

M6TSS

Federal Communications Commission (F.C.C.) Statement

This device complies with Part 15 of the FCC Rules. Operation of this device is subject to the following two conditions: (1) this device may not cause harmful interference, and (2) this device must accept any interference received, including interference that may cause undesired operation.

Accessories: This device has been tested and found to comply with the limits of a Class B digital device, the accessories associated with this equipment are as follows:

1. Shielded serial cable (Can be obtained from multiple retail outlets)
2. Shielded printer cable (Can be obtained from multiple retail outlets)
3. Shielded video cable (Can be obtained from multiple retail outlets)
4. Shielded power cord (Provided by manufacturer)

These accessories are required to ensure compliance with FCC Rules. It is the responsibility of the user to provide and use these accessories properly.

This equipment has been tested and found to comply with the limits of a Class B digital device, pursuant to Part 15 of the FCC Rules. These limits are designed to provide reasonable protection against harmful interference in a residential installation. This equipment generates, uses, and can radiate radio frequency energy and, if not installed and used in accordance with the instructions, may cause harmful interference to radio communications. There is no guarantee that interference will not occur in a particular installation.

If this equipment does cause harmful interference to radio or television reception, which can be determined by turning the equipment off and on, you are encouraged to try to correct the interference by one or more of the following measures:

1. Reorient / relocate the receiving antenna.
2. Increase the separation between the equipment and receiver.
3. Connect the equipment into an outlet on a circuit different from that to which the receiver is connected.
4. Consult the dealer or an experienced radio/TV technician for help.

Caution: Changes or modifications not expressly approved by the manufacturer could void the user's authority to operate the equipment.

Disclaimer

The vendor makes no representations or warranties with respect to the contents hereof and specially disclaims any implied warranties of merchantability or fitness for any purpose. Further, the vendor reserves the right to revise this publication and to make changes to the contents hereof without obligation to notify any party beforehand.

Duplication of this publication, in part or in whole, is not allowed without first obtaining the vendor's approval in writing.

Trademarks and Remarks

MS-DOS, Windows NT, Windows 9x, Windows ME, and Windows 2000 are products of Microsoft Corp, with its ownership of trademark, and are distributed by the Vendor under a license agreement.

All trademarks used in this manual are the property of their respective owners.

Copyright © 2001

All Rights Reserved

Canadian D.O.C. Statement

This digital apparatus does not exceed the Class B limits for radio noise emissions from digital apparatus as set out in the radio interference regulations of the Canadian Department of Communications.

Cet appareil numérique n'émet pas de bruits radioélectriques dépassant les limites appliqués aux appareils numériques de Class B prescrits dans le règlement du brouillage radioélectrique édicté par le ministère Des Communications du Canada.

Contents

Introduction	1-1
1 Motherboard Description	1-2
1.1 Features	1-2
1.1.1 Hardware	1-2
1.1.2 Software	1-6
1.1.3 Attachments.....	1-6
1.2 Motherboard Installation.....	1-7
1.2.1 Layout of Motherboard	1-7
1.3 Motherboard Connectors.....	1-8
1.3.1 Front Panel Connectors (JPANEL1)	1-9
1.3.2 ATX 20-pin Power Connector (JATXPER1).....	1-11
1.3.3 Hard Disk Connectors (IDE1/IDE2)	1-12
1.3.4 Floppy Disk Connector (FDC1)	1-12
1.4 Back Panel Connectors	1-13
1.4.1 PS/2 Mouse / Keyboard Connectors (JKBMS1)	1-13
1.4.2 USB Connector	1-14
1.4.2.1 Stacked USB Connector (JUSB2).....	1-14
1.4.2.2 Front USB Connector: (JUSBF1 / JUSBF2) (Optional)	1-15
1.5 Serial and Parallel Interface Ports	1-16
1.6 CPU Installation.....	1-20
1.6.1 CPU Installation Procedure	1-20
1.6.2 How to install a DIMM Module.....	1-21

Contents

1.7 Jumper Settings	1-22
1.7.1 CPU Fan Connector (JCFAN1).....	1-23
1.7.2 System Fan Connector (JSFAN1) (Optional).....	1-23
1.7.3 CMOS Function Selection (JCMOS1)	1-23
1.7.4 Keyboard / Mouse Power Selection (JKBV1) (Optional)	1-23
1.7.5 Power Selection (JUSBP1) (Optional).....	1-24
1.7.6 Wake On Modem Connector (JWOM1)	1-24
1.7.7 Wake-On-LAN Connector (JWOL1)	1-24
1.7.8 CPU Frequency Selection (JCLK1)	1-24
1.8 DIMM Installation	1-25
1.8.1 DIMM	1-25
1.9 Audio Subsystem.....	1-27
1.9.1 CD Audio-In Connectors (JCDIN1/JCDIN2)	1-27
1.9.2 Telephony Connector (JTAD1).....	1-28
1.9.3 AUX Audio in Connector (JAUX1) (Optional)	1-28
1.9.4 Front Audio Connector: JAUDIO1 (Optional).....	1-28
2. BIOS Setup.....	2-1
2.1 Main Menu.....	2-3
2.2 Standard CMOS Features.....	2-6
2.3 Advanced BIOS Features.....	2-9
2.4 Advanced Chipset Features.....	2-13
2.5 Integrated Peripherals	2-15
2.6 Power Management Setup.....	2-20

Contents

2.7 PnP/PCI Configurations	2-24
2.8 PC Health Status	2-27
2.9 Load Fail-Safe Defaults	2-29
2.10 Load Optimized Defaults	2-30
2.11 Set Supervisor/User Password	2-31
2.12 Save & Exit Setup	2-32
2.13 Exit Without Saving	2-33
3. Software Setup	3-1
3.1 Software List	3-1
3.2 On Board Audio Device Driver List	3-2
3.3 Software Installation	3-3
4. Trouble Shooting	4-1

Introduction

System Overview

Thank you buying this product! This manual was written to help you start using this product as quickly and smoothly as possible. Inside you will find adequate explanations to solve most problems. For help in finding topics of interest, refer to Table of Contents.

This board incorporates the all new Intel® 815EP serial chipset, built-in the LPC I/O, and AGP Bus, PCI Bus, IDE interface into one board that provides a total PC solution. The motherboard, a Coppermine™ processor based PC/ ATX system, supports a 128KB or 256KB cache on CPU, PCI Local Bus to support upgrades to your system performance. On-Board sound subsystem to support high 3D sound quality, the AMR slot and CNR slot to support the solution of high performance, 6-channel audio codec, low cost modem and LAN (CNR slot only). It is ideal for multi-tasking and fully supports MS-DOS, Windows 3x, Windows NT, Windows 2000, Novell, OS/2, Windows9x, Windows ME, LINUX, UNIX, SCO UNIX etc. This manual also explains how to install the motherboard for operation, and how to setup your CMOS configuration with the BIOS setup program.

1 Motherboard Description

1.1 Features

1.1.1 Hardware

CPU

- The Coppermine™ processor (FC-PGA) and Celeron™ (FC-PGA only) the new generation power for high-end workstations and servers.
- Provides Socket 370.
- Running at 66 MHz, 100 MHz and 133MHz Front Side Bus frequency.

Speed

- Supports from 300MHz to 1G Hz CPU core speeds.
- Supports 33MHz PCI Bus speed.

DRAM Memory

- Supports three 16/32/64/128/256MB DIMM module sockets.
- Supports Synchronous DRAM (3.3V).
- Supports a maximum memory size of 512 MB with SDRAM.
- 100/133MHz Bus frequency.
- Supports up to 3 double sided DIMMs at 100 MHz system memory bus.
- Supports up to 2 double sided or 3 single sided DIMMs at 133 MHz system memory bus.

Shadow RAM

- Supports shadowing of system BIOS into RAM for faster performance.

Green PC Power Management Functionality

- BIOS supported power management.
- Power down timer from 1 min to 1 hour.
- Wakes up by any key pressed or mouse activity.
- Wake On LAN connector.

- Wake On MODEM header.
- S3 (suspend to RAM) support (Optional).
- Wake On AMR or CNR supported.

BUS Slots

- Provides one AMR slot, five PCI Bus slots, one CNR slot and one AGP Bus slot.

PCI Enhanced IDE Built-in Onboard

- Supports 4 IDE hard disk drives.
- Supports PIO mode 4, Master Mode high performance hard disk drives.
- Supports Ultra DMA/33, Ultra DMA/66 Bus and Ultra DMA/100 Bus Master Mode.
- Supports IDE interface with CD-ROM.
- Supports high capacity hard disk drives.
- Supports LBA mode.
- Driver detected by BIOS.

PCI-Based AC 97 Digital Audio Processor (Optional)

- AC 97 2.1 interface.
- 16 channels of high-quality sample rate conversion.
- 16x8 channel digital mixer.
- Stereo 10 band graphic equalizer.
- Sound Blaster® and Sound Blaster Pro® emulation.
- S/PDIF output (allows standard interface to consumer electronics).
- 64-voice wavetable.
- PC99 complaint.

Accelerated Graphics Port (AGP)

- Supports AGP 2.0 including 4X AGP data transfers.
- High priority access support.
- Hierarchical PCI configuration mechanism.
- Supports via dual mode buffers to allow AGP 2.0, 3.3V or 1.5V signaling.

AC'97 Sound Codec Onboard

- AC-LINK protocol compliance.
- AC'97 2.1 compliant.
- Energy saving power down modes.
- 18-bit full duplex stereo ADC,DACs.
- SNR>95 dB through Mixer and DAC.
- AC-3 playback required for PVD applications.
- Support 4-channel audio codec.

LPC I/O Built-in Onboard

- LPC Interface.
- PC98, PC99 Compliant.
- Game Port Interface.
- MPU-401 MDI Support.
- Intelligent Auto Power Management.
- 2.88MB Super I/O Floppy Disk Controller.
- Floppy Disk Available on Parallel Port Pins.
 - Supports 360KB, 720KB, 1.2MB, 1.44MB, and 2.88MB floppy disk drives.
- Enhanced Digital Data Separator.
- Serial Ports.
 - Two full Function Serial Ports.
 - Supports 230K and 460K Baud Programmable Baud Rate Generator Modem Control Circuitry.
- Infrared Port.
- Multi-Mode™ Parallel Port with ChipProtect™.

Hardware Monitor Subsystem

The hardware monitor subsystem provides low-cost instrumentation capabilities. The features of the hardware monitor subsystem include:

- Management Level 4 functionality.
- Microprocessor System Hardware Monitor:
 - Integrated temperature and voltage monitoring to detect levels above or below acceptable values (+12V, -12V, +5V, +3.3V, +2.5V, VTT (1.5V), VCCORE (CPU Voltage)). When suggested ratings for temperature, fan speed, or voltage are exceeded, an interrupt is activated.
- Fan speed sensors.

System Speed Selection

- Front side bus frequency may selected by both jumper setting and the BIOS setup.

Universal Serial Bus

- Supports two rear panel Universal Serial Bus (USB) Ports.
- Supports 48MHz USB.
- The two ports USB may located front panel.

Dimension (ATX form-factor)

- 20 cm X 30.5 cm (W x L)

1.1.2 Software

BIOS

- AWARD BIOS.
- ACPI Supported.
- Supports APM1.2.
- Supports USB Function.
- Setting the CPU Host frequency/Ratio.
- Setting CNR or AMR status. (On-board CT5880 only)

Operating Systems

- Offers the highest performance for MS-DOS, OS/2, Windows 3x, Windows NT, Windows 2000, Windows 9x, Windows ME, LINUX, Novell, UNIX, SCO UNIX etc.

1.1.3 Attachments

- HDD Cable.
- FDD Cable.
- Rear I/O Panel for ATX Case (Optional).
- COM2 Cable (Optional).
- CD for sound, IDE drivers and modem driver utilities.
- Front USB cable (Optional).

1.3 Motherboard Connectors

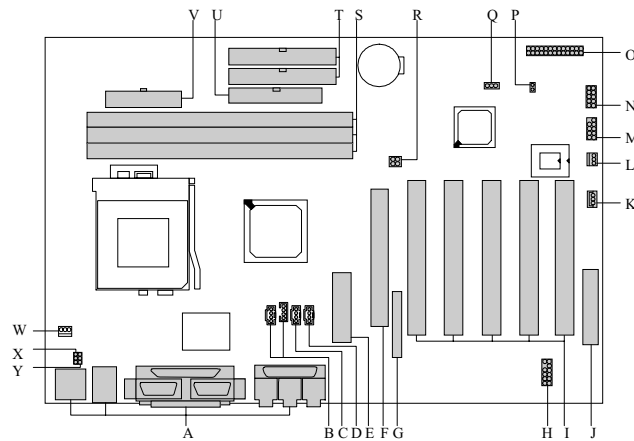

- | | |
|---|--|
| A. Back Panel Connectors | N. Front USB Connector (*JUSBF2) |
| B. CD Audio-In Connectors (JCDIN1-2) | O. Front Panel Connector (JPANEL1) |
| C. AUX Audion In Connector (*JAUX1) | P. Wake On-Modem CONN. (JWOM1) |
| D. Telephony Connector (JTAD1) | Q. CMOS Function Selection (JCMOS1) |
| E. AMR Slot (AMR1) | R. CPU Frequency Selection (JCLK1) |
| F. AGP Slot (AGP1) | S. DIMMs (DIMM1-3) |
| G. Digital VGA Out Connector (*J15) | T. IDE Connectors (IDE1-2) |
| H. Front Audio Connector(*JAUDIO1) | U. FDC Connector (FDC1) |
| I. PCI BUS Slots (PCI1-5) | V. ATX Power Connector (JATXPWR1) |
| J. CNR Slot (CNR1) | W. CPU Fan Connector (JCFAN1) |
| K. Wake-On-LAN CONN. (JWOL1) | X. Keyboard/ Mouse Power Selection (*JKBV1) |
| L. System Fan Connector (*JSFAN1) | Y. USB Connector (*JUSBP1) |
| M. Front USB Connector (*JUSBF1) | |

NOTE: The "*" mark represent the function is optional.

1.3.1 Front Panel Connectors (JPANEL1)

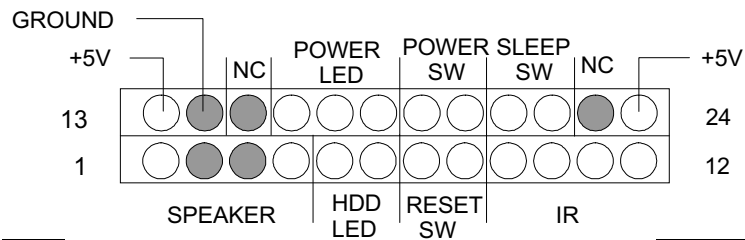

Pin No.	Assignment	Function	Pin No.	Assignment	Function
1	Speaker	Speaker Connector	13	+5V	VCC
2	NC		14	Ground	Ground
3	NC		15	NC	NC
4	+5V		16	Power LED (+)	POWER LED
5	HDD LED (+)	17	Power LED (+)		
6	HDD LED (-)	18	Power LED (-)		
7	Ground	Reset Button	19	Power Button	Power SW
8	Reset Control		20	Ground	
9	+5V	IrDA Connector	21	Sleep Control	Sleep Button
10	Ir-In		22	Ground	
11	Ground		23	NC	NC
12	Ir-Out		24	+5V	VCC

Speaker Connector

An offboard speaker can be installed on the motherboard as a manufacturing option. An offboard speaker can be connected to the motherboard at the front panel connector. The speaker (onboard or offboard) provides error beep code information during the Power On Self-Test when the computer cannot use the video interface. The speaker is not connected to the audio subsystem and does not receive output from the audio subsystem.

Hard Drive LED Connector

This connector can be connected to an LED to provide a visual indicator that data is being read from or written to a hard drive. For the LED to function properly, an IDE drive must be connected to the onboard hard drive controller.

Reset Button

This connector can be connected to a momentary SPST type switch that is normally open. When the switch is closed, the motherboard resets and runs the POST.

IrDA (Infrared) Connector

After the IrDA interface is configured, files can be transferred from or to portable devices such as laptops, PDAs, and printers using application software.

Power LED Connector

This connector can be connected to an LED that will light when the computer is powered on.

Power On Button

This connector can be connected to a front panel power switch. The switch must pull the Power Button pin to ground for at least 50 ms to signal the power supply to switch on or off. (The time requirement is due to internal debounce circuitry on the motherboard.) At least two seconds must pass before the power supply will recognize another on/off signal.

Sleep /Resume Switch Connector

When APM is enabled in the system BIOS, and the operating system's APM driver is loaded, the system can enter sleep (standby) mode in one of the following ways:

- Optional front panel sleep/resume button
- Prolonged system inactivity using the BIOS inactivity timer feature

The 2-pin connector located on the front panel I/O connector supports a front panel sleep/resume switch, which must be a momentary SPST type that is normally open.

Closing the sleep/resume switch sends a System Management Interrupt (SMI) to the processor, which immediately goes into SMM. While the computer is in sleep mode, it is fully capable of responding to and servicing external interrupts (such as an incoming fax) even though the monitor turns on only if a keyboard or mouse interrupt occurs. To reactivate or resume system operation, the sleep/resume switch must be pressed again, or the keyboard or mouse must be used.

1.3.2 ATX 20-pin Power Connector (JATXPER1)

This connector supports the power button on-board. Using the ATX power supply, functions such as Modem Ring Wake-Up and Soft Power Off are supported on this motherboard. This power connector supports instant power-on functionality, which means that the system will boot up instantly when the power connector is inserted on the board.

PIN	VOLTAGE	PIN	VOLTAGE
1	3.3 V	11	3.3 V
2	3.3 V	12	-12 V
3	GND	13	GND
4	5 V	14	PS_ON
5	GND	15	GND
6	5 V	16	GND
7	GND	17	GND
8	PW_OK	18	-5 V (Optional)
9	5V_SB	19	5 V
10	12 V	20	5 V

Warning: Since the motherboard has the instant power-on function, make sure that all components are installed properly before inserting the power connector to ensure that no damage will be done.

1.3.3 Hard Disk Connectors (IDE1/IDE2)

The motherboard has a 32-bit Enhanced, PCI IDE Controller that provides PIO Mode 0~4, and Ultra DMA 33/ 66/ 100 functionality. It has two HDD connectors IDE1 (primary) and IDE2 (secondary). You can connect up to four hard disk drives, a CD-ROM, a 120MB Floppy (reserved for future BIOS) and other devices to IDE1 and IDE2. These connectors support the IDE hard disk cable provided.

- **IDE1 (Primary IDE Connector)**

The first hard drive should always be connected to IDE1. IDE1 can connect a Master and a Slave drive. You must configure the second hard drive on IDE1 to Slave mode by setting the jumper accordingly.

- **IDE2 (Secondary IDE Connector)**

The IDE2 controller can also support a Master and a Slave drive. The configuration is similar to IDE1. The second driver on this controller must be set to slave mode.

1.3.4 Floppy Disk Connector (FDC1)

The motherboard provides a standard floppy disk connector (FDC) that supports 360K, 720K, 1.2M, 1.44M and 2.88M floppy disk types. This connector supports the provided floppy drive ribbon cables.

1.4 Back Panel Connectors

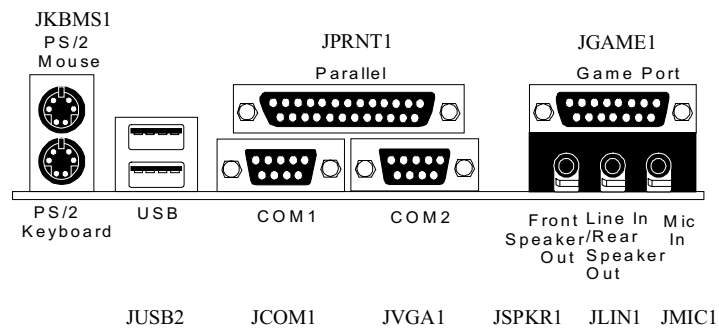

Rear Speaker out

This driver will also work for two channel systems. You can play DVD movies using InterVideo's Win DVD or Power DVD (on-board CT5880) software, if using four channel systems.

1.4.1 PS/2 Mouse / Keyboard Connectors (JKBMS1)

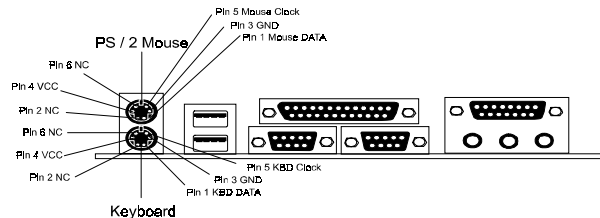

The motherboard provides a standard PS/2 mouse / Keyboard mini DIN connector for attaching a PS/2 mouse. You can plug a PS/2 mouse / Keyboard directly into this connector. The connector location and pin definition are shown below:

PS/2 Mouse / Keyboard Connectors

Pin	Signal Name
1	Data
2	No connect
3	Ground
4	+5 V (fused)
5	Clock
6	No connect

1.4.2 USB Connector

The motherboard provides a **UHCI (Universal Host Controller Interface) Universal Serial Bus roots** for attaching USB devices such as: keyboard, mouse and other USB devices. You can plug the USB devices directly into this connector.

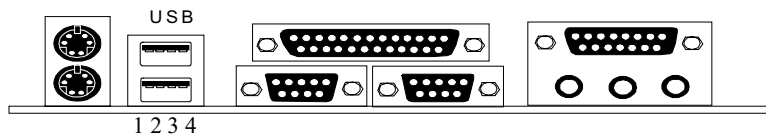
1.4.2.1 Stacked USB Connector (JUSB2)**Stacked USB Connectors**

Pin	Signal Name
1	+5 V (fused)
2	USBP0- [USBP1-]
3	USBP0+ [USBP1+]
4	Ground

1.4.2.2 Front USB Connector: (JUSBF1 / JUSBF2) (Optional)

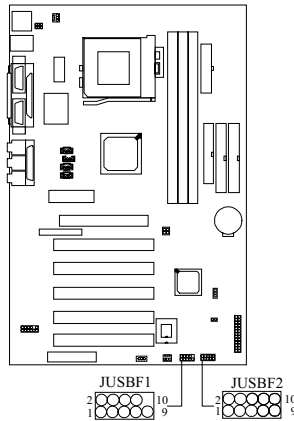

Front USB Connector (JUSBF1) (Optional)

Pin	Signal Name	Pin	Signal Name
1	N/C	2	+5V
3	Ground	4	NC
5	NC	6	FNT_USBP0
7	Ground	8	FNT_USBP0#
9	Ground	10	Key

Front USB Connector (JUSBF2) (Optional)

Pin	Assignment	Pin	Assignment
1	+5V	2	No connection
3	Port 1 Negative Data	4	Ground
5	Port 1 Positive Data	6	Port 2 Positive Data
7	Ground	8	Port 2 Negative Data
9	No connection	10	+5V

1.5 Serial and Parallel Interface Ports

This system comes equipped with two serial ports and one parallel port. Both types of interface ports will be explained in this chapter.

The Serial Interface Port : COM1&COM2

The serial interface port is sometimes referred to as an RS-232 port or an asynchronous communications port. Mice, printers, modems and other peripheral devices can be connected to a serial port. The serial port can also be used to connect your computer with another computer system. If you wish to transfer the contents of your hard disk to another system it can be accomplished by using each machine's serial port.

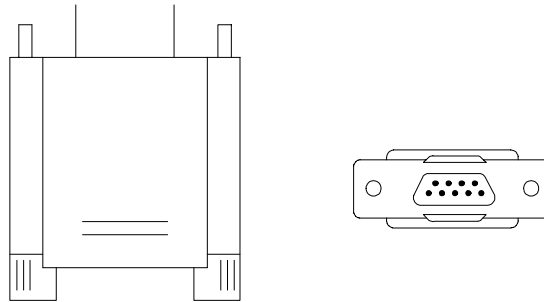

The serial ports on this system have two 9-pin connector. Some older computer systems and peripherals used to be equipped with only one 25-pin connector. Should you need to connect your 9-pin serial port to an older 25-pin serial port, you can purchase a 9-to-25 pin adapter.

Connectivity

The serial port can be used many ways, and it may be necessary to become familiar with the pin-out diagram. The following chart gives you the function of each pin on the 9-pin connector and some of the 25-pin connector. This information can be used when configuring certain software programs to work with the serial port.

Signal	Name	DB9 PIN	DB25 PIN
DCD	Data Carrier Detect	1	8
RX	Receive Data	2	3
TX	Transmit Data	3	2
DTR	Data Terminal Ready	4	20
GND	Signal Ground	5	7
DSR	Data Set Ready	6	6
RTS	Request to Send	7	4
CTS	Clear to Send	8	5
RI	Ring Indicator	9	22

Serial Ports/COM Ports

The two serial ports on the computer are called COM1 and COM2, respectively. If you wish, two more serial ports can be added onto the computer using optional hardware. Should you choose to add the extra Serial ports (COM ports) they would be called COM3 and COM4.

When using serial ports to communicate with a peripheral device, be sure to assign only one COM port number to each device. For example, if a printer and a scanner are both connected to your computer through serial ports, the printer must be assigned one COM port (i.e. COM1) and the scanner must be assigned the other COM port (i.e. COM2). No two devices can be assigned to one COM port. Each peripheral must have its own COM port.

NOTE: Four serial ports may be installed on the computer. However, no more than two ports can be used simultaneously.

*If you have installed an internal modem, be careful not to assign a COM port number that has already been assigned to another device. This error is common.

When installing a device that is going to require the use of a serial port, use a diagnostic program to find out which ports are available. It may be necessary to remove expansion cards that have serial ports in order to check their jumper settings. The jumper settings will indicate which COM port the card has been assigned. Checking the expansion card will eliminate mistakes in overlapping COM ports. Once you have completed the installation of peripheral devices using the serial ports, be sure that the communication parameters such as baud rate, parity bit, etc. are matching. If your computer is set for a baud rate of 9600 and your modem is set for a baud rate of 2400 you will not be able to send messages. The manuals that accompany the peripheral devices will inform you on the procedure for setting their parameters. Software manuals also have instructions on setting parameters.

Parallel Interface Port (JPRNT1)

Unlike the serial port, parallel interface ports have been standardized and should not present any difficulty interfacing peripherals to your system. Sometimes called a Centronics port, the parallel port is almost exclusively used with printers. The parallel port on your system has a 25-pin, DB25 connector (see picture below). The pin-out for the parallel port are shown in the table below.

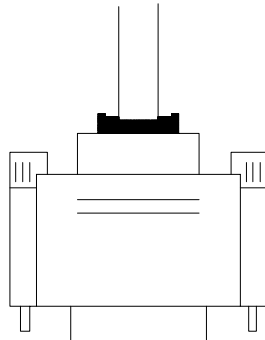
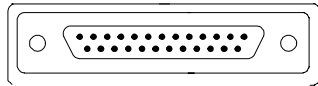

Signal	Pin
-Strobe	1
Data 0	2
Data 1	3
Data 2	4
Data 3	5
Data 4	6
Data 5	7
Data 6	8
Data 7	9
-Ack	10
Busy	11
Paper Empty	12
+Select	13
-Auto FDXT	14
-Error	15
-Init	16
-SLCTN	17
Ground	18
Ground	19
Ground	20
Ground	21
Ground	22
Ground	23
Ground	24
Ground	25

1.6 CPU Installation

1.6.1 CPU Installation Procedure

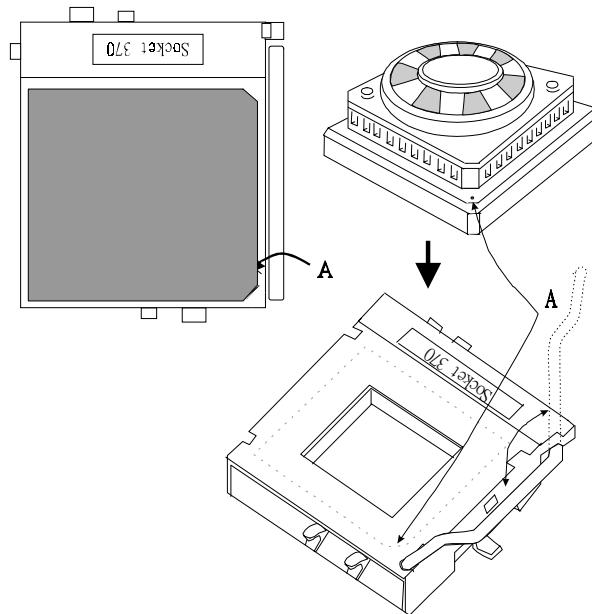

1. Pull the lever sideways away from the socket then raise the lever up to a 90-degree angle.
2. Locate Pin A in the socket and look for the white dot or cut edge in the CPU. Match Pin A with the white dot/cut edge then insert the CPU.
3. Press the lever down to complete the installation.

1.6.2 How to install a DIMM Module

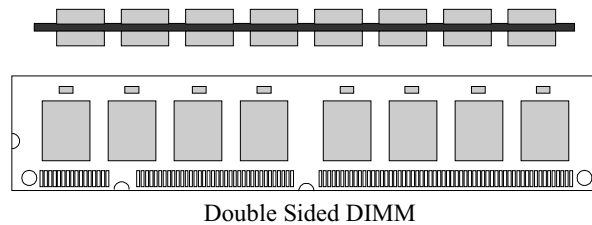
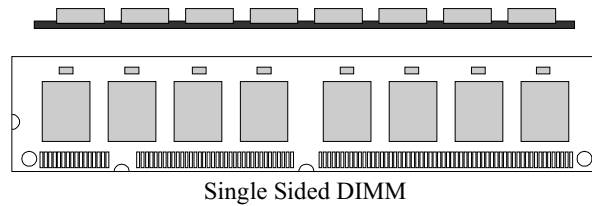

1. The DIMM socket has a Plastic Safety Tab and the DIMM memory module has an asymmetrical notch, so the DIMM memory module can only fit into the slot in one direction.

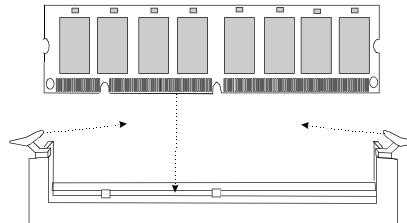

2. Push the tabs out. Insert the DIMM memory modules into the socket at a 90-degree angle then push down vertically to fit the modules into place.

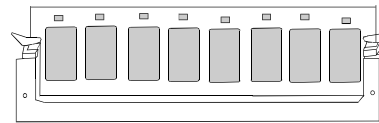

3. The mounting holes and plastic tabs should fit over the edge and hold the DIMM memory modules in place.

1.7 Jumper Settings

The jumper has two or more pins that can be covered by a plastic jumper cap, enabling you to select different system options.

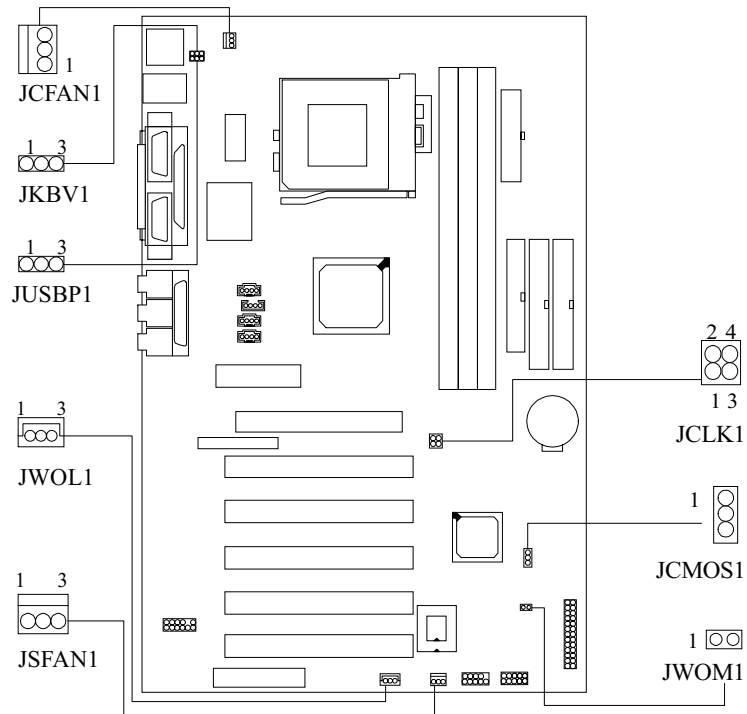



1.7.1 CPU Fan Connector (JCFAN1)

Pin No.	Assignment
1	Ground
2	+12V
3	FAN R.P.M. Signal input

1.7.2 System Fan Connector (JSFAN1) (Optional)

Pin No.	Assignment
1	Ground
2	+12V
3	FAN R.P.M Srgnal input

1.7.3 CMOS Function Selection (JCMOS1)

JCOMS1	Assignment
 1-2 Closed	Normal Operation (default)
 2-3 Closed	Clear CMOS Data

1.7.4 Keyboard / Mouse Power Selection (JKBV1) (Optional)

Pin No.	Assignment
1-2	+5V Standby Voltage
2-3	+5V

1.7.5 Power Selection (JUSBP1) (Optional)

Pin No.	Assignment
1-2	+5V Standby Voltage
2-3	+5V

1.7.6 Wake On Modem Connector (JWOM1)

PIN NO.	Assignment
1	Ground
2	Ring-in Signal input

1.7.7 Wake-On-LAN Connector (JWOL1)

Pin No.	Assignment
1	+5V Standby Voltage
2	Ground
3	Wakeup Signal Input

1.7.8 CPU Frequency Selection (JCLK1)

CPU / DRAM	PIN1-2	PIN3-4	Remark
66/100(MHz)	CLOSE	CLOSE	
100/100(MHz)	OPEN	CLOSE	
133/100(MHz)	OPEN	OPEN	
133/133(MHz)	CLOSE	OPEN	System Memory Frequency must select 133MHz from BIOS setup.
Auto (Control by CPU)	OPEN (Default)	OPEN (Default)	Celeron™ CPU (FC-PGA) must selected by both Jumper only, not Auto.

1.8 DIMM Installation

1.8.1 DIMM

DRAM Access Time: 3.3V Unbuffered SDRAM PC100/133 Type required.

DRAM Type: 16MB/ 32MB/ 64MB/ 128MB/ 256MB DIMM Module (168pin)

Total	Bank 0	Bank 1	Bank 2
Memory Size (MB)	DIMM1	DIMM2	DIMM3
16 M	16M x 1 pc	----	----
32 M	32M x 1 pc	----	----
64 M	64M x 1 pc	----	----
128 M	128M x 1 pc	----	----
256 M	256M x 1 pc	----	----
32 M	16M x 1 pc	16M x 1 pc	----
64 M	32M x 1 pc	32M x 1 pc	----
128 M	64M x 1 pc	64M x 1 pc	----
256 M	128M x 1 pc	128M x 1 pc	----
512 M	256M x 1 pc	256M x 1 pc	----
48 M	16M x 1 pc	16M x 1 pc	16M x 1 pc
80 M	32M x 1 pc	32M x 1 pc	16M x 1 pc
144 M	64M x 1 pc	64M x 1 pc	16M x 1 pc
272 M	128M x 1 pc	128M x 1 pc	16M x 1 pc

Total	Bank 0	Bank 1	Bank 2
Memory Size (MB)	DIMM1	DIMM2	DIMM3
64 M	16M x 1 pc	16M x 1 pc	32M x 1 pc
96 M	32M x 1 pc	32M x 1 pc	32M x 1 pc
160 M	64M x 1 pc	64M x 1 pc	32M x 1 pc
288 M	128M x 1 pc	128M x 1 pc	32M x 1 pc
96 M	16M x 1 pc	16M x 1 pc	64M x 1 pc
128 M	32M x 1 pc	32M x 1 pc	64M x 1 pc
192 M	64M x 1 pc	64M x 1 pc	64M x 1 pc
320 M	128M x 1 pc	128M x 1 pc	64M x 1 pc
160 M	16M x 1 pc	16M x 1 pc	128M x 1 pc
192 M	32M x 1 pc	32M x 1 pc	128M x 1 pc
256 M	64M x 1 pc	64M x 1 pc	128M x 1 pc
384 M	128M x 1 pc	128M x 1 pc	128M x 1 pc
288 M	16M x 1 pc	16M x 1 pc	256M x 1 pc
320 M	32M x 1 pc	32M x 1 pc	256M x 1 pc
384 M	64M x 1 pc	64M x 1 pc	256M x 1 pc
512 M	128M x 1 pc	128M x 1 pc	256M x 1 pc

Notes: Don't stuff or remove the DIMM memory, if the LED1 is lighting.

1.9 Audio Subsystem

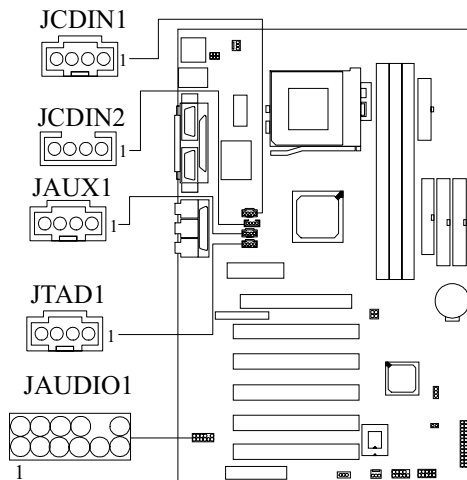

1.9.1 CD Audio-In Connectors (JCDIN1/JCDIN2)

Pin No. of JCDIN1	Assignment
1	Left Channel Input
2	Ground
3	Ground
4	Right Channel Input

Pin No. of JCDIN2	Assignment
1	Left Channel Input
2	Ground
3	Right Channel Input
4	Ground

1.9.2 Telephony Connector (JTAD1)

Pin No.	Assignment
1	MONO out
2	Ground
3	Ground
4	MONO_in

1.9.3 AUX Audio in Connector (JAUX1) (Optional)

Pin No.	Assignment
1	Right Channel Aux-in
2	Ground
3	Ground
4	Left Channel Aux in

1.9.4 Front Audio Connector: JAUDIO1 (Optional)

Pin	Assignment	Pin	Assignment
1	Lch Line out Signal to phone Jack	2	Rch Line Out Signal to phone Jack
3	Lch Line out from M/B	4	Rch Line out Signal from M/B
5	Ground	6	Ground
7	Line_in_L	8	Line_in_R
9	Ground	10	Pin Removed as key pin
11	MIC_in	12	Ground

*Notes: Lch- Left channel
Rch- Right channel*

2. BIOS Setup

Introduction

This manual discussed Award™ Setup program built into the ROM BIOS. The Setup program allows users to modify the basic system configuration. This special information is then store in battery-backed RAM so that it retains the Setup information when the power is turned off.

The Award BIOS™ installed in your computer system's ROM (Read Only Memory) is a custom version of an industry standard BIOS. This means that it supports Intel processors input/output system. The BIOS provides critical low-level support for standard devices such as disk drives and serial and parallel ports.

Adding important has customized the Award BIOS™, but nonstandard, features such as virus and password protection as well as special support for detailed fine-tuning of the chipset controlling the entire system.

The rest of this manual is intended to guide you through the process of configuring your system using Setup.

Plug and Play Support

These AWARD BIOS supports the Plug and Play Version 1.0A specification. ESCD (Extended System Configuration Data) write is supported.

EPA Green PC Support

This AWARD BIOS supports Version 1.03 of the EPA Green PC specification.

APM Support

These AWARD BIOS supports Version 1.1&1.2 of the Advanced Power Management (APM) specification. Power management features are implemented via the System Management Interrupt (SMI). Sleep and Suspend power management modes are supported. Power to the hard disk drives and video monitors can be managed by this AWARD BIOS.

PCI Bus Support

This AWARD BIOS™ also supports Version 2.1 of the Intel PCI (Peripheral Component Interconnect) local bus specification. Please see the Intel technical documentation for additional information.

DRAM Support

SDRAM (Synchronous DRAM) are supported.

Supported CPUs

This AWARD BIOS supports a single Intel Pentium®!!! & Celeron™ CPU. Dual CPUs are not supported.

Using Setup

In general, you use the arrow keys to highlight items, press <Enter> to select, use the PageUp and PageDown keys to change entries, press <F1> for help and press <Esc> to quit. The following table provides more detail about how to navigate in the Setup program using the keyboard.

Keystroke	Function
Up arrow	Move to previous item
Down arrow	Move to next item
Left arrow	Move to the item on the left (menu bar)
Right arrow	Move to the item on the right (menu bar)
Esc	Main Menu: Quit without saving changes Submenus: Exit Current page to the next higher level menu
Move Enter	Move to the item you desired
PgUp key	Increase the numeric value or make changes
PgDn key	Decrease the numeric value or make changes
+ Key	Increase the numeric value or make changes
- Key	Decrease the numeric value or make changes
Esc key	Main Menu – Quit and not save changes into CMOS Status Page Setup Menu and Option Page Setup Menu – Exit Current page and return to Main Menu
F1 key	General help on Setup navigation kdys
F5 key	Load previous values from CMOS
F6 key	Load the fail-safe defaults from BIOS default table
F7 key	Load the optimized defaults
F10 key	Save all the CMOS changes and exit

2.1 Main Menu

Once you enter Award BIOS™ CMOS Setup Utility, the Main Menu will appear on the screen. The Main Menu allows you to select from several setup functions and two exit choices. Use the arrow keys to select among the items and press <Enter> to accept and enter the sub-menu.

!! WARNING !!

The information about BIOS defaults on manual (Figure 1,2,3,4,5,6,7,8,9,10,11,12,13) is just for reference, please refer to the BIOS installed on board, for update information.

■ Figure 1. Main Menu

CMOS Setup Utility-Copyright (C) 1984-2000 Award Software

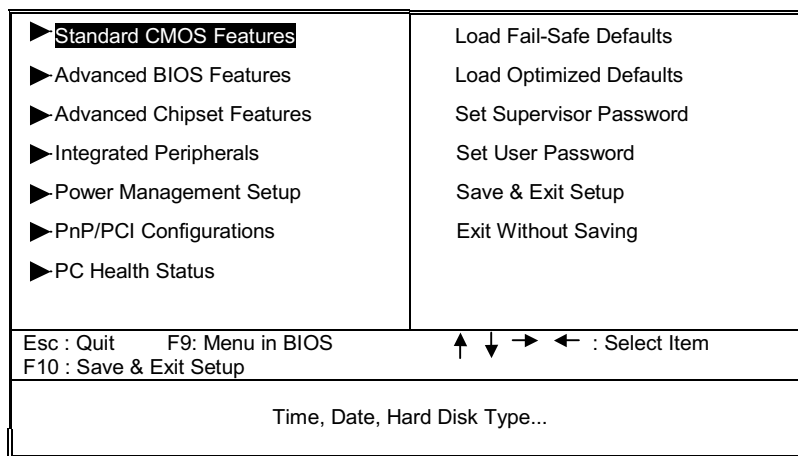

Standard CMOS Features

This setup page includes all the items in a standard compatible BIOS.

Advanced BIOS Features

This setup page includes all the items of BIOS special enhanced features.

Advanced Chipset Features

This setup page includes all the items of chipset special features.

Integrated Peripherals

This section page includes all the items of IDE hard drive and Programmed Input/Output features.

Power Management Setup

This setup page includes all the items of power management features.

PnP/PCI Configurations

This setup page includes IRQ Setting by user define or default.

PC Health Status

This setup page is the System auto detect Temperature, voltage, fan speed.

Load Fail-Safe Defaults

Use this menu to load the BIOS default values for the minimal/stable performance for your system to operate.

Load Optimized Defaults

These settings are more likely to configure a workable computer when something is wrong. If you cannot boot the computer successfully, select the BIOS Setup options and try to diagnose the problem after the computer boots. These settings do not provide optimal performance.

Set Supervisor Password

Change, set, or disable password. It allows you to limit access to the system and Setup, or just to Setup.

Set User Password

You can specify both a User and a Supervisor password. When you select either password option, you are prompted for a 1-8 character password. Enter the password and then retype the password when prompted.

Save & Exit Setup

Save CMOS value changes to CMOS and exit setup.

Exit Without Saving

Abandon all CMOS value changes and exit setup.

2.2 Standard CMOS Features

The items in Standard CMOS Setup Menu are divided into 10 categories. Each category includes no, one or more than one setup items. Use the arrow keys to highlight the item and then use the <PgUp> or <PgDn> keys to select the value you want in each item.

■ Figure 2. Standard CMOS Setup

CMOS Setup Utility-Copyright (C) 1984-2000 Award Software
Standard CMOS Features

Date (mm:dd:yy)	Fri, Jan 12 2001	Item Help
Time (hh:mm:ss)	11 : 37 : 30	Menu Level ▶
▶ IDE Primary Master	None	Change the day, month, year and century
▶ IDE Primary Slave	None	
▶ IDE Secondary Master	None	
▶ IDE Secondary Slave	None	
Drive A	1.44M, 3.5 in	
Drive B	None	
Video	EGA/VGA	
Halt On	All, But Keyboard	
Base Memory	XXXX	
Extended Memory	XXXX	
Total Memory	XXXX	

↑ ↓ → ← : Move Enter :Select +/-/PU/PD :Value F10 :Save ESC :Exit F1 :General Help
F5 :Previous Values F6 :Fail-Safe Defaults F7 : Optimized Defaults

Main Menu Selections

This table shows the selections that you can make on the Main Menu.

Item	Options	Description
Date	MM DD YYYY	Set the system date. Note That the 'Day' automatically changes when you set the date.
IDE Primary Master	Options are in its sub menu.	Press <Enter> to enter the sub menu of detailed options
IDE Primary Slave	Options are in its sub menu.	Press <Enter> to enter the sub menu of detailed options.
IDE Secondary Master	Options are in its sub menu.	Press <Enter> to enter the sub menu of detailed options.
IDE Secondary Slave	Options are in its sub menu.	Press <Enter> to enter the sub menu of detailed options.
Drive A Drive B	None 360K, 5.25 in 1.2M, 5.25 in 720K, 3.5 in 1.44M, 3.5 in 2.88M, 3.5 in	Select the type of floppy disk drive installed in your system.
Video	EGA/VGA CGA 40 CGA 80 MONO	Select the default video device.

Item	Options	Description
Halt On	All Errors No Errors All, but Keyboard All, but Diskette All, but Disk/Key	Select the situation in which you want the BIOS to stop the POST process and notify you.
Base Memory	N/A	Displays the amount of conventional memory detected during boot up.
Extended Memory	N/A	Displays the amount of extended memory detected during boot up.
Total Memory	N/A	Displays the total memory available in the system.

2.3 Advanced BIOS Features

■ Figure 3. Advanced BIOS Setup

CMOS Setup Utility-Copyright (C) 1984-2000 Award Software
Advanced BIOS Features

Virus Warning	Disabled	Item Help
CPU Internal Cache	Enabled	
Enaled External Cache	Enabled	Menu Level ►
CPU L2 Cache ECC Checking	Enabled	
Processor Number Feature	Enabled	
Quick Power On Self Test	Enabled	Allows you to choose the VIRUS warning feature for IDE Hard
First Boot Device	Floppy	Disk boot sector
Second Boot Device	HDD-0	protection. If this
Third Boot Device	LS120	function is ebabled
Boot Other Device	Enabled	and someone attempt to
Swap Floppy Drive	Disabled	write data into this
Typematic Rate Setting	Disabled	area, BIOS will show
X Typematic Rate (Chars/Sec)	6	A warning message on
X Typematic Delay (Msec)	250	screen and alarm beep
Security Option	Setup	
OS Select For DRAM >64MB	Non-OS2	
Report No FDD For WIN 95	No	

↑ ↓ → ← : Move Enter :Select +/-/PU/PD :Value F10 :Save ESC :Exit F1 :General Help
F5 :Previous Values F6 :Fail-Safe Defaults F7 : Optimized Defaults

Virus Warning

This option allows you to choose the VIRUS Warning feature for IDE Hard Disk boot sector protection. If this function is enabled and someone attempts to write data into this area, BIOS will show a warning message on screen and alarm beep.

Disabled (default)	No warning message appears when anything attempts to access the boot sector or hard disk partition table.
Enabled	Activates automatically when the system boots up causing a warning message to appear when anything attempts to access the boot sector of hard disk partition table.

CPU Internal /External Cache

These two categories speed up memory access. However, it depends on CPU/chipset design.

Enabled (default)	Enable cache
Disabled	Disable cache

CPU L2 Cache ECC Checking

This item allows you to enable/disable CPU L2 Cache ECC checking.

The Choices: Enabled (default), Disabled.

Process Number Feature

The VIA process serial number control option.

The Choices: Enabled (default), Disabled.

Quick Power On Self Test

This category speeds up Power on Self-Test (POST) after you power up the computer. If it is set to Enabled, BIOS will shorten or skip some check items during POST.

The Choices: Enabled (default), Disabled.

First /Second/Third Boot Device

These BIOS attempts to load the operating system from the devices in the sequence selected in these items.

The Choices: Floppy, LS120, HDD-0, SCSI, CDROM, HDD-1, HDD-2, HDD-3, ZIP100, LAN, Disabled.

Boot Other Device

The Choices: Enabled (default), Disabled.

Swap Floppy Drive

If the system has two floppy drives, you can swap the logical drive name assignments.

The Choices: Enabled, Disabled (default).

Typematic Rate Setting

Keystroke repeat at a rate determined by the keyboard controller. When enabled, the typematic rate and typematic delay can be selected.

The Choices: Enabled, Disabled (default).

Typematic Rate (Chars / Sec)

Sets the number of times a second to repeat a keystroke when you hold the key down.

The Choices: 6 (default), 8, 10, 12, 15, 20, 24, 30.

Typematic Delay (Msec)

Sets the delay time after the key is held down before it begins to repeat the keystroke.

The Choices: 250 (default), 500, 750, 1000.

Security Option

Select whether the password is required every time the system boots or only when you enter setup.

System	The system will not boot and access to Setup will be denied if the correct password is not entered at the prompt.
Setup (default)	The system will boot, but access to Setup will be denied if the correct password is not entered at the prompt.

Note: To disable security, select *PASSWORD SETTING* at Main Menu and then you will be asked to enter password. Do not type anything and just

press <Enter>, it will disable security. Once the security is disabled, the system will boot and you can enter Setup freely.

OS Selection for DRAM > 64MB

Select the operating system that is running with greater than 64MB of RAM on the system.

The Choices: Non-OS2 (default), OS2.

Report No FDD For WIN 95

Whether report no FDD for Win 95 or not.

The Choices: Yes, No (default).

2.4 Advanced Chipset Features

This section allows you to configure the system based on the specific features of the installed chipset. This chipset manages bus speeds and access to system memory resources, such as DRAM and the external cache. It also coordinates communications between the conventional PCI bus. It must be stated that these items should never need to be altered. The default settings have been chosen because they provide the best operating conditions for your system. The only time you might consider making any changes would be if you discovered that data was being lost while using your system.

■ Figure 4. Advanced Chipset Setup

CMOS Setup Utility-Copyright (C) 1984-2000 Award Software
Advanced Chipset Features

SDRAM CAS Latency Time	Auto	Item Help
Slight Adjust	Disabled	Menu Level ▶
X Clock By Slight Aadjust	66	
CPU Clock Ratio	X3	

↑ ↓ → ← : Move Enter :Select +/-/PU/PD :Value F10 :Save ESC :Exit F1 :General Help
 F5 :Previous Values F6 :Fail-Safe Defaults F7 : Optimized Defaults

SDRAM CAS Latency Time

When synchronous DRAM is installed, the number of clock cycles of CAS latency depends on the DRAM timing.

The Choices: Auto (default), 2, 3.

Slight Adjust

This item allows you to adjust CPU frequency when “Slight Adjust” select enable.

The Choices: Enabled, Disabled (default).

Clock By Slight Adjust

This item allows you to adjust CPU frequency.

CPU Clock Ratio

This item allows you to select CPU Clock ratio.

2.5 Integrated Peripherals

■ Figure 5. Integrated Peripherals

CMOS Setup Utility-Copyright (C) 1984-2000 Award Software
Integrated Peripherals

▶ On-Chip IDE Control	Press Enter	▲ ▼	Item Help
USB Controller	Enabled		Menu Level ▶
USB Keyboard	Disabled		
Init Display First	PCI Slot		
AC97 Audio	Auto		
AC97 Modem	Auto		
Onboard FDC Controller	Enabled		
Onboard Serial Port 1	3F8/IRQ4		
Onboard Serial Port 2	2F8/IRQ3		
UART Mode Select	Standard		
Onboard Parallel Port	378/IRQ7		
Parallel Port Mode	Standard		
X ECP Mode Use DMA	3		
PWRON After PWR-Fail	Off		
Game Port Address	200		
Midi Port Address	300		
Midi Port IRQ	10		

▲ ▼ ▶ ◀ : Move Enter : Select +/-/PU/PD : Value F10 : Save ESC : Exit F1 : General Help
 F5 : Previous Values F6 : Fail-Safe Defaults F7 : Optimized Defaults

OnChip IDE Control

The chipset contains a PCI IDE interface with support for two IDE channels. Select "Enabled" to activate the first and/or second IDE interface. Select "Disabled" to deactivate an interface, if you install a primary and/or secondary add-in IDE interface. If you highlight the literal "Press Enter" next to the "Onchip IDE Control" label and then press the enter key, it will take you a submenu with the following options:

On-Chip Primary /Secondary PCI IDE

The integrated peripheral controller contains an IDE interface with support for two IDE channels. Select Enabled to activate each channel separately.

The Choices: Enabled (default), Disabled.

IDE Primary / Secondary Master / Slave PIO

The IDE PIO (Programmed Input / Output) fields let you set a PIO mode (0-4) for each of the IDE devices that the onboard IDE interface supports. Modes 0 through 4 provide successively increased performance. In Auto mode, the system automatically determines the best mode for each device.

The Choices: Auto (default), Mode0, Mode1, Mode2, Mode3, Mode4.

IDE Primary / Secondary Master / Slave UDMA

Ultra DMA /33 implementation is possible only if your IDE hard drive supports it and the operating environment includes a DMA drive (Windows 95 OSR2 or a third party IDE bus master driver). If your hard drive and system software both support Ultra DMA/33 & DMA/66, select Auto to enable BIOS support.

The Choices: Auto (default), Disabled.

IDE HDD Block Mode

Block mode is also called block transfer, multiple commands, or multiple sector read/write. If your IDE hard drive supports block mode (most new drives do), select Enabled for automatic detection of the optimal number of block read/writes per sector the drive can support.

The Choices: Enabled (default), Disabled.

USB Controller

Select Enabled if your system contains an Universal Serial Bus (USB) controller and you have USB peripherals.

The Choices: Enabled (default), Disabled.

USB Keyboard Support

The default value is Disabled.

Enabled

Enable USB Keyboard Support.

Disable (default)

Disable USB Keyboard Support.

Init Display First

This item allows you decide to active whether PCI Slot or on-chip VGA first.

The Choices: PCI Slot (default), AGP.

AC97 Audio/Modem

This item allows you to decide to enable/disable the 810-chipset family to support AC97 Audio/Modem.

The Choices: Auto (default), Disabled.

Onboard FDC Controller

Select Enabled if your system has a floppy disk controller (FDC) installed on the system board and you wish to use it. If install and FDC or the system has no floppy drive, select Disabled in this field.

The Choices: Enabled (default), Disabled.

Onboard Serial Port 1/Port 2

Select an address and corresponding interrupt for the first and second serial ports.

The Choices: Disabled, Auto, 3F8/IRQ4, 2F8/IRQ3, 3E8/IRQ4, 2E8/IRQ3.

UART Mode Select

This item allows you to determine which InfraRed (IR) function of onboard I/O chip.

The Choices: IrDA SIR (default), Sharp IR, Standard.

Onboard Parallel Port

This item allows you to determine access onboard parallel port controller with which I/O Address.

The Choices: 378/IRQ7 (default), 278/IRQ5, 3BC/IRQ7, Disabled.

Parallel Port Mode

The default value is Standard.

SPP	Using Parallel port as Standard Printer Port.
Standard (default)	Using Parallel Port as bi-directional Parallel Port.
ECP	Using Parallel port as Extended Capabilities Port.
EPP1.9	Using Parallel port as Enhanced Parallel Port.
EPP1.7	Using Parallel Port as Enhanced Parallel Port.
ECP+EPP	Using Parallel port as ECP & EPP mode.

ECP Mode Use DMA

Select a DMA Channel for the port.

The Choices: 3 (default), 1.

PWRON After PWR-Fail

"Former-Sts" System will return former status after is re-applied.

"On" System will return to boot after power is re-applied.

"Off" System will return to the S5 status (off) In S5 status, the only enabled wake event is the Power Button or any enabled wake event that was preserved through the power failure.

Game Port Address

Game Port I/O Address.

200 (default)

210

Disabled

Midi Port Address

Midi Port Base I/O Address.

300 (default)

Disabled

330

Midi Port IRQ

This determines the IRQ in which the Midi Port can use.

The Choices: 5, 10 (default).

ACPI Function

This item allows you to enable/disable the Advanced Configuration and Power Management (ACPI).

The Choices: Enabled (default), Disabled.

ACPI Suspend Type

The item allows you to select the suspend type under ACPI operating system.

S1 (POS) (default)	Power on Suspend
S3 (STR)	Suspend to RAM

Power Management

This category allows you to select the type (or degree) of power saving and is directly related to the following modes:

- 1.HDD Power Down.
- 2.Doze Mode.
- 3.Suspend Mode.

Min Saving	Minimum power management. Doze Mode = 1 hr. Standby Mode = 1 hr., Suspend Mode = 1 hr., and HDD Power Down = 15 min.
Max Saving	Maximum power management. Doze Mode = 1 min., Standby Mode = 1 min., Suspend Mode = 1 min., and HDD Power Down = 1 min.
User Define (default)	This option allows you to set each mode individually. When not disabled, each of the ranges are from 1 min. to 1 hr. except for HDD Power Down, which ranges from 1 min. to 15 min. and disable.

Video Off Method

This determines the manner in which the monitor is blanked.

V/H SYNC+Blank	This selection will cause the system to turn off the vertical and horizontal synchronization ports and write blanks to the video buffer.
Blank Screen	This option only writes blanks to the video buffer.
DPMS (default)	Initial display power management signaling.

Video Off In Suspend

This determines the manner in which the monitor is blanked.

The Choices: Yes (default), No.

Suspend Type

Select the Suspend Type.

The Choices: PwrOn Suspend, **Stop Grant** (default).

MODEM Use IRQ

This determines the IRQ in which the MODEM can use.

The Choices: 3 (default), 4, 5, 7, 9, 10, and 11, NA.

Suspend Mode

When enabled and after the set time of system inactivity, all devices except the CPU will be shut off.

The Choices: **Disabled** (default), 1Min, 2Min, 4Min, 8Min, 12Min, 20Min, 30Min, 40Min, and 1Hour.

HDD Power Down

When enabled and after the set time of system inactivity, the hard disk drive will be powered down while all other devices remain active.

The Choices: **Disabled** (default), 1Min, 2Min, 3Min, 4Min, 5Min, 6Min, 7Min, 8Min, 9Min, 10Min, 11Min, 12Min, 13Min, 14Min, and 15Min.

Soft-Off by PWR-BTTN

Pressing the power button for more than 4 seconds forces the system to enter the Soft-Off state when the system has "hung."

The Choices: Delay 4 Sec, **Instant-Off** (default)

Wake-Up by PCI card

When you select Enabled, a PME signal from PCI card returns the system to Full On state.

The Choice: Enabled, **Disabled** (default).

Power On by Ring

An input signal on the serial Ring Indicator (RI) line (in other words, an incoming call on the modem) awakens the system from a soft off state.

The Choices: Enabled (default), Disabled.

Wake Up On LAN

To use this function, you need a LAN add-on card which support power on functions. It should also support the wake-up on LAN jumper.

The Choices: Enabled (default), Disabled.

Resume by Alarm

This function is for setting date and time for your computer to boot up. During Disabled, you cannot use this function. During Enabled, Choose the Date and Time Alarm:

Date (of month) Alarm You can choose which month the system will boot up.

Time (hh:mm:ss) Alarm You can choose the 10hour, minute and second the system will boot up.

Note: If you have change the setting, you must let the system boot up until it goes to the operating system, before this function will work.

PM Events

PM events are I/O events whose occurrence can prevent the system from entering a power saving mode or can awaken the system from such a mode. In effect, the system remains alert for anything, which occurs to a device, which is configured as *Enabled*, even when the system is in a power down mode.

Primary IDE 0/1

Secondary IDE 0/1

FDD, COM, LPT Port

PCI PIRQ [A-D]#

2.7 PnP/PCI Configurations

This section describes configuring the PCI bus system. PCI, or Personal Computer Interconnect, is a system which allows I/O devices to operate at speeds nearing the speed the CPU itself uses when communicating with its own special components. This section covers some very technical items and it is strongly recommended that only experienced users should make any changes to the default settings.

■ Figure 7. PnP/PCI Configurations

CMOS Setup Utility-Copyright (C) 1984-2000 Award Software
PnP/PCI Configurations

Reset Configuration Data	Disabled	Item Help
Resources Controlled By	Auto (ESCD)	Menu Level ►
X IRQ Resources	Press Enter	Default is Disabled.
PCI/VGA Palette Snoop	Disabled	Select Enabled to reset Extended System Configuration Data (ESCD) when you exit Setup if you have installed a new add-on and the system reconfiguration has caused such a serious conflict that the OS cannot boot

↑ ↓ → ← : Move Enter :Select +/-/PU/PD :Value F10 :Save ESC :Exit F1 :General Help
F5 :Previous Values F6 :Fail-Safe Defaults F7 : Optimized Defaults

Reset Configuration Data

The system BIOS supports the PnP feature so the system needs to record which resource is assigned and proceeds resources from conflict. Every peripheral device has a node, which is called ESCD. This node records which resources are assigned to it. The system needs to record and update ESCD to the memory locations. These locations (4K) are reserved at the system BIOS.

If Disabled (default) is chosen, the system's ESCD will update only when the new configuration varies from the last one.

If Enabled is chosen, the system is forced to update ESCDs and then is automatically set to the "Disabled" mode.

IRQ-3	assigned to: PCI / ISA PnP
IRQ-4	assigned to: PCI / ISA PnP
IRQ-5	assigned to: PCI / ISA PnP
IRQ-7	assigned to: PCI / ISA PnP
IRQ-9	assigned to: PCI / ISA PnP
IRQ-10	assigned to: PCI / ISA PnP
IRQ-11	assigned to: PCI / ISA PnP
IRQ-12	assigned to: PCI / ISA PnP
IRQ-14	assigned to: PCI / ISA PnP
IRQ-15	assigned to: PCI / ISA PnP

The above settings will be shown on the screen only if "Manual" is chosen for the Resources Controlled By function.

Resources Controlled By

By Choosing "Auto(ESCD)" the system BIOS will detect the system resources and automatically assign the relative IRQ channel for each peripheral.

By Choosing "Manual", the user will need to assign IRQ for add-on cards. Be sure that there are no IRQ and I/O port conflicts.

IRQ Resources

When resources are controlled manually, assign each system interrupt a type, depending on the type of device using the interrupt.

PCI / VGA Palette Snoop

Choose Disabled or Enabled. Some graphic controllers which are not VGA compatible take the output from a VGA controller and map it to their display as a way to provide boot information and VGA compatibility.

However, the color information coming from the VGA controller is drawn from the palette table inside the VGA controller to generate the proper colors, and the graphic controller needs to know what is in the palette of the VGA controller.

To do this, the non-VGA graphic controller watches for the Write access to the VGA palette and registers the snoop data. The palette snoop bit will be set by the system BIOS when it detects both a VGA device and a graphics accelerator device that are on separate boards on the same bus or on the same path but on different buses. When both agents are PCI devices that reside on the same bus, either device can be set to snoop and the other will be set to positively respond. Unless you have the above situation, you should disabled this option.

Disabled (default)	Disables the function.
Enabled	Enables the function.

2.8 PC Health Status

■ Figure 8. PC Health Status

CMOS Setup Utility-Copyright (C) 1984-2000Award Software
PC Health Status

+5V	XXX	Item Help
CPU Voltage	XXX	Menu Level ▶
VTT (1.5v)	XXX	
2.5V	XXX	
+12 Voltage	XXX	
-12 Voltage	XXX	
Analog 3.3V Power Supply	XXX	
CPU Temperature	XXX	
System Temperature	XXX	
System FAN Speed	XXX	
CPU FAN Speed	XXX	

↑ ↓ → ← : Move Enter :Select +/-/PU/PD :Value F10 :Save ESC :Exit F1 :General Help
F5 :Previous Values F6 :Fail-Safe Defaults F7 : Optimized Defaults

Current Voltage (V) VCCVID,VTT,+3.3V,+5V, ±12V,2.5V

Detect system's voltage status automatically.

CPU Temperature

Show you the current CPU temperature.

System Temperature

Show you the current system temperature.

System FAN Speed

Show you the current System FAN speed.

CPU FAN Speed

Show you the current CPU FAN speed.

2.9 Load Fail-Safe Defaults

When you press <Enter> on this item you get a confirmation dialog box with a message similar to:

■ **Figure 9. Load Fail-Safe Defaults**

CMOS Setup Utility-Copyright (C) 1984-2000 Award Software

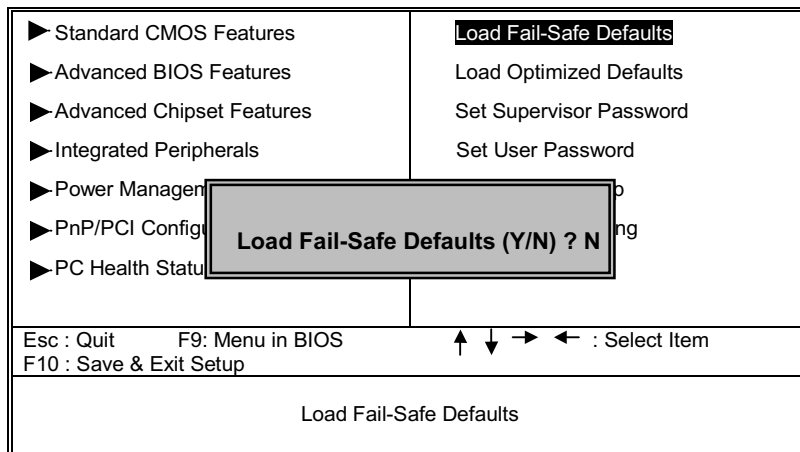

Pressing 'Y' loads the BIOS default values for the most stable, minimal-performance system operations.

2.10 Load Optimized Defaults

When you press <Enter> on this item you get a confirmation dialog box with a message similar to:

■ Figure 10. Load Optimized Defaults

CMOS Setup Utility-Copyright (C) 1984-2000 Award Software

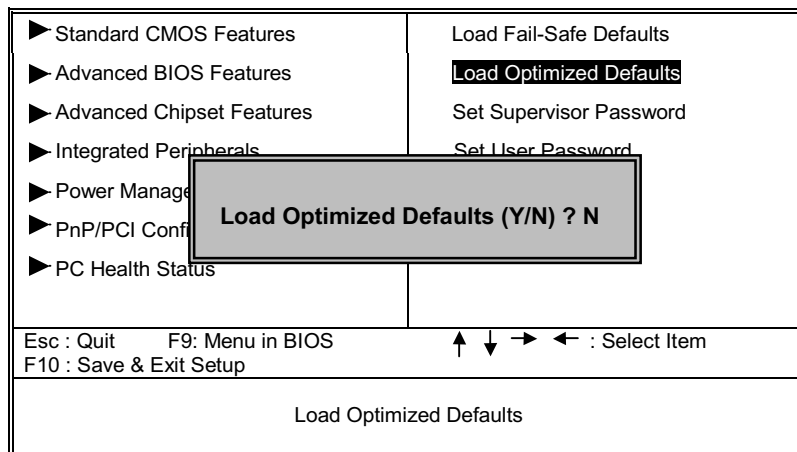

Pressing 'Y' loads the default values that are factory settings for optimal performance system operations.

2.11 Set Supervisor/User Password

■ Figure 11. Set Supervisor/User Password

CMOS Setup Utility-Copyright (C) 1984-2000 Award Software

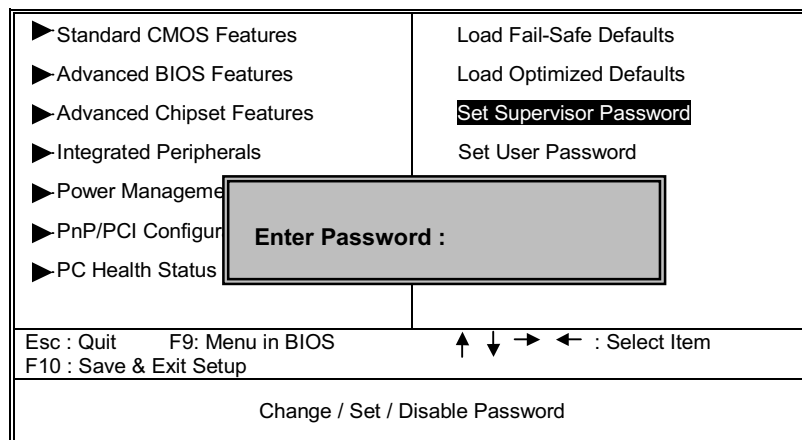

When you select this function, the following message will appear at the center of the screen to assist you in creating a password.

ENTER PASSWORD

Type the password, up to eight characters, and press <Enter>. The password you type now will clear any previously entered password from CMOS memory. You will be asked to confirm the password. Type the password again and press <Enter>. You may also press <ESC> to abort the selection and not enter a password. To disable password, just press <Enter> when you are prompted to enter password. A message will confirm that you wish to disable the password. Once the password is disabled, the system will boot and you can enter setup freely.

PASSWORD DISABLED

If you select "System" at the Security Option of BIOS Features Setup Menu, you will be prompted for the password every time the system is rebooted or any time you try to enter Setup. If you select "Setup" at Security Option of BIOS Feature Setup Menu, you will be prompted only when you try to enter Setup.

2.12 Save & Exit Setup

■ Figure 12. Save & Exit Setup

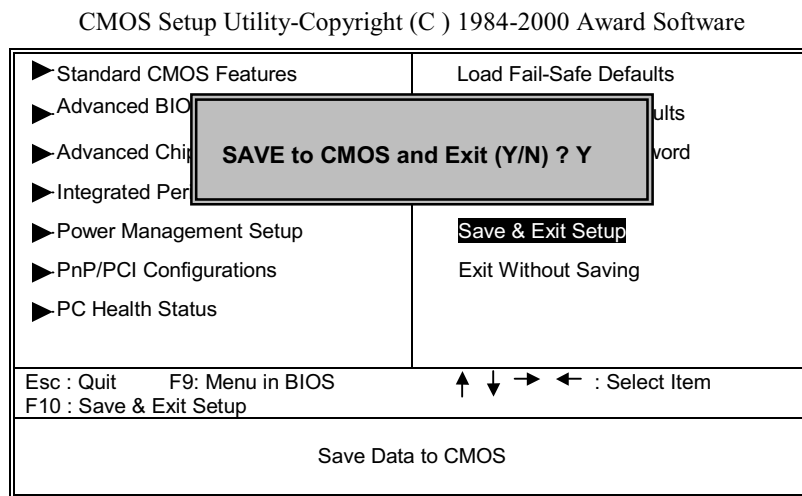

Type "Y" will quit the Setup Utility and save the user setup value to RTC CMOS RAM.
Type "N" will return to Setup Utility.

2.13 Exit Without Saving

■ Figure 13. Exit Without Saving

CMOS Setup Utility-Copyright (C) 1984-2000 Award Software

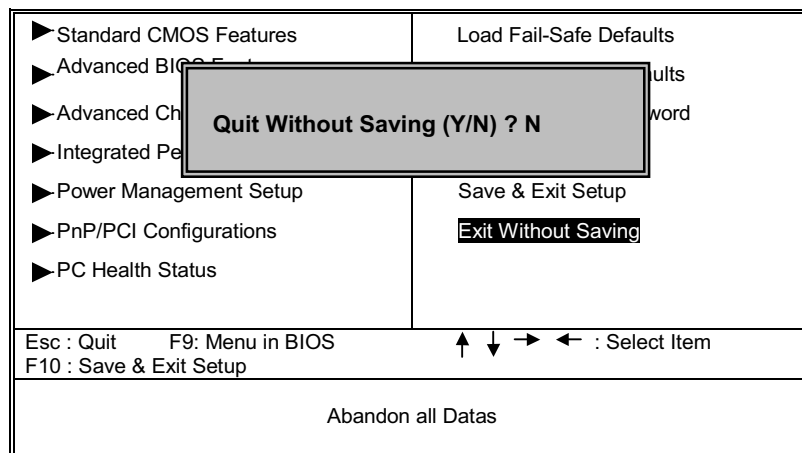

Type "Y" will quit the Setup Utility without saving to RTC CMOS RAM.
Type "N" will return to Setup Utility.

3. Software Setup

NOTE: The mark * means it can be installed directly from CD by using CD Installation Utility (i.e. SETUP.EXE).

3.1 Software List

Category	Description	Platform	Location in CD
Windows 9x Inf Patch Utility Driver *	The INF Update Utility for Intel Chipsets installs to the target system the Windows* 95 or Windows* 98 INF files that outline to the operating system how the chipset components shall be configured.	Windows 95/98/2000	\\Driver\\Chipset\\ Intel\\NFINST
Intel Security *	Use the Firmware Hub component of the Intel 81x Chipsets to generate Random Numbers.	Windows 95/98//ME/NT4.0 /2000	\\Driver\\Chipset\\ Intel\\Security
Intel(r) Ultra ATA Storage Driver *	The Intel Ultra ATA Storage Driver automatically enables fast Ultra ATA transfers for a variety of ATA/ATAPI mass storage devices such as hard disk drives and CD-ROMs.	Windows 98/ME/2000/NT4.0	\\Driver\\Chipset\\ Intel\\UltraATA
Award Flash Utility	Used for updating BIOS. (Please refer to chapter - Application Software.)	Need to be run under DOS environment.	\\Software\\ Flash
Microsoft DCOM *	Microsoft DCOM runtime library	Windows 95/98	\\Software\\ Dcom
Microsoft DirectX 8.0*	Microsoft DirectX runtime library	Windows 95/98/ME/2000	\\Software\\ DirectX

3.2 On Board Audio Device Driver List

1. When selecting the On board Audio Driver (See Figure 1 , section 3.3)

The Installation wizard will automatically detect the on board audio device and install the proper drivers.

2.The following table shows the optioned audio device and the relative driver path.

Category	Description	Platform	Location in CD
Analog Integrated Digital Audio (Optional) *	Install the drivers to enable the Analog AC97 Audio Device	Windows 95/98/ME/NT4.0 /2000	\\Driver\\Audio\\Analog
Crystal Audio (Optional) *	Install the drivers to enable the Crystal AC97 Audio Device	Windows 95/98//ME/NT4.0 /2000	\\Driver\\Audio\\Crystal
Sigmatel Audio (Optional) *	Install the drivers to enable the Sigmatel(STAC9708T) AC97 Audio Device	Windows 95/98//ME/NT4.0 /2000	\\Driver\\Audio\\Sigmatel\\9708
Sigmatel Audio (Optional) *	Install the drivers to enable the Sigmatel(STAC9721T) AC97 Audio Device	Windows 95/98/ME/NT4.0 /2000	\\Driver\\Audio\\Sigmatel\\9721
Creative SB PCI128 Audio * (Option) *	Install the driver to enable the Creative Audio Device	Windows 95/98//NT4/ME/2000	\\Driver\\Audio\\Creative
Aureal Vortex AU8810 PCI Audio(Optional)	Install the drivers to enable the Aureal AC97 Audio Device	Windows 95/98/NT4.0/2000	\\Driver\\Audio\\Aureal

3.3 Software Installation

We provide an installation wizard, Driver CD Installation Utility (SETUP.EXE), located in the root of Driver CD to let users install some common used drivers conveniently.

The Wizard can automatically detect OS and switch to the proper page, so you don't need to worry about installing the wrong drivers.

You can simply put Driver CD into CD-ROM drive and the Installation Utility will autorun or you can launch the Driver CD Installation Utility manually.

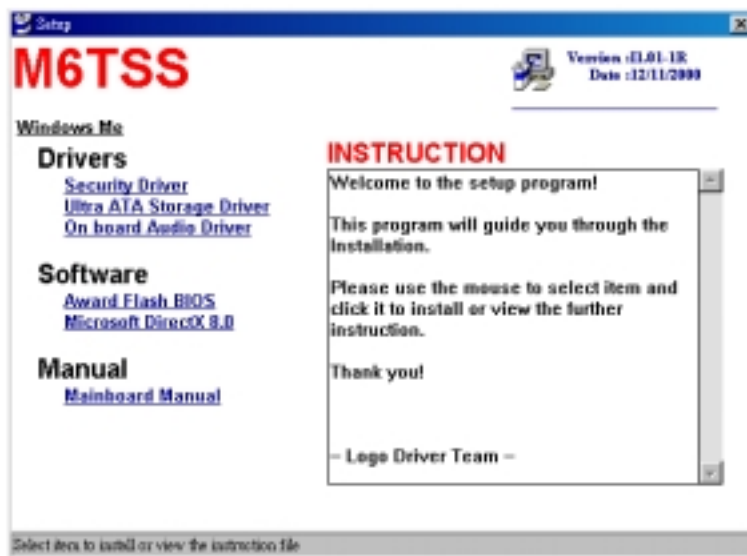

Figure 1 Installation Wizard Main Page

There are two kinds of Installation Procedure:**Note: Automatically detect main board**

You can simply put Driver CD into CD-ROM drive. The Installation wizard will show to you main board's name(see fig1 , **section 3.3**). You can watch the left top side on the tabled.

➤ **Automatically Install drivers from CD by using CD Installation Utility:**

Use the mouse cursor to click the proper option on the page. Utility will invoke other applications to complete the rest of installation.

➤ **When the drivers CAN NOT be installed directly from CD by using CD Installation Utility, please do the following procedure:**

You can put Driver CD into CD-ROM manually run "setup.exe". (in the root directly.)

4. Trouble Shooting

PROBLEM

No power inputs to the system at all. Power light does not illuminate, fan inside power supply does not turn on. Indicator light on keyboard does not turn on.

PROBABLE CAUSE	DIAGNOSIS	SOLUTION
Power cable is unplugged.	Visually inspect power cable.	Make sure power cable is securely plugged in.
Defective power cable.	Visually inspect the cable; try another cable.	Replace cable.
Power supply failure.	Power cable and wall socket are OK, but system is still dead.	Contact technical support.
Faulty wall outlet; circuit Breaker or fuse blown.	Plug in device known to work in socket and test.	Use different socket, repair outlet, reset circuit breaker or replace fuse.

PROBLEM

System is inoperative. Keyboard lights are on, power indicator lights are lit, hard drive is spinning.

PROBABLE CAUSE	DIAGNOSIS	SOLUTION
Memory DIMM is partially dislodged from the slot on the motherboard.	Turn off computer. Take cover off system unit. Check the DIMM to ensure it is securely seated in the slot.	Using even pressure on both ends of the DIMM, press down firmly until the module snaps into place.

PROBLEM

System does not boot from hard disk drive, can be booted from CD-ROM drive.

PROBABLE CAUSE	DIAGNOSIS	SOLUTION
Connector between hard drive and system board unplugged.	When attempting to run the FDISK utility you get a message, INVALID DRIVE SPECIFICATION.	Check cable running from disk to disk controller board. Make sure both ends are securely plugged in; check the drive type in the standard CMOS setup.
Damaged hard disk or disk controller.	Format hard disk; if unable to do so the hard disk may be defective.	Contact technical support.
Hard disk directory or FAT is scrambled.	Run the FDISK program, format the hard drive. Copy data that was backed up onto hard drive.	Backing up the hard drive is extremely important. All hard disks are capable of breaking down at any time.

PROBLEM

System only boots from CD-ROM. Hard disk can be read and applications can be used but booting from hard disk is impossible.

PROBABLE CAUSE	DIAGNOSIS	SOLUTION
Hard disk boot program has been destroyed.	A number of causes could be behind this.	Back up data and applications files. Reformat the hard drive. Re-install applications and data using backup disks.

PROBLEM

Error message reading “SECTOR NOT FOUND” or other error messages not allowing certain data to be retrieved.

PROBABLE CAUSE	DIAGNOSIS	SOLUTION
A number of causes could be behind this.	Use a file-by-file backup instead of an image backup to backup the hard disk.	Back up any salvageable data. Then, low-level format, partition, and high-level format the hard drive. Re-install all saved data when completed.

PROBLEM

Screen message says “Invalid Configuration” or “CMOS Failure.”

PROBABLE CAUSE	DIAGNOSIS	SOLUTION
Incorrect information entered into the configuration (setup) program.	Check the configuration program. Replace any incorrect information.	Review system’s equipment . Make sure correct information is in setup.

PROBLEM

Screen is blank.

PROBABLE CAUSE	DIAGNOSIS	SOLUTION
No power to monitor.		Check the power connectors to monitor and to system. Make sure monitor is connected to display card.
Monitor not connected to computer.		See instructions above.

PROBLEM

PROBABLE CAUSE	DIAGNOSIS	SOLUTION
Memory problem.		Reboot computer. Reinstall memory, make sure that all memory modules are installed in correct sockets.
Computer virus.		Use anti-virus programs to detect and clean viruses.

PROBLEM

Screen goes blank periodically.

PROBABLE CAUSE	DIAGNOSIS	SOLUTION
Screen saver is enabled.		Disable screen saver.

PROBLEM

Keyboard failure.

PROBABLE CAUSE	DIAGNOSIS	SOLUTION
Keyboard is disconnected.		Reconnect keyboard. Check keys again, if no improvement replace keyboard.

PROBLEM

No display on screen.

PROBABLE CAUSE	DIAGNOSIS	SOLUTION
Faulty Monitor.		If possible, connect monitor to another system. If no color replace monitor.
CMOS incorrectly set up.		Call technical support.

PROBLEM

C: drive failure.

PROBABLE CAUSE	DIAGNOSIS	SOLUTION
Hard drive cable not connected properly.		Check hard drive cable.

PROBLEM

Cannot boot system after installing second hard drive.

PROBABLE CAUSE	DIAGNOSIS	SOLUTION
Master/slave jumpers not set correctly.		Set master/slave jumpers correctly.
Hard drives not compatible / different manufacturers.		Run SETUP program and select correct drive types. Call drive manufacturers for compatibility with other drives.

PROBLEM

Missing operating system on hard drive.

PROBABLE CAUSE	DIAGNOSIS	SOLUTION
CMOS setup has been changed.		Run setup and select correct drive type.

PROBLEM

Certain keys do not function.

PROBABLE CAUSE	DIAGNOSIS	SOLUTION
Keys jammed or defective.		Replace keyboard.

PROBLEM

Keyboard is locked, no keys function.

PROBABLE CAUSE	DIAGNOSIS	SOLUTION
Keyboard is locked.		Unlock keyboard.

02/05/2001
MADE IN TAIWAN
R.O.C.