

6KME

**82440 EX PCI Mainboard
User's Guide &
Technical Reference**



SOYOTM

About This Guide

This User's Guide is for assisting system manufacturers and end users in setting up and installing the mainboard. Information in this guide has been carefully checked for reliability; however, no guarantee is given as to the correctness of the contents. The information in this document is subject to change without notice.

Copyright Notice

Copyright 1997, Soyo Computer Inc. All rights reserved. This manual is copyrighted by Soyo Computer Inc. You may not reproduce, transmit, transcribe, store in a retrieval system, or translate into any language, in any form or by any means, electronic, mechanical, magnetic, optical, chemical, manual, or otherwise, any part of this publication without express written permission of Soyo Computer Inc.

Trademarks

Soyo is a registered trademark of Soyo Computer Inc. All trademarks are the property of their owners.

Disclaimer

Soyo Computer Inc. makes no representations or warranties regarding the contents of this manual. We reserve the right to revise the manual or make changes in the specifications of the product described within it at any time without notice and without obligation to notify any person of such revision or change. The information contained in this manual is provided for general use by our customers. Our customers should be aware that the personal computer field is the subject of many patents. Our customers should ensure that they take appropriate action so that their use of our products does not infringe upon any patents. It is the policy of Soyo Computer Inc. to respect the valid patent rights of third parties and not to infringe upon or assist others to infringe upon such rights.

Restricted Rights Legend

Use, duplication, or disclosure by the Government is subject to restrictions set forth in subparagraph (c)(1)(ii) of the Rights in Technical Data and Computer Software clause at 252.277-7013.

Product Rights

Product mentioned in this manual are mentioned for identification purpose only. Product names appearing in this manual may or may not be registered trademarks or copyrights of their respective companies.

If you need any further information, please come to our home page on internet. The address is "<http://www.soyo.com.tw>".

Edition: May 1998

Version 1.0

6KME SERIAL

FC Tested To Comply
With FCC Standards
FOR HOME OR OFFICE USE

Table of Contents

Chapter 1: Introduction	1
Key Features	1
Unpacking the Mainboard	2
Electrostatic Discharge Precautions	2
Mainboard Layout w/ Default Settings	3
Chapter 2: Hardware Setup	5
Jumpers	5
JP5: CMOS Clear Jumper	5
CPU Type Configuration	5
Memory Configuration	6
Multi I/O Port Addresses	6
Connectors	7
P2 – ATX Power Supply Connectors	7
PS/2 Keyboard Connector	7
PS/2 Mouse Connector	7
IR – IR Connector	8
Keylock & Power LED Connector	8
SPK – Speaker Connector	8
RST – Hardware Reset Control	8
IDE1/IDE2 – On-board Primary/Secondary IDE HDD Connectors	8
COM1/COM2 Connectors	8
IDE LED – IDE HDD LED Connectors	9
FDC Connector	9
PRT – Parallel Port Connector	9
USB1/USB2 – Universal Serial Bus Connector	9
PWRBT – ATX Power Supply On/Off Switch Connector (Momentary Type)	9
JP44 – Wake-On-LAN (WOL) Header	9
CPU, CHA: Cooling Fan Connectors	10
SB-LINK – PCI Audio Card Connector	10
JP10: PS/2 Keyboard WakeUp	11
Slot 1 Installation Guide	12
Chapter 3: BIOS Setup	18
Standard CMOS Setup	19
BIOS Features Setup	21
Chipset Features Setup	24
Power Management Setup	28
PNP/PCI Configuration Setup	31
Load Setup Defaults	33

Load BIOS Defaults	33
Integrated Peripherals	34
Supervisor Password	38
User Password	39
IDE HDD Auto Detection	40
Quick Installation Guide	41
Motherboard Layout	41
Memory Configurations	41
Connectors and Jumper Settings	42
Default I/O Settings	42

1 Introduction

The 82440 EX PCI mainboard is a high-performance ATX architecture system board that supports the Pentium II processor family. This mainboard is fully compatible with industry standards, and adds many technical enhancements.

Key Features

- Processor supports:
 - Intel Pentium II CPU up to 66 MHz host bus frequency (233 ~ 333 MHz)
 - **auto detection of CPU voltage**
- DRAM controller:
 - **supports 2 strips of 168-pin EDO /SDRAM Unbuffered DIMM**
 - supports auto detection of memory type
 - **supports ECC configuration**
 - has onboard memory configurations from 8MB to 256MB
- BUS controller:
 - complies with the PCI specifications v2.1
 - One 32-bit AGP slot onboard
 - two 32-bit PCI slots (Masters) and two ISA slots
 - **supports Universal Serial Bus—USB onboard**
- Peripheral controller:
 - System BIOS supports “Plug and Play” function
 - onboard built-in PCI Master IDE controller and floppy controller
 - onboard two high speed UARTS (w/i 16550 FIFO) and Multimode parallel port for Standard, Enhanced (EPP) and high speed (ECP) modes, PS/2 mouse function
 - onboard FLASH Memory for easy BIOS upgrades
 - **onboard support for IR function**

Unpacking the Mainboard

The mainboard package contains:

- The 82440EX Mainboard
- A disc and a manual OR a CD and a Quick Installation Guide

Note: Do not unpack the mainboard until you are ready to install it.

Follow the precautions below while unpacking the mainboard.

1. Before handling the mainboard, ground yourself by grasping an unpainted portion of the system's metal chassis.
2. Remove the mainboard from its anti-static packaging and place it on a grounded surface, component side up.
3. Check the mainboard for damage. If any chip appears loose, press carefully to seat it firmly in its socket.

Do not apply power if the mainboard appears damaged. If there is damage to the board contact your dealer immediately.

Electrostatic Discharge Precautions

Make sure you ground yourself before handling the mainboard or other system components. Electrostatic discharge can easily damage the components. Note that you must take special precaution when handling the mainboard in dry or air-conditioned environments.

Take these precautions to protect your equipment from electrostatic discharge:

- Do not remove the anti-static packaging until you are ready to install the mainboard and other system components.
- Ground yourself before removing any system component from its protective anti-static packaging. To ground yourself grasp the expansion slot covers or other unpainted portions of the computer chassis.
- Frequently ground yourself while working, or use a grounding strap.
- Handle the mainboard by the edges and avoid touching its components.

Mainboard Layout w/ Default Settings

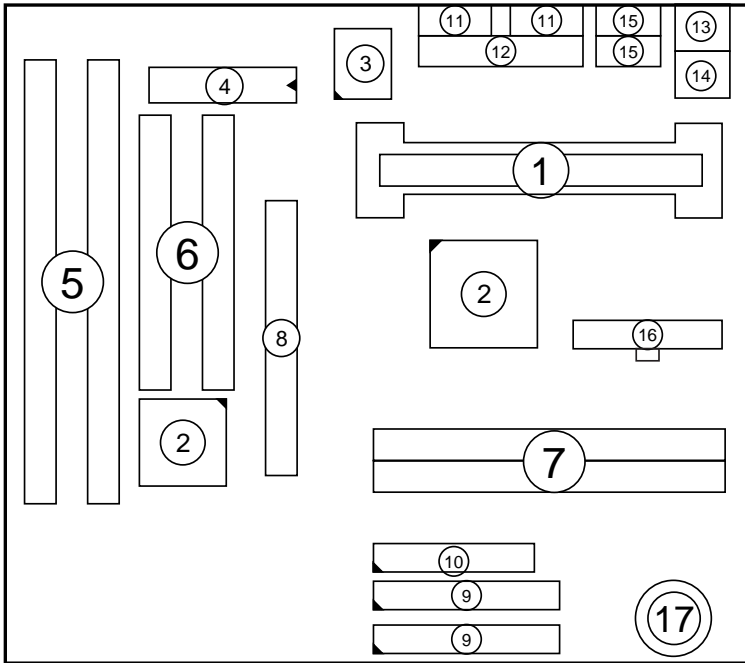

Figure 1-1. Mainboard Layout

- | | | | |
|----|--------------------|-----|------------------------------------|
| 1. | Slot 1 for PII CPU | 9. | IDE1/IDE2 Connector |
| 2. | 82440EX Chipset | 10. | Floppy Connector |
| 3. | Ultra I/O Chip | 11. | COM1/COM2 Connector |
| 4. | PnP FLASH BIOS | 12. | Parallel Port Connector |
| 5. | ISA Slot | 13. | PS/2 Keyboard Connector |
| 6. | PCI Slot | 14. | PS/2 Mouse Connector |
| 7. | DIMM Memory Bank | 15. | USB 1/2 Connector |
| 8. | AGP Port | 16. | ATX Power Connector |
| | | 17. | CMOS Battery (Lithium battery, 3V) |

Default settings are as follows: Pentium II 233MHz* CPU, On-board PCI Bus IDE Enabled, FDC Enabled, 2 high speed UARTS Enabled (w/ 16550 FIFO), 1 EPP/ECP port (ECP + EPP mode), and ATX Power Supply.

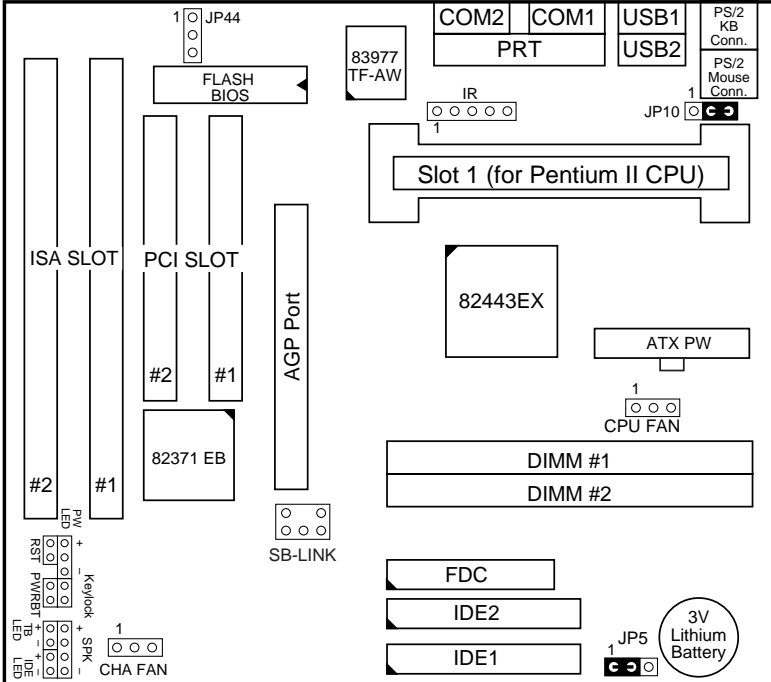

Figure 1–2. Mainboard Default Setting

* The 233MHz setting is used as default and as a “safe” frequency to allow the board to boot-up at any time when the BIOS settings are erased or reset. Refer to the “CPU Type Configuration” section of Chapter 2.

Important: *Make sure the system is well ventilated to prevent overheating and ensure system stability.*

2 Hardware Setup

This chapter explains how to configure the mainboard's hardware. After you install the mainboard, you can set jumpers, install memory on the mainboard, and make case connections. Refer to this chapter whenever you upgrade or reconfigure your system.

CAUTION: *Turn off power to the mainboard, system chassis, and peripheral devices before performing any work on the mainboard or system.*

Jumpers

JP5: CMOS Clear Jumper

Clear the CMOS memory by setting this jumper to 2-3, then set the jumper back to 1-2 to retain the new settings.

CMOS Setting	JP5						
Retain CMOS data (default)	<table><tr><td>1</td><td>2</td><td>3</td></tr><tr><td>●</td><td>●</td><td>○</td></tr></table>	1	2	3	●	●	○
1	2	3					
●	●	○					
Clear CMOS data	<table><tr><td>1</td><td>2</td><td>3</td></tr><tr><td>○</td><td>●</td><td>●</td></tr></table>	1	2	3	○	●	●
1	2	3					
○	●	●					

CPU Type Configuration

This mainboard is designed so that it is not necessary to use any jumpers to set the CPU frequency and multipliers onboard. Instead of using jumpers, the settings for the CPU frequency are set through the BIOS Setup which allows you to use any type of CPU from the Pentium II family's 233-333 range.

In order to change the CPU type, you need to enter the BIOS by pressing the <Delete> key during boot-up and then select the "Chipset Features Setup" menu. There is an item called "CPU Frequency Pentium II" under this setup section and it allows you to set the frequency according to the speed of the Pentium II CPU that you have, which should be clearly indicated on the case. The choices of settings are 133, 166, 200, 233, 266, 300, and 333 MHz. The 233 MHz setting is used as default and as a "safe" frequency which means the board can be boot-up at any time even if the BIOS settings are erased or reset, however, there is no Pentium II CPU of that frequency.

If the frequency is set too high, the CPU will not be able to function properly and the board will not boot up. By pressing the <Insert> key a few times while turning on the computer, the frequency will be set back to the default value, 233MHz, and you will be able to enter the BIOS Setup to correct the CPU frequency value.

Memory Configuration

The mainboard supports three banks of **168-pin 3.3V EDO/SDRM Unbuffered DIMM**. The mainboard supports **from 8 to 256 Mbytes** with no other restrictions on memory configurations. You can install DRAM in any combination without having to rely on a memory configuration table. Memory configuration is thus “**Table-Free**” in any bank.

Multi I/O Port Addresses

Default settings for multi-I/O port addresses are shown in the table below.

Port	I/O Address	IRQ	Status
LPT1*	378H	7	ECP + EPP
COM1	3F8H	4	
COM2	2F8H	3	

* If default I/O port addresses conflict with other I/O cards (e.g. sound cards or I/O cards), you must adjust one of the I/O addresses to avoid address conflict. (You can adjust these I/O addresses from the BIOS.)

Note: Some sound cards have a default IRQ setting for IRQ7, which may conflict with printing functions. If this occurs do not use sound card functions at the same time you print.

Connectors

Attach the mainboard to case devices, or an external battery, via connectors on the mainboard. Refer to Figure 1-1 for connector locations and connector pin positions.

P2 – ATX Power Supply Connectors

The motherboard provides an ATX power supply connector. It is a twenty-pin male header connector. Plug the connector from the power directly onto the board connector while making sure the pin1 is in its position.

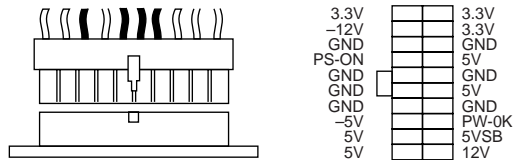

PS/2 Keyboard Connector

A six-pin female PS/2 keyboard connector is located at the rear of the board. Plug the keyboard jack into this connector.

PS/2 Mouse Connector

A six-pin female PS/2 mouse connector is located at the rear of the board. Plug the mouse jack into this connector.

IR – IR Connector

A five-pin wafer connector is for connecting to the IR device. Use the device that has the IrDA or ASKIR specification and choose IrDA/ASKIR from the BIOS setup.

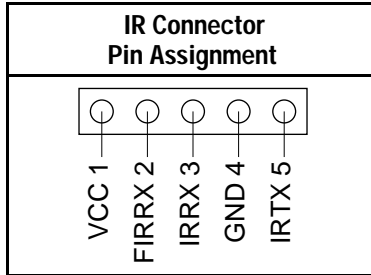

Keylock & Power LED Connector

This connector is for a lock that may be installed on the system case for enabling or disabling the keyboard. This connector also attaches to the case's Power LED. (Pin 1, 3 for power LED, pin 4, 5 for keylock.)

SPK – Speaker Connector

Attach the system speaker to connector SPK.

RST – Hardware Reset Control

Attach the Reset switch to RST. Closing the Reset switch restarts the system.

IDE1/IDE2 – On-board Primary/Secondary IDE HDD Connectors

Attach on-board hard disk drives to these connectors.

COM1/COM2 Connectors

Connect COM1/COM2 devices to these connectors.

IDE LED – IDE HDD LED Connectors

Attach on-board IDE device LEDs to this connector. The LED lights when an IDE device is active.

FDC Connector

Attach floppy cable to this connector.

PRT – Parallel Port Connector

Attach parallel port cable to this connector.

USB1/USB2 – Universal Serial Bus Connector



Attach USB cable to these connectors for external USB device.

PWRBT – ATX Power Supply On/Off Switch Connector (Momentary Type)

Attach a two-pin switch to this connector for turning the ATX power supply on/off.

JP44 – Wake-On-LAN (WOL) Header

Attach a 3-pin connector from the LAN card which supports the Wake-On-LAN (WOL) function. This function lets users wake up the connected computer through the LAN card. (The cable should be included with the LAN card.)

JP44 Pin Assignment		
1		5V Standby
2		GND
3		SENSOR

CPU, CHA: Cooling Fan Connectors

These 3-pins connectors provide 12V power for the CPU and chassis cooling fans which match the pin assignment of these connectors. If you enable the Suspend Mode function in BIOS setup, these fans will stop when the system is into the suspend mode.

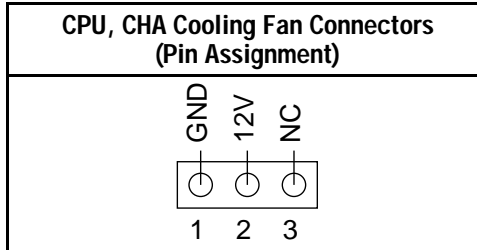

Note: Make sure the pin assignment of our CPU Cooling Fan is matched with this connector before connecting it, otherwise, you may damage either the mainboard or the cooling fan.





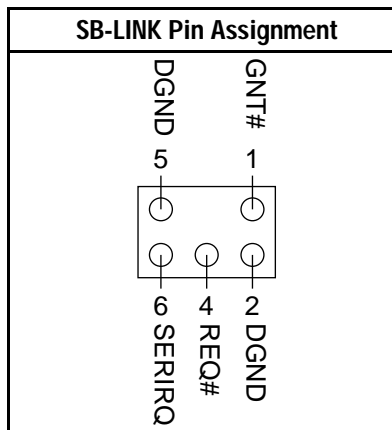













SB-LINK – PCI Audio Card Connector

This 6-pin connector is used for plugging the PCI Audio card's PCI request/grant sideband signals connector into. Through this connector requests for legacy DMA channel support as needed by some soundcards are forwarded to the PCI Bus. Your soundcard package should include a cable for this feature if it requires it (pin3 is left empty to make sure that you can insert the connector only in one way.)



JP10: PS/2 Keyboard WakeUp

JP10 allows the user to enable the keyboard/mouse wake up function. If JP10 is set to Enabled, the BIOS setting determines the exact response of the mainboard to a wake up event. (See the “Integrated Peripherals” section.)

JP10: PS/2 Keyboard Wake up							
Wake Up Enabled	<table><tr><td>1</td><td>2</td><td>3</td></tr><tr><td></td><td></td><td></td></tr></table>	1	2	3			
1	2	3					
							
Wake Up Disabled (disabled)	<table><tr><td>1</td><td>2</td><td>3</td></tr><tr><td></td><td></td><td></td></tr></table>	1	2	3			
1	2	3					
							

Slot 1 Installation Guide

This mainboard provides a non-boxed Pentium II CPU retention set to secure the CPU on this board. Follow the steps below to secure this type of CPU on to your motherboard.

Step 1:

Find the ATX PW and the Slot 1 on the board and set the board in the direction as follows before doing any installation.

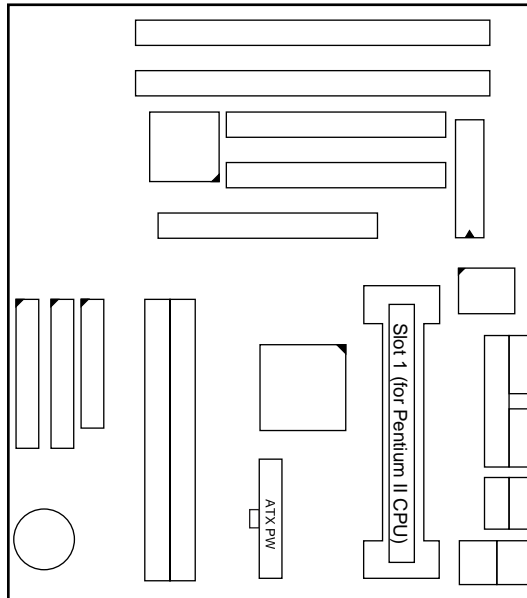

Install the 2 pairs of screws, as shown in the following figure, from the bottom of the motherboard upward onto the mainboard.

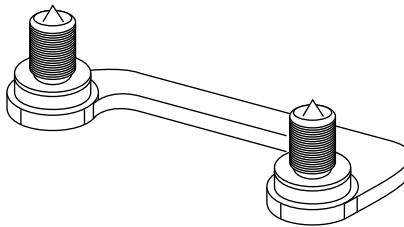

Step 2:

Insert the supporting base, which is shown below, into the two holes directly to the left of the 2 sets of screws that have just been inserted on to the board.

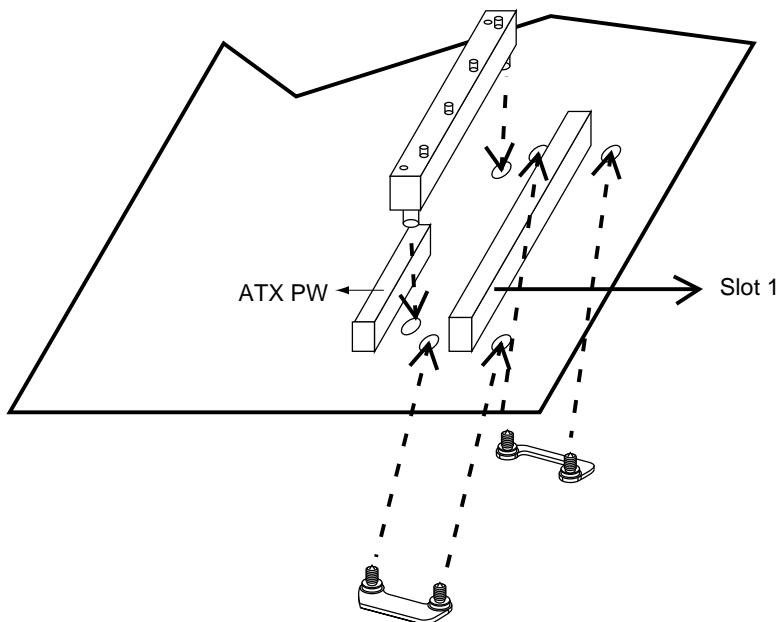

Step 3:

Insert the 2 latches into the two holes of the supporting base to secure the CPU.

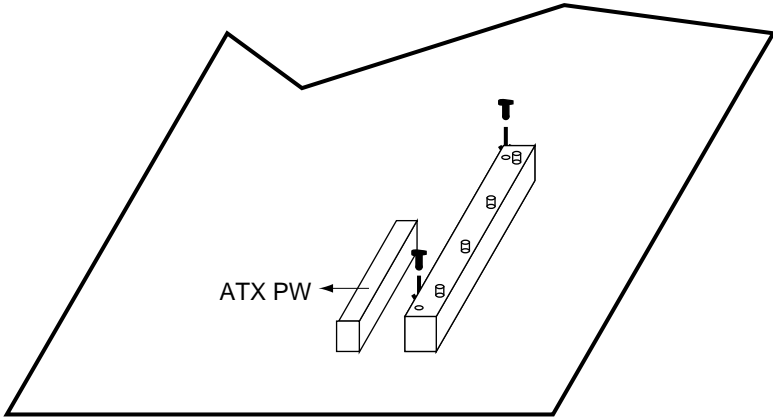

Step 4:

Set the retention clip right on the top of the 2 sets of screws which are along the sides of Slot1 and then tighten the 4 screws on the retention clip.

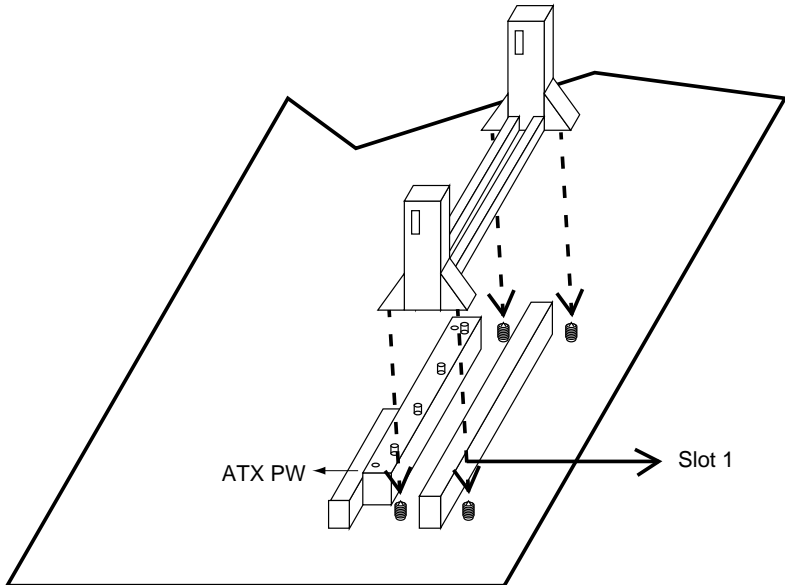

Step 5:

Insert the CPU into the retention clip and notice that the heat sink is on the left hand side of the board. Lock the two latches on the sides of the CPU to secure the CPU.

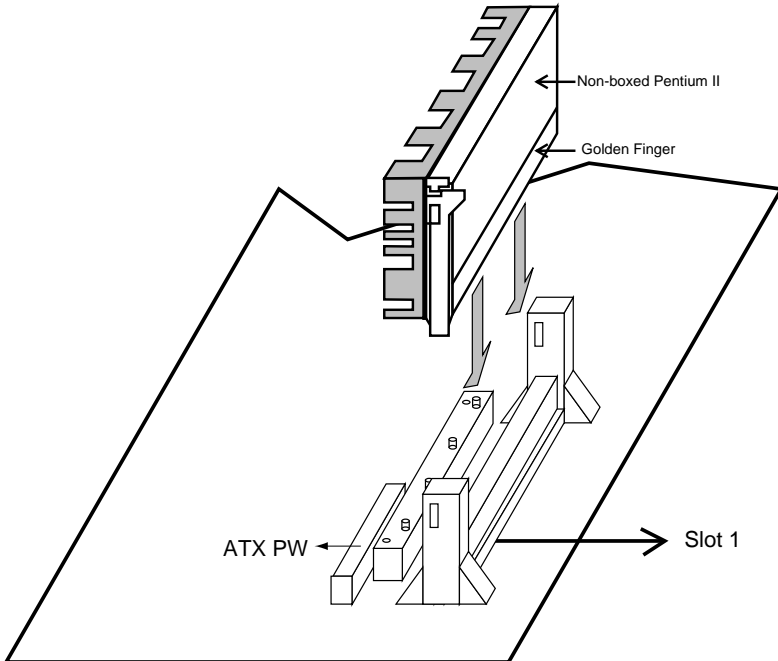

Step 6:

Now insert the clip portion of the CPU supporter, which is shown below, so that the heat sink can sit on the top of the whole CPU supporter. Only Intel specification compliant heatsinks can be fixed this way.



Top View of CPU Support Clip

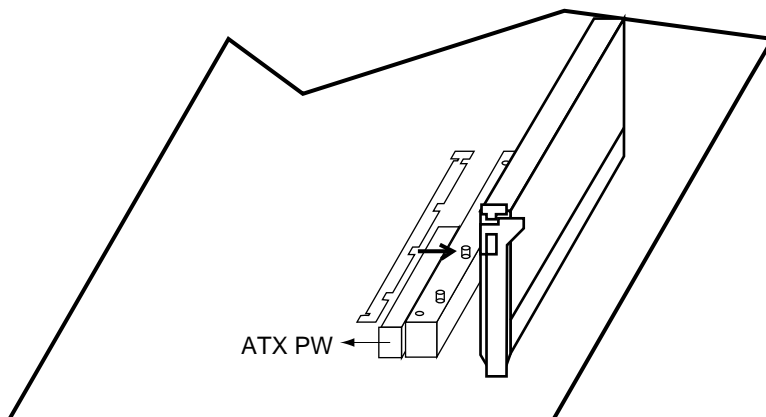

3 BIOS Setup

The mainboard's BIOS setup program is the ROM PCI/ISA BIOS from Award Software Inc. Enter the Award BIOS program's Main Menu as follows:

1. Turn on or reboot the system. After a series of diagnostic checks, you are asked to press DEL to enter Setup.
2. Press the key to enter the Award BIOS program and the main screen appears:

ROM PCI/ISA BIOS
CMOS SETUP UTILITY
AWARD SOFTWARE, INC.

STANDARD CMOS SETUP	INTEGRATED PERIPHERALS
BIOS FEATURES SETUP	SUPERVISOR PASSWORD
CHIPSET FEATURES SETUP	USER PASSWORD
POWER MANAGEMENT SETUP	IDE HDD AUTO DETECTION
PNP/PCI CONFIGURATION	SAVE & EXIT SETUP
LOAD SETUP DEFAULTS	EXIT WITHOUT SAVING
LOAD BIOS DEFAULTS	
Esc : Quit	↑ ↓ → ← : Select Item
F10 : Save & Exit Setup	(Shift) F2 : Change Color
Time, Date, Hard Disk Type...	

3. Choose an option and press <Enter>. Modify the system parameters to reflect the options installed in the system. (See the following sections.)
4. Press <ESC> at anytime to return to the Main Menu.
5. In the Main Menu, choose "SAVE AND EXIT SETUP" to save your changes and reboot the system. Choosing "EXIT WITHOUT SAVING" ignores your changes and exits the program.

The Main Menu options of the Award BIOS are described in the sections that follow.

Standard CMOS Setup

Run the Standard CMOS Setup as follows.

1. Choose "STANDARD CMOS SETUP" from the Main Menu. A screen appears.

ROM PCI/ISA BIOS
STANDARD CMOS SETUP
AWARD SOFTWARE, INC.

Date (mm:dd:yy) : Fri, Dec 5 1997									
Time (hh:mm:ss) : 7 : 30 : 33									
HARD DISKS	TYPE	SIZE	CYLS	HEAD	PRECOMP	LANDZ	SECTOR	MODE	
Primary Master	: AUTO	0	0	0	0	0	0	AUTO	
Primary Slave	: NONE	0	0	0	0	0	0	----	
Secondary Master	: NONE	0	0	0	0	0	0	----	
Secondary Slave	: NONE	0	0	0	0	0	0	----	
Drive A : 1.44M, 3.5 in.					Base Memory: 640K				
Drive B : None					Extended Memory: 3328K				
Floppy 3 Mode Support : Disabled					Other Memory: 128K				
Video : EGA/VGA					Total Memory: 4096K				
Halt On : All Errors									
Esc : Quit		↑ ↓ → ← : Select Item			PU/PD/+/- : Modify				
F11 : Help		(Shift) F2 : Change Color			F3 : Toggle Calendar				

2. Use arrow keys to move between items and select values. Modify selected fields using PgUp/PgDn/+/- keys. Some fields let you enter values directly.

Date (mm/dd/yy) Type the current date.

Time (hh:mm:ss) Type the current time.

Primary (Secondary) Master & Slave Choose Auto (primary master default) or from the standard hard disk types 1 to 45 by user. If a hard disk is not installed choose "NONE."

Drive A & B Choose 360KB , 5 1/4 in.,
1.2MB , 5 1/4 in.,
720KB , 3 1/2 in.,
1.44M , 3 1/2 in.(default),
2.88 MB, 3 1/2 in. or
NONE

Video	Choose MONO, EGA/VGA (default), CGA40, CGA80
Floppy 3 Mode Support	Choose Disabled (default) or Enabled. When enables this function, the system will support 720KB/1.25MB/1.44MB 3 different modes floppy diskette. <i>Note: This function is for a special disk drive which happens to be popular in Japan.</i>
Halt On	Choose halt mode when BIOS detects system errors: All Errors (default) All, But Diskette No Errors All, But Keyboard All, But Disk/Key

- When you finish, press the <ESC> key to return to the Main Menu.

BIOS Features Setup

Run the BIOS Features Setup as follows.

1. Choose “BIOS FEATURES SETUP” from the Main Menu and a screen with a list of items appears. (**The screen below shows the BIOS default settings.**)

ROM PCI/ISA BIOS BIOS FEATURES SETUP AWARD SOFTWARE, INC.			
Virus Warning	: Disabled	Video BIOS Shadow	: Enabled
CPU Internal Cache	: Enabled	C8000-CBFFF Shadow	: Disabled
External Cache	: Enabled	CC000-CFFFF Shadow	: Disabled
Quick Power on Self Test	: Enabled	D0000-D3FFF Shadow	: Disabled
Boot Sequence	: A,C,SCSI	D4000-D7FFF Shadow	: Disabled
Swap Floppy Drive	: Disabled	D8000-DBFFF Shadow	: Disabled
Boot Up NumLock Status	: On	DC000-DFFFF Shadow	: Disabled
Gate A20 Option	: Fast		
Typematic Rate Setting	: Disabled		
Typematic Rate (Chars/Sec)	: 6		
Typematic Delay (Msec)	: 250		
Security Option	: Setup	ESC : Quit	↑ ↓ → ← : Select Item
PCI/VGA Palette Snoop	: Disabled	F1 : Help	PU/PD/+/- : Modify
Assign IRQ for VGA	: Enabled	F5 : Old Values (Shift)F2 : Color	
OS Select for DRAM >64MB	: Non-OS2	F6 : Load BIOS Defaults	
Report no FDD for WIN95	: Yes	F7 : Load Setup Defaults	

2. Use the arrow keys to move between items and to select values. Modify the selected fields using the PgUp/PgDn/+/- keys. <F> keys are explained below:

<F1>: “Help” gives options available for each item.

Shift <F2>: Change color.

<F5>: Get the old values. These values are the values with which the user started the current session.

<F6>: Load all options with the BIOS Setup default values.

<F7>: Load all options with the Power-On default values.

A short description of screen items follows:

Virus Warning Enable this option will allow BIOS to protect the boot sectors and partition tables of your hard disk. Any attempt to write to them will cause the system to halt and display a warning message.

CPU Internal Cache This option enables/disables the CPU’s internal cache. (The Default setting is Enabled.)

External Cache This option enables/disables the external cache memory. (The Default setting is Enabled.)

Quick Power On Self Test	Enabled provides a fast POST at boot-up .
Boot Sequence	Choose the boot device sequence as your need. For example, "A, C, SCSI" means that BIOS will look for an operating system first from drive A, drive C, then SCSI device. Options of this function are: A, C, SCSI; C,A, SCSI; C, CDROM, A; CDROM, C, A; D, A, SCSI; E, A, SCSI; F, A, SCSI; SCSI, A, C; SCSI, C, A; C only; LS/ZIP, C.
Swap Floppy Drive	Enabled changes the sequence of the A: and B: drives. (The Default setting is Disabled.)
Boot Up Num Lock Status	Choose On or Off. On puts numeric keypad in Num Lock mode at boot-up. Off puts this keypad in arrow key mode at boot-up.
Gate A20 Option	Choose Fast (default) or Normal. Fast allows RAM accesses above 1MB using the fast gate A20 line.
Typematic Rate Setting	Enable this option to adjust the keystroke repeat rate.
Typematic Rate (Chars/Sec)	Choose the rate a character keeps repeating.
Typematic Delay (Msec)	Choose how long after you press a key that a character begins repeating.

- Security Option** Choose Setup or System. Use this feature to prevent unauthorized system boot-up or use of BIOS Setup.
“System” – Each time the system is booted the password prompt appears.
“Setup”– If a password is set, the password prompt only appears if you attempt to enter the Setup program.
- PCI/VGA Palette Snoop** Enabled: The color of the monitor may be incorrect if uses with MPEG card. Enable this option to make the monitor normal.
Disabled: Default setting.
- Assign IRQ For VGA** Set this item to **Enabled** if your video card requires an IRQ. Default is **Disabled**.
- Report no FDD for WIN95** This item has the following function: Windows will release INT line6 (normally used by the Floppy Disk Drive) if you disable your onboard FDD and set this item to ‘Yes’ (default). If you set it to ‘No’, windows will reserve INT 6 for your FDD, whether it is disabled or not.
- OS Select for DRAM >64MB** OS2: Choosing this when you are using OS/2 operation system.
Non-OS/2: Choosing this when you are using no-OS/2 operation system.
- Video or Adapter BIOS Shadow** BIOS shadow copies BIOS code from slower ROM to faster RAM. BIOS can then execute from RAM. These 16K segments can be shadowed from ROM to RAM. BIOS is shadowed in a 16K segment if it is enabled and it has BIOS present.

3. After you have finished with the BIOS Features Setup program, press the <ESC> key and follow the screen instructions to save or disregard your settings.

Chipset Features Setup

The Chipset Features Setup option changes the values of the chipset registers. These registers control system options in the computer.

Note: Change these settings only if you are familiar with the Chipset.

Run the Chipset Features Setup as follows.

1. Choose “CHIPSET FEATURES SETUP” from the Main Menu and the following screen appears. (The screen below shows default settings.)

ROM PCI/ISA BIOS CHIPSET FEATURES SETUP AWARD SOFTWARE, INC.	
Auto Configuration : Enabled	CPU Speed : 233MHz (66x3.5)
DRAM Speed Selection : 60 ns	
MA Wait State : Slow	Spread Spectrum : Disabled
EDO RAS# To CAS# Delay : 3	
EDO RAS# Precharge Time : 3	
EDO DRAM Read Burst : x3/3/3	
EDO DRAM Write Bursts : x2/2/2	
DRAM Data Integrity Mode : Non-ECC	
CPU-TO-PCI IDE Posting : Enabled	
System BIOS Cacheable : Disabled	
Video BIOS Cacheable : Disabled	
Video RAM Cacheable : Disabled	
8 Bit I/O Recovery Time : 1	
16 Bit I/O Recovery Time : 1	
Memory Hole At 15M-16M : Disabled	
Delay Transaction : Disabled	ESC : Quit ↑ ↓ → ← : Select Item
AGP Aperture Size (MB) : 64	F1 : Help PU/PD/+/- : Modify
SDRAM RAS-to-CAS Delay : Fast	F5 : Old Values (Shift)F2 : Color
SDRAM RAS Precharge Time : Fast	F6 : Load BIOS Defaults
SDRAM CAS Latency Time : 3	F7 : Load Setup Defaults

2. Use the arrow keys to move between items and select values. Modify selected fields using the PgUp/PgDn/+/- keys.

A short description of screen items follows:

Auto Configuration Enable this option (strongly recommended) and the system automatically sets all options on the left side of the screen (except cache update mode & BIOS cacheable).
If this option is Enabled you must boot from Turbo mode.

MA Wait State Use the default setting.

EDO RAS# to CAS# Delay Use the default setting.

EDO RAS# Precharge Time	Use the default setting.
EDO DRAM Read Burst	Use the default setting.
DRAM Write Burst	Use the default setting.
DRAM Data Integrity Mode	Choose Non-ECC (default) or ECC according to the DRAM type you have.
CPU-TO-PCI IDE Posting	Use the default setting.
System BIOS Cacheable	Disabled: The ROM area F0000H-FFFFFH is not cached. Enabled: The ROM area F0000H-FFFFFH is cacheable if cache controller is enabled.
Video BIOS Cacheable	Disabled: The video BIOS C0000H-C7FFFH is not cached. Enabled: The video BIOS C0000H-C7FFFH is cacheable if cache controller is enabled.
8Bit I/O Recovery Time	Use the default setting.
16Bit I/O Recovery Time	Use the default setting.
Memory Hole At 15M-16M	Choose Enabled or Disabled (default). Some interface cards will map their ROM address to this area. If this occurs, you should select Enabled, otherwise use Disabled.
Delayed Transaction	Use the default setting.
AGP Aperture Size	AGP could use the DRAM as its video RAM. Choose the DRAM size that you want it to be used as video RAM. The range is from 4MB to 256MB.

SDRAM RAS-to-CAS Delay	Use the default setting.
SDRAM RAS Precharge Time	Use the default setting.
SDRAM CAS Latency Time	Use the default setting.
CPU Speed	<p>Select the frequency of your Pentium II CPU from the following: <i>133, 233, 266, 300, 333 MHz</i>, or <i>Manual</i>.</p> <p>133MHz: default setting which allows the board to boot up at any time if a wrong CPU frequency setting crashes the system. Press <Insert> during boot-up to load the BIOS default values.</p> <p>Manual: User can select the frequency and multiplier values if so desired. SOYO does not guarantee proper functioning of the system if the user selects “Manual” setting, however, since some combinations fall outside of the INTEL specifications. Refer to the table on the next page for CPU frequency settings.</p>
CPU Ratio	If you choose “Manual” in the CPU Speed item above, then you can choose the multiplier here. The multiplier can be chosen from a range of 2.0 to 5.5.
CPU Host Clock Select	If you choose “Manual” in the CPU Speed item above, then you can set your CPU’s Host Clock Frequency here. The choices for 66MHz Host Clock CPUs are: 50, 60, 66, 68, and 75MHz.
Spread Spectrum	Enabled it when you want to run the FCC or DOC testing.

CPU Frequency:

		Bus Frequency				
		50MHz	60MHz	66MHz	68MHz	75MHz
CPU Ratio	2.0	100MHz	120MHz	133MHz	137MHz	150MHz
	2.5	125MHz	150MHz	166MHz	171MHz	188MHz
	3.0	150MHz	180MHz	200MHz	205MHz	225MHz
	3.5	175MHz	210MHz	233MHz (default)	239MHz	263MHz
	4.0	200MHz	240MHz	266MHz	274MHz	300MHz
	4.5	225MHz	270MHz	300MHz	308MHz	338MHz
	5.0	250MHz	300MHz	333MHz	342MHz	375MHz

Notes: If you use Bus Frequencies of 75MHz, make sure that your PCI cards can cope with the higher PCI clock.

3. After you have finished with the Chipset Features Setup, press the <ESC> key and follow the screen instructions to save or disregard your settings.

Power Management Setup

The Power Management Setup option sets the system's power saving functions.

Run the Power Management Setup as follows.

1. Choose "POWER MANAGEMENT SETUP" from the Main Menu and a screen with a list of items appears.

ROM PCI/ISA BIOS CMOS SETUP UTILITY POWER MANAGEMENT SETUP	
Power Management : Disabled	IRQ 8 Break Suspend : Disabled
PM Control by APM : Yes	** Relead Global Timer Events **
Video Off Method : V/H SYNC+Blank	IRQ [3-7, 9-15], NMI : Enabled
Video Off After : Standby	Primary IDE 0 : Disabled
Modem Use IRQ : 3	Primary IDE 1 : Disabled
Doze Mode : Disabled	Secondary IDE 0 : Disabled
Standby Mode : Disabled	Secondary IDE 1 : Disabled
Suspend Mode : Disabled	Floppy Disk : Disabled
HDD Power Down : Disabled	Serial Port : Enabled
VGA Active Monitor : Disabled	Parallel Port : Disabled
Soft-Off by PWR-BTN : Instant-Off	
CPU Fan Off In Suspend: Enabled	ESC : Quit ↑↓ → ←: Select Item
Resume by Ring : Disabled	F1 : Help PU/PD/+/- : Modify
Resume by Alarm : Disabled	F5 : Old Values (Shift)F2 : Color
	F6 : Load BIOS Defaults
	F7 : Load Setup Defaults

2. Use the arrow keys to move between items and to select values. Modify the selected fields using the PgUp/PgDn/+/- keys.

A short description of selected screen items follows:

Power Management Options are as follows:

User Define – Let's you define the HDD and system power down times (default).

Disable – Disables the Green PC Features.

Min Saving Doze timer = 1 Hour
Standby timer = 1 Hour
Suspend timer = 1 Hour
HDD Power Down = 15 Min

Max Saving Doze timer = 1 Min
Standby timer = 1 Min
Suspend timer = 1 Min
HDD Power Down = 1 Min

PM Control by APM	Choose Yes (default) or No . APM stands for Advanced Power Management. To use APM, you must run “power.exe” under DOS v6.0 or later version.
Video Off Method	Choose V/H Sync+Blank (default), Blank screen , or DPMS for the selected PM mode.
Video Off After	Choose Standby (default), Suspend , Doze , or N/A mode .
Modem Use IRQ	Choose Modem IRQ Setting.
Doze Mode	When the set time has elapsed, the BIOS sends a command to the system to enter doze mode (system clock drops to 33MHz). Time is adjustable from 1 Min to 1 Hour.
Standby Mode	The default is Disabled. Time is adjustable from 1 Min to 1 Hour.
Suspend Mode	The default is Disabled. Only an SL-Enhanced (or SMI) CPU can enter this mode. Time is adjustable from 1 Min to 1 Hour. Under Suspend mode, the CPU stops completely (no instructions are executed.)
HDD Power Down	When the set time has elapsed, the BIOS sends a command to the HDD to power down, which turns off the motor. Time is adjustable from 1 to 15 minutes. The default setting is Disabled. Some older model HDDs may not support this advanced function.
Soft-Off by PWR-BTTN	Choose Instant-off (default) or Delay 4 Sec . Delay 4 Sec turns off the system power 4 seconds after pushing the power button
VGA Active Monitor	Choose Enabled (default) or Disabled. Enabled – enables the power management timers when a “no activity” event is detected.

CPU Fan Off In Suspend	Choose Enabled to stop the CPU fan when the system runs into the suspend mode (refer to Power Management Setup.)
Resume by Ring	Choose Enabled or Disabled (default). This function only works when the computer is powered on. Enabled – The system will resume active when modem is ringing. Disabled – The system will not resume when modem is ringing.
Resume by Alarm	Choose Enabled or Disabled (default). Enabled – Set alarm to wake up the system either by the date (1-31) or time (hh:mm:ss), and if the date is set to 0, it means that the system will wake up by the alarm everyday. Disabled – The system ignores the alarm.
IRQ8 Break Suspend	Choose Enabled or Disabled (default). Alarm function will be activated when this function is enabled.
IRQ[3-7,9-15], NMI	Choose Enabled (default) or Disabled . The BIOS monitors these items for activity. If activity occurs from the Enabled item the system wakes up.
Primary/Secondary IDE 0	Choose Enabled or Disabled (default). Enabled – Enables the power management timers when “no activity” event is detected.
Primary/Secondary IDE 1	Choose Enabled or Disabled (default). Enabled – Enables the power management timers when “no activity” event is detected.
Floppy Disk/ Serial Port/ Parallel Port	Choose Enabled or Disabled . Enabled – enables the power management timers when “no activity” event is detected.

- After you have finished with the Power Management Setup, press the <ESC> key to return to the Main Menu.

PNP/PCI Configuration Setup

This option sets the mainboard's PCI Slots. Run this option as follows:

1. Choose "PNP/PCI CONFIGURATION SETUP" from the Main Menu and the following screen appears. (The screen below shows default settings.)

ROM PCI/ISA BIOS PNP/PCI CONFIGURATION AWARD SOFTWARE, INC.	
Resources Controlled By : Manual Reset Configuration Data : Disabled IRQ-3 assigned to : PCI/ISA PnP* IRQ-4 assigned to : PCI/ISA PnP* IRQ-5 assigned to : PCI/ISA PnP* IRQ-7 assigned to : PCI/ISA PnP* IRQ-9 assigned to : PCI/ISA PnP* IRQ-10 assigned to : PCI/ISA PnP* IRQ-11 assigned to : PCI/ISA PnP* IRQ-12 assigned to : PCI/ISA PnP* IRQ-14 assigned to : PCI/ISA PnP* IRQ-15 assigned to : PCI/ISA PnP* DMA-0 assigned to : PCI/ISA PnP* DMA-1 assigned to : PCI/ISA PnP* DMA-3 assigned to : PCI/ISA PnP* DMA-5 assigned to : PCI/ISA PnP* DMA-6 assigned to : PCI/ISA PnP* DMA-7 assigned to : PCI/ISA PnP*	PCI IDE IRQ Map To : PCI-AUTO Primary IDE INT# : A Secondary IDE INT# : B Used MEM Base Addr : N/A Assign IRQ for USB : Enabled ESC : Quit ↑↓→←: Select Item F1 : Help PU/PD/+/- : Modify F5 : Old Values (Shift)F2 : Color F6 : Load BIOS Defaults F7 : Load Setup Defaults

*: These items will disappear when Resource Controlled. is Auto.

2. Use the arrow keys to move between items and select values. Modify selected fields using the PgUp/PgDn/+/- keys.

A short description of screen items follows:

Resources Controlled By	Manual – BIOS doesn't manage PCI/ISA PnP card (i.e., IRQ) automatically.
	Auto – BIOS auto manage PCI and ISA PnP card (recommended).
Reset Configuration Data	Disabled –Retain PnP configuration data in BIOS.
	Enabled –Reset PnP configuration data in BIOS.

IRQX and DMAX assigned to	Choose PCI/ISA PnP or Legacy ISA . If the first item is set to Manual , you could choose IRQX and DMAX assigned to PCI/ISA PnP card or ISA card.
PCI IDE IRQ Map To	Select PCI-AUTO , ISA , or assign a PCI SLOT number (depending on which slot the PCI IDE is inserted). The default setting is PCI-AUTO. If PCI-AUTO does not work, then assign an individual PCI SLOT number.
Primary IDE INT#	Choose INTA#, INTB#, INTC#, or INTD#. The default setting is INTA#.
Secondary IDE INT#	Choose INTA#, INTB#, INTC#, or INTD#. The default setting is INTB#.
Used MEM Base Addr	Choose C800, CC00, D000, D400, D800, or DC00 for setting the I/O address of your add-on card. You should ask your add-on card dealer for the exactly I/O address. Use this function only when problems occur while using the add-on card.
Assign IRQ for USB	Set this item to Enabled (default) if you use an USB device.

3. After you have finished with the PCI Slot Configuration, press the <ESC> key and follow the screen instructions to save or disregard your settings.

Load Setup Defaults

This item loads the system values you have previously saved. Choose this item and the following message appears:

“Load SETUP Defaults (Y/N)? N”

To use the SETUP defaults, change the prompt to “Y” and press <Enter>.

Note: The SETUP Defaults are optimized for the most stabilized performance.

Load BIOS Defaults

Choose this item and the following message appears:

“Load BIOS Defaults (Y/N)?N”

To use the BIOS defaults, change the prompt to “Y” and press <Enter>.

Note: BIOS DEFAULTS values are adjusted for high performance. If you run into any problems after loading BIOS DEFAULTS, please load the SETUP DEFAULTS for the stable performance.

Integrated Peripherals

The Integrated Peripherals option changes the values of the chipset registers. These registers control system options in the computer.

Note: Change these settings only if you are familiar with the Chipset.

Run the Integrated Peripherals as follows.

1. Choose “Integrated Peripherals” from the Main Menu and the following screen appears. (The screen below shows default settings:)

ROM PCI/ISA BIOS INTEGRATED PERIPHERALS AWARD SOFTWARE, INC.	
IDE HDD Block Mode : Enabled	Onboard Serial Port 1 : 3F8/IRQ4
IDE Primary Master PIO : Auto	Onboard Serial Port 2 : 2F8/IRQ3
IDE Primary Slave PIO : Auto	UART Mode Select : Normal
IDE Secondary Master PIO : Auto	
IDE Secondary Slave PIO : Auto	Onboard Parallel Port : 378/IRQ7
IDE Primary Master UDMA : Auto	Parallel Port Mode : SPP
IDE Primary Slave UDMA : Auto	
IDE Secondary Master UDMA : Auto	
IDE Secondary Slave UDMA : Auto	
OnChip Primary PCI IDE : Enabled	
OnChip Secondary PCI IDE : Enabled	
USB Keyboard Support : Disabled	
Power ON Function : BUTTON ONLY	ESC : Quit ↑ ↓ → ← : Select Item
	F1 : Help PU/PD/+/- : Modify
	F5 : Old Values (Shift) F2 : Color
	F6 : Load BIOS Defaults
	F7 : Load Setup Defaults
Onboard FDC Controller : Enabled	

2. Use the arrow keys to move between items and select values. Modify selected fields using the PgUp/PgDn/+/- keys.

A short description of screen items follows:

IDE HDD Block Mode Choose **Enabled** (default) or **Disabled**. Enabled invokes multi-sector transfer instead of one sector per transfer. Not all HDDs support this function.

IDE Primary Master PIO/
IDE Primary Slave PIO/
IDE Secondary Master
PIO/
IDE Secondary Slave PIO Choose **Auto** (default) or **mode 0-4**. Mode 0 is the slowest speed, and HDD mode 4 is the fastest speed. For better performance and stability, we suggest you use the Auto setting to set the HDD control timing.

- IDE Primary Master** Choose **Auto** (default) or **Disabled**.
UDMA/ Auto – Supports Ultra DMA mode.
- IDE Primary Slave**
UDMA/
- IDE Secondary Master**
UDMA/
- IDE Secondary Slave**
UDMA
- On-chip Primary PCI** Enabled – Use the on-board IDE
IDE/ (default)
- On-chip Secondary PCI** Disabled – Turn off the on-board IDE
IDE
- USB Keyboard Support** Choose **Disabled** (default) or **Enabled**.
 You need to use the regular keyboard to get in the BIOS Setup to enable this function before using the USB keyboard.
- POWER On Function** If you enable the PS/2 keyboard wake up function by setting JP10 to 1–2, you can set the appropriate action through this item. Refer to the table below for details:

Setting	Explanation
BUTTON ONLY (default)	This setting disables the wake-up function.
Password	If you choose this option, you will have to set your password in the “KB Power On Password” item below. You will be able to wake up the system by entering the password or by pressing the power button.
Hot Key	If you choose this option, you will have to set the key combination that will wake up the system in the “Hot key Power On” item below.
<i>Note: Please set JP10 to 2–3 if you choose “BUTTON ONLY.”</i>	

KB POWER On Password If you selected password from the item above, you can set your password through this item.

Hot Key Power On	If you select “Hot Key” from the item above, you will have to choose a key combination that will wake up the system here. Choose from Ctrl-F1 to Ctrl-F12.				
Onboard FDC Controller	<p>Enabled – Use the on-board floppy controller (default).</p> <p>Disabled – Turn off the on-board floppy controller.</p>				
Onboard Serial Port 1/ Onboard Serial Port 2	<p>Choose serial port 1 & 2’s I/O address. Do not set port 1 & 2 to the same value except for Disabled. Choose Auto for automatic setting for the I/O address and IRQ.</p> <table border="0" style="margin-left: 20px;"> <tr> <td style="padding-right: 10px;">COM1/3F8H</td> <td style="border-left: 1px solid black; padding-left: 10px;">COM3/3E8H</td> </tr> <tr> <td style="padding-right: 10px;">COM2/2F8H</td> <td style="border-left: 1px solid black; padding-left: 10px;">COM4/2E8H</td> </tr> </table> <p>(default)</p>	COM1/3F8H	COM3/3E8H	COM2/2F8H	COM4/2E8H
COM1/3F8H	COM3/3E8H				
COM2/2F8H	COM4/2E8H				
UART Mode Select	Choose Normal (default), IrDA 1.0, or ASKIR to meet the specification of your Infra Red device.				
RxD, TxD Active	Choose Hi, Hi; Hi, Lo (default); Lo, Hi; or Lo, Lo. Ask your IR provider when you use this function.				
IR Transmission Delay	Choose Enabled or Disabled. Ask your IR provider when you use this function.				
Onboard Parallel Port	Choose the parallel port I/O address: 378H/IRQ7 (default), 3BCH/IRQ7, 278H/IRQ5, or Disabled to disable this port.				
Parallel Port Mode	Choose ECP+EPP (default), SPP , EPP , or ECP . The mode depends on your external device that connects to this port.				

ECP Mode Use DMA Choose **DMA3** (default) or **DMA 1**.
This setting only works when the Onboard Printer Mode is set at the ECP mode.

EPP Mode Select Choose EPP1.7 or EPP1.9 (default).

3. After you have finished with the Integrated Peripherals, press the <ESC> key and follow the screen instructions to save or disregard your settings.

Supervisor Password

Based on the setting you made in the “Security Option” of the “BIOS FEATURES SETUP”, this Main Menu item lets you configure the system so that a password is required every time the system boots or an attempt is made to enter the Setup program. Change the password as follows:

1. Choose “SUPERVISOR PASSWORD” in the Main Menu and press <Enter>. The following message appears:

“Enter Password:”

2. Enter a password and press <Enter>.
(If you do not wish to use the password function, you can just press <Enter> and a “Password disabled” message appears.)
3. After you enter your password, the following message appears prompting you to confirm the new password:

“Confirm Password:”

4. Re-enter your password and then Press <ESC> to exit to the Main Menu.
5. You have the right to change any changeable settings in the “CMOS SETUP UTILITY.”

Important: If you forget or lose the password, the only way to access the system is to set jumper JP5 to clear the CMOS RAM. All setup information is lost and you must run the BIOS setup program again.

User Password

Based on the setting you made in the “Security Option” of the “BIOS FEATURES SETUP”, this Main Menu item lets you configure the system so that a password is required every time the system boots or an attempt is made to enter the Setup program. Change the password as follows:

1. Choose “USER PASSWORD” in the Main Menu and press <Enter>. The following message appears:

“Enter Password:”

2. Enter a password and press <Enter>. (If you do not wish to use the password function, you can just press <Enter> and a “Password disabled” message appears.)
3. After you enter your password, the following message appears prompting you to confirm the new password:

“Confirm Password:”

4. Re-enter your password and then Press <ESC> to exit to the Main Menu.
5. You are not allowed to change any setting in “CMOS SETUP UTILITY” except change user’s password.

Important: If you forget or lose the password, the only way to access the system is to set jumper JP5 to clear the CMOS RAM. All setup information is lost and you must run the BIOS setup program again.

IDE HDD Auto Detection

This Main Menu item automatically detects the hard disk type and configures the STANDARD CMOS SETUP accordingly.

*Note: This function is only valid for **IDE** hard disks.*

ROM PCI/ISA BIOS
CMOS SETUP UTILITY
AWARD SOFTWARE, INC.

HARD DISKS	TYPE	SIZE	CYLS	HEAD	PRECOMP	LANDZ	SECTOR	MODE
Primary Master	: None	0	0	0	0	0	0	----
Primary Slave	: None	0	0	0	0	0	0	----
Secondary Master	: None	0	0	0	0	0	0	----
Secondary Slave	: None	0	0	0	0	0	0	----

Do you accept this drive C (Y/N)? N

ESC : Skip

6KME Quick Installation Guide

This Quick Installation Guide leaflet summarizes all important information regarding how to setup your board in order to boot up. If you run into any problems or need more information, please refer to the CD that comes with you 6KME board.

Motherboard Layout

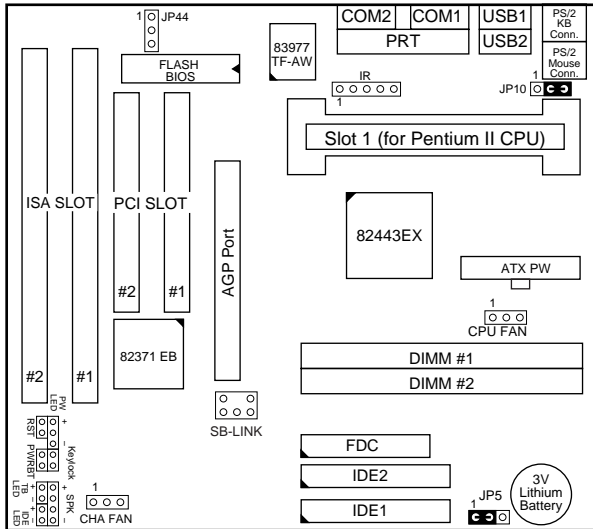

Memory Configurations

	DIMM BANKS	
	DIMM1	DIMM2
RAM Type	EDO/SDRAM	
Size	8/16/32/64/128	

Note: This mainboard requires 3.3V DIMM with an access time of 70ns or less, it supports memory size from 8 to 256MB and you may use any combination of DIMMs in the banks.

Connectors and Jumper Settings

CMOS clear: JP5		ATX Power Supply: P2				CPU, CHA Cooling Fan			
Retain CMOS data (default)	1-2	please insert the ATX power supply plug into this header.				pin	1	2	3
						function	GND	12V	sensor
Clear CMOS data	2-3	wake on LAN jumper: JP44 Please connect the WOL cable from your LAN card to this jumper.				RST Connect the reset button to this jumper.		IDE Led Connect the HDD led to this jumper.	
USB1 and 2 Connect your USB devices to these headers				PRT printer cable header		SPK Connect the cable of speakers to this jumper		Keylock Connect keyboard lock switch to this jumper	
ATX Power Supply On/Off Switch: PWRBT Connect your power switch to this jumper (momentary switch type).									
IrDA (Infrared Devices Connector): IR						TB Led Connect the Turbo led to this jumper		PW Led Connect the power led to this jumper	
pin	1	2	3	4	5				
function	Vcc	FIRRX	IRRX	GND	IRTX				
PCI Audio Card Connector: SB-LINK						.JP10: Keyboard Wake Up			
1	2	3	4	5	6	Wake Up Enabled		1-2	
GNT#1	DGND	Empty	REQ#	DGND	SERIRQ	Wake Up Disabled		2-3	

Default I/O Settings

PORT	I/O Address	IRQ	Functionality
LPT1	378H	7	ECP + EPP
COM1	3F8H	4	—
COM2	2F8H	3	—

Note: If the default I/O settings conflict with those of other I/O cards, such as soundcards you will have to adjust the settings of one of them. The default settings for the onboard I/O can be changed in the BIOS setup. Enter BIOS Setup by pressing <Delete> key during boot-up. The I/O settings can be found under “Integrated Peripherals”.