

# 5ED5/5EDM-(T2)

586 CPU Supported PCI Mainboard  
User Guide & Technical Reference



®

**SOYO™**

---

## About This Guide

This User's Guide is for assisting system manufacturers and end users in setting up and installing the mainboard. Information in this guide has been carefully checked for reliability; however, no guarantee is given as to the correctness of the contents. The information in this document is subject to change without notice.

## Copyright Notice

Copyright 1998, Soyo Computer Inc. All rights reserved. This manual is copyrighted by Soyo Computer Inc. You may not reproduce, transmit, transcribe, store in a retrieval system, or translate into any language, in any form or by any means, electronic, mechanical, magnetic, optical, chemical, manual, or otherwise, any part of this publication without express written permission of Soyo Computer Inc.

## Trademarks

Soyo is a registered trademark of Soyo Computer Inc. All trademarks are the property of their owners.

## Disclaimer

Soyo Computer Inc. makes no representations or warranties regarding the contents of this manual. We reserve the right to revise the manual or make changes in the specifications of the product described with in it at any time without notice and without obligation to notify any person of such revision or change. The information contained in this manual is provided for general use by our customers. Our customers should be aware that the personal computer field is the subject of many patents. Our customers should ensure that they take appropriate action so that their use of our products does not infringe upon any patents. It is the policy of Soyo Computer Inc. to respect the valid patent rights of third parties and not to infringe upon or assist others to infringe upon such rights.

## Restricted Rights Legend

Use, duplication, or disclosure by the Government is subject to restrictions set forth in subparagraph (c)(1)(ii) of the Rights in Technical Data and Computer Software clause at 252.277-7013.

## Product Rights

Product mentioned in this manual are mentioned for identification purpose only. Product names appearing in this manual may or may not be registered trademarks or copyrights of their respective companies. If you need any further information, please come to our home page on internet. The address is "<http://www.soyo.com.tw>".

**Edition : February 1998**  
**Version 2.0F**  
**5ED5/M-T2 SERIAL**

**FC** Tested To Comply  
With FCC Standards  
FOR HOME OR OFFICE USE  
**100%** POST CONSUMER  
RECYCLED PAPER

# Table of Contents

<b>Chapter 1: Introduction .....</b>	<b>1</b>
Key Features .....	1
Unpacking the Mainboard .....	2
Electrostatic Discharge Precautions .....	2
Mainboard Layout w/ Default Settings .....	3
<b>Chapter 2: Hardware Setup .....</b>	<b>5</b>
Jumpers .....	5
JP5: CMOS Clear Jumper .....	5
JP22: CPU Burst Mode Jumper .....	6
JP1: Smart Detect CPU Voltage Auto/Manual Jumper .....	6
JP37: DIMM Voltage Jumper .....	7
CPU Type Configuration .....	8
P54C/P55C Series CPUs Settings .....	8
P54C/P55C Series CPUs Settings (Continued) .....	9
AMD K5/K6 Series CPUs Setting .....	10
Cyrix 6x86/L/MX Series CPUs Setting .....	11
Memory Configuration .....	12
Memory Configuration Table .....	12
RAM Bank Installation Notice .....	12
Cache Configuration .....	13
Cache Size and RAM Locations .....	13
Multi I/O Port Addresses .....	13
Connectors .....	14
Front Panel Connectors .....	14
Back Panel Connectors .....	15
Other Connectors .....	15
<b>Chapter 3: BIOS Setup .....</b>	<b>18</b>
Standard CMOS Setup .....	19
BIOS Features Setup .....	21
Chipset Features Setup .....	24
Power Management Setup .....	26
PNP/PCI Configuration Setup .....	29
Load Setup Defaults .....	31
Load BIOS Defaults .....	31
Integrated Peripherals .....	32
Supervisor Password .....	34
User Password .....	35
IDE HDD Auto Detection .....	36

<b>Quick Instalation Guide.....</b>	<b>38</b>
Motherboard Layout.....	38
CPU Voltage and Frequency Jumper Settings.....	38
Voltage Settings : JP30.....	38
CPU Frequency Settings : SW1.....	38
Memory Configuration.....	38
Additional Jumper Settings.....	39
Setting for Various Processors : SW1 & JP30.....	39
<b>Drivers Installation Guide.....</b>	<b>40</b>
South Bridge/IDE Bus Master Drivers.....	40
Install AGP Card Steps.....	41
<b>BIOS Update.....</b>	<b>42</b>

# 1 Introduction

The ETEQ 82C662X PCI mainboard is a high-performance ATX form-factor system board that supports P54C/P55C family CPUs. This mainboard is fully compatible with industry standards and adds many technical enhancements.

## Key Features

---

- CPU
  - Supports P54C/P55C family CPUs running at 75~233 MHz speeds; Cyrix 6x86/6x86L/6x86MX CPUs running at PR150~PR266 speeds; and AMD K5/K6 CPUs running at P75~PR300 speeds
  - Supports Socket 7 for upgrade
  - Supports P54C/P55C series SMM Mode and CPU Stop Clock
  - Supports **MMX** technology and Smart Detect CPU Voltage function
- L2 Cache Controller
  - On-board **512K/1M** Pipeline Burst SRAMs Cache
- DRAM Controller
  - Supports 2 strips of 72-pin FPM/EDO SIMM (symmetrical/asymmetrical addressing)
  - Supports **3 strips** of 168-pin EDO/SDRM **Unbuffered DIMM**
  - **Comes with three DIMM banks, supports 8/16/32/64/128 MB unbuffered DIMMs**
  - Memory configuration for DIMM is from 8MB to 384 MB; for SIMM is from 8MB to 64MB
- BUS Controller
  - Compliant to PCI specifications v2.1
  - Five 32-bit PCI slots, two ISA slots, and **one AGP slot**
  - **Onboard USB (Universal Serial Bus) port**
- Peripheral Controller
  - System BIOS include NCR 810 SCSI BIOS and Plug&Play func.
  - Onboard PCI Master IDE controller and floppy controller
  - Onboard supports two high speed UARTS (w/i 16550 FIFO), one ECP/EPP/SPP multi-mode parallel port, and one PS/2 mouse port
  - **Onboard FLASH Memory for easy upgrade BIOS**
  - Easy installation of ETEQ E-IDE/ATAPI CD-ROM Bus Master Drivers included
  - Onboard support IR connector

## Unpacking the Mainboard

The mainboard package contains:

- The EQ82C662X Mainboard
- One CD (Including Manuals/Drivers/Utilities)
- One page of One Sheet Manual

*Note: Do not unpack the mainboard until you are ready to install it.*

Follow the precautions below while unpacking the mainboard.

1. Before handling the mainboard, ground yourself by grasping an unpainted portion of the system's metal chassis.
2. Remove the mainboard from its anti-static packaging and place it on a grounded surface, component side up.
3. Check the mainboard for damage. If any chip appears loose, press carefully to seat it firmly in its socket.

Do not apply power if the mainboard appears damaged. If there is damage to the board contact your dealer immediately.

## Electrostatic Discharge Precautions

Make sure you ground yourself before handling the mainboard or other system components. Electrostatic discharge can easily damage the components. Note that you must take special precaution when handling the mainboard in dry or air-conditioned environments.

Take these precautions to protect your equipment from electrostatic discharge:

- Do not remove the anti-static packaging until you are ready to install the mainboard and other system components.
- Ground yourself before removing any system component from its protective anti-static packaging. To ground yourself grasp the expansion slot covers or other unpainted portions of the computer chassis.
- Frequently ground yourself while working, or use a grounding strap.
- Handle the mainboard by the edges and avoid touching its components.

## Mainboard Layout w/ Default Settings

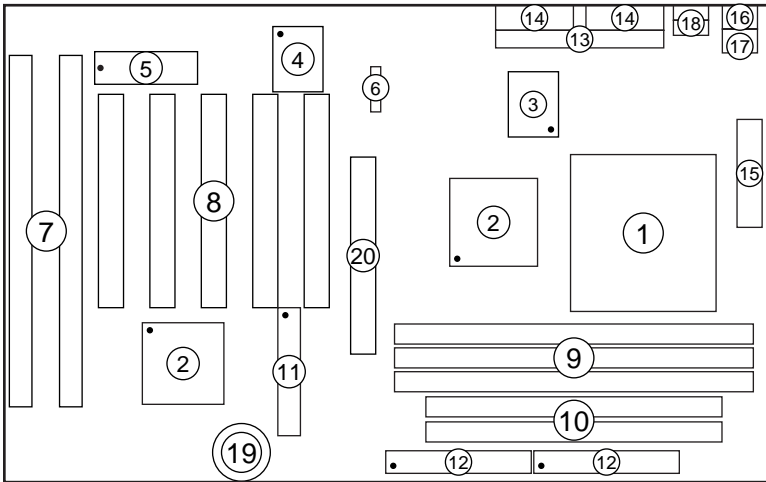

*Figure 1-1. Mainboard Layout*

- |                            |                             |
|----------------------------|-----------------------------|
| 1. ZIF socket 7            | 11. Floppy Connector        |
| 2. EQ82C662X Chipset       | 12. IDE1/IDE2 Connector     |
| 3. Pipelined Burst SRAM    | 13. Parallel Port Connector |
| 4. Super I/O Chip          | 14. COM1/COM2 Connector     |
| 5. PnP FLASH BIOS          | 15. ATX Power Connector     |
| 6. 1 TAG SRAM (or 2 SRAMs) | 16. PS/2 KB Connector       |
| 7. ISA Slots               | 17. PS/2 Mouse Connector    |
| 8. PCI Slots               | 18. USB Connectors          |
| 9. Unbuffered DIMM Bank    | 19. 3 Volt. Lithium Battery |
| 10. SIMM Bank              | 20. AGP Port                |

Default settings are as follows: Pentium 133MHz (P54C/P55C) CPU, 512K Pipelined Burst cache, On - board PCI E - IDE Enabled, 2 high speed UARTS Enabled (w / 16550 FIFO), 1 EPP/ECP port (ECP + EPP mode), 5V DRAM/3.3V DIMM, and ATX power supply.

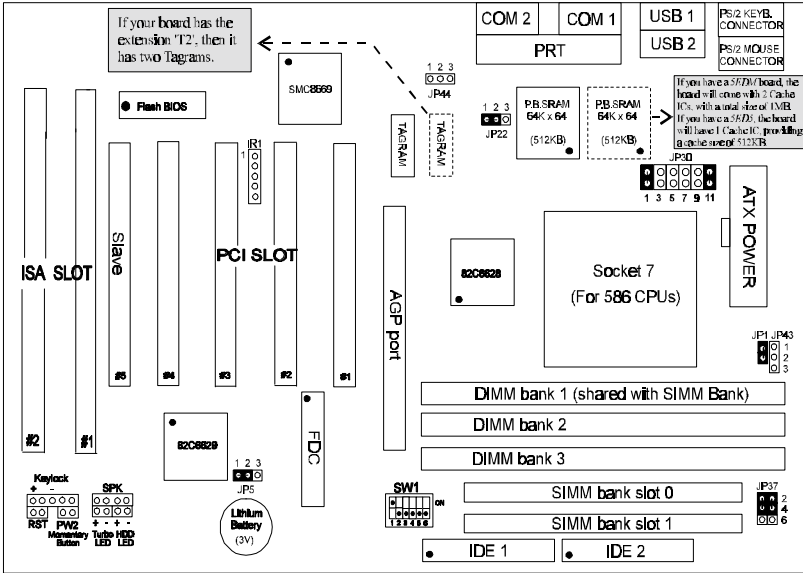

Figure 1-2. Mainboard Default Setting

**Important:** Make sure the system is well ventilated to prevent overheating and ensure system stability.



# 2 Hardware Setup

This chapter is designed for Normal edition mainboard use only and it explains how to configure the mainboard's hardware. After you install the mainboard, you can set jumpers, install memory on the mainboard, and make case connections. Refer to this chapter whenever you upgrade or reconfigure your system.

---

**CAUTION:** *Turn off power to the mainboard, system chassis, and peripheral devices before performing any work on the mainboard or system.*

---











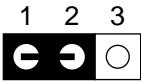
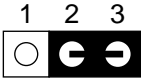

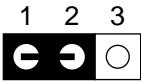
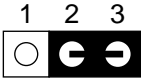

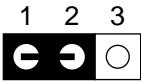
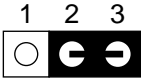
## Jumpers

This mainboard uses different colors of jumper caps to identify different functions of the jumpers:

Jumper Cap Color	White	Black	Blue	Red	Green
Function	clear CMOS	CPU burst mode	Smart Detect CPU voltage	DIMM voltage	CPU Voltage



### JP5: CMOS Clear Jumper

Clear the CMOS memory by momentarily shorting pin 2–3; then shorting pin 1–2 to retain new settings.

CMOS Setting	JP5						
Retain CMOS data (default)	<table><tr><td>1</td><td>2</td><td>3</td></tr><tr><td></td><td></td><td></td></tr></table>	1	2	3			
1	2	3					
							
Clear CMOS data	<table><tr><td>1</td><td>2</td><td>3</td></tr><tr><td></td><td></td><td></td></tr></table>	1	2	3			
1	2	3					
							

## JP22: CPU Burst Mode Jumper

Due to different designs, there are two kinds of CPU burst modes: Interleave Burst and Linear Burst. Select the correct mode according to the CPU you are using.

CPU Burst Mode	JP22
Interleave (for P54C/P55C and AMD K5/K6 CPU)	1 2 3 
Linear (for Cyrix 6x86/L/MX CPU)	1 2 3 

When using a Cyrix series of CPUs, follow the below procedures after select the burst mode:

1. Press <Delete> key to enter the BIOS setup menu during the boot-up,
2. Select “Chipset Features Setup”,
3. Set the “Linear Burst” to “Enabled”,
4. Press <Esc> to go back to the main menu and choose “Save & Exit Setup” to reboot your computer.

## JP1: Smart Detect CPU Voltage Auto/Manual Jumper

For P54C/P55C and Cyrix 6x86/L CPUs, this board automatically detects and adjusts the CPU voltage to the proper voltage. JP1 is reserved for a few older non-Intel CPUs which can not be detect correctly. If you run into problems while detecting the voltage of older CPUs, remove the jumper cap to correct it.

**JP37: DIMM Voltage Jumper**

There are two kinds of DIMM voltages in the market—3.3V and 5V—and most of SDRAM DIMMS are 3.3V. Choose the correct voltage according to the DIMM that you are using.

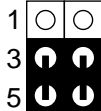
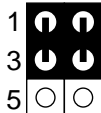
DIMM Voltage	JP37 Setting
5V	
3.3V (Default)	

---

**Caution:** *Do not change this jumper to 5V setting unless you are sure that your DIMMs are 5V. The wrong setting may cause the system malfunction.*

---

## CPU Type Configuration

SW1 and JP30 are the only switches/jumpers that you need to set for your CPU on this mainboard. Make sure that you know the type of CPU that you are installing and refer to the proper settings which are listed below. If you have a higher frequency CPU then the one listed below, see the “Quick Installation Guide” for more SW1 information.

- SW1: Frequency Setting.** Some newer CPUs may not be included in this section, please refer to the Appendix for more information.
- JP30: Voltage Setting.** There are two kinds of CPU voltages currently on the market—Single and Dual. The CPUs which fall under the single voltage category are: P54C, AMD-K5, and Cyrix 6x86. The CPUs which fall under the dual voltage category are: P55C, AMD-K6, and Cyrix 6x86L/MX. This board is designed to detect the CPU voltage automatically for P54C and P55C CPUs due to the Smart Detect CPU Voltage function, and therefore, there is no need to move any jumpers to set the voltage for P54C/P55C CPUs.

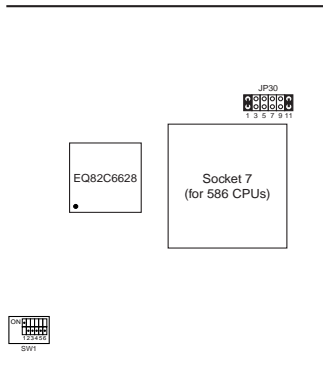













Figure 2–1. Location of JP30 and SW1

### P54C/P55C Series CPUs Settings



CPU	Frequency Setting (SW1)	Voltage Setting (JP30)
P54C–75MHz	External : 50MHz Ratio : 1.5x	Single Voltage 3.52V (default)
P54C–90MHz	External : 60MHz Ratio : 1.5x	
P54C–100MHz	External : 66MHz Ratio : 1.5x	

## P54C/P55C Series CPUs Settings (Continued)

CPU	Frequency Setting (SW1)	Voltage Setting (JP30)
P54C-120MHz	 External : 60MHz Ratio : 2.0x	 Single Voltage 3.52V (default)
P54C-133MHz (default)	 External : 66MHz Ratio : 2.0x	
P54C-150MHz	 External : 60MHz Ratio : 2.5x	
P54C-166MHz	 External : 66MHz Ratio : 2.5x	
P54C-180MHz	 External : 60MHz Ratio : 3.0x	
P54C-200MHz	 External : 66MHz Ratio : 3.0x	
P55C-166MHz (MMX)	 External : 66MHz Ratio : 2.5x	 DualVoltage 2.8V (default)
P55C-180MHz (MMX)	 External : 60MHz Ratio : 3.0x	
P55C-200MHz (MMX)	 External : 66MHz Ratio : 3.0x	
P55C-233MHz (MMX)	 External : 66MHz Ratio : 3.5x	



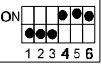
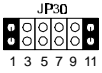
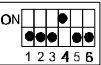
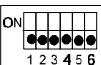
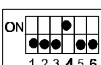
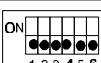
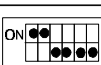
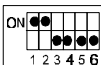
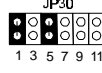
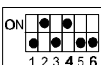
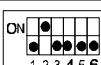
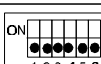
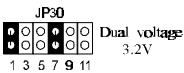
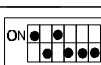

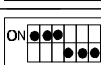



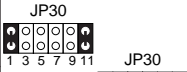

*Note: The voltage setting for 3.52V and 2.8V are the same due to the Smart Detect CPU Voltage technology.*

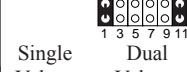
### AMD K5/K6 series CPUs setting

CPU	Frequency setting (SW1)	Voltage setting (JP30)
AMD-K5 PR75	 External : 50MHz Ratio : 1.5x	 Single voltage 3.2V (default)
AMD-K5 PR90	 External : 60MHz Ratio : 1.5x	
AMD-K5 PR100	 External : 66MHz Ratio : 1.5x	
AMD-K5 PR120	 External : 60MHz Ratio : 1.5x	
AMD-K5 PR133	 External : 66MHz Ratio : 1.5x	
AMD-K5 PR166	 External : 66MHz Ratio : 2.5x	
AMD-K6 PR166	 External : 66MHz Ratio : 2.5x	 Dual voltage 2.9V
AMD-K6 PR180	 External : 60MHz Ratio : 3.0x	
AMD-K6 PR200	 External : 66MHz Ratio : 3.0x	
AMD-K6 PR233	 External : 66MHz Ratio : 3.5x	 Dual voltage 3.2V
AMD-K6 PR266	 External : 66MHz Ratio : 4.0x	 Dual voltage 2.2V
AMD-K6 PR300	 External : 66MHz Ratio : 4.5x	

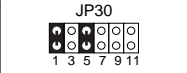
Note : The voltage of AMD may vary from market to market. Please ask your CPU provider for detail. We follow the specification of AMD. AMD has the right to change the specification without notice.

## Cyrux 6x86/L/MX Series CPUs Setting

CPU	Frequency Setting (SW1)	Voltage Setting (JP30)
Cyrux 6x86/6x86L -PR150	 External : 60MHz Ratio : 2.0x	 Single Voltage : 3.52V (default) Dual Voltage : 2.8V (default)
Cyrux 6x86/6x86L -PR166	 External : 66MHz Ratio : 2.0x	 Single Voltage : 3.52V (default) Dual Voltage : 2.8V (default)
Cyrux 6x86/6x86L -PR200	 External : 75MHz Ratio : 2.0x	
Cyrux 6x86MX -PR166	 External : 60MHz Ratio : 2.5x	
Cyrux 6x86MX -PR200	 External : 66MHz Ratio : 2.5x	 Dual Voltage : 2.9V
Cyrux 6x86MX -PR233	 External : 75MHz Ratio : 2.5x	
Cyrux 6x86MX -PR233	 External : 66MHz Ratio : 3.0x	
Cyrux 6x86MX -PR266	 External : 75MHz Ratio : 3.0x	
Cyrux 6x86MX -PR266	 External : 66MHz Ratio : 3.5x	

- Note: 1. There are two kinds of Cyrux MX-PR233/266 CPUs as you could see on the above list. Make sure the type of your CPU first from your CPU provider and then set the SW1 and JP30.
2. The voltage setting for 3.52V and 2.8V are the same due to the Smart Detect CPU Voltage technology.

## Memory Configuration

The mainboard supports one bank of **72-pin 5V FPM/EDO/Burst EDO DRAM (SIMM)**, and **three strips of 168-pin 3.3V/5V Unbuffered DIMM modules**. The mainboard requires SIMM of at least 70ns access time.

The mainboard supports SIMM bank and DIMM banks from 4 to 128 MB with no other restrictions on memory configurations. You can install memory in any combination without having to rely on a memory configuration table. Memory configuration is thus “**Table-Free**” in any memory bank. You must install two SIMM modules to complete a bank.

### Memory Configuration Table

	SIMM Bank	DIMM Bank		
	Bank 0	DIMM 1	DIMM 2	DIMM 3
RAM Type	FPM/EDO	FPM/BEDO /SDRAM	FPM/EDO/ SDRAM	FPM/EDO/ SDRAM
Single RAM Module Size (MB)	4/8/16/32/64	4/8/16/32/64 /128	4/8/16/32/64 /128	4/8/16/32/64 /128

*Note: Do not install FPM or EDO SIMM/DIMM when you already installed SDRAM type of DIMM.*

### RAM Bank Installation Notice

Due to the RAS line share architecture of ETEQ chipset, do not install SIMM bank with DIMM1. All other combinations are acceptable.



## Cache Configuration

The mainboard has a write-back caching scheme with built-in 512KB or 1MB Level 2 Pipelined Burst cache onboard to improve the system performance.

### L2 Cache Size and RAM Locations

Cache Size	Cache RAM	TAG RAM	Cacheable Range
512KB	64k x 64 on U4	16K x 8 on U11 (1 tag)	64 MB (1 dirty bit) 128 MB (0 dirty bit) *
		16K x 8 on U11,U10 (2 tags)	256 MB (1 dirty bit) * 512 MB (0 dirty bit) *
1MB	64k x 64 U4, U8	16K x 8 on U11 (1 tag)	128 MB (1 dirty bit) * 256 MB (0 dirty bit) *
		16K x 8 on U11,U10 (2 tags)	512 MB (1 dirty bit) * 512 MB (0 dirty bit) *

\* :1. The performance of 1MB cache is better than 512KB cache even the cacheable range is the same.

2. You could change the dirty bit from item "Sustained 3T Write" or "Dirty bit" in "Chipset Feature Setup" sub-menu of BIOS setup and "Enabled" means dirty bit set to 0, "Disabled" means dirty bit set to 1.

## Multi I/O Port Addresses

Default settings for multi-I/O port addresses are shown in the table below.

Port	I/O Address	IRQ	Mode
<b>LPT1*</b>	378H	7	ECP + EPP
<b>COM1</b>	3F8H	4	
<b>COM2</b>	2F8H	3	

If default I/O port addresses conflict with other I/O cards (e.g. sound cards or I/O cards), you must adjust one of the I/O addresses to avoid address conflict. (You can adjust these I/O addresses from the BIOS setup.)

*Note: Some sound cards have a default IRQ setting for IRQ7, which may conflict with printing functions. If this occurs do not use sound card functions at the same time you print.*

## Connectors

Attach the mainboard to case devices via connectors on the mainboard. Refer to Figure 1-1 for connector locations and connector pin positions.

### Front Panel Connectors

Connector's Name	Description
<b>HD LED</b>	IDE device LED connector: Attach a 2-pin IDE drive LED cable to this connector. The LED lights when an IDE device is active.
<b>KB_LOCK</b>	Keylock & Power LED connector: It is a 5-pin connector for a lock that may be installed on the system case for enabling or disabling the keyboard. It also attaches to the case's Power LED. Pin 1, 3 are for power LED and pin 4, 5 are for keylock.
<b>PW2</b>	ATX power on/off switch connector: Attach a 2-pin momentary type switch to this connector for turning on or off your ATX power supply.
<b>RESET</b>	Hardware reset switch connector: Attach 2-pin hardware reset switch to it. Closing the reset switch restarts the system.
<b>SPEAK</b>	PC speaker connector: Attach a 4-pin PC speaker cable from the case to this connector.
<b>TB LED</b>	Turbo LED connector: Attach a 2-pin turbo LED cable to it. The LED lights when the system is in turbo mode. Manufacture default has set the board in turbo mode due to most of hardware and software are compliance to turbo mode.

## Back Panel Connectors

Connector's Name	Description
<b>COM1/ COM2</b>	COM1/COM2 serial port connectors: Attach COM1/COM2 device cables to these connectors.
<b>PS/2 Keyboard Connector</b>	PS/2 keyboard port connector: A 6-pin female PS/2 keyboard connector is located at the rear of the board. Plug the PS/2 keyboard jack into this connector.
<b>PRT</b>	Parallel port connector: A 26-pin female connector is located at the rear of the board. Plug the parallel port device cable into this connector.
<b>USB1/2</b>	USB ports connectors: Two female connector is located at the rear of the board. Plug the USB devices jack into this connector.

## Other Connectors

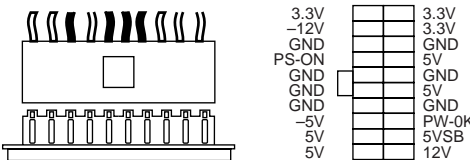
Connector's Name	Description																				
<b>ATX PW</b>	<p>ATX power supply connector: It is a twenty-pin male header connector. Plug the connector from the power directly onto the board connector while making sure the pin1 is in its position. The mainboard requires a power supply with at least 200 watts and a “power good” signal.</p>  <p>The diagram shows a 20-pin male header connector with a notch on the left side. To its right is a 20-pin female header with the following pinout:</p> <table border="1"> <tr><td>3.3V</td><td>3.3V</td></tr> <tr><td>-12V</td><td>3.3V</td></tr> <tr><td>GND</td><td>GND</td></tr> <tr><td>PS-ON</td><td>5V</td></tr> <tr><td>GND</td><td>GND</td></tr> <tr><td>GND</td><td>5V</td></tr> <tr><td>GND</td><td>GND</td></tr> <tr><td>-5V</td><td>PW-0K</td></tr> <tr><td>5V</td><td>5VSB</td></tr> <tr><td>5V</td><td>12V</td></tr> </table>	3.3V	3.3V	-12V	3.3V	GND	GND	PS-ON	5V	GND	GND	GND	5V	GND	GND	-5V	PW-0K	5V	5VSB	5V	12V
3.3V	3.3V																				
-12V	3.3V																				
GND	GND																				
PS-ON	5V																				
GND	GND																				
GND	5V																				
GND	GND																				
-5V	PW-0K																				
5V	5VSB																				
5V	12V																				
	<p><i>Note:</i> Make sure that the ATX power supply can take at least 10mAmp load on the 5V StandBy lead (5VSB) to meet the standard ATX specification.</p>																				

<b>Fan (JP43)</b>	<p>CPU cooling fan connector: Attach a 3-pin CPU cooling fan cable to this connector. Make sure the pin assignment of the fan matches this connector or you may damage the system. This fan will stop when the system is into the suspend mode, if you enable the Suspend Mode in the BIOS setup.</p> <div data-bbox="558 341 742 579" style="border: 1px solid black; padding: 5px; margin: 10px auto; width: fit-content;"> <p style="text-align: center;"><b>CPU Cooling Fan Pin Assignment</b></p> <table style="width: 100%; border-collapse: collapse;"> <tr> <td style="text-align: center; width: 20px;">1</td> <td style="text-align: center; width: 20px;">⊖</td> <td style="border-left: 1px solid black; width: 10px;"></td> <td style="text-align: center;">GND</td> </tr> <tr> <td style="text-align: center;">2</td> <td style="text-align: center;">⊖</td> <td style="border-left: 1px solid black;"></td> <td style="text-align: center;">12V</td> </tr> <tr> <td style="text-align: center;">3</td> <td style="text-align: center;">⊖</td> <td style="border-left: 1px solid black;"></td> <td style="text-align: center;">Empty</td> </tr> </table> </div>	1	⊖		GND	2	⊖		12V	3	⊖		Empty								
1	⊖		GND																		
2	⊖		12V																		
3	⊖		Empty																		
<b>IDE1/IDE2</b>	<p>Primary/Secondary IDE device connectors: Attach the IDE device cables to these connectors.</p>																				
<b>IR</b>	<p>Infrared device connector: Attach a 5-pin infrared device cable to this connector for enabling the infrared transfer function. This mainboard meets the specification of ASKIAR and HPSIR.</p> <div data-bbox="558 794 742 1067" style="border: 1px solid black; padding: 5px; margin: 10px auto; width: fit-content;"> <p style="text-align: center;"><b>IR Connector Pin Assignment</b></p> <table style="width: 100%; border-collapse: collapse;"> <tr> <td style="text-align: center; width: 20px;">1</td> <td style="text-align: center; width: 20px;">⊖</td> <td style="border-left: 1px solid black; width: 10px;"></td> <td style="text-align: center;">VCC</td> </tr> <tr> <td style="text-align: center;">2</td> <td style="text-align: center;">⊖</td> <td style="border-left: 1px solid black;"></td> <td style="text-align: center;">Empty</td> </tr> <tr> <td style="text-align: center;">3</td> <td style="text-align: center;">⊖</td> <td style="border-left: 1px solid black;"></td> <td style="text-align: center;">IRRX</td> </tr> <tr> <td style="text-align: center;">4</td> <td style="text-align: center;">⊖</td> <td style="border-left: 1px solid black;"></td> <td style="text-align: center;">GND</td> </tr> <tr> <td style="text-align: center;">5</td> <td style="text-align: center;">⊖</td> <td style="border-left: 1px solid black;"></td> <td style="text-align: center;">IRTX</td> </tr> </table> </div>	1	⊖		VCC	2	⊖		Empty	3	⊖		IRRX	4	⊖		GND	5	⊖		IRTX
1	⊖		VCC																		
2	⊖		Empty																		
3	⊖		IRRX																		
4	⊖		GND																		
5	⊖		IRTX																		

<b>JP44</b>	<p>Wake-on-LAN connector: Attach a 3-pin connector from the LAN card which supports the Wake-On-LAN (WOL) function. This function lets users wake up the connected computer through the LAN card. (The cable should be included with the LAN card.)</p> <div data-bbox="558 312 742 587" style="border: 1px solid black; padding: 5px; margin: 10px auto; width: fit-content;"><p style="text-align: center;"><b>Wake-on-LAN Pin Assignment</b></p><table style="margin: auto;"><tr><td style="text-align: center;">5V</td><td style="text-align: center;">GND</td><td style="text-align: center;">SENSOR</td></tr><tr><td style="text-align: center;">⊖</td><td style="text-align: center;">⊖</td><td style="text-align: center;">⊖</td></tr><tr><td style="text-align: center;">1</td><td style="text-align: center;">2</td><td style="text-align: center;">3</td></tr></table></div>	5V	GND	SENSOR	⊖	⊖	⊖	1	2	3
5V	GND	SENSOR								
⊖	⊖	⊖								
1	2	3								

# 3 BIOS Setup

The mainboard's BIOS setup program is the ROM PCI/ISA BIOS from Award Software Inc. Enter the Award BIOS program's Main Menu as follows:

1. Turn on or reboot the system. After a series of diagnostic checks, you are asked to press DEL to enter Setup.
2. Press the <DEL> key to enter the Award BIOS program and the main screen appears:

ROM PCI/ISA BIOS  
CMOS SETUP UTILITY  
AWARD SOFTWARE, INC.

STANDARD CMOS SETUP	INTEGRATED PERIPHERALS
BIOS FEATURES SETUP	SUPERVISOR PASSWORD
CHIPSET FEATURES SETUP	USER PASSWORD
POWER MANAGEMENT SETUP	IDE HDD AUTO DETECTION
PNP/PCI CONFIGURATION	SAVE & EXIT SETUP
LOAD SETUP DEFAULTS	EXIT WITHOUT SAVING
LOAD BIOS DEFAULTS	
Esc : Quit	↑ ↓ → ← : Select Item
F10 : Save & Exit Setup	(Shift) F2 : Change Color
Time, Date, Hard Disk Type...	

3. Choose an option and press <Enter>. Modify the system parameters to reflect the options installed in the system. (See the following sections.)
4. Press <ESC> at anytime to return to the Main Menu.
5. In the Main Menu, choose "SAVE AND EXIT SETUP" to save your changes and reboot the system. Choosing "EXIT WITHOUT SAVING" ignores your changes and exits the program.

The Main Menu options of the Award BIOS are described in the sections that follow.

## Standard CMOS Setup

Run the Standard CMOS Setup as follows.

1. Choose “STANDARD CMOS SETUP” from the Main Menu. A screen appears.

ROM PCI/ISA BIOS  
STANDARD CMOS SETUP  
AWARD SOFTWARE, INC.

Date (mm:dd:yy) : Fri, Feb 1 1995																	
Time (hh:mm:ss) : 7 : 30 : 33																	
HARD DISKS	TYPE	SIZE	CYLS	HEAD	PRECOMP	LANDZ	SECTOR	MODE									
Primary Master	: AUTO	0	0	0	0	0	0	0	AUTO								
Primary Slave	: None	0	0	0	0	0	0	0	----								
Secondary Master	: None	0	0	0	0	0	0	0	----								
Secondary Slave	: None	0	0	0	0	0	0	0	----								
Drive A : 1.44M, 3.5 in.					<table border="1"> <tr> <td>Base Memory:</td> <td>640K</td> </tr> <tr> <td>Extended Memory:</td> <td>3328K</td> </tr> <tr> <td>Other Memory:</td> <td>128K</td> </tr> <tr> <td colspan="2">Total Memory: 4096K</td> </tr> </table>					Base Memory:	640K	Extended Memory:	3328K	Other Memory:	128K	Total Memory: 4096K	
Base Memory:	640K																
Extended Memory:	3328K																
Other Memory:	128K																
Total Memory: 4096K																	
Drive B : None																	
Floppy 3 Mode Support : Disabled																	
Video : EGA/VGA																	
Halt On : All Errors																	
Esc : Quit			↑ ↓ → ← : Select Item			PU/PD/+/- : Modify											
F11 : Help			(Shift) F2 : Change Color			F3 : Toggle Calendar											

2. Use arrow keys to move between items and select values. Modify selected fields using PgUp/PgDn/+/- keys. Some fields let you enter values directly.

**Date (mm/dd/yy)** Type the current date.

**Time (hh:mm:ss)** Type the current time.

**Primary (Secondary)** First, choose the type of hard disk that you already installed:

- Master & Slave**
- Auto – BIOS detects hard disk type automatically (default)
  - 1 ~ 46 – Selects standard hard disk type
  - User – User defines the type of hard disk.

Next, choose hard disk mode:

- Auto – BIOS detects hard disk mode automatically (default)
- Normal – Normal IDE hard disk (smaller than 528MB)
- LBA – Enhanced-IDE hard disk (larger than 528MB)

<b>Primary (Secondary) Master &amp; Slave (Continued)</b>	Large – Large IDE hard disk (for certain hard disk)  <i>Note: If you have any questions on your hard disk type or mode, ask your hard disk provider or previous user for details.</i>
<b>Drive A &amp; B</b>	Choose 360KB , 5 1/4 in., 1.2MB , 5 1/4 in., 720KB , 3 1/2 in., 1.44M , 3 1/2 in.(default), 2.88 MB, 3 1/2 in. or Not installed
<b>Floppy 3 Mode Support</b>	Choose Disabled (default) or Enabled. When enables this function, the system will support 720KB/1.25MB/1.44MB 3 different modes floppy diskette.  <i>Note: This function is for a special disk drive which happens to be popular in Japan.</i>
<b>Video</b>	Choose Monochrome, Color 40x25, VGA/EGA (default), Color 80x25
<b>Halt On</b>	When BIOS detects system errors, this function will stop the system. Choose one of the following options to make system halt.  All Errors (default)       All, But Diskette No Errors                   All, But Keyboard   All, But Disk/Key

3. When you finish, press the <ESC> key to return to the Main Menu.



## BIOS Features Setup

Run the BIOS Features Setup as follows.

1. Choose “BIOS FEATURES SETUP” from the Main Menu and a screen with a list of items appears. (The screen below shows the BIOS default settings.)

ROM PCI/ISA BIOS  
BIOS FEATURES SETUP  
AWARD SOFTWARE, INC.

CPU Internal Cache	: Enabled	Video BIOS Shadow	: Enabled
External Cache	: Enabled	C8000-CBFFF Shadow	: Disabled
Quick Power on Self Test	: Enabled	CC000-CFFFF Shadow	: Disabled
Boot Sequence	: A,C,SCSI	D0000-D3FFF Shadow	: Disabled
Swap Floppy Drive	: Disabled	D4000-D7FFF Shadow	: Disabled
Boot Up NumLock Status	: On	D8000-DBFFF Shadow	: Disabled
Typematic Rate Setting	: Disabled	DC000-DFFFF Shadow	: Disabled
Typematic Rate (Chars/Sec)	: 6		
Typematic Delay (Msec)	: 250		
Security Option	: Setup	ESC : Quit	↑ ↓ → ← : Select Item
IDE Second Channel Control	: Enabled	F1 : Help	PU/PD/+/- : Modify
PS/2 Mouse Function Control	: Disabled	F5 : Old Values (Shift)	F2 : Color
PCI/VGA Palette Snoop	: Disabled	F6 : Load BIOS Defaults	
OS Select for DRAM >64MB	: Non-OS2	F7 : Load Setup Defaults	

2. Use the arrow keys to move between items and to select values. Modify the selected fields using the PgUp/PgDn/+/- keys. <F> keys are explained below:
  - <F1>: “Help” gives options available for each item.
  - Shift <F2>: Change color.
  - <F5>: Get the old values. These values are the values with which the user started the current session.
  - <F6>: Load all options with the BIOS Setup default values.
  - <F7>: Load all options with the Power-On default values.

A short description of screen items follows:

**CPU Internal Cache** This option enables/disables the CPU’s internal cache. (The Default setting is Enabled.)

**External Cache** This option enables/disables the external cache memory. (The Default setting is Enabled.)

**Quick Power On Self Test** Enabled provides a fast POST at boot-up .

- Boot Sequence** Choose the boot device sequence as your need. For example, “A, C, SCSI” means BIOS will look for an operating system first from drive A, drive C, then SCSI device. Options of this function are:  
 A, C, SCSI  
 C, A, SCSI  
 C, CD-ROM, A  
 CD-ROM, C, A  
 D, A, SCSI  
 E, A, SCSI  
 F, A, SCSI  
 SCSI, A, C  
 SCSI, C, A  
 C only.
- Swap Floppy Drive** Enabled changes the sequence of the A: and B: drives. (The Default setting is Disabled.)
- Boot Up Num Lock Status** Choose **On** or **Off**. On puts numeric keypad in Num Lock mode at boot-up. Off puts this keypad in arrow key mode at boot-up.
- Typematic Rate Setting** Enable this option to adjust the keystroke repeat rate.
- Typematic Rate (Chars/Sec)** Choose the rate a character keeps repeating.
- Typematic Delay (Msec)** Choose how long after you press a key that a character begins repeating.
- Security Option** Choose **Setup** or **System**. Use this feature to prevent unauthorized system boot-up or use of BIOS Setup.
- “System” – Each time the system is booted the password prompt appears.
- “Setup” – If a password is set, the password prompt only appears if you attempt to enter the Setup program.

<b>IDE Second Channel Control</b>	Default setting is Enabled. Choose Disabled when you need to turn off the onboard IDE second channel.
<b>PS/2 Mouse Function Control</b>	Default setting is Disabled. You need to enable this function when the PS/2 mouse is attached.
<b>PCI/VGA Palette Snoop</b>	Enabled: The color of the monitor may be incorrect if uses with MPEG card. Enable this option to make the monitor normal.  Disabled: Default setting.
<b>OS Select for DRAM &gt;64MB</b>	OS2 – Choosing this when you are using OS/2 operation system.  Non-OS/2 – Choosing this when you are using no-OS/2 operation system.
<b>Video or Adapter BIOS Shadow</b>	BIOS shadow copies BIOS code from slower ROM to faster RAM. BIOS can then execute from RAM. These 16K segments can be shadowed from ROM to RAM. BIOS is shadowed in a 16K segment if it is enabled and it has BIOS present.

3. After you have finished with the BIOS Features Setup program, press the <ESC> key and follow the screen instructions to save or disregard your settings.

## Chipset Features Setup

The Chipset Features Setup option changes the values of the chipset registers. These registers control system options in the computer.

*Note:* Change these settings only if you are familiar with the Chipset.

Run the Chipset Features Setup as follows.

1. Choose “CHIPSET FEATURES SETUP” from the Main Menu and the following screen appears. (The screen below shows default settings.)

ROM PCI/ISA BIOS CHIPSET FEATURES SETUP AWARD SOFTWARE, INC.	
Bank 0/1 DRAM Timing	: 60ns
Read Pipeline	: Disabled
Write Pipeline	: Enabled
Video BIOS Cacheable	: Disabled
System BIOS Cacheable	: Disabled
Memory hole At 15Mb Addr.	: Disabled
OnChip USB	: Disabled
ESC : Quit            ↑ ↓ → ← : Select Item F1 : Help             PU/PD/+/- : Modify F5 : Old Values (Shift) F2 : Color F6 : Load BIOS Defaults F7 : Load Setup Defaults	

2. Use the arrow keys to move between items and select values. Modify selected fields using the PgUp/PgDn/+/- keys.

A short description of screen items follows:

**Bank 0/1 DRAM Timing** Choose 60ns, 70ns, Normal, Medium, Fast, or Turbo. Normal is the slowest and you must check the system stability before you change to the Fast or Turbo setting. Choose 60ns or 70ns only when you know the exact timing of the DRAM.

**DRAM Read Pipeline** Use the default setting.

**Cache Rd + CPU Wt Pipeline** Use the default setting.

**Read Around Write** Use the default setting.

---

<b>Linear Burst</b>	Choose Enabled when you installed a Cyrix CPU and set JP22 to Linear mode.
<b>Video BIOS Cacheable</b>	Disabled – The ROM area F0000H-FFFFFH is not cached.  Enabled – The ROM area F0000H-FFFFFH is cacheable if cache controller is enabled.
<b>System BIOS Cacheable</b>	Disabled – The video BIOS C0000H-C7FFFH is not cached.  Enabled – The video BIOS C0000H-C7FFFH is cacheable if cache controller is enabled.
<b>Memory Hole At 15Mb Addr</b>	Choose <b>Enabled</b> or <b>Disabled</b> (default). Some interface cards will map their ROM address to this area. If this occurs, you should select Enabled, otherwise use Disabled.
<b>AGP</b>	Choose Enabled when you wish to use DRAM to extend the size of your AGP VGA card's VRAM.
<b>AGP Aperture Size</b>	AGP could use the DRAM as its video RAM. Choose the DRAM size that you want it to be used as video RAM. The range is from 4MB to 256MB.
<b>OnChip USB</b>	Default is Disabled. Enable this function when you use the USB device.
<b>USB Keyboard Support</b>	Enable this function when you use the USB keyboard, but notice that you need to use the regular keyboard first before getting in the BIOS setup.

**Spread Spectrum  
Modulated**

Choose **Disabled** (default) or Enabled.  
Select Enabled when uses Spread  
Spectrum Modulated 1.5% or 6% for FCC  
or DOC testing.

3. After you have finished with the Chipset Features Setup, press the <ESC> key and follow the screen instructions to save or disregard your settings.

## Power Management Setup

The Power Management Setup option sets the system's power saving functions.

Run the Power Management Setup as follows.

1. Choose "POWER MANAGEMENT SETUP" from the Main Menu and a screen with a list of items appears.

ROM PCI/ISA BIOS CMOS SETUP UTILITY POWER MANAGEMENT SETUP	
Power Management : Disabled	** Power Down & Resume Events **
PM Control by APM : Yes	IRQ 5 (LPT 2) : Primary
Video Off Option : Suspend -> Off	IRQ 6 (Floppy Disk) : Primary
Video Off Method : V/H SYNC+Blank	IRQ 7 (LPT 1) : Primary
Conserve Mode : Disabled	IRQ 8 (RTC Alarm) : Disabled
	IRQ 9 (IRQ2 Redir) : Secondary
** PM Timers **	IRQ 10 (Reserved) : Secondary
HDD Power Down : Disabled	IRQ 11 (Reserved) : Secondary
Doze Mode : Disabled	IRQ 12 (PS/2 mouse) : Primary
Suspend Mode : Disabled	IRQ 13 (Coprocesor) : Primary
	IRQ 14 (Hard Disk) : Primary
** PM Events **	IRQ 15 (Reserved) : Disabled
VGA : OFF	ESC : Quit ↑↓ → ← : Select Item
LPT & COM : LPT/COM	F1 : Help PU/PD/+/- : Modify
HDD & FDD : ON	F5 : Old Values (Shift) F2 : Color
DMA/master : OFF	F6 : Load BIOS Defaults
Primary INTR : ON	F7 : Load Setup Defaults
IRQ 3 (COM 2) : Primary	
IRQ 4 (COM 1) : Primary	

2. Use the arrow keys to move between items and to select values. Modify the selected fields using the PgUp/PgDn/+/- keys.

A short description of selected screen items follows:

<b>Power Management</b>	Options are as follows:
User Define –	Let's you define the HDD and system power down times.
Disabled –	Disables the Green PC Features.
Min Saving –	Doze timer = 1 Hour Suspend timer = 1 Hour HDD Power Down = 15 Min
Max Saving –	Doze timer = 10 Sec Suspend timer = 10 Sec HDD Power Down = 1 Min

---

<b>PM Control by APM</b>	Choose <b>Yes</b> (default) or <b>No</b> . APM stands for Advanced Power Management. To use APM, you must run “power.exe” under DOS v6.0 or later version.
<b>Video Off Option</b>	Susp, Stby→off: Video off when the system runs into Suspend or Standby mode.  All Modes→off: Video off in all modes.  Always On: Video never off.  Suspend→off: Video off when system runs into the suspend mode.
<b>Video Off Method</b>	Choose <b>V/H Sync+Blank</b> (default), <b>Blank screen</b> , or <b>DPMS</b> for the selected PM mode.
<b>Conserve Mode</b>	Use the default setting.
<b>HDD Power Down</b>	When the set time has elapsed, the BIOS sends a command to the HDD to power down, which turns off the motor. Time is adjustable from 1 to 15 minutes. The default setting is Disabled. Some older model HDDs may not support this advanced function.
<b>Doze Mode</b>	When the set time has elapsed, the BIOS sends a command to the system to enter doze mode (system clock drops to 33MHz). Time is adjustable from 10 seconds to 1 Hour.
<b>Suspend Mode</b>	The default is Disabled. Only an SL-Enhanced (or SMI) CPU can enter this mode. Time is adjustable from 10 seconds to 1 Hour. Under Suspend mode, the CPU stops completely (no instructions are executed.)
<b>VGA</b>	Choose <b>Off</b> (default) or <b>On</b> to disable or enable the power management.



---

<b>LPT &amp; COM</b>	Choose LPT/COM (default) or LPT (COM) to enable the power management timer. Choose NONE to disable the power management timer.
<b>HDD &amp; FDD</b>	Choose <b>On</b> (default) to enable the power management timer, or <b>Off</b> to disable the power management timer.
<b>DMA/master</b>	Choose <b>Off</b> (default) or <b>On</b> . If you choose the system “Off”, will not monitor the signal of DMA/master; and when you choose “On”, the system will not have SMI signal until the master is finished while the master is working.
<b>Primary INTR</b>	When <b>On</b> (default) is chosen, you can choose any IRQ #.
<b>IRQ#</b>	When set at “Primary” the processor will power down only after the BIOS detects a “no IRQ activity” during the time specified by the Suspend time. If set at “Secondary event” the system will distinguish whether an interrupt accesses and I/O address or not. If it does, the system enters the standby mode. If not, the system enters the dreaming mode; that is the system goes back full-on status but leaves the monitor blank. For instance, if the system connects to a LAN and receives an interrupt from its file server, the system will enter the dreaming mode to execute the corresponding calling routine.

3. After you have finished with the Power Management Setup, press the <ESC> key to return to the Main Menu.

## PNP/PCI Configuration Setup

This option sets the mainboard's PCI Slots. Run this option as follows:

1. Choose "PNP/PCI CONFIGURATION SETUP" from the Main Menu and the following screen appears. (The screen below shows default settings.)

ROM PCI/ISA BIOS PNP/PCI CONFIGURATION AWARD SOFTWARE, INC.	
Resources Controlled By : Manual Reset Configuration Data : Disabled	PCI IRQ Activated By : Level PCI IDE IRQ Map To : PCI-AUTO Primary IDE INT# : A Secondary IDE INT# : B
IRQ-3 assigned to : Legacy ISA*	ESC : Quit           ↑↓→←: Select Item F1 : Help            PU/PD/+/- : Modify F5 : Old Values (Shift)F2 : Color F6 : Load BIOS Defaults F7 : Load Setup Defaults
IRQ-4 assigned to : Legacy ISA*	
IRQ-5 assigned to : PCI/ISA PnP*	
IRQ-7 assigned to : PCI/ISA PnP*	
IRQ-9 assigned to : PCI/ISA PnP*	
IRQ-10 assigned to : PCI/ISA PnP*	
IRQ-11 assigned to : PCI/ISA PnP*	
IRQ-12 assigned to : PCI/ISA PnP*	
IRQ-14 assigned to : PCI/ISA PnP*	
IRQ-15 assigned to : PCI/ISA PnP*	
DMA-0 assigned to : PCI/ISA PnP*	
DMA-1 assigned to : PCI/ISA PnP*	
DMA-3 assigned to : PCI/ISA PnP*	
DMA-5 assigned to : PCI/ISA PnP*	
DMA-6 assigned to : PCI/ISA PnP*	
DMA-7 assigned to : PCI/ISA PnP*	

\*: These items will disappear when Resource Controlled. is Auto.

2. Use the arrow keys to move between items and select values. Modify selected fields using the PgUp/PgDn/+/- keys.

A short description of screen items follows:

<b>Resources Controlled By</b>	Manual – BIOS doesn't manage PCI/ISA PnP card (i.e., IRQ) automatically.
	Auto – BIOS auto manage PCI and ISA PnP card (recommended).
<b>Reset Configuration Data</b>	Disabled – Retain PnP configuration data in BIOS.
	Enabled – Reset PnP configuration data in BIOS.

- |                                 |  |
|---------------------------------|--|
| <b>IRQX and DMA assigned to</b> | Choose <b>PCI/ISA PnP</b> or <b>Legacy ISA</b> . If the first item is set to Manual, you could choose IRQX and DMA assigned to PCI/ISA PnP card or ISA card.   |
| <b>PCI IRQ Activated By</b>     | Choose <b>Edge</b> or <b>Level</b> . Most PCI trigger signals are Level. This setting must match the PCI card.   |
| <b>PCI IDE IRQ Map To</b>       | Select <b>PCI-AUTO</b> , <b>ISA</b> , or <b>assign a PCI SLOT number</b> (depending on which slot the PCI IDE is inserted). The default setting is PCI-AUTO. If PCI-AUTO does not work, then assign an individual PCI SLOT number. |
| <b>Primary IDE INT#</b>         | Choose INTA#, INTB#, INTC#, or INTD#. The default setting is INTA#.  |
| <b>Secondary IDE INT#</b>       | Choose INTA#, INTB#, INTC#, or INTD#. The default setting is INTB#.  |
3. After you have finished with the PCI Slot Configuration, press the <ESC> key and follow the screen instructions to save or disregard your settings.

## Load Setup Defaults

---

This item loads the system values you have previously saved. Choose this item and the following message appears:

“Load SETUP Defaults (Y/N)? N”

To use the SETUP defaults, change the prompt to “Y” and press <Enter>. This item is recommended if you need to reset the system setup.

*Note: The SETUP Defaults are optimized for the most stabilized performance.*

## Load BIOS Defaults

---

Choose this item and the following message appears:

“Load BIOS Defaults (Y/N)?N”

To use the BIOS defaults, change the prompt to “Y” and press <Enter>.

*Note: BIOS DEFAULTS values are adjusted for high performance. If you run into any problems after loading BIOS DEFAULTS, please load the SETUP DEFAULTS for the stable performance.*

## Integrated Peripherals

The Integrated Peripherals option changes the values of the chipset registers. These registers control system options in the computer.

*Note:* Change these settings only if you are familiar with the Chipset.

Run the Integrated Peripherals as follows.

1. Choose “Integrated Peripherals” from the Main Menu and the following screen appears. (The screen below shows default settings:)

ROM PCI/ISA BIOS INTEGRATED PERIPHERALS AWARD SOFTWARE, INC.	
OnChip IDE First Channel : Enabled	
OnChip IDE Second Channel: Enabled	
IDE Prefetch Mode : Enabled	
IDE HDD Block Mode : Enabled	
IDE Primary Master PIO : Auto	
IDE Primary Slave PIO : Auto	
IDE Secondary Master PIO : Auto	
IDE Secondary Slave PIO : Auto	
IDE Secondary Master UDMA: Auto	
IDE Secondary Slave UDMA: Auto	
Onboard FDC Controller : Enabled	
Onboard UART 1 : 3F8/IRQ4	
Onboard UART 2 : 2F8/IRQ3	
Onboard UART 2 Mode : Standard	
Onboard Parallel Port : 378/IRQ7	
Parallel Port Mode : ECP+EPP	
ECP Mode Use DMA : 3	
Parallel Port EPP Type : EPP1.9	
ESC : Quit                    ↑ ↓ → ← : Select Item F1 : Help                    PU/PD/+/- : Modify F5 : Old Values (Shift)F2 : Color F6 : Load BIOS Defaults F7 : Load Setup Defaults	

2. Use the arrow keys to move between items and select values. Modify selected fields using the PgUp/PgDn/+/- keys.

A short description of screen items follows:

- On-chip IDE First Channel/** Enabled – Use the on-board IDE (default)
- On-chip IDE Second Channel** Disabled – Turn off the on-board IDE
- IDE Prefetch Mode** Use the default setting.
- IDE HDD Block Mode** Choose **Enabled** (default) or **Disabled**. Enabled invokes multi-sector transfer instead of one sector per transfer. Not all HDDs support this function.

<b>IDE Primary Master PIO/ IDE Primary Slave PIO/ IDE Secondary Master PIO/ IDE Secondary Slave PIO</b>	Choose <b>Auto</b> (default) or <b>mode 0~4</b> . Mode 0 is the slowest speed, and HDD mode 4 is the fastest speed. For better performance and stability, we suggest you use the Auto setting to set the HDD control timing.
<b>IDE Secondary Master UDMA IDE Secondary Slave UDMA</b>	Choose <b>Auto</b> (default) or <b>Disabled</b> . When Auto is selected, it supports Ultra DMA Mode.
<b>Onboard FDC Controller</b>	Enabled – Use the on-board floppy controller (default). Disabled – Turn off the on-board floppy controller.
<b>Onboard UART 1/ Onboard UART 2</b>	Choose serial port 1 & 2's I/O address. Do not set port 1 & 2 to the same value except for Disabled.  COM 1/3F8H   COM3/3E8H COM 2/2F8H   COM4/2E8H (default)
<b>Onboard UART 2 Mode</b>	Standard – (default) supports a serial infrared IrDA.  HPSIR – supports HP serial infrared interface format  ASKIR – supports a Sharp serial interface format.
<b>IR Duplex Mode</b>	Use the default setting (Half). This function shows up only when either HPSIR or ASKIR is chosen in the previous function (Onboard UART 2 Mode).
<b>Onboard Parallel Port</b>	Choose the printer I/O address: 378H/IRQ7 (default), 3BCH/IRQ7, 278H/IRQ5

---

<b>Parallel Port Mode</b>	Choose <b>ECP + EPP</b> (default), <b>Normal</b> or <b>EPP</b> , <b>ECP</b> mode. The mode depends on your external device that connects to this port.
<b>ECP Mode Use DMA</b>	Choose <b>DMA3</b> (default) or <b>DMA1</b> . This setting only works when the Onboard Printer Mode is set at the ECP mode.
<b>Parallel Port EPP Type</b>	Choose EPP specification Ver. 1.7 or 1.9 (default).

---

## Supervisor Password

---

Based on the setting you made in the “Security Option” of the “BIOS FEATURES SETUP”, this Main Menu item lets you configure the system so that a password is required every time the system boots or an attempt is made to enter the Setup program. Change the password as follows:

1. Choose “SUPERVISOR PASSWORD” in the Main Menu and press <Enter>. The following message appears:

**“Enter Password:”**

2. Enter a password and press <Enter>. (If you do not wish to use the password function, you can just press <Enter> and a “Password disabled” message appears. )
3. After you enter your password, the following message appears prompting you to confirm the new password:

**“Confirm Password:”**

4. Re-enter your password and then Press <ESC> to exit to the Main Menu.

***Important:*** *If you forget or lose the password, the only way to access the system is to set jumper JP5 to clear the CMOS RAM. All setup information is lost and you must run the BIOS setup program again.*

---

## User Password

---

Based on the setting you made in the “Security Option” of the “BIOS FEATURES SETUP”, this Main Menu item lets you configure the system so that a password is required every time the system boots or an attempt is made to enter the Setup program. Change the password as follows:

1. Choose “USER PASSWORD” in the Main Menu and press <Enter>. The following message appears:

**“Enter Password:”**

2. Enter a password and press <Enter>. (If you do not wish to use the password function, you can just press <Enter> and a “Password disabled” message appears. )
3. After you enter your password, the following message appears prompting you to confirm the new password:

**“Confirm Password:”**

4. Re-enter your password and then Press <ESC> to exit to the Main Menu.
5. You are not allowed to change any setting in “CMOS SETUP UTILITY” except change user’s password.

***Important: If you forget or lose the password, the only way to access the system is to set jumper JP5 to clear the CMOS RAM. All setup information is lost and you must run the BIOS setup program again.***



## IDE HDD Auto Detection

This Main Menu item automatically detects the hard disk type and configures the STANDARD CMOS SETUP accordingly.

*Note: This function is only valid for IDE hard disks.*

ROM PCI/ISA BIOS  
 CMOS SETUP UTILITY  
 AWARD SOFTWARE, INC.

HARD DISKS	TYPE	SIZE	CYLS	HEAD	PRECOMP	LANDZ	SECTOR	MODE
Primary Master	: None	0	0	0	0	0	0	----
Primary Slave	: None	0	0	0	0	0	0	----
Secondary Master	: None	0	0	0	0	0	0	----
Secondary Slave	: None	0	0	0	0	0	0	----

Do you accept this drive C (Y/N)? N

ESC : Skip

# Quick Installation Guide

This Quick Installation Guide leaflet is designed for those people who are familiar with motherboard settings to set up this new motherboard in order to boot up the system. Refer back to the proper chapters if you have run in to any problems.

## Motherboard Layout

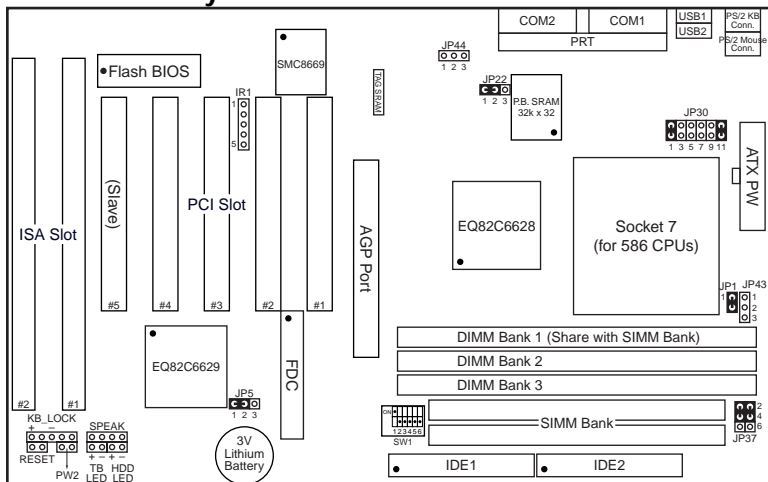

## CPU Voltage and Frequency Jumper Settings

### Voltage Settings: JP30

### CPU Frequency Settings: SW1

	1-2	3-4	5-6	7-8	9-10	11-12	Multiplier	1	2	3	Frequency	4	5	6
Single 3.52V	close	open	open	open	open	close	1.5x/3.5x	off	off	off	50MHz	on	on	off
Single 3.3V	close	open	open	open	close	open	2.0x	on	off	off	60MHz	off	off	off
Dual 3.2V	close	open	open	close	open	open	2.5x	on	on	off	66MHz	on	off	off
Dual 2.9V	close	open	close	open	open	open	3.0x	off	on	off	75MHz	off	on	off
Dual 2.8V	close	open	open	open	open	close	4.0x	on	off	on				
							4.5x	on	on	on				
							5.0x	off	on	on				

## Memory Configuration

	SIMM Bank	DIMM Bank		
	Bank 0	DIMM 1	DIMM 2	DIMM 3
RAM Type	FPM/EDO	FPM/EDO/SDRAM	FPM/EDO/SDRAM	FPM/EDO/SDRAM
Size (MB)	4/8/16/32/64	4/8/16/32/64/128	4/8/16/32/64/128	4/8/16/32/64/128

*Note: Do not use FPM or EDO SIMM/DIMM if you already use SDRAM. Do not use Bank0 and DIMM1 at the same time.*

## Additional Jumper Settings

CMOS clear: JP5		Auto Voltage Detect Disable: JP1		CPU Cooling Fan: JP43					
Retain CMOS data (default)	1-2	Remove this jumper cap if you use an older type of CPU which can not be identified correctly		pin	1	2	3		
				function	GND	12V	GND		
Clear CMOS data	2-3	<b>Burst Mode: JP22</b>		<b>TB LED</b>		<b>Reset</b>		<b>HDD LED</b>	
		1-2	Intel, AMD	Connect the turbo LED to this jumper		Connect the reset button to this jumper		Connect the HDD LED to this jumper	
		2-3	Cyrix						
<b>DIMM Voltage: JP37</b>		3.3V DIMM (default)		1-3, 2-4		<b>Speak</b>		<b>KB Lock</b>	
		5V DIMM		3-5, 4-6		Connect the speaker to this jumper		Connect keylock & power LED to jumper J17	
<b>Power switch: PW2</b>									
Connect your power switch to this jumper (momentary switch type)									

## Settings for Various Processors: SW1 & JP30

CPU Frequency: SW1									CPU Voltage: JP30						
Processor	Bus Clock	Multi-plier	1	2	3	4	5	6	Voltage	1-2	3-4	5-6	7-8	9-10	11-12
AMD K5 PR75	50MHz	1.5x	off	off	off	on	on	on	Due to the various versions and voltages of AMD K5 and K6, please verify the correct voltage settings before doing any installation						
AMD K5 PR90	60MHz	1.5x	off	off	off	on	off	off							
AMD K5 PR100	66MHz	1.5x	off	off	off	off	off	off							
AMD K5 PR120	60MHz	1.5x	off	off	off	on	off	off							
AMD K5 PR133	66MHz	1.5x	off	off	off	off	off	off							
AMD K5 PR166	66MHz	2.5x	on	on	off	off	off	off							
AMD K6 PR166	66MHz	2.5x	on	on	off	off	off	off	dual 2.9V	close	open	close	open	open	open
AMD K6 PR180	60MHz	3.0x	off	on	off	on	off	off	dual 3.2V	close	open	open	close	open	open
AMD K6 PR200	66MHz	3.0x	off	on	off	off	off	off	dual 2.2V	open	close	open	open	open	open
AMD K6 PR233	66MHz	3.5x	off	off	off	off	off	off	Due to the various versions and voltages of Cyrix 6x86(L) P150 <sup>+</sup> and P166 <sup>+</sup> , please verify the correct voltage settings before doing any installation						
Cyrix 6x86(L) P150 <sup>+</sup>	60MHz	2.0x	on	off	off	on	off	off							
Cyrix 6x86(L) P166 <sup>+</sup>	66MHz	2.0x	on	off	off	off	on	off							
Cyrix 6x86(L) P200 <sup>+</sup>	75MHz	2.0x	on	off	off	off	on	off	dual 2.9V	close	open	close	open	open	open
Cyrix MX PR166	60MHz	2.5x	on	on	off	on	off	off	Due to the various versions and voltages of P54C (standard Pentium), please verify the correct voltage settings before doing any installation						
Cyrix MX PR200	66MHz	2.5x	on	on	off	off	off	off							
Cyrix MX PR233	75MHz	2.5x	on	on	off	off	on	off							
Cyrix MX PR266	66MHz	3.5x	off	off	off	off	off	off							
P54C P75	60MHz	1.5x	off	off	off	on	on	on	Due to the various versions and voltages of P54C (standard Pentium), please verify the correct voltage settings before doing any installation						
P54C P90	60MHz	1.5x	off	off	off	on	off	off							
P54C P100	66MHz	1.5x	off	off	off	off	off	off							
P54C P120	60MHz	2.0x	on	off	off	on	off	off							
P54C P133	66MHz	2.0x	on	off	off	off	off	off							
P54C/P55C P150	60MHz	2.5x	on	on	off	on	off	off	The P55C (MMX) processors have the same voltage setting: 2.8V						
P54C/P55C P166	66MHz	2.5x	on	on	off	off	off	off							
P54C/P55C P180	60MHz	3.0x	off	on	off	on	off	off							
P54C/P55C P200	66MHz	3.0x	off	on	off	off	off	off							
P55C P233	66MHz	3.5x	off	off	off	off	off	off	dual 2.8V	close	open	open	open	open	close

## **ETEQ Drivers Installation Guide**

### **Step 1 : South Bridge Identify Issue**

ETEQ south bridge chipset can not be identified by Windows 95 and so it shows two question marks under 'Device Manager'. Therefore, we provide drivers for you to solve this problem. Please find the Setup.exe file from the \rev-10\utility\Eteq\_USB directory under your CD-ROM that came with your motherboard and install it.

### **Step 2 : IDE Bus Master/Ultra DMA Drivers**

If you have IDE devices that support Bus Master or Ultra DMA function, you need to install the drivers to enable these functions. Please find the Setup.exe file from the \rev-10\utility\Eteq\_IDE directory under your CD-ROM that came with your motherboard and install it.

## How to use AGP on the 5ED5/M-(T2)

Because AGP is a very new technology, enabling the use of AGP on your 5ED/M-(T2) board requires you to go through a lot of complicated steps. All the necessary steps are described below, step through them one by one, then installing all the necessary drivers should not be a problem.

- 1.) **First** of all, it is impossible to use the AGP port with a version of windows lower than OSR2. Users of an older version of windows should upgrade to OSR2. You can check what version of windows you have installed by taking the following steps: click 'start', 'settings', 'control panel' and select 'system' there. Under the 'General' tab you will find what version of Windows you have installed. If there is a B or a C at the end of the system description then you have installed OSR2. Users of windows 98 (Memphis) can use AGP as well. Users of NT will need to run NT5 to make use of AGP.
- 2.) **Now** enter the BIOS setup by pressing the <Delete> during boot-up. Go to the 'Chipset Features Setup' section of the BIOS setup and make sure that the 'AGP' item there is set to 'enabled'.
- 3.) **You** will now have to install USBSUPP.EXE from Microsoft, which includes the USB supplement and a new memory manager (VMM32.VxD) needed for the AGP DIME feature. You can find this file on the OSR2 CD, in the directory \OSR2\USBSUPP. (Make sure your OSR2 CD support USB)
- 4.) **Install** the VXD driver from this directory -> \rev-10\utility\Eteq\_AGP\setup.exe in your CD-ROM.
- 5.) **Next** you will have to install Direct X5 to your system. This is a set of drivers provided by Microsoft for free, but you will have to download them from their Internet Site. Go to the following address to download the drivers: <http://www.microsoft.com/directx/default.asp> and download 'DirectX 5.0 for end users'. After downloading install it to your system and restart your system.
- 6.) **Install** the drivers that came with your AGP card, and after restarting your system you should be ready to make full use of your system's AGP port.
- 7.) **In order** to verify whether or not you really have successfully installed all the necessary components, please take the following steps: Open the 'Microsoft DirectX-5 SDK' and double click on 'Direct X viewer'. Switch to 'DirectDraw Devices'. If there are numbers given for the following items: 'Video', 'Video (local)', 'Video (Non Local)' and 'texture', it means that you have succeeded, because your system now allows your AGP card to make use of the main memory for storage of image and texture data. If there is no memory selected for these items then AGP is not enabled, please go through the above steps to see if you forgot something.

## New item in CHIPSET FEATURES SETUP

New BIOS add a item in “CHIPSET FEATURES SETUP” and it’s “SUSTAINED 3T WRITE” (or “DIRTY BIT”).

Enabled : Set the L2 cache dirty bit to 0.

Disabled : Set the L2 cache dirty bit to 1.

Note : Please refer to page 13 for detail information about the relation between Dirty bit and Cacheable range.