

Mainboard User's Manual

This publication, including all photographs, illustrations and software, is protected under international copyright laws, with all rights reserved. Neither this manual, nor any of the material contained herein, may be reproduced without the express written consent of the manufacturer.

The information in this document is subject to change without notice. The manufacturer makes no representations or warranties with respect to the contents hereof and specifically disclaims any implied warranties of merchantability or fitness for any particular purpose. Further, the manufacturer reserves the right to revise this publication and to make changes from time to time in the content hereof without obligation of the manufacturer to notify any person of such revision or changes.

Trademarks

IBM, VGA, and PS/2 are registered trademarks of International Business Machines.

Intel, Pentium/II/III, MMX, and Celeron are registered trademarks of Intel Corporation.

Microsoft, MS-DOS and Windows 95/98/NT/2000 are registered trademarks of Microsoft Corporation.

Sound Blaster is a trademark of Creative Technology Ltd.

PC-cillin and ChipAwayVirus are trademarks of Trend Micro Inc.

AMI is a trademark of American Megatrends Inc.

A3D is a registered trademark of Aureal Inc.

SuperVoice is a registered trademark of Pacific Image Communications Inc.

MediaRing Talk is a registered trademark of MediaRing Inc.

3Deep is a registered trademark of E-Color Inc.

Other names used in this publication may be trademarks and are acknowledged.

**Copyright © 2001
All Rights Reserved
M587 Series, V1.3A
A156T/June 2001**

M587 Mainboard User's Manual

M587 Mainboard User's Manual

Table of Contents

Chapter 1: Introduction.....	1
Key Features.....	2
Package Contents.....	5
Static Electricity Precautions.....	6
Pre-Installation Inspection.....	6
Chapter 2: Mainboard Installation.....	7
Mainboard Components.....	8
Install A CPU.....	9
Install Memory.....	10
Setting Jumper Switches.....	11
Install the Mainboard.....	13
Install the Extension Brackets.....	14
Optional Extension Brackets.....	19
Install Other Devices.....	20
Expansion Slots.....	22
Chapter 3: BIOS Setup Utility.....	23
Introduction.....	23
Running the Setup Utility.....	24
Standard CMOS Setup Page.....	25
Advanced Setup Page.....	26
Power Management Setup Page.....	28
PCI / Plug and Play Setup Page.....	30
Load Optimal Settings.....	31
Load Best Performance Settings.....	31
Features Setup Page.....	31
CPU PnP Setup Page.....	33
Hardware Monitor Page.....	34
Change Password.....	34
Exit.....	35
Chapter 4: Software & Applications.....	37
Introduction.....	37
Installing Support Software.....	37
Auto-installing under Windows 98.....	39
Using the PCI Audio Software.....	41
The Four Speakers System.....	41

M587 Mainboard User's Manual

Chapter 1

Introduction

This mainboard supports all **Socket 7** processors including newer designs which feature a **100 MHz system bus**. The mainboard firmware supports **CPU Plug and Play** so that the system will automatically adopt the correct configuration for the Socket-7 processor that you install.

This mainboard uses the **ALi Art X** chipset which integrates a **3D 128-bit AGP Graphics Accelerator** with **Hardware Geometry Engine** and has an embedded **10BaseT/100BaseTX Ethernet Network Interface**. The mainboard has a built-in **PCI 3D Sound System** and a **V.90 Fax/Modem DAA module** is shipped with the mainboard. In addition, the mainboard has a full set of **I/O Ports** including a keyboard port, a parallel port, a serial port, an audio port, a game/MIDI port and a VGA port. Optional a PS/2 mouse port, two USB ports and an Infrared port can be added using the ATX Form card.

This mainboard has all the features you need to develop a powerful multimedia workstation that is network ready, and has built-in communications. The board is **Baby-AT** form factor and supports both **AT/ATX power supply**. If you use an ATX supply, it supports the ATX power management features including **ACPI** (Advanced Configuration and Power management Interface) and **power saving modes** feature.

M587 Mainboard User's Manual

Key Features

The key features of this mainboard include:

Socket-7 Processor Support

- ◆ Supports all recent socket-7 processors including the Intel **P55C** (Pentium MMX), the Cyrix/IBM **6x86L/6x86MX /MII**, the AMD **K6/K6-2/K6-III**, IDT **C6**, and **WinChip 2/2A** CPUs
- ◆ Supports socket-7 processors with system bus frequencies of **66/100 MHz**
- ◆ **CPU Plug and Play** support lets the firmware automatically configure the CPU

Memory Support

- ◆ Two DIMM slots for 168-pin SDRAM memory modules
- ◆ Support for 66MHz, 100MHz memory bus
- ◆ Maximum installed memory is 2 x 512MB = 1 GB
- ◆ Support Symmetric (128-bit) architecture

Note: For the best performance, please use the same memory size with the same single/double side on the both two DIMM slots

Expansion Slots

- ◆ Two 32-bit PCI slots
- ◆ One 8/16-bit ISA slot

Onboard IDE channels

- ◆ Primary and Secondary PCI IDE channels
- ◆ Support for PIO (programmable input/output) modes
- ◆ Support for Multiword DMA modes
- ◆ Support for Bus Mastering and Ultra DMA 33/66 modes

1: Introduction

Power Supply and Power Management

- ◆ Provides AT/ATX power connector
- ◆ ACPI and previous PMU support, suspend switch
- ◆ Supports Wake on Modem, Wake on LAN and Wake on Alarm

Built-in Graphics System

- ◆ Onboard advanced 128-bit 2D/3D **AGP Graphics Accelerator**
- ◆ Supports **Hardware Geometry Engine**
- ◆ Shared SDRAM memory architecture allows a maximum of 32 MB main memory to act as frame buffer
- ◆ Supports high resolutions up to 1600x1200 and 32-bit color pipeline, up to 2048x2048 Texture size and Virtual screen up to 4096x4096
- ◆ High performance 128-bit 2D GUI/DirectDraw acceleration
- ◆ Video Acceleration for Direct7, DirectShow, MPEG-1, MPEG-2 and Indeo

Sound System

- ◆ Complies with the PC98 audio specification
- ◆ 16-bit CODEC for full-duplex playback and recording
- ◆ HRTF 3D professional audio supports both Direct Sound 3D[®] and A3D[®]-compatible interfaces plus support for **4-channel speakers**
- ◆ Driver support for MS-DOS, Microsoft Windows 95/98/2000/NT 4.0
- ◆ Built-in 32ohm earphone buffer and 3D surround sound
- ◆ Provides MPU-401 Game/MIDI port and legacy Sound Blaster 16 support
- ◆ Downloadable Wave-table Synthesizer supports Direct Music[®]
- ◆ Stereo Mixer supports analog mixing from CD-Audio and Line In

M587 Mainboard User's Manual

Onboard I/O Ports

- ◆ Provides PC99 Color Connectors for easy peripheral device connections
- ◆ Floppy disk drive connector with 1Mb/s transfer rate
- ◆ One serial port with 16550-compatible fast UART
- ◆ One parallel port with ECP and EPP support
- ◆ Optional ATX Form card provides two USB ports, a PS/2 port for mouse and an infrared port

Built-in Ethernet LAN

- ◆ **10BaseT/100BaseTX Ethernet LAN**
- ◆ LAN controller integrates Fast Ethernet MAC and PHY compliant with IEEE802.3u 100BASE-TX, 10BASE-T and ANSI X3.263 TP-PMD standards
- ◆ Compliant with ACPI 1.0 and the Network Device Class Power Management 1.0
- ◆ High Performance provided by 100Mbps clock generator and data recovery circuit for 100Mbps receiver

Fax/Modem DAA Module

- ◆ **56 Kbps Fax/Modem DAA module**
- ◆ Supports V.90, V.34, V.32bis, V.32, V.22bis, V.22
- ◆ Supports Auto Fallback and MNP 5, V.42bis data compression with 115,200-compatible Virtual UART
- ◆ Requires 16MB RAM and Microsoft Windows 95/98/NT

Onboard Flash ROM

- ◆ Automatic CPU and board configuration
- ◆ Supports Plug and Play configuration of peripheral devices and expansion cards
- ◆ Built-in virus protection using **Trend's ChipAwayVirus** provides boot process virus protection.

Bundled Software

- ◆ **PC-Cillin2000** provides automatic virus protection under Windows 95/98/NT/2000
- ◆ **SuperVoice** is data, fax and voice communication software

1: Introduction

- ◆ **MediaRing Talk** provides PC to PC or PC to Phone internet phone communication
- ◆ **3Deep** delivers the precise imagery and displays accurate color in your monitor

Dimensions

- ◆ Baby-AT form factor (22cm x 22cm)

Package Contents

Attention: This mainboard series includes two different models. They are M587LR (LAN Ready), and M587 (without LAN). Please contact your local supplier for your purchase model. Each model will support different specification, list as below:

Model	Specification
M587LR	Onboard LAN header (LAN), LAN chip (U9) and LAN extension bracket
M587	---

Your mainboard package ships with the following items:

- The mainboard
- This User's Guide
- 1 UDMA/33 IDE cable
- 1 Floppy disk drive cable
- Audio ports and Game/MIDI port extension bracket
- Serial/parallel ports extension bracket
- VGA extension bracket
- Support software on CD-ROM disc

Optional Accessories

You can purchase the following optional accessories for this mainboard.

- ATX Form card (2 USB ports, IR port & PS/2 mouse Port)
- UDMA/66 IDE cable
- Fax/Modem DAA module

M587 Mainboard User's Manual

Static Electricity Precautions

Components on this mainboard can be damaged by static electricity. Take the following precautions when unpacking the mainboard and installing it in a system.

1. Keep the mainboard and other components in their original static-proof packaging until you are ready to install them.
2. During installation, wear a grounded wrist strap if possible. If you don't have a wrist strap, discharge static electricity by touching the bare metal of the system chassis.
3. Handle the mainboard carefully by the edges. Avoid touching the components unless it is absolutely necessary. During installation put the mainboard on top of the static-protection packaging it came in with the component side facing up.

Pre-Installation Inspection

1. Inspect the mainboard for damage to the components and connectors on the board.
2. If you suspect that the mainboard has been damaged, do not connect power to the system. Contact your mainboard vendor and report the damage.

Chapter 2

Mainboard Installation

To install this mainboard in a system, follow the procedures in this chapter:

- ❑ Identify the mainboard components
- ❑ Install a CPU
- ❑ Install one or more system memory modules
- ❑ Verify that any jumpers or switches are set correctly
- ❑ Install the mainboard in a system chassis (case)
- ❑ Connect any extension brackets or cables to the mainboard connector headers
- ❑ Install any other devices and make the appropriate connections to the mainboard connector headers.

Note:

1. Before installing this mainboard, make sure jumper JP4 is set to Normal, the default setting is set to Clear CMOS. See this chapter for information on locating JP4 and the setting options.
2. Never connect power to the system during installation. Doing so may damage the mainboard.

M587 Mainboard User's Manual

Mainboard Components

Use the diagram below to identify the major components on the mainboard.

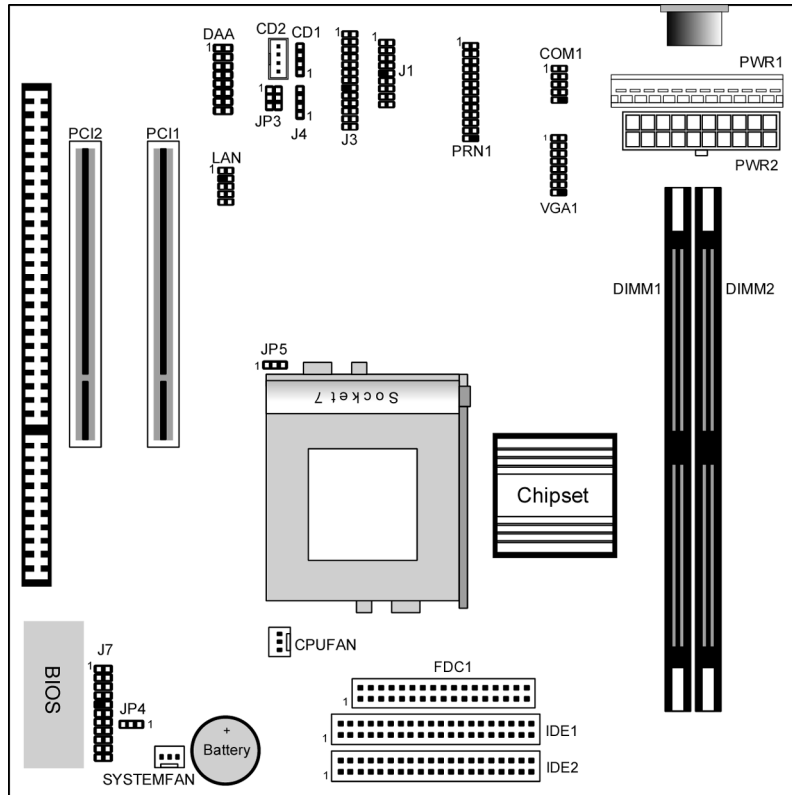

Note: Any jumpers on your mainboard that do not appear in this illustration are for testing only.

2: Mainboard Installation

Install A CPU

This mainboard has a Socket-7 which may be installed with any of the socket-7 processors including the Intel P55C (MMX) series, the Cyrix/IBM 6x86L/6x86MX/MII series, the AMD K6/K6-2/K-III series, the IDT C6/Winchip 2/2A series. The mainboard supports system bus speeds of 66, 100 MHz.

Do not try to install a Socket-370 processor in the Socket-7. A Socket-370 processor such as the PPGA Celeron or FCPGA Pentium III does not fit in the Socket-7.

The board supports CPU plug and play, so the system can automatically run the installed processor with the correct clock speed and the correct system bus frequency. To automatically configure the processor, use the BIOS setup program to select the clock speed and system bus frequency. See chapter three for more information.

To ensure reliability, make sure that your socket-7 processor is fitted with a heatsink/cooling fan assembly.

The socket-7 processor installs into the ZIF (Zero Insertion Force) socket-7 on the mainboard.

1. Locate the Socket-7 and CPUFAN. Pull the locking lever out slightly from the socket and raise it to the upright position.

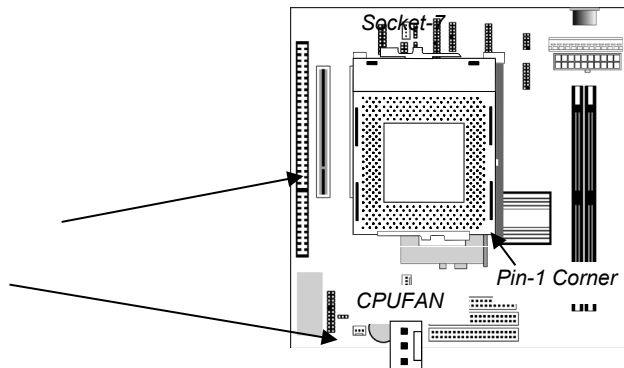

M587 Mainboard User's Manual

2. On the processor, identify the Pin-1 corner by its beveled edge.
3. On the Socket-7, identify the Pin-1 corner. The Pin-1 corner is at the end of the locking lever when it is locked.
4. Match the Pin-1 corners and insert the processor into the socket. No force is required and the processor should drop into place freely.
5. Swing the locking lever down and hook it under the catch on the side of the socket. This secures the CPU in the socket.
6. All processors should be installed with a combination heatsink/cooling fan, connect the cable from the fan to the CPU fan power connector CPUFAN.

Install Memory

The mainboard has two DIMM sockets for system memory modules. You must install at least one memory module in order to use the mainboard.

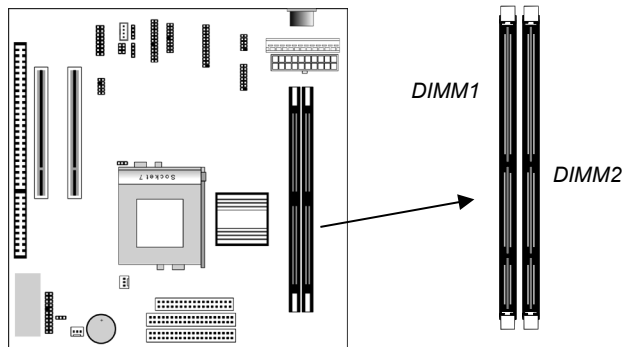

For this mainboard, you must use 168-pin, 3.3V unbuffered SDRAM memory modules. If the installed CPU uses a 100 MHz system bus, you must use PC100 memory. If the installed CPU uses a 66 MHz system bus, you must use PC66 memory. You can install any size memory module from 16 MB to 512MB, so the maximum memory size is $2 \times 512\text{MB} = 1\text{GB}$.

The edge connectors on the memory modules have cut outs, which coincide with spacers in the DIMM sockets so that memory modules can only be installed in the correct orientation.

2: Mainboard Installation

To install a module, push the retaining latches at either end of the socket outwards. Position the memory module correctly and insert it into the DIMM socket. Press the module down into the socket so that the retaining latches rotate up and secure the module in place by fitting into notches on the edge of the module.

Setting Jumper Switches

Jumpers are sets of pins which can be connected together with jumper caps. The jumper caps change the way the mainboard operates by changing the electronic circuits on the mainboard. If a jumper cap connects two pins, we say the pins are **SHORT**. If a jumper cap is removed from two pins, the pins are **OPEN**.

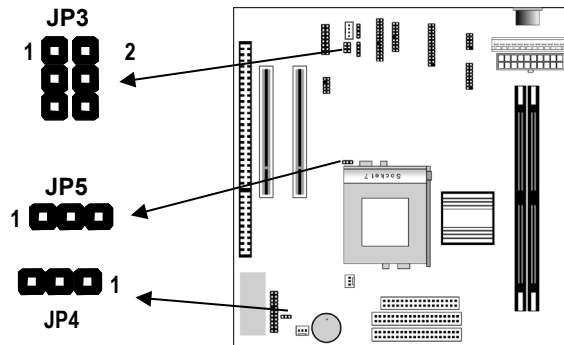

Jumper JP3: Fax/Modem & Audio System Enable/disable

This jumper has two sets of three pins. The right (pins 2-4-6) is used to enable or disable the onboard Fax/Modem. The left (pins 1-3-5) is used to enable or disable the onboard audio system.

Function	Jumper Setting
Enable onboard Fax/Modem	Short Pins 2-4
Disable onboard Fax/Modem	Short Pins 4-6

Function	Jumper Setting
Enable onboard audio	Short Pins 1-3
Disable onboard audio	Short Pins 3-5

M587 Mainboard User's Manual

Note: If you use the left set of pins to disable the onboard audio system, the Fax/Modem is disabled, even if you have set the right set of pins to the enable Fax/Modem setting.

Jumper JP4: Clear CMOS Memory

Use this jumper to clear the contents of the CMOS memory. You may need to clear the CMOS memory if the settings in the Setup Utility are incorrect and prevent your mainboard from operating. To clear the CMOS memory, disconnect all the power cables from the mainboard and then move the jumper cap into the CLEAR setting for a few seconds.

Function	Jumper Setting
Normal Operation	Short Pins 1-2
Clear CMOS Memory	Short Pins 2-3

Jumper JP5: LAN Enable/disable

This mainboard has a built-in 10BaseT/100BaseTX network adapter. If you plan on using an alternative network adapter, you must use this jumper to disable the onboard network adapter.

Function	Jumper Setting
Enable onboard LAN	Short Pins 1-2
Disable onboard LAN	Short Pins 2-3

2: Mainboard Installation

Install the Mainboard

Install the mainboard in a system chassis (case). The board is a baby-AT size mainboard. However, the board supports an AT and an ATX power supply so you can use either an AT or ATX system case. If you use an AT case, some of the ATX power management features might not function.

Install the mainboard in a case. Follow the instructions provided by the case manufacturer using the hardware and internal mounting points on the chassis.

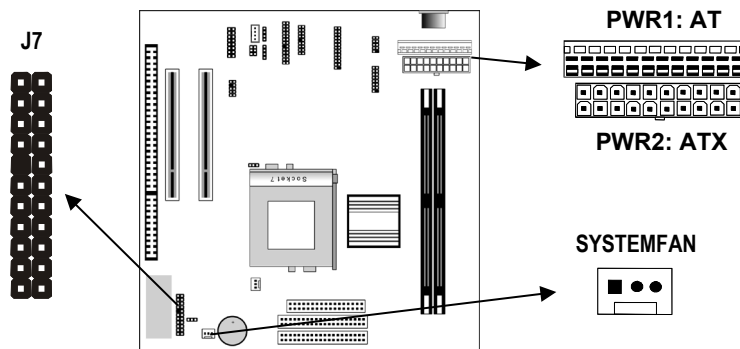

If you are using a case with an ATX power supply, connect the power cable from the ATX power supply unit to the power connector **PWR2** on the mainboard.

If you are using a case with an AT power supply, connect the power cable from the AT power supply unit to the power connector **PWR1** on the mainboard.

If there is a cooling fan installed in the system chassis, connect the cable from the cooling fan to the **SYSTEMFAN** fan power connector on the mainboard.

Connect the case switches and indicator LEDs to the **J7** switch and LED connector header.

M587 Mainboard User's Manual

See the illustration below for a guide to the J7 connector pin assignments.

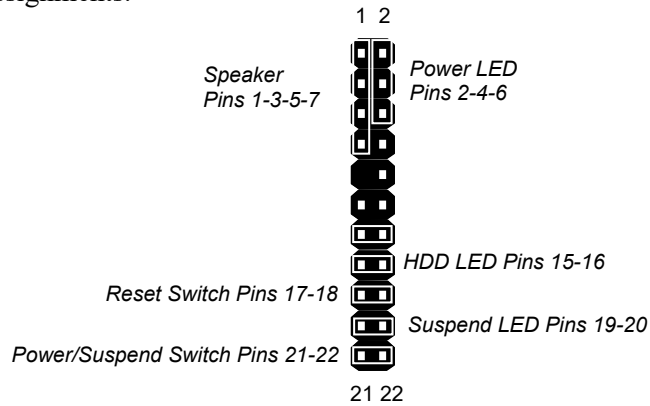

Install the Extension Brackets

The extension brackets are used to connect features on the mainboard to external connectors that can be attached to the system chassis. Follow the steps below to install the extension brackets.

Note: All the ribbon cables used on the extension brackets have a red stripe on the Pin-1 side of the cable.

VGA Extension Bracket

The VGA extension bracket has a 15-pin connector for an external monitor cable.

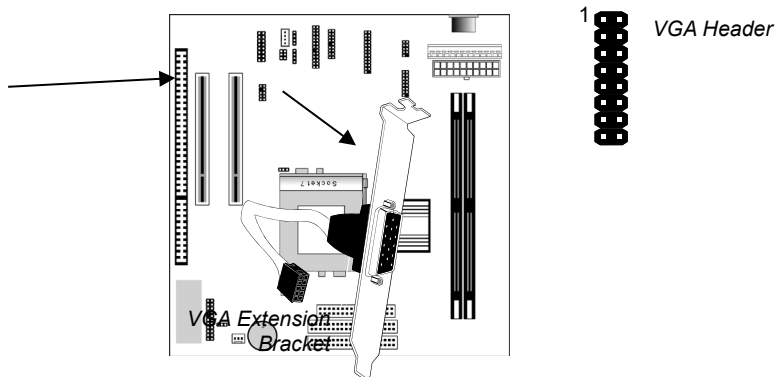

2: Mainboard Installation

1. On the mainboard, locate the VGA header for this bracket.
2. Plug the cable from the bracket into the VGA header.
3. In the system chassis, remove a blanking plate from one of the expansion slots and install the extension bracket in the slot. Use the screw that held the blanking plate in place to secure the extension bracket.

Fax/Modem Module

The Fax/Modem DAA module plugs directly into the mainboard in line with to an expansion slot opening in the system chassis. When you remove the slot cover from the system chassis, you can access the LINE and TEL RJ11 connectors on the metal edge of the Fax/Modem DAA module.

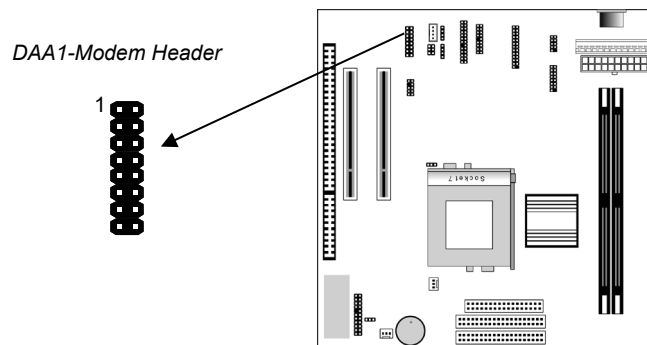

1. Locate the Modem header on the mainboard.
2. Plug the Fax/Modem DAA module into the Modem header.
3. Remove the modem header slot cover.

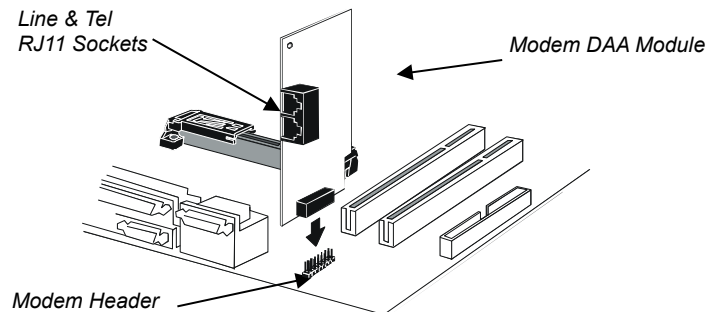

M587 Mainboard User's Manual

Audio Ports and Game/MIDI Port Extension Bracket

This bracket provides three audio jacks for stereo line in, stereo line out and microphone. In addition it has a 15-pin D-connector which can be used by either a joystick or a MIDI device.

If you are using a four channel speakers system, channel one and two are output through the Stereo Line-out, and the rear speaker channels three and four are output through Stereo Line-in.

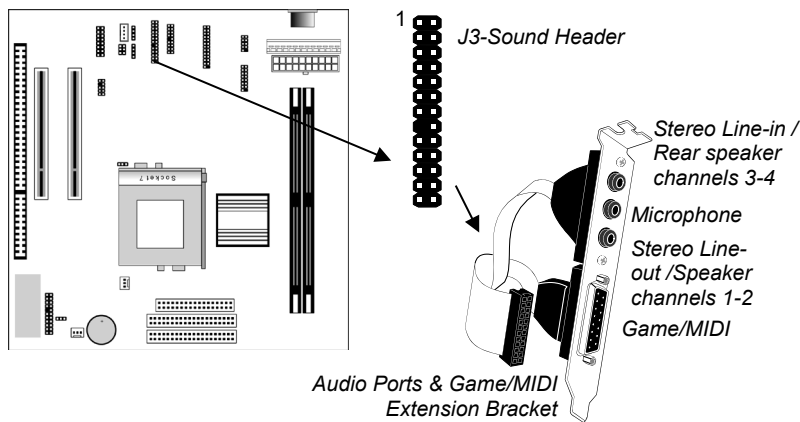

1. On the mainboard, locate the Sound header for this bracket.
2. Plug the cable from the bracket into the header.
3. In the system chassis, remove a blanking plate from one of the expansion slots and install the extension bracket in the slot. Use the screw that held the blanking plate in place to secure the extension bracket.

2: Mainboard Installation

Serial/Parallel Ports Extension Bracket

This bracket has one serial port - COM1 (9-pins) and one parallel port - LPT1 (25pins).

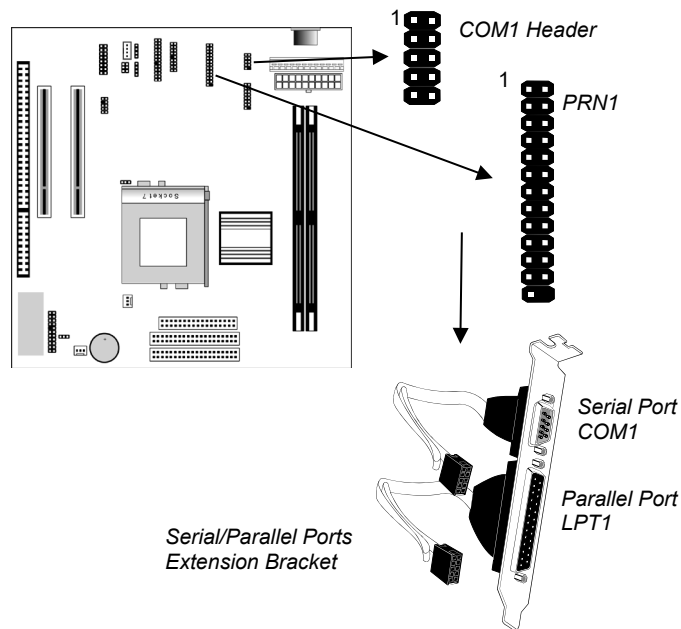

1. On the mainboard, locate the headers COM1 and PRN1 for this bracket.
2. Plug the serial cable into COM1 and the parallel cable into PRN1.
3. In the system chassis, remove a blanking plate from one of the expansion slots and install the extension bracket in the slot. Use the screw that held the blanking plate in place to secure the extension bracket.

M587 Mainboard User's Manual

LAN Network Adapter Extension Bracket

This bracket supports an RJ45 network connector and connects to the built in LAN header on the mainboard.

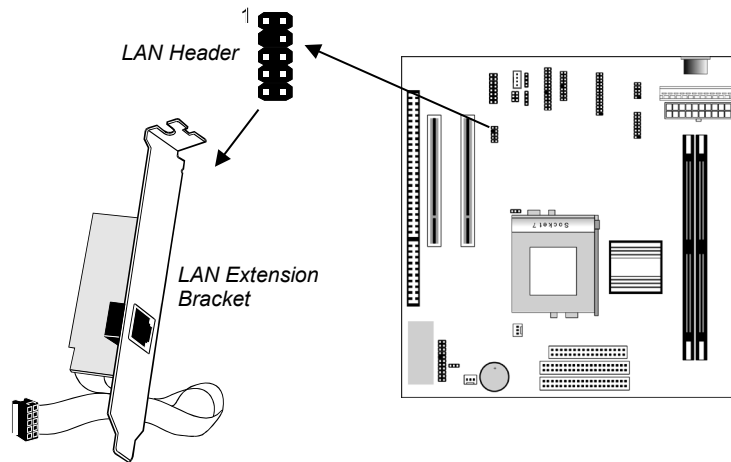

1. On the mainboard, locate the LAN header for this bracket.
2. Plug the cable from the bracket into the LAN header.
3. In the system chassis, remove a blanking plate from one of the expansion slots and install the extension bracket in the slot. Use the screw that held the blanking plate in place to secure the extension bracket.

2: Mainboard Installation

Optional Extension Brackets

For this mainboard, you can also obtain an ATX Form card. Install them by following the steps below.

ATX Form Card

This ATX Form card provides a mini-DIN port for infrared, one mini-DIN port for a PS/2 mouse. In addition it has two USB (Universal Serial Bus) ports.

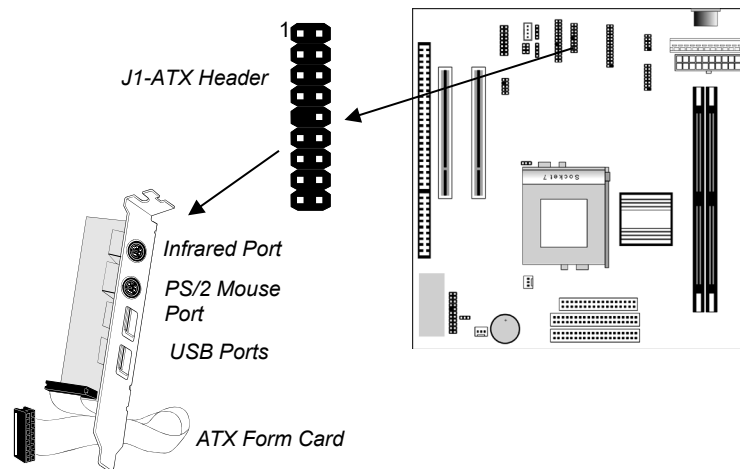

1. On the mainboard, locate the ATX header for this bracket.
2. Plug the cable from the bracket into the ATX header.
3. In the system chassis, remove a blanking plate from one of the expansion slots and install the extension bracket in the slot. Use the screw that held the blanking plate in place to secure the extension bracket.

Install Other Devices

Install and connect any other devices in the system following the steps below.

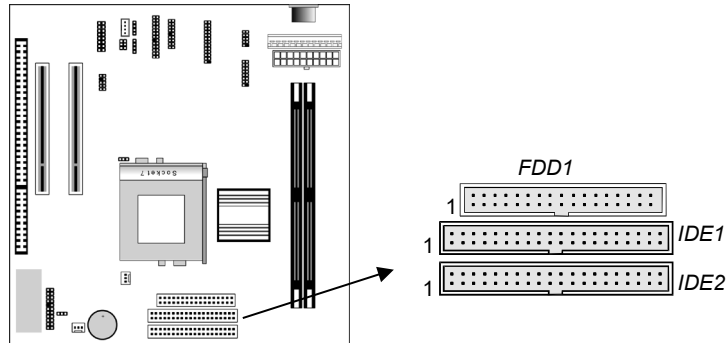

Floppy Disk Drive

The mainboard ships with a floppy disk drive cable that can support one or two drives. Drives can be 3.5" or 5.25" wide, with capacities of 360K, 720K, 1.2MB, 1.44MB, or 2.88MB.

Install your drives and connect power from the system power supply. Use the cable provided to connect the drives to the floppy disk drive header **FDD1**.

IDE Devices

IDE devices include hard disk drives, high-density diskette drives, and CD-ROM or DVD-ROM drives, among others.

The mainboard ships with an IDE cable that can support one or two IDE devices. If you connect two devices to a single cable, you must configure one of the drives as Master and one of the drives as Slave. The documentation of the IDE device will tell you how to configure the device as a Master or Slave device. The Master device connects to the end of the cable.

Install the device(s) and connect power from the system power supply. Use the cable provided to connect the device(s) to the Primary IDE channel connector **IDE1** on the mainboard.

If you want to install more IDE devices, you can purchase a second IDE cable and connect one or two devices to the Secondary IDE channel connector **IDE2** on the mainboard. If you have two devices on the cable, one must be Master and one must be Slave.

2: Mainboard Installation

Internal Sound Connections

If you have installed a CD-ROM drive or DVD-ROM drive, you can connect the drive audio cable to the onboard sound system. On the mainboard, locate the two 4-pin connectors CD1 and CD2. There are two kinds of connector because different brands of CD-ROM drive have different kinds of audio cable connectors. Connect the cable to the appropriate connector.

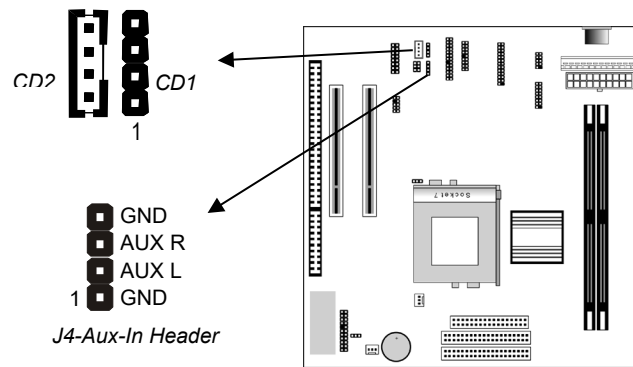

Aux-In Connection

If you have installed a secondary CD-ROM drive or DVD-ROM drive, you can connect the drive audio cable to the onboard sound system. On the mainboard, locate the 4-pin Aux-In header, connect the cable to the connector.

M587 Mainboard User's Manual

Expansion Slots

This mainboard has two 32-bit PCI expansion slots and one 8/16-bit ISA slot. The PCI slot PCI2 is shared with the ISA slot ISA1. It means that you can use either one of shared both but you cannot use the both at the same time.

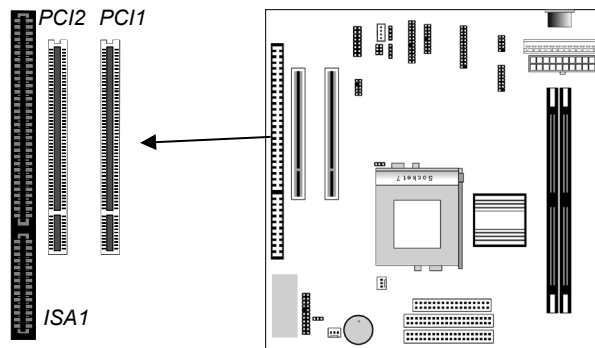

Follow the steps below to install a PCI or ISA expansion card.

1. Select a free PCI or ISA slot on the mainboard.
2. Remove the slot cover for the expansion slot from the system chassis.
3. Insert the expansion card edge connector into the slot and press it firmly down into it so that it is fully inserted.
4. Secure the expansion card bracket to the system chassis using the screw that held the slot cover in place.

Chapter 3

BIOS Setup Utility

Introduction

The BIOS Setup Utility records settings and information about your computer such as the date and time, the kind of hardware installed, and various configuration settings. Your computer uses this information to initialize all the components when booting up and functions as the basis for coordination between system components.

If the Setup Utility configuration is incorrect, it may cause the system to malfunction. It can even stop your computer from booting properly. If this happens, you can use the clear CMOS jumper to clear the CMOS memory used to store the configuration information, or you can hold down the **Page Up** key while you reboot your computer. Holding down the **Page Up** key also clears the CPU PnP Setup information, you may need to set the CPU speed again.

You can run the setup utility and manually make changes to the configuration. You might need to do this to configure some of the hardware that you install on or connect to the mainboard, such as the CPU, system memory, disk drives, etc.

M587 Mainboard User's Manual

Running the Setup Utility

Each time your computer starts, before the operating system loads, a message appears on the screen that prompts you to “Hit if you want to run SETUP”. When you see this message, press the **Delete** key and the Main menu page of the Setup Utility appears on your monitor.

AMIBIOS SIMPLE SETUP UTILITY – VERSION 1.20 ©1999 American Megatrends, Inc. All Rights Reserved			
Standard CMOS Setup		Features Setup	
Advanced Setup		CPU PnP Setup	
Power Management Setup		Hardware Monitor	
PCI / Plug and Play Setup		Change Password	
Load Optimal Settings		Exit	
Load Best Performance Settings			
ESC: Quit	↑↓←→: Select Item	(Shift)F2: Change Color	F5: Old Values
F6: Optimal values	F7: Best performance values		F10: Save&Exit

You can use the cursor arrow keys to highlight any of the options on the main menu page. Press **Enter** to select the highlighted option. To leave the setup utility, press the **Escape** key. To cycle through the Setup Utility's optional color schemes hold down the **Shift** key and press **F2**.

Some of the options on the main menu page lead to tables of items with installed values. In these pages, use the cursor arrow keys to highlight the items, and then use the **PgUp** and **PgDn** keys to cycle through the alternate values for each of the items. Other options on the main menu page lead to dialog boxes which require you to answer Yes or No by hitting the **Y** or **N** keys.

If you have already made changes to the setup utility, press **F10** to save those changes and exit the utility. Press **F5** to reset the changes to the original values. Press **F6** to install the setup utility with a set of default values. Press **F7** to install the setup utility with a set of high-performance values.

3: BIOS Setup Utility

Standard CMOS Setup Page

Use this page to set basic information such as the date and time, the IDE devices, and the diskette drives. If you press the F3 key, the system will automatically detect and configure the hard disks on the IDE channels.

AMIBIOS SETUP – STANDARD CMOS SETUP									
©1999 American Megatrends, Inc. All Rights Reserved									
Date (mm/dd/yy) : Tue May 16, 2000									
Time (hh/mm/ss) : 14:26:53									
	Type	Size	Cyln	Head	WPcom	LBA	Blk	PIO	32Bit
					Sec	Mode	Mode	Mode	Mode
Pri Master	: Auto								On
Pri Slave	: Auto								On
Sec Master	: Auto								On
Sec Slave	: Auto								On
Floppy Drive A : 1.44MB 3 1/2"									
Floppy Drive B : Not Installed									
Month : Jan – Dec						ESC : Exit			
Day : 01 – 31						↑↓ : Select Item			
Year : 1901 – 2099						PU/PD/+/- : Modify			
						(Shift)F2 : Color			
						F3 : Detect All HDD			

Date & Time	Use these items to set the system date and time
Pri Master	Use these items to configure devices connected to the Primary and Secondary IDE channels. To configure an IDE hard disk drive, choose <i>Auto</i> . If the <i>Auto</i> setting fails to find a hard disk drive, set it to <i>User</i> , and then fill in the hard disk characteristics (Size, Cyls, etc.) manually. If you have a CD-ROM drive, select the setting <i>CDROM</i> . If you have an ATAPI device with removable media (e.g. a ZIP drive or an LS-120) select <i>Floptical</i> .
Pri Slave	
Sec Master	
Sec Slave	
Floppy Drive A Floppy Drive B	Use these items to set the size and capacity of the floppy diskette drive(s) installed in the system.

M587 Mainboard User's Manual

Advanced Setup Page

Use this page to set more advanced information about your system. Take some care with this page. Making changes can affect the operation of your computer.

AMIBIOS SETUP – ADVANCED SETUP ©1999 American Megatrends, Inc. All Rights Reserved		
Trend ChipAway Virus	Enabled	
Share Memory Size	8MB	
1 st Boot Device	IDE-0	
2 nd Boot Device	Floppy	
3 rd Boot Device	CDROM	
Try Other Boot Devices	Yes	
S.M.A.R.T. for Hard Disks	Disabled	
BootUp Num-Lock	On	
Floppy Drive Swap	Disabled	
Floppy Drive Seek	Disabled	
PS/2 Mouse Support	Enabled	
Password Check	Setup	
Boot To OS/2 > 64MB	No	
Internal Cache	Enabled	
System BIOS Cacheable	Enabled	
DRAM Driving Current	Auto	
SDRAM CAS Latency	3 Clock	
		ESC : Quit ↑↓←→ : Select Item F1 : Help PU/PD/+/- : Modify F5 : Old Values (Shift)F2 : Color F6 : Load Optimal values F7 : Load Best performance values

Trend ChipAway Virus	This mainboard has built-in virus protection in the firmware. Use this item to enable or disable the built-in virus protection.
Share Memory Size	This item lets you allocate a portion of the main memory for use by the onboard VGA display.
1st Boot Device 2nd Boot Device 3rd Boot Device	Use these items to determine the device order the computer uses to look for an operating system to load at start-up time.
Try Other Boot Device	If you enable this item, the system will also search for other boot devices if it fails to find an operating system from the first three locations.
S.M.A.R.T. for Hard Disks	Enable this item if any IDE hard disks support the S.M.A.R.T. (Self-Monitoring, Analysis and Reporting Technology) feature.
BootUp Num-Lock	This items determines if the Num Lock key is active or inactive at system start-up time.
Floppy Drive Swap	If you have two diskette drives installed and you enable this item, drive A becomes drive B and drive B becomes drive A.

3: BIOS Setup Utility

Floppy Drive Seek	If you enable this item, your system will check all floppy disk drives at start up. Disable this item unless you are using an old 360KB drive.
PS/2 Mouse Support	If this item is set to Enabled, the onboard PS/2 Mouse port will work. Setting this to Disable turns off the port.
Password Check	If you have entered a password for the system, use this item to determine if the password is required to enter the Setup Utility (<i>Setup</i>) or required both at start-up and to enter the Setup Utility (<i>Always</i>).
Boot to OS/2 > 64MB	Enable this item if you are booting the OS/2 operating system and you have more than 64MB of system memory installed.
Internal Cache	Leave this item enabled since all the processors that can be installed on this board have internal cache memory.
System BIOS Cacheable	If you enable this item, a segment of the system BIOS will be cached to main memory for faster execution.
DRAM Driving Current	Setting the driving current for the used DRAM by this item. The <i>Auto</i> setting is recommended.
SDRAM CAS Latency	This item determines the operation of the SDRAM memory CAS (column address strobe). We recommend that you leave this item at the default value. The 2T setting requires faster memory that specifically supports this mode.

M587 Mainboard User's Manual

Power Management Setup Page

This page sets some of the parameters for system power management operation.

AMIBIOS SETUP – POWER MANAGEMENT SETUP	
©1999 American Megatrends, Inc. All Rights Reserved	
Power Management/APM	Disabled
Standby Time Out	Disabled
Suspend Time Out	Disabled
Ring On Power On	Disabled
LAN Card Power On	Disabled
RTC Alarm Power On	Disabled
RTC Alarm Date	15
RTC Alarm Hour	12
RTC Alarm Minute	30
RTC Alarm Second	30

ESC : Quit ↑↓←→ : Select Item
F1 : Help PU/PD/+/- : Modify
F5 : Old Values (Shift)F2 : Color
F6 : Load Optimal values
F7 : Load Best performance values

Power Management/APM	Use this item to enable or disable a power management scheme. If you enable power management, you can use the items below to set the power management operation. Both APM and ACPI are supported.
Standby Time Out	This sets the timeout for Standby mode in minutes. If the time selected passes without any system activity, the computer will enter power-saving Standby mode.
Suspend Time Out	This sets the timeout for Suspend mode in minutes. If the time selected passes without any system activity, the computer will enter power-saving Suspend mode.
Ring On Power On	The system can be turned off with a software command. If you enable this item, the system can automatically resume if there is an incoming call on the Fax/Modem. You must use an ATX power supply in order to use this feature.

3: BIOS Setup Utility

LAN Card Power On	The system can be turned off with a software command. If you enable this item, the system can automatically resume if there is traffic on the network adapter. You must use an ATX power supply in order to use this feature.
RTC Alarm Power On /Date /Hour /Minute /Second	The system can be turned off with a software command. If you enable this item, the system can automatically resume at a fixed time based on the system's RTC (realtime clock). Use the items below this one to set the date and time of the wake-up alarm. You must use an ATX power supply in order to use this feature.

M587 Mainboard User's Manual

PCI / Plug and Play Setup Page

This page sets some of the parameters for devices installed on the PCI bus and devices that use the system plug and play capability.

AMBIOS SETUP – PCI / PLUG AND PLAY SETUP	
©1999 American Megatrends, Inc. All Rights Reserved	
Plug and Play Aware O/S	Yes
Primary Graphics Adapter	OnBoard AGP
Assign IRQ for VGA	Yes
Reserved Memory Size	Disabled
Reserved Memory Address	C8000
ESC : Quit ↑↓←→ : Select Item F1 : Help PU/PD/+/- : Modify F5 : Old Values (Shift)F2 : Color F6 : Load Optimal values F7 : Load Best performance values	

Plug and Play Aware O/S	Enable this item if you are using an O/S that supports Plug and Play such as Windows 95 or 98.
Primary Graphics Adapter	This item indicates if the primary graphics adapter uses the PCI or the AGP bus. The default PCI setting still lets the onboard display work and allows the use of a second display card installed in a PCI slot.
Assign IRQ for VGA	If this item is enabled, an IRQ will be assigned to the PCI VGA graphics system. You set this value to No to free up an IRQ.
Reserved Memory Size	This item lets you reserve a block of memory for any device that requires it.
Reserved Memory Address	This item lets you set the address for any block of memory that has been reserved.

3: BIOS Setup Utility

Load Optimal Settings

If you select this item and press **Enter** a dialog box appears. If you press **Y**, and then **Enter**, the Setup Utility loads a set of fail-safe default values. These default values are not very demanding and they should allow your system to function with most kinds of hardware and memory chips.

Load Best Performance Settings

If you select this item and press **Enter** a dialog box appears. If you press **Y**, and then **Enter**, the Setup Utility loads a set of best-performance default values. These default are quite demanding and your system might not function properly if you are using slower memory chips or other low-performance components.

Features Setup Page

This page sets some of the parameters for peripheral devices connected to the system.

AMIBIOS SETUP – FEATURES SETUP ©1999 American Megatrends, Inc. All Rights Reserved		
OnBoard FDC	Enabled	
OnBoard Serial Port	3F8h/COM1	
OnBoard Ir Port	Disabled	
Ir Port Mode	N/A	
Ir Port IRQ	N/A	
Ir Port DMA	N/A	
Ir Transceiver Type	N/A	
Ir Half-Duplex TimeOut	N/A	
OnBoard Parallel Port	378h	
Parallel Port Mode	Normal	
EPP Version	N/A	
Parallel Port IRQ	7	
Parallel Port DMA	N/A	
OnBoard IDE	Both	
Ultra DMA Support	Disabled	
OnBoard USB Function	Disabled	ESC : Quit ↑↓←→ : Select Item
USB Function for DOS	Disabled	F1 : Help PU/PD/+/- : Modify
OnBoard Sound	Enabled	F5 : Old Values (Shift)F2 : Color
OnBoard Modem	Enabled	F6 : Load Optimal values
		F7 : Load Best performance values

OnBoard FDC	Use this item to enable or disable the onboard floppy disk drive interface.
--------------------	---

M587 Mainboard User's Manual

OnBoard Serial Port	Use this item to enable or disable the onboard COM1 serial port, and to assign a port address
OnBoard Ir Port	Use this item to define the protocol for an infrared port if you have installed an optional IR port. The choices are IrDA and ASKIR.
Ir Port Mode Ir Port IRQ Ir Port DMA Ir Transceiver ... Ir Half-Duplex ...	Use these items to define the settings for an infrared port if you have installed an optional IR port.
Onboard Parallel Port	Use this item to enable or disable the onboard LPT1 parallel port, and to assign a port address. The Auto setting will detect and available address.
Parallel Port Mode	Use this item to set the parallel port mode. You can select SPP (Standard Parallel Port), ECP (Extended Capabilities Port), EPP (Enhanced Parallel Port), or ECP + EPP.
EPP Version	Use this item to set the version of EPP while the parallel port mode is set to EPP.
Parallel Port IRQ	Use this item to assign either IRQ 5 or 7 to the parallel port.
Parallel Port DMA	Use this item to assign a DMA channel to the parallel port. The options are 0, 1 and 3.
Onboard IDE	Use this item to enable or disable either or both of the onboard Primary and Secondary IDE channels.
Ultra DMA Support	Use this item to set Ultra DMA support for IDE devices on the Primary or Secondary IDE channels. You must enable this or UDMA devices will not work at their intended speed.
OnBoard USB Function	Enable this item if you plan to use the USB ports on this mainboard.
USB Function for DOS	Enable this item if you plan to use the USB ports on this mainboard in a DOS environment.
Onboard Sound	Use this item to enable or disable the onboard audio chip.
Onboard Modem	Use this item to enable or disable the onboard modem chip.

3: BIOS Setup Utility

CPU PnP Setup Page

This page lets you manually configure the mainboard for the CPU. The system will automatically detect the kind of CPU that you have installed and make the appropriate adjustments to the items on this page.

Note: If you manually set the wrong speed and the system won't run properly, press the **Page Up** key while the system is booting and a default setting will replace the incorrect CPU setting.

AMIBIOS SETUP – CPU PnP SETUP	
©1999 American Megatrends, Inc. All Rights Reserved	
CPU Plug and Play	Auto
CPU Brand	
CPU Speed	450 MHz
VCCore Voltage	2.0V
CPU Base Frequency	100 MHz
CPU Multiple Factor	X4.5
ESC : Quit ↑↓←→ : Select Item F1 : Help PU/PD/+/- : Modify F5 : Old Values (Shift)F2 : Color F6 : Load Optimal values F7 : Load Best performance values	

CPU Plug and Play	Use this item to select the CPU Plug and Play function by auto-detect or user-define.
CPU Brand; VCCore Voltage	These items display the CPU brand and CPU core voltage by the system automatic detecting.
CPU Speed	The item displays the internal clock speed of the CPU, based on the next two items.
CPU Base Frequency	Use this item to set the external clock frequency for the CPU. Set the CPU clock based on the requirements of the CPU installed on the board.
CPU Multiple Factor	Use this item to set a multiplier for the CPU external frequency. The multiplier times the external CPU frequency sets the internal clock speed of the CPU, e.g. 100 MHz (external clock or "FSB") x 4.5 (multiplier) = 450 MHz (internal clock speed of the installed CPU).

M587 Mainboard User's Manual

Hardware Monitor Page

This page sets some of the parameters for the hardware monitoring function of this mainboard.

AMIBIOS SETUP – HARDWARE Monitor	
©1999 American Megatrends, Inc. All Rights Reserved	
--- Hardware Monitor ---	
System Temperature	30°C/86°F
CPU Temperature	30°C/86°F
System Fan	
CPU Fan	
Vcc	5.000 V
Vcc3	3.300 V
Vcore	2.000 V
+12V	12.000 V
ESC : Quit ↑↓←→ : Select Item	
F1 : Help PU/PD/+/- : Modify	
F5 : Old Values (Shift)F2 : Color	
F6 : Load Optimal values	
F7 : Load Best performance values	

CPU / System Temperature	These items display CPU/system temperature measurement.
FAN Speeds & Voltage Measurements	These items indicate cooling fan speeds in RPM and the various system voltage measurements.

Change Password

If you highlight this item and press **Enter**, a dialog box appears which lets you enter a Supervisor password. You can enter no more than six letters or numbers. Press **Enter** after you have typed in the password. A second dialog box asks you to retype the password for confirmation. Press **Enter** after you have retyped it correctly. The password is then required to access the Setup Utility or for that and at start-up, depending on the setting of the Password Check item in Advanced Setup.

3: BIOS Setup Utility

Change or Remove the Password

Highlight this item, press Enter and type in the current password. At the next dialog box, type in the new password, or just press Enter to disable password protection.

Exit

Highlight this item and press **Enter** to save the changes that you have made in the Setup Utility configuration and exit the program. When the Save and Exit dialog box appears, press **Y** to save and exit, or press **N** to exit without saving.

AMIBIOS SIMPLE SETUP UTILITY - VERSION 1.20			
(C)1998 American Megatrends, Inc. All Rights Reserved			
Standard CMOS Setup		Features Setup	
Advanced Setup		CPU PnP Setup	
Power Management Setup		Hardware Monitor	
PCI / Plug an			
Load Optimal			
Load Best Per			
Save current settings and exit (Y/N) ? Y			
ESC: Quit	↑↓←→: Select Item	(Shift)F2: Change Color	F5: Old Values
F6: Optimal values	F7: Best performance values		F10: Save&Exit
Exit Or, Save CMOS setting and exit			

Chapter 4

Software & Applications

Introduction

The support software CD-ROM that is included in the mainboard package contains all the drivers and utility programs needed to properly run our products. Below you can find a brief description of each software program, and the location for your mainboard version. More information on some programs is available in a README file, located in the same directory as the software.

If the operating system used in your system is Windows 98, it will automatically install all the drivers and utilities for your board. See the Auto-Installing under Windows 98 section.

Installing Support Software

The software on the support CD-ROM is for Windows 95/NT/2000 and Windows 98. The installation procedure differs depending on which Operating System you have, but the automatic installation is now for Win98 only.

Installing under Windows 95/NT/2000

To install support software for Windows 95/NT/2000 follow this general procedure:

1. Insert the support CD-ROM disc in the CD-ROM drive.
(The system might get an error message from the PnP function. Don't care the message. You don't really need that file to install the drivers)
2. Use My Computer or Windows Explorer to look at the directory structure. You must use the Open command in the right-button menu. Double-clicking on the drive icon will result in an error message because the disc's AutoRun feature doesn't work in Windows 95/NT/2000.
3. Execute the EXE file name given in the description below.

M587 Mainboard User's Manual

*Note: The correct path name for each software driver is provided, where **D:** identifies the CD-ROM drive letter – modify if necessary.*

Bus Master IDE Driver

The IDE Bus Master Drivers allow the system to properly manage the IDE channels on the mainboard. This driver is available for:

- ◆ Win9x – D:\IDE\Artx\

Audio Driver

The Sound driver allows the system to generate optimal sound effects. The Audio driver and applications are available for:

- ◆ D:\SOUND\Driver\C-Media\

Display Drivers and Software

Find the Display drivers and software here:

- ◆ D:\VGA\Artx\

Fax/Modem Drivers and Software

Find the fax/modem drivers and software here:

- ◆ D:\Modem\Driver\9xNT
- ◆ D:\Modem\SuperVoice\ [Telecom management software]
- ◆ D:\Modem\MediaRing Talk

Network Adapter Driver

Find the network interface driver here:

- ◆ D:\LAN\SiS900

USB Driver

The USB Driver allows the system to recognize the USB ports on the mainboard. You need to install this driver if you are running Windows 95. Windows 95 OSR2 does not require this driver.

This driver is available for:

- ◆ Win95 – D:\USB\EUSBSUPP\USBSUPP.EXE
- ◆ Win95 (Chinese) – D:\USB\CUSBSUPP\CUSBSUPP.EXE

3Deep Software

Find the software here:

- ◆ D:\3Deep\3Deep 3.3\Setup.EXE

4: Software & Applications

BIOS Update Utility

The BIOS Update utility allows you to update the BIOS file on the mainboard to a newer version. You can download the latest version of the BIOS setup available for your mainboard from the website.

- ◆ D:\UTILITY\AMINFxxx.EXE

PC-Cillin Software

The PC-cillin software program provides anti-virus protection for your system. Find the software here:

- ◆ D:\PC-CILLIN\

Auto-installing under Windows 98

The support software CD-ROM disc loads automatically under Windows 98. When you insert the CD-ROM disc in the system CD-ROM drive the Autorun feature will automatically bring up the install screen. The screen has three buttons on it, Setup, Browse CD and Exit. See the following screen illustration.

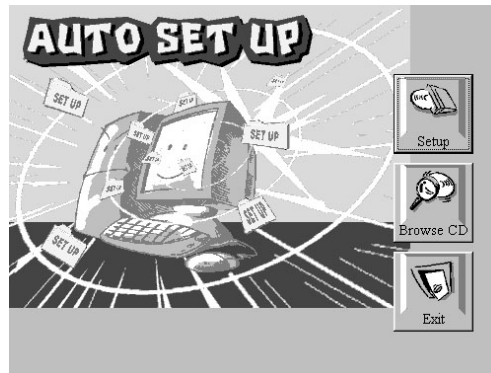

When you click on the **Setup** button the software installation program will run and you can select what kind of installation you want to do, as explained later in this section.

The **Browse CD** button is the standard Windows command that allows you to examine the contents of the disc using the Windows 98 file browsing interface.

M587 Mainboard User's Manual

The **Exit** button closes the Auto Setup window. To run the program again, reinsert the CD-ROM disc in the drive or click on AutoRun in the context sensitive menu for the CD-ROM drive icon in a file browser window.

Installing Software with Auto Setup

To install support software for the system board follow this procedure:

1. Click on the **Setup** button. The install program will load and display the following screen. Click the **Next** button.



2. Select the items that you want to setup by clicking on it (the default options are recommended). Click the **Next** button to proceed.

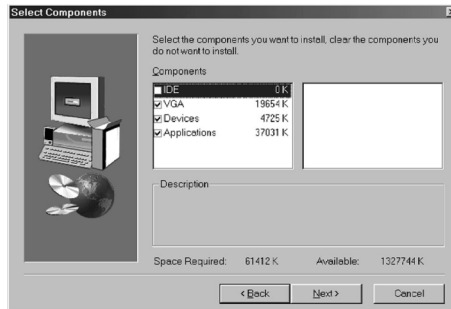

3. The support software will automatically install.

Once any of the installation procedures start, software is automatically installed in sequence. You will need to follow the onscreen instructions, confirm commands and allow the computer to restart as few times as is needed to complete installing whatever

4: Software & Applications

software you selected to install. When the process is finished, all the support software will be installed and working.

There are some utilities that you have to manually install if you need, check to the above section.

Using the PCI Audio Software

1. Before you install the PCI Sound Pro drivers, make sure your Operating System has been installed, otherwise the onboard PCI audio might be detected as an “Other device” by the OS device manager.
2. After the drivers are properly installed, choose the MULTIMEDIA icon in the CONTROL PANEL when you need to use the Software Wave-Table drivers as a MIDI output device. Select the MIDI tab and click on “C-media SoftMidi Synthesis (Win98) / Driver (Win95)”, then click “OK” to confirm.
3. A Windows application named Audio Rack is provided with the PCI Sound Pro drivers, which gives you control over all the audio functions through a user interface that is as simple to use as a home stereo system. We recommend that you use the Audio Rack’s System Mixer to control your computer’s audio volume, recording devices and recording gain.
4. If the devices you are using require the MIDI port as the control interface, you need to select the MULTIMEDIA icon in the CONTROL PANEL. Select the MIDI tab and click on “CM8738 MPU-401” (Win98) or “CM8738/C3DX PCI Audio External MIDI Port” (Win95), and then click “OK” to confirm.
5. For more information, refer to the PCI Sound Pro manual on the CD that ships with this mainboard.

The Four Speakers System

The onboard PCI Sound Pro audio system supports 2 wave channels (front/rear) known as the 4 speaker system. If you are running applications which use the DirectSound® 3D or A3D® audio interface, your system can simulate realistic 3D sound

M587 Mainboard User's Manual

through a 4 speaker setup. Follow the steps below to install a 4-speaker setup.

Speaker Installation

Connect the front two speakers to the Line-out jack on the sound ports extension bracket. Connect the rear two speakers to the Line-in/Rear jack on the sound ports extension bracket. The original Line-in can be moved to Aux.

Speaker Position

Set up your speakers similar to the following figure to get the best audio result.

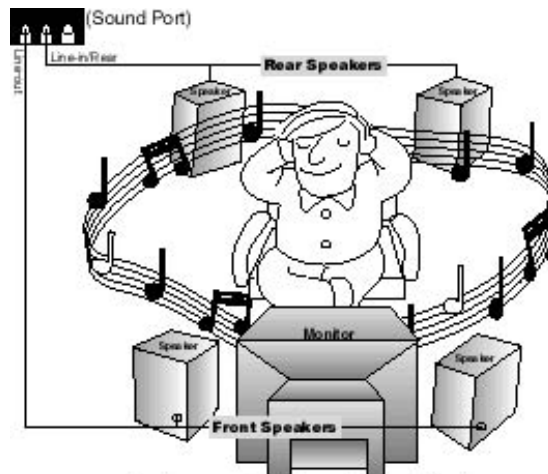

A picture on the 4 speakers application.

Mixer Setup

There is a 4-speakers option in the Volume Control of the Mixer when you are setting up the PCI Audio Application. Click on the 4 SPK icon to enable this option. This means that the output to the rear speakers is sent through the Line-in/Rear jack. In order to avoid hardware conflicts, **DO NOT** enable this option when the Line-in/Rear jack is connected with a line-in device. While the 4 speakers mode is enabled, turn on/off the output of the front speakers and adjust the volume of the speakers so that the front/rear speakers have the same volume.

4: Software & Applications

Demo

Execute the “Helicopter” demo in the C3D HRTF Positional Audio Demos of the PCI Audio Application. When you hear the helicopter flying behind you, it means that the rear speakers are working properly.