

# ***AP-540TX***

**Single Board Computer  
with S3 VGA & Flash disk socket  
for ZIF Socket 7 Processor**

## **COPYRIGHT©**

---

This document is a copyright of the original manufacturer, 1998. The original manufacturer reserves the right to make improvements to the product(s) described in this manual at any time without notice. This manual may not, in whole or in part, be photocopied, reproduced, transcribed, translated, or transmitted in whatever form without the written consent of the manufacturer, except for copies retained by the purchaser for backup purposes. All rights are reserved.

## **TRADEMARKS**

---

Pentium® is a registered trademark of Intel Corporation.

The following are trademarks or registered trademarks of their respective companies: IBM, Intel, AMD, Cyrix, Award, AMI, Microsoft, Windows, Windows NT, Novell, SCO, PC/104, PICMG, ALI, UMC, SMC, Winbond. Products mentioned in this manual are mentioned for identification purposes only. All names of products or services appearing in this manual are the trademarks or registered trademarks of their respective organizations and companies.

↔ Copyright 1998

Ver. No.1.2

LEI-UM-AP540TX-001

Date : 2000/11/17

# TABLE OF CONTENTS

<b>CHAPTER 1</b>	<b>INTRODUCTION</b>	<b>1</b>
1.1	SPECIFICATIONS	2
1.2	PACKING CHECK LIST	3
<b>CHAPTER 2</b>	<b>JUMPER SETTINGS AND CONNECTORS</b>	<b>4</b>
2.1	BOARD OUTLINE OF AP-540TX	4
2.2	CPU INSTALLING AND UPGRADING	5
2.3	JUMPER SETTING OVERVIEW	5
2.4	JUMPER LOCATION FOR AP-540TX	6
2.5	JUMPER SETTINGS SUMMARY FOR AP-540TX	7
2.6	JUMPER SETTINGS FOR AP-540TX	8
2.7	I/O CONNECTORS LOCATION FOR AP-540TX	14
2.8	I/O CONNECTORS SUMMARY FOR AP-540TX	15
2.9	SETTING STATUS INDICATORS AND CONTROL CONNECTORS	16
2.10	I/O CONNECTORS DESCRIPTION	17
<b>CHAPTER 3</b>	<b>AWARD BIOS SETUP</b>	<b>27</b>
3.1	RUNNING AWARD BIOS	27
3.2	CMOS SETUP UTILITY	28
3.3	STANDARD CMOS SETUP	29
3.4	BIOS FEATURES SETUP	34
3.5	CHIPSET FEATURES SETUP	37
3.6	POWER MANAGEMENT SETUP	41
3.7	PNP/PCI CONFIGURATION	44
3.8	LOAD BIOS DEFAULTS	46
3.9	LOAD SETUP DEFAULTS	46
3.10	INTEGRATED PERIPHERALS	47
3.11	SUPERVISOR / USER PASSWORD	49
3.12	IDE HDD AUTO DETECTION	50
3.13	HDD LOW LEVEL FORMAT	50
3.14	SAVE & EXIT SETUP	50
3.15	EXIT WITHOUT SAVING	50



<b>CHAPTER 4</b>	<b>DRIVERS SUPPORT</b>	<b>51</b>
4.1	DRIVER DISKETTE LIST	51
4.2	VGA DRIVER UTILITIES	51
<b>APPENDIX A</b>	<b>HOW TO USE WATCH-DOG TIMER</b>	<b>60</b>
<b>APPENDIX B</b>	<b>TECHNICAL REFERENCE</b>	<b>61</b>
<b>GLOSSARY</b>		
<b>TERMS AND CONDITIONS</b>		
<b>RMA SERVICE REQUEST FORM</b>		



## **CHAPTER 1.**

### **INTRODUCTION**

---

The AP-540TX is a full-size Pentium PCI/ISA single board computer that is using the Intel' s chipset 82430TX which supports the Ultra DMA-33 for faster hard drive and the Health monitoring hardware. It also has the S3 ViRGE 375 VGA chip on-board for immediate connection to your monitor. Health monitoring hardware is also available on the AP-540TX that detects and releases a sound alarm for any abnormal function which is found on the operating voltage & temperature of CPU (or it' s cooling fan). The For boosting operation, this motivated card also supports sockets for a Flash Disk, two DIMMs and four SIMMs. It offers the function of an industrial computer on a single board with on-board 2<sup>nd</sup> level cache RAM of 512KB for maximum performance.

The AP-540TX is built as a PCI/ISA expansion card that is simply upgraded by changing one card from another without replacing the whole system. It provides the primarily elements for building an IBM PC/AT compatible computer for a wide variety of applications with system integration. The AP-540TX is fully compatible with the IBM PC/AT which means virtually all the software written for the IBM PC/AT will run on the AP-540TX SBC.

Other on-board features include two serial ports (one each of RS-232 and selectable RS-232/422/485), one multi-mode parallel port (ECP/EPP/SPP), a floppy drive controller and a keyboard interface and a PS/2 mouse interface. The built-in high speed PCI IDE controller supports both PIO and bus master modes. Up to four IDE devices can be connected, including large hard disks, CD-ROM drives, tape backup drives and other IDE devices. Its 6-layer printed circuit board combines with noise-tolerant and low power consumption CMOS technology applied on the board makes AP-540TX able to withstand any harsh industrial environments very well.

## 1.1 SPECIFICATIONS

Processor	: For ZIF Socket 7 Processor -- Intel Pentium <sup>®</sup> & MMX, AMD K5 & K6, Cyrix 6x86, M1 & MII CPU
Chipset	: Intel 82430TX2.1 Compliant, S3 ViRGE 375 and Winbond 977TF I/O chipset compatible
System Memory	: Two 168-pin DIMM and Four 72-pin SIMM sockets up to 256MB DRAM
Cache Memory	: On-board 512KB Pipelined Burst Synchronous cache
BIOS	: 256KB Award License BIOS
Flash Memory Disk	: Reserved socket for DiskOnChip from M-System support up to 72 MB Flash memory Disk
VGA Controller	: S3 ViRGE 375, with 2MB video memory Resolution up to 1024 x 768 at 256 colors
IDE Drive Interface	: Two PCI IDE ports that support up to four IDE devices and Ultra DMA-33
Floppy Drive Interface	: One FDD port that supports up to two floppy devices
Serial Port	: Two COM ports, one RS-232 and one RS-232/422/485 serial port
Parallel Port	: One multi-mode parallel port (ECP/EPP/SPP)
Bus Interface	: Optional ISA/PCI bus
RTC Battery	: Dallas RTC battery or compatible
DMA	: 8 DMA channels
Interrupts	: 16 levels of hardware interrupts
PS/2 Mouse Connector	: On-board 6-pin Mini-Din PS/2 Mouse connector
Keyboard Connector	: 5-pin header and 6-pin Mini-Din connectors
Watchdog Timer	: 8 level time-out intervals (0.5/1/2/4/8/16/32/64 sec.)
Universal Serial Bus	: Support 2 USB ports
IR Interface	: Support one IrDA header
Health Monitoring	: Support CPU Temperature Alarm
Operating Temperature	: 0°C~55°C (32°F~132°F)
Humidity	: 10%~90% RH
Dimensions	: 338 mm X 122 mm (13 <sup>1</sup> / <sub>4</sub> " X 4 <sup>5</sup> / <sub>6</sub> " )
Net weight	: 340 g (0.748 lb.)



## 1.2 PACKING CHECK LIST

Before you begin to install your card, please make sure that you received the following materials as listed below:

<i>Item</i>	<i>Qty</i>	<i>Remark</i>
AP-540TX Single Board Computer	1 pc.	
Keyboard adapter cable	1 set	6-pin AT keyboard connector to 5-pin PS/2 keyboard connector 5-pin female connector header to 5-pin female connector header
IDE/Floppy cable	1 set	40-pin standard header to 40-pin standard header 34-pin standard header to 34-pin standard header
Printer/COM port cable	1 set	10-pin standard flat header to 9-pin D-Sub connector 26-pin female flat connector t header to 25-pin male D-Sub connector
SVGA/Utility Drivers	1 set	Disk drivers
User' s manual	1 pc.	AP-540TX

## **CHAPTER 2.**

### *JUMPER SETTINGS AND CONNECTORS*

#### 2.1 BOARD OUTLINE OF AP-540TX

The Figure below shows the jumpers and connectors location on the AP-540TX:

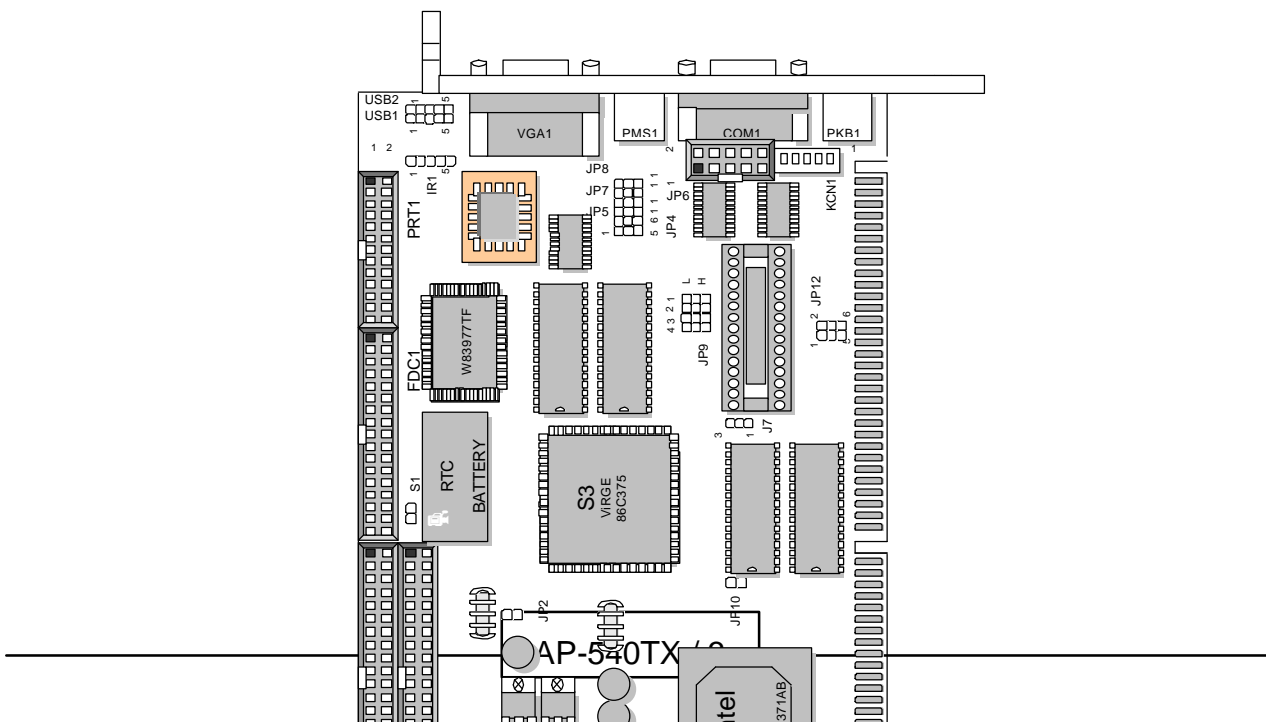



## 2.2 CPU INSTALLING AND UPGRADING

To upgrade to a higher power Pentium CPU, simply remove the old CPU and install to a new one; be sure to set the jumpers for the new CPU type and speed.

### **WARNING!**

Disconnect the power cord from your system when you intend to work on it or you plan to open the chassis of your IPC. Do not make connections when the power is turned on as sensitive electronic components can be damaged by the sudden rush of power. Please only allow experienced electronics technicians to do this job.

### **STATIC ELECTRICITY PRECAUTION!**

Caution! Computer components are very sensitive to damage from static electric discharge. Always ground yourself to remove static charge build-up before touching the boards in the computer. Use a grounding wrist strap at all time. Place all electronic components on the anti-static pad for static-dissipation or in a static-shielded bag when they are not in the chassis.

## 2.3 JUMPER SETTING OVERVIEW

In order to select the operation modes of your system, configure and set the jumpers on your SBC to match the need of your application. To set a jumper, a black plastic cap containing metal contacts is placed over the jumper pins as designated by the required configuration as listed in this section. A jumper is said to be “ on ” or “ 1-2 ” when the black cap has been placed on two of its pins, as show in the figure below:

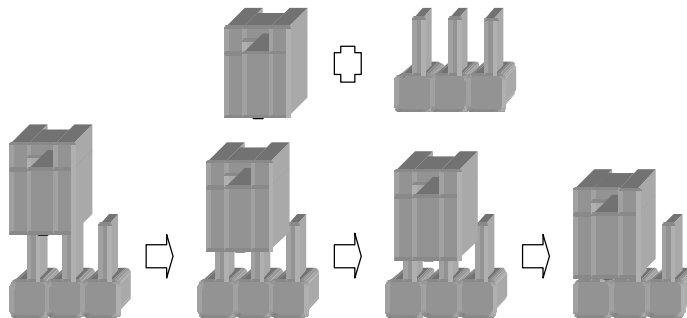

A pair of needle-nose pliers is recommended when working with jumpers. If you have any doubts about the best hardware configuration for your application, contact your local sales representative before you make any changes. In general, you simply need a standard cable to make most connections.

## 2.4 JUMPER LOCATION BOARD LAYOUT FOR AP-540TX

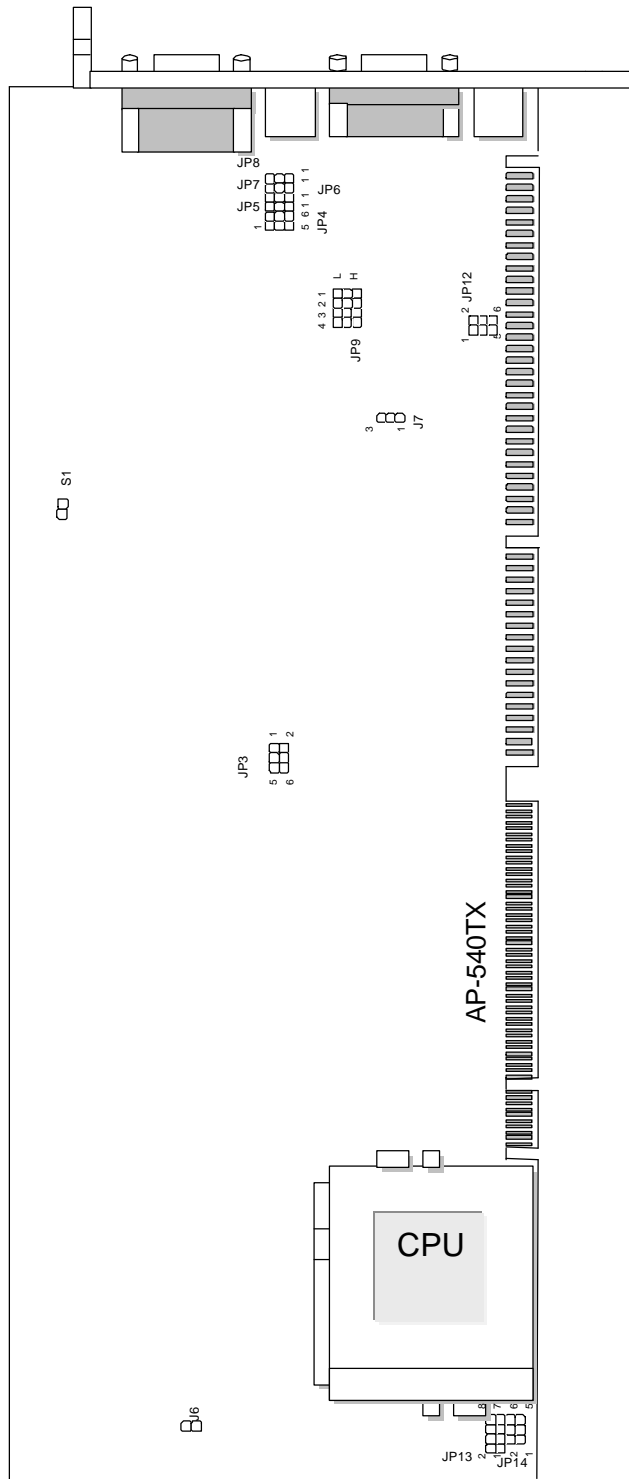

## 2.5 JUMPER SETTINGS SUMMARY FOR AP-540TX

<b>JUMPERS</b>	
<b>LOCATION</b>	<b>FUNCTION</b>
JP3	Select CPU External Bus Clock
JP4 ~ JP8	Select COM2 Type
JP9	Select Watch-Dog Time Out Period
JP12	Select Disk On Chip ( Flash Disk ) Address
JP13	Select CPU Vcore Voltage
JP14	Select Internal CPU Clock Ratio
J6	External SMI Switch
J7	Select Watch-Dog Active Type
S1	Clear CMOS

## 2.6 JUMPER SETTINGS FOR AP-540TX

CPU Speed Reference Table									
CPU Speed (MHz)	75	90	100	120	133	150	166	200	233
Clock setting	50	60	66.6	60	66.6	60	66.6	66.6	66.6
Frequency ratio	1.5	1.5	1.5	2	2	2.5	2.5	3	3.5

### ✦ JP3 : Select CPU External Bus Clock

Phase Link PLL52C66-01 CPU External Bus Clock	JP3
50 MHz	1-2 , 3-4 , 5-6
60 MHz	1-2
66.6 MHz (Default)	OFF
75 MHz	3-4 , 5-6
83.3 MHz	1-2 , 5-6

Note : Spare Jumper at 1-3

IC WORKS W48S87-04 CPU External Bus Clock	JP3
50 MHz	1-2 , 3-4 , 5-6
60 MHz	1-2
66.6 MHz ( Default )	OFF
75 MHz	3-4 , 5-6
83.3 MHz	1-2 , 5-6

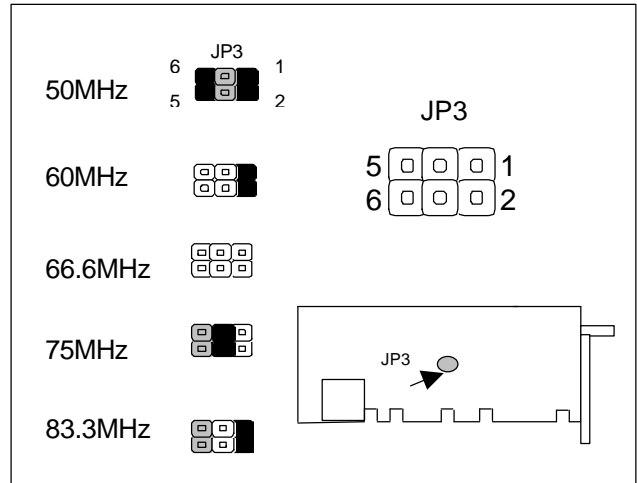
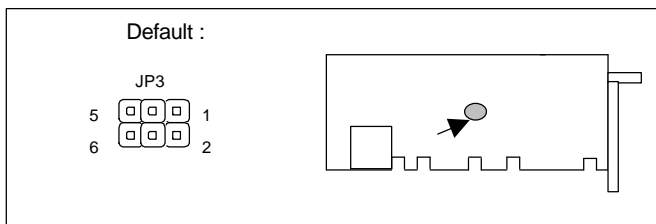

✦ JP4~JP8 : Select COM2 Type

COM2 Type	JP4	JP5	JP6	JP7	JP8
RS-232 ( Default )	5-6	1-2	1-2	1-2	1-2
RS-422	3-4	2-3	2-3	2-3	2-3
RS-485	1-2	2-3	2-3	2-3	2-3

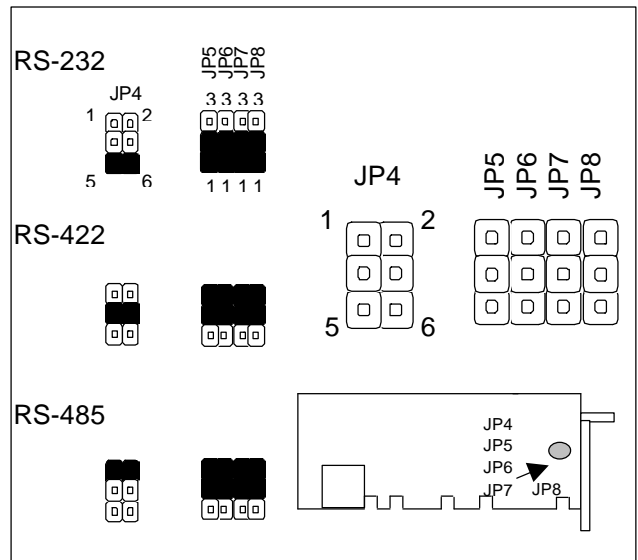
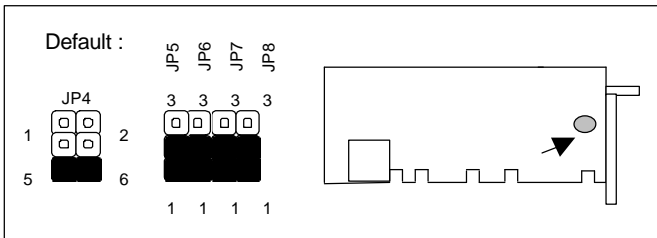

✦ JP9 : Select Watch-Dog Time Out Period

Time Out Period	JP9
0.5 sec	1L
1 sec	2L
2 sec	3L
4 sec (Default)	4L
8 sec	4H
16 sec	3H
32 sec	2H
64 sec	1H

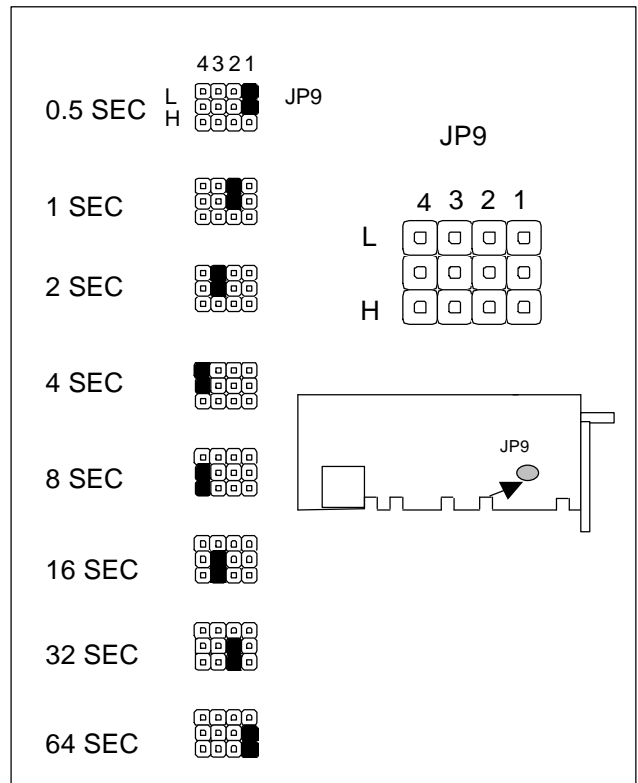
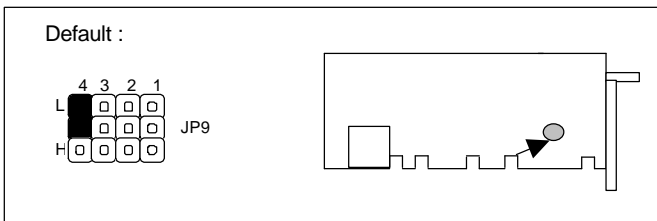

✦ **JP12 : Select Disk On Chip ( Flash Disk ) Address**

Flash Disk Address	JP12
C8000~CFFFF	1-2
D0000~D7FFF	3-4
D8000~DFFFF	5-6
Default	2-4

Note : Spare Jumper at 2-4

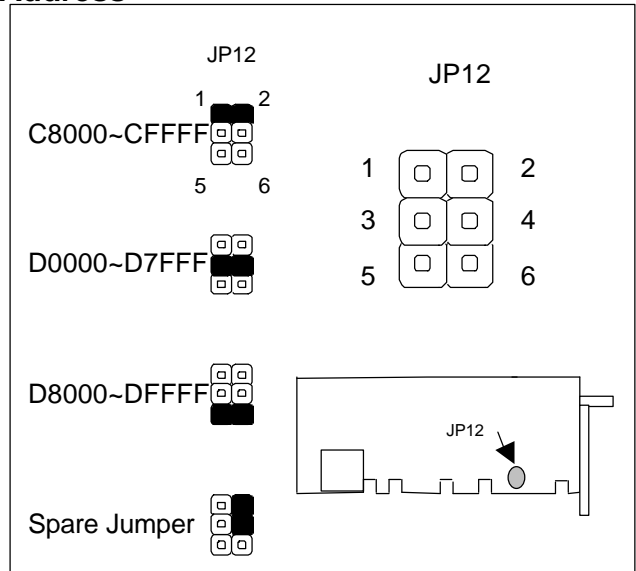
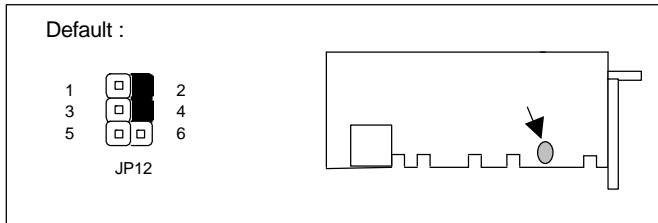



✦ **JP13 : Select CPU Vcore Voltage**

Vcore Voltage	JP13
2.0 V	1-2 , 3-4 , 5-6 , 7-8
2.1 V	3-4 , 5-6 , 7-8
2.2 V	1-2 , 5-6 , 7-8
2.3 V	5-6 , 7-8
2.4 V	1-2 , 3-4 , 7-8
2.5 V	3-4 , 7-8
2.6 V	1-2 , 7-8
2.7 V	7-8
2.8 V ( Default )	1-2 , 3-4 , 5-6
2.9 V	3-4 , 5-6
3.0 V	1-2 , 5-6
3.1 V	5-6
3.2 V	1-2 , 3-4
3.3 V	3-4
3.4 V	1-2
3.5 V	OFF

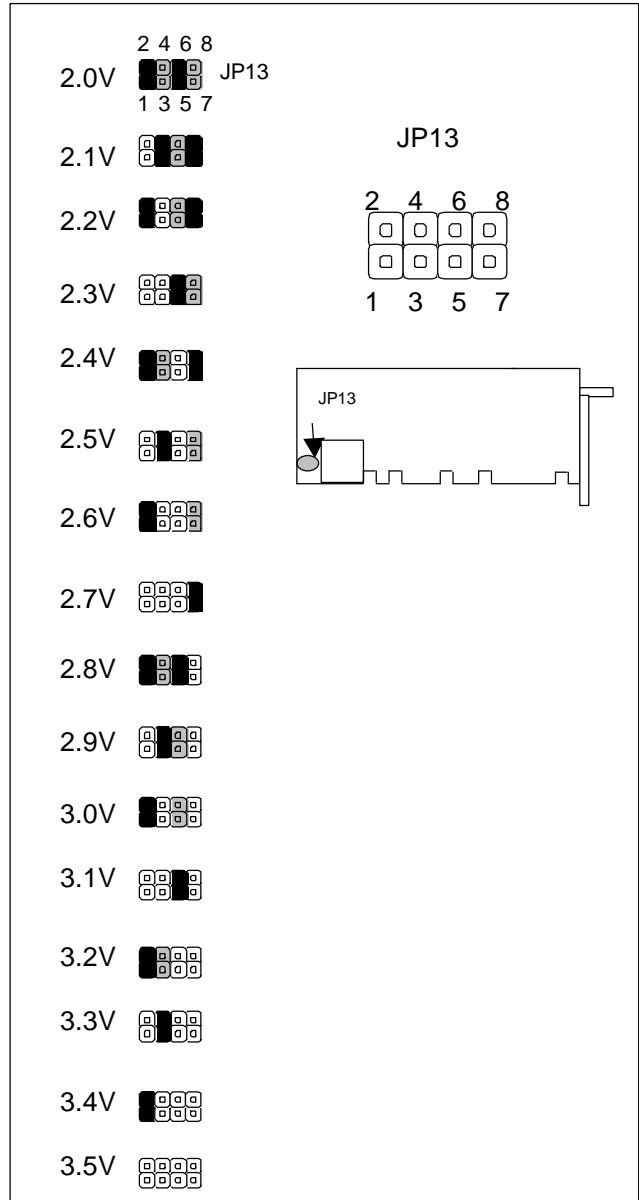
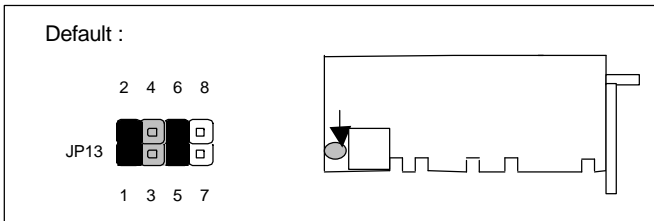

✦ **JP14 : Select Internal CPU Clock Ratio**

Clock Ratio	JP14
1.5 X	OFF
2.0 X	1-2
2.5 X ( Default )	1-2 , 3-4
3.0 X	3-4
3.5 X	OFF
4.0 X	1-2 , 5-6
4.5 X	1-2 , 3-4 , 5-6
5.0 X	3-4 , 5-6
5.5 X	5-6

Note : Spare Jumper at 2-4

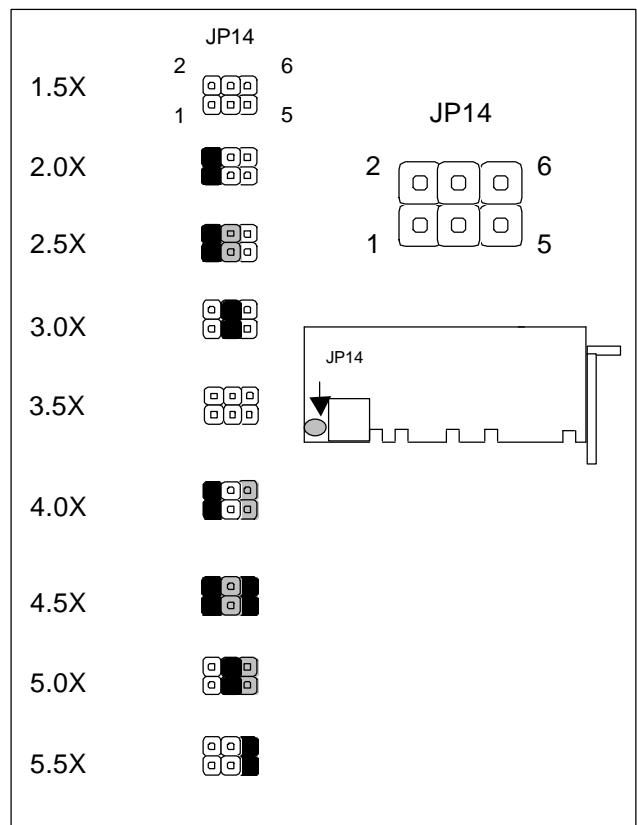
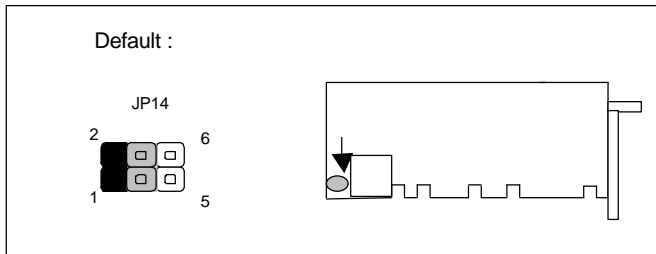

✦ **J6 : External SMI Switch**

SMI Function	J6
Sleep ( Break )	ON
Normal ( Default )	OFF

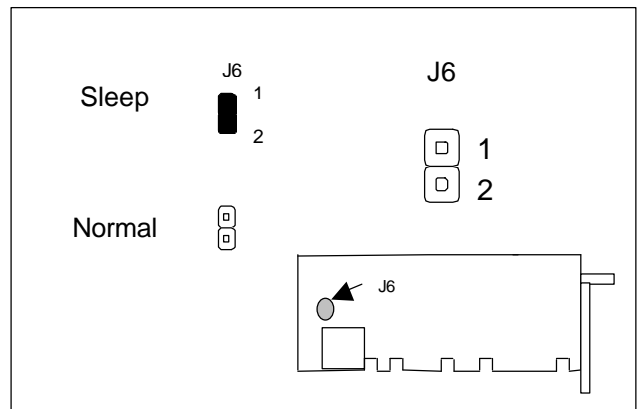
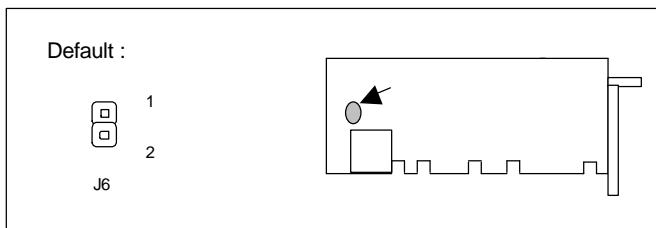

✦ **J7 : Select Watch-Dog Active Type**

Active Type	J7
Reset System ( Default )	2-3
NMI System	1-2
Disable Watch-Dog	OFF

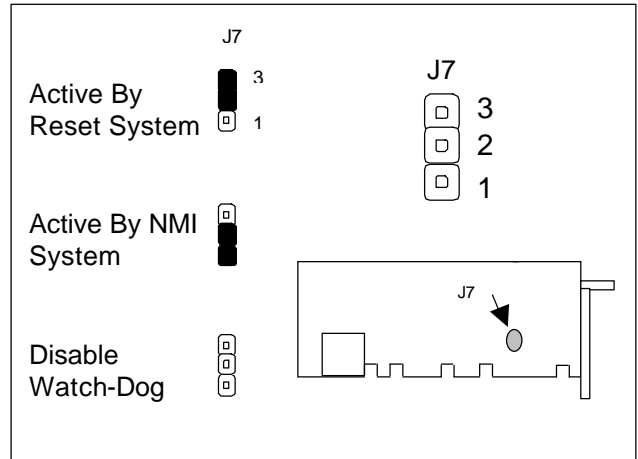
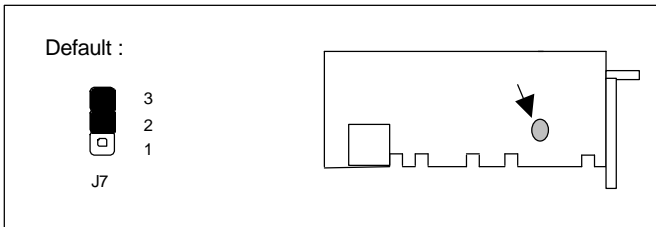

✦ **S1 : Clear CMOS**

Clear CMOS	S1
Normal (Default )	OFF
Clear CMOS	ON

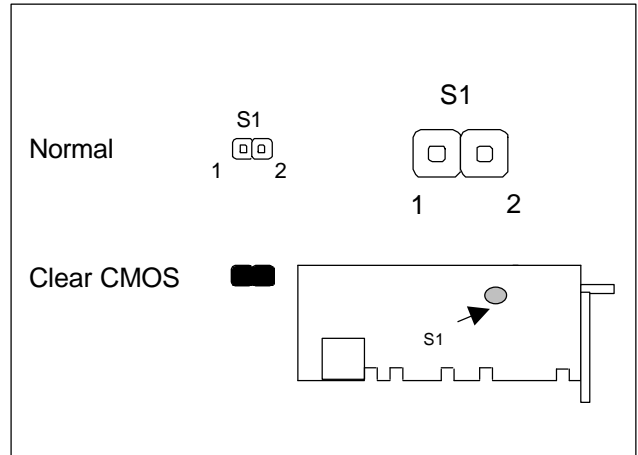
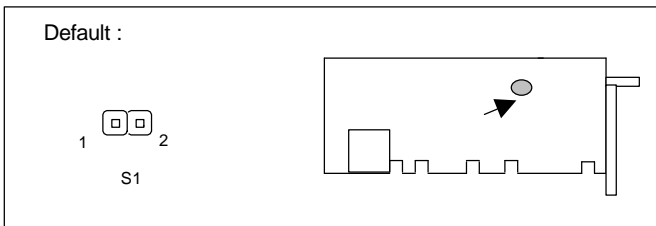

## 2.7 I/O CONNECTOR LOCATION FOR AP-540TX

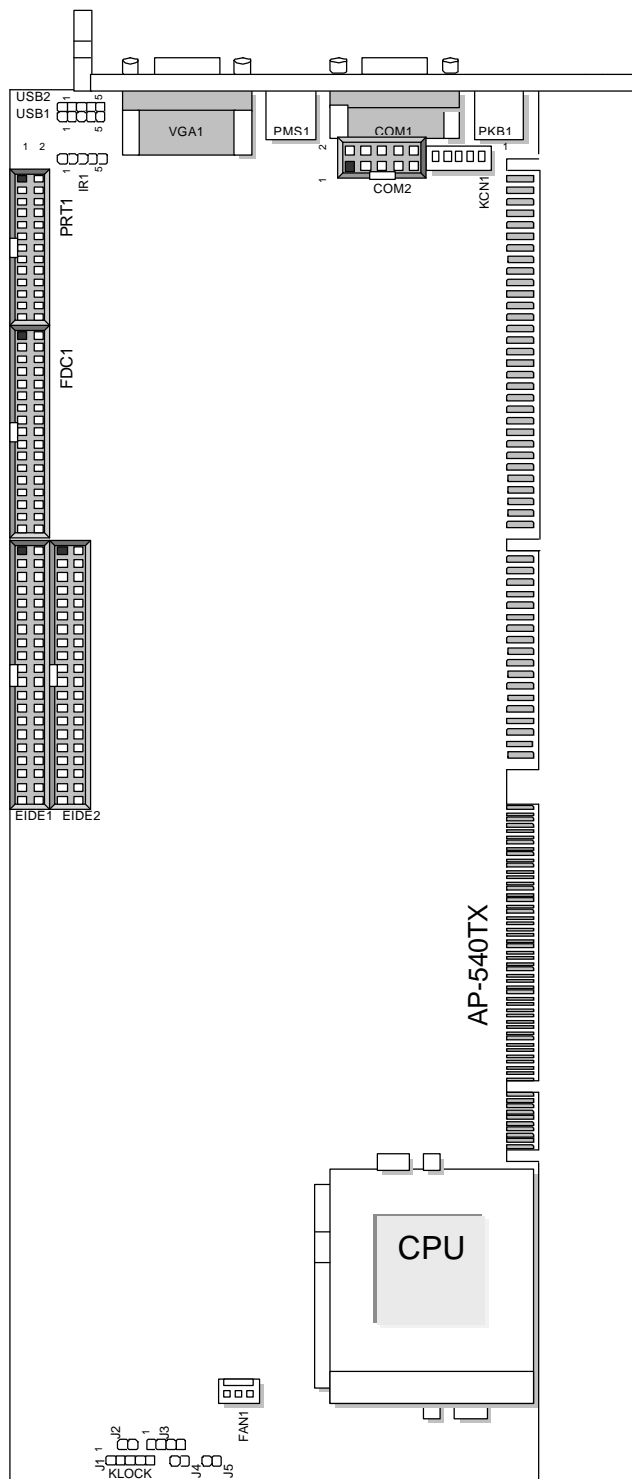

## 2.8 I/O CONNECTOR SUMMARY FOR AP-540TX

CONNECTOR	FUNCTION
J1	1-3 : Power LED , 4-5 : Key Lock
J2	Reset Switch
J3	Ext. Speaker
J4	Hard Disk Active LED
J5	Turbo LED
FAN1	CPU Fan Connector
USB1	USB Port #1 Connector
USB2	USB Port #2 Connector
IR1	Alternate IrDa Connector
KCN1	5 Pin Keyboard Cable Connector
COM1	RS-232 Serial Port #1 Connector ( D-Sub )
COM2	RS-232/422/485 Serial Port #2 Connector ( Header )
PMS1	PS/2 Mouse Connector ( Mini-Din )
PKB1	PS/2 Keyboard Connector ( Mini-Din )
EIDE1	Primary IDE Cable Connector ( Header )
EIDE2	Secondary IDE Cable Connector ( Header )
FDC1	Floppy Cable Connector ( Header )
LPT1	Parallel Cable Connector ( Header )
VGA1	VGA Connector

## 2.9 SYSTEM STATUS INDICATE AND CONTROL CONNECTORS

CONNECTOR	PIN NO.	DESCRIPTION
J1 : Power LED & Key Lock Connector	1	+5V
	2	NC
	3	Ground
	4	Key Lock Signal
	5	Ground
J2 : Reset Switch	1	Ground
	2	Reset Signal
J3 : Ext. Speaker	1	+5V
	2	NC
	3	NC
	4	Speak Signal
J4 : Hard Disk Active LED	1	HDD Active # Signal
	2	+5V
J5 : Turbo LED	1	Active # Signal
	2	Ground

## 2.10 I/O CONNECTORS DESCRIPTION

### ✦ FAN1 : CPU FAN Connector

PIN NO.	DESCRIPTION
1	FAN Status Signal
2	+12V
3	Ground

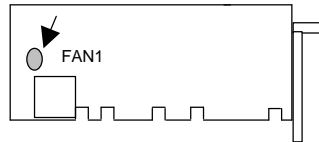
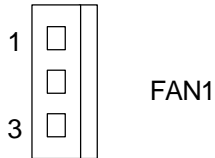

### ✦ USB1 : USB Port #1 Connector

PIN NO.	DESCRIPTION
1	USB VCC
2	USB P0-
3	USB P0+
4	S_Ground
5	Ground

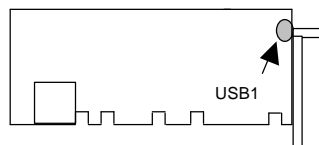
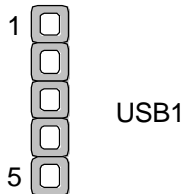

✦ **USB2 : USB Port #2 Connector**

PIN NO.	DESCRIPTION
1	USB VCC
2	USB P1-
3	USB P1+
4	S_Ground
5	Ground

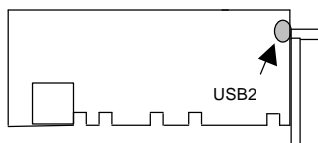
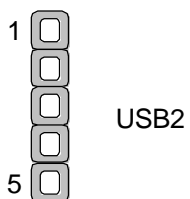

✦ **IR1 : Alternate IrDa Connector**

PIN NO.	DESCRIPTION
1	+5V
2	FIR_RX
3	IR_RX
4	Ground
5	IR_TX

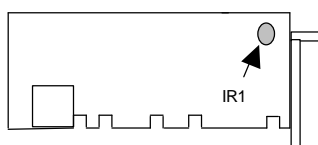
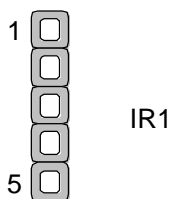



✦ **KCN1 : 5 Pin Keyboard Cable Connector**

PIN NO.	DESCRIPTION
1	Keyboard Clock
2	Keyboard Data
3	NC
4	Ground
5	+5V

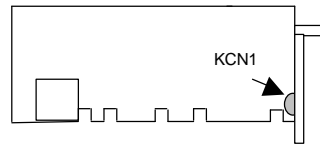
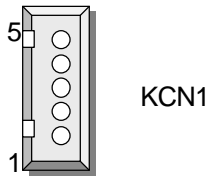

✦ **COM1 : RS-232 Serial Port #1 Connector ( D-Sub )**

PIN NO.	DESCRIPTION
1	DCDA #
2	SINA
3	SOUTA
4	DTRA #
5	Ground
6	DSRA #
7	RTSA #
8	CTSA #
9	RIA#

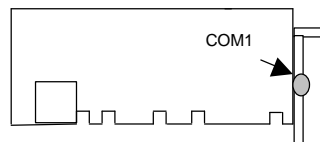
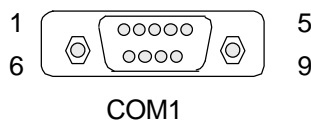
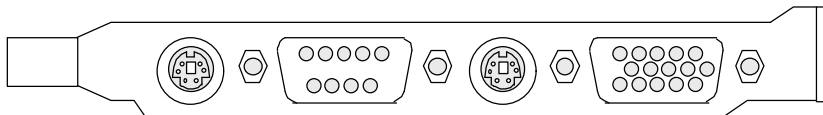

✦ **COM2 : RS-232/422/485 Serial Port #2 Connector ( Header )**

PIN NO.	DESCRIPTION		
	RS-232	RS-422	RS-485
1	Data Carrier Detect (DCDB #)	Transmit Data- (TXD-)	Data -
2	Receive Data (RXDB)	Transmit Data+ (TXD+)	Data +
3	Transmit Data (TXDB)	Receive Data+ (RXD+)	NC
4	Data Terminal Ready (DTRB #)	Receive Data- (RXD-)	NC
5	Ground	NC	NC
6	Data Set Ready (DSRB #)	NC	NC
7	Request To Send (RTSB #)	NC	NC
8	Clear To Send (CTSB #)	NC	NC
9	Ring Indicator (RIB #)	NC	NC
10	NC	NC	NC

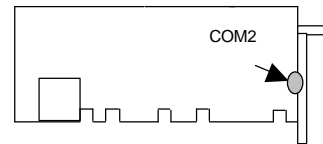
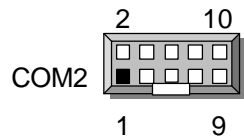

✦ **PMS1 : PS/2 Mouse Connector ( Mini Din )**

PIN NO.	DESCRIPTION
1	PS/2 Mouse Data
2	NC
3	Ground
4	+5V
5	PS/2 Mouse Clock
6	NC

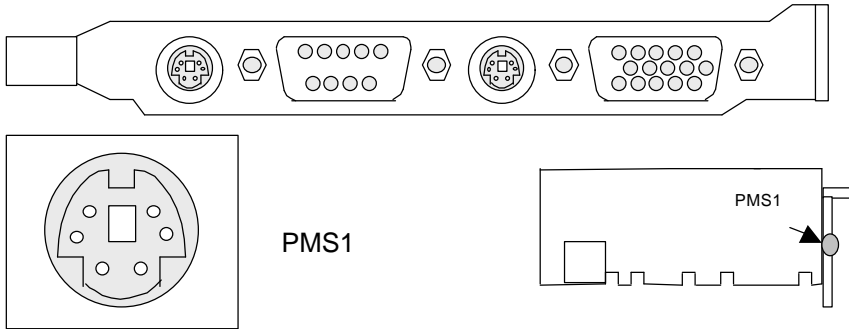

**PKB1 : PS/2 Keyboard Connector ( Mini Din )**

PIN NO.	DESCRIPTION
1	PS/2 Keyboard Data
2	NC
3	Ground
4	+5V
5	PS/2 Keyboard Clock
6	NC

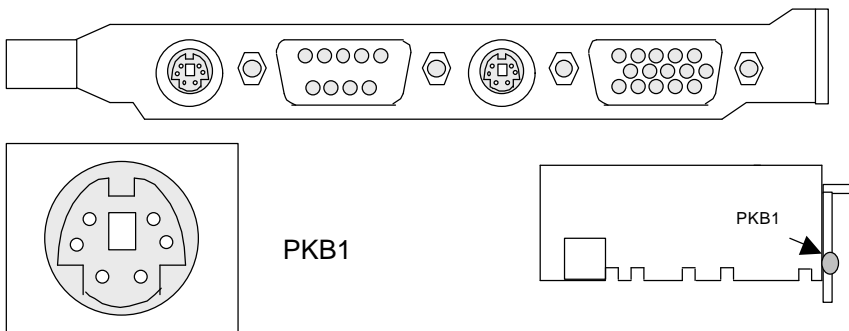

✦ **EIDE1 : Primary IDE Cable Connector ( Header )**

PIN NO.	DESCRIPTION	PIN NO.	DESCRIPTION
1	Reset #	2	Ground
3	Data 7	4	Data 8
5	Data 6	6	Data 9
7	Data 5	8	Data 10
9	Data 4	10	Data 11
11	Data 3	12	Data 12
13	Data 2	14	Data 13
15	Data 1	16	Data 14
17	Data 0	18	Data 15
19	Ground	20	NC
21	DMA REQ	22	Ground
23	IOW #	24	Ground
25	IOR #	26	Ground
27	IOCHRDY	28	NC
29	DMA ACK #	30	Ground
31	Interrupt	32	IOCS16 #
33	SA1	34	NC
35	SA0	36	SA2
37	HDC CS0 #	38	HDC CS1 #
39	HDD Active #	40	Ground

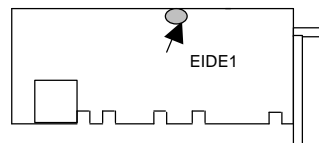
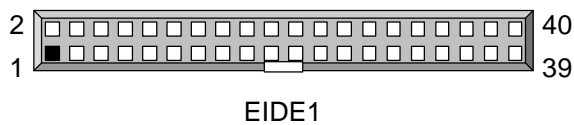

**EIDE2 : Secondary IDE Cable Connector ( Header )**

PIN NO.	DESCRIPTION	PIN NO.	DESCRIPTION
1	Reset #	2	Ground
3	Data 7	4	Data 8
5	Data 6	6	Data 9
7	Data 5	8	Data 10
9	Data 4	10	Data 11
11	Data 3	12	Data 12
13	Data 2	14	Data 13
15	Data 1	16	Data 14
17	Data 0	18	Data 15
19	Ground	20	NC
21	DMA REQ	22	Ground
23	IOW #	24	Ground
25	IOR #	26	Ground
27	IOCHRDY	28	NC
29	DMA ACK #	30	Ground
31	Interrupt	32	IOCS16 #
33	SA1	34	NC
35	SA0	36	SA2
37	HDC CS0 #	38	HDC CS1 #
39	HDD Active	40	Ground

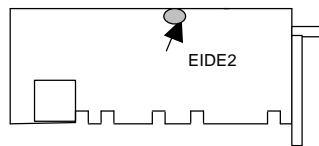
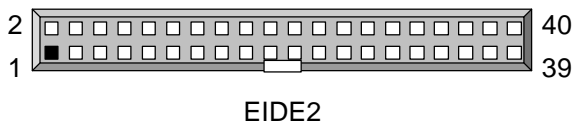

✦ **FDC1 : Floppy Cable Connector ( Header )**

PIN NO.	DESCRIPTION	PIN NO.	DESCRIPTION
1	Ground	2	Density Select
3	Ground	4	NC
5	Ground	6	NC
7	Ground	8	Index #
9	Ground	10	Motor Enable A #
11	Ground	12	Drive Select B #
13	Ground	14	Drive Select A #
15	Ground	16	Motor Enable B #
17	Ground	18	Direction #
19	Ground	20	Step #
21	Ground	22	Write Data #
23	Ground	24	Write Gate #
25	Ground	26	Track 0#
27	Ground	28	Write Protect #
29	NC	30	Read Data #
31	Ground	32	Head Side Select #
33	NC	34	Disk Change #

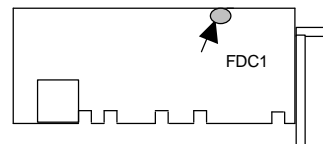
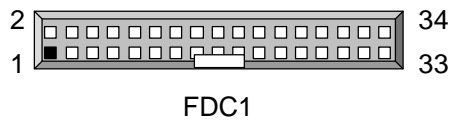

✦ **LPT1 : Parallel Cable Connector ( Header )**

PIN NO.	DESCRIPTION	PIN NO.	DESCRIPTION
1	Strobe #	2	Auto Form Feed #
3	Data 0	4	Error #
5	Data 1	6	Initialize #
7	Data 2	8	Printer Select IN #
9	Data 3	10	Ground
11	Data 4	12	Ground
13	Data 5	14	Ground
15	Data 6	16	Ground
17	Data 7	18	Ground
19	Acknowledge #	20	Ground
21	Busy	22	Ground
23	Paper Empty	24	Ground
25	Printer Select	26	NC

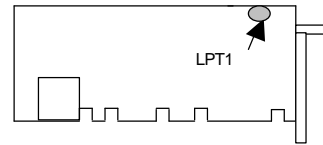
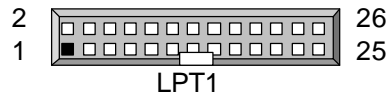

✦ **VGA1 : VGA Connector**

PIN NO.	DESCRIPTION
1	Red Color Signal
2	Green Color Signal
3	Blue Color Signal
4	NC
5	Ground
6	Ground
7	Ground
8	Ground
9	NC
10	Ground
11	NC
12	SPD
13	H-Sync.
14	V-Sync.
15	SPCLK

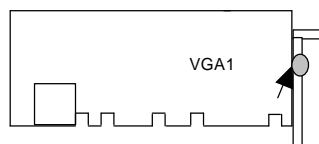
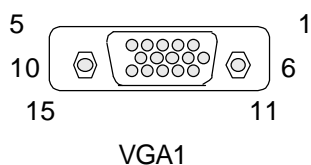
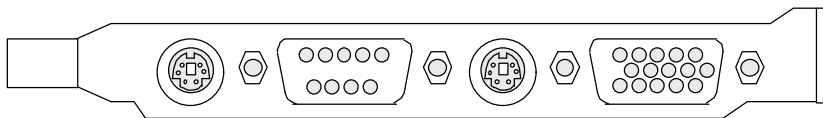



**CHAPTER 3.*****AWARD BIOS SETUP***

Award's ROM BIOS provides a built-in Setup program that allows user to modify the basic system configuration and settings. The modified data will be stored in a battery-backed CMOS RAM so that these data will be retained even when the power is turned off. In general, the information saved in the CMOS RAM stay unchanged unless there is configuration change in the system, such as hard drive replacement or new equipment is installed.

**3.1 RUNNING AWARD BIOS**

The Setup Utility is stored in the BIOS ROM. When the power of the computer system is turned on, a screen message appears to give you an opportunity to call up the Setup Utility; while the BIOS will enter the Power On Self Test (POST) routines. The POST routines perform various diagnostic checks while initializing the board hardware. If the routines encounter an error during the tests, the error will be reported in either of the two different ways – (1) hear a series of short beeps, or (2) see an error message on the screen display. There are two kinds of error: fatal or non-fatal. The system can usually continue to boot up sequence with the non-fatal errors. Non-fatal error messages usually appear on the screen along with the following instructions:

“ Press <F1> to RESUME ”

Write down the message and press the F1 key to continue the bootup sequence. After the POST routines are completed, the following message appears:

“ Press DEL to enter SETUP ”





**Entering Setup**

Turn on the power of the computer system and press <Del> immediately. If you don't have the chance to respond, reset the system by simultaneously typing the <Ctrl>, <Alt> and <Delete> keys, or by pushing the ' Reset ' button on the system cabinet. You can also restart by turning the system OFF then ON.

### 3.2 CMOS SETUP UTILITY

To access the AWARD BIOS SETUP program, press the <DEL> key. The screen display will appear as :

#### Main Program Screen

ROM PCI / ISA BIOS (2A59IL7E) CMOS SETUP UTILITY AWARD SOFTWARE, INC.	
<b>STANDARD CMOS SETUP</b> BIOS FEATURES SETUP CHIPSET FEATURES SETUP POWER MANAGEMENT SETUP PNP / PCI CONFIGURATION LOAD SETUP DEFAULTS LOAD BIOS DEFAULTS	INTEGRATED PERIPHERALS SUPERVISOR PASSWORD USER PASSWORD IDE HDD AUTO DETECTION HDD LOW LEVEL FORMAT SAVE & EXIT SETUP EXIT WITHOUT SAVING
ESC : Quit F10 : Save & Exit Setup	    : Select Item (Shift) F2 : Change Color
Load Setup Defaults except Standard CMOS SETUP	

This screen provides access to the utility's various functions.

Listed below are explanation of the keys displayed at the bottom of the screen:

**<ESC>** : Quit or Exit the utility.

 : Use arrow keys  to move cursor to your desired selection.

**<F10>** : Saves all changes made from the setup and exits program.

**<Shift><F2>** : Changes background and foreground colors.

### 3.3 STANDARD CMOS SETUP

When you select the "STANDARD CMOS SETUP" on the main program, the screen display will appear as :

#### Standard CMOS Setup Screen

ROM PCI / ISA BIOS(2A59IL7E)									
STANDARD CMOS SETUP									
AWARD SOFTWARE, INC.									
Date	(mm : dd : yy)	: Wed, Jun 3 1998							
Time	(hh : mm : ss)	: 1 4 : 5 0 : 4 1							
HARD DISKS	TYPE	SIZE	CYLS	HEAD	PRECOMP	LANDZ	SECTORS	MODE	
Primary Master	: Auto	0	0	0	0	0	0	AUTO	
Primary Slave	: Auto	0	0	0	0	0	0	AUTO	
Secondary Master	: Auto	0	0	0	0	0	0	AUTO	
Secondary Slave	: Auto	0	0	0	0	0	0	AUTO	
Drive A	: 1.44M, 3.5 in.								
Drive B	: None								
Floppy 3	Mode Support: Disabled								
Video	: EGA/VGA								
Halt On	: All Errors								
				Base Memory :					640K
				Extended Memory :					64512K
				Other Memory :					384K
				Total Memory :					65536K
ESC	: Quit			⏏ 🗑 🌙 🏠 : Select Item			PU / PD / + / - : Modify		
F1	: Help (Shift) F2 : Change Color								

The Standard CMOS Setup utility is used to configure the following components such as date, time, hard disk drive, floppy drive, display, and memory. Once a field is highlighted, on-line help information is displayed in the left bottom of the Menu screen.

**Set Date** : Month, Date, Year.

**Set Time** : Hour, Minute and Second. Use 24 Hour clock format (for p.m. time, add 12 to the hour number, you would enter 4:30p.m. as 16:30). When you select the "STANDARD CMOS SETUP" on the main program, the screen display will appear as :

**Hard Disks** : There are four hard disks listed: "Primary Master", "Primary Slave", "Secondary Master" and "Secondary Slave". For each IDE channel, the first device is the "Master" and the second device is "Slave". Hard disk types from 1 to 45 are the standard ones. To select or change the configuration, move the cursor to the desired position and press <Page Up> or <Page Down> to change the option : (1) Press "Auto" for IDE HDD auto detection, (2) Press "User" for user definable, and Press "None" for not installed (e.g. SCSI). There are six categories of information that you must enter for a HDD: "CYLS." for (number of cylinders), "HEADS" for (number of heads), "PRECOMP" for (write pre-compensation), "LANDZ" for (landing zone), "SECTOR" for (number of sectors) and "MODE" for (Normal, LBA, LARGE and AUTO). The hard disk vendor's or system manufacturer's documentation should provide you with the drive specifications. For an IDE hard drive, you can set "TYPE" to "Auto" or use the "IDE HDD AUTO DETECTION" utility in the main program screen to enter the drive specifications.

Here is a brief explanation of drive specifications:

- ✦ Type : The BIOS contains a table of pre-defined drive types. Each defined drive type has specified number of cylinders, number of heads, write compensation factor, landing zone, and number of sectors. Drives whose specifications do not accommodate any pre-defined type are classified as type USER.
- ✦ Size : Disk drive capacity (approximate). Note that this size is usually slightly greater than the size of a formatted disk given by a diskchecking program.
- ✦ Cyls : Number of cylinders.
- ✦ Head : Number of heads.
- ✦ Precomp : Write precompensation cylinder
- ✦ Landz : Landing zone.
- ✦ Sector : Number of sectors.
- ✦ Mode : Auto, Normal, Large, or LBA.
  - Auto: The BIOS automatically determines the optimal mode.
  - Normal: Maximum number of cylinders, heads, and sectors supported are 1024, 16, and 63.
  - Large: For drives that do not support LBA and have more than 1024 cylinders.
  - LBA (Logical Block Addressing): During drive accesses, the IDE controller transforms that data address described by sector, head, and cylinder number into a physical block address, significantly improving data transfer rates. For drives with greater 1024 cylinders.

The AWARD BIOS supports three HDD modes: NORMAL, LBA and LARGE.

**NORMAL mode** : This is a Generic Access mode in which neither the BIOS nor the IDE controller will make any transformation during the accession. The maximum HDD size is supported by the NORMAL mode that is 528 Megabytes.

**LBA mode** : This is a Logical Block Addressing mode which is a HDD accessing method to overcome the 528 Megabytes restriction. The number of cylinders, heads and sectors that are shown in setup may not be the physical number contained in the HDD.

During the HDD accessing, the IDE controller will transform the logical address that is described by the cylinder, head and sector numbers into its own physical address as contained inside the HDD. The maximum HDD size that is supported by the LBA mode is 8.4 Gigabytes.

**LARGE mode** : Some IDE HDD contains more than 1024 cylinders without the LBA support. This access mode tricks DOS (or other OS) with the number of cylinders that is less than 1024 by dividing it by 2. At the same time, the number of heads is multiplied by 2. A reverse transformation process will be made inside INT13H in order to access to the right HDD address. The maximum HDD size that is supported by the LARGE mode is 1 Gigabytes.

- Note :
1. To support LBA or LARGE mode, there are softwares located in the AWARD HD Service Routine“INT13H”. It may fail to access a HDD with LBA or LARGE modes selected if you are running under an Operating System that replaces the whole INT13H service routine.
  2. Entering incorrect drive specifications will result in a hard disk drive that will function improperly or no function at all.

**Drive A and Drive B :** Select the correct specifications for the diskette drive(s) installed in the computer.

None	No diskette drive installed
360K, 5.25 in	5-1/4 inch PC-type standard drive; 360 kilobyte capacity
1.2M, 5.25 in	5-1/4 inch AT-type high-density drive; 1.2 megabyte capacity
720K, 3.5in	3 1-2 inch double-sided drive; 720 kilobyte capacity
1.44M, 3.5 in	3 1-2 inch double-sided drive; 1.44 megabyte capacity
2.88M, 3.5 in	3 1-2 inch double-sided drive; 2.88 megabyte capacity

- Note :
1. Not Installed could be used as an option for diskless workstations..
  2. Highlight the listing after each drive name and select the appropriate entry.

**Video :** Select the type of primary video subsystem in your computer. The BIOS usually detects the correct video type automatically. The BIOS supports a secondary video subsystem, but you do not select it in Setup.

EGA/VGA	Enhanced Graphics Adapter/Video Graphics Array. For EGA, VGA, SEGA, SVGA or PGA monitor adapters.
CGA 40	Color Graphics Adapter, power up in 40 column mode
CGA 80	Color Graphics Adapter, power up in 80 column mode
MONO	Monochrome adapter, includes high resolution monochrome adapters

**Halt On :** During the power-on-self-test (POST), the computer stops if the BIOS detects a hardware error. You can tell the BIOS to ignore certain errors POST and continue the boot-up process. These are the selections:

No errors	Whenever the BIOS detects a non-fatal error the system will not be stopped and you will be prompted
All errors	The system boot will be stopped for any error that may be detected.
All, But Keyboard	The system boot will not stop for a keyboard error ; it will stop for all Other errors.
All, But Diskette	The system boot will not stop for a disk error ; it will stop for all other Errors.
All, But Disk/Key	The system boot will not stop for a keyboard or disk error ; it will stop for all other errors.

**Memory** : You cannot change any values in the Memory fields; they are only for your information. The fields show the total installed random access memory (RAM) and amounts allocated to base memory, extended memory, and other (high) memory. RAM is counted in kilobytes (KB: approximately one thousand bytes) and megabytes (MB: approximately one million bytes).

RAM is the computer's working memory, where the computer stores programs and data currently being used, so they are accessible to the CPU. Modern personal computers may contain up to 64MB, 128MB, or more.

- ✦ **Base Memory** : Typically 640KB. Also called conventional memory. The DOS operating system and conventional applications use this area.
- ✦ **Extended Memory** : Above the 1-MB boundary. Early IBM personal computers could not use memory above 1MB, but current PCs and their software can use extended memory.
- ✦ **Other Memory** : Between 640KB and 1MB; called High memory. DOS may load terminate-and-stay-resident (TSR) programs, such as device drivers, in this area, to free as much conventional memory as possible for applications. Lines in your CONFIG.SYS file that start with LOADHIGH load programs into high memory.





**Virus Warning** : The default setting of the Virus Warning is "Disabled". When it is enabled, any attempt to write the boot sector and partition table will halt the system and cause a warning message to appear. If this happens, you can use an anti-virus utility on a virus free, bootable floppy diskette to reboot, to clean and to investigate your system.

**CPU Internal Cache** : The default setting is "Enabled". This setting enables the CPU internal cache .

**External Cache** : The default setting is "Enabled". This setting enables the external cache.

**Quick Power On Self Test** : The default setting is "Enabled". This speeds up the Power On Self Test (POST) by skipping some items that are normally checked during the full POST. If your system is functioning normally, you can choose this feature to speed the booting process.

**Boot Sequence** : The default setting is "C:,A:"; the other options are "CDROM, C, A" and "A, C" and "C, CDROM, A". This setting determines where the computer looks first for an operating system, the hard disk, or the floppy disk, ...or other. The BIOS will load the operating system from the disk drives in the sequence as selected here.

**Swap Floppy Drive** : The default setting is "Disabled". This setting gives you an option to swap A and B floppy disks. Normally, the floppy drive A is the one at the end of the cable and drive B is at the other end. If you set this option to "Enabled", the Drive A will function as Drive B, and vice-versa under the DOS.

**Boot Up Floppy Seek** : The defaults setting is "Disabled". When enabled, the BIOS will check whether there is a floppy disk drive installed.

**Boot Up Numlock Status** : The default setting is "On". If set "Off", the cursor controls will function on the numeric keypad.

**Boot Up System Speed** : The default setting is "High". This sets the CPU speed at boot up.

**Gate A20 Option** : The default setting is “Fast”. This is the optimal setting for the CPU card. The other option is “Normal” .

**Typematic Rate Setting** : The default setting is “Disabled” . If enabled, you can set the typematic rate and typematic delay.

**Typematic Rate (Chars/Sec)** : This setting controls the speed at which the system registers the repeated keystrokes. The choices range from 6 to 30 Chars/Sec. The default setting is “6” Chars/Sec.

**Typematic Delay (Msec)** : This setting controls the time between the display of the first and second characters. There are four delay choices: 250ms, 500ms, 750ms and 1000ms. The default setting is “250” ms.

**Security Option** : This setting controls the password in the main screen. The options are “Setup” and “System” . Select “Setup” and it will protect the Setup Utility settings from being tampered with. Select “System” if you want to use password feature every time the system boots up. The default setting is “Setup” . You can create your password by using the “SUPERVISOR/USER PASSWORD” utility on the main program screen.

**PCI/VGA Palette Snoop** : The default setting is “Disabled” . Set to “Enable” if any ISA adapter card installed requires VGA palette snooping.

**Assign IRQ For VGA** : The default setting is “Disabled” .

**OS Select For DRAM > 64MB** : The default setting is “Non-OS2” . Set to “OS2” if the system memory size is greater than 64MB and the operating system is OS/2.

**Video BIOS Shadow** : The default setting is “Enabled” which will copy the VGA display card BIOS into system DRAM to improve performance.

**C8000-CBFFF Shadow to DC000-DFFFF Shadow** : The default setting for the shadow feature is “Disabled” . When enabled, the ROM with the specific address is copied into system DRAM. It will also reduce the size of memory available to the system. After you have made your selection in the BIOS FEATURES SETUP, press the <ESC> key to go back to the main program screen.

### 3.5 CHIPSET FEATURES SETUP

When you select the “CHIPSET FEATURES SETUP” on the main program, the screen display will appears as:

#### Chipset Features Setup Screen

ROM PCI / ISA BIOS (2A59IL7E) CHIPSET FEATURES SETUP AWARD SOFTWARE, INC.	
Auto Configuration	: Enabled
DRAM Timing	: 60 ns
DRAM Leadoff Timing	: 10 / 6 / 3
DRAM Read Burst (EDO/FP)	: x222/x333
DRAM Write Burst Timing	: x222
Fast EDO Lead Off	: Enabled
Refresh RAS# Assertion	: 4 Clks
Fast RAS To CAS Delay	: 3
DRAM Page Idle Timer	: 2 Clks
DRAM Enhanced Paging	: Enabled
Fast MA to RAS# Delay	: 2 Clks
SDRAM (CAS Lat/RAS-to-CAS)	: 3 / 3
SDRAM Speculative Read	: Disabled
System BIOS Cacheable	: Enabled
Video BIOS Cacheable	: Enabled
8 Bit I /O Recovery Time	: 1
16 Bit I /O Recovery Time	: 2
Memory Hole At 15M-16M	: Disabled
PCI 2.1 Compliance	: Enabled
Spread Spectrum	: Disabled
CPU Warning Temperature	: 70  C / 158  F
Current CPU Temperature	: 26  C / 78  F
Current CPUFAN1 Speed	: 5454 RPM
Current Vin (V)	: 2.94 V
ESC	: Quit
F1	: Help
F5	: Old Values (Shift) F2
F6	: Load BIOS Defaults
F7	: Load Setup Defaults
	: Select Item
PU /PD /+ / -	: Modify
	: Color

This section describes features of the Intel 82430TX PCIsset. If your system contains a different chipset, this section will bear little resemblance to what you seen on your screen.

**Auto Configuration** : The default setting is “Enabled” which will optimize DRAM timing automatically depending on whether the DRAM used is either 70ns or 60ns. The other option is “Disabled” which allows you to change DRAM timing manually.

**DRAM Timing** : Choose DRAM speed 60ns or 70ns.

**DRAM Leadoff Timing** : Select the combination of CPU clocks the DRAM on your board requires before each read from or write to the memory.

**DRAM Read Burst (EDO/FP)** : Sets the timing for reads from EDO (Extended Data Output) or FPM (First Page Mode) memory. The lower the timing numbers, the faster the system addresses memory. Selecting timing numbers lower than the installed DRAM is able to support can result in memory errors.

**DRAM Write Burst Timing** : Sets the timing for writes to memory. The lower the timing numbers, the faster the system addresses memory. Selecting timing numbers lower than the installed DRAM is able to support can result in memory errors.

**Fast EDO Lead off** : Select Enabled only for EDO DRAMs in either a synchronous cache or cacheless system. It causes a 1-HCLK pull-in for all read leadoff latencies for EDO DRAMs (i.e., page hits, page misses, and row misses). Select Disabled if any of the DRAM rows are populated with FPM DRAMs.

**Refresh RAS# Assertion** : Select the number of clock ticks RAS# is asserted for refresh cycles.

**Fast RAS to CAS Delay** : When DRAM is refreshed, both rows and columns are addressed separately. This field lets you insert a timing delay between CAS and RAS strobe signals, used when DRAM is written to, read from, or refreshed. Disabled gives faster performance; Enabled give more stable performance.

**DRAM Page Idle Timer** : Select the amount of time in HCLKs that the DRAM controller waits to close a DRAM page after the CPU becomes idle.

**DRAM Enhanced Paging** : When Enabled, the chipset keeps the page open until a

page/row miss. When Disabled, the chipset uses additional information to keep the DRAM page open when the host may be “right back.”

**Fast MA to RAS# Delay** : The values in this field are set by the system board designer, depending on the DRAM installed. Do not change the values in this field unless you change specifications of the installed DRAM or the installed CPU.

**SDRAM (CAS Lat/RAS-to-CAS** : You can select a combination of CAS latency and RAS-to-CAS delay in HCLKs of 2/2 or 3/3. The system board designer should set the values in this field, depending on the DRAM installed. Do not change the values in this field unless you change specifications of the installed DRAM or the installed CPU.

**SDRAM Speculative Read** : The chipset can “speculate” on a DRAM read address, thus reducing read latencies. The CPU issues a read request containing the data memory address. The DRAM controller receives the request. When this field is Enabled, the controller issues the read command slightly before it has finished decoding the data address.

**System BIOS Cacheable** : Selecting Enabled allows caching of the system BIOS ROM at F0000h-FFFFFh, resulting in better system performance. However, if any program writes to this memory area, a system error may result.

**Video BIOS Cacheable** : Selecting Enabled allows caching of the video BIOS ROM at C0000h to C7FFFh, resulting in better video performance. However, if any program writes to this memory area, a system error may result.

**8/16 Bit I/O Recovery Time** : The I/O recovery mechanism adds bus clock cycles between PCI-originated I/O cycles to the ISA bus. This delay takes place because the PCI bus is so much faster than the ISA bus. These two fields let you add recovery time (in bus clock cycles) for 16-bit and 8-bit I/O.

**Memory Hole At 15M-16M** : The default setting is “Disabled”. Set to “Enabled” when the system memory size is equal to or greater than 16M bytes, then the physical memory address from 15M to 16M will be passed to PCI or ISA. Thus, there will be 1M Bytes hole in your system memory. This option is designed for some OS with special add-on cards which need 15M-16M memory space.

**PCI 2.1 Compliance** : The default setting is “Enabled”. Select Enabled to support

compliance with PCI specification version 2.1.

**CPU Warning Temperature** : The default setting is “ 70°C/158°F ”. Select the combination of lower and upper limits for the CPU temperature. If the CPU temperature extends beyond either limit, any warning mechanism programmed into your system will be activated.

**Current CPU Temperature** : The default setting is “ 39°C/102°F ”. This field displays the current CPU temperature, if your computer contains a monitoring system.

**Current CPUFAN1 Speed** : The default setting is “ 0 RPM ”. This field displays the current speed of the CPU fan, if your computer contains a monitoring system.





**Current Vin (V)** : The default setting is “ 3.28V ”. This field programs the limit voltage of the CPU, if your computer contains a monitoring system.

After you have made your selections in the CHIPSET FEATURES SETUP, press the <ESC> key to go back to the main program screen.

### 3.6 POWER MANAGEMENT SETUP

The “Power Management Setup” controls the CPU card’s “Green” features. When you select the “POWER MANAGEMENT SETUP” on the main program, the screen display will appear as:

#### Power Management Setup Screen

ROM PCI / ISA BIOS (2A59IL7E) POWER MANAGEMENT SETUP AWARD SOFTWARE, INC.	
Power Management : Disabled PM Control by APM : Yes Video Off Method : V /H SYNC+ Blank Video Off After : Standby MODEM Use IRQ : 3 Doze Mode : Disabled Standby Mode : Disabled Suspend Mode : Disabled HDD Power Down : Disabled Throttle Duty Cycle : 62.5% ZZ Active in Suspend : Disabled VGA Active Monitor : Enabled PowerOn by Ring : Disabled IRQ 8 Break Suspend : Disabled	** Reload Global Timer Events ** IRQ [ 3-7 , 9-15 ] , NMI : Enabled Primary IDE 0 : Disabled Primary IDE 1 : Disabled Secondary IDE 0 : Disabled Secondary IDE 1 : Disabled Floppy Disk : Disabled Serial Port : Enabled Parallel Port : Disabled
ESC : Quit     : Select Item F1 : Help      PU /PD/+/- : Modify F5 : Old Values ( Shift ) F2 : Color F6 : Load BIOS Defaults F7 : Load Setup Defaults	

**Power Management :** This setting controls the System Doze Mode, Standby Mode and Suspend Mode Timer features. There are four options namely --

- User Define :** Allows you to customize all power saving timer features.
- Optimize :** This is the recommended setting for general use.
- Test/Demo :** This is for test/demonstration purpose.
- Disable :** Disable the power management features.

**PM Control by APM** : The default setting is “No”. If it is set to “Yes”, the system BIOS will wait for APM’s prompt before it enters any PM mode.

Note : If your system power management is controlled by APM and there is a task running, the APM will not prompt the BIOS to enter any power saving mode after time out.

**Video Off Method** : This setting controls the Video off method in power saving mode. The default setting is “V/H SYNC+Blank”. This setting disables V/H SYNC signals and blanks the screen into the power saving mode. Other options are “Blank Screen” and “DPMS”.

**Video Off After** : As the system moves from lesser to greater power-saving modes, select the mode in which you want the monitor to blank.

**Doze Mode** : Options are from “1 Min.” to “1 Hour” and “Disable”. The system speed will change from turbo to slow and the video signal will be suspended, if no Power Management events occur for a specified length of time. Full power function will return when a Wake-Up event is detected.

**Standby Mode** : Options are from “1 Min” to “1 Hour” and “Disable”. The system speed will change from turbo to slow and the video signal will be suspended, if no Power Management events occur for a specified length of time. Full power function will return when a Wake-Up event is detected.

**Suspend Mode** : Option are from “1 Min” to “1 Hour” and “Disable”. The CPU clock will be stopped and the video signal will be suspended, if no Power Management events occur for a specified length of time. Full power function will return when a Wake-Up event is detected.

**HDD Power Down** : Options are from “1 Min.” to “15 Min.” and “Disable”. The IDE hard drive will spin down if it is not accessed within a specified length of time.

**Throttle Duty Cycle** : When the system enters Doze mode, the CPU clock runs only part of the time. You may select the percent of time that the clock runs.



**ZZ Active in Suspend** : When “ Enabled” , the ZZ signal is active during Suspend mode.

**VGA Active Monitor** : When Enabled, any video activity restarts the global timer for Standby mode.

**CPUFAN Off In suspend** : When Enabled, the CPU fan turns off during Suspend mode.

**IRQ8 Clock Event** : You can turn On or Off monitoring of IRQ8 (the Real Time Clock) so it does not awaken the system from Suspend mode.

**Reload Global Time Events** : When Enabled, an event occurring on each device listed below restarts the global time for Standby mode.

**IRQ3-7, 9-15, NMI**

**Primary IDE 0**

**Primary IDE 1**

**Secondary IDE 0**

**Secondary IDE 1**

**Floppy Disk**

**Serial Port**

**Parallel Port**

**Wake-Up Events** : When a hardware event is enabled, the occurrence of a corresponding event will return the system to full speed.

**Power Down/Resume Events** : When a hardware event is enabled, the occurrence of a corresponding event will prevent the system from entering any PM mode.





After you have made your selection in the POWER MANAGEMENT SETUP, press the <ESC> key to go back to the main program screen.

### 3.7 PNP/PCI CONFIGURATION

Both the ISA and PCI buses on the CPU card use system IRQs & DMAs. You must set up the IRQ and DMA assignments correctly through the PnP/PCI Configuration Setup utility, otherwise the SBC will not work properly.

When you select the “PnP /PCI CONFIGURATION” on the main program, the screen display will appears as:

#### PnP/PCI Configuration Setup Screen

ROM PCI / ISA BIOS (2A59IL7E) PNP/PCI CONFIGURATION AWARD SOFTWARE, INC.	
PNP OS Installed : No Resources Controlled By : Manual Reset Configuration Data : Disabled	PCI IDE IRQ Map To : ISA
IRQ-3 assigned to : Legacy ISA IRQ-4 assigned to : Legacy ISA IRQ-5 assigned to : PCI/ISA PnP IRQ-7 assigned to : Legacy ISA IRQ-9 assigned to : PCI/ISA PnP IRQ-10 assigned to : PCI/ISA PnP IRQ-11 assigned to : PCI/ISA PnP IRQ-12 assigned to : PCI/ISA PnP IRQ-14 assigned to : PCI/ISA PnP IRQ-15 assigned to : PCI/ISA PnP DMA-0 assigned to : PCI/ISA PnP DMA-1 assigned to : PCI/ISA PnP DMA-3 assigned to : PCI/ISA PnP DMA-5 assigned to : PCI/ISA PnP DMA-6 assigned to : PCI/ISA PnP DMA-7 assigned to : PCI/ISA PnP	Used MEM base addr : N/A Assign IRQ For USB : Disabled  ESC : Quit     : Select Item F1 : Help      PU /PD/+/- : Modify F5 : Old Values ( Shift ) F2 : Color F6 : Load BIOS Defaults F7 : Load Setup Defaults

**PNP OS Installed** : Select Yes if the system operating environment is Plug-and-Play aware (e.g., Windows 95).

**Resources Controlled By** : The defaults setting is “Auto” which will control all IRQs and DMAs automatically. The other option is “Manual” which allows you to control IRQs and DMAs individually.

**Reset Configuration Data** : The default setting is “Disabled”. When set to “Enabled”, the content of the ESCD block in flash BIOS will be cleared.

**IRQ Assigned to and DMA Assigned to** : If there is a legacy ISA device which uses an IRQ or a DMA, set the corresponding IRQ or DMA to “ Legacy ISA”; otherwise you should set to PCI/ISA PnP.

**PCI IDE IRQ Map To, Primary IDE INT#, Secondary IDE INT#** : If you disable the on-board PCI IDE controller and install a PCI IDE card on the SBC, you need to set this option. If a PCI IDE Card which uses ISA IRQ directly through a paddle card installed on an ISA slot, select “ISA” for the option “PCI IDE IRQ Map To”. If a PCI IDE Card uses PCI “INT” and is compliant to PCI Plug and Play specification, select “PCI-AUTO” for the option “PCI IDE IRQ Map To”. Otherwise, select “PCI-SLOT 1, PCI-SLOT 2 or PCI-SLOT 3, PCI-SLOT4 ) depending on which slot the PCI IDE Card is installed. Only INT# A and INT# B are available for a PCI IDE Card, therefore you must set the PCI IDE Card’s primary interrupt to INT A and secondary interrupt to INT B. The INT# A is routed to IRQ 14, while the INT# B is routed to IRQ 15 through a hardware router in the chipset.

**Used MEM base addr** : Because BIOSes fail to auto detect some specific ISA Legacy cards with requested memory space below 1M address, we have added the “Used MEM base addr” and “Used MEM Length” to support such kind of cards. Now, with these two functions, users can define where the used memory address is located and its length of the legacy area correspondingly. Based on this, BIOS will skip the UMB area that is used by the legacy device to avoid the memory space conflict. For example, if the user select “D000” for “Used MEM base addr” and “16K” for “Used MEM Length” that means the address region D0000H-D3FFFH is occupied by ISA legacy cards, and BIOS will not assign this region for PnP/ISA and PCI cards.

### 3.8 LOAD SETUP DEFAULTS

“LOAD SETUP DEFAULTS” loads the optimal settings which are stored in BIOS ROM. The defaults loaded affect only the BIOS Features Setup, Chipset Features Setup, Power Management Setup, PnP/PCI configuration setup and Integrated Peripherals Setup. There is no effect on the Standard CMOS Setup. To use this feature, highlight the entry on the main screen and press <Enter>. A line will appear on the screen asking if you want to load the Setup default values. Press the <Y> key and then press the <Enter> key if you want to load the Setup defaults. Press <N> if you do not want to proceed.

### 3.9 LOAD BIOS DEFAULTS

The BIOS defaults have been set by the manufacturer which represent settings provided with the minimum requirements for your system to operate. “ **Load BIOS Defaults** ” loads the troubleshooting default values permanently recorded in the BIOS ROM. These settings are non-optimal and turn off all high performance features.

The Standard CMOS Setup screen is not affected. To use this feature, highlight it on the main screen and press <Enter>. A line will appear asking if you want to load the BIOS default values. Press the <Y> key and the <Enter>. The default settings will load. Press <N> if you do not want to proceed.

ROM PCI / ISA BIOS (2A59IL7E) CMOS SETUP UTILITY AWARD SOFTWARE, INC.	
STANDARD CMOS SETUP BIOS FEATURES SETUP CHIPSET FEATURES SETUP POWER MANAGEMENT SETUP PNP / PCI CONFIGURATION LOAD SETUP DEFAULTS <b>LOAD BIOS DEFAULTS</b>	INTEGRATED PERIPHERALS SUPERVISOR PASSWORD USER PASSWORD IDE HDD AUTO DETECTION HDD LOW LEVEL FORMAT SETUP EXIT WITHOUT SAVING
Load BIOS Default (Y/N)? Y	
ESC : Quit F10 : Save & Exit Setup	⏴ ⏵ ☾ ☼ : Select Item (Shift) F2 : Change Color
Load Setup Defaults except Standard CMOS SETUP	

### 3.10 INTEGRATED PERIPHERALS

When you select the “INTEGRATED PERIPHERALS” on the main program, the screen display will appear as:

#### Integrated Peripheral Setup Screen

ROM PCI / ISA BIOS (2A59IL7E)			
INTEGRATED PERIPHERALS			
AWARD SOFTWARE, INC.			
IDE HDD Block Mode	: Enabled	Onboard Parallel Port	: 378/IRQ7
IDE Primary Master PIO	: Auto	Parallel Port Mode	: SPP
IDE Primary Slave PIO	: Auto		
IDE Primary Master UMDA	: Auto		
IDE Primary Slave UMDA	: Auto		
IDE Secondary Master PIO	: Auto		
IDE Secondary Slave PIO	: Auto		
IDE Secondary Master UMDA	: Auto		
IDE Secondary Slave UMDA	: Auto		
On-Chip Primary PCI IDE	: Enabled		
On-Chip Secondary PCI IDE	: Enabled		
USB Keyboard Support	: Disabled		
KBC input clock	: 8 MHz		
Onboard FDC Controller	: Enabled		
Onboard Serial Port 1	: 3F8 / IRQ4	ESC : Quit	: Select Item
Onboard Serial Port 2	: 2F8 / IRQ3	F1 : Help	PU /PD/+/- : Modify
UART Mode Select	: Normal	F5 : Old Values ( Shift )	F2 : Color
		F6 : Load BIOS Defaults	
		F7 : Load Setup Defaults	

**IDE HDD Block Mode** : The Default setting is “Enabled”. This feature enhances the hard disk performance by making multi-sector transfers instead of one sector per transfer. Most IDE drives, except the very early design, have Block Mode transfer feature.

**IDE Primary Master PIO, IDE Primary Slave PIO, IDE Secondary Master PIO, IDE Secondary Slave PIO :** There are four IDE PIO (Programmed Input/Output) fields let you set a PIO mode (0-4) for each of the four IDE devices that the onboard IDE interface supports. Modes 0 through 4 provide successively increased performance. In Auto mode, the system automatically determines the best mode for each device.

**IDE Primary Master UMDA, IDE Primary Slave UMDA, IDE Secondary Master UMDA, IDE Secondary Slave UMDA :** Ultra DMA/33 implementation is possible only if your IDE hard drive supports it and the operating environment includes a DMA driver (Window 95 OSR2 or a third-party IDE bus master driver). If your hard drive and your system software both support Ultra DMA/33, select Auto to enable BIOS support.

**On-Chip Primary/Secondary PCI IDE :** The default setting is "Enabled". This option enables the onboard Primary /Secondary PCI IDE controller.

**USB Keyboard Support :** Select Enabled if your system contains a Universal Serial Bus (USB) controller and you have a USB keyboard.

**KBC input clock :** The system designer must select the correct frequency for the keyboard controller input clock. Do not change this value from the default value.

**Onboard FDC Controller :** Select Enabled if your system has a floppy disk controller (FDC) installed on the system board and you wish to use it. If you install an add-in FDC or the system has no floppy drive, select Disabled in this field.

**Onboard Serial Port 1 / 2:** These options are used to assign the I/O addresses for the two on-board serial ports. They can be assigned as follows:

Auto [**Default**]

3F8 / IRQ4

2F8 / IRQ3

3E8 / IRQ4

2E8 / IRQ3

Disabled (Disable the onboard serial port)

**UART Mode Select:** Select an operating mode for the second serial port:

Normal	RS-232C serial port
IrDA SIR	IrDA-compliant serial infrared port
IrDA MIR	1MB/sec infrared port
IrDA FIR	Fast infrared standard
Sharp IR	4MB/s data transmission

**Onboard Parallel Port :** This option is used to assign the I/O address for the onboard parallel port. The options are “378/IRQ7” (defaults), “278/IRQ7”, “3BC/IRQ7” and “Disabled” (disable the onboard parallel port). Note: Printer port always use IRQ7 when set to “378/IRQ7” or “278/IRQ7”, or from “3BE/IRQ7” to “Enabled”.

**Parallel Port Mode:** There are four options “Normal” (default), “ECP”, “ECP/EPP” and “EPP/SPP”. Change the mode from “Normal” to the enhanced mode only if your peripheral device can support it. When it is set to ECP mode, the printer port always uses DMA3.

### 3.11 SUPERVISOR/USER PASSWORD

The “SUPERVISOR/USER PASSWORD” utility sets the password. The SBC is shipped with the password disabled. If you want to change the password, you must first enter the current password, then at the prompt -- enter your new password. The password is case sensitive, and can be up to 8 alphanumeric characters. Press <Enter> after you have finished typing in the password. At the next prompt, confirm the new password by re-typing it and pressing <Enter> again. When you are done, the screen automatically reverts to the main screen. Remember that when you use this feature, the “Security Option” line in BIOS FEATURES SETUP will determine when entering the password will be required.

**To disable the password,** press the <Enter> key instead of entering a new password when the “Enter Password” in the dialog box appears. A message will appear confirming that the password is disabled.

If you have set both supervisor and user password, only the supervisor password allows you to enter the BIOS SETUP PROGRAM.

Note : If you forget your password, the only way to solve this problem is to discharge the CMOS memory by turning power off and placing a shunt on the S1 (open pad) for 5 seconds, then removing the shunt.



### **3.12 IDE HDD AUTO DETECTION**

If your system has an IDE hard drive, you can use this utility to detect its parameters and enter them into the Standard CMOS Setup automatically.

If the auto-detected parameters displayed do not match the ones that should be used for your hard drive, do not accept them. Press the <N> key to reject the values and enter the correct ones manually on the Standard CMOS Setup screen.

Note :If you are setting up a new hard disk drive (nothing on it) that supports LBA mode, more than one line will appear in the parameter box, choose the line that lists LBA for an LBA drive.

Do not choose Large or Normal if the hard disk drive is already fully formatted when you install it, choose the mode "HDD Low Level Format" to format it.

### **3.13 HDD LOW LEVEL FORMAT**

Select and highlight this option press the <Enter> key to enable you to perform the low level format of hard disk drive.

### **3.14 SAVE & EXIT SETUP**

Select this option and press the <Enter> key to save the new setting information in the CMOS memory and continue with the booting process.

### **3.15 EXIT WITHOUT SAVING**

Select this option and press the <Enter > key to exit the Setup Utility without recording any new values or changing old ones.

---

## **CHAPTER 4.**

### ***DRIVERS SUPPORT***

---

#### **4.1 DRIVER DISKETTE LIST**

The table below lists the drivers supported for AP-540TX

<b>Diskette No.</b>	<b>Diskette Name</b>	<b>Driver Directory Name</b>
Disk No. 1	S3 ViRGE 375	WIN 3.1 WIN 95 WIN NT3.51 WIN NT4.0

## 4.2 VGA DRIVER UTILITIES

This section describes the operation and installation of the software drivers. Below is the Windows 95 Driver Installation Procedure –

**Step 1.** Double click **My Computer** icon.

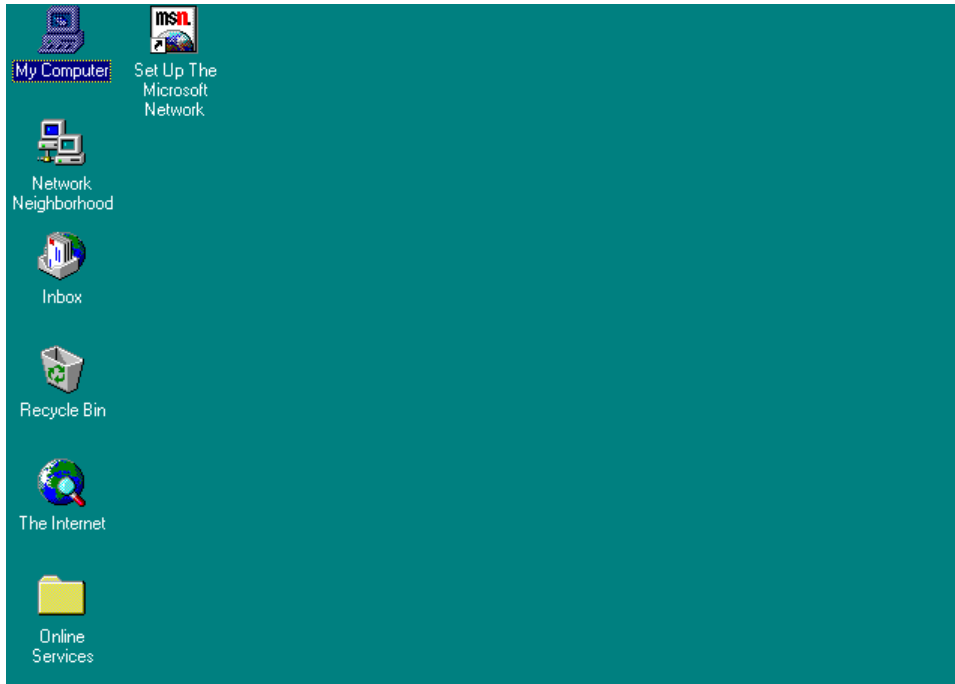

---

**Step 2.** Go back to front page of Windows 95. Click **Start**, point to **Settings**, and click **Control Panel**.

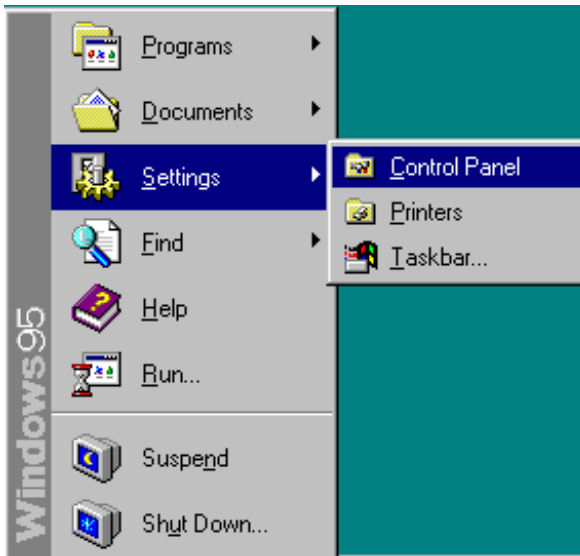

**Step 3.** Select and click **Display** icon under the **Control Panel** window.

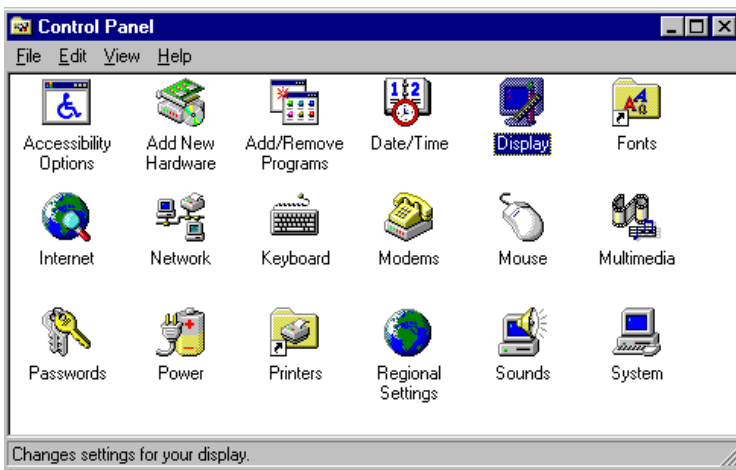

**Step 4.** In the **Display properties** window, click on the **Settings** folder.

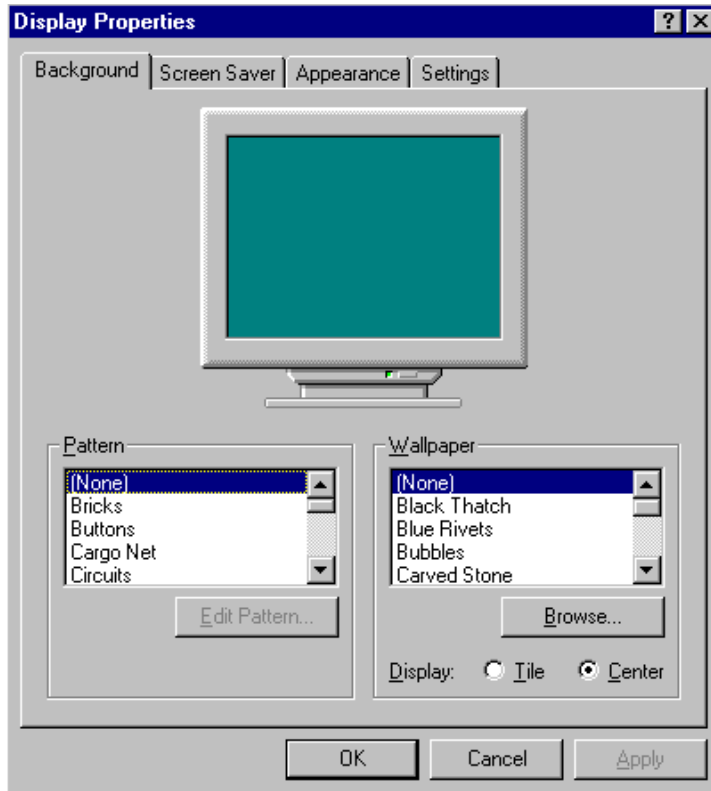

**Step 5.** The **Settings** window appears, then click on the **Advanced Properties** tab.

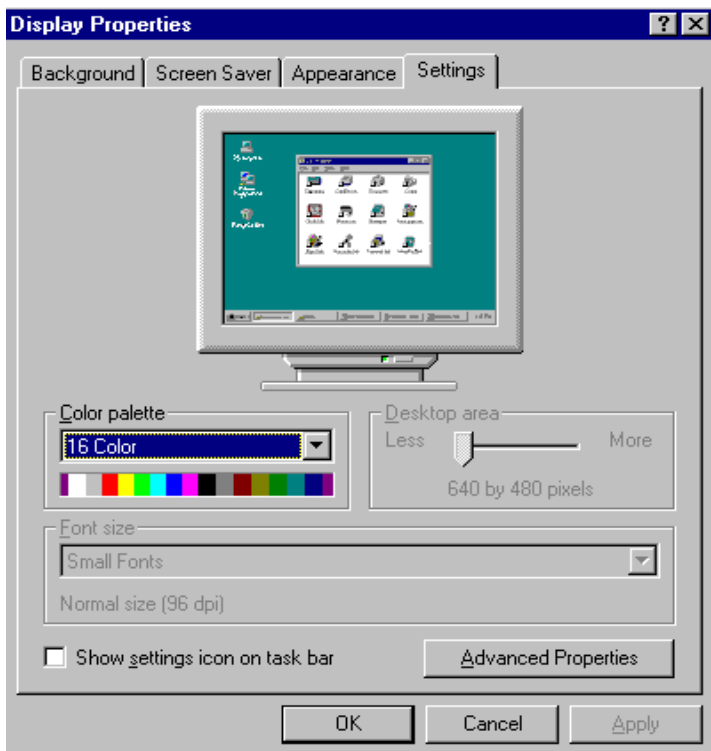

**Step 6.** In the **Advanced Display Properties**, click **Change** under **Adapter** folder.

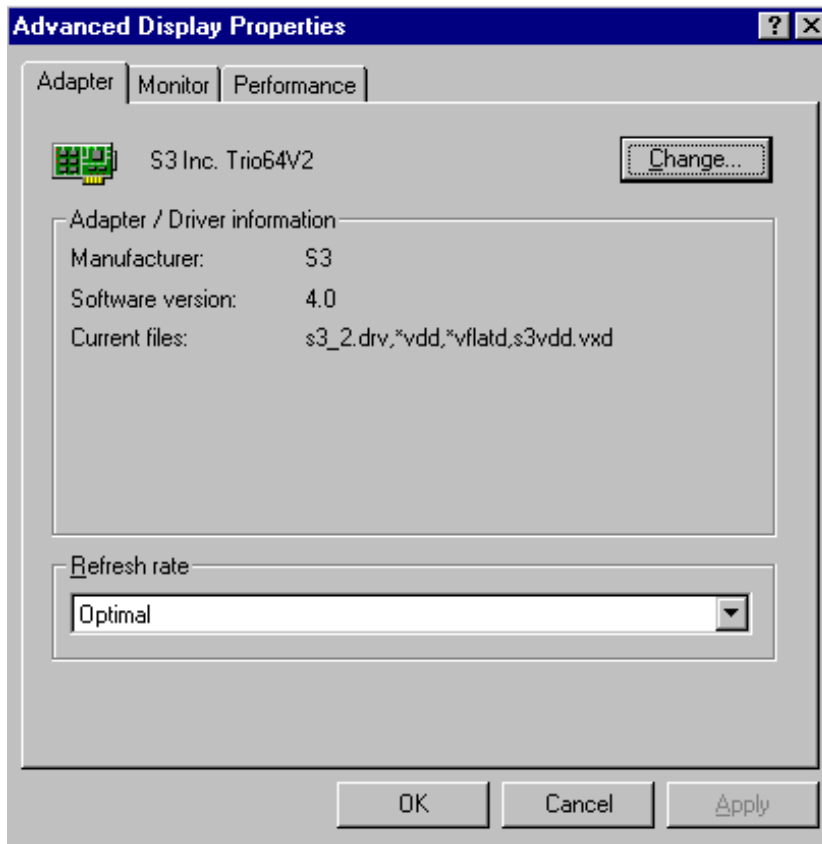

**Step 7.** When the **Select Device** window appears, select and click **Have Disk...tab**.



**Step 8.** Select and click **Browse..** tab in the **Install From Disk** window.

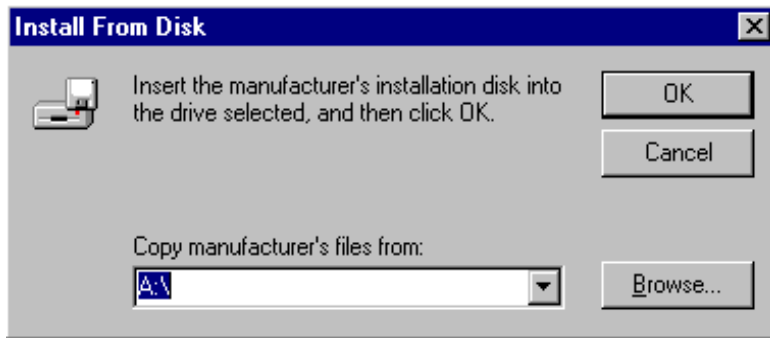

**Step 9.** The **Open** window appears as shown below. Move  tab in the dialog box of **Drives**. A pull out box showing the available drives. Select and point to **d:** and click to start reading d: drive.

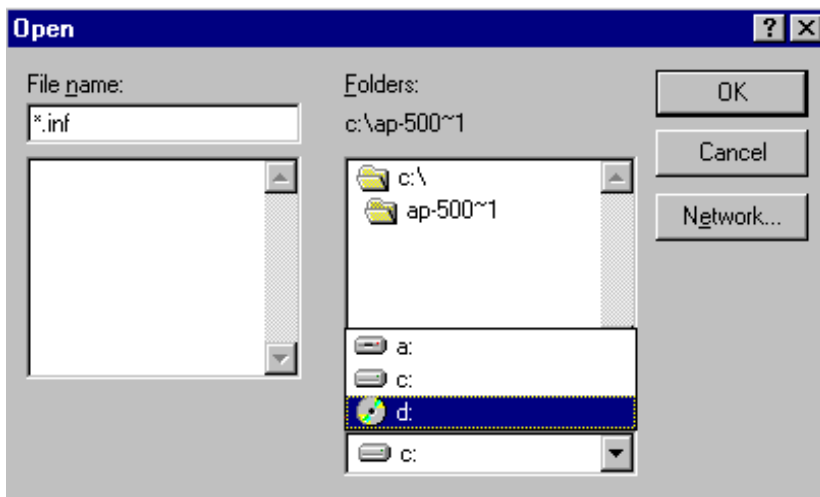

**Step 10.** Select **375** folder in the Folders dialog box.

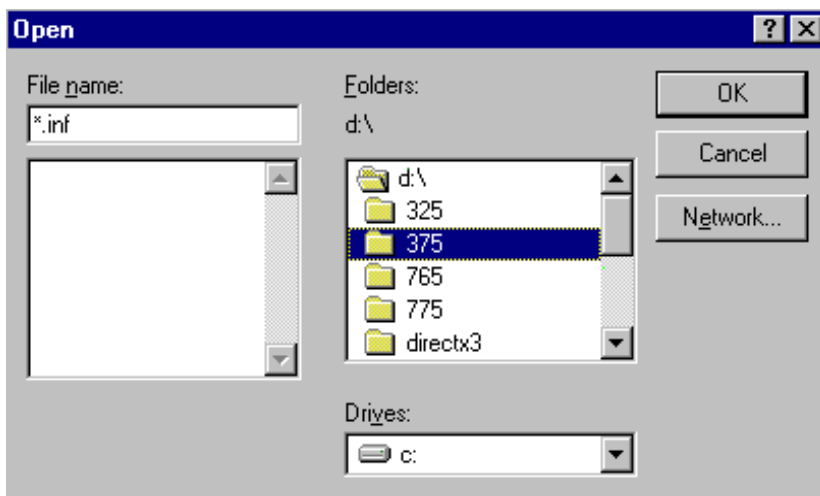

**Step 11.** The **Open** window appears, select **win95** driver.

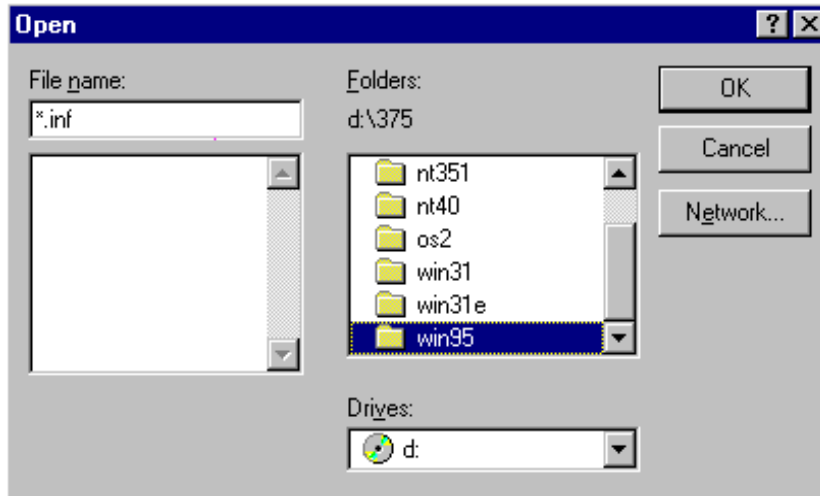

**Step 12.** Select and point to **s3virge.inf** under the **File name** dialog box. Click **OK** to proceed.

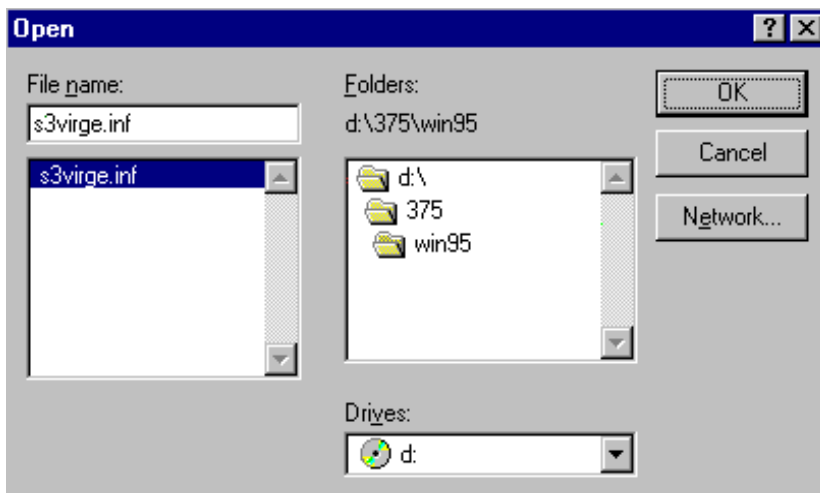

**Step 13.** When the **Install From Disk** window appears, select and click **Browse..**tab.

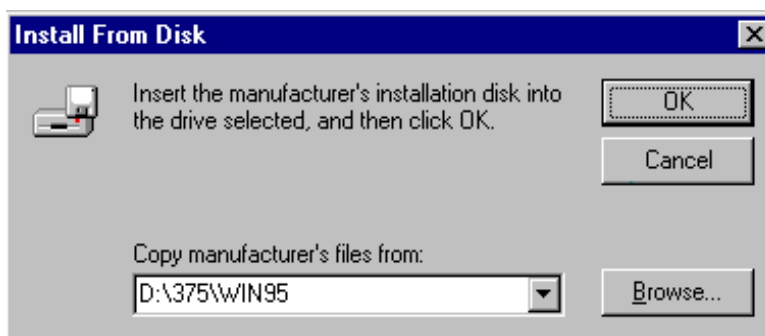



**Step 14.** Succeeded by the **Select Device** window, a file showing S3 Inc. ViRGE GX2 PCI is selected and shown in the **Models:** dialog box. Click **OK** tab to start installation.

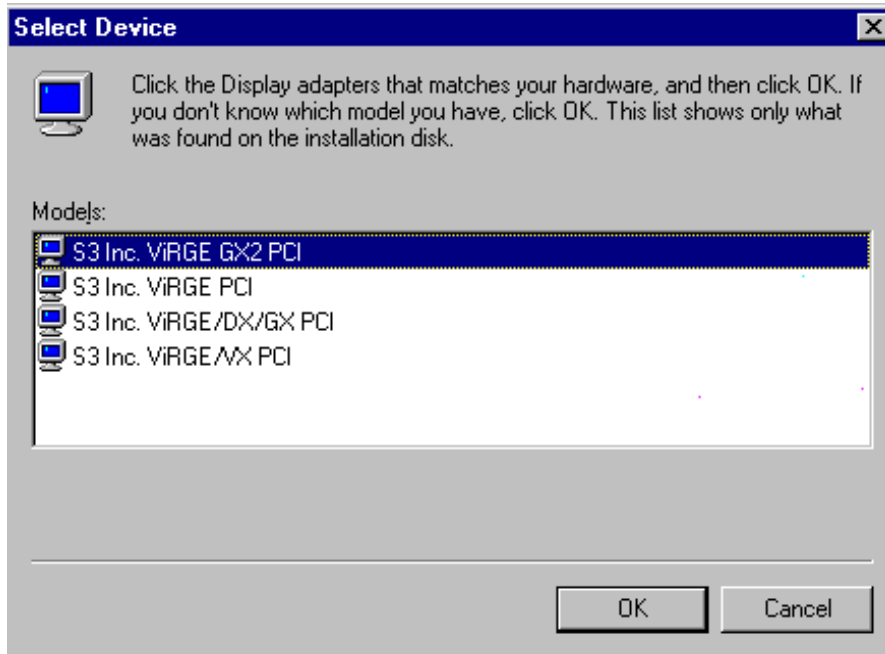

The driver program will be retrieved and install in the system.

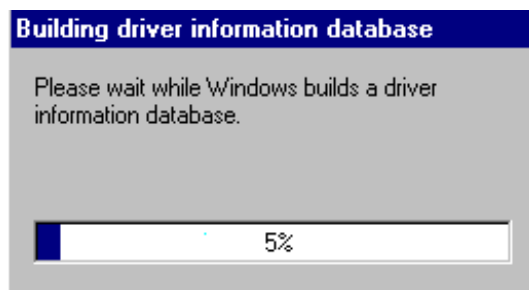

---

**Step 15.** When the installation is completed. The Advanced Display Properties windows appears to indicate the completion of the task. Point to **Close** tab and click.

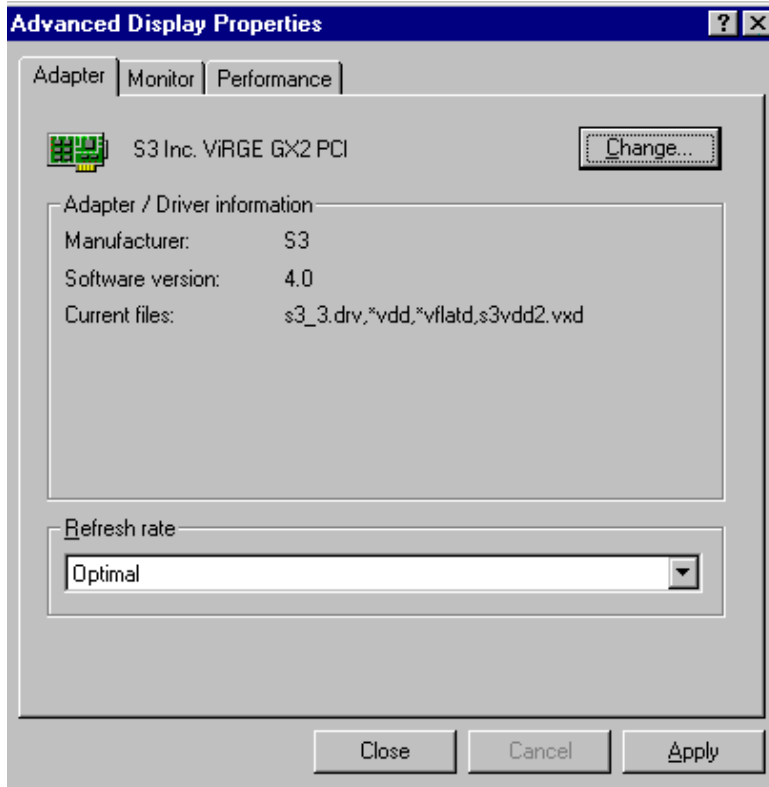

**Step 16.** After returning to the Display Properties window, point to **Close** tab and click.

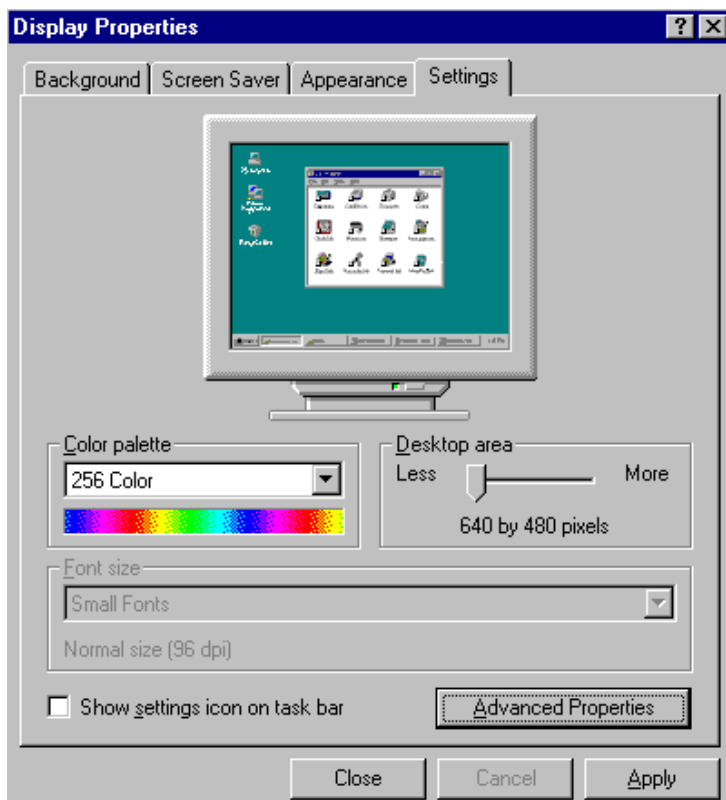

---

A window with message **System Settings Change** appears, select **Yes** tab and click to restart your computer with the proper vga setting that you have just chosen.

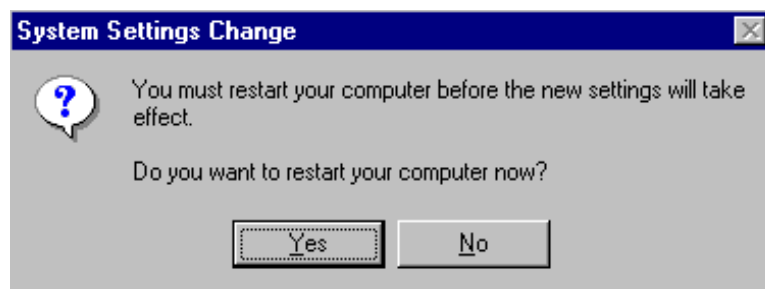

---

## **APPENDIX A.**

---

### ***HOW TO USE WATCH-DOG TIMER***

---

To use the watch-dog timer :

**Step 1.** Enable and retrigger the Watch-Dog timer: **443H**

**Step 2.** Disable: **43H**

#### **EX.1: For DOS**

Execute the **DEBUG.EXE** file under DOS, Then key-in **i443**. The system will reboot automatically according to the time-out you set.

For example, if you want to Set **4 seconds** for the time-out, you should set **JP9: 4L ON** and **J7 : 2-3 ON** to enable watch-dog timer.

```
C:\DOS> DEBUG
-i443
```

#### **EX.2: For assemble Language**

**Enable :**

```
      :
      :
MOV   DX, 443H
IN   AL, DX
```

```
      :
      :
```

**Disable :**

```
      :
      :
IN   AL, 43H
```

```
      :
      :
```

---

---

**APPENDIX B.**

---

**TECHNICAL REFERENCE**

---

**I/O PORT ADDRESS MAP**

<b>Address</b>	<b>Function</b>
000 - 01F	DMA Controller #1
020 - 03F	Interrupt Controller #1
040 - 05F	Timer Chip
043	Disable Watch-Dog Times Operation (Read)
060 - 06F	Keyboard Controller
070 - 07F	Read Time Clock/NMI Mask
080 - 09F	DMA Page Register
0A0 - 0BF	Interrupt Controller #2
0C0 - 0DF	DMA Controller #2
0F0 - 0F1	Clear/Reset Math Coprocessor
1F0 - 1F7	Hard Disk Controller
200 - 210	Game Port
278 - 27F	Parallel Port #2
2E8 - 2EF	Serial Port #4 (COM 4)
2F8 - 2FF	Serial Port #2 (COM 2)
300 - 31F	prototype Card/Streaming Tape Adapter
360 - 36F	PC Network
378 - 3FF	Parallel Port #1
380 - 38F	SDLC #2
3A0 - 3AF	SDLC #1
3B0 - 3BF	MDA Video Card (Including LPT0)
3C0 - 3CF	EGA Card
3D0 - 3DF	CGA Card
3E8 - 3EF	Serial Port #3 (COM 3)
3F0 - 3F7	Floppy Disk Controller
3F8 - 3FF	Serial Port #1 (COM 1)
443	Enable Watch-dog Timer Operation (read)

---

## MEMORY ADDRESS MAP

Address Range (Hex)	Description
000000H - 09FFFFH	640 KB of Conventional RAM
0A0000H - 0BFFFFH	128 KB of Video RAM
0C0000H - 0EFFFFH	256 KB of I/O Expansion ROM
0F0000H - 0FFFFFFH	64 KB of System BIOS ROM
0100000H - 7FFFFFFFH	1 MB ~ 128MB of User RAM

## DMA CHANNELS

CHANNEL	Function
DMA 0	Reserved
DMA 1	Reserved
DMA 2	Floppy Disk Controller
DMA 3	ECP Parallel Port
DMA 4	Cascade for DMA #1
DMA 5	Reserved
DMA 6	Reserved
DMA 7	Reserved

## INTERRUPT CONTROLLER

IRQ	Function
IRQ 0	System timer output
IRQ 1	Keyboard
IRQ 2	Cascade for INTC #2
IRQ 3	Serial port #2
IRQ 4	Serial port #1
IRQ 5	Parallel port #2
IRQ 6	Floppy disk controller
IRQ 7	Parallel port #1
IRQ 8	Real time clock
IRQ 9	Software redirected to INT 0AH (IRQ 2)
IRQ 10	Reserved
IRQ 11	Reserved
IRQ 12	PS/2 Mouse
IRQ 13	Math Coprocessor (CPU Internal)
IRQ 14	Primary Hard disk
IRQ 15	Secondary Hard Disk
NMI	Parity Check Error

**GLOSSARY**

**8-Bit Bus** – Data is transmitted to expansion slots and other components on the bus only along 8 parallel data line.

**10Base-T** – It is a 10Mbps IEEE 802.3/Ethernet standard that uses unshielded twisted pair cable specification. 10Base-T supports network configuration using the CSMA/CD access method over a twisted pair transmission system up to 100 meters in length without the use of repeater.

**16-Bit Bus or ISA Bus** – Data is transmitted along either 8 or 16 data lines, depending on what kind of adapter card is used in an expansion slot. ISA is the abbreviation of Industry Standard Architecture.

**100Base-TX** – It is a 100Mbps IEEE 802.3/Ethernet standard that uses UTP cable. Also called Fast Ethernet, it uses RJ-45 connectors and EIA/TIA T568B pinning. Maximum cable length from hub to node is 100 meters without a repeater.

**Adapter** – It is also called an expansion board, expansion card, or adapter card. It is a small circuit board that is installed in the expansion slots on the motherboard. You can install a particular adapter that connects a new device such as internal modem, sound card, and scanner.

**AGP (Accelerated Graphic Port )** – is a 32-bit, 66MHz data bus that transmit a maximum of 528MB of data.

**bps** – Bits per second. Also often preceded by K (kilo/thousands), **Kbps** – Kilo bytes per second, and M (mega/million), **Mbps** – Mega bytes per second.

**BIOS (Basic Input /Output System)** – This is a chip on the motherboard that contains the instructions for starting up, or booting, the computer, and more.

**Bus** – Data that travels in a computer along the circuits on the motherboard are called buses. Although three main buses (data bus, address bus, and control bus) manage the computer's operation, often these are collectively called the bus. The bus carries instructions back and forth between the CPU and other devices in the system. ISA, EISA, VL-Bus, PCI and SCSI are examples of PC buses.



**Bus Mastering** – A method of transferring data through a bus in which the device takes over the bus and directly controls the transfer of data to the computer's memory. Bus mastering is a method of Direct Memory Access (**DMA**) transfer.

**Cache** – Cache RAM is an extra holding area for program instructions that need to be frequently used by the CPU or swapped in and out of RAM. Your CPU can usually access those instructions from the cache more quickly than it could from a hard disk or even RAM, so a cache helps the system work more efficiently. Most systems sold today offer either 256K or 512K cache.

**CPU (Central Processing Unit)** – executes all commands and controls the flow of data, providing the “ brain ” that enables the PC to calculate and perform the operations like sorting information more quickly than a human could. The CPU makes perhaps the greatest contribution to a PC's speed and power. Note: Any additional information is subject to change without prior revision from the supplier.

**Table 1 -- CPU Speeds**

Processor type	Speed ratings (MHz)
486DX2	66, 80
486DX4	75, 100, 120
Pentium	90, 100, 120, 133, 166, 200
Pentium MMX	166, 200, 233
Pentium Pro	166, 180, 200
Pentium II	233, 266, 300, 333

**EIDE (Enhanced IDE)** – It is a hard drive controller that enables your system to be able to handle fast hard disk drives at a speed of 10Mbps.

**EISA or MCA Bus** – Data is transmitted along 32 data lines to adapter cards designed specifically to work with the 32-bit buses. MCA expansion slots cannot accept 8-bit or 16-bit adapter cards. EISA stands for Extended Industry Standard Architecture, while MCA stands for MicroChannel Architecture. MCA is architecture used in IBM Microcomputer.

**Expansion slots** – Expansion slots are plug-in connectors that allow you to insert additional circuit boards that attach to the rest of the PC through special circuitry called the **bus**. By inserting the right circuit board -- usually called an **adapter** or an **expansion card** – you can increase the resolution and the number of colors used by the display, or you can transform your PC into a machine for recording and playing music.

**Fast SCSI** – The common nomenclature associated with SCSI-2, the second generation of SCSI offering mandatory parity checking improvements over SCSI-1.

**IDE (Integrated Drive Electronics)** – It was developed from ST-506 type hard drive interface, utilizes BIOS INT 13h hard drive secondary software and supports two hard drives (Master and Slave). Do not need extra software to drive since it is directly initiated in the BIOS. Data transfer rate is 4.1 Mbps. Take note that this interface cannot support other drive like CD-ROM drive.

**IEEE (Institute of Electrical and Electronic Engineers)** – It is an international professional society that issues its own standard, and is a member of ANSI and ISO. Popular known standards is:

- IEEE802.3** – is a physical layer standard for 10Base-T, 100Base-T, Ethernet, and StarLAN.
- IEEE802.5** – is a physical layer standard for Token Ring.
- IEEE802.11** – is a physical layer standard for Wireless LAN/WAN compatibility.
- IEEE802.12** – is a physical layer standard for 100VG AnyLAN.

**LAN (Local Area Network)** – A data communications network spanning a limited area. It provides communications between three or more computers and peripherals, in most cases using a high-speed media as it's backbone.

**Keyboard** – This is a component that comes in direct contact for you with your PC. The mechanism of keyboard converts a key cap's movement into a signal sent to the computer. The most common key mechanism are “ **capacitate** ” and “ **hard contact** ”. Capacitate keyboard has a spring that causes the plastic and the metal plunger to move nearer to two pads that have large plates (plated in tin, nickel, and copper). These pads are connected to the keyboard's printed circuit board. Hard contact keyboard causes the key cap to collapse a foam rubber dome that presses against a sheet of

---

plastic on the bottom of which is metallic area connected to the rest of the keyboard's circuit board.

**LDCM (LANDesk Client Manager)** – With the help of LDCM, PCs that are either stand-alone or on a network can not escape the control of a system administrator. Alerts will be sent to the user if an abnormal condition is encountered in a PC. It allows the administrator to give each PC a thorough check-up. Additionally, this feature is available to multiple OS's on the market today. LDCM Key Features include the following : ■ Health Monitoring , ■ Real-Time Alerting , ■ Remote Accessibility , ■ Extensive Instrumentation. This is a product from Intel.

**Mouse** – The keyboard is a barrier to learn how to use a computer. Xerox Corporation first developed the concept of a pointing device, something a computer user could move with his or her hand, causing a corresponding move on screen. Because of its size and tail like cable, the device was named for the mouse. Apple Computer made the mouse a standard feature of its Macintosh computers, and with the popularity of Windows, a mouse is becoming standard equipment on all PCs, as well. The “ **Trackball** ” have survived more awkward methods of navigating with the keyboard. “ **Digitizing tablets** ” are popular with architects and engineers who must translate precise movements of a pen into lines on the screen. “ Touch screens “ , on which you press either your finger and a special light pen to control the software, are too tiring to use for any length of time.

**MMX** – CPU's with MMX technology are optimized to run multimedia application, and therefore, offer faster multimedia playback than standard CPUs. However, when manufacturers introduce any new hardware technology, the software makers need to catch up. At this time of compilation, most applications can't yet take advantage of MMX capabilities.

**Parallel port** – Parallel ports (labeled **LPT1**, **LPT2**, and so on) are usually for plugging in printers. It is also often called a **Centronics port** – has been almost synonymous with **printer port**. Although a serial port can also be used to send data from a PC to some models of printers, the parallel port is faster. A serial port sends data one bit at a time over a single one-way wire; a parallel port can send several bits of data across eight parallel wires simultaneously. Take note that a serial connection sends a single bit, a parallel port send an entire byte. A parallel connection has one drawback.

**PCI Bus (Peripheral Component Interconnect)** – It is a connection slot in a motherboard that supports 32-bit bus transfer rates. The now standard PCI Local Bus carries data along at least 32 lines, that is, at least 32 bits at a time. Local bus computer designs add special buses so the CPU can communicate directly with key components like the monitor, resulting in much better performance. You should look for PCI local bus capabilities in any system you buy, especially PCI local bus video (which helps the monitor display more quickly).

**POST (Power-On Self-Test)** – is the first thing your PC does when you turn it on, and it's your first warning of trouble with any of the components. When the POST detects an error from the display, memory, keyboard, or other basic components, it produces an error warning in the form of a message on your display and—in case your display is part of the problem—in the form of a series of beeps.

**RAM (Random Access Memory)** – consists of a bank of chips that act as “ working memory ”, holding program instructions and data only while your computer's on. Unless the instructions and data are saved to a disk, RAM forgets them when you turn your computer off. RAM is measured in megabytes (M). Most computers today come with 32M of RAM, though some sell with only 16M installed. There are a few different flavors and speeds of RAM, as well. One of the most prominent today is Extended Data Output ( EDO ) RAM, but an even faster type of RAM that has just hit the market is called **SyncDRAM**.

**Serial port** – Serial ports are also sometimes called **COM** (short for COMmunications) ports, and are labeled **COM1**, **COM2**, and so on. It is simple in concept: one line to send data, another line to receive data, and a few other lines to regulate how data is sent over the other two lines – from commonplace modems and printers to plotters and burglar alarms. The most common use for serial port is with a **mouse** or **modem**. The reason for this is that a serial port is not a very efficient way to transfer data, so little data that speed is not crucial, and perfect for modems because. With current technology, phone lines cannot transport more than one signal at a time anyway. The **serial port** is often referred to as an **RS-232 port**.

**SCSI (Small Computer System Interface)** – An intelligent bus for transmitting data commands between a variety of devices. There are many implementations of SCSI, including Fast SCSI, Wide SCSI, Fast Wide SCSI, Fast-20, and Fast-40.

---

**SCSI-2** – The second generation of SCSI; includes many improvements to SCSI-1, including Fast SCSI, Wide SCSI, and mandatory parity checking.

**SCSI-3** – The third generation of SCSI; introduces Fast-20 and Fast-40 as improvements to the parallel bus. The standard also includes a number of specifications for high-speed serial bus architectures such as SSA, Fiber Channel, and IEEE 1394. Also known as Ultra SCSI.

**Ultra SCSI** – Also known as SCSI-3, is a third generation SCSI standard that introduced parallel bus speed improvements (FAST-20 and FAST-40), and the miniaturized 68-pin micro connector.

**USB (Universal Serial Bus)** – USB consolidates serial, parallel, keyboard, mouse, and game ports into one asynchronous and isochronous communications port with bandwidth for data transfer speeds up to 12 Mbps without termination. By daisy-chaining USB hubs, up to 127 I/O devices can be connected to one USB port on the PC. USB is completely plug-and play meaning peripherals can be correctly detected and configured automatically as soon as they are connected.

**UTP (Unshielded Twisted Pair)** – Twisted pair cable with neither individual nor overall shielding. **Twisted Pair** are two wires twisted together to reduce susceptibility to RF crosswalk.

**VGA (Video Graphics Array)** – A video adapter that supports 640x480 pixels color resolution. The Windows OS provides medium text & graphics standard.

**VL-Bus** – It is also known as Local Bus; this is an I/O interface that is directly connected and depended of the system CPU. The VL-Bus is an abbreviation of VESA Local Bus.

# Terms and Conditions

---

Date:1997.10.20

## Warranty Policy

1. All products are warranted against defects in materials and workmanship on a period of two years from the date of purchase by the customer.
2. The buyer will bear the return freight charges for goods that are returned for repair within the warranty period whereas manufacturer will bear the other way after repair.
3. The buyer will pay for repair (for the replaced materials plus service time) and transportation charges (both ways) for items after the expiration of the warranty period.
4. If the RMA Service Request Form does not meet the stated requirement as listed on "RMA Service " , RMA goods will be returned at the customer expense.
5. The following conditions are excluded from this warranty :
  - A. Improper or inadequate maintenance by the customer.
  - B. Unauthorized modification or misuse.
  - C. Operation outside of the environmental specifications for the product.

## RMA Service

### 1. **Request a RMA# :**

Complete and fax to Supplier the "RMA Request Form" to obtain a RMA number.

### 2. **Shipping:**

- A. The customer is requested to fill up the problem code as listed . If none of the code is selected, please write the symptom description on the remark.
- B. Ship the defective units with freight prepaid.
- C. Mark the RMA # clearly on the box.
- D. Shipping damage as a result of inadequate packing is the customer's responsibility.
- E. Use the original packing materials whenever possible .

### 3. **All RMA# are valid for 30 days only:**

When RMA goods are received after valid RMA# period , the goods will be rejected.

# RMA Service Request Form

Date: 1997.10.20

**When requesting RMA service, please fill out this "RMA Service Request Form". This form needs to be shipped with your returns. Service cannot begin until we have this information.**

Company: Phone No. Fax No.: Return Shipping Address _____ _____	Person to contact: Purchased Date: Applied Date:
---	--

<b>*For Supplier only</b>	<b>RMA No:</b>  <b>Account Sales:</b>
---------------------------	---

Model No.	Serial No.	Problem Code	Remark
			*This form could be copied for more description

**\*Problem Code:**

- |                        |                              |                            |
|------------------------|------------------------------|----------------------------|
| 01: D.O.A.             | 06: HDC Fail                 | 11: Memory Socket Bad      |
| 02: Second Time R.M.A. | 07: Bad Slot                 | 12: Hang Up Hardware       |
| 03: No Screen          | 08: BIOS Problem             | 13: Hang Up Software       |
| 04: CMOS Data Lost     | 09: Keyboard Controller Fail | 14: Other ( Pls. Specify ) |
| 05: FDC Fail           | 10: Cache RMA Problem        |                            |

**Request Party**

**Confirmed By Supplier**

**Authorized Signatures**

**Authorized Signatures**