

TYAN™

Tiger 230 S2507

Motherboard User's Manual Revision 1.01

Copyright © Tyan Computer Corporation, 2000. All rights reserved. No part of this manual may be reproduced or translated without prior written consent from Tyan Computer Corp.

All registered and unregistered trademarks and company names contained in this manual are property of their respective owners including, but not limited to the following.

Tiger 230 S2507 is a trademark of Tyan Computer Corporation.

AwardBIOS is a trademark of Phoenix Software.

Windows is a trademark of Microsoft Corporation.

IBM, PC, AT, PS/2 are trademarks of IBM Corporation.

Intel, Pentium III are registered trademarks of Intel Corporation.

VIA, Apollo Pro 133A are trademarks of Via Technologies, Inc.

Information contained in this document is furnished by Tyan Computer Corporation and has been reviewed for accuracy and reliability prior to printing. Tyan assumes no liability whatsoever, and disclaims any express or implied warranty, relating to sale and/or use of Tyan products including liability or warranties relating to fitness for a particular purpose or merchantability. Tyan retains the right to make changes to product descriptions and/or specifications at any time, without notice. In no event will Tyan be held liable for any direct or indirect, incidental or consequential damage, loss of use, loss of data or other malady resulting from errors or inaccuracies of information contained in this document.

Table of Contents

Chapter 1: Introduction	Page 4
1.1 Overview	4
1.2 Hardware Specifications	5
1.3 Software Specifications	6
1.4 Technical Support	7
1.5 Returning Merchandise for Service	7
Chapter 2: Board Installation	8
2.1 Unpacking	8
2.2 Installation	8
2.3 How to install our products right... the first time	8
2.4 Quick Reference for Jumpers	10
2.5 Map of Motherboard Jumpers	11
2.6 Setting Jumpers	12
2.6-A Front Panel Connector	12
2.6-B CMOS Reset	12
2.6-C USB Connector	12
2.6-D Cooling Fans	12
2.6-E Wake on LAN	13
2.6-F Wake on Modem	13
2.6-G Chassis Intrusion	13
2.6-H CPU Frequency Settings	13
2.6-I Infrared Reserved	13
2.6-J Soft Power Connector	14
2.6-K Hardware Reset Switch Connector Installation	14
2.6-L Flash Utility	14
2.7 Mounting the Motherboard in the Chassis	15
2.8 Installing Memory	16
2.9 Installing the CPU and Cooling Fan	17
2.10 Connecting IDE and Floppy Drives	20
2.11 Installing Add-on Cards	22
2.12 Connecting PS/2, USB, and Serial Port 1	23
2.13 Connecting the Power Supply	24
2.14 Frequently Asked Questions (FAQ)	25
Chapter 3: BIOS Setup	26
Introduction to the BIOS Setup	26
Starting Setup	26
Setup Keys	27
Getting Help	27
In Case of Problems	27
Setup Variations	28
General Help	28
3.1 Main Setup	28
3.2 Standard CMOS Setup	28
3.2-A Date/Time	28
3.2-B IDE Primary/Secondary Master/Slave	28
3.2-C Table of IDE Device Settings	29
3.2-D Memory	30

3.3	Advanced BIOS Features	30
3.4	Advanced Chipset Features	32
3.5	Integrated Peripherals	33
3.6	Power Management Setup	34
3.7	PnP/PCI Setup	35
3.8	PC Health Status	36
3.9	Set Supervisor / User Password	36
3.10	Flash Utility	37
Chapter 4: System Resources		38
4.1	Beep Codes	38
4.2	Displayed Error Messages	38
Appendix I: Glossary		41

Chapter 1: Introduction

1.1 Overview

The Tiger 230™ is a high performance motherboard designed for server and performance applications that require the power of dual Intel® Pentium® III FC-PGA processors or a single Celeron® FC-PGA processor. This motherboard utilizes the VIA Apollo Pro 133A chipset and can support CPU speeds of 500 MHz through 1 GHz and front side bus speeds of 100 MHz or 133 MHz. Please see Tyan's website for updates and information concerning CPU information and support:

<http://www.tyan.com>

This integrated performance board is supported in an ATX form factor. Some of the features included are onboard UltraDMA-33/66/100 support, and sound bridge with integrated hardware monitoring.

With I/O and drive controller support onboard, the one 2x/4x mode AGP slot and five 32-bit PCI v2.2 slots are free for numerous types of add-on expansion cards. The four 168-pin DIMM sockets can support up to 2GB* of PC100 memory or 1.5GB* of PC133 SDRAM.

Remember to visit Tyan's website at **<http://www.tyan.com>**. There you can find information on all of Tyan's products with FAQs, distributors list, and BIOS settings explanations.

* 2.0GB total memory @ 4 DIMMs only, when using 100MHz SDRAM
1.5GB total memory @ 3 DIMMs only, when using 133MHz SDRAM
Check the Tyan website for details on memory compatibility: **<http://www.tyan.com>**

1.2 Hardware Specifications

Processor Information	Dual ZIF PGA370 Socket Intel Pentium III, Celeron (only single socket) FC-PGA Onboard VRM Front side bus support for 100 or 133MHz
Expansion Slots	One 2x/4x mode AGP slot Five 32-bit PCI v2.2 compliant slots Total six usable slots
Chipset Information	VIA Apollo Pro 133A chipset (VT82C694X and VT82C686B)
Hardware Monitoring	Integrated hardware monitoring 3-pin Fan Monitoring headers 2-pin External SCSI LED header Temperature and Voltage Monitoring 3-pin Wake on Modem header
Memory	Four 168-pin 3.3V DIMM sockets Supports up to 2GB @ 100MHz (4 DIMMS) Supports up to 1.5GB @ 133MHz (3 DIMMS) Supports PC100/133 SDRAM
Integrated PCI IDE	Two channel master mode Supports up to four Enhanced IDE devices Support for UltraDMA-33/66/100 IDE devices and ATAPI compliant devices
Integrated I/O	One floppy connector for up to two drives Two 9-pin UART serial ports One 25-pin ECP/EPP parallel port Four USB ports (two ports via cable - optional*) PS/2 mouse and keyboard ports
BIOS	Award BIOS 2 Mbit Flash Auto-detection of memory size Auto-configuration of IDE hard disk types User settings of hardware monitoring Multiple boot options DMI 2.0 compliant
Form Factor	ATX 2.03 12" x 9.6" (304.8 x 243.84 mm) One 20-pin ATX power connector Stacked mouse & keyboard ports Stacked two USB ports Two serial ports
Regulatory	FCC Class B (Declaration of Conformity) European Community CE (Declaration of Conformity) Taiwan BSMI Notice (Declaration of Conformity)

* extra accessories can be purchased at the Tyan Online Store: <http://www.etyan.com>

1.3 Software Specifications

OS

Operates with Windows 98/SE/ME,
Windows NT/2000

1.4 Technical Support

If a problem arises with your system, you should turn to your dealer for help first. Your system has most likely been configured by them, and they should have the best idea of what hardware and software your system contains. Hence, they should be of the most assistance. Furthermore, if you purchased your system from a dealer near you, you can actually bring your system to them to have it serviced, instead of attempting to do so yourself (which can have expensive consequences).

Help Resources:

1. See the FAQ and beep codes section of this manual.
2. See the Tyan website for FAQ, bulletins, driver updates, and other information: <http://www.tyan.com>
3. Contact your dealer for help **BEFORE** calling Tyan.
4. Check the Tyan user group: alt.comp.periphs.mainboard.tyan

1.5 Returning Merchandise for Service

During the warranty period, contact your distributor or system vendor **FIRST** for any product problems. This warranty only covers normal customer use and does not cover damages incurred during shipping or failure due to the alteration, misuse, abuse, or improper maintenance of products.

NOTE: A receipt or copy of your invoice marked with the date of purchase is required before any warranty service can be rendered. You may obtain service by calling the manufacturer for a Return Merchandise Authorization (RMA) number. The RMA number should be prominently displayed on the outside of the shipping carton and the package should be mailed prepaid. Tyan will pay to have the board shipped back to you.

Chapter 2: Board Installation

2.1 Unpacking

The retail motherboard package should contain the following:



Tiger 230 motherboard



34-pin floppy cable



ATA-66/100 IDE cable (with blue connector)



Tiger 230 user's manual



Tyan driver CD

2.2 Installation

You are now ready to install your motherboard. The mounting hole pattern of the Tiger 230 matches the ATX board specifications, so your chassis must be capable of supporting an ATX board (check the motherboard dimensions provided on [p. 5](#)).

2.3 How to install our products right.. the first time.

Question: what's the first thing I should do?

The first thing you should do is read the user's manual. It contains important information which will make configuration and setup much easier, as well as provide information on device installation and component set up.. By reading through the manual completely before installing your motherboard, you will have a complete overview on the installation.

Here are some safety tips:

- (1) **Ground yourself properly before removing your motherboard from the antistatic bag.** Unplug the power from your computer power supply and touch any metal part on the computer case. (You might also want to wear a grounded wrist strap.)
- (2) **Hold the motherboard by its edges and do not touch the bottom of the board.**
- (3) **Avoid touching motherboard components, IC chips, connectors, and leads.**
- (4) **Avoid touching pins of memory modules and chips.**
- (5) **Place motherboard on a grounded antistatic surface or on the antistatic bag.**

Having reviewed the precautions above, the next step is to take the motherboard out of the cardboard box and static bag, hold it by its edges, and place it on a grounded antistatic surface, component side up. Inspect the board for damage.

NOTE:**DO NOT APPLY POWER TO THE BOARD IF IT HAS BEEN DAMAGED!**

Press down on any of the socketed ICs if it appears that they are not properly seated (the board should still be on an antistatic mat). Do not touch the bottom of the board. Remember, don't take any electronic device out of its protective bag until you are ready to actually install it into the computer case. If you do not ground yourself, you risk zapping the motherboard or adapter card. Subsequent problems may not arise immediately because electrostatic discharge, unlike physical damage, causes the device to fail over time.

Installation Steps

1. Set jumpers (if necessary)
2. Mount motherboard in chassis
3. Install memory
4. Install CPU and cooling fan(s)
5. Connect IDE and floppy drives
6. Install add-on cards
7. Connect PS/2, USB, and serial devices

2.4 Quick References for Jumpers

In this manual, the term “closed” and “on” are used when referring to jumpers (or jumper pins) that are active; “open” and “off” are used when referring to jumpers (or jumper pins) that are inactive. See **Figure 2.0a** and **Figure 2.0c** for examples of “on” and “off” pins and jumpers.

Jumpers and pins are connected by slipping the plastic jumper connector over the top of two adjacent jumper pins (indicated by 1-2 or 2-3). The metal rod inside the plastic shell bridges the gap between the two pins, completing the circuit. See **Figure 2.0b** and **Figure 2.0d** for more examples of 3-pin jumper connections. NOTE: The small number “1” indicates pin 1.

The tables and maps on the following pages will help you set the jumpers for CPU speed, infrared, and external connector pin assignments, among others. The miniature motherboard maps will help you locate the jumpers on your board. Full page maps of the motherboard can be found on the next two pages.

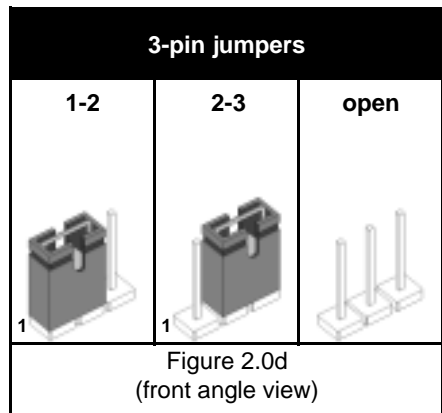
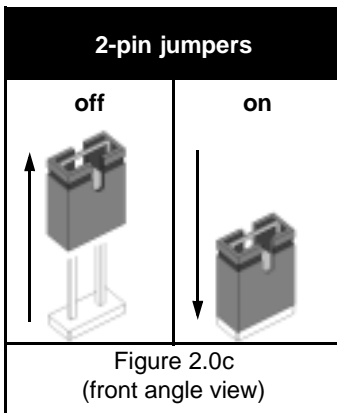
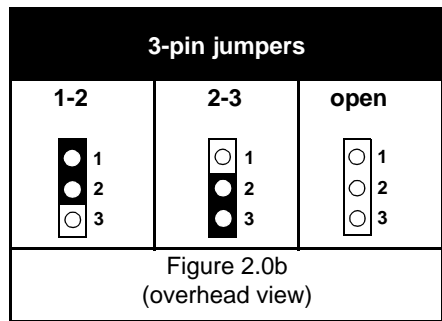
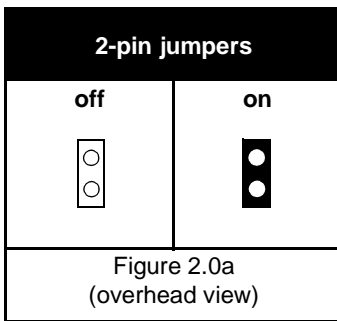

2.5 Map of Motherboard Jumpers

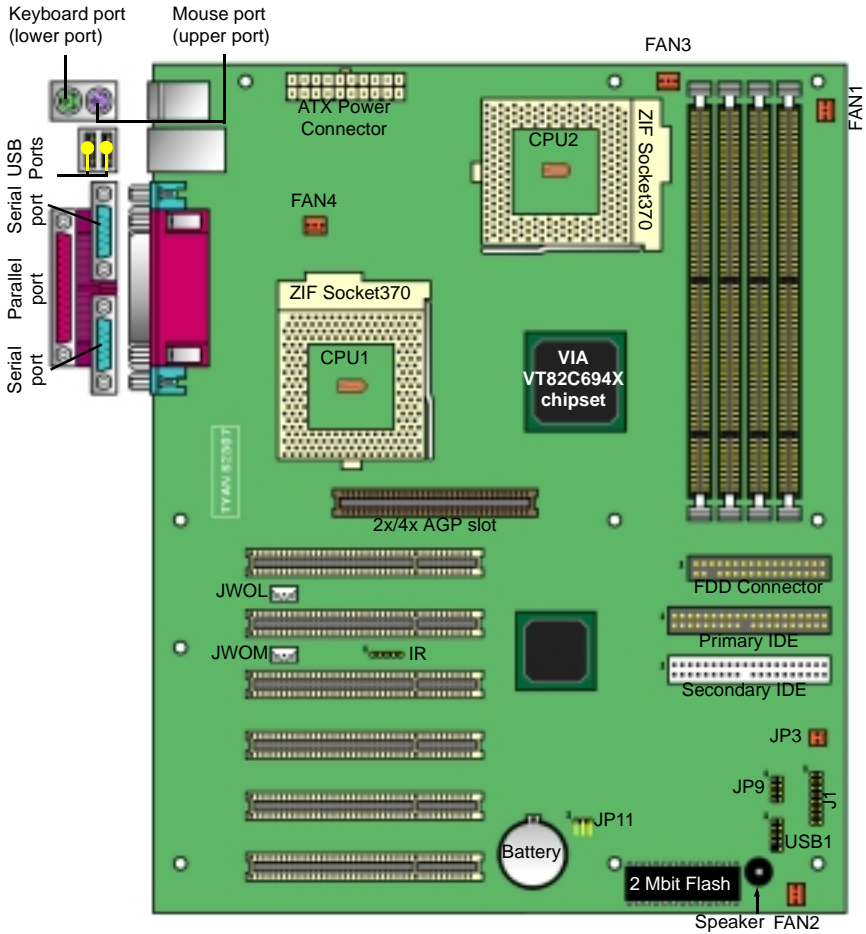

INSTALL

2.6 Setting Jumpers

2.6-A. Front Panel Connector (J1)

HDD LED	VCC	1	2	Pwr LED+	Pwr/Slp LEDs
	LED	3	4	Slp LED+	
Reset Switch	Ground	5	6	Switch	Power Switch
	Switch	7	8	Ground	
Infrared	IR +5V	9	10	SN_NMI	
	IR RX	11	12	Ground	
	Ground	13	14	no connect	
	IR TX	15	16	no connect	

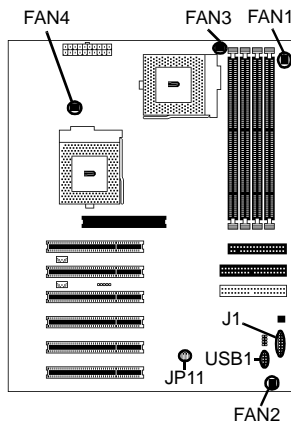

2.6-B. CMOS Reset (JP11)

JP11	1-2	2-3
	Normal	Clear

If you have been locked out of your system because you forgot your password or set the CMOS incorrectly, or have just finished flashing your BIOS follow the instructions below.

1. Power off the system, and disconnect the power supply
2. Close pins 2-3 on JP11 (see mini-map for location of JP11)
3. Wait about three seconds
4. Move jumper back to 1-2, then power on the system again

By following this procedure, you will erase your password and reset the CMOS.

2.6-C. USB Connector (USB1)

This connector is for the additional USB connector* (which adds two more ports on a second USB channel).

2.6-D. Cooling Fans (FAN1, FAN2, FAN3, FAN4)

FAN	1	2	3
	Ground	+12V	Speed

In addition to installing your CPU, Tyan highly recommends that you install a CPU fan/heatsink combination, and if needed, additional chassis fans. To this end Tyan has provided several connectors to power the fan(s), as well as the fan pinout (shown above). Here is some information you may find useful:

- We recommend you use FAN3 and FAN4 for the CPU cooling fans
- All other fan connectors are left to the user's discretion

* extra accessories can be purchased at the Tyan Online Store: <http://www.etyan.com>

2.6-E. Wake on LAN (JWOL)

This is the connector for the Wake on LAN function.

2.6-F. Wake on Modem (JWOM)

This is the connector for the Wake on Modem function.

2.6-G. External SCSI LED (JP3)

If your peripheral supports a feature for chassis intrusion, you can use this connector to use that feature. If activity is detected from the peripheral and this feature is connected, the activity will be displayed on the chassis front side LED.

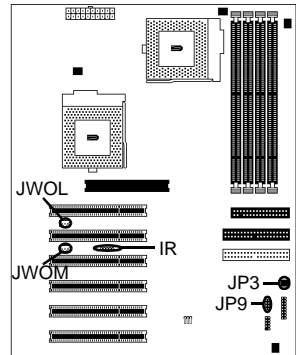

2.6-H. CPU Frequency Settings (JP9)

NOTE: The following settings are only valid if a non-retail/engineering sample CPU is installed. Retail CPU settings will automatically be detected and used accordingly.

Ratio	Bus Speed	CPU Speed	Pins 1-2	Pins 3-4	Pins 5-6	Pins 7-8
2	100	200	ON	ON	ON	ON
	133	333				
3	100	300	ON	OFF	ON	ON
	133	433				
4	100	400	OFF	ON	ON	ON
	133	533				
5	66	333	OFF	OFF	ON	ON
	100	500				
	133	667				
5.5	66	366	ON	ON	OFF	ON
	100	550				
	133	733				
7.5	66	500	ON	OFF	OFF	ON
	100	750				
	133	997				
9.5	66	633	OFF	ON	OFF	ON
	100	950				
	133	1264				
11.5	66	733	OFF	OFF	OFF	ON
	100	1150				
	133	1530				

2.6-I. Infrared Reserved (IR)

This is a reserved connector for IR functions.

2.6-J. Soft Power Connector

The soft power connector is part of jumper block J1 (pins 6 to 8). This board uses the chipset for power management, including turning on and off the system. If the power button function option in the BIOS Power Management menu is set to "On/Off" (which is the default), pressing the power button once after the BIOS has booted up will turn the system on and off. If the power button function is set to Suspend, pressing the power button once will wake up the system or send it to Suspend mode. In this case, you cannot turn the system off unless you shut down through the Windows operating system or you hold the power button down for four seconds.

2.6-K. Hardware Reset Switch Connector Installation

The reset switch on your chassis case provides you with the Hardware Reset function, which is the same as power on/off, except that the system will immediately execute a cold start after the reset button is pushed.

2.6-L. Flash Utility

You can upgrade the BIOS of this motherboard by using the Flash Utility (see **p. 37**). Check the Tyan website for details: <http://www.tyan.com>

* check the Tyan website for updates: <http://www.tyan.com>

2.7 Mounting the Motherboard into the Chassis

Your chassis may include mounting hardware. If mounting hardware was included, you can use the following examples to help you in installing your motherboard into the chassis.

The chassis may have come with the studs integrated into the chassis wall, so in those cases you would only need to use screws (possibly included with your chassis) to install the motherboard. See the examples (**Figure 2.0**, shown below) for more details.

If the chassis includes mounting hardware without the studs pre-installed, then you will need to install the motherboard using the mounting hardware as shown in the examples **below**. Remember not to over-tighten any of the screws, or you might risk breaking internal traces in the surrounding area, or damage the motherboard in some other way.

Other examples of how to install your motherboard using other hardware (that may or may not have been included with your chassis) are shown below.







Type of hardware	One solution for installing motherboard	Another solution	Another solution
	 <p>screw</p> <p>motherboard base</p> <p>stud</p> <p>chassis wall</p>		
	 <p>motherboard base</p> <p>standoff</p> <p>chassis wall</p>		
	 <p>motherboard base</p> <p>standoff</p> <p>chassis wall</p>		

Figure 2.0

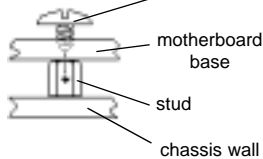
NOTE:

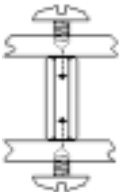

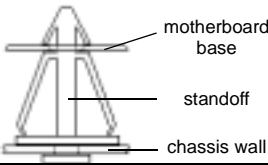

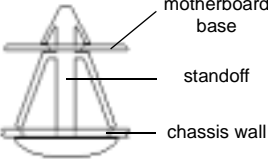
The diagrams above are only representative of a few solutions for installing a motherboard into the chassis. The installation procedure for installing your motherboard may differ.

2.8 Installing Memory

Please keep in mind that although some memory modules may appear to be high-quality, they may contain inferior or substandard parts. The type of memory you choose to install should be checked against the memory compatibility list, which is available from Tyan's website at <http://www.tyan.com>

Memory Installation Procedure

Here are some details of memory installation for this board:

-  At least one unbuffered DIMM must be installed for the system to POST.
-  The motherboard supports 64MB, 128MB, 256MB, and 512MB PC100/133 SDRAM.
-  All installed memory will be automatically detected, so there is no need to set any jumpers.
-  The motherboard supports up to 1.5 (3 DIMMs)* or 2 GB (4 DIMMs)* of memory.

Step 1 Insert the DIMM by pushing the module into the socket **with even force**. Do not insert one end and then the other: install the whole module at once or you might bend the DIMM pins. Make sure the DIMM is securely seated.

Step 2 Line your module up so that the pins fit into the socket. There is only one way your DIMM can fit properly. Make sure that the short row of pins is lined up with the short gap in the DIMM socket.

Step 3 Lock the DIMM into place by pushing the clips back on either end of the socket onto the notches in the ends of the DIMM (see pictures below for details).

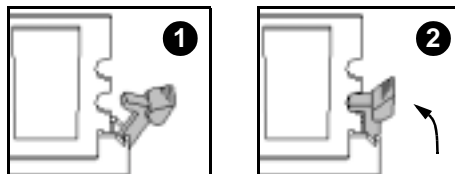

* 2.0GB total memory @ 4 DIMMs only, when using 100MHz SDRAM
1.5GB total memory @ 3 DIMMs only, when using 133MHz SDRAM
Check the Tyan website for details on memory compatibility: <http://www.tyan.com>

Removing a DIMM

Removing a DIMM is just the reverse: simply pull back the clips from the DIMM (see pictures below), and carefully pull the module straight out. Place the DIMMs in an anti-static bag as soon as you remove them to avoid static damage.

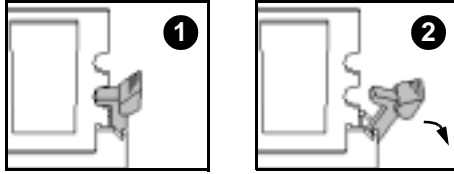

Suggested Memory Configurations

The table below shows some of the possible memory configurations. **Not all possible configurations are listed.** Your memory configuration may differ from one or more of the combinations shown below.

2GB* at 100 MHz combination or 1.5GB* at 133 MHz combination								
DIMM 1	64MBx1	0	128MBx1	128MBx1	0	0	512MBx1	0
DIMM 2	0	64MBx1	0	128MBx1	256MBx1	0	0	1024MBx1
DIMM 3	0	0	64MBx1	0	0	512MBx1	1024MBx1	0
DIMM 4	0	64MBx1	0	0	128MBx1	512MBx1	0	1024MBx1
TOTAL	64MB	128MB	192MB	256MB	384MB	1024MB	1536MB	2048MB

The 168-pin DIMMs (Dual In-line Memory Modules) must be of the **3.3V PC100/PC133** variety. The position of the notch in the SDRAM key position will tell you whether or not a DIMM is unbuffered (see **Figure 2.1 below**). All installed memory will be automatically detected, so there is no need to set any jumpers.

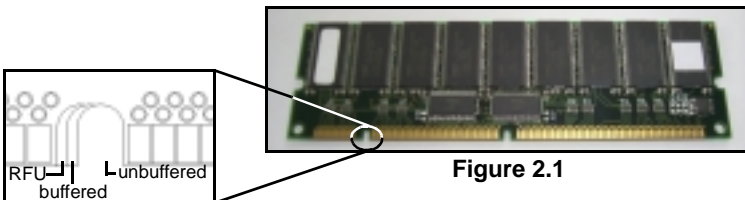







Figure 2.1

* 2.0GB total memory @ 4 DIMMs only, when using 100MHz SDRAM
 1.5GB total memory @ 3 DIMMs only, when using 133MHz SDRAM
 Check the Tyan website for details on memory compatibility: <http://www.tyan.com>

2.9 Installing the CPU and Cooling Fan

Intel Pentium III FC-PGA processors (500 MHz through 1 GHz) or a **single** FC-PGA type Celeron processor can be used on this board. For more information on CPU compatibility, check Tyan's website at: <http://www.tyan.com>.

-  When installing your CPU, remember the following:
-  The CPU is a sensitive electronic component and can easily be damaged by static electricity
-  Do not touch the CPU pins with your fingers
-  You should be able to insert the CPU into the socket with virtually no force
-  Do not press down hard on the CPU as you might bend or break pins, or otherwise damage the CPU

The CPU voltage will automatically be detected by the motherboard, so there is no need to set any jumpers or BIOS setting.

Installing the Intel Pentium III FC-PGA CPU

Before installing the CPU, check it for any visible damage. Make sure none of the pins are bent or missing. Be sure where Pin 1 is on both the CPU and the socket. The following steps each have a corresponding picture next to it to help guide you through the installation.

- Step 1** Carefully lift the arm of the ZIF socket until it is at a 90 degree angle pointing away from the motherboard. Be very careful not to damage any components that might be next to the socket.

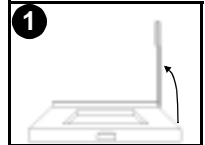

- Step 2** There are two beveled corners on the CPU, which will match the two angled corners on the socket. Carefully install the CPU by lining both Pin 1 on the CPU and Pin 1 on the socket, making sure the pins actually fit into the socket. **Do not** force the CPU into the socket: check the pin alignment of CPU pins to socket holes.

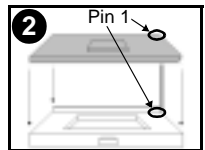

- Step 3** Push down lightly on the CPU while lowering the arm on the socket to secure the CPU (see right). A squeaking noise may be heard while lowering the arm, or the socket may make a 'click' noise when the arm is locked into position: these noises are normal.

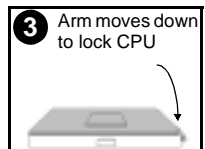

Installing the Cooling Fan

After the CPU has been installed, you will need to **install the proper cooling device** for the CPU. This device, a heatsink/fan combination, can be purchased at many computer retail stores. Installation of the cooling device may vary depending on the fan manufacturer's design. You should also take space into consideration when install a cooling device: make sure the cooling device is not too big, or else you may end up damaging components around the CPU socket.

Tyan **highly recommends** that you use some type of thermal compound (available from computer retail stores), between the CPU and heat sink, to maximize distribution of heat away from the CPU. Please use extra caution when installing any type of clamp-style fan, or else damage may occur to the CPU socket, and/or the CPU itself. See **Figure 2.2** (see right) for an example of how to connect the cooling fan's power supply. Another diagram has also been provided below, to aid in CPU fan installation onto the socket.



Figure 2.2*

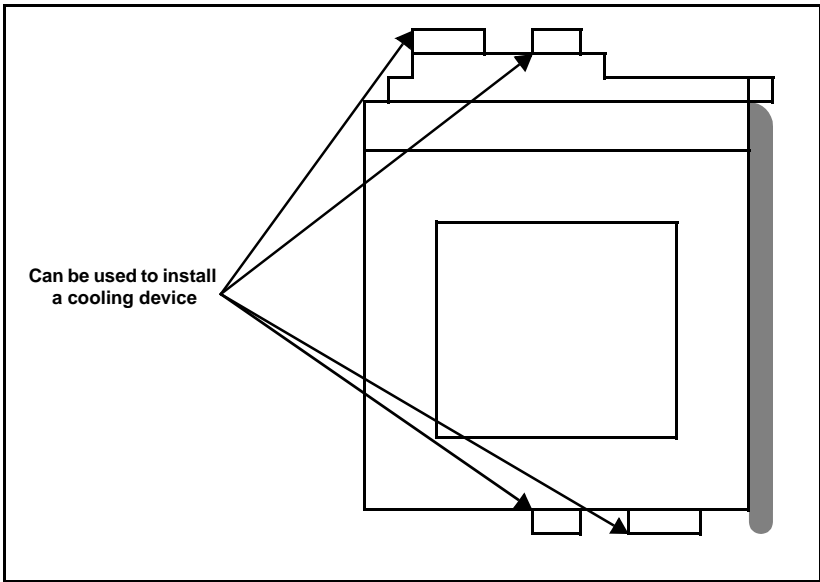

Can be used to install a cooling device

Mounting points on the CPU socket

Installing Chassis Fans

Alternatively, if you wish to also install chassis fans for increased cooling, we have provided headers to power those fans as well (see **p. 12, section 2.6-D**). Chassis fan installation will vary depending on your chassis manufacturer's design. Please check with your chassis manufacturer for details on proper chassis fan installation.

* image may not be representative of your motherboard

2.10 Connecting IDE and Floppy Drives

A variety of IDE and ATAPI-compliant devices* can be installed on this motherboard, such as hard disk drives (HDDs) and CD-ROMs.

Please keep in mind that on this motherboard, the primary IDE connector is **BLACK**, and the secondary IDE connector is **WHITE**. See **Figure 2.3** (right) for an example of the IDE cable properly connected to the motherboard. Consult the documentation that came with your IDE/ATAPI device, or contact the device's manufacturer for more details on installation.

Also see **Figure 2.4** (right) for an example of the HDD with the IDE cable installed. Please note that UltraDMA-66 IDE HDDs require a special 80-wire cable which has additional grounding wires. This cable has been included with this motherboard for your convenience. The UltraDMA-66 cable is upwards compatible with UltraDMA-100 IDE HDDs, and backwards compatible with UltraDMA-33 and legacy IDE HDDs.

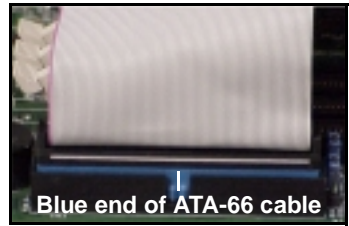

Figure 2.3

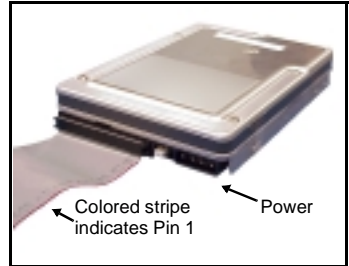

Figure 2.4

NOTE:

The **BLUE** end of the ATA-66 cable must connect to the motherboard. The black connector on the ATA-66 cable is for the master HDD, and the grey connector is for the slave HDD. See **Figure 2.3** (above) for an example of installation on the motherboard.

Only Tyan-approved cables are recommended for this motherboard. If you are using an existing configuration with older cables, your system might not function properly. Use only Tyan-approved cables (i.e. the ones included with your motherboard).

Some symptoms of incorrectly installed HDDs are...

HDDs are not auto-detected	May be a Master/Slave configuration problem, bad IDE cable, or BIOS mis-configuration. Consult the HDD documentation or contact your HDD vendor.
Hard Disk Drive Fail message at bootup	May be a bad cable or lack of power going to the drive. Check the cables for damage and bad connections.
No video or beeps during bootup	Usually means the cable has been installed backwards.
HDD lights are constantly on	Bad IDE cable or defective drives/motherboard. Try another HDD, or contact your HDD vendor.
HDD does not power on	Check power cables and cabling. May be a bad power supply or IDE drive problem.

* ATAPI-compliant devices may not work with the Promise IDE RAID connectors. Check the Tyan website for updates and information: <http://www.tyan.com>

Connecting Floppy Drives

Pin 1 on the floppy cable is usually denoted by a red or colored stripe down one side of the cable. See **Figure 2.5** (below) for an example of a floppy cable. Most of the current floppy drives on the market require that the cable be installed with the colored stripe positioned next to the power connector. In most cases, there will be a key pin on the cable which will force a proper connection of the cable.

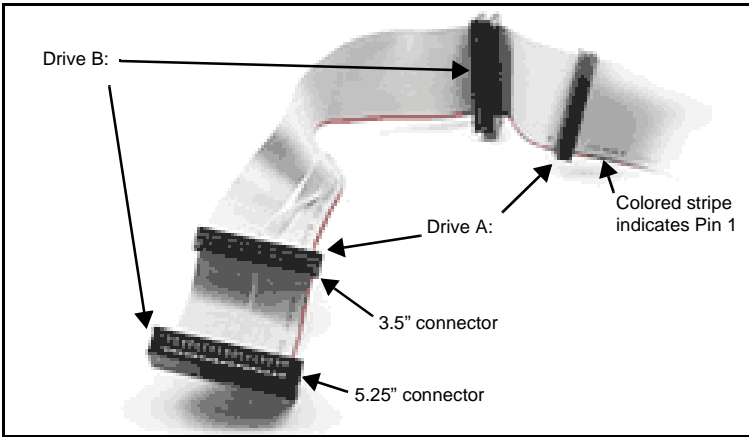

Figure 2.5

The first floppy (denoted as A:) is usually attached to the end of the cable with the twist in it. See **Figure 2.5** (above) for an example. Drive B: is usually connected to the middle of the cable. Refer to your floppy drive's installation instructions, or contact your dealer if you are unsure about how to attach the floppy drive(s). Remember, you can only have 2 floppy drives connected at any given time.

Some symptoms of incorrectly installed FDDs are...

FDDs are not auto-detected

Usually caused by faulty cables, cables put in backwards, or a bad floppy or motherboard. Try another floppy drive to verify the problem or try another cable. Also check to see if the onboard floppy is enabled in the BIOS.

Floppy Drive Fail message at bootup

The cable, floppy, or motherboard may be faulty. Try another cable or floppy drive to verify.

FDD does not power on

Check power cables and cabling. May be a bad power supply or IDE drive problem.

FDD light is constantly on

Usually signifies that the cable is on backwards. Reverse the cable at the floppy drive end and try again.

2.11 Installing Add-on Cards

There are a few rules you need to follow when installing add-on cards. In order to assure proper operation and a quick installation, adhere to the following guidelines:

- ➡ If you are going to install a PCI-bus interface card in your system, be aware that any one of the six PCI slots can support a Master or Slave device.
- ➡ NEVER force a card into a slot. If it doesn't fit, look at the socket on the motherboard to make sure there are no wires or other obstructions to the slot.
- ➡ NEVER plug an ISA card into a PCI slot. You will void your warranty and damage your system board if you do this.
- ➡ When plugging the card in, especially when installing long cards, try to push the entire card in at one time. Don't force one end of the card into the socket first and then the other, or a rocking motion between the card and the slot might occur, and could damage the pins within the socket.
- ➡ Make sure the cards are seated securely into their slots.
- ➡ Before turning on the system, make sure no cards are touching.

When installing the add-on cards, make sure the cards are installed with **even** force; do not insert one end and then the other. See the before (**Figure 2.6a**) and after (**Figure 2.6b**) example installation images below for details.

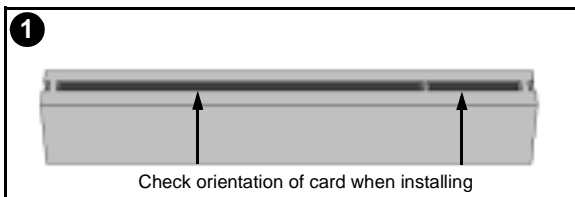

Figure 2.6a

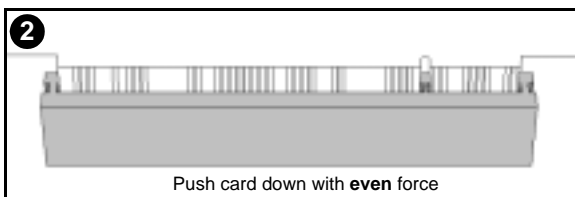

Figure 2.6b

2.12 Connecting PS/2, USB, and Serial Devices

This motherboard includes ports for PS/2 mouse and keyboard, Universal Serial Bus (USB) devices, and serial and parallel* devices. Please note that the upper PS/2 port is the mouse port, and the lower PS/2 port is for the keyboard (see **Figure 2.7** below).

The PS/2 connectors are probably quite familiar to you, while the USB connectors may not be. A USB port can function as a serial, parallel, mouse, keyboard, display, or joystick port. It is capable of supporting up to 127 daisy-chained peripheral devices. All external ports are labeled in **Figure 2.7**, shown below.

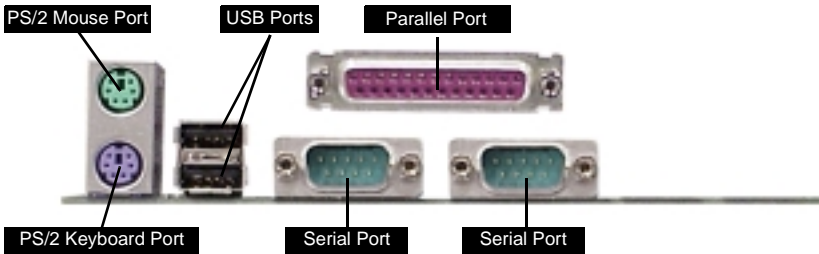

Figure 2.7

Connecting Serial and Parallel Ports

The serial and parallel ports can be used to connect various devices such as a mouse or printer. The connectors can only be connected one way: be sure and check the orientation of the connector before installing it into the port.

NOTE:

When plugging in your keyboard and mouse, or when plugging in anything into a serial or parallel* port, make sure that the power is off. Connecting these devices and ports while the power is on is called **hot plugging** and may damage your system and/or external devices that you are trying to install.

2.13 Connecting the power supply

This motherboard requires an ATX power supply. Tyan recommends using one that conforms to industry standard Revision 2.01. The images below show the ATX power connector before (**Figure 2.8a**) and after (**Figure 2.8b**) it has been plugged in. The clip on the power connector should lock over the tab on the onboard connector. You shouldn't be able to plug the power connector in any other way but just to be safe, make sure it looks like **Figure 2.8b**. Make certain that you do not miss connecting any of the pins because if you do, you will void your warranty and possibly cause damage to yourself and/or your motherboard when the power is turned on. After connecting the power, make sure the connector is seated firmly into its socket so it will not become loose or fall off when the computer is jostled or moved.

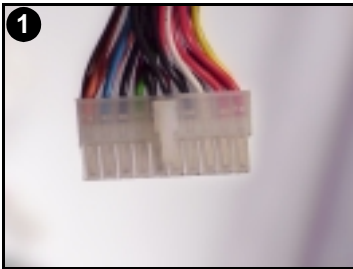

Figure 2.8a



Figure 2.8b*

You are done!

Other than checking the jumper settings and cable connections, and putting the case back on, you are done. Installing a new motherboard may seem difficult, but by following these directions, you should have a fairly uneventful time installing our products. If you do encounter problems, your dealer will be able to help you, or you can consult one of our many technical support resources (see p. 7).

* image may not be representative of your motherboard

2.14 Frequently Asked Questions (FAQ)

Q: My system sometimes becomes unstable. How should I check the system?

A: The first thing to do is to check and see if you have any device conflicts related to the IRQ, or DMA. If you are using Microsoft Windows, the Control Panel is a good place to start investigating the conflict. Please consult your operating system documentation for details. Secondly, slowing down the memory timing in the BIOS' chipset setup section will help the situation as well. Many memory modules are not suitable for high performance systems and are probably the main source of your problem. Also check to make sure you are using an ATX 2.01 compliant or better power supply. Lastly, make sure the motherboard is receiving adequate cooling.

Q: I have a question about memory compatibility; what memory will work on my motherboard?

A: Memory compatibility information can be found on Tyan's website at: <http://www.tyan.com>

Q: Where can I get additional accessories for my Tyan motherboard?

A: You can purchase additional accessories such as USB cables, as well as other Tyan-approved accessories at the Tyan Computer Online Store: <http://www.etyan.com>

Q: Where do I get pinout information for my motherboard?

A: Pinouts of certain headers are available on the Tyan website: <http://www.tyan.com>

Q: My motherboard is dead, how do I return it?

A: Contact the place of purchase or your distributor for assistance to return the motherboard for service. RMA issues will not be handled via e-mail by Tyan Tech Support. Please refer to the URL link here for more details: http://www.tyan.com/support/html/rma_faq.html

Q: How do I upgrade my BIOS?

A: Check the section about the Flash Utility (see **p.37**) for information on upgrading your BIOS. BIOS update files, flash utilities, and instructions on how to install them are also available from the Tyan website at: <http://www.tyan.com>

Q: Why do I get a "CMOS checksum invalid" error message during POST?

A: If you get the above error message or "Invalid configuration, run Setup" message, it is an indication that the CMOS battery needs to be changed. Contact your dealer for assistance. Once you've replaced your battery, don't forget to check the Clear CMOS section (see **p.12**) so that you can reset your CMOS.

Chapter 3: BIOS Setup

Introduction to the BIOS setup

The BIOS is the basic input/output system, required by the computer to perform functions such as CPU and hard drive support. This chapter describes different settings for Award BIOS that can be used to configure your system.

The BIOS section of the manual is subject to change without notice and is provided here for reference purposes only. The settings and configurations of the BIOS are current at the time of print, and therefore they may not be exactly the same as that displayed on your screen.

The manual describes the Award BIOS setup program. The setup program lets you modify basic configuration settings. The settings are then stored in a dedicated battery-backed memory, called NVRAM, that retains the information when the power is turned off.

The Award BIOS in your computer is a customized version of an industry-standard BIOS for IBM PC AT-compatible personal computers. It supports Intel x86 and compatible processors. The BIOS provides critical low-level support for the system central processing, memory, and I/O subsystems.

The BIOS has been customized by adding important, but non-standard, features such as virus and password protection, power management, and detailed fine-tuning of the chipset controlling the system. The rest of this manual is intended to guide you through the process of configuring your system using the Award BIOS setup program.

Starting Setup

The BIOS is immediately activated when you first turn on the computer. The BIOS reads system configuration information in CMOS RAM and begins the process of checking out the system and configuring it through the Power-On Self Test (POST).

When these preliminaries are finished, the BIOS seeks an operating system on one of the data storage devices (HDD, FDD, etc.) and if one is found, the BIOS will launch that operating system and hand control of system operations to it. During POST, you can start the setup program by pressing the **[DEL]** key when the "Press DEL key to enter BIOS setup" message appears on the screen.

Setup Keys

The table below shows how to navigate in the setup program using the keyboard.



Key	Function
Arrow keys	Moves from one selection to the next
Enter	Select the highlighted option
+/-/PGUP/PGDN	Change option setting
ESC	Exit
F1	General Help
F2	Item Help
F5	Previous values
F6	Load failsafe defaults
F7	Load optimized defaults
F9	Menu in BIOS
F10	Save settings and exit

Getting Help

Press **[F1]** to display a small help window that describes the appropriate keys to use and the possible selections for the highlighted item. To exit the Help Window press **[ESC]** or the **[F1]** key again.

In Case of Problems

If you discover that you have trouble booting the computer after making and saving changes with the BIOS setup program, you can restart the computer by either:

-  Pressing **[CTRL]+[ALT]+[DEL]** (all three keys at the same time), or
-  Holding the power button down until the computer shuts off, then reset the CMOS (see p. 15)

The best advice is to alter only settings that you thoroughly understand. In particular, do not change settings in the Chipset screen unless you are absolutely sure that you need to. The Chipset defaults were carefully chosen for the best performance and reliability. Even a seemingly small change to the Chipset setup may cause the system to become unstable.

Setup Variations

Not all systems have the same setup program. While the basic look and function of the setup program remains more or less the same for all system, the appearance of your Setup screen may differ from other Award BIOS screens. Each system design and chipset combination require custom configurations. In addition, the final appearance of the setup program depends on your system designer. Your system designer can decide that certain items should not be available for user configuration, and remove them from the BIOS setup program.

General Help

At any time, you can press **[F1]** to bring up a General Help screen in case you want to learn the shortcut commands. There are two settings you should be aware of (listed below).

Setting	Function
Load Failsafe Defaults	If your system is experiencing configuration problems, you can choose this option to reset all settings.
Load Optimal Defaults	This will load preset options that are designed for maximum system performance, but may not work for all computer applications. You should not use this option if you are experiencing configuration problems.

3.1 Main Setup

The BIOS allows you to select from several setup functions and two exit choices. If an additional configuration screen is available, it will have a **▶** symbol. If you select that option with that symbol, you will be brought to another configuration screen. Hitting **[ESC]** will bring you back out.

3.2 Standard CMOS Setup

3.2-A. Date/Time

You can type in the date and time directly, or select the portion of the date or time that you want to modify and adjust it using the **↑ ↓** cursor keys. The clock runs on a 24-hour cycle (i.e 1:00 PM is 13:00).

3.2-B. IDE Primary/Secondary Master/Slave

These four options are for setting IDE devices such as HDDs and CD-ROMs. If left on the default setting of "Auto", the drives will be auto-detected.

The next page describes the settings available for configuring the IDE devices.

3.2-C. Table of IDE device settings

Type	The type of IDE device installed can be configured using this option. [Default setting is Auto for auto-detect]
LBA/Large Mode	These modules make it possible for the BIOS to take advantage of the additional space on drives which are larger than 504MB. This can be auto-detected (when you select Auto for Type), or you can manually set this mode to Disabled. [Default setting is Auto]
Block (Multi-sector Transfer)	When set to Auto, the block mode auto-detects the optimal number of block read/writes per section that the drive supports. [Default is 0]
PIO Mode	Programming input/output is a method of transmitting data between devices that use the system's CPU as part of the data path. There are 6 modes: 5 with their own transmission speed and 1 auto mode. To use modes 3 and 4, you must use an Enhanced IDE drive. [Default is Auto]
DMA Mode	This option specifies the Direct Memory Access mode for the IDE device. If set to Auto, the BIOS will determine the DMA mode. [Default is Auto]
S.M.A.R.T. (Self-Monitoring Analysis and Reporting Technology)	This option allows the S.M.A.R.T. protocol to report server system information over a network. [Default is Auto]
32Bit Data Transfer	If set to On, this option allows for the transmission of 32-bits in parallel (e.g. at the same time). If set to Off, only 16-bits will be transmitted in parallel. [Default is Enabled]
ARMD Emulation Type	Specifies the type of emulation used for a non-disk device attached as the primary master IDE device. If set to Auto, the BIOS will determine the emulation type. [Default is Auto]

The following settings are also available in the Standard CMOS Setup screen.

Drive A	The settings are 360KB 5.25", 1.2MB 5.25", 720KB 3.5", 1.44MB 3.5", or 2.88MB 3.5".
Drive B	The options are the same as listed for Floppy A. [Default setting is Disabled]
Floppy 3 Mode	Sets whether you have a Japanese standard mode floppy (1.2MB storage on 3.5" drive). [Default is Disabled]
Video	Sets whether or not the drive can be written to. [Default is Disabled]
Halt On	Sets whether or not the BIOS should check for the drive at bootup. [Default is Disabled]

3.2-D. Memory

You cannot change any values in the Memory fields, as they are shown only for your information. The fields show the total installed random access memory (RAM) and amounts allocated to base, extended, and other memory. RAM is the computer's working memory, where the computer stores programs and data currently being used, so that they are accessible to the CPU. RAM is counted in kilobytes (KB: approximately one thousand bytes) and megabytes (MB: approximately one million bytes). Modern personal computers may contain up to 128, 256 MB, or more.

Base Memory	Typically 640KB. Also called conventional memory. The DOS operating system and conventional applications use this area.
Extended memory	Above the 1MB boundary. Early IBM personal computers could not use memory above 1MB, but current PCs and their software can use extended memory.
Other Memory	Between 640KB and 1MB; often called high memory. DOS may load terminate-and-stay (TSR) programs in this area, such as device drivers, to free as much conventional memory as possible for applications. Lines in your config.sys file that start with loadhigh , load programs into high memory, for example.

3.3 Advanced BIOS Features

This section may allow the user to alter certain settings that affect the way their computer boots up, checks CPU cache, and other advanced features. **Please note that you should not alter settings in this BIOS section unless you are absolutely sure that you know what you are doing.**

Virus Warning	Sets whether the BIOS should try to auto-detect for boot viruses, etc. [Default setting is Disabled]
CPU Internal Cache	Sets whether or not your installed CPU has internal cache [Default setting is Enabled]
External Cache	Sets whether or not external cache is installed. [Default is Enabled]
CPU L2 Cache ECC Checking	Sets whether the CPU's L2 (Level 2) cache has ECC checking. [Default is Enabled]
Quick Power On Self Test	Sets whether BIOS should perform the quick POST during boot-up. [Default is Disabled]
First Boot Device	Sets the first device that the BIOS should check in order to boot-up. [Default is Floppy]
Second Boot Device	Sets the second device that the BIOS should check in order to boot-up. [Default is CD-ROM]
Third Boot Device	Sets the third device that the BIOS should check in order to boot-up. [Default is HDD-0]
Boot Other Device	Sets whether still another boot device should be checked. [Default is Enabled]

(continued on next page)

(continued from previous page)

Swap Floppy Drive	If you have two drives and need to swap them for some reason, use this option. [Default setting is Disabled]
Boot Up Floppy Seek	Sets whether the BIOS should check all floppy drives during boot-up. [Default setting is Enabled]
Boot Up Numlock Status	Sets whether the Num Lock key should be enabled during boot-up. [Default is Enabled]
Gate A20 Option	Refers to the method that the system addresses memory above 1MB. [Default is Normal]
Typematic Rate Setting	Sets whether the keyboard input speed should be altered. [Default is Disabled]
Typematic Rate	If above setting is Enabled, this sets the characters per second of keyboard input. [Default is 6]
Typematic Delay	If above setting is Enabled, this sets the delay on character input from keyboard. [Default is 250]
Security Option	Sets whether the password should be enabled. [Default is Setup]
PS/2 Mouse Function Control	Reserved. [Default is Enabled]
MPS Version Control for OS	Reserved. [Default is 1.1]
OS Select for DRAM > 64MB	If your OS requires this setting, it can be altered from here. [Default is Non-OS2]
Video BIOS Shadow	Reserved. [Default is Enabled]
C800-CBFFF Shadow to DC000-DFFFF Shadow	Reserved. [Default is Enabled]

3.4 Advanced Chipset Features

This section describes the settings for the chipset installed on this motherboard. **Please note that the parameters described in this section are for technically competent users only. Do not change these values unless you completely understand the consequences of your changes.**

Bank 0/1 to Bank 6/7 DRAM Timing	Settings depend on type of memory installed, and therefore these settings are reserved. [Default settings are 5/10ns]
SDRAM Cycle Length	Sets the CAS latency timing. [Default setting is 3]
DRAM Drive Strength	Reserved. [Default is Auto]
DRAM Drive Value	Reserved. [Default is 2F]
Memory Hole	Specifies the location of an area of memory that cannot be addressed on the ISA bus. [Default is Disabled]
P2C/C2P Concurrency	If Enabled, the PCI/AGP Master to CPU cycle can be concurrent if the Host CPU is performing R/W access to the PCI or slave devices. [Default is Enabled]
System Bios Cacheable	Sets ability to cache system BIOS ROM at F0000h-FFFFFh. [Default is Disabled]
Video RAM Cacheable	Sets whether the video memory should be cacheable. [Default is Disabled]
AGP Aperture Size	The aperture is a portion of the PCI memory address range dedicated for graphics memory address space. [Default is 64M]
AGP-4x Mode	Enables the 4X AGP mode (requires a 4X-capable AGP card). [Default is Enabled]
AGP Driving Control	Some AGP cards require setting this option, otherwise this option is reserved. [Default is Auto]
AGP Driving Value	This function is generally reserved for manufacturer use. [Default is dependent on graphics card]
AGP Fast Write	Setting is dependent on AGP card. [Default is Disabled]
OnChip USB	Sets whether you have USB devices. [Default is Enabled]
USB Keyboard Support	Enable or disable use of a USB keyboard. [Default is Disabled]
CPU to PCI Write Buffer	Setting this can compensate for speed differences between the CPU and PCI bus. [Default is Enabled]
PCI Dynamic Buffering	If Enabled, every write transaction goes to write buffer. Burstable transactions then burst on the PCI bus, but non-burstable transactions do not. [Default is Enabled]

(continued on next page)

(continued from previous page)

PCI Master 0 WS Write	Sets whether writes to PCI bus are executed with zero wait states. [Default settings are Enabled]
PCI Delay Transaction	Sets write buffer support in compliance with PCI spec v2.1. [Default setting is Enabled]
PCI#2 Access #1 Retry	Sets whether PCI masters should rotate priority [Default is Disabled]
AGP Master 1 WS Write / Read	Sets whether one clock tick should be added to AGP write operations. [Default is Enabled]
Memory Parity / ECC Check	Sets whether the BIOS should enable memory checking automatically when it detects ECC DRAM. [Default is Disabled]

3.5 Integrated Peripherals

This section describes settings for the integrated peripherals setup options.

On-Chip IDE Channel 0 / 1	Sets the onboard support for the two IDE channels. [Default setting is Enabled]
IDE Prefetch Mode	Sets support for IDE prefetching for faster drive accesses. [Default setting is Enabled]
IDE Pri/Sec Master/Slave PIO	Sets PIO mode for each of up to four IDE devices that the onboard IDE interface supports. [Default is Auto]
IDE Pri/Sec Master/Slave UDMA	Sets whether UDMA data transfer protocol should transfer at optimal speed, or to auto-detect optimal speed. [Default is Auto]
Init Display First	Sets type of display adapter installed. [Default is PCI Slot]
IDE HDD Block Mode	Sets onboard detection of optimal number of block R/W's per sector that the drive can support. [Default is Enabled]
Onboard FDD Controller	Sets whether onboard floppy controller should be used. [Default is Enabled]
Onboard Serial Port 1 / 2	Sets logical COM port address and corresponding interrupt for 1st and 2nd serial ports. IR is offered on 2nd port. [Default is Auto]
UART Mode Selecty	Sets operating mode for second serial port. [Default is Standard]
UART2 Duplex Mode	Sets whether COM port should be able to receive and transmit data simultaneously. [Default is Half , as in Half-Duplex]
Tx,Rx Inverting Enabled	Reserved. [Default is No, Yes]

BIOS

(continued on next page)

(continued from previous page)

Onboard Parallel Port	Sets logical LPT port address and corresponding interrupt. [Default setting is 378/IRQ7]
Onboard Parallel Mode	Sets mode for onboard parallel port. [Default setting is Normal]
ECP Mode Use DMA	Sets whether parallel port should use DMA for faster transfer rate. [Default is 3]
Parallel Port EPP Type	Sets parallel port data transfer mode. [Default is EPP1.9]

3.6 Power Management Setup

This section describes the different power management functions that may be available on your system. Please note that power management functions are also dependent on your OS' power management functions, and that both OS and system power management functions should be set up to work in conjunction with one another.

ACPI Function	Enable or Disable Advanced Configuration Power Interface. [Default setting is Enabled]
Power Management (subscreen)	Lets you enter the screen for configuring power states.
Power Management	Sets whether each mode should be set separately. [Default is User Define]
HDD Power Down	Sets time that system should wait before powering down the HDD(s). [Default is Disable]
Doze Mode	Sets time that system should wait before CPU clock runs at slower speed to save power. [Default is Disabled]
Suspend Mode	Sets time that system should wait before suspending all devices except for CPU, to save power. [Default is Disabled]
ACPI Suspend Type	Sets type of suspend function to enable once the system enters suspend mode. [Default is S1(POS)]
PM Control by APM	Reserved. [Default is Yes]
Video Off Option	Sets power-saving mode for video display. [Default is Suspend->Off]
Video Off Method	Determines manner in which the monitor is blanked. [Default is V/H SYNC+Blank]
Modem Use IRQ	If Modem Ring Resume is Enabled, it's possible to wake the system up by dialing into it. [Default is 3]

(continued on next page)

(continued from previous page)

Soft-Off by PWRBTN	Sets time needed to hold down the power button to shutdown the system. [Default setting is Instant-Off]
Wake Up Events (subscreen)	Lets you enter the screen for configuring wake up events.
VGA	Sets video activity as power management event. [Default is Off]
LPT & COM	Sets LPT and COM/Serial Port activity as power management events. [Default is LPT/COM]
HDD & FDD	Sets floppy and HDD activity as power management events. [Default is ON]
PCI Master	Sets PCI activity as power management events. [Default is Off]
Wake Up on LAN / RING	Sets Wake Up on LAN / Ring as power management events. [Default is Disabled]
RTC Alarm Resume	Sets RTC Alarm as a power management event. [Default is Disabled]
Date / Time	Sets Date and Time that system will wake up. [Default is 0]
Primary INTR	Sets whether IRQ activity should be a power management event. [Default is ON]
IRQs Activity Monitoring (subscreen)	In this screen, you can assign how power management will monitor each IRQ.

BIOS

3.7 PnP/PCI Configuration

This section describes the PCI/PnP configuration options available.

PNP OS Installed	Sets whether the system is using a Plug-n-Play OS. [Default setting is NO]
Reset Configuration Data	Sets whether the configuration data in the ESCD should be reset at bootup. [Default setting is Disabled]
Resources Controlled By (ESCD)	Sets how the PnP devices will be controlled. [Default is Auto(ESCD)]
IRQ Resources	Sets IRQs PnP control statuses.
DMA Resources	Sets DMAs PnP control statuses.

(continued on next page)

(continued from previous page)

PCI/VGA Palette Snoop	Reserved. [Default setting is Disabled]
Assign IRQ for VGA	Sets whether an IRQ should be reserved for VGA. [Default setting is Enabled]
Assign IRQ for USB	Sets whether an IRQ should be reserved for USB. [Default setting is Enabled]

3.8 PC Health Status

This section describes the hardware monitoring of certain onboard devices. No options are user-defined.

Current CPU1 Temp.	Displays temperature of CPU1 in Celsius and Fahrenheit.
Current CPU2 Temp.	Displays temperature of CPU2 in Celsius and Fahrenheit.
Current CPUFAN1 Speed	Displays speed of CPUFAN1 in revolutions per minute (RPM).
Current CPUFAN2 Speed	Displays speed of CPUFAN2 in revolutions per minute (RPM).
CPU1 Vcore	Displays core voltage of CPU1.
CPU2 Vcore	Displays core voltage of CPU2.
3.3V	Displays power supply voltage on 3.3V line.
5V	Displays power supply voltage on 5V line.
12V	Displays power supply voltage on 12V line.

3.9 Set Supervisor Password / Set User Password

Both of these functions allow for passwords to be set accordingly for BIOS configuration.

When selecting one of the password functions, the following words will appear:

ENTER PASSWORD:

After typing in a new password of up to eight characters, press **[Enter]**. The following words will then appear:

CONFIRM PASSWORD:

Type your new password again, and the password will then be set. Please note that entering a new password and then confirming it, will clear any old password that you had (depending on type of password).

3.10 Flash Utility

NOTE: You will need to visit the Tyan website at <http://www.tyan.com> if you would like to get the Flash Utility, as well as any BIOS updates for your motherboard. Updates and more information about flashing the BIOS are available from the Tyan website.

Instructions on flashing the BIOS are available from the Tyan website at <http://www.tyan.com>

NOTE:

Please be aware that by flashing your BIOS, you agree that in the event of a BIOS flash failure, you must contact your dealer for a replacement BIOS. There are no exceptions. Tyan does not have a policy of replacing BIOS chips directly with end users. In no event will Tyan be held responsible for damage done to the BIOS by the end user.

Chapter 4: System Resources

Note: If you experience problems with setting up your system, always check the following things in the following order:

CPU, MEMORY, VIDEO

By checking these items, you will most likely find out what the problem might have been when setting up your system. For more information on troubleshooting, check the Tyan website at <http://www.tyan.com>

4.1 Beep Codes

Fatal errors, which halt the boot process, are communicated through a series of audible beeps. For example, if the Award BIOS POST can initialize the video but an error occurs, an error message will be displayed. If it cannot display video, it will convey a series of beeps.

If you hear one long beep followed by two short beeps, then a video problem has probably occurred and the BIOS is having difficulty initializing the video display. Any other beep sequences that may or may not occur are probably due to memory problems.

4.2 Displayed Error Messages

If an error occurs after the system display has been initialized, an error message will be displayed as follows:

```
ERROR Message Line 1
ERROR Message Line 2
Press <F1> to continue
```

and the system will halt. Depending on how the Halt On setting was configured in the Standard CMOS Setup menu, the system may or may not display the error message.

RUN SETUP UTILITY

may also appear. Press **[F1]** to run the Award BIOS Setup if this message appears. The following two pages show the possible error messages and explanations.

8042 Gate-A20 Error	Gate A20 on the keyboard controller (8042) is not working.
Address Line Short!	Error in the address decoding circuitry.
C: Drive Error	No response from drive C:
C: Drive Failure	No response from drive C:
Cache Memory Bad, Do Not Enable Cache!	Cache memory is defective.
CH-2 Timer Error	Timer 2 has failed.
CMOS Battery State Low	The battery is running low and needs to be replaced.
CMOS Checksum Failure	The CMOS data is different than previous data. Run BIOS setup to enter new data.
CMOS System Options Not Set	CMOS RAM values were destroyed. Run BIOS setup to enter new data.
CMOS Display Type Mismatch	Video type set in BIOS does not match actual video display. Run BIOS setup to enter new data.
CMOS Memory Size Mismatch	Memory size does not match actual detected memory size. Run BIOS setup to enter new data.
CMOS Time and Date Not Set	Time and Date have not been set. Run BIOS setup to enter new data.
D: Drive Error	No response from drive D:
D: Drive Failure	No response from drive D:
Diskette Boot Failure	Diskette cannot be used to boot system.
Display Switch Not Proper	Some systems require a video switch to be set to either color or monochrome. Power down the system and set the switch.
DMA Error	Error in the DMA controller.
DMA 1 Error	Error in the first DMA channel.
DMA 2 Error	Error in the second DMA channel.

FDD Controller Failure	FDD controller is not responding.
HDD Controller Failure	HDD controller is not responding.
INTR1 Error	Interrupt channel 1 failed POST.
INTR2 Error	Interrupt channel 2 failed POST.
Invalid Boot Diskette	Diskette is not bootable.
Keyboard is Locked... Unlock it	Keyboard lock is engaged. Power down and unlock it.
Keyboard Error	Keyboard appears to have a timing problem.
KB/Interface Error	Error in keyboard connection.
No ROM BASIC	System cannot find a bootable sector on any boot drive.
Off Board Parity Error	Parity error in external memory.
On Board Parity Error	Parity error in internal memory.
Parity Error ???	Parity error at unknown address.

Appendix I: Glossary

ACPI (Advanced Configuration and Power Interface): a power management specification that allows the operating system to control the amount of power distributed to the computer's devices. Devices not in use can be turned off, reducing unnecessary power expenditure.

AGP (Accelerated Graphics Port): a PCI-based interface which was designed specifically for demands of 3D graphics applications. The 32-bit AGP channel directly links the graphics controller to the main memory. While the channel runs at only 66 MHz, it supports data transmission during both the rising and falling ends of the clock cycle, yielding an effective speed of 133 MHz.

AMR (Audio Modem Riser): a modem that can be used on Intel Reference Motherboard platforms using Intel's core logic chipsets supporting AC-link 2.1. It supports fax and all data feedback modes. It provides high speed communications between your personal computer and a remote location, such as an Internet Service Provider (ISP).

AT: the original form factor of IBM's PC.

ATAPI (AT Attachment Packet Interface): also known as IDE or ATA; a drive implementation that includes the disk controller on the device itself. It allows CD-ROMs and tape drives to be configured as master or slave devices, just like HDDs.

ATX: the form factor designed to replace the AT form factor. It improves on the AT design by rotating the board 90 degrees, so that the IDE connectors are closer to the drive bays, and the CPU is closer to the power supply and cooling fan. The keyboard, mouse, USB, serial, and parallel ports are built-in.

Bandwidth: refers to carrying capacity. The greater the bandwidth, the more data the bus, phone line, or other electrical path, can carry. Greater bandwidth, then, also results in greater speed.

BBS (Bulletin Board System): a computer system with a number of modems hooked up to it which acts a center for users to post messages and access information.

BIOS (Basic Input/Output System): the program that resides in the ROM chip, and provides the basic instructions for controlling your computer's hardware. Both the operating system and application software use BIOS routines to ensure compatibility.

Buffer: a portion of RAM which is used to temporarily store data, usually from an application, though it is also used when printing, and in most keyboard drivers. The CPU can manipulate data in a buffer before copying it, all at once, to a disk drive. While this improves system performance --- reading to or writing from a disk drive a single time is much faster than doing so repeatedly --- there is also the possibility of losing your data should the system crash. Information stored in a buffer is temporarily stored, not permanently saved.

Bus: a data pathway. The term is used especially to refer to the connection between the processor and system memory, and between the processor and PCI or ISA local buses.

Bus mastering: allows peripheral devices and IDEs to access the system memory without going through the CPU (similar to DMA channels).

Cache: a temporary storage area for data that will be needed often by an application. Using a cache lowers data access times, since the needed information is stored in the SRAM instead of in the slow DRAM. Note that the cache is also much smaller than your regular memory: a typical cache size is 512KB, while you may have as much as 1GB of regular memory.

Cache size: refers to the physical size of the cache onboard. This should not be confused with the cacheable area, which is the total amount of memory which can be scanned by the system in search of data to put into the cache. A typical setup would be a cache size of 512KB, and a cacheable area of 512MB. In this case, up to 512KB of the main memory onboard is capable of being cached. However, only 512KB of this memory will be in the cache at any given moment. Any main memory above 512MB could never be cached.

Closed and open jumpers: jumpers and jumper pins are active when they are “on” or “closed”, and inactive when they are “off” or “open”.

CMOS (Complementary Metal-Oxide Semiconductors): chips that hold the basic startup information for the BIOS.

COM port: another name for the serial port, which is called as such because it transmits the eight bits of a byte of data along one wire, and receives data on another single wire (that is, the data is transmitted in serial form, one bit after another). Parallel ports transmit the bits of a byte on eight different wires at the same time (that is, in parallel form, eight bits at the same time).

DDR (Double Data Rate): improves RAM speed to at least 200 MHz. It activates output on both the rising and falling edge of the system clock rather than on just the rising edge, potentially doubling output.

DIMM (Dual In-line Memory Module): faster and more capacious form of RAM than SIMMs, and do not need to be installed in pairs.

DIMM bank: sometimes called DIMM sockets, because the physical slot and the logical unit are the same. That is, one DIMM module fits into one DIMM socket, which is capable of acting as a memory bank.

DMA (Direct Memory Access): channels that are similar to IRQs. DMA channels allow hardware devices (like soundcards or keyboards) to access the main memory without involving the CPU. This frees up CPU resources for other tasks. As with IRQs, it is vital that you do not double up devices on a single line. Plug-n-Play devices will take care of this for you.

Doze mode: in this mode, only the CPU's speed is slowed.

DRAM (Dynamic RAM): widely available, very affordable form of RAM which has the unfortunate tendency to lose data if it is not recharged regularly (every few milliseconds). This refresh requirement makes DRAM three to ten times slower than non-recharged RAM such as SRAM.

EDO RAM (Extended Data-Out RAM): speeds access to memory locations by assuming that memory addresses are static; the next time it looks for a bit of data, it will be at the same spot, or one nearby.

EEPROM (Electrically Erasable Programmable ROM): also called Flash BIOS, is a ROM chip which can, unlike normal ROM, be updated. This allows you to keep up with changes in the BIOS programs without having to buy a new chip. Tyan's BIOS updates can be found at <http://www.tyan.com>

ESCD (Extended System Configuration Data): a format for storing information about Plug-n-Play devices in the system BIOS. This information helps properly configure the system each time it boots.

Fault-tolerance: a term describing a system where one component can quickly be replaced without causing a loss of service, such as in a **RAID** system.

Firmware: low-level software that controls the system hardware.

Form factor: an industry term for the size, shape, power supply type, and external connector type of the Personal Computer Board (PCB) or motherboard. The standard form factors are the AT and ATX, although Tyan also makes some Baby-AT and ATX Footprint boards.

Global timer: onboard hardware timer, such as the Real-Time Clock (RTC).

Handshaking: a form of encryption. One system, typically the server, sends an encryption scheme to another agent, typically a client. Thus, the client's data is protected during transmittal to the server.

HDD: stands for Hard Disk Drive, a type of fixed drive.

H-SYNC: controls the horizontal synchronization/properties of the monitor.

IC (Integrated Circuit): the formal name for the computer chip.

IDE (Integrated Device/Drive Electronics): a simple, self-contained HDD interface. It can handle drives up to 8.4 GB in size. Almost all IDEs sold now are in fact Enhanced IDEs (EIDEs), with maximum capacity determined by the hardware controller.

IDE INT (IDE Interrupt): a hardware interrupt signal that goes to the IDE.

I/O (Input/Output): the connection between your computer and another piece of hardware (mouse, keyboard, etc.)

IRQ (Interrupt Request): an electronic request that runs from a hardware device to the CPU. The interrupt controller assigns priorities to incoming requests and delivers them to the CPU. It is important that there is only one device hooked up to each IRQ line; doubling up devices on IRQ lines can lock up your system. Plug-n-Play operating systems can take care of these details for you.

ISA (Industry Standard Architecture): a slower 8- or 16-bit bus (data pathway).

Latency: the amount of time that one part of a system spends waiting for another part to catch up. This is most common when the system sends data out to a peripheral device, and it waiting for the peripheral to send some data back (peripherals tend to be slower than onboard system components).

Mirroring: see **RAID**.

NVRAM: ROM and EEPROM are both examples of Non-Volatile RAM, memory that holds its data without power. DRAM, in contrast, is volatile.

OEMs (Original Equipment Manufacturers): Compaq or IBM package other companies' motherboards and hardware inside their case and sell them.

Parallel port: transmits the bits of a byte on eight different wires at the same time (that is, in parallel form, eight bits at the same time).

PCI (Peripheral Component Interconnect): a 32-bit local bus (data pathway) which is faster than the ISA bus. Local buses are those which operate within a single system (as opposed to a network bus, which connects multiple systems).

PCI PIO (PCI Programmable Input/Output) modes: the data transfer modes used by IDE drives. These modes use the CPU for data transfer (in contrast, DMA channels do not). PCI refers to the type of bus used by these modes to communicate with the CPU.

PCI-to-PCI bridge: allows you to connect multiple PCI devices onto one PCI slot.

Pipeline burst SRAM: a fast secondary cache. It is used as a secondary cache because SRAM is slower than SDRAM, but usually larger. Data is cached first to the faster primary cache, and then, when the primary cache is full, to the slower secondary cache.

Pipelining: improves system performance by allowing the CPU to begin executing a second instruction before the first is completed. A pipeline can be likened to an assembly line, with a given part of the pipeline repeatedly executing a set part of an operation on a series of instructions.

PM timers (Power Management timers): software timers that count down the number of seconds or minutes until the system times out and enters sleep, suspend, or doze mode.

PnP (Plug-n-Play): a design standard that has become ascendant in the industry. Plug-n-Play devices require little set-up to use. Novice end users can simply plug them into a computer that is running on a Plug-n-Play aware operating system (such as Windows 98), and go to work. Devices and operating systems that are not Plug-n-Play require you to reconfigure your system each time you add or change any part of your hardware.

Striping: see RAID.

RAID (Redundant Array of Independent Disks): a way for the same data to be stored in different places on many hard drives. By using this method, the data is stored redundantly, also the multiple hard drives will appear as a single drive to the operating system. RAID level 0 is known as striping, where data is striped (or overlapped) across multiple hard drives, but offers no fault-tolerance. RAID level 1 is known as mirroring, which stores the data within at least two hard drives, but does not stripe. RAID level 1 also allows for faster access time and fault-tolerance, since either hard drive can be read at the same time. RAID level 0+1 is both striping and mirroring, providing fault-tolerance, striping, and faster access all at the same time.

RAM (Random Access Memory): technically refers to a type of memory where any byte can be accessed without touching the adjacent data, is often used to refer to the system's main memory. This memory is available to any program running on the computer.

ROM (Read-Only Memory): a storage chip which contains the BIOS; the basic instructions required to boot the computer and start up the operating system.

SDRAM (Synchronous Dynamic RAM): called as such because it can keep two sets of memory addresses open simultaneously. By transferring data alternately from one set of addresses and then the other, SDRAM cuts down on the delays associated with non-synchronous RAM, which must close one address bank before opening the next.

Serial port: called as such because it transmits the eight bits of a byte of data along one wire, and receives data on another single wire (that is, the data is transmitted in serial form, one bit after another).

SIMM (Single In-line Memory Module): formerly the most common form of RAM for motherboards. They must be installed in pairs, and do not have the carrying capacity or the speed of DIMMs.

SIMM bank/socket: SIMM sockets are the physical slots into which you install SIMM modules. A pair of SIMM sockets form a SIMM bank, and act as one unit. If only one socket is filled, the bank will not operate.

Sleep/Suspend mode: in this mode, all devices except the CPU shut down.

SRAM (Static RAM): unlike DRAM, this type of RAM does not need to be refreshed in order to prevent data loss. Thus, it is faster, and more expensive.

Standby mode: in this mode, the video and fixed disk drive (usually the HDD) shuts down; all other devices continue to operate normally.

UltraDMA/33/66/100: a fast version of the old DMA channel. UltraDMA is also called UltraATA. Without the proper UltraDMA controller, your system cannot take advantage of the higher data transmission rates of the new UltraDMA/UltraATA HDDs.

USB (Universal Serial Bus): a versatile port. This one port type can function as a serial, parallel, mouse, keyboard, or joystick port. It is fast enough to support video transfer, and is capable of supporting up to 127 daisy-chained peripheral devices.

VGA (Video Graphics Array): the PC video display standard.

V-SYNC: controls the vertical properties of the monitor.

ZIF socket (Zero Insertion Force socket): these sockets make it possible to insert CPUs without damaging the sensitive CPU pins. The CPU is lightly placed in an open ZIF socket, and the metal level is pulled down. This shifts the processor over and down, guiding it into place on the board.



Notice for the USA

Compliance Information Statement (Declaration of Conformity Procedure) DoC
FCC Part 15: This device complies with Part 15 of the FCC Rules.

Operation is subject to the following conditions:

- 1) this device may not cause harmful interference, and
- 2) this device must accept any interference received including interference that may cause undesired operation. If this equipment does cause harmful interference to radio or television reception, which can be determined by turning the equipment off and on, the user is encouraged to try one or more of the following measures:
 - Reorient or relocate the receiving antenna.
 - Increase the separation between the equipment and receiver.
 - Plug the equipment into an outlet on a circuit different from that of the receiver.
 - Consult the dealer or an experienced radio/television technician for help.

Notice for Canada

This apparatus complies with the Class B limits for radio interference as specified in the Canadian Department of Communications Radio Interference Regulations. (Cet appareil est conforme aux normes de Classe B d'interférence radio tel que spécifié par le Ministère Canadien des Communications dans les règlements d'interférence radio.)



Notice for Europe (CE Mark)

This product is in conformity with the Council Directive 89/336/EEC, 92/31/EEC (EMC).

CAUTION: Lithium battery included with this board. Do not puncture, mutilate, or dispose of battery in fire. Danger of explosion if battery is incorrectly replaced. Replace only with the same or equivalent type recommended by manufacturer. Dispose of used battery according to manufacturer instructions and in accordance with your local regulations.