

**Tyan S1846**  
**Tsunami ATX**

**Motherboard User's Manual**  
**Revision 1.50**

Copyright © Tyan Computer Corporation, 1998. All rights reserved. No part of this manual may be reproduced or translated without prior written consent from Tyan Computer Corp.

All registered and unregistered trademarks and company names contained in this manual are property of their respective companies including, but not limited to the following.

AMIBIOS is a trademark of American Megatrend Incorporated.

Windows is a trademark of Microsoft Corporation.

IBM, PC, AT, PS/2 are trademarks of IBM Corporation.

INTEL, Pentium II, Celeron are trademarks of Intel Corporation.

S1846 Tsunami and Tsunami-ATX are trademarks of TYAN Computer Corporation.

Information contained in this publication has been carefully checked for accuracy and reliability. In no event will Tyan Computer be held liable for any direct or indirect, incidental or consequential damage, loss of use, loss of data, or other malady resulting from errors or inaccuracies of information contained in this manual. The information contained in this document is subject to change without notice.

**PRINTED IN USA.**

# Table of Contents

<b>1. Introduction.....</b>	<b>4</b>
Overview.....	4
Icons.....	5
Hardware Specifications/Features.....	5
Software Specifications.....	7
Technical Support.....	7
Returning Merchandise for Service.....	8
<b>2. Board Installation.....</b>	<b>10</b>
Unpacking.....	10
Installation.....	10
Setting Jumpers.....	23
<b>3. Onboard Resource Settings.....</b>	<b>24</b>
Quick Reference for Jumpers.....	24
Map of Motherboard Jumpers.....	25
Hardware CMOS & Password Reset.....	27
Soft Power Connector.....	29
Speaker Connector Installation.....	29
Hardware Reset Switch Connector Installation.....	29
External SMI.....	29
Chassis Intrusion Alarm Connector.....	30
Ensoniq Audio Connectors.....	30
CMOS RTC.....	30
Flash EEPROM.....	31
RAM Installation.....	31
Cache Memory.....	31
Frequently Asked Questions.....	32
<b>4. BIOS Configuration.....</b>	<b>34</b>
Main Setup.....	35
Advanced CMOS Setup.....	40
Chipset Setup.....	45
Power Management Setup.....	51
Plug and Play/PCI Setup.....	55
Peripheral Setup.....	60
Supervisor and User Security.....	64
Language Utility.....	65
Flash Writer Utility.....	65

<b>5. System Resources</b> .....	<b>66</b>
Beep Codes.....	66
Troubleshooting System Problems.....	67
POST Checkpoint Codes.....	68
Displayed Error Messages.....	75
<b>Appendix 1 - CPU Retention Module Options</b> .....	<b>78</b>
<b>Appendix 2 - Glossary</b> .....	<b>80</b>

# chapter 1

## Introduction

---

### Overview

The S1846 (S1846S and S1846SLA) Tsunami ATX is a quality, high performance motherboard designed for Intel Pentium II microprocessors. This motherboard utilizes the Intel 440BX AGPset and can support CPU speeds of 233MHz through 450MHz, and host bus speeds of 66MHz to 100MHz.

The S1846 motherboard, with built-in AGP slot, provides high performance capabilities that are ideal for a wide range of demanding applications such as CAD, CAM, CAE, desktop publishing, 3D animation, and video production.

This integrated system board achieves high reliability with numerous features and yet is small enough to be supported in an ATX form factor. Some of the features included are onboard dual channel PCI PIO, BUS Master IDE and UltraDMA/33, onboard floppy controller, and onboard high speed I/O.

Flexibility and expandability have been designed into the Tsunami ATX. With I/O and drive controller support built onboard, the one AGP slot, five PCI and two ISA slots (one shared, seven usable) are free for numerous add-on expansion cards.

Remember to take a look at TYAN Computer's web site located at <http://www.tyan.com>. There you can find information on all of TYAN's

products along with FAQs, distributors list, drivers, and BIOS setting explanations.

## Icons

In order to help you navigate this manual and set up your system, we have added several icons to our format.



This icon alerts you to particularly important details regarding the setup or maintenance of your system. This icon often appears next to information that may keep you from damaging your board or system. While we will often point out the most vital paragraphs in a chapter, you should always read every word in the text. Failing to do so can lead to exasperation and expense.



Wherever possible, we have included step-by-step instructions for setting up your system, which are indicated by this icon. However, it is in your best interest to read an entire section (and perhaps the entire manual) before you begin to fiddle with your motherboard.



While we have alerted you to potential dangers in several places in the manual with this icon, these warnings should not be regarded as the whole of your safety regimen. Never forget that computers are electrical devices, and are capable of delivering a shock. Prevent damage to yourself and to your board: always ensure that your system is turned off and unplugged whenever you are working with it, and that you are equipped with a static safety device.

## Hardware Specifications/Features

### Processor Information

- One SEC slot (Slot One type)
- 66MHz to 100MHz bus support (BIOS selectable)
- Pentium II 233-450MHz
- Supports Celeron CPUs

### Chipset Information

- Intel 440BX AGPset
- Intel PIIX4e controller

**Voltage and Power Information**

- National 309 Super I/O chipset
- ATX power supply connector
- +12V power source for DC fan onboard
- 3.3V DRAM support
- Utilizes GTL+ bus to reduce power consumption and EMI

**Main Memory**

- Up to 768MB onboard
- Three 168-pin DIMM sockets
- Supports 100MHz SDRAM with SPD

**System Management**

- Optional National LM79 and LM75 ASICs with onboard alarm for monitoring temperature, supply voltages, and fan speed
- Intel LANDesk Client Manager software (with LM79 installed)
- Chassis intrusion detection capable

**Expansion Slots**

- One 32-bit AGP slot
- Five 32-bit PCI BUS Master slots
- Two 16-bit ISA slots
- One shared, seven usable slots

**Physical Dimensions**

- ATX design
- 12 inches x 8.25 inches
- S1846S requires Intel Venus compatible I/O shield
- S1846SLA requires Intel Caveman compatible I/O shield

**BIOS Information**

- AMI Plug and Play flash BIOS
- Deep Green, Energy Star, ACPI, Year 2000, and PC98 compliant
- Soft power-down, multiple boot options
- Win98/NT5 ready, DMI 2.0 compliant
- PCI 2.1, APM 1.1 compliant

**Disk Drive & System I/O**

- Two PCI bus mastering EIDE

channels

- Supports EIDE CD-ROMs
- PIO Mode 3 & 4 (up to 17MB/sec DTR)
- UltraDMA/33 bus mastering mode (up to 33MB/sec DTR)
- Support for two floppy drives (up to 2.88MB)
- Two serial ports (16550 UARTs)
- One ECP/EPP parallel port
- One IR (InfraRed) I/O interface port
- Two USB rev 1.2 (universal serial bus) connectors
- One PS/2 mouse connector
- One PS/2 keyboard connector

**Ensoniq ES 1371 AudioPCI  
(S1846SLA only)**

- AC97 Codec
- Uses a single, shared IRQ
- High performance PCI bus master
- Spatial enhanced 3D sound (SWS)
- Wavetable synthesis built in
- Joystick, Audio in, Speaker, Microphone connectors

**Warranty**

- 3 year manufacturer's warranty

## Software Specifications

**OS**

- Operates with MS-DOS, Windows 3.x, Windows for WorkGroup 3.x, Windows 95, Windows 98, Windows NT, OS/2, Novell Netware, Solaris, and SCO Unix

## Technical Support

If a problem arises with your system, you should turn to your dealer for help first. Your system has most likely been configured by them, and they should have the best idea of what hardware and software your system contains. Hence, they should be of the most assistance. Further, if you purchased your system from a dealer near to you, you can actually bring your system in to them to have it serviced, instead of attempting to do so yourself (which can have expensive consequences).

**Help resources:**

1. See FAQ and beep codes sections of this manual.
2. See Tyan web site for FAQ, bulletins, driver updates, etc.  
<http://www.tyan.com>
3. Contact your dealer or distributor for help BEFORE calling Tyan.
4. Check the Tyan user group: [alt.comp.periphs.mainboard.tyan](mailto:alt.comp.periphs.mainboard.tyan)
5. Email Tyan tech support: [techsupport@tyan.com](mailto:techsupport@tyan.com)
6. Call Tyan tech support: 510-440-8808

## Returning Merchandise for Service

During the warranty period, contact your distributor or system vendor **FIRST** for any product problems. This warranty only covers normal customer use and does not cover damages incurred during shipping or failure due to the alteration, misuse, abuse, or improper maintenance of products.

**For Resellers Only:**

A receipt or copy of your invoice marked with the date of purchase is required before any warranty service can be rendered. You can obtain service by calling the manufacturer for a Return Merchandise Authorization (RMA) number. The RMA number should be prominently displayed on the outside of the shipping carton and the package should be mailed prepaid, or hand-carried to the manufacturer. TYAN will pay to have the board shipped back to you.



**This page left blank intentionally.**

# chapter 2

## Board Installation

---

### Unpacking

The motherboard package should contain the following:

- (1) S1846S(LA) mainboard
- (1) 40-pin IDE and 34-pin floppy cable pack
- (1) S1846 User's Manual
- (1) Retention module
- (1) Driver CD with Ensoniq AudioPCI manual and installation instructions (S1846S only)
- (1) System Management & Driver CD with Ensoniq AudioPCI manual and installation instructions (1846SLA only)

### Installation

You are now ready to install your motherboard. The mounting hole pattern of the S1846 matches the ATX system board specifications. Your chassis should be that of a standard ATX mainboard form factor.

#### **How to install our products right...the first time.**

##### **What's the first thing I should do?**

The first thing you should do is read this user's manual. It contains important



procedure

information which will make configuration and setup much easier.

The next step is to properly ground yourself. First, unplug the power from your computer case and then touch the metal casing of the power supply or any metal part on the computer case. This will discharge any electricity from your body. Take the motherboard out of the cardboard box and static bag, holding it by its edges, and place it on a grounded anti-static surface, component side up. Inspect the board for damage.



important

**DO NOT APPLY POWER TO THE BOARD IF IT HAS BEEN DAMAGED!**

Press down on any of the socket ICs if it appears that they are not properly seated (the board should still be on an anti-static mat). Do not touch the bottom of the board. Remember, don't take any electronic device out of its protective bag until you are ready to actually install it into the computer case. If you don't ground yourself, you risk zapping the motherboard or adapter card. Subsequent problems may not arise immediately because electrostatic discharge damage, unlike physical damage, causes the device to fail over time.

**Install the motherboard into your case.**

Follow the instructions provided by the case manufacturer for proper installation guidelines. TYAN recommends that you use only one screw to hold down the motherboard. The rest of the mounting holes should be used for the plastic standoffs. If your case does not have a hole for a standoff, simply cut off the bottom of the plastic standoff so that the flat portion rests on the metal. The adapter cards and the screws holding them down will keep your board flat. The fastening screw should not short any of the traces on the motherboard. Make certain that you do not overtighten the screw, as it will damage the motherboard and possibly break internal traces in the surrounding area. The hole you should use is located at the top-center of the board where the adapter cards are fastened to the case.

**Plug in the power connector as shown.**

The photos on the following page show the ATX power connector before (Figure 1) and after (Figure 2) it has been plugged in.

The plastic clip on the power connector should lock over the plastic tab on the onboard connector. You shouldn't be able to plug the power connector in any other way but just to be safe, make sure it looks like Figure 2 (next page). Make absolutely certain that you do not miss any pins because, if you do, you will void your warranty and cause damage to yourself or your motherboard when



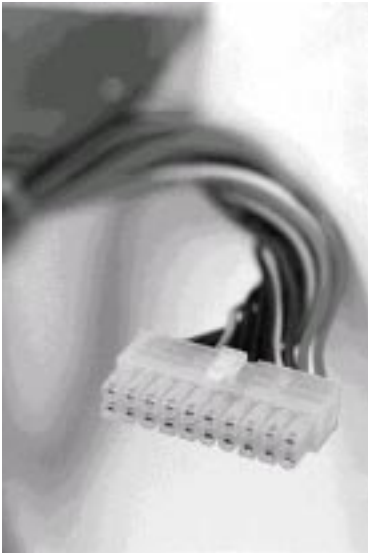

**Figure 1**

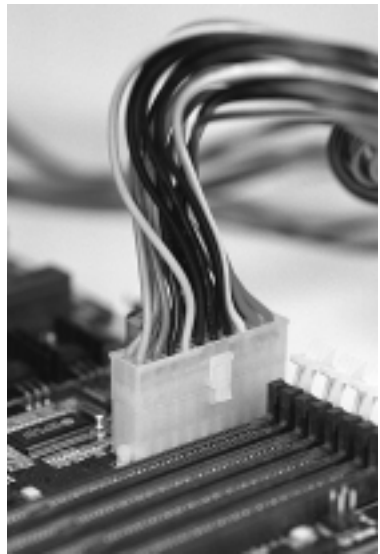

**Figure 2**

you turn the system on. After connecting the power, make sure the connector is seated firmly into its socket so it will not become loose or fall off when the computer is jostled or moved. Note: Tyan recommends using an ATX power supply that conforms to industry standard revision 2.01.

**Next, connect your IDE cables (if you're using IDE hard drives).**

The colored stripe on the cable indicating pin 1 should face towards the rear of the case (towards the ATX connectors).

In Figure 3 on the next page you can see how the IDE cables should look when they are connected to your hard drive. Notice how Pin 1 (denoted by a red stripe) is connected so that it is next to the power connector of the drive. In most cases, this is the proper way of connecting your IDE cable to the hard drive. Figure 4 shows the IDE cable properly connected to the motherboard. Contact your hard disk drive manufacturer or documentation for more information.

Some symptoms of incorrectly installed HDDs are:

- Hard disk drives are not auto-detected: may be a Master/Slave

**Figure 3**

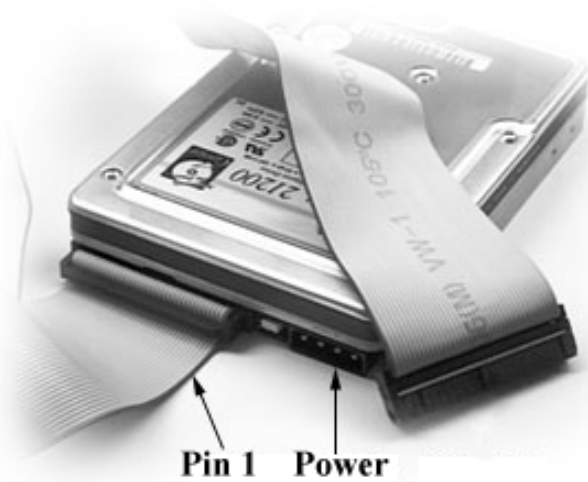

- problem or a bad IDE cable. Contact your vendor.
- Hard Disk Drive Fail message at bootup: may be a bad cable or lack of power going to the drive.
- No video or beeps on bootup: usually means the cable is on backwards.
- Hard drive lights are constantly on: bad IDE cable or defective drives/motherboard. Try another HDD.
- Hard drives do not power up: check power cables and cabling. May also be a bad power supply or IDE drive.

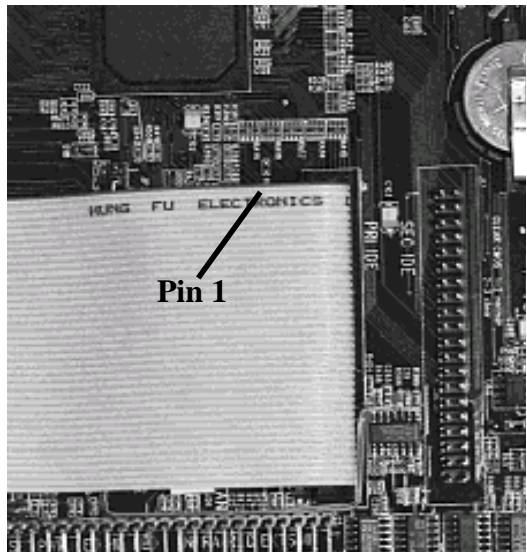
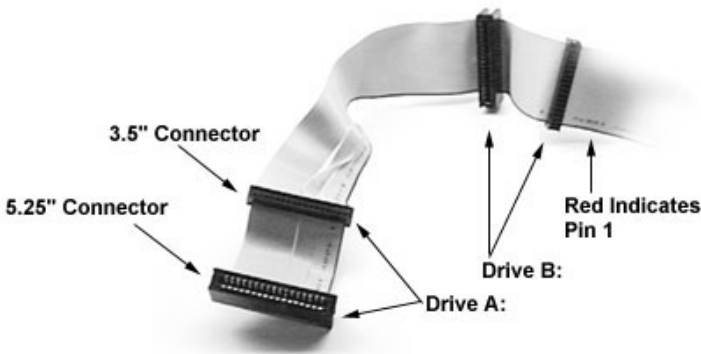

**Figure 4**

**Now that you have installed your IDE drives, your floppies are next.**

Pin 1 on the floppy cable is usually denoted by a red or colored stripe down one side of the cable (see Figure 5). Most of the current floppy drives on the market require that the colored stripe be positioned so that it is right next to the power connector. In most cases, there will be a key pin on the cable which will force you to connect the cable properly.

Drive A: is usually attached to the end of the cable with the twist in it. Drive B: is usually connected to the middle of the cable. Refer to your installation instructions or call your dealer if you are unsure about attaching floppy drives. Refer to Figure 5 below for a detailed anatomy of the floppy cable. Remember, you can only have two floppy drives connected at any given time.



**Figure 5**

The colored stripe on the cable indicating pin 1 should face towards the rear of the case (towards the ATX connectors), as with the IDE cables. Please refer to your documentation for proper installation, or see Figure 4 on page 13.

Some symptoms of incorrectly installed floppies are:

- Floppy drives are not detected: usually caused by faulty cables, backward cables, or a bad floppy or motherboard. Try another single floppy drive to verify the problem or try another cable. Also, check to see if the onboard floppy is enabled in the BIOS.
- Floppy Drive Fail message at bootup: the cable, floppy, or motherboard may be faulty. Try another cable or floppy drive to verify.

- Light on the floppy is on constantly: a dead give-away that the cable is on backwards. Reverse the cable at the motherboard end and try again.

**Next are the Com and Printer ports.**



**Warning:** When plugging in your keyboard and mouse, or when plugging anything into a serial or Com port, make sure that the power is off. Connecting these devices and ports while the power is on is called “hot plugging,” and may damage your system.

Figure 6 below shows the ATX double row connectors on this board. The Com and Printer ports, as well as the other ports, are labeled.

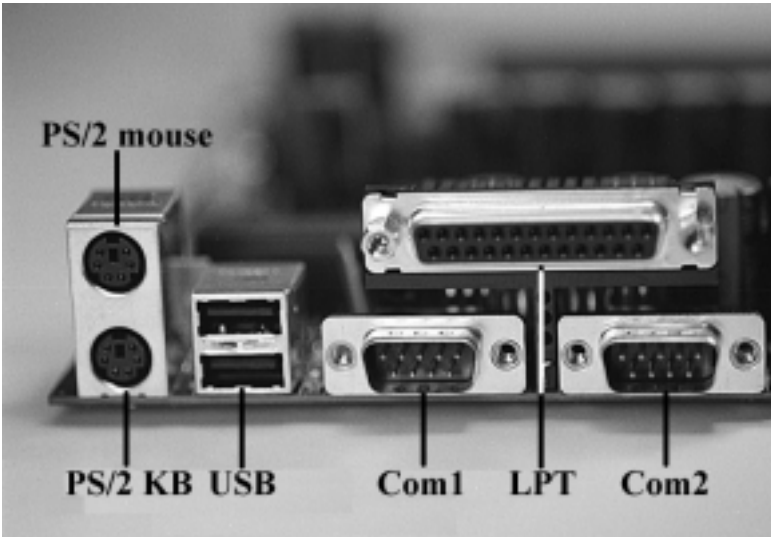

**Figure 6**

Note: Only TYAN cables will work on this motherboard. If you are using an existing case with old cables, your system may not function properly. Use only TYAN-approved cables.

**Connecting the USB and PS/2 ports.**

This board includes ports for USB, PS/2 mouse, and PS/2 keyboard devices. The location of these ports is shown in Figure 6 above. Note that, for this

board, the PS/2 mouse port is the upper PS/2 port, and the PS/2 keyboard port is the lower PS/2 port.

The PS/2 connectors are probably quite familiar to you. The USB connectors, however, may be foreign. The USB (Universal Serial Bus) is a versatile port. This one port type can function as a serial, parallel, mouse, keyboard, or joystick port. It is fast enough to support video transfer, and is capable of supporting up to 127 daisy-chained peripheral devices. Close-ups of the USB connector, as well as of the USB and PS/2 ports, are on the following page.

Figure 7 shows the USB ports and Figure 8 the PS/2 ports.



**Figure 7**

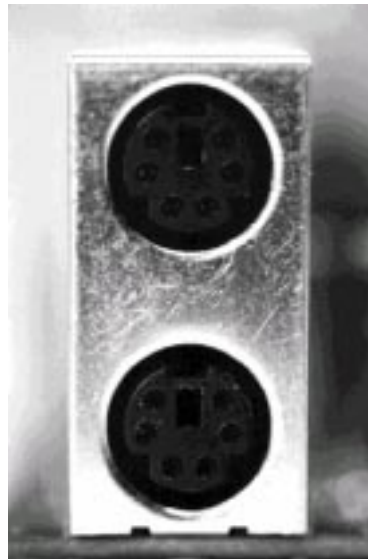

**Figure 8**

**Installing your add-in cards is relatively simple but...**

there are a few rules you need to follow when plugging in a card. In order to assure proper operation and a quick installation, adhere to these guidelines:

- If you are going to install a PCI-Bus interface card on your system, be aware that any one of the two PCI slots can support a Master or Slave





- device.
- NEVER force a card into a slot. If it doesn't fit, look at the socket on the computer to make sure there are no wires or other obstructions to the slot.
  - NEVER plug an ISA card into a PCI slot or a PCI card in an ISA slot. You will void your warranty and damage your system board if you do this.
  - When plugging the card in, especially when installing long cards, try to push the entire card in at one time. Don't force one end of the card into the socket first and then the other. This will create a rocking motion between the card and the slot and it will damage the pins within the socket.
  - Make sure that the cards are seated securely into the slots.
  - Before turning on the system, make sure no cards are touching each other or are shorting.

If you follow these basic guidelines, there shouldn't be any problems with installation. However, if you do encounter any problems, have a qualified professional install your cards for you or contact your card manufacturer.

Remember, always read the manuals and installation notes that come with the adapter cards. They contain important information which will help you install the components right, the first time.

**Next, you need to install your memory.**

Since TYAN boards are manufactured with performance in mind, you should use add-in components that match. Some DIMM modules may seem to be high quality because of name or feel but that does not guarantee real-world usability. Some cheaper or OEM memory may have brand-name components, but they may contain inferior or substandard parts which do not meet the critical tolerances our products require. Because of this, your memory may not work correctly in a TYAN board though it may work well in a competitor's board. This is because many of our competitors do not adhere to the strict tolerances required for high performance. If you buy a TYAN board, you are getting the best system available. To make installation easy and trouble free, get high quality parts. Some brands we recommend are Advantage Memory, Corsair Microsystems, Millenium, Kingston Memory, QesTec Incorporated, Unigen, Micron Technology, and Crucial Technology. These DIMMs have proven to be very stable on our boards and perform extremely well.

**INSTALL**

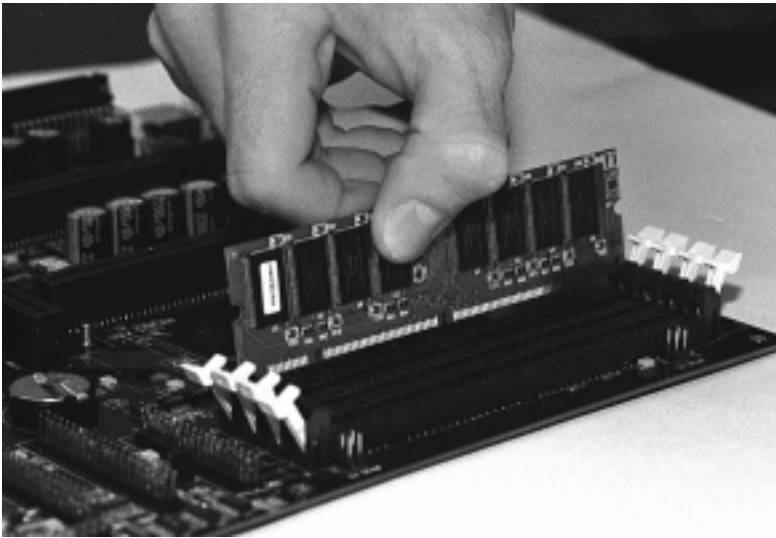

**Figure 9**

To install your DIMMs, line your module up so that the pins fit into the slot. There is only one way that your DIMM can fit properly. Make sure that the short row of pins is lined up with the short gap in the DIMM slot. Figure 9 shows how to sit the DIMM into its slot. To insert the DIMM, push down vertically on the module with even force, as shown in the photo. Do not shove one end in first; doing so will bend the DIMM pins.



important!

To lock the DIMM into place, push the plastic clips on either end of the slot onto the notches in the ends of the DIMM (see Figure 10 on the next page). To remove your DIMM, simply pull the clips back, and pull up on the module.

Place the DIMMs in an anti-static bag as soon as you remove them to avoid static damage.

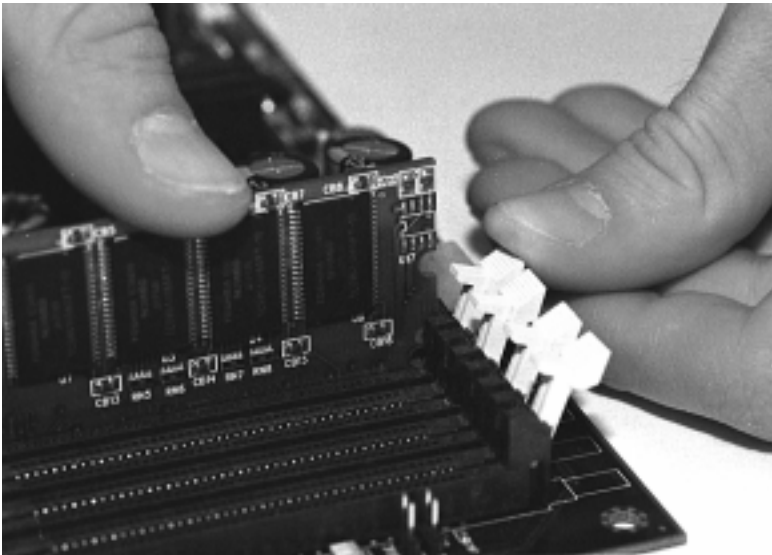

**Figure 10**

**Finally, install your CPU.**

Pentium II processors (233 through 450MHz) can be used on the Tsunami. Please refer to page 27 for the correct CPU jumper settings for your board. Remember:



- The CPU is a sensitive electronic component and it can easily be damaged by static electricity. Do not touch the CPU pins with your fingers.
- Before the CPU is installed, the mainboard must be placed on a flat surface. You should be able to insert the CPU with minimal, but firm, pressure. Do not press down hard on the CPU.

Currently, Intel produces two types of Pentium II processors: the active (or boxed) processor and the passive processor (see Figures 11 and 12 on the next page). These two types of processors are essentially the same in design; the only difference lies in their cooling methods. The active processor is equipped with a cooling fan and heat sink, while the passive processor is equipped with a heat sink alone. Both types of CPUs provide the user with the same performance, and both types can be installed in the Pentium II slot on the Tsunami board.



**Figure 11**



**Figure 12**

### **Installing CPU Retention Modules**

Installation of a Pentium II processor requires a CPU retention module, which is first secured onto the motherboard.

To attach the retention module, place the motherboard on a flat surface. Locate the key pin on one end of the Pentium II slot on the board. Then carefully line up the key notch on the retention module with the key pin on the Pentium II slot (the key pin on the Pentium II slot indicates the correct orientation of the CPU).

Drop the retention module (Figure 14 below) down over the Pentium II slot so that the retention module sits flat against the motherboard. Tighten the



**Figure 14**

**Figure 13**



**Pentium II Slot Connector  
and Key Pin**

screws in a clockwise manner to secure the module to the board. Warning: Do not overtighten the screws as you may damage the module and/or the motherboard.

### **Installing the Active Processor**

When the retention module is securely installed, you are ready to plug in the CPU. Press down firmly on the CPU until you hear a “click” (see Figure 15 on the following page). This clicking sound indicates that the



**Figure 15**

(see Figure 16 below).

CPU is fully locked into the retention module. If you have an active processor, you will also need to connect the CPU's cooling fan cable to the cooling fan power connector on the board.

Locate the cooling fan connector (e.g. FAN1) on the motherboard. Plug the CPU's cooling fan cable into the cooling fan connector on the board. There will be a plastic clip assembly similar to that of the ATX power connector that will force you to connect the fan cable correctly

**INSTALL**

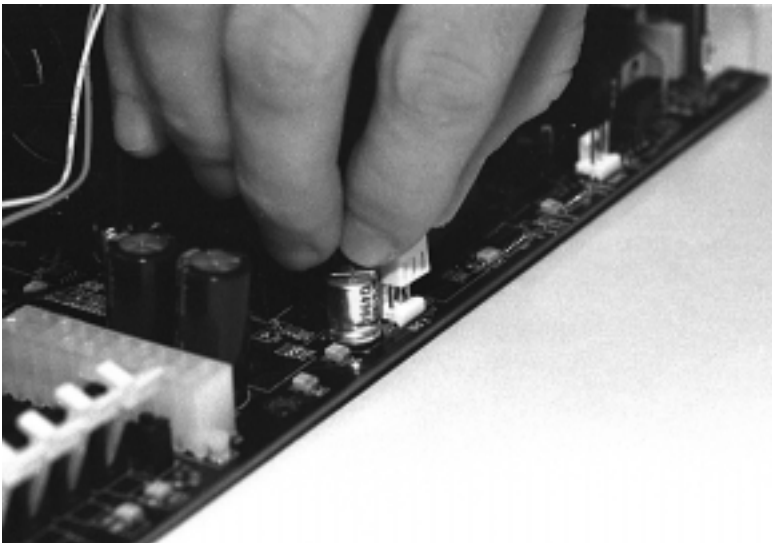

**Figure 16**

### **Installing the Passive Processor**

The installation of the passive processor differs only slightly from that of the active processor. Your passive CPU package should contain one CPU retention module, one heat sink retention bracket with mounting locks, two mounting attachments, and one heat sink lock. Install the retention module as explained in the active processor section.

The heat sink mount (Figure 17 on the next page) has two pins on the bottom

and four pins on the top. Notice that the bottom two pins are of different sizes. The size of the pins and the holes in the motherboard will determine the correct orientation. When the bracket is correctly installed, the four pins on top will be right next to the Pentium II CPU slot.



**Figure 17**

Insert the heat sink mount into the holes on the motherboard. When the bracket is properly inserted into the holes on the motherboard, you will hear a clicking noise.

Align the CPU with the CPU retention module. Make sure the heat sink is lined up with the heat sink mount bracket. If you put the CPU in the wrong way, you may damage the CPU, the motherboard, and/or the CPU socket. Slowly press down on the CPU module until the CPU locks into place. You will hear a clicking noise when the CPU is locked securely into the module.

The heat sink lock (Figure 18) has four notches which will correspond to the four pins on the heat sink mounting bracket. Gently slide the lock between the heat sink and the heat sink mounting bracket until both sides of the lock are firmly secured. A clicking sound will be heard when the lock is securely fastened to the heat sink mounting bracket. To remove the lock from the heat sink mounting bracket, gently press the ends of the locks inward and pull.



**Figure 18**



**Figure 19**

Lock the heat sink mount to the board by inserting the two mounting locks (Figure 19) into the pins of the heat sink mounting bracket which are now below the mainboard. There will be a click when the locks are securely fastened.

### **Removing the CPU.**

To remove the CPU, move the locks to the center of the CPU. A click will be heard when the CPU has been unlocked. Gently pull up on the CPU, taking care not to bend the motherboard or the CPU retention module.

To remove the lock from the retention module, gently press the ends of the locks inward and pull.

**You are done.**

Other than checking the jumper settings and cable connections and putting the case back on, you are done. Installing a new motherboard may sound difficult, but by following these directions, you should have a fairly uneventful time installing our products. If you do encounter problems, your dealer will be able to help you, or you can consult one of our many technical support resources (see page 7).

## Setting Jumpers

In this manual, the terms “closed” and “on” are used when referring to jumpers (or jumper pins) that are active; “open” and “off” are used when referring to jumpers (or jumper pins) that are inactive. Jumpers and pins are connected by slipping the blue plastic jumper connector overtop of two adjacent jumper pins. The metal rod inside the plastic shell bridges the gap between the two pins, completing the circuit. See the drawings below for examples of “on” and “off” pins and jumpers.

### 2 pin jumpers

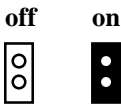

### 3 (or more) pin jumpers

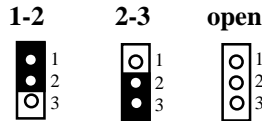

# chapter 3

## Onboard Resource Settings

---

### Quick References for Jumpers

The tables on the following pages will help you set the jumpers for CPU speed, wake on events, and external connector pin assignments among other things. The miniature motherboard maps will help you locate the jumpers on your board. A full-page map of the motherboard can be found on the facing page.



# Map of Motherboard Jumpers

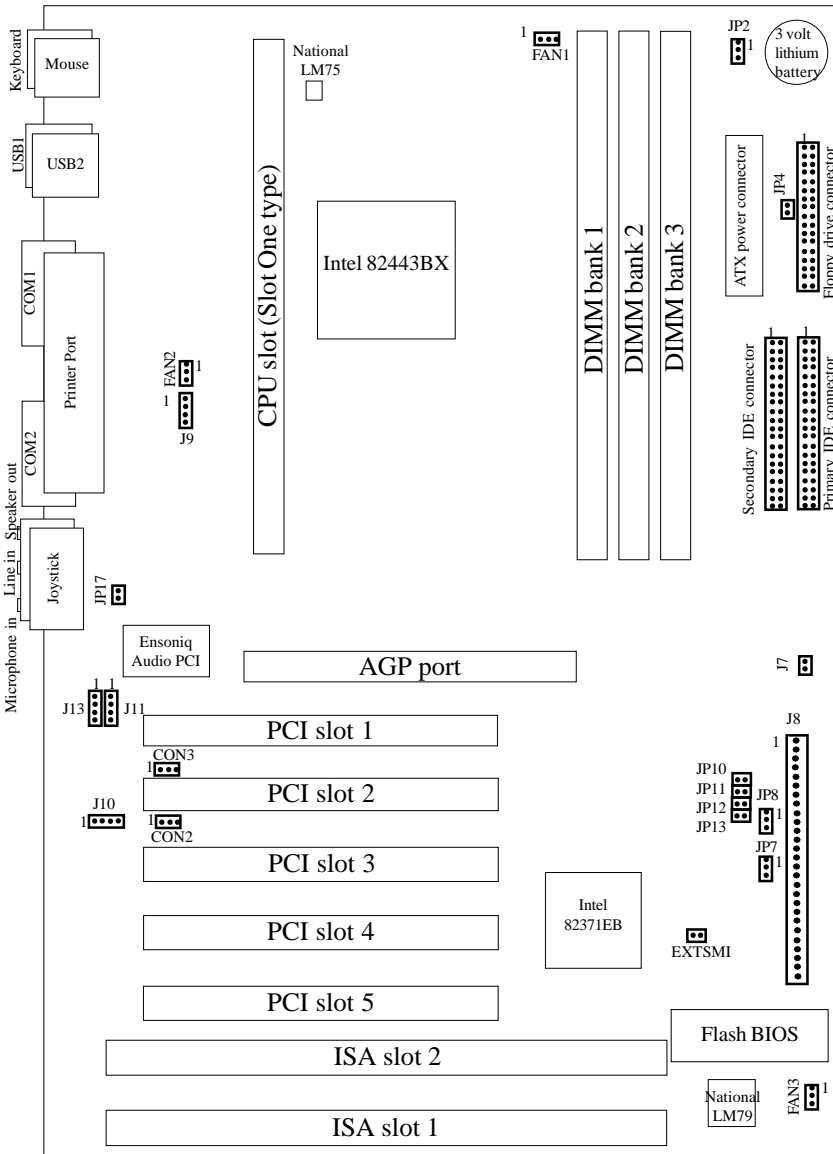

**ONBOARD**

The tiny "1"s next to jumpers of 3 pins or more indicate the position of pin 1 for that jumper.

**TYAN** Chapter 3  
 COMPUTER Onboard Resource Settings

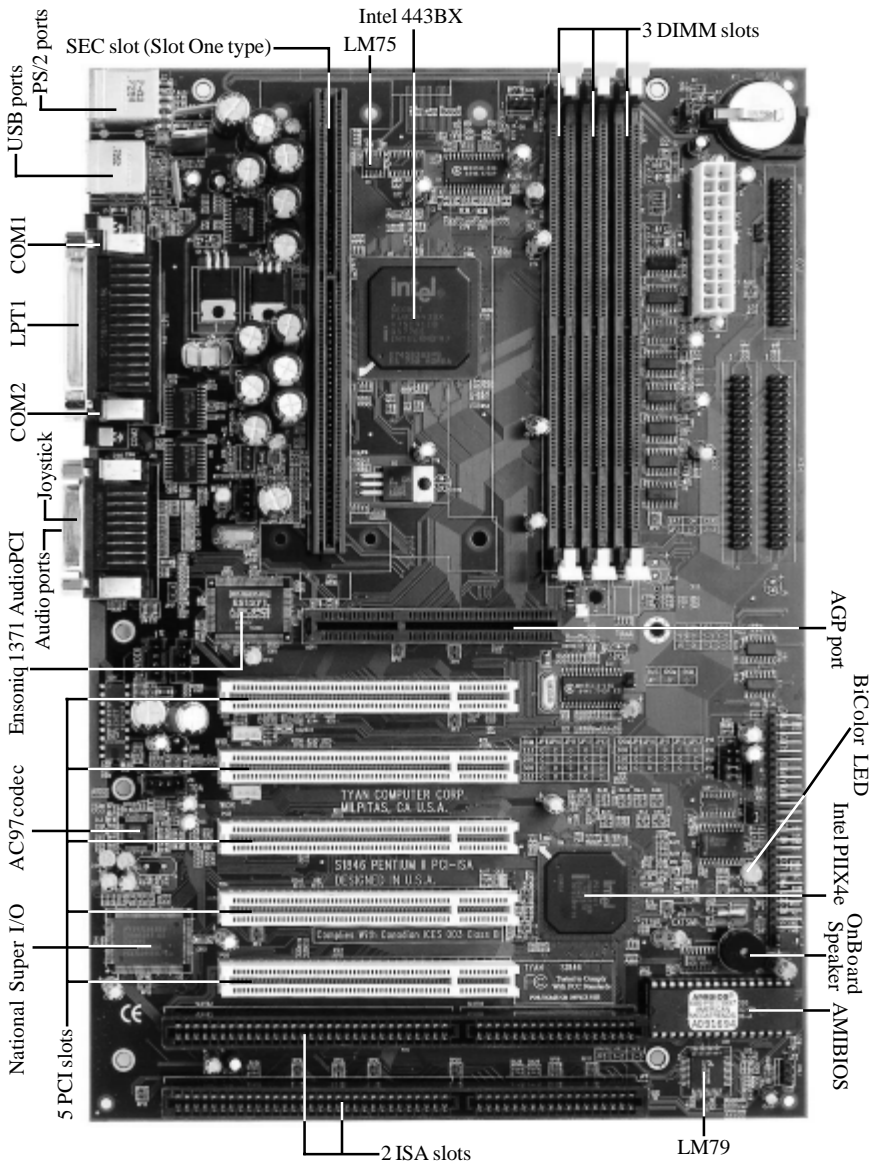

### CPU Settings for 66MHz Bus

Clock Speed	Mult	JP10	JP11	JP12	JP13
233MHz	x3.5	ON	OFF	OFF	ON
266MHz	x4	OFF	ON	ON	ON
300MHz	x4.5	OFF	ON	OFF	ON
333MHz	x5	OFF	OFF	ON	ON

### CPU Settings for 100MHz Bus

Clock Speed	Mult	JP10	JP11	JP12	JP13
350MHz	x3.5	ON	OFF	OFF	ON
400MHz	x4	OFF	ON	ON	ON
450MHz	x4.5	OFF	ON	OFF	ON

The CPU speed is controlled by setting the bus speed (described in BIOS setup) and by setting the multiplier with the jumpers described above that are appropriate for your CPU and memory. You must have a 100MHz processor to run at a bus speed of 100MHz. Tyan does not recommend and is not responsible for functionality or damage to components caused by operating a CPU, memory or any bus at higher than rated speeds (overclocking).



**ONBOARD**

### Onboard Sound Enable

Sound	Enable	Disable
JP17	OFF	ON

### Hardware CMOS & Password Reset

	Default	Reset
JP2	1-2	2-3

If you have been locked out of your system because you forgot your password or set the CMOS incorrectly, follow the

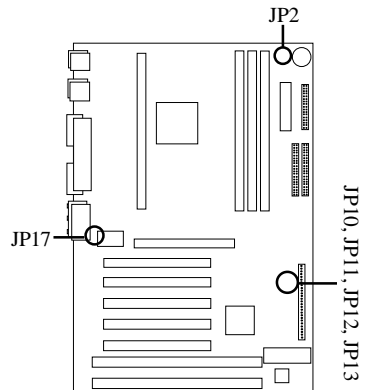

instructions below.



1. Power off the system
2. Set jumper JP2 to pins 2 and 3 (see previous page for location of JP2).
3. Wait for 2 seconds, then return jumper JP2 to pins 1 and 2.
4. Power on the system again.

By following this procedure, you will erase your password and reset the CMOS to the BIOS defaults.

### InfraRed/Floppy Drive Settings

IR/FDD	JP4	JP7	JP8
<b>2 FDD</b>	ON	2-3	1-2
<b>1 IR/1 FDD (Default)</b>	OFF	1-2	2-3

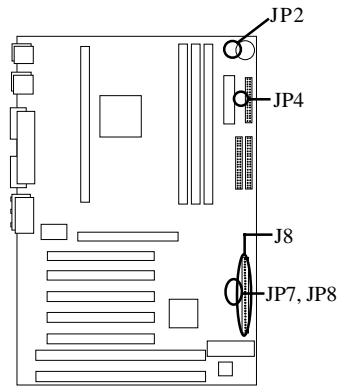

### J8 External Pin Assignments

Pins	1-2	6-10	13-16	18-20	22-23	24-27
<b>Function</b>	Power On/Off	InfraRed	HDD LED	Power LED	Reset Switch	Speaker
<b>Assignment</b>	1=on/off 2=5VSB	6=5V 8=IR RX 9=GND 10=IR TX	13=5V 15=LED- 16=LED+	18=Sleep LED 20=Power LED	22=GND 23=Reset	24=5V 26=Internal Speaker 27=Speaker-

### Other Pin Assignments

	1	2	3
<b>FAN1-3</b>	GND	VCC	Fan Monitor
<b>CON3 (Wake-on LAN)</b>	Standby 5V	GND	Wake (Power On, Active High)

## Soft Power Connector

The Soft Power Connector is located on pins 1 and 2 of jumper block J8. The Tsunami uses the PIIX4e chip for power management, including turning on and off the system. If the Power Button Function option in the Power Management Menu is set to On/Off (which is the default), pressing the power button once, after the BIOS has booted up, will turn the system on and off. If the Power Button Function option is set to Suspend, pressing the power button once will wake the system or send it in to Suspend mode. In this case, you cannot turn the system off unless you shut down through the Windows operating system or you hold the power button down for four seconds.

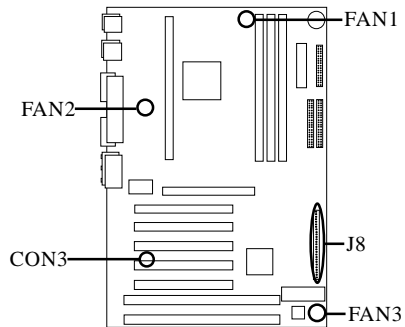

## Speaker Connector Installation

The Tsunami provides a 4-pin header to connect the speaker. The speaker is connected to pins 24-27 of jumper block J8. A jumper on pins 26-27 is the default setting for the onboard speaker.

## Hardware Reset Switch Connector Installation

The Reset switch on your case's display panel provides you with the Hardware Reset function, which is the same as power on/off. The system will do a cold start after the Reset button is pushed. The Reset switch is a 2-pin connector and should be installed on pins 22 and 23 of jumper block J8.

## External SMI

The EXTSMI (External System Management Interface) connector, JP16, is used by some plug-in cards. Certain applications associated with these plug-in cards use the interface for hardware control and queries.

**ONBOARD**

## Chassis Intrusion Alarm Connector

The J7 connector is an intrusion alarm, that can be connected to the system chassis. When active (J7 is closed), this alarm will alert the system administrator anytime someone opens the system's case.

## Ensoniq Audio Connectors (S1846SLA only)

There are four black 4-pin connectors onboard which are used for various peripherals' audio signals. The digital signal that comes in through these connectors is directed through the Ensoniq 1371 PCI sound chip, and the digital signal is turned into an audio signal which goes out through the speaker. The TDA connector (J10) is for modem audio; the MPEG connector (J9) is for DVD and TV cards; the VIDEO connector is (J11); the CD connector (J13) is for CD-ROMs.



important!

### Windows 95 Users:

You may encounter problems with some of the devices in the Intel 82371EB chipset. Neither the PCI Bridge nor the PCI Universal Serial Bus device IDs for this chipset (also called PIIX4e) are recognized by Windows 95. This is a software problem, not a hardware problem, and can be easily remedied by either upgrading to Windows 98 or downloading the 82371EB patch found at <http://www.tyan.com/html/drivers.html> or at <ftp://download.intel.com/design/pcisets/busmastr/setupex.exe>. Note that USB requires Windows 95 OSR 2.1 or above; please contact Microsoft for the USB update.

## CMOS RTC

The 440BX AGPset includes a Real Time Clock (RTC) circuit, which provides the date and time for the system. If the external battery for the RTC is low, it will prevent your system from POSTing, and you will not get a display.. If your battery is running low ,you will need to replace it with a new 3V lithium battery (Sony CR2032).

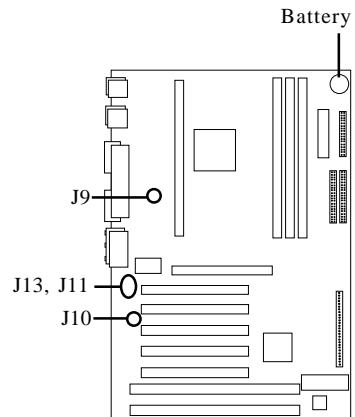

## Flash EEPROM

The Tsunami uses flash memory to store BIOS programs. It can be updated as new versions of the BIOS become available. You can upgrade your BIOS easily using the flash utility (see page 65).

## RAM Installation

The Tsunami uses a 64-bit data path from memory to CPU and can accommodate up to 768MB of SDRAM. The 168-pin DIMMs must be of the 3.3V, **unbuffered** variety. The position of the notch in the DRAM key position will tell you whether or not a DIMM is unbuffered (see the figure below). All installed memory will be automatically detected, so there is no need to set any jumpers.

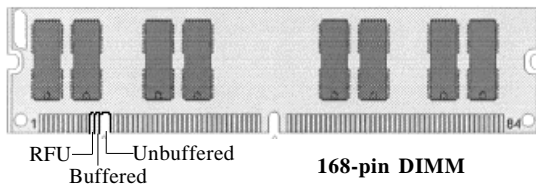

Some details of memory installation:

- One unbuffered DIMM must be installed for the system to POST.
- The mainboard supports 8MB, 16MB, 32MB, 64MB, 128MB, and 256MB SDRAM DIMM modules.
- 256MB Registered SDRAM is supported, but can not be mixed with non-registered SDRAM.

## Cache Memory

Pentium II processors have the L2 (Level 2) cache built into their architecture, so there is no need for an L2 cache on the motherboard. The Pentium II processor has a physical L2 cache size of 512KB and a cacheable memory area of 512MB.

The table below shows some of the possible memory configurations. Not all possible configurations are listed.

DIMM Bank 1	DIMM Bank 2	DIMM Bank 3	Total
8MBx1	0	0	8MB
8MBx1	8MBx1	0	16MB
8MBx1	8MBx1	8MBx1	24MB
16MBx1	8MBx1	8MBx1	32MB
16MBx1	16MBx1	8MBx1	40MB
16MBx1	16MBx1	16MBx1	48MB
32MBx1	16MBx1	16MBx1	64MB
32MBx1	32MBx1	16MBx1	80MB
32MBx1	32MBx1	32MBx1	96MB
64MBx1	32MBx1	32MBx1	128MB
64MBx1	64MBx1	32MBx1	160MB
64MBx1	64MBx1	64MBx1	192MB
128MBx1	64MBx1	64MBx1	256MB
128MBx1	128MBx1	64MBx1	320MB
128MBx1	128MBx1	128MBx1	384MB
256MBx1	256MBx1	0	512MB
256MBx1	256MBx1	256MBx1	768MB

## Frequently Asked Questions

**Q:** Why don't I get a display after I put in my old DIMM module?

**A:** The 440BX chipset requires the memory manufacturer to program an EEPROM chip with SPD (Serial Presence Detection) on the module in order for the BIOS to program the 440BX's timing registers properly. Your DIMM may not have the EEPROM chip on the module, or the EEPROM may not contain the correct program. Check with your memory vendor for details. The figure on the following page shows a DIMM module with an EEPROM chip.



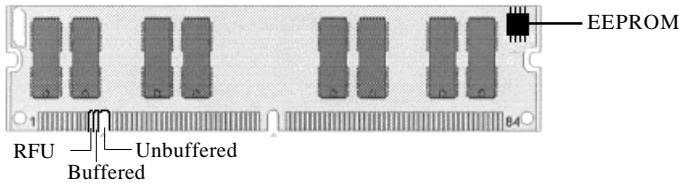

**168-pin DIMM**

**Q:** My system sometimes becomes unstable. How should I check the system?

**A:** The first thing to do is to check and see if you have any device conflict in address, IRQ, or DMA. If you are using Windows 95, the Device Manager is a good place to start. Please consult your operating system manual for details. Second of all, slowing down the memory timing in the BIOS's chipset setup section will help the situation, as well. Many memory modules are not suitable for high performance systems and are probably the main source of your problem.

**Q:** Can I use EDO DIMMs on this motherboard?

**A:** No. The Intel 440BX AGPset does not support EDO memory. The 440BX AGPset supports bus speeds of 100MHz, and EDO memory does not. You must use SDRAM (which does support 100MHz bus speeds) on this board.

**Q:** What is AGP?

**A:** AGP (Accelerated Graphics Port) is a new bus architecture for 3D graphics. The AGP slot eliminates the PCI bandwidth bottleneck by bypassing the PCI interface and accessing the system memory directly. Currently, the AGP supports 1X and 2X modes, which yield bandwidths of 264MB/s (at 33MHz bus speed) and 533MB/s (at 66MHz bus speed), respectively. Compare this with the mere 132MB/s (at 33MHz bus speed) that you get with the PCI bus.

**Q:** Does my operating system support AGP?

**A:** Currently, only Windows 98 and Windows NT 5.0 will have built-in support for AGP. Some AGP cards require Windows 95 OSR2.1 or a special driver from Intel. Please check with your graphics vendor for more details.

# chapter 4

## BIOS Configuration

The AMIBIOS Setup screen is shown below.

AMI BIOS EASY SETUP UTILITY Ver.1.16 (c)1998 American Megatrends, Inc. All Rights Reserved	
Main    Advanced    Security    Exit	
System Date    Thu Oct 15 1998 System Time    12:55:37  Floppy Drive A    1.44 MB 3¼ Floppy Drive B    Not Installed  Primary IDE Master    Auto Primary IDE Slave    Auto Secondary IDE Master    Auto Secondary IDE Slave    Auto  Auto-Detect Hard Disks    [ Enter ]  Boot Sector Virus Protection    Disabled	Setup Help  Month:    Jan - Dec Day:      01 - 31 Year:     1901 - 2099   - Previous Item - Next Item -> Select Menu
ESC:Exit    Enter:Select    F5:Setup Defaults    F6:Original Values    F10:Save & Exit	

You can select a Setup option by using the following keyboard keys:

Key	Function
Tab	Moves from one box to the next
Arrow keys	Changes selections within a box
Enter	Opens highlighted selection

The pages which follow contain explanations of the settings for the AMIBIOS Setup menus. Drawings have been included for ease of reference. Overall, the AMIBIOS Setup program is easy to use, and fairly intuitive. Note that the graphics in the manual are simpler than those that appear on your screen.

## Main Setup

Select the AMIBIOS Setup options below by choosing Main Setup from the AMIBIOS Setup main menu. The Standard Setup menu screen is shown below.

AMI BIOS EASY SETUP UTILITY Ver.1.16  
 (c)1998 American Megatrends, Inc. All Rights Reserved

**Main**    Advanced    Security    Exit

**System Date**    **Fri Jan 1 1999**  
**System Time**    12:55:37

Floppy Drive A    1.44 MB 3¼  
 Floppy Drive B    Not Installed

Primary IDE Master    Auto  
 Primary IDE Slave    Auto  
 Secondary IDE Master    Auto  
 Secondary IDE Slave    Auto

Auto-Detect Hard Disks    [ Enter ]

Boot Sector Virus Protection    Disabled

Setup Help

Month:    Jan - Dec  
 Day:    01 - 31  
 Year:    1901 - 2099

- Previous Item  
 - Next Item  
 -@ Select Menu

ESC:Exit    Enter:Select    F5:Setup Defaults    F6:Original Values    F10:Save & Exit

**System Date/Time**

You can type the date and time in directly, or select the portion of the date or time that you want to modify and adjust it using the - - cursor keys. The clock runs on a 24-hour cycle (i.e. 1:00 PM is 13:00).

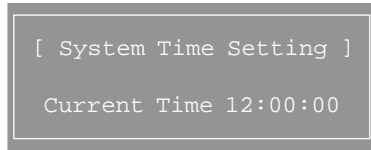
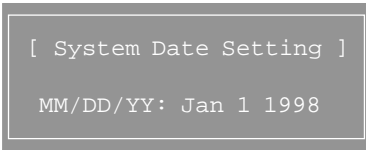

**Floppy Drive A: and B:**

Move the cursor to these fields via the arrow keys and select the floppy type. The settings are 360KB 5¼ inch, 1.2 MB 5¼ inch, 720KB 3½ inch, 1.44MB 3½ inch, or 2.88MB 3½ inch. If you are not sure what type of floppy drive you have, consult the documentation that came with your drive.

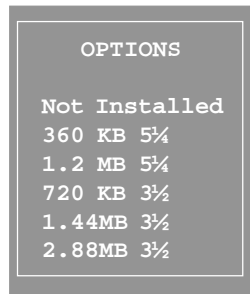

**Primary Master, Primary Slave, Secondary Master, Secondary Slave**

Select these options to configure the various drives. A screen with a list of drive parameters appears.

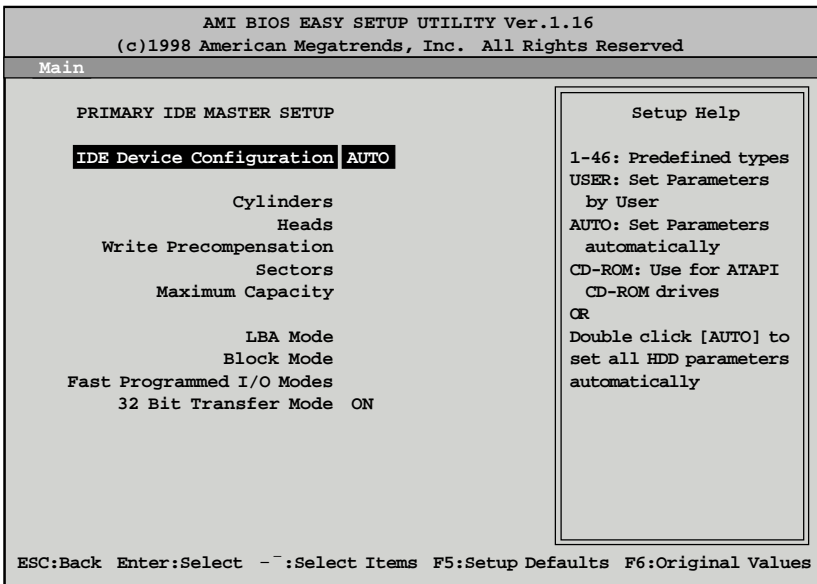

**IDE Device Configuration:** To have the BIOS autodetect the IDE drive, select Auto. Otherwise, you may choose one of the 46 drive types offered, or enter the parameters yourself (see Entering Drive Parameters on page 42). Consult the table below to see how to configure various drive types yourself.

Type	How to Configure
SCSI	Select <i>Type</i> . Select <i>Not Installed</i> on the drive parameter screen. The SCSI drivers provided by the SCSI manufacturer should allow you to configure the SCSI drive.
IDE	Select <i>Type</i> . Select <i>Auto</i> to let AMIBIOS determine the parameters. Click on <i>OK</i> when AMIBIOS displays the drive parameters. Select <i>LBA Mode</i> . Select <i>On</i> if the drive has a capacity greater than 540MB. Select <i>Block Mode</i> . Select <i>On</i> to allow block mode data transfers. Select <i>32-Bit Mode</i> . Select <i>On</i> to allow 32-bit data transfers. Select the <i>PIO Mode</i> . It is best to select <i>Auto</i> to allow AMIBIOS to determine the PIO mode. If you select a PIO mode that is not supported by the IDE drive, the drive will not work properly. If you are absolutely certain that you know the drive's PIO mode, select PIO mode 0-4, as appropriate.
CD-ROM	Select <i>Type</i> . Select <i>CDROM</i> . Click on <i>OK</i> when AMIBIOS displays the drive parameters.
Standard MFM	(MFM drives are older IDEs which use an encoding scheme that produces slower data access and less storage room.) Select <i>Type</i> . You must know the drive parameters. Select the drive type that exactly matches your drive's parameters.
Non-Standard MFM	Select <i>Type</i> . If the drive parameters do not match the drive parameters listed for drive types 1-46, select <i>User</i> and enter the correct hard disk drive parameters.

**LBA/Large Mode:** These modes make it possible for the BIOS to take advantage of the additional space on drives which are larger than 504MB. This can be autodetected (when you select Auto for Type), or you can turn the modes On or Off yourself.

**Block Mode:** If On, Block Mode automatically detects the optimal number of block read/writes per sector that the drive can support.

**Fast Programmed I/O Modes:** Programmed Input/Output is a method of transmitting data between devices that uses the system's CPU as part of the data path. There are 6 modes - 5 with their own transmission speed and 1 auto mode. To use modes 3 and 4, you must be using an Enhanced IDE drive.

PIO Mode	Data Transfer Rate (MBps)
Auto	
0	3.3
1	5.2
2	8.3
3	11.1
4	16.6

**32bit Transfer Mode:** If On, allows for the transmission of 32 bits in parallel (i.e. at the same time). If Off, only 16 bits will be transmitted in parallel.

**Entering Drive Parameters**

If you select User for the drive Type, you can enter the hard disk drive parameters yourself. The drive parameters are as follows:

Parameter	Description
Type	The number for a drive with certain identification parameters (see the next page for a table of drive types).
Cylinders (Cyl)	The number of cylinders in the disk drive.
Heads (Hd)	The number of heads.
Write Precompensation (WP)	The actual physical size of a sector gets progressively smaller as the track diameter diminishes. Yet, each sector must still hold 512 bytes. Write precompensation circuitry on the hard disk compensates for the physical difference in sector size by boosting the write current for sectors on inner tracks. This parameter is the track number on the disk surface where write precompensation begins.
Sectors (Sec)	The number of sectors per track. MFM drives have 17 sectors per track. RLL drives have 26 sectors per track. ESDI drives have 34 sectors per track. SCSI and IDE drives have even more sectors per track.
Size	The formatted capacity of the drive is the number of heads times the number of cylinders times the number of sectors per track times 512 (bytes per sector).

### Auto-Detect Hard Disks

This option lets the system detect your hard disk(s) automatically for your convenience.

### Boot Sector Virus Protection

The available settings for this option are 'Enable' and 'Disable'.

## Default Settings

Every option in AMIBIOS Setup contains two default values: a Fail-Safe default and the Optimal default value. You can also choose to restore the original BIOS settings (i.e. those that your board came with) at any time. These options can be found in the 'Exit' menu.

### Optimal Defaults

The Optimal default values provide optimum performance settings for all devices and system features.

### Fail-Safe Defaults

The Fail-Safe default settings consist of the safest set of parameters. Use them if the system is behaving erratically. They should always work but do not provide optimal system performance characteristics.

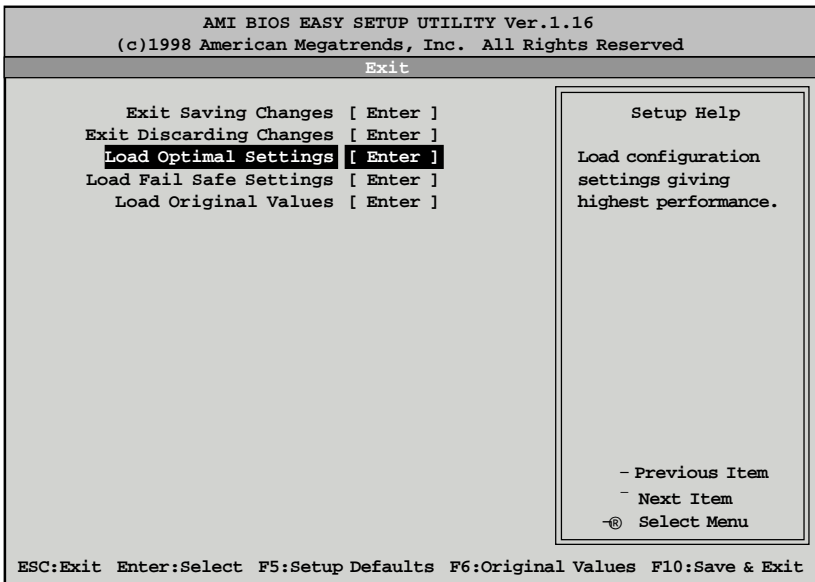

## Advanced CMOS Setup

The Advanced Setup options included in the AMIBIOS Setup for the Thunder X are described in this chapter. Select Advanced Setup from the AMIBIOS Setup main menu to display the Advanced Setup options.

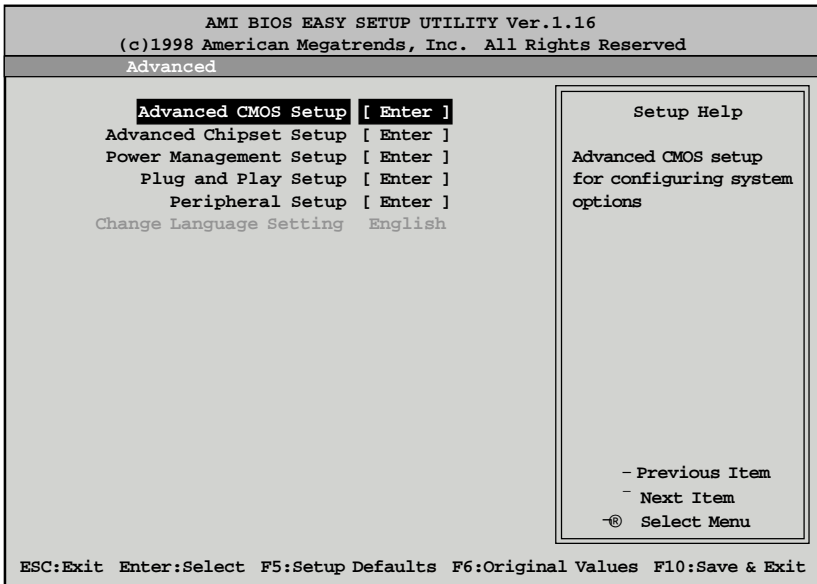

## Advanced CMOS Setup Default Settings Chart

Setting Option	Optimal Default	Fail-Safe Default
Quick Boot	Disabled	Disabled
Primary Master ARMD Emulated as	Auto	Auto
Primary Slave ARMD Emulated as	Auto	Auto
Secondary Master ARMD Emulated as	Auto	Auto
Secondary Slave ARMD Emulated as	Auto	Auto
1st Boot Device	Floppy	Floppy
2nd Boot Device	1st IDE-HDD	1st IDE-HDD
3rd Boot Device	AT API CDR OM	AT API CDR OM
Try Other Boot Devices	Yes	Yes
Floppy Access Control	Read-Write	Read-Write
Hard Disk Access Control	Read-Write	Read-Write



## Settings Chart (Continued)

Setting Option	Optimal Default	Fail-Safe Default
S.M.A.R.T. for Hard Disks	Dis abled	Dis abled
Boot Up Num-Lock	On	On
P.S/2 Mouse Support	E nabled	E nabled
Primary Display	VGA/E GA	VGA/E GA
Password Check	S etup	S etup
Boot to OS/2	No	No
Internal Cache	WriteB ack	WriteB ack
System BIOS Cacheable	E nabled	Dis abled
Cache Bus ECC	E nabled	E nabled
Default Primary Video	AGP	AGP
MPS Revision	1.1	1.1
C000, 16K Shadow	Cached	Cached
C400, 16K Shadow	Cached	Cached
C800, 16K Shadow	Dis abled	Dis abled
CC00, 16K Shadow	Dis abled	Dis abled
D000, 16K Shadow	Dis abled	Dis abled
D400, 16K Shadow	Dis abled	Dis abled
D800, 16K Shadow	Dis abled	Dis abled
DC00, 16K Shadow	Dis abled	Dis abled

## Advanced Setup

### Quick Boot

Set this option to Enabled to instruct AMIBIOS to boot quickly when the computer is powered on. This option replaces the old Above 1 MB Memory Test Advanced Setup option. The settings are:

Setting	Description
Disabled	AMIBIOS tests all system memory. AMIBIOS waits up to 40 seconds for a READY signal from the IDE hard disk drive. AMIBIOS waits for .5 seconds after sending a RESET signal to the IDE drive to allow the IDE drive time to get ready again. AMIBIOS checks for a <Del> key press and runs AMIBIOS Setup if the key has been pressed.
Enabled	AMIBIOS does not test system memory above 1MB. AMIBIOS does not wait up to 40 seconds for a READY signal from the IDE hard disk drive. If a READY signal is not received immediately from the IDE drive, AMIBIOS does not configure that drive. AMIBIOS does not wait for .5 seconds after sending a RESET signal to the IDE drive to allow the IDE drive time to get ready again. You cannot run AMIBIOS Setup at system boot, because there is no delay for the Hit <Del> to run Setup message.

**Pri/Sec Master/Slave ARMD Emulated as**

ATAPI Removable Media Disks (e.g. ZIP drives) are hybrid drives. They are removable, and can be used as floppy drives, but also have great capacity and so are sometimes used as hard drives. These four options ensure that, if you have an ARMD attached as a master or slave device, it can be properly detected by the system. The settings are Auto, Floppy, and Hard Disk.

**1st Boot Device**

This option sets the type of device for the first boot drive that the AMIBIOS attempts to boot from after AMIBIOS POST completes. The settings are Disabled, 1st IDE-HDD, 2nd IDE-HDD, 3rd IDE-HDD, 4th IDE-HDD, Floppy, ARMD-FDD, ARMD-HDD, ATAPI CDROM, SCSI, NETWORK, and I<sub>2</sub>O.

**2nd Boot Device**

This option sets the type of device for the second boot drive that the AMIBIOS attempts to boot from after AMIBIOS POST completes. The settings are Disabled, 1st IDE-HDD, 2nd IDE-HDD, 3rd IDE-HDD, 4th IDE-HDD, Floppy, ARMD-FDD, ARMD-HDD, ATAPI CDROM, and SCSI.

**3rd Boot Device**

This option sets the type of device for the third boot drive that the AMIBIOS attempts to boot from after AMIBIOS POST completes. The settings are Disabled, 1st IDE-HDD, 2nd IDE-HDD, 3rd IDE-HDD, 4th IDE-HDD, Floppy, ARMD-FDD, ARMD-HDD, ATAPI CDROM.

**Try Other Boot Devices**

Set this option to Yes to instruct AMIBIOS to attempt to boot from any other drive in the system if it cannot find a boot drive among the drives specified in the 1st Boot Device, 2nd Boot Device, and 3rd Boot Device options. The settings are Yes or No.

**Floppy Access Control**

This option specifies the read-write access that is set when booting from a floppy drive. The settings are Read-Write or Read-Only.

**Hard Disk Access Control**

This option specifies the read-write access that is set when booting from a hard disk drive. The settings are Read-Write or Read-Only.

**S.M.A.R.T. for Hard Disks**

Set this option to Enabled to permit AMIBIOS to use the SMART (System

Management and Reporting Technologies) protocol for reporting server system information over a network. Enabling this feature allows you to back up your data when your hard disk is about to fail. The settings are Enabled or Disabled.

### **Boot Up Num-Lock**

Set this option to Off to turn the Num Lock key off when the computer is booted so you can use the arrow keys on both the numeric keypad and the keyboard. The settings are On or Off.

### **PS/2 Mouse Support**

Set this option to Enabled to enable AMIBIOS support for a PS/2-type mouse. The BIOS will allocate IRQ12 for the PS/2 mouse. The settings are Enabled or Disabled.

### **Primary Display**

This option configures the type of monitor attached to the computer. The settings are Absent, VGA/EGA, CGA40x25, CGA80x25, or Mono.

### **Password Check**

This option enables password checking every time the system boots or when you run AMIBIOS Setup. If Always is chosen, a user password prompt appears every time the computer is turned on. If Setup is chosen, the password prompt appears if AMIBIOS is executed.

### **Boot To OS/2**

Set this option to Yes if you are running an OS/2 operating system and using more than 64 MB of system memory on the motherboard. The settings are Yes or No.

### **Internal Cache**

This option sets the type of caching algorithm used by the L1 internal cache memory on the CPU. The settings are Disabled, WriteThru, or WriteBack.

### **System BIOS Cacheable**

When set to Enabled, the contents of the F0000h system memory segment can be read from or written to cache memory. The contents of this memory segment are copied from the BIOS ROM to system RAM for faster execution. The settings are Enabled or Disabled. The Optimal default setting is Enabled.

**Cache Bus ECC**

When Enabled, this option permits ECC error checking on the L2 cache bus. This ensures that cached data is not improperly altered. The settings are Enabled or Disabled.

**Default Primary Video**

This option sets the primary video card as either AGP (Accelerated Graphics Port) card or a regular PCI video card. The settings are AGP or PCI.

**MPS Revision**

This option sets the Multi-Processor Symmetry. Then settings are 1.1 or 1.4.

**C000,16K Shadow and C400,16K Shadow**

These options specify how the 32 KB of video ROM at C0000h is treated. The settings are:

Setting	Description
Disabled	The contents of the video ROM are not copied to RAM.
Enabled	The contents of the video ROM area from C000h-C7FFFh are copied (shadowed) from ROM to RAM for faster execution.
Cached	The contents of the video ROM area from C000h-C7FFFh are copied from ROM to RAM and can be written to or read from cache memory.

**C800,16K Shadow; CC00,16K Shadow; D000,16K Shadow; D400,16K Shadow; D800, 16K Shadow; and DC00,16K Shadow**

These options enable shadowing of the contents of the ROM area named in the option. The ROM area not used by ISA adapter cards is allocated to PCI adapter cards. The settings are:

Setting	Description
Disabled	The contents of the video ROM are not copied to RAM.
Enabled	The contents of the designated ROM area are copied (shadowed) from ROM to RAM for faster execution.
Cached	The contents of the designated ROM area are copied from ROM to RAM and can be written to or read from cache memory.

# Chipset Setup

Choose Chipset Setup on the AMIBIOS Setup main menu. All Chipset Setup options are then displayed. AMIBIOS Setup can be customized. AMIBIOS Setup can be customized via AMIBCP. See the AMIBIOS Utilities Guide for additional information.

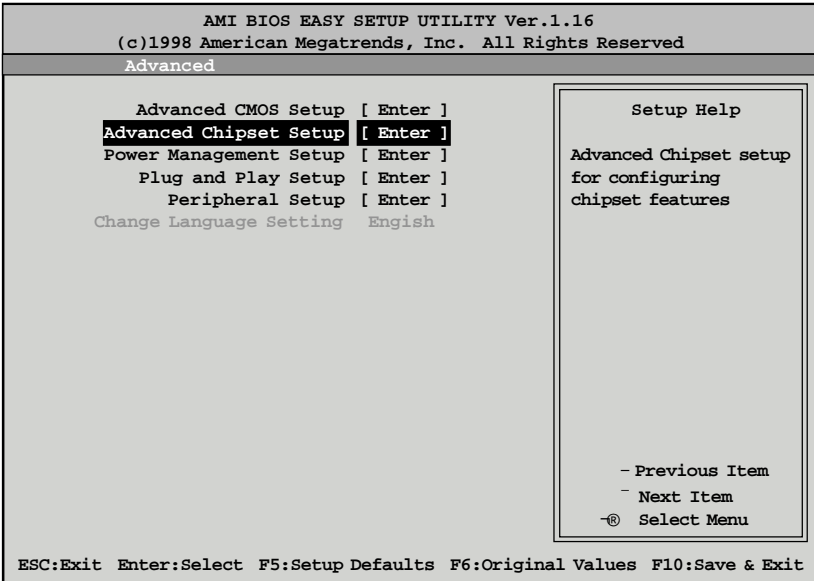

## Advanced Chipset Setup Default Settings Chart

Setting Option	Optimal Default	Fail-Safe Default
USB Function	Disabled	Disabled
* USB KB/Mouse Legacy Support	Disabled	Disabled
* Port 64/60 Emulation	Disabled	Disabled
SERR#	Disabled	Disabled
PERR#	Disabled	Disabled
WSC# Handshake	Enabled	Enabled
USWC Write Post	Enabled	Enabled
Master Latency Timer (Clks)	64	64
Multi-Trans Timer (Clks)	32	32
PCI1 to PCI0 Access	Disabled	Disabled
Method of Memory Detection	Auto & SPD	Auto & SPD
DRAM Integrity Mode	N/A	N/A

**Settings Chart (continued)**

Setting Option	Optimal Default	Fail-Safe Default
DRAM Refresh Rate	15.6 us	15.6 us
Memory Hole	Disabled	Disabled
SDRAM RAS# to CAS# Delay	3S CLKs	3S CLKs
SDRAM RAS# Precharge	3S CLKs	3S CLKs
Power Down SDRAM	Disabled	Disabled
ACPI Control Register	Disabled	Disabled
Gated Clock	Disabled	Disabled
Graphics Aperture Size	64 MB	64 MB
Search for MDA Resources	Yes	Yes
AGP Multi-Transaction Timer (AGP Clks)	32	Disabled
AGP Low-Priority Timer (Clks)	16	Disabled
AGP SERR	Disabled	Disabled
AGP Parity Error Response	Disabled	Disabled
8bit I/O Recovery Time	Disabled	Disabled
16bit I/O Recovery Time	Disabled	Disabled
PIIX4 SERR#	Disabled	Disabled
USB Passive Release	Enabled	Enabled
PIIX4 Passive Release	Enabled	Enabled
PIIX4 Delayed Transaction	Disabled	Disabled
Type F DMA Buffer Control1	Disabled	Disabled
Type F DMA Buffer Control2	Disabled	Disabled
DMA-0 Type	Normal ISA	Normal ISA
DMA-1 Type	Normal ISA	Normal ISA
DMA-2 Type	Normal ISA	Normal ISA
DMA-3 Type	Normal ISA	Normal ISA
DMA-4 Type	Normal ISA	Normal ISA
DMA-5 Type	Normal ISA	Normal ISA
DMA-6 Type	Normal ISA	Normal ISA

\* Setting option not selectable.

**USB Function**

Set this option to Enabled to enable USB (Universal Serial Bus) support. The settings are Enabled or Disabled.

### USB KB/Mouse Legacy Support

Set this option to Enabled to enable support for older keyboards and mouse devices if the USB Function option is set to Enabled. The settings are Enabled or Disabled.

### Port 64/60 Emulation

Setting this option to Enabled allows a USB keyboard to act like a legacy keyboard. If this option is not Enabled, USB keyboard lights will not work under Windows NT. With other operating systems, a USB keyboard will work normally with this option Disabled. The settings are Enabled or Disabled.

### SERR#

Set this option to Enabled to enable the SERR# signal on the bus. The settings are Enabled or Disabled.

### PERR#

Set this option to Enabled to enable the PERR# signal on the bus. The settings are Enabled or Disabled. The Optimal and Fail-safe default settings are Disabled.

### WSC# Handshake

Set this option to Enabled to enable handshaking for the WSC# signal. Handshaking is a form of encryption; see the Glossary for more information. The settings are Enabled or Disabled.

### USWC Write Post

This option sets the status of USWC posted writes to I/O. USWC is a type of memory that is used by VGA devices. The settings are:

Setting	Description
Enabled	USWC posted writes to I/O are enabled.
Disabled	USWC posted writes to I/O are disabled.

### BX Master Latency Timer (Clks)

This option specifies the master latency timer (in PCI clocks) for devices in the computer. The settings are Disabled, 32, 64, 96, 128, 160, 192, or 224.

### Multi-Trans Timer (Clks)

This option specifies the multi-trans latency timings (in PCI clocks) for devices in the computer. The settings are Disabled, 32, 64, 96, 128, 160, 192, or 224.

**PCI1 to PCI0 Access**

Set this option to Enabled to enable access between two different PCI buses (PCI1 and PCI0). The settings are Enabled or Disabled.

**Method of Memory Detection**

This option determines how your system will detect the type of system memory you have installed. Options are Auto+SPD or Auto only.

**DRAM Integrity Mode**

This option sets the type of system memory checking. The settings are:

Setting	Description
Non ECC	No error checking or error reporting is done.
EC	Errors are detected, but no corrections will be made.
ECC Hardware	Errors are detected, and single bit errors are corrected.

**DRAM Refresh Rate**

This option specifies the interval between refresh signals to DRAM system memory. The settings are 15.6 us (microseconds), 31.2 us, 62.4 us, 124.8 us, or 249.6 us.

**Memory Hole**

This option specifies the location of an area of memory that cannot be addressed on the ISA bus. The settings are Disabled, 512KB-640KB, or 15MB-16MB.

**SDRAM RAS# to CAS# Delay**

This option specifies the length of the a inserted between the RAS and CAS signals of the DRAM system memory access cycle if SDRAM is installed. The settings are Auto, 2 SCLKs or 3 SCLKs. The Optimal default setting is Auto.

**SDRAM RAS# Precharge**

(CHANGE) This option specifies the length of the RAS precharge part of the DRAM system memory access cycle when SDRAM system memory is installed in this computer. The settings are Auto, 2 SCLKs, or 3 SCLKs.

**Power Down SDRAM**

If this option is set to Enabled, the SDRAM Power Down feature is enabled. The settings are Enabled or Disabled.



### **ACPI Control Register**

Set this option to Enabled to enable the ACPI (Advanced Configuration and Power Interface) control register. The settings are Enabled or Disabled. The Optimal and Fail-safe default settings are Enabled.

### **Gated Clock**

Set this option to Enabled to enable the gated clock. The settings are Enabled or Disabled.

### **Graphics Aperture Size**

This option specifies the amount of system memory that can be used by the Accelerated Graphics Port (AGP). The settings are 4 MB, 8 MB, 16 MB, 32 MB, 64 MB, 128 MB, or 256 MB.

### **Search for MDA Resources**

Set this option to Yes to let AMIBIOS search for MDA resources. The settings are Yes or No.

### **AGP Multi-Trans Timer (AGP Clks)**

This option sets the AGP multi-trans timer. The settings are in units of AGP Clocks. The settings are Disabled, 32, 64, 96, 128, 160, 192, or 224.

### **AGP Low-Priority Timer (Clks)**

This option sets the AGP low priority timer. The settings are in units of AGP Clocks. The settings are Disabled, 16, 32, 48, 64, 80, 96, 112, 128, 144, 176, 192, 208, 224, or 240.

### **AGPSERR**

Set this option to Enabled to enable the AGP SERR signal. The settings are Enabled or Disabled.

### **AGP Parity Error Response**

Set this option to Enabled to enable AGP parity error response. The settings are Enabled or Disabled.

### **8bit I/O Recovery Time**

This option specifies the length of a delay inserted between consecutive 8-bit I/O operations. The settings are Disabled and from 1 to 8 Sysclk (system clocks) in increments of one.

**16bit I/O Recovery Time**

This option specifies the length of a delay inserted between consecutive 16-bit I/O operations. The settings are Disabled and from 1 to 4 Sysclk (system clocks) in increments of one.

**PIIX4SERR#**

Set this option to Enabled to enable the SERR# signal for the Intel PIIX4 chip. The settings are Enabled or Disabled.

**USB Passive Release**

Set this option to Enabled to enable passive release for USB. The settings are Enabled or Disabled.

**PIIX4 Passive Release**

Set this option to Enabled to enable passive release for the Intel PIIX4e chip. This option must be Enabled to provide PCI 2.1 compliance. The settings are Enabled or Disabled.

**PIIX4DELAYED TRANSACTION**

Set this option to Enabled to enable delayed transactions for the Intel PIIX4 chip. This option must be Enabled to provide PCI 2.1 compliance. The settings are Enabled or Disabled.

**TypeF DMA Buffer Control1 and 2**

These options specify the DMA channel where TypeF buffer control is implemented. The settings are Disabled, Channel-0, Channel-1, Channel-2, Channel-3, Channel-5, Channel-6, or Channel-7.

**DMA-*n* Type**

These options specify the bus that the specified DMA channel can be used on. The settings are Normal ISA, PC/PCI, or Distributed.

**CPU Bus Frequency**

This option provides selective CPU Bus Frequency; however, it is strongly recommended that the default setting (Auto) be selected. Unpredictable situations may arise if the Intel default CPU bus speed is not used. The settings are Auto, 66.8MHz, 68.5MHz, 75MHz, 83.3MHz, 100MHz, 103MHz, or 112MHz.

# Power Management Setup

The AMIBIOS Setup options described in this section are selected by choosing Power Management Setup from the AMIBIOS Setup main menu.

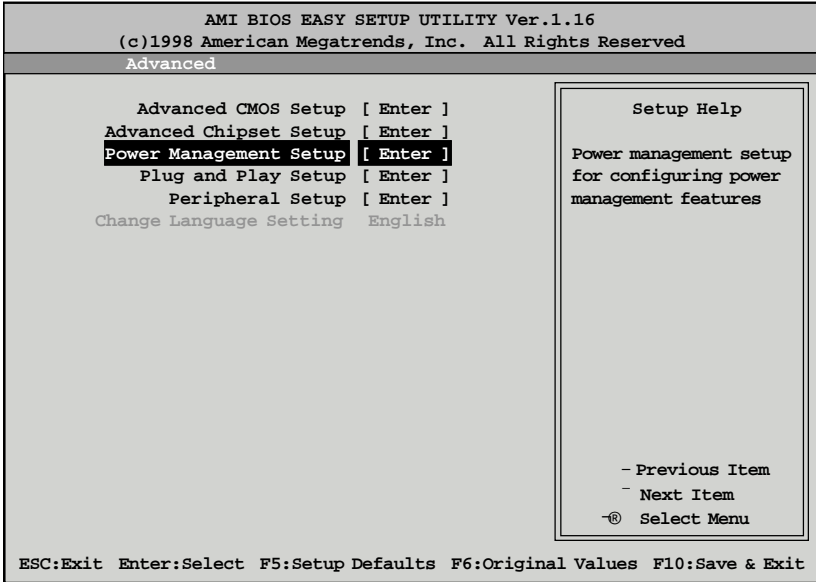

**BIOS**

## Power Management Setup Default Settings Chart

Setting Option	Optimal Default	Fail-Safe Default
ACPI Aware O/S	No	No
Power Management / APM	Enabled	Enabled
Power Button Function	On/Off	On/Off
Green P.C Monitor Power State	Suspend	StandBy
Video Power Down Mode	Suspend	Disabled
Hard Disk Power Down Mode	Suspend	Disabled
Hard Disk Time Out (Minute)	Disabled	Disabled
Power Saving Type	Sleep	Sleep
Standby / Suspend Timer Unit	4 min	4 min
Standby Time Out	Disabled	Disabled
Suspend Time Out	Disabled	Disabled
Slow Clock Ratio	50% - 62.5%	50% - 62.5%
Display Activity	Ignore	Ignore

Setting Option	Optimal Default	Fail-Safe Default
Device 6 (Serial port 1)	Monitor	Monitor
Device 7 (Serial port 2)	Monitor	Monitor
Device 8 (Parallel port)	Monitor	Monitor
Device 5 (Floppy disk)	Monitor	Monitor
Device 0 (Primary master IDE)	Monitor	Monitor
Device 1 (Primary slave IDE)	Monitor	Monitor
Device 2 (Secondary master IDE)	Monitor	Monitor
Device 3 (Secondary slave IDE)	Monitor	Monitor
LAN Wake-up	Disabled	Disabled
PC98 Power LED	Disabled	Disabled
Fan OFF at Suspend	Enabled	Enabled
RTC Wake-up	Disabled	Disabled
*Hour	N/A	N/A
*Minute	N/A	N/A

\* Setting option not selectable.

### ACPI Aware O/S

Set this option to Yes to enable Advanced Configuration and Power Interface (ACPI) BIOS for an ACPI-aware operating system.

### Power Management/APM

Set this option to Enabled to enable the chipset power management and APM (Advanced Power Management) features. The settings are Enabled or Disabled.

### Power Button Function

This option specifies how the power button mounted externally on the computer chassis is used. See Soft Power Connector on page 31 for more information. The settings are shown in the table below.

Setting	Description
On/Off	Pushing the power button turns the computer on or off.
Suspend	Pushing the power button places the computer in Suspend mode or Full On power mode.

### Green PC Monitor Power State

This option specifies the power state that the green PC-compliant video monitor enters when AMIBIOS places it in a power saving state after the

specified period of display inactivity has expired. The settings are Off, Stand By, or Suspend.

### **Video Power Down Mode**

This option specifies the power state that the video subsystem enters when AMIBIOS places it in a power saving state after the specified period of display inactivity has expired. The settings are Stand By, Suspend, or Disabled.

### **Hard Disk Power Down Mode**

This option specifies the power conserving state that the hard disk drive enters after the specified period of hard drive inactivity has expired. The settings are Disabled, Stand By, or Suspend.

### **Hard Disk Time Out (Minute)**

This option specifies the length of a period of hard disk drive inactivity. When this length of time expires, the computer enters power-conserving state specified in the Hard Disk Power Down Mode option (see above). The settings are Disabled, and from 1 to 15 minutes, in one minute intervals.

### **Power Saving Type**

There are several types of sleeping states within the general sleep state. This option allows you to choose how “asleep” you want your system to be. In deeper sleep modes, more energy is saved. However, upon waking up, the system must “reorient” itself, and reestablish control over the system’s sleeping components. The settings are POS, Sleep, Stop Clock, and Deep Sleep. POS is the lightest sleep mode; Deep Sleep is the heaviest.

### **Standby/Suspend Timer Unit**

This option specifies the unit of time used for the Standby and Suspend time out periods. The settings are 4 msec, 4 sec, 32 sec, or 4 min.

### **Standby Time Out**

This option defines the length of time that the system, while in Full On state, must be inactive before it enters Standby mode. The settings are Disabled and from 4 minutes to 508 minutes, in increments of 4 minutes.

### **Suspend Time Out**

This option defines the length of time that the system, while in Standby mode, must be inactive before it enters Suspend mode. The settings are Disabled and from 4 minutes to 508 minutes, in increments of 4 minutes.

### **Slow Clock Ratio**

This option specifies the speed at which the system clock runs in the Standby Mode power saving state. The settings are expressed as a percentage of the normal CPU clock speed. The settings are 0-12.5%, 12.5%-25%, 25%-37.5%, 37.5%-50%, 50%-62.5%, 62.5%-75%, or 75-87.5%.

### **Display Activity**

When set to Monitor, this option enables event monitoring on the video display. If set to Monitor and the computer is in a power saving state, display activity will cause the system to enter the Full On state. AMIBIOS reloads the Standby and Suspend time-out timers if display activity occurs. The settings are Monitor or Ignore.

### **Device *n* (Device identity)**

When set to Monitor, these options enable event monitoring on the specified hardware interrupt request line. If set to Monitor and the computer is in a power saving state, any activity on the IRQ line will cause the system to enter the Full On state. AMIBIOS reloads the Standby and Suspend time-out timers if activity occurs on the specified IRQ line. The settings for each of these options are Monitor or Ignore.

### **LAN Wake-up**

When this option is Enabled, the system will wake up when a signal is received on the Wake-on LAN header. In order for this wake up function to work, the system must have been brought up at least past the POST before it was last shut down (i.e. if you turn the system off before the POST, the registry will not be set, and the system will not be able to wake up using this function). This function requires an ATX 2.01 compliant power supply with 5V standby (STB5V) current of at least 800mA. The settings are Enabled or Disabled.

### **PC98 Power LED**

When this option is Enabled, your power LED will turn to yellow when your system is in Suspend mode. Note that if you do not have a two-color LED, your LED will turn off when the system is in Suspend mode if this option is set to Enabled. The settings are Enabled or Disabled.

### **FAN OFF at Suspend**

If this option is Enabled, the CPU fan will turn off when the system is in Suspend mode. If Disabled, the CPU fan will remain on while the system is in Suspend mode. The settings are Enabled or Disabled.

## RTC Wake-up

If Enabled, this option allows you to set an hour and minute for the system to wake up. The next two fields allow you to choose the wake up time. Note that the time fields will not be available if this option is set to Disabled. In order for this wake up function to work, the system must have been brought up at least past the POST before it was last shut down (i.e. if you turn the system off before the POST, the registry will not be set, and the system will not be able to wake up using this function). The settings are Enabled or Disabled.

## Plug and Play Setup

Choose PCI/Plug and Play Setup from the AMIBIOS Setup screen to display the PCI and Plug and Play Setup options, described below.

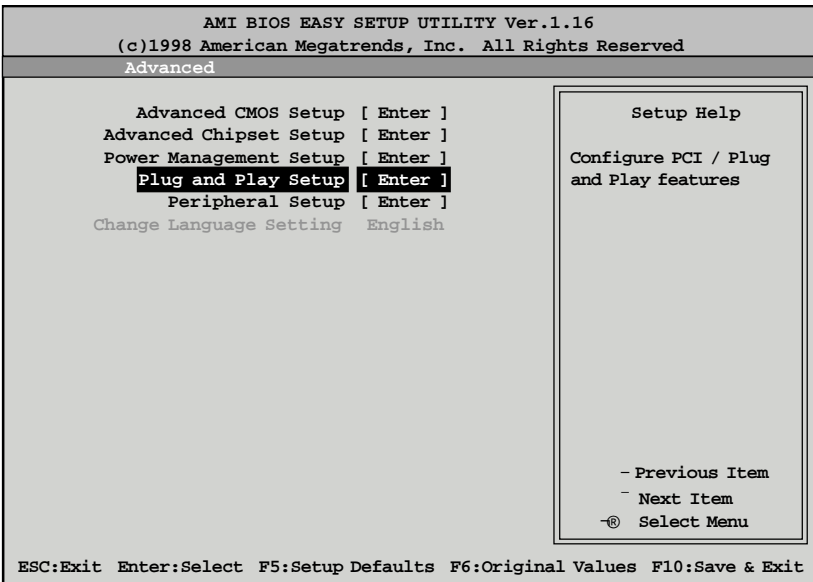

## Plug and Play Setup Default Settings Chart

Setting Option	Optimal Default	Fail-Safe Default
Plug and Play Aware O/S	Yes	Yes
PCI Latency Timer (PCI Clocks)	64	64
PCI VGA Palette Snoop	Disabled	Disabled
Allocate IRQ to PCI VGA	Yes	Yes
PCI IDE Bus Master	Disabled	Disabled
Offboard PCI IDE Card	Auto	Auto
*Offboard PCI IDE Primary IRQ	Disabled	Disabled
*Offboard PCI IDE Secondary IRQ	Disabled	Disabled
PCI Slot1 IRQ Priority	Auto	Auto
PCI Slot2 IRQ Priority	Auto	Auto
PCI Slot3 IRQ Priority	Auto	Auto
PCI Slot4 IRQ Priority	Auto	Auto
DMA Channel 0	PnP	PnP
DMA Channel 1	PnP	PnP
DMA Channel 3	PnP	PnP
DMA Channel 5	PnP	PnP
DMA Channel 6	PnP	PnP
DMA Channel 7	PnP	PnP
IRQ3	PCI/PnP	PCI/PnP
IRQ4	PCI/PnP	PCI/PnP
IRQ5	PCI/PnP	PCI/PnP
IRQ7	PCI/PnP	PCI/PnP
IRQ9	PCI/PnP	PCI/PnP
IRQ10	PCI/PnP	PCI/PnP
IRQ11	PCI/PnP	PCI/PnP
IRQ12	PCI/PnP	PCI/PnP
IRQ14	PCI/PnP	PCI/PnP
IRQ15	PCI/PnP	PCI/PnP

\* Setting option is not selectable



### Plug and Play Aware O/S

Set this option to Yes to inform AMIBIOS that the operating system can handle plug and Play (PnP) devices. The settings are No or Yes.

### PCI Latency Timer (PCI Clocks)

This option specifies the latency timings (in PCI clocks) for PCI devices installed in the PCI expansion slots. The settings are 32, 64, 96, 128, 160, 192, 224, or 248.

### PCI VGA Palette Snoop

When this option is set to Enabled, multiple VGA devices operating on different buses can handle data from the CPU on each set of palette registers on every video device. Bit 5 of the command register in the PCI device configuration space is the VGA Palette Snoop bit (0 is disabled). For example, if there are two VGA devices in the computer (one PCI and one ISA) and this field is set for:

Setting	Description
Disabled	Data read and written by the CPU is only directed to the PCI VGA device's palette registers.
Enabled	Data read and written by the CPU is directed to the both the PCI VGA device's palette registers and the ISA VGA device palette registers, permitting the palette registers of both devices to be identical.

This option must be set to Enabled if any ISA adapter card installed in the system requires VGA palette snooping.

### Allocate IRQ to PCI VGA

Set this option to Yes to allocate an IRQ to the VGA device on the PCI bus. The settings are Yes or No.

### PCI IDE BusMaster

Set this option to Enabled to specify that the IDE controller on the PCI bus has bus mastering capability. The settings are Disabled or Enabled.

### OffBoard PCI IDE Card

This option specifies whether or not an offboard PCI IDE controller adapter card is used in the computer, and where it is installed. If an offboard PCI IDE controller is used, the motherboard onboard IDE controller is automatically disabled. The settings are Auto and Slot1 through Slot6. If Auto is selected, AMIBIOS automatically determines the correct setting (including using the onboard controller if no offboard controller card is detected). This option forces IRQ 14 and 15 to a PCI slot on the PCI local bus. This is necessary to

support non-compliant PCI IDE adapter cards.

### **OffBoard PCI IDE Primary IRQ**

This option specifies the PCI interrupt used by the primary IDE channel on the offboard PCI IDE controller. The settings are Disabled, Hardwired, INTA, INTB, INTC, or INTD.

### **Offboard PCI IDE Secondary IRQ**

This option specifies the PCI interrupt used by the secondary IDE channel on the offboard PCI IDE controller. The settings are Disabled, Hardwired, INTA, INTB, INTC, or INTD.

### **PCI Slot *n* IRQ Priority**

These options specify the IRQ priority for PCI devices installed in the PCI devices installed in the PCI expansion slots. The settings are Auto, IRQ 3, 4, 5, 7, 9, 10, and 11, in priority order.

### **DMA Channel *n***

These options allow you to specify the bus type used by each DMA channel. The settings are PnP or ISA/EISA .

### **IRQ<sub>*n*</sub>**

These options specify the bus that the specified IRQ line is used on. These options allow you to reserve IRQs for legacy ISA adapter cards. These options determine if AMIBIOS should remove an IRQ from the pool of available IRQs passed to devices that are configurable by the system BIOS. The available IRQ pool is determined by reading the ESCD NVRAM. If more IRQs must be removed from the pool, you can use these options to reserve the IRQ by assigning an ISA/EISA setting to it. Onboard I/O is configured by AMIBIOS. All IRQs used by onboard I/O are configured as PCI/PnP. IRQ12 only appears if the Mouse Support option in Advanced Setup is set to Disabled. IRQ14 and 15 will not be available if the onboard PCI IDE is enabled. If all IRQs are set to ISA/EISA and IRQ14 and 15 are allocated to the onboard PCI IDE, IRQ9 will still be available for PCI and PnP devices, because at least one IRQ must be available for PCI and PnP devices. The settings are ISA/EISA or PCI/PnP.

### **Reserved Memory Size**

This option specifies the size of the memory area reserved for legacy ISA adapter cards. The settings are Disabled, 16K, 32K, or 64K.

**Reserved Memory Address**

This option specifies the beginning address (in hex) of the reserved memory area. The specified ROM memory area is reserved for use by legacy ISA adapter cards. This option does not appear if the Reserved Memory Size option is set to Disabled. The settings are C0000, C4000, C8000, CC000, D0000, D4000, D8000, or DC000.

**PCI Device Search Order**

This option changes the BIOS scan order of the PCI slot - from first to last or last to first. The settings are First-Last or Last-First.

**BIOS Devnode for Shadow RAM**

This option is used for some add-on card ROMs which do not claim the correct memory range that they occupy. The settings are Disabled or Enabled.

# Peripheral Setup

Peripheral Setup options are displayed by choosing Peripheral Setup from the AMIBIOS Setup main menu. All Peripheral Setup options are described here.

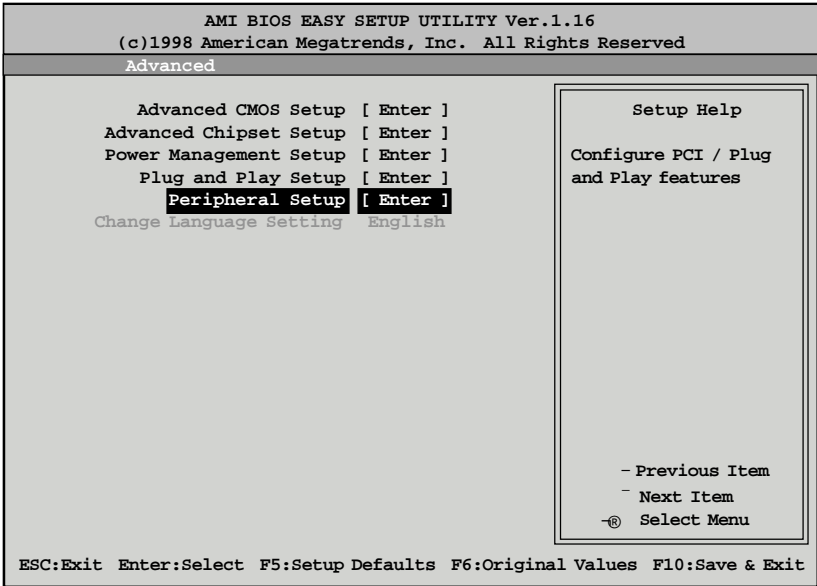

## Peripheral Setup Default Settings Chart

Setting Option	Optimal Default	Fail-Safe Default
Power Interruption	Dis abled	Dis abled
Overclock Warning Mes sage	Enabled	E nabled
LM79 IN0	4.08	4.08
LM79 IN1	4.08	4.08
LM79 IN2	4.08	4.08
LM79 IN3	6.85	6.85
LM79 IN4	15.50	15.50
LM79 IN5	-14.28	-14.28
LM79 IN6	-6.20	-6.20
Onboard F DC	Auto	Auto
Onboard Serial P ort 1	3F 8h	3F 8h
Onboard Serial P ort 2	2F 8h	2F 8h
Serial P ort 2 Mode	Normal	Normal
*1R Duplex Mode	N/A	N/A

## Default Settings Chart (Continued)

Setting Option	Optimal Default	Fail-Safe Default
*IR Receiver Pin	IRRX1	IRRX1
Onboard Parallel Port	378	378
Parallel Port Mode	Normal	Normal
*EPP Version	N/A	N/A
Parallel Port IRQ	7	7
*Parallel Port DMA Channel	N/A	N/A
Onboard IDE	Both	Both

\* Setting Option is not Selectable

### Overclock Warning Message

When enabled, this option sends a warning message if the CPU is overclocked. The settings are Enabled or Disabled.

### LM79IN(X)

This option specifies various CPU core voltage settings.

### Power Interruption

The settings are Enabled or Disabled.

### Onboard FDC

Set this option to Enabled to enable the floppy drive controller on the motherboard. The settings are Auto, Enabled, or Disabled.

### Onboard Serial Port1

This option specifies the base I/O port address of serial port 1. The settings are Auto, Disabled, 3F8h, 2F8h, 3E8h, or 2E8h.

### Onboard Serial Port2

This option specifies the base I/O port address of serial port 2. The settings are Auto, Disabled, 3F8h, 2F8h, 3E8h, or 2E8h.

### Serial Port2 Mode

This option specifies the operating mode for serial port 2. This option will not appear if the Onboard Serial Port2 option is set to Disabled, or is set to Auto and your system does not have an onboard serial port 2. The settings are Normal, Sharp-IR, IrDA, and Consumer.

**IR Transmission Mode**

This option specifies the infrared transmission method. This option will not appear if the Serial Port2 Mode option is set to Normal. The settings are Full or Half.

Mode	Description
<b>Full Duplex</b>	Data is transmitted in two directions at once. Any data you send will not appear on your screen until it has been received by the other device and sent back to you. Full duplex is the faster of the two modes.
<b>Half Duplex</b>	Data is transmitted in only one direction at a time. Any data you send will be instantly displayed on your screen. Half duplex mode is easier for the devices to execute. Not all IR-capable devices can handle full duplex mode.

**IR Receiver Pin**

This option specifies which pin will act as the receiver for IR data transmission. This option will not appear if the Serial Port2 Mode option is set to Normal. The only setting is IRRX1.

**OnBoard Parallel Port**

This option specifies the base I/O port address of the parallel port on the motherboard. The settings are Auto, Disabled, 378, or 278.

**Parallel Port Mode**

This option specifies the parallel port mode. The settings are:

Setting	Description
Normal	The normal parallel port mode is used.
Bi-Dir	Use this setting to support bidirectional transfers on the parallel port.
EPP	The parallel port can be used with devices that adhere to the Enhanced Parallel Port (EPP) specifications. EPP uses the existing parallel port signals to provide asymmetric bidirectional data transfer driven by the host device.
ECP	The parallel port can be used with devices that adhere to the Extended Capabilities Port (ECP) specifications. ECP uses the DMA protocol to achieve data transfer rates of up to 2.5 Megabits per second. ECP provides symmetric bidirectional communication.

**EPP Version**

This option specifies the Enhanced Parallel Port specification version number that is used in the system. This option only appears if the Parallel Port Mode option is set to EPP. The settings are 1.7 or 1.9. Version 1.9 is common on

newer devices; consult your device's user information for the appropriate port type. There are no default settings.

**Parallel Port IRQ**

This option specifies the IRQ used by the parallel port, and only appears if OnBoard Parallel Port is set to 278 or 378. The settings are 5 or 7.

**Parallel Port DMA Channel**

This option is only available if the setting for the Parallel Port Mode option is set to ECP and the OnBoard Parallel Port option is set to 378, 278, or 3BC. This option sets the DMA channel used by the parallel port. The settings are 0 through 7 in increments of one.

**Onboard IDE**

This option specifies the IDE channel used by the onboard IDE controller. The settings are Disabled, Primary, Secondary, or Both.

## Supervisor and User Security

You can limit access to the Setup Program or to the system using the Supervisor and User password options (the Supervisor password gives you access to the Setup Program and the system; the User password, only to the system). Note that you must create a supervisor password before you create a user password.

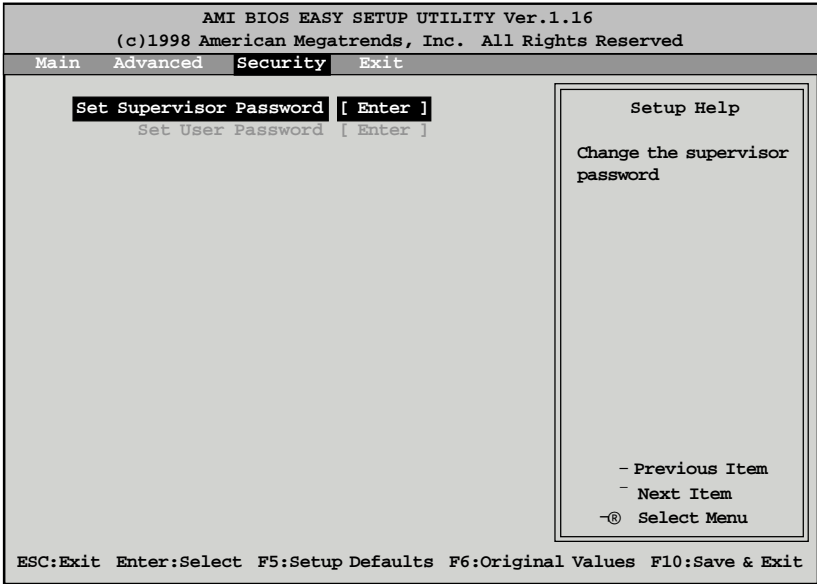

When you select the Supervisor Security option, a dialog box will appear, allowing you to enter a password. You may either type the password in, or click on the onscreen buttons. Your password must be between one and six characters long.



Once you have entered your new password, you will be asked to confirm it. If the two passwords do not match, you will be prompted to enter a new password, and then to confirm it. This will continue until you enter the same series of characters both times. Once this is accomplished, a dialog box will appear and notify you that the Supervisor Password has been installed. You may then select the User Security option and enter a password for the user.

You can enter a new User password at any time simply by selecting the User Security option, and typing in a new password. To enter a new Supervisor password, select the Supervisor Security option. You will be asked to enter the current password. After you do so, you will be prompted to enter the new password.

In either the Supervisor or User Security options, pressing <Enter> once when asked for a new password, and a second time when asked to confirm the new password, will uninstall the existing password. Note that uninstalling the Supervisor password uninstalls the User password as well.

## Language Utility

Currently, the BIOS Setup program is available only in English.

## Flash Writer Utility

The AMI Flash Writer Utility is now included in the AMIBIOS, and so it is simpler to upgrade the BIOS of your mainboard. The system BIOS is stored on a flash EEPROM ROM chip on the mainboard which can be erased and reprogrammed by following the directions on the following page.

1. From the DOS prompt, rename the BIOS file that you have downloaded to "amiboot.rom" and copy it on to a floppy disk.
2. Insert the floppy disk with the BIOS upgrade into the A: drive.
3. Turn the power off.
4. While holding the <Ctrl> and <Home> keys, turn the power on. The system will begin to read from the A: drive, and write the BIOS information contained on the floppy disk in that drive to the EEPROM ROM chip. When the BIOS has been totally reprogrammed, the system will reboot with the new BIOS in operation.
5. If the system does not reboot in three minutes, power down the system wait a few seconds, and then turn the power back on again. You will be prompted to press <F1> to run Setup. You may check your settings at this time, or simply save and exit the program.

# chapter 5

## System Resources

---

### Beep Codes

Fatal errors, which halt the boot process, are communicated through a series of audible beeps. If AMIBIOS POST can initialize the system video display, it displays the error message. Displayed error messages, in most cases, allow the system to continue to boot. Displayed error messages are described on pages 75-76. See the top of the next page for the beep code chart.

Beeps	Error Message	Description
1	Refresh Failure	The memory refresh circuitry is faulty.
2	Parity Error	Parity error in the base memory (the first 64 KB block) of memory.
3	Base 64 KB Memory Failure	Memory failure in first 64 KB.
4	Timer Not Operational	A memory failure in the first 64 KB of memory, or Timer 1 is not functioning.
5	Processor Error	The CPU generated an error.
6	8042 - Gate A20 Failure	Cannot switch to protected mode.
7	Processor Exception Interrupt Error	The CPU on the CPU Card generated an exception interrupt.
8	Display Memory Read/Write Error	The system video adapter is either missing or its memory is faulty. This is not a fatal error.
9	ROM Checksum Error	The ROM checksum value does not match the value encoded in AMIBIOS.
10	CMOS Shutdown Register Read/Write Error	The shutdown register for CMOS RAM has failed.
11	Cache Memory Bad — Do Not Enable Cache	The cache memory test failed. Cache memory is disabled. Do not press <Ctrl> <Alt> <Shift> <+> to enable cache memory.

## Troubleshooting System Problems

### If the computer beeps... then...

1, 2, or 3 times...

reseat the memory SIMMs or DIPs.  
If the system still beeps, replace the memory.

6 times...

reseat the keyboard controller chip. If it still beeps, replace the keyboard controller. If it still beeps, try a different keyboard, or replace the keyboard fuse, if there is one.

8 times...

there is a memory error on the video adapter. Replace the video adapter, or the RAM on the video adapter.

9 times...

the BIOS ROM chip is bad. The system probably needs a new BIOS ROM chip.

11 times...

reseat the cache memory on the motherboard. If it still beeps, replace the cache memory.

4, 5, 7, or 10 times...

for 5 or 7 beeps, first test with a new CPU - if that does not solve the problem, then motherboard must be replaced.

**Bootblock Recovery Codes**

The bootblock recovery checkpoint codes are listed in order of execution.

Checkpoint Code	Description
E0h	The onboard floppy controller if available is initialized. Next, beginning the base 512 KB memory test.
E1h	Initializing the interrupt vector table next.
E2h	Initializing the DMA and Interrupt controllers next.
E6h	Enabling the floppy drive controller and Timer IRQs. Enabling internal cache memory.
EDh	Initializing the floppy drive.
EEh	Looking for a floppy diskette in drive A: Reading the first sector of the diskette.
EFh	A read error occurred while reading the floppy drive in drive A:.
F0h	Next, searching for the AMIBOOT.ROM file in the root directory.
F1h	The AMIBOOT.ROM file is not in the root directory.
F2h	Next, reading and analyzing the floppy diskette FAT to find the clusters occupied by the AMIBOOT.ROM file.
F3h	Next, reading the AMIBOOT.ROM file, cluster by cluster.
F4h	The AMIBOOT.ROM file is not the correct size.
F5h	Next, disabling internal cache memory.
FBh	Next, detecting the type of flash ROM.
FCh	Next, erasing the flash ROM.
FDh	Next, programming the flash ROM.
FFh	Flash ROM programming was successful. Next, restarting the system BIOS.

**Uncompressed Initialization Codes**

The following routine checkpoint codes are listed in order of execution. These codes are uncompressed in F000h shadow RAM. The table begins on the next page.

Checkpoint Code	Description
03h	The NMI is disabled. Next, checking for a soft reset or a power on condition.
05h	The BIOS stack has been built. Next, disabling cache memory.
06h	Uncompressing the POST code next.
07h	Next, initializing the CPU and the CPU data area.
08h	The CMOS checksum calculation is done next.
08h	Next, performing any required initialization before the keyboard BAT command is issued.
0Ch	The keyboard controller input buffer is five. Next, issuing the BAT command to the keyboard controller.
0Eh	The keyboard controller BAT command result has been verified. Next, performing any necessary initialization after the keyboard controller BAT command test.
0Fh	The initialization after the keyboard controller BAT command test is done. The keyboard command byte is written next.
10h	The keyboard controller command byte is written. Next, issuing the Pin 23 and 24 blocking and unblocking commands.
11h	Next, checking if the <End or <Ins> keys were pressed during power on. Initializing CMOS RAM if the Initialize CMOS RAM in every boot AMIBIOS POST option was set in AMIBCP or the <End> key was pressed.
12h	Next, disabling DMA controllers 1 and 2 and interrupt controllers 1 and 2.
13h	The video display has been disabled. Port B has been initialized. Next, initializing the chipset.
14h	The 8254 timer test will begin next.
19h	The 8254 timer test is over. Starting the memory refresh test next.
1Ah	The memory refresh line is toggling. Checking the 15 second on/off time next.
23h	Reading the 8042 input port and disabling the MEGAKEY Green PC feature next. Making the BIOS code segment writable and performing any necessary configuration before initializing the interrupt vectors.
24h	The configuration required before interrupt vector initialization has completed. Interrupt vector initialization is about to begin.
25h	Interrupt vector initialization is done. Clearing the password if the POST DIAG switch is on.
27h	Any initialization before setting video mode will be done next.
28h	Initialization before setting the video mode is complete. Configuring the monochrome mode and color mode settings next.
2Ah	Bus initialization system, static, output devices will be done next, if present. See page 71 for additional information.
2Bh	Passing control to the video ROM to perform any required configuration before the video ROM test.

Checkpoint Code	Description
2Ch	All necessary processing before passing control to the video ROM is done. Looking for the video ROM next and passing control to it.
2Dh	The video ROM has returned control to BIOS POST. Performing any required processing after the video ROM had control.
2Eh	Completed post-video ROM test processing. If the EGA/VGA controller is not found, performing the display memory read/write test next.
2Fh	The EGA/VGA controller was not found. The display memory read/write test is about to begin.
30h	The display memory read/write test passed. Look for retrace checking next.
31h	The display memory read/write test or retrace checking failed. Performing the alternate display memory read/write test next.
32h	The alternate display memory read/write test passed. Looking for alternate display retrace checking next.
34h	Video display checking is over. Setting the display mode next.
37h	The display mode is set. Displaying the power on message next.
38h	Initializing the bus input, IPL, and general devices next, if present. See page 71 for additional information.
39h	Displaying bus initialization error messages. See page 71 for additional information.
3Ah	The new cursor position has been read and saved. Displaying the Hit <DEL> message next.
40h	Preparing the descriptor tables next.
42h	The descriptor tables are prepared. Entering protected mode for the memory test next.
43h	Entered protected mode. Enabling interrupts for diagnostics mode next.
44h	Interrupts enabled if the diagnostics switch is on. Initializing data to check memory wraparound at 0:0 next.
45h	Data initialized. Checking for memory wraparound at 0:0 and finding the total system memory size next.
46h	The memory wraparound test has completed. The memory size calculation has been completed. Writing patterns to test memory next.
47h	The memory pattern has been written to extended memory. Writing patterns to the base 640 KB memory next.
48h	Patterns written in base memory. Determining the amount of memory below 1 MB next.
49h	The amount of memory below 1 MB has been found and verified. Determining the amount of memory above 1 MB memory next.
4Bh	The amount of memory above 1 MB has been found and verified. Checking for a soft reset and clearing the memory below 1 MB for the soft reset next. If this is a power on situation, going to checkpoint 4Eh next.

Checkpoint Code	Description
4Ch	The memory below 1 MB has been cleared via a soft reset. Clearing the memory above 1 MB next.
4Dh	The memory above 1 MB has been cleared via a soft reset. Saving the memory size next. Going to checkpoint 52h next.
4Eh	The memory test started, but not as the result of a soft reset. Displaying the first 64 KB memory size next.
4Fh	The memory size display has started. The display is updated during the memory test. Performing the sequential and random memory test next.
50h	The memory below 1 MB has been tested and initialized. Adjusting the displayed memory size for relocation and shadowing next.
51h	The memory size display was adjusted for relocation and shadowing. Testing the memory above 1 MB next.
52h	The memory above 1 MB has been tested and initialized. Saving the memory size information next.
53h	The memory size information and the CPU registers are saved. Entering real mode next.
54h	Shutdown was successful. The CPU is in real mode. Disabling the Gate A20 line, parity, and the NMI next.
57h	The A20 address line, parity, and the NMI are disabled. Adjusting the memory size depending on relocation and shadowing next.
58h	The memory size was adjusted for relocation and shadowing. Clearing the Hit <DEL> message next.
59h	The Hit <DEL> message is cleared. The <WAIT...> message is displayed. Starting the DMA and interrupt controller test next.
60h	The DMA page register test passed. Performing the DMA Controller 1 base register test next.
62h	The DMA controller 1 base register test passed. Performing the DMA controller 2 base register test next.
65h	The DMA controller 2 base register test passed. Programming DMA controllers 1 and 2 next.
66h	Completed programming DMA controllers 1 and 2. Initializing the 8259 interrupt controller next.
7Fh	Extended NMI source enabling is in progress.
80h	The keyboard test has started. Clearing the output buffer and checking for stuck keys. Issuing the keyboard reset command next.
81h	A keyboard reset error or stuck key was found. Issuing the keyboard controller interface test command next.
82h	The keyboard controller interface test completed. Writing the command byte and initializing the circular buffer next.
83h	The command byte was written and global data initialization has completed. Checking for a locked key next.

Checkpoint Code	Description
84h	Locked key checking is over. Checking for a memory size mismatch with CMOS RAM data next.
85h	The memory size check is done. Displaying a soft error and checking for a password or bypassing WINBIOS Setup next.
86h	The password was checked. Performing any required programming before WINBIOS Setup next.
87h	The programming before WINBIOS Setup has completed. Uncompressing the WINBIOS Setup code and executing the AMIBIOS Setup or WINBIOS Setup utility next.
88h	Returned from WINBIOS Setup and cleared the screen. Performing any necessary programming after WINBIOS Setup next.
89h	The programming after WINBIOS Setup has completed. Displaying the power on screen message next.
8Bh	The first screen message has been displayed. The <WAIT...> message is displayed. Performing the PS/2 mouse check and extended BIOS data area allocation check next.
8Ch	Programming the WINBIOS Setup options next.
8Dh	The WINBIOS Setup options are programmed. Resetting the hard disk controller next.
8Fh	The hard disk controller has been reset. Configuring the floppy drive controller next.
91h	The floppy drive controller has been configured. Configuring the hard disk drive controller next.
95h	Initializing the bus option ROMs from C800 next. See page 71 for additional information.
96h	Initializing before passing control to the adaptor ROM at C800.
97h	Initialization before the C800 adaptor ROM gains control has completed. The adaptor ROM check is next.
98h	The adaptor ROM had control and has now returned control to BIOS POST. Performing any required processing after the option ROM returned control.
99h	Any initialization required after the option ROM test has completed. Configuring the timer data area and printer base address next.
9Ah	Set the timer and printer base addresses. Setting the RS-232 base address next.
9Bh	Returned after setting the RS-232 base address. Performing any required initialization before the Coprocessor test next.
9Ch	Required initialization before the Coprocessor test is over. Initializing the Coprocessor next.
9Dh	Coprocessor initialized. Performing any required initialization after the Coprocessor test next.
9Eh	Initialization after the Coprocessor test is complete. Checking the extended keyboard, keyboard ID, and Num Lock key next. Issuing the keyboard ID command next.



Checkpoint Code	Description
A2h	Displaying any soft errors next.
A3h	The soft error display has completed. Setting the keyboard typematic rate next.
A4h	The keyboard typematic rate is set. Programming the memory wait states next.
A5h	Memory wait state programming is over. Clearing the screen and enabling parity and the NMI next.
A7h	NMI and parity enabled. Performing any initialization required before passing control to the adaptor ROM at E000 next.
A8h	Initialization before passing control to the adaptor ROM at E000h completed. Passing control to the adaptor ROM at E000h next.
A9h	Returned from adaptor ROM at E000h control. Performing any initialization required after the E000 option ROM had control next.
AAh	Initialization after E000 option ROM control has completed. Displaying the system configuration next.
ABh	Building the multiprocessor table, if necessary.
ACh	Uncompressing the DMI data and initializing DMI POST next.
B0h	The system configuration is displayed.
B1h	Copying any code to specific areas.
00h	Code copying to specific areas is done. Passing control to INT 19h boot loader next.

**The system BIOS passes control to different buses at the following checkpoints:**

Checkpoint Code	Description
2Ah	Initializing the different bus system, static, and output devices, if present.
38h	Initialized bus input, IPL, and general devices, if present.
39h	Displaying bus initialization error messages, if any.
95h	Initializing bus adaptor ROMs from C8000h through D8000h.

### Additional Bus Checkpoints

While control is in the bus routines, additional checkpoints are output to I/O port address 0080h as word to identify the routines being executed. These are word checkpoints. The low byte of checkpoint is the system BIOS checkpoint where control is passed to the different bus routines. The high byte of checkpoint indicates that the routine is being executed in different buses.

The high byte of these checkpoints includes the following information:

Bits	Description
Bits 7-4	
0000	Function 0. Disable all devices on the bus.
0001	Function 1. Initialize static devices on the bus.
0010	Function 2. Initialize output devices on the bus.
0011	Function 3. Initialize input devices on the bus.
0100	Function 4. Initialize IPL devices on the bus.
0101	Function 5. Initiate general devices on the bus.
0110	Function 6. Initialize error reporting on the bus.
0111	Function 7. Initialize add-on ROMs for all buses.
Bits 3-0	Specify the bus
0	Generic DIM Device Initialization Manager.
1	Onboard System devices.
2	ISA devices.
3	EISA devices.
4	ISA PnP devices.
5	PCI devices.

# Displayed Error Messages

If an error occurs after the system display has been initialized, the error message will be displayed as follows:

```

ERROR Message Line 1
ERROR Message Line 2
Press <F1> to continue
    
```

and the system will halt. The system will not halt if the Wait for <F1> If Any Error option in Advanced Setup is Disabled.

RUN SETUP UTILITY

may also appear. Press <F1> to run WINBIOS Setup if this message appears.

Error Message	Explanation
8042 Gate-A20 Error	Gate A20 on the keyboard controller (8042) is not working. Replace the 8042.
Address Line Short!	Error in the address decoding circuitry.
C: Drive Error	No response from drive C:. Run the AMIDdiag Hard Disk Utility. Check the C: hard disk type in Standard Setup.
C: Drive Failure	No response from hard disk drive C:. Replace the drive.
Cache Memory Bad, Do Not Enable Cache!	Cache memory is defective. Run AMIDdiag.
CH-2 Timer Error	An AT system has two timers. There is an error in timer 2.
CMOS Battery State Low	CMOS RAM is powered by a battery. The battery power is low. Replace the battery.
CMOS Checksum Failure	CMOS RAM checksum is different than the previous value. Run WINBIOS Setup.
CMOS System Options Not Set	The values stored in CMOS RAM have been destroyed. Run WINBIOS Setup.
CMOS Display Type Mismatch	The video type in CMOS RAM does not match the type detected. Run WINBIOS Setup.
CMOS Memory Size Mismatch	The amount of memory found by AMIBIOS is different than the amount in CMOS RAM. Run WINBIOS Setup.
CMOS Time and Date Not Set	Run Standard Setup to set the date and time.
D: Drive Error	No response from drive D:. Run the AMIDdiag Hard Disk Utility. Check the hard disk type in Standard Setup.

Error Message	Explanation
D: drive failure	No response from hard disk drive D:. Replace the drive.
Diskette Boot Failure	The boot diskette in drive A: cannot be used to boot the system. Use another boot diskette and follow the screen instructions.
Display Switch Not Proper	Some systems require a video switch be set to either color or monochrome. Turn the system off, set the switch properly, then power on.
DMA Error	Error in the DMA controller.
DMA 1 Error	Error in the first DMA channel.
DMA 2 Error	Error in the second DMA channel.
FDD Controller Failure	AMIBIOS cannot communicate with the floppy disk drive controller. Check all appropriate connections after the system is powered down.
HDD Controller Failure	AMIBIOS cannot communicate with the hard disk drive controller. Check all appropriate connections after the system is powered down.
INTR1 Error	Interrupt channel 1 failed POST.
INTR2 Error	Interrupt channel 2 failed POST.
Invalid Boot Diskette	AMIBIOS can read the diskette in floppy drive A:, but it cannot boot the system with it. Use another boot diskette and follow the screen instructions.
Keyboard Is Locked...Unlock It	The keyboard lock on the system is engaged. The system must be unlocked to continue to boot.
Keyboard Error	The keyboard has a timing problem. Make sure a Keyboard Controller AMIBIOS is installed. Set Keyboard in Advanced Setup to Not Installed to skip the keyboard POST routines.
KB/Interface Error	There is an error in the keyboard connector.
No ROM BASIC	Cannot find a proper bootable sector on either drive A: or C:. AMIBIOS cannot find ROM Basic.
Off Board Parity Error	Parity error in memory installed on an adapter card in an expansion slot. The format is: OFF BOARD PARITY ERROR ADDR = (XXXX) XXXX is the hex address where the error occurred. Run AMIDiag to find and correct memory problems.
On Board Parity Error	Parity error in motherboard memory. The format is: ON BOARD PARITY ERROR ADDR = (XXXX) XXXX is the hex address where the error occurred. Run AMIDiag to find and correct memory problems.
Parity Error ????	Parity error in system memory at an unknown address. Run AMIDiag to find and correct memory problems.

**This page intentionally left blank.**

# Appendix 1

## CPU Retention Module Options

---

Tyan offers two different options for securing Intel's Pentium II CPUs onto the motherboard. Each option provides retention for both older Pentium II's as well as newer Pentium II's (including Celeron).

### **OPTION 1:**

Two different types of retention modules are included in the motherboard package. For older versions of Pentium II, use the retention module shown in Figure 1. For newer versions of Pentium II CPUs (including Celeron), use the retention module shown in Figure 2. (Screws for the retention modules are provided.)

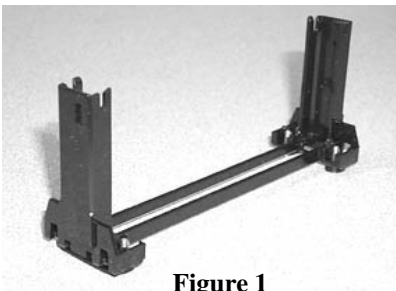

**Figure 1**

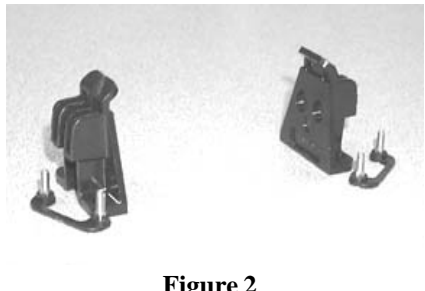

**Figure 2**

**OPTION 2:**

One universal retention module is included in the motherboard package. This type of retention module adapts to both old and new Pentium II CPUs - see Figure 3. (Screws for the retention modules are provided)

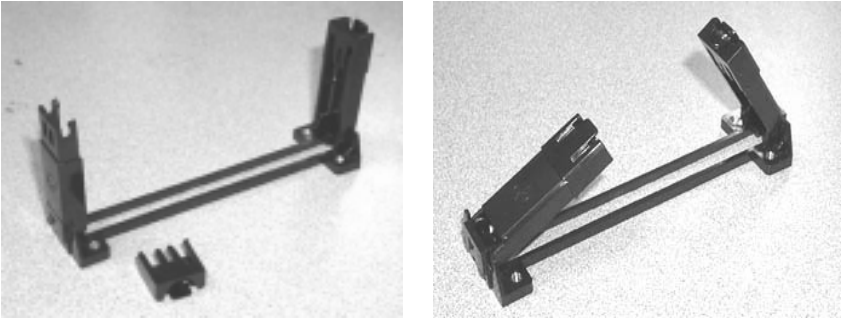

**Figure 3**

# Appendix 2

## Glossary

---

**ACPI** (Advanced Configuration and Power Interface) is a power management specification that allows the operating system to control the amount of power distributed to the computer's devices. Devices not in use can be turned off, reducing unnecessary power expenditure.

**AGP** (Accelerated Graphics Port) is a PCI-based interface which was designed specifically for demands of 3D graphics applications. The 32-bit AGP channel directly links the graphics controller to the main memory. While the channel runs at only 66MHz, it supports data transmission during both the rising and falling ends of the clock cycle, yielding an effective speed of 133MHz.

**AT** was the original form factor of IBM's PC.

**ATAPI** (AT Attachment Packet Interface), also known as IDE or ATA, is a drive implementation that includes the disk controller on the device itself. It allows CD-ROMs and tape drives to be configured as master or slave devices, just like hard drives.

**ATX** form factor was designed to replace the AT form factor. It improves on the AT design by rotating the board ninety degrees, so that the IDE connectors are closer to the drive bays, and the CPU is closer to the power supply



and cooling fan. The keyboard, mouse, serial, USB, and parallel ports are built in.

**Bandwidth** refers to carrying capacity. The greater the bandwidth, the more data the bus, phone line, or other electrical path, can carry. Greater bandwidth, then, also results in greater speed.

A **BBS (Bulletin Board System)** is a computer system with a number of modems hooked up to it which acts as a center for users to post messages and access information.

The **BIOS (Basic Input/Output System)** program resides in the ROM chip, and provides the basic instructions for controlling your computer's hardware. Both the operating system and application software use BIOS routines to ensure compatibility.

A **buffer** is a portion of RAM which is used to temporarily store data, usually from an application, though it is also used when printing, and in most keyboard drivers. The CPU can manipulate data in a buffer before copying it, all at once, to a disk drive. While this improves system performance--reading to or writing from a disk drive a single time is much faster than doing so repeatedly--there is the possibility of losing your data should the system crash. Information stored in a buffer is temporarily stored, not permanently saved.

A **bus** is a data pathway. The term is used especially to refer to the connection between the processor and system memory, and between the processor and PCI or ISA local buses.

**Bus mastering** allows peripheral devices and IDEs to access the system memory without going through the CPU (similar to DMA channels).

A **cache** is a temporary storage area for data that will be needed often by an application. Using a cache lowers data access times, since the needed information is stored in the SRAM instead of in the slower DRAM. Note that the cache is also much smaller than your regular memory: a typical cache size is 512KB, while you may have as much as 1GB of regular memory.

**Cache size** refers to the physical size of the cache onboard. This should not be confused with the cacheable area, which is the total amount of memory

which can be scanned by the system in search of data to put into the cache. A typical setup would be a cache size of 512KB, and a cacheable area of 512MB. In this case, up to 512MB of the main memory onboard is capable of being cached. However, only 512KB of this memory will be in the cache at any given moment. Any main memory above 512MB could never be cached.

**Closed and open jumpers** Jumpers and jumper pins are active when they are On or Closed, and inactive when they are Off or Open.

**CMOS** Complementary Metal-Oxide Semiconductors are chips that hold the basic start-up information for the BIOS.

The **COM port** is another name for the serial port, which is so-called because it transmits the eight bits of a byte of data along one wire, and receives data on another single wire (that is, the data is transmitted in serial form, one bit after another). Parallel ports transmit the bits of a byte on eight different wires at the same time (that is, in parallel form, eight bits at the same time).

**DIMM** Dual In-line Memory Modules are a faster and more capacious form of RAM than SIMMs, and do not need to be installed in pairs.

**DIMM bank** DIMM banks are sometimes called DIMM sockets, because the physical slot and the logical unit are the same. That is, one DIMM module fits into one DIMM socket, which is capable of acting as a memory bank.

**DMA** Direct Memory Access channels are similar to IRQs. DMA channels allow hardware devices (like sound cards or keyboards) to access the main memory without involving the CPU. This frees up CPU resources for other tasks. As with IRQs, it is vital that you do not double up devices on a single line. Plug and Play devices will take care of this for you.

In **Doze mode**, only the CPU's speed is slowed.

**DRAM** Dynamic RAM is a widely available, very affordable form of RAM which has the unfortunate tendency to lose data if it is not recharged regularly (every few milliseconds). This refresh requirement makes DRAM three to ten times slower than non-recharged RAM such as SRAM.

**EDO RAM** (Extended Data-Out RAM) speeds access to memory locations by assuming that memory addresses are static: the next time it looks for a bit of data, it will be at the same spot, or one nearby.

**EEPROM** Electrically Erasable Programmable ROM, also called Flash BIOS, is a ROM chip which can, unlike normal ROM, be updated. This allows you to keep up with changes in the BIOS programs without having to buy a new chip. TYAN's BIOS updates can be found at <http://www.tyan.com/html/drivers.html>

**ESCD** (Extended System Configuration Data) is a format for storing information about Plug and Play devices in the system BIOS. This information helps properly configure the system each time it boots.

**Firmware** is low level software that controls the system hardware.

**Form factor** is an industry term for the size, shape, power supply type, and external connector type of the PCB (personal computer board) or motherboard. The standard form factors are the AT and ATX, although TYAN also makes some Baby-AT boards.

A **Global timer** is an onboard hardware timer, such as the Real Time Clock.

**Handshaking** is a form of encryption. One system, typically the server, sends an encryption scheme to another agent, typically a client. Thus, the client's data is protected during transmittal to the server.

**HDD** stands for **Hard Disk Drive**.

**H-SYNC** controls the horizontal properties of the monitor.

**IC** (Integrated Circuit) is the formal name for the computer chip.

**IDE** Integrated Device (or Drive) Electronics is a simple, self-contained hard drive interface. It can handle drives up to 8.4GB in size. Almost all IDEs sold now are in fact Enhanced IDEs (EIDEs).

**IDE INT (IDE Interrupt)** is a hardware interrupt signal that goes to the IDE.

**I/O Input/Output** is the connection between your computer and another piece of hardware (mouse, keyboard, etc.).

**IRQ** An Interrupt Request is an electronic request that runs from a hardware device to the CPU. The interrupt controller assigns priorities to incoming requests and delivers them to the CPU. It is important that there is only one device hooked up to each IRQ line; doubling up devices on IRQ lines can lock up your system. Happily, Plug and Play operating systems take care of these details for you.

**ISA** stands for **Industry Standard Architecture**. ISA is a slower 8- or 16-bit BUS (data pathway).

**Latency** is the amount of time that one part of a system spends waiting for another part to catch up. This is most common when the system sends data out to a peripheral device, and is waiting for the peripheral to send some data back (peripherals tend to be slower than onboard system components).

**NVRAM** ROM and EEPROM are both examples of **Non-Volatile RAM**, memory that holds its data without power. DRAM, in contrast, is volatile.

**OEMs** (**Original Equipment Manufacturers**) like Compaq or IBM package other companies' motherboards and hardware inside their case and sell them.

The **parallel port** transmits the bits of a byte on eight different wires at the same time (that is, in parallel form, eight bits at the same time).

**PCI** stands for **Peripheral Component Interconnect**. PCI is a 32-bit local bus (data pathway) which is faster than the ISA bus. Local buses are those which operate within a single system (as opposed to a network bus, which connects multiple systems).

The **PCI PIO (PCI Programmable Input/Output)** modes are the data transfer modes used by IDE drives. These modes use the CPU for data transfer (DMA channels do not). PCI refers to the type of bus used by these modes to communicate with the CPU.

**PCI-to-PCI bridge** allows you to connect multiple PCI devices onto one PCI slot.

**Pipeline burst SRAM** is a fast secondary cache. It is used as a secondary cache because SRAM is slower than SDRAM, but usually larger. Data is cached first to the faster primary cache, and then, when the primary cache is full, to the slower secondary cache.

**Pipelining** improves system performance by allowing the CPU to begin executing a second instruction before the first is completed. A pipeline can be likened to an assembly line, with a given part of the pipeline repeatedly executing a set part of an operation on a series of instructions.

**PM timers (Power Management timers)** are software timers that count down the number of seconds or minutes until the system times out and enters sleep, suspend, or doze mode.

**PnP** is an acronym for Plug and Play, a design standard that has become ascendant in the industry. Plug and Play devices require little set-up to use. Novice end users can simply plug them into a computer that is running on a Plug and Play-aware operating system (such as Windows 95), and go to work. Devices and operating systems that are not Plug and Play require you to reconfigure your system each time you add or change any part of your hardware.

The term **RAM (Random Access Memory)**, while technically referring to a type of memory where any byte can be accessed without touching the adjacent data, is often used to refer to the system's main memory. This memory is available to any program running on the computer.

**ROM (Read-Only Memory)** is a storage chip which contains the BIOS (Basic Input/Output System), the basic instructions required to boot the computer and start up the operating system.

**SDRAM (Synchronous Dynamic RAM)** is so-called because it can keep two sets of memory addresses open simultaneously. By transferring data alternately from one set of addresses, and then the other, SDRAM cuts down on the delays associated with non-synchronous RAM, which must close one address bank before opening the next.

The **serial port** is so called because it transmits the eight bits of a byte of data along one wire, and receives data on another single wire (that is, the data is transmitted in serial form, one bit after another).

**SIMM** **S**ingle **I**n-line **M**emory **M**odules are the most common form of RAM. They must be installed in pairs, and do not have the carrying capacity or the speed of DIMMs.

**SIMM bank/socket** SIMM sockets are the physical slots into which you stick SIMM modules. A pair of SIMM sockets form a SIMM bank, and act as a unit. If only one socket is filled, the bank will not operate.

In **Sleep/Suspend mode**, all devices except the CPU shut down.

**SRAM** **S**tatic **R**AM, unlike DRAM, does not need to be refreshed in order to prevent data loss. Thus, it is faster, and more expensive.

In **Standby mode**, the video and fixed disk drive shut down; all other devices operate normally.

**UltraDMA/33** is a fast version of the old DMA channel. UltraDMA is also called UltraATA. Without UltraDMA your system cannot take advantage of the higher data transmission rates of the new UltraATA hard drives.

**Universal Serial Bus** or USB, is a versatile port. This one port type can function as a serial, parallel, mouse, keyboard, or joystick port. It is fast enough to support video transfer, and is capable of supporting up to 127 daisy-chained peripheral devices.

**VGA** (**V**ideo **G**raphics **A**rray) is the PC video display standard.

**V-SYNC** controls the vertical properties of the monitor.

**ZIF socket** **Z**ero **I**nsertion **F**orce sockets make it possible to insert CPUs without damaging the sensitive pins. The CPU is lightly placed in an open ZIF socket, and the metal lever pulled down. This shifts the processor over and down, guiding it into place on the board.

**Notice for the USA**

Compliance Information Statement (Declaration of Conformity Procedure) DoC FCC Part 15: This Device complies with Part 15 of the FCC Rules.

Operation is subject to the following conditions:

1) this device may not cause harmful interference, and  
2) this device must accept any interference received including interference that may cause undesired operation. If this equipment does cause harmful interference to radio or television reception, which can be determined by turning the equipment off and on, the user is encouraged to try one or more of the following measures:

- Reorient or relocate the receiving antenna.
- Increase the separation between the equipment and receiver.
- Plug the equipment into an outlet on a circuit different from that of the receiver.
- Consult the dealer or an experienced radio/television technician for help.

**Notice for Canada**

This apparatus complies with the Class B limits for radio interference as specified in the Canadian Department of Communications Radio Interference Regulations. (Cet appareil est conforme aux normes de Classe B d'interférence radio tel que spécifié par le Ministère Canadien des Communications dans les règlements d'interférence radio.)

**Notice for Europe (CE Mark)**

This product is in conformity with the Council Directive 89/336/EEC, 92/31/EEC (EMC).

**CAUTION:** Lithium Batteries included with this board. Danger of explosion if battery is incorrectly replaced. Replace only with the same or equivalent type recommended by manufacturer. Dispose of used batteries according to manufacturer instructions.

**Note:** The joystick port maximum output rating is 9 amperes at 5 volts.

# Addendum 1

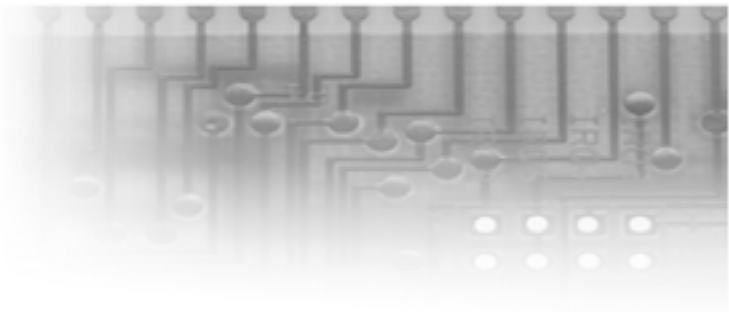

## BIOS Configuration (Text Mode)

The AMIBIOS Setup screen is shown below.

```

AMIBIOS HIFLEX SETUP UTILITY - VERSION 1.18
(c)1998 American Megatrends, Inc. All Rights Reserved

Standard CMOS Setup
Advanced CMOS Setup
Advanced Chipset Setup
Power Management Setup
PCI / Plug and Play Setup
Peripheral Setup
Auto-Detect Hard Disks
Change User Password
Change Supervisor Password
Change Language Setting
Auto Configuration with Optimal Settings
Auto Configuration with Fail Safe Settings
Save Settings and Exit
Exit Without Saving

Standard CMOS setup for changing time, date, hard disk type, etc.
ESC:Exit ↑↓:Sel F2/F3:Color F10:Save & Exit
  
```



You can select a Setup option by using the following keyboard keys:

Key	Function
Tab	Moves from one box to the next
Arrow keys	Changes selections within a box
Enter	Opens highlighted selection

The pages which follow contain the settings for the AMIBIOS Setup menus. Drawings have been included for ease of reference. Overall, the AMIBIOS Setup program is easy to use, and fairly intuitive. Note that the graphics in the manual are simpler than those that appear on your screen.

# 1. Standard CMOS Setup

Select the AMIBIOS Setup options below by choosing Main Setup from the AMIBIOS Setup main menu. The Standard Setup menu screen is shown below.

```

AMIBIOS SETUP - STANDARD CMOS SETUP
(c)1998 American Megatrends, Inc. All Rights Reserved

Date (mm/dd/yyyy):  Thurs Jan 1, 1998           Base Memory: 640 KB
Time (hh/mm/ss):    12:00:00                   Extd Memory: 127 MB

Floppy Drive A:     1.44 MB 3½
Floppy Drive B:     Not Installed

                                LBA Blk PIO 32Bit
                                Type      Size Cyln Head WPcom Sec Mode Mod Mode Mode
Pri Master : Auto                                On
Pri Slave  : Auto                                On
Sec Master : Auto                                On
Sec Slave  : Auto                                On

Boot Sector Virus Protection  Disabled

Month:  Jan - Dec                               ESC:Exit  ↑↓:Sel
Day:    01 - 31                                 PgUp/PgDn:Modify
Year:   1901 - 2099                             F2/F3:Color
    
```

### System Date/Time

You can type the date and time in directly, or select the portion of the date or time that you want to modify using the ↑ ↓ cursor keys. Use the PgUp/PgDn keys to Modify the settings. The clock runs on a 24-hour cycle (i.e. 1:00 PM is 13:00).

### Floppy Drive A: and B:

Move the cursor to these fields via the arrow keys and select the floppy type. The settings are 360KB 5¼ inch, 1.2 MB 5¼ inch, 720KB 3½ inch, 1.44MB 3½ inch, or 2.88MB 3½ inch. If you are not sure what type of floppy drive you have, consult the documentation that came with your drive.

### Primary Master, Primary Slave, Secondary Master, Secondary Slave

Select these options to configure the various drives. A screen with a list of drive parameters appears.

AMIBIOS SETUP - STANDARD CMOS SETUP							
(c)1998 American Megatrends, Inc. All Rights Reserved							
Date (mm/dd/yyyy):	Thurs	Jan	1, 1998			Base Memory:	640 KB
Time (hh/mm/ss):	12:00:00					Extd Memory:	127 MB
Floppy Drive A:	1.44 MB	3½					
Floppy Drive B:	Not Installed						
						LBA Blk PIO 32Bit	
	Type	Size	Cyln	Head	WPcom	Sec Mode	Mod Mode
Pri Master :	Auto						On
Pri Slave :	Auto						On
Sec Master :	Auto						On
Sec Slave :	Auto						On
Boot Sector Virus Protection	Disabled						
1-46	: Predefined types					ESC:Exit ↑↓:Sel	
USER	: Enter parameters manually					PgUp/PgDn:Modify	
AUTO	: Set parameters automatically on each boot					F2/F3:Color	
CDROM	: Use for ATAPI CDROM drives						
ARMD	: Use for LS120, MO, Iomega Zip Drives						
Or press ENTER to autodetect							

## Default Settings

Every option in AMIBIOS Setup contains two default values: a Fail-Safe default and the Optimal default value. You can also choose to restore the original BIOS settings (i.e. those that your board came with) at any time. These options can be found in the 'Exit' menu.

## Optimal Defaults

The Optimal default values provide optimum performance settings for all devices and system features.

## Fail-Safe Defaults

The Fail-Safe default settings consist of the safest set of parameters. Use them if the system is behaving erratically. They should always work but do not provide optimal system performance characteristics.

```
AMIBIOS HIFLEX SETUP UTILITY - VERSION 1.18
(c)1998 American Megatrends, Inc. All Rights Reserved

Standard CMOS Setup
Advanced CMOS Setup
Advanced Chipset Setup
Power Management Setup
PCI / Plug and Play Setup
Peripheral Setup
Auto-Detect Hard Disks
Change User Password
Change Supervisor Password
Change Language Setting
Auto Configuration with Optimal Settings
Auto Configuration with Fail Safe Settings
Save Settings and Exit
Exit Without Saving

Standard CMOS setup for changing time, date, hard disk type, etc.
ESC:Exit ↑↓:Sel F2/F3:Color F10:Save & Exit
```

## 2. Advanced CMOS Setup

The Advanced Setup options included in the AMIBIOS Setup for the Thunder X are described in this chapter. Select Advanced Setup from the AMIBIOS Setup main menu to display the Advanced Setup options.

AMIBIOS SETUP - ADVANCED CMOS SETUP (c)1998 American Megatrends, Inc. All Rights Reserved		
<b>Quick Boot</b>	<b>Disabled</b>	Available Options: Disabled Enabled
Primary Master ARMD Emulated as	Auto	
Primary Slave ARMD Emulated as	Auto	
Secondary Master ARMD Emulated as	Auto	
Secondary Slave ARMD Emulated as	Auto	
1st Boot Device	Floppy	
2nd Boot Device	1st IDE-HDD	
3rd Boot Device	ATAPI CDROM	
Try Other Boot Devices	Yes	
Floppy Access Control	Read-Write	
Hard Disk Access Control	Read-Write	
S.M.A.R.T. for Hard Disks	Disabled	
Boot Up Num-Lock	On	
PS/2 Mouse Support	Enabled	
Primary Display	VGA/EGA	
Password Check	Setup	
Boot To OS/2	No	
Internal Cache	WriteBack	ESC:Exit ↑↓:Sel
System BIOS Cacheable	Enabled	PgUp/PgDn:Modify
Cache Bus ECC	Enabled	F2/F3:Color

### Advanced CMOS Setup Default Settings Chart

Setting Option	Optimal Default	Fail-Safe Default
Quick Boot	Disabled	Disabled
Primary Master ARMD Emulated as	Auto	Auto
Primary Slave ARMD Emulated as	Auto	Auto
Secondary Master ARMD Emulated as	Auto	Auto
Secondary Slave ARMD Emulated as	Auto	Auto
1st Boot Device	Floppy	Floppy
2nd Boot Device	1st IDE-HDD	1st IDE-HDD
3rd Boot Device	ATAPI CDROM	ATAPI CDROM
Try Other Boot Devices	Yes	Yes
Floppy Access Control	Read-Write	Read-Write
Hard Disk Access Control	Read-Write	Read-Write

**Settings Chart (Continued)**

<b>Setting Option</b>	<b>Optimal Default</b>	<b>Fail-Safe Default</b>
S.M.A.R.T. for Hard Disks	Disabled	Disabled
Boot Up Num-Lock	On	On
PS/2 Mouse Support	Enabled	Enabled
Primary Display	VGA/EGA	VGA/EGA
Password Check	Setup	Setup
Boot To OS/2	No	No
Internal Cache	WriteBack	WriteBack
System BIOS Cacheable	Enabled	Disabled
Cache Bus ECC	Enabled	Enabled
Default Primary Video	AGP	AGP
C000,16K Shadow	Cached	Cached
C400,16K Shadow	Cached	Cached
C800,16K Shadow	Disabled	Disabled
CC00,16K Shadow	Disabled	Disabled
D000,16K Shadow	Disabled	Disabled
D400,16K Shadow	Disabled	Disabled
D800,16K Shadow	Disabled	Disabled
DC00,16K Shadow	Disabled	Disabled

### 3. Advanced Chipset Setup

Choose Chipset Setup on the AMIBIOS Setup main menu. All Chipset Setup options are then displayed. AMIBIOS Setup can be customized. AMIBIOS Setup can be customized via AMIBCP. See the AMIBIOS Utilities Guide for additional information.

AMIBIOS SETUP - ADVANCED CHIPSET SETUP (c)1998 American Megatrends, Inc. All Rights Reserved		
<b>USB Function</b>	<b>Disabled</b>	<b>Available Options:</b> Disabled Enabled  ESC:Exit ↑↓:Sel PgUp/PgDn:Modify F2/F3:Color
USB KB/Mouse Legacy Support	Disabled	
Port 64/60 Emulation	Disabled	
SERR#	Disabled	
PERR#	Disabled	
WSC# Handshake	Enabled	
USWC Write Post	Enabled	
Master Latency Timer (Clks)	64	
Multi-Trans Timer (Clks)	32	
PCI1 to PCI0 Access	Disabled	
Method of Memory Detection	Auto & SPD	
DRAM Integrity Mode	N/A	
DRAM Refresh Rate	15.6us	
Memory Hole	Disabled	
SDRAM RAS# to CAS# Delay	3SCLKs	
SDRAM RAS# Precharge	3SCLKs	
Power Down SDRAM	Disabled	
ACPI Control Register	Disabled	
Gated Clock	Disabled	
Graphics Aperture Size	64 MB	

### Advanced Chipset Setup Default Settings Chart

Setting Option	Optimal Default	Fail-Safe Default
USB Function	Disabled	Disabled
* USB KB/Mouse Legacy Support	Disabled	Disabled
* Port 64/60 Emulation	Disabled	Disabled
SERR#	Disabled	Disabled
PERR#	Disabled	Disabled
WSC# Handshake	Enabled	Enabled
USWC Write Post	Enabled	Enabled
Master Latency Timer (Clks)	64	64
Multi-Trans Timer (Clks)	32	32
PCI1 to PCI0 Access	Disabled	Disabled
Method of Memory Detection	Auto & SPD	Auto & SPD
DRAM Integrity Mode	* N/A	* N/A

**Settings Chart (continued)**

<b>Setting Option</b>	<b>Optimal Default</b>	<b>Fail-Safe Default</b>
DRAM Refresh Rate	15.6 us	15.6 us
Memory Hole	Disabled	Disabled
SDRAM RAS# to CAS# Delay	3SCLKs	3SCLKs
SDRAM RAS# Precharge	3SCLKs	3SCLKs
Power Down SDRAM	Disabled	Disabled
ACPI Control Register	Disabled	Disabled
Gated Clock	Disabled	Disabled
Graphics Aperture Size	64 MB	64 MB
Search for MDA Resources	Yes	Yes
AGP Multi-Trans Timer (AGP Clks)	32	Disabled
AGP Low-Priority Timer (Clks)	16	Disabled
AGP SERR	Disabled	Disabled
AGP Parity Error Response	Disabled	Disabled
8bit I/O Recovery Time	Disabled	Disabled
16bit I/O Recovery Time	Disabled	Disabled
PIIX4 SERR#	Disabled	Disabled
USB Passive Release	Enabled	Enabled
PIIX4 Passive Release	Enabled	Enabled
PIIX4 Delayed Transaction	Disabled	Disabled
Type F DMA Buffer Control1	Disabled	Disabled
Type F DMA Buffer Control2	Disabled	Disabled
DMA-0 Type	Normal ISA	Normal ISA
DMA-1 Type	Normal ISA	Normal ISA
DMA-2 Type	Normal ISA	Normal ISA
DMA-3 Type	Normal ISA	Normal ISA
DMA-5 Type	Normal ISA	Normal ISA
DMA-6 Type	Normal ISA	Normal ISA
DMA-7 Type	Normal ISA	Normal ISA
CPU Bus Frequency	Auto	Auto

\* Setting option not selectable.

## 4. Power Management Setup

The AMIBIOS Setup options described in this section are selected by choosing Power Management Setup from the AMIBIOS Setup main menu.

AMIBIOS SETUP - POWER MANAGEMENT SETUP (c)1998 American Megatrends, Inc. All Rights Reserved		
<b>ACPI Aware O/S</b>	<b>No</b>	<b>Available Options:</b>
Power Management / APM	Enabled	No
Power Button Function	On/Off	Yes
Green PC Monitor Power State	Suspend	
Video Power Down Mode	Suspend	
Hard Disk Power Down Mode	Suspend	
Hard Disk Time Out (Minute)	Disabled	
Power Saving Type	Sleep	
Standby / Suspend Timer Unit	4 min	
Standby Time Out	Disabled	
Suspend Time Out	Disabled	
Slow Clock Ratio	50% - 62.5%	
Display Activity	Ignore	
Device 6 (Serial port 1)	Monitor	
Device 7 (Serial port 2)	Monitor	
Device 8 (Parallel port)	Monitor	
Device 5 (Floppy Disk)	Monitor	
Device 0 (Primary master IDE)	Monitor	ESC:Exit ↑↓:Sel
Device 1 (Primary slave IDE)	Monitor	PgUp/PgDn:Modify
Device 2 (Secondary master IDE)	Monitor	F2/F3:Color

### Power Management Setup Default Settings Chart

Setting Option	Optimal Default	Fail-Safe Default
ACPI Aware O/S	No	No
Power Management / APM	Enabled	Enabled
Power Button Function	On/Off	On/Off
Green PC Monitor Power State	Suspend	Stand By
Video Power Down Mode	Suspend	Disabled
Hard Disk Power Down Mode	Suspend	Disabled
Hard Disk Time Out (Minute)	Disabled	Disabled
Power Saving Type	Sleep	Sleep
Standby / Suspend Timer Unit	4 min	4 min
Standby Time Out	Disabled	Disabled
Suspend Time Out	Disabled	Disabled
Slow Clock Ratio	50% - 62.5%	50% - 62.5%
Display Activity	Ignore	Ignore



Setting Option	Optimal Default	Fail-Safe Default
Device 6 (Serial port 1)	Monitor	Monitor
Device 7 (Serial port 2)	Monitor	Monitor
Device 8 (Parallel port)	Monitor	Monitor
Device 5 (Floppy disk)	Monitor	Monitor
Device 0 (Primary master IDE)	Monitor	Monitor
Device 1 (Primary slave IDE)	Monitor	Monitor
Device 2 (Secondary master IDE)	Monitor	Monitor
Device 3 (Secondary slave IDE)	Monitor	Monitor
LAN Wake-up	Disabled	Disabled
PC 98 Power LED	Disabled	Disabled
Fan OFF at Suspend	Enabled	Enabled
RTC Wake-up	Disabled	Disabled
*Hour	N/A	N/A
*M inute	N/A	N/A

\* Setting option not selectable.

## 5. PCI / Plug and Play Setup

Choose PCI/Plug and Play Setup from the AMIBIOS Setup screen to display the PCI and Plug and Play Setup options, described below.

AMIBIOS SETUP - POWER MANAGEMENT SETUP (c)1998 American Megatrends, Inc. All Rights Reserved		
<b>Plug and Play Aware O/S</b>	<b>Yes</b>	<b>Available Options:</b>
PCI Latency Timer (PCI Clocks)	64	No
PCI VGA Palette Snoop	Disabled	Yes
Allocate IRQ to PCI VGA	Yes	
PCI IDE BusMaster	Disabled	
OffBoard PCI IDE Card	Auto	
OffBoard PCI IDE Primary IRQ	Disabled	
OffBoard PCI IDE Secondary IRQ	Disabled	
PCI Slot1 IRQ Priority	Auto	
PCI Slot2 IRQ Priority	Auto	
PCI Slot3 IRQ Priority	Auto	
PCI Slot4 IRQ Priority	Auto	
DMA Channel 0	PnP	
DMA Channel 1	PnP	
DMA Channel 3	PnP	
DMA Channel 5	PnP	
DMA Channel 6	PnP	
DMA Channel 7	PnP	
IRQ3	PCI/PnP	ESC:Exit ↑↓:Sel
IRQ4	PCI/PnP	PgUp/PgDn:Modify
		F2/F3:Color

## Plug and Play Setup Default Settings Chart

Setting Option	Optimal Default	Fail-Safe Default
Plug and Play Aware O/S	Yes	Yes
PCI Latency Timer (PCI Clocks)	64	64
PCI VGA Palette Snoop	Disabled	Disabled
Allocate IRQ to PCI VGA	Yes	Yes
PCI IDE Bus Master	Disabled	Disabled
Off Board PCI IDE Card	Auto	Auto
*Off Board PCI IDE Primary IRQ	Disabled	Disabled
*Off Board PCI IDE Secondary IRQ	Disabled	Disabled
PCI Slot 1 IRQ Priority	Auto	Auto
PCI Slot 2 IRQ Priority	Auto	Auto
PCI Slot 3 IRQ Priority	Auto	Auto
PCI Slot 4 IRQ Priority	Auto	Auto
DMA Channel 0	PnP	PnP
DMA Channel 1	PnP	PnP
DMA Channel 3	PnP	PnP
DMA Channel 5	PnP	PnP
DMA Channel 6	PnP	PnP
DMA Channel 7	PnP	PnP
IRQ 3	PC/VPnP	PC/VPnP
IRQ 4	PC/VPnP	PC/VPnP
IRQ 5	PC/VPnP	PC/VPnP
IRQ 7	PC/VPnP	PC/VPnP
IRQ 9	PC/VPnP	PC/VPnP
IRQ 10	PC/VPnP	PC/VPnP
IRQ 11	PC/VPnP	PC/VPnP
IRQ 12	PC/VPnP	PC/VPnP
IRQ 14	PC/VPnP	PC/VPnP
IRQ 15	PC/VPnP	PC/VPnP
Reserved Memory Size	Disabled	Disabled
*Reserved Memory Address	C8000	C8000
PCI Device Search Order	First-Last	First-Last
BIOS Devnode for Shadow RAM	Disabled	Disabled

\* Setting option is not selectable

## 6. Peripheral Setup

Peripheral Setup options are displayed by choosing Peripheral Setup from the AMIBIOS Setup main menu. All Peripheral Setup options are described here.

AMIBIOS SETUP - PERIPHERAL SETUP (c)1998 American Megatrends, Inc. All Rights Reserved		
<b>Power Interruption</b>	<b>Disabled</b>	Available Options: Disabled Enabled
Onboard FDC	Auto	
Onboard Serial Port1	3F8h	
Onboard Serial Port2	2F8h	
Serial Port2 Mode	Normal	
IR Duplex Mode	N/A	
IR Receiver Pin	IRRx1	
Onboard Parallel Port	378	
Parallel Port Mode	Normal	
EPP Version	N/A	
Parallel Port IRQ	7	
Parallel Port DMA Channel	N/A	
Onboard IDE		
		ESC:Exit ↑↓:Sel PgUp/PgDn:Modify F2/F3:Color

### Peripheral Setup Default Settings Chart

Setting Option	Optimal Default	Fail-Safe Default
Power Interruption	Disabled	Disabled
Onboard FDC	Auto	Auto
Onboard Serial Port 1	3F8h	3F8h
Onboard Serial Port 2	2F8h	2F8h
Serial Port 2 Mode	Normal	Normal
*IR Duplex Mode	N/A	N/A
*IR Receiver Pin	IRRX1	IRRX1
Onboard Parallel Port	378	378
Parallel Port Mode	Normal	Normal
*EPP Version	N/A	N/A
Parallel Port IRQ	7	7
*Parallel Port DMA Channel	N/A	N/A
Onboard IDE	Both	Both

## 7. Supervisor and User Security

You can limit access to the Setup Program or to the system using the Supervisor and User password options (the Supervisor password gives you access to the Setup Program and the system; the User password, only to the system). Note that you must create a supervisor password before you create a user password.

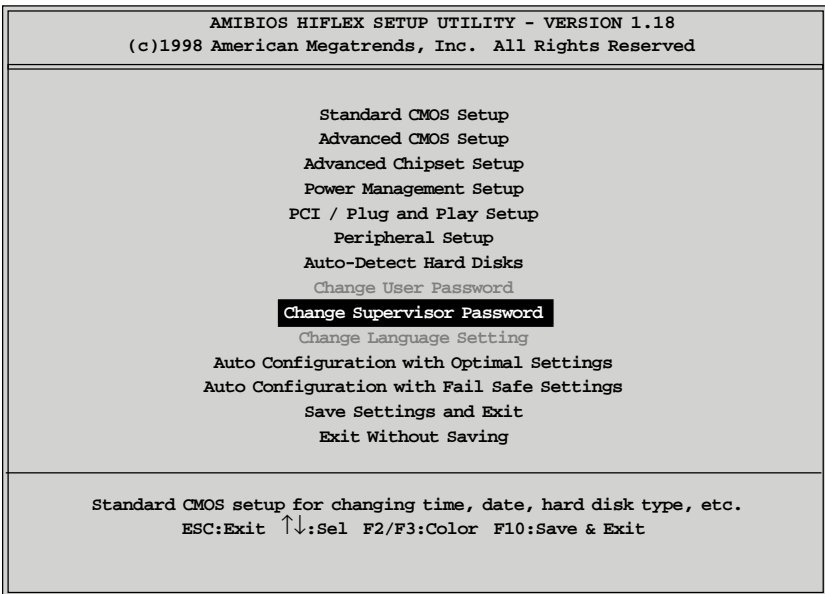

When you select the Supervisor Security option, a dialog box (shown below) will appear, allowing you to enter a password. You may either type the password in, or click on the onscreen buttons. Your password must be between one and six characters long.

To enter a new Supervisor password, select the Supervisor Security option. You will be asked to enter the current password. After you do so, you will be prompted to enter the new password.

## 8. Language Utility

Currently, the BIOS Setup program is available only in English.

## 9. Flash Writer Utility

The AMI Flash Writer Utility is now included in the AMIBIOS, and so it is simpler to upgrade the BIOS of your mainboard. The system BIOS is stored on a flash EEPROM ROM chip on the mainboard which can be erased and reprogrammed by following the directions on the following page.

1. From the DOS prompt, rename the BIOS file that you have downloaded to “amiboot.rom” and copy it on to a floppy disk.
2. Insert the floppy disk with the BIOS upgrade into the A: drive.
3. Turn the power off.
4. While holding the <Ctrl> and <Home> keys, turn the power on. The system will begin to read from the A: drive, and write the BIOS information contained on the floppy disk in that drive to the EEPROM ROM chip. When the BIOS has been totally reprogrammed, the system will reboot with the new BIOS in operation.
5. If the system does not reboot in three minutes, power down the system wait a few seconds, and then turn the power back on again. You will be prompted to press <F1> to run Setup. You may check your settings at this time, or simply save and exit the program.

# Addendum 2

## CPU Retention Module Options

---

Tyan offers two different options for securing Intel's Pentium II CPUs onto the motherboard. Each option provides retention for both older Pentium II's as well as newer Pentium II's (including Celeron).

### OPTION 1:

Two different types of retention modules are included in the motherboard package. For older versions of Pentium II, use the retention module shown in Figure 1. For newer versions of Pentium II CPUs (including Celeron), use the retention module shown in Figure 2. (Screws for the retention modules are provided.)

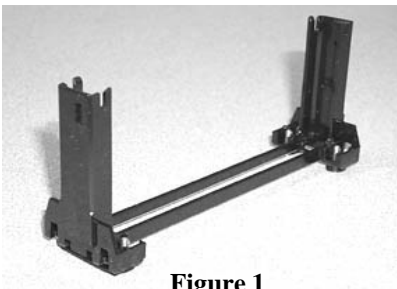

**Figure 1**

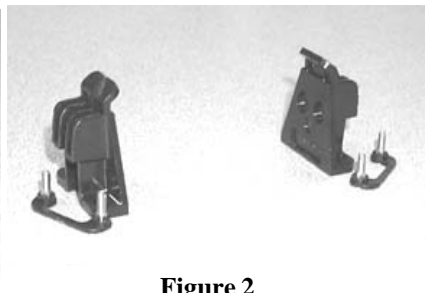

**Figure 2**

**OPTION 2:**

One universal retention module is included in the motherboard package. This type of retention module adapts to both old and new Pentium II CPUs - see Figure 3. (Screws for the retention modules are provided)

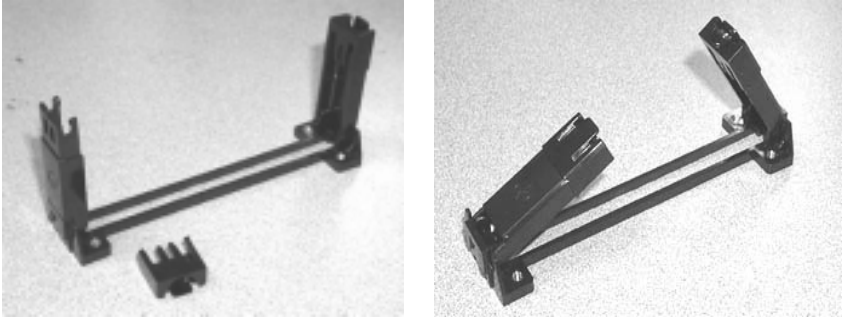

**Figure 3**