

# **SBC-675**

Celeron CPU Card with LCD,  
Ethernet, High Drive, & SSD



## **Copyright Notice**

This document is copyrighted, 1999. All rights are reserved. The original manufacturer reserves the right to make improvements to the products described in this manual at any time without notice.

No part of this manual may be reproduced, copied, translated, or transmitted in any form or by any means without the prior written permission of the original manufacturer. Information provided in this manual is intended to be accurate and reliable. However, the original manufacturer assumes no responsibility for its use, nor for any infringements upon the rights of third parties which may result from its use.

## **Acknowledgements**

AMD is a trademark of Advanced Micro Devices, Inc.

AMI is a trademark of American Megatrends, Inc.

Award is a trademark of Award Software International, Inc.

Cyrix is a trademark of Cyrix Corporation.

IBM, PC/AT, PS/2, and VGA are trademarks of International Business Machines Corporation.

Intel and Pentium II are trademarks of Intel Corporation.

Microsoft Windows® is a registered trademark of Microsoft Corp.

SMC is a trademark of Standard Microsystems Corporation.

RTL is a trademark of Realtek Semi-Conductor Co., Ltd.

C&T is a trademark of Chips and Technologies, Inc.

UMC is a trademark of United Microelectronics Corporation.

ITE is a trademark of Integrated Technology Express, Inc.

SiS is a trademark of Silicon Integrated Systems Corp.

VIA is a trademark of VIA Technology, Inc.

All other product names or trademarks are properties of their respective owners.

# **A Message to the Customer**

---

## **AAEON Customer Services**

Each and every AAEON product is built to the most exacting specifications to ensure reliable performance in the harsh and demanding conditions typical of industrial environments. Whether your new AAEON equipment is destined for the laboratory or the factory floor, you can be assured that your product will provide the reliability and ease of operation for which the name AAEON has come to be known.

Your satisfaction is our primary concern. Here is a guide to AAEON's customer services. To ensure you get the full benefit of our services, please follow the instructions below carefully.

## **Technical Support**

We want you to get the maximum performance from your products. So if you run into technical difficulties, we are here to help. For the most frequently asked questions, you can easily find answers in your product documentation. These answers are normally a lot more detailed than the ones we can give over the phone.

So please consult this manual first. If you still cannot find the answer, gather all the information or questions that apply to your problem, and with the product close at hand, call your dealer. Our dealers are well trained and ready to give you the support you need to get the most from your AAEON products. In fact, most problems reported are minor and are able to be easily solved over the phone.

In addition, free technical support is available from AAEON engineers every business day. We are always ready to give advice on application requirements or specific information on the installation and operation of any of our products.

## **Product Warranty**

AAEON warrants to you, the original purchaser, that each of its products will be free from defects in materials and workmanship for one year from the date of purchase.

This warranty does not apply to any products which have been repaired or altered by persons other than repair personnel authorized by AAEON, or which have been subject to misuse, abuse, accident or improper installation. AAEON assumes no liability under the terms of this warranty as a consequence of such events.

Because of AAEON's high quality-control standards and rigorous testing, most of our customers never need to use our repair service. If an AAEON product is defective, it will be repaired or replaced at no charge during the warranty period. For out-of-warranty repairs, you will be billed according to the cost of replacement materials, service time, and freight. Please consult your dealer for more details.

If you think you have a defective product, follow these steps:

1. Collect all the information about the problem encountered. (For example, CPU type and speed, AAEON products used, other hardware and software used, etc.) Note anything abnormal and list any on-screen messages you get when the problem occurs.
2. Call your dealer and describe the problem. Please have your manual, product, and any helpful information readily available.
3. If your product is diagnosed as defective, obtain an RMA (return material authorization) number from your dealer. This allows us to process your return more quickly.
4. Carefully pack the defective product, a fully-completed Repair and Replacement Order Card and a photocopy proof of purchase date (such as your sales receipt) in a shippable container. A product returned without proof of the purchase date is not eligible for warranty service.
5. Write the RMA number visibly on the outside of the package and ship it prepaid to your dealer.

# Packing list

---

Before you begin installing your card, please make sure that the following materials have been shipped:

- 1 SBC-675 All-in-One Single Board Computer
- 1 Quick Installation Guide
- 1 Supporting CD-ROM contains the followings:
  - User's Manual (this manual in PDF file)
  - Ethernet drivers and utilities
  - VGA drivers and utilities
  - BIOS files
- 1 Hard disk drive (IDE) interface cable
- 1 Floppy disk drive interface cable
- 1 6-pin mini-DIN dual outlet adapter for keyboard and PS/2 mouse
- 1 mounting bracket contains 1 Parallel port adapter (26 pins) and COM2 adapter (for RS-232/422/485)

If any of these items are missing or damaged, contact your distributor or sales representative immediately.

# Notice

---

Dear Customer,

Thank you for purchasing the SBC-675 board. This user's manual is designed to help you to get the most out of the SBC-675, please read it thoroughly before you install and use the board. The product that you have purchased comes with an two-year limited warranty, but AAEON will not be responsible for misuse of the product. Therefore, we strongly urge you to first read the manual before using the product.

To receive the latest version of the user manual, please visit our Web site at:

**<http://www.aaeon.com>**

# Contents

<b>Chapter 1: General Information .....</b>	<b>1</b>
Introduction .....	2
Features .....	3
Specifications .....	4
Board layout .....	7
Board dimensions .....	8
<b>Chapter 2: Installation .....</b>	<b>9</b>
Jumpers and connectors .....	10
Locating jumpers .....	12
Locating connectors .....	13
Setting jumpers .....	14
CPU installing and upgrading .....	15
Installing DRAM (DIMMS) .....	17
System Memory .....	17
Supplementary information about DIMM .....	17
Memory Installation Procedures .....	17
Cache Memory .....	18
LCD driving voltage select (J1) .....	19
Clear CMOS (J5) .....	19
CPU frequency ratio select (J4) .....	20
Celeron CPU jumper setting examples .....	21
LCD clock signal select (J6) .....	22
COM2 RS-232/422/485 select (J7, J8) .....	22
DOC address select (J9) .....	23
Power connectors (PWR1, CN17) .....	24
Power connector (PWR1) .....	24
CPU fan power connector (CN17) .....	24
Power LED and Keylock (CN1) .....	25
IDE hard drive connector (CN2, CN8) .....	26
Connecting the hard drive .....	26



<b>IDE hard drive connectors (CN2, CN8)</b> .....	<b>27</b>
<b>Floppy drive connector (CN3)</b> .....	<b>28</b>
Connecting the floppy drive .....	28
Floppy drive connectors (CN3) .....	29
<b>Hard drive LED (CN4)</b> .....	<b>30</b>
<b>Reset switch (CN5)</b> .....	<b>30</b>
<b>USB connector (CN6)</b> .....	<b>30</b>
<b>External speaker (CN7)</b> .....	<b>31</b>
<b>Parallel port connector (CN9)</b> .....	<b>32</b>
Parallel port IRQ .....	32
Parallel port connector table (CN9) .....	32
<b>IrDA connector (CN11)</b> .....	<b>33</b>
<b>Display connectors (CN12, CN10)</b> .....	<b>34</b>
VGA display connector (CN12).....	34
LCD display connector (CN10) .....	35
<b>100Base-Tx Ethernet connector (CN13)</b> .....	<b>36</b>
<b>Serial ports (CN16, CN14)</b> .....	<b>36</b>
COM2 RS-232/422/485 serial ports (CN14).....	36
<b>Keyboard and PS/2 mouse connector (CN18, CN15) ...</b>	<b>37</b>
<b>DiskOnChip socket (U15)</b> .....	<b>38</b>
<b>DiskOnChip (DOC) 2000 Installation</b> .....	<b>39</b>
<b>Chapter 3: Award BIOS Setup</b> .....	<b>41</b>
Starting setup .....	42
Setup keys .....	43
Getting help .....	44
In case of problem.....	44
Main setup menu .....	45
Standard CMOS setup .....	47
BIOS features setup .....	54
CHIPSET features setup .....	58
Power management setup .....	62
PNP/PCI configuration setup .....	67

Load BIOS defaults/Load setup defaults .....	70
Integrated peripherals setup .....	71
Supervisor/User password setting .....	74
IDE HDD auto detection .....	76
Save & exit setup .....	77

**Chapter 4: Flat Panel/CRT controller Display  
Drivers and Utilities ..... 79**

<b>Software drives</b> .....	<b>80</b>
Hardware configuration .....	80
Necessary prerequisites .....	81
Before you begin .....	81
<b>Windows 95</b> .....	<b>82</b>
Driver installation .....	82
<b>Windows 3.51</b> .....	<b>90</b>
Driver installation .....	90
<b>Windows NT 4.0</b> .....	<b>91</b>
Driver installation .....	91

**Chapter 5: Ethernet software configuration ...  
..... 93**

Ethernet software configuration .....	94
---------------------------------------	----

**Appendix A: Programming the Watchdog  
Timer ..... 95**

<b>Programming the watchdog timer</b> .....	<b>96</b>
How to set the watchdog timer .....	96
Demo program .....	97



## General Information

This chapter gives background information on the mainboard.

Sections include:

- Board specifications
- Layout and dimensions

# Introduction

---

The SBC-675 is an all-in-one Celeron processor based single board computer (SBC) with a PCI Flat Panel controller, a PCI 100Base-Tx Ethernet interface. When using an Intel Celeron processor, the SBC-675 achieves outstanding performance that surpasses any other SBC in its class. In addition, the onboard SSD interface supports M-systems DiskOnChip 2000 series, memory capacity from 2 MB to 144 MB.

Onboard features include two serial ports (one RS-232, one RS-232/422/485), one multi-mode parallel (ECP/EPP/SPP) port, connector for two USB (Universal Serial Bus) ports, a floppy drive controller, and a keyboard/PS/2 mouse interface. The built-in high speed PCI IDE controller supports Ultra DMA/33 mode. Up to four IDE devices can be connected, including large hard disks, CD-ROM drives, and tape backup drives, etc.

The SBC-675 also features power management to minimize power consumption. It complies with the ACPI standard and supports three types of power saving features: Doze mode, Standby mode, and Suspend mode. In addition, the board's watchdog timer can automatically reset the system or generate an interrupt in case the system stops due to a program bug or EMI.

## Highly integrated SBC

The SBC-675 is a highly integrated SBC that combines video and network functions on a single computer board. It provides up to 1024 x 768 resolution @ 64K colors with on-chip 2MB SDRAM display memory. Major onboard devices adopt PCI technology to achieve outstanding computing performance when used with Intel Celeron level processors, making the SBC-675 one of the world's best and most powerful all-in-one Single Board Computers.

## Features

---

- Supports Intel Celeron CPUs up to 466MHz
- Supports DiskOnChip (SSD) up to 144MB
- C&T 69000 LCD controller supports 36-bit TFT Panels
- 100Base-Tx Fast Ethernet
- Supports H/W status monitoring
- High Drive design to enhance the ISA driving capacity

# Specifications

---

## Standard SBC functions

- **CPU:** Intel Celeron 300~466MHz (With system bus frequencies of 66/100MHz)
- **Bus interface:** PCI/ISA bus. PICMG 2.0 standard
- **ISA driving capacity:** Built-in Address/Data buffer supports driving capacity up to 64mA
- **CPU socket:** 370-pin socket
- **BIOS:** Award 256KB Flash BIOS
- **Chipset:** Intel 440BX
- **I/O chipset:** Winbond W83977TF with fully 16-bit I/O decoded
- **Memory :** Onboard three 168-pin DIMM sockets support up to 384Mbytes SDRAM
- **Enhanced IDE:** Supports up to four IDE devices. Supports Ultra DMA/33 mode with data transfer rate 33MB/Sec.
- **FDD interface:** Supports up to two floppy disk drives, 5.25" (360KB and 1.2MB) and/or 3.5" (720KB, 1.44MB, and 2.88MB)
- **Parallel port:** One bi-directional parallel port. Supports SPP, ECP, and EPP modes
- **Serial port:** One RS-232 and one RS-232/422/485 serial port. Ports can be configured as COM1, COM2, COM3, COM4, or disabled individually. (16C550 equivalent)
- **IR interface:** Supports one IrDA Tx/Rx header
- **KB/Mouse connector :** 6-pin mini-DIN connector supports PC/AT keyboard and PS/2 mouse. Additional 5-pin header supports PC/AT keyboard for IPC applications
- **USB connectors:** 5 x 2 header onboard supports dual USB ports
- **Battery:** Lithium battery for data retention of up to 10 years

- **Watchdog timer:** Can generate a system reset, IRQ15, or NMI. Software selectable time-out interval (2 sec. ~ 255 sec., 1 sec./step)
- **DMA:** 7 DMA channels (8237 equivalent)
- **Interrupt:** 15 interrupt levels (8259 equivalent)
- **Power management:** I/O peripheral devices support power saving and doze/standby/suspend modes. APM 1.2 compliant
- **H/W status monitoring:** Winbond W83781D H/W status monitoring IC supports power supply voltages, fan speed, and temperatures monitoring

### **Flat Panel/CRT Interface**

- **Chipset:** C&T 69000
- **Display memory:** Built-in 2MB SDRAM
- **Display type:** Supports non-interlaced CRT and LCD (TFT, DSTN, and Mono) displays. Can display both CRT and Flat Panel simultaneously
- **Resolution:** Up to 1024x768@64K colors

### **Ethernet Interface**

- **Chipset:** Realtek RTL8139B 100Base-Tx Fast Ethernet controller
- **Ethernet interface:** Onboard 100Base-Tx RJ-45 connector

### **SSD Interface**

- One 32-pin DIP socket supports M-Systems DiskOnChip 2000 series up to 144MB



## **Mechanical and environmental**

- **Power supply voltage:** +5V (4.75V to 5.25V),  
+12V (11.4V to 12.6V)
- **Typical power requirement:** +5V @ 4A
- **Operating temperature:** 32 to 140°F (0 to 60°C)
- **Board size:** 13.3"(L) x 4.8"(W) (338mm x 122mm)
- **Weight:** 1.2 lb. (0.5 Kg)

## Board layout

---



# Board dimensions

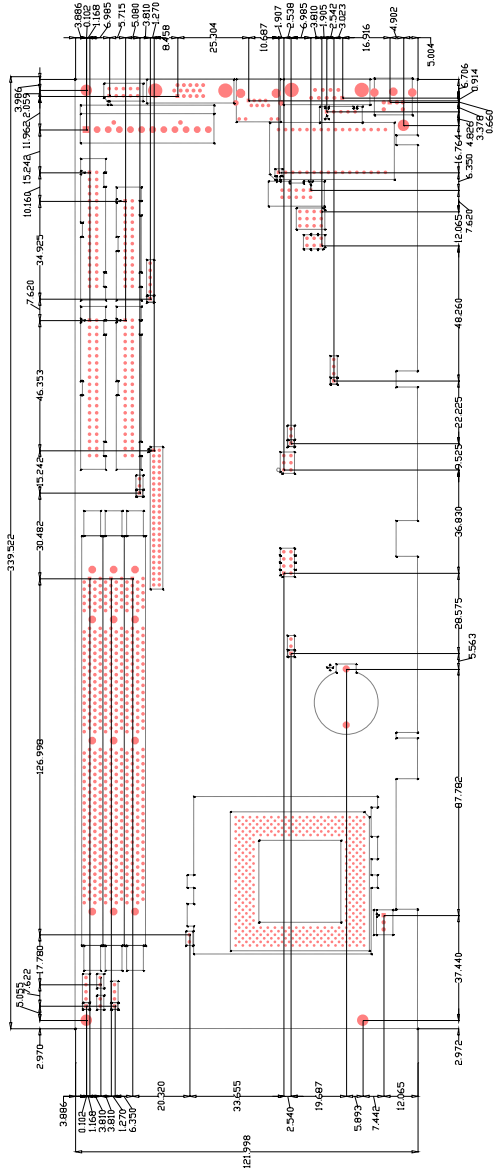

## Installation

This chapter describes how to set up the main board hardware, including instructions on setting jumpers and connecting peripherals, switches, and indicators. Be sure to read all the safety precautions before you begin the installation procedure.

## Jumpers and connectors

---

Connectors on the board link it to external devices such as hard disk drives, a keyboard, or floppy drives. In addition, the board has a number of jumpers that allow you to configure your system to suit your application.

The following tables list the function of each of the board's jumpers and connectors.

---

Jumpers	
Label	Function
J1	LCD driving voltage select
J4	CPU frequency ratio select
J5	Clear CMOS
J6	LCD clock signal select
J7	COM2 RS-232/422/485 select
J8	COM2 RS-232/422/485 select
J9	DOC address select

---

Connectors	
Label	Function
CN1	Power LED and keylock
CN2	IDE hard drive connector (Primary)
CN3	Floppy drive connector
CN4	IDE drive LED
CN5	Reset switch
CN6	USB connector
CN7	External speaker
CN8	IDE hard drive connector (Secondary)
CN9	Parallel port connector
CN10	LCD display connector
CN11	IrDA connector
CN12	VGA display connector
CN13	100Base-Tx Ethernet connector
CN14	COM2 RS-232/422/485 serial port connector
CN15	Internal keyboard connector
CN16	COM1 RS-232 serial port connector
CN17	CPU fan power connector
CN18	Keyboard and PS/2 mouse connector
U15	DiskOnChip socket
PWR1	Power connector

# Locating jumpers

---

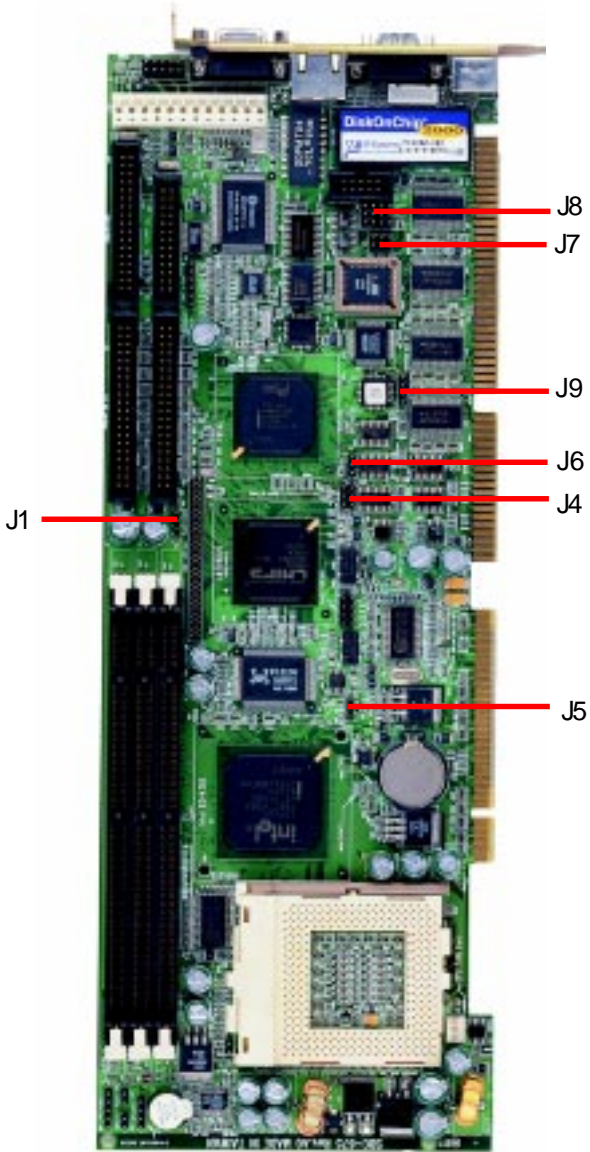

# Locating connectors

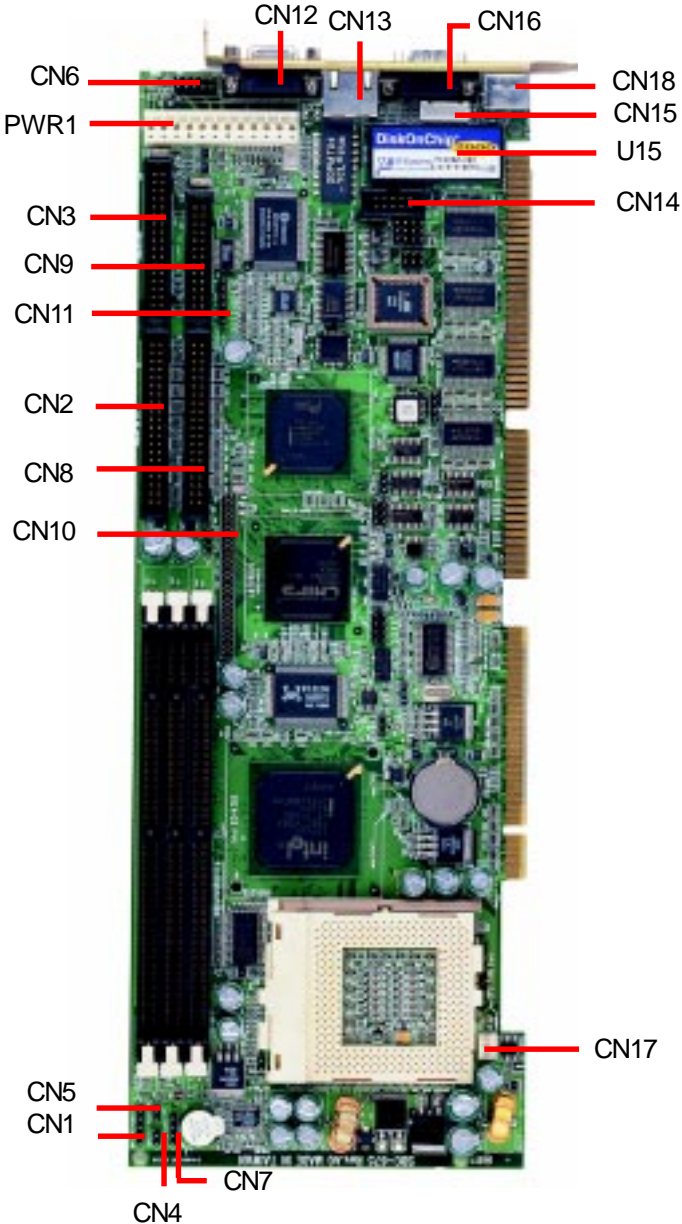



## Setting jumpers

---

You can configure your card to match the needs of your application by setting jumpers. A jumper is the simplest kind of electric switch. It consists of two metal pins and a small metal clip (often protected by a plastic cover) that slides over the pins to connect them. To “close” a jumper you connect the pins with the clip. To “open” a jumper you remove the clip. Sometimes a jumper will have three pins, labeled 1, 2, and 3. In this case you would connect either pins 1 and 2 or 2 and 3.

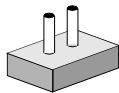

**Open**

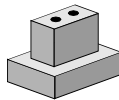

**Closed**

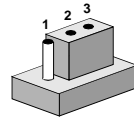

**Closed 2-3**

The jumper settings are schematically depicted in this manual as follows:



**Open**



**Closed**



**Closed 2-3**

A pair of needle-nose pliers may be helpful when working with jumpers.

If you have any doubts about the best hardware configuration for your application, contact your local distributor or sales representative before you make any changes.

## CPU installing and upgrading

---

You can upgrade to a more powerful Celeron CPU at any time. Simply remove the old CPU, install the new one, and set the jumpers for the new CPU speed.

**Warning!** *Always disconnect the power cord from your chassis when you are working on it. Do not make connections while the power is on as sensitive electronic components can be damaged by the sudden rush of power. Only experienced electronics personnel should open the system chassis.*



**Caution!** *Always ground yourself to remove any static charge before touching the system board. Modern electronic devices are very sensitive to static electric charges. Use a grounding wrist strap at all times. Place all electronic components on a static-dissipative surface or in a static-shielded bag when they are not in the chassis.*



### Instala a CPU in the ZIF socket

SBC-675 Series provides a Zero Insertion Force (ZIF) socket for easy CPU installation.

1. Make sure the ZIF socket lever is in the upright position. To raise the lever, pull it out to the side a little and raise it as far as it will go.
2. Place the CPU in the empty socket. Follow the instructions that came with the CPU. If you have no instructions, do the following: Carefully align the CPU so it is parallel to the socket and the notch on the corner of the CPU corresponds with the notch on the inside of the socket. Gently slide the CPU in. It should insert easily. If it doesn't, pull the lever up a little more.

3. Press the lever down. The plate will slide forward. You will feel some resistance as the pressure starts to secure the CPU in the socket. This normal and won't damage the CPU.

When the CPU is installed, the lever should snap into place at the side of the socket.

**Note:** To remove a CPU, pull the lever out to the side a little and raise it as far as it will go. Lift out the CPU chip.

When you install a new CPU, be sure to adjust the board settings, such as CPU type and CPU clock. **Improper settings may damage the CPU.**

# Installing DRAM (DIMMs)

---

## System Memory

The left edge of the SBC-675 contains three sockets for 168-pin dual inline memory module (DIMM). The socket uses 3.3 V unbuffered synchronous DRAM (SDRAM). DIMM is available in capacities of 16, 32, 64, or 128 MB. The socket can be filled in the DIMM of any size, giving your SBC-675 single board computer between 16 and 128 MB of memory.

## Supplementary information about DIMM

Your SBC-675 can accept both regular and PC-100 SDRAM DIMM Module(with or without parity). However, if the Celeron with 100MHz FSB CPU is used. The SBC-675 can only accept PC-100 SDRAM DIMM Module.

Single-sided modules are typically 16 or 64 MB; double-sided modules are usually 32 or 128 MB.

## Memory Installation Procedures

To install DIMM, first make sure the two handles of the DIMM socket are in the "open" position. i.e. The handles remain outward. Slowly slide the DIMM module along the plastic guides on both ends of the socket. Then press the DIMM module right down into the socket, until you hear a click. This is when the two handles have automatically locked the memory module into the correct position of the DIMM socket. (See Figure below) To take away the memory module, just push both handles outward, and the memory module will be ejected by the mechanism in the socket.

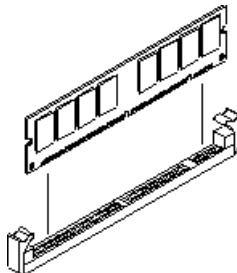

## **Cache memory**

---

Since the second level cache has been embedded into the Celeron CPU, you do not have to take care of either SRAM chips or SRAM modules. The built-in second level cache in the Celeron yields much higher performance than the external cache memories. The cache size in the Celeron CPU is either 128 KB.

## LCD driving voltage select (J1)

---

You can select the LCD connector CN10 (pin 5 and pin 6) driving voltage by setting J1. The configurations are as follows:

---

### LCD driving voltage select (J1)

---

	<b>5V</b>	<b>3.3V *</b>
J1		

\*default

## Clear CMOS (J5)



---

You can use J5 to clear the CMOS data if necessary. To reset the CMOS data, set J5 to 2-3 closed for just a few seconds, and then move the jumper back to 1-2 closed.

---

### Clear CMOS (J5)

---

	<b>Protect*</b>	<b>Clear CMOS</b>
J5		

\*default

# CPU frequency ratio select (J4)

CPU core frequency = CPU frequency ratio (2~5.5) \* External bus clock (66 or 100 MHz)

## CPU frequency ratio select (J4)

2x			2.5x			3x		
1	3	5	1	3	5	1	3	5
<input checked="" type="checkbox"/>	<input type="checkbox"/>	<input type="checkbox"/>	<input checked="" type="checkbox"/>	<input type="checkbox"/>	<input checked="" type="checkbox"/>	<input checked="" type="checkbox"/>	<input checked="" type="checkbox"/>	<input type="checkbox"/>
2	4	6	2	4	6	2	4	6
<input type="checkbox"/>	<input type="checkbox"/>	<input type="checkbox"/>	<input type="checkbox"/>	<input type="checkbox"/>	<input type="checkbox"/>	<input type="checkbox"/>	<input type="checkbox"/>	<input type="checkbox"/>
3.5x			4x			4.5x*		
1	3	5	1	3	5	1	3	5
<input checked="" type="checkbox"/>	<input checked="" type="checkbox"/>	<input checked="" type="checkbox"/>	<input type="checkbox"/>	<input type="checkbox"/>	<input type="checkbox"/>	<input type="checkbox"/>	<input type="checkbox"/>	<input checked="" type="checkbox"/>
2	4	6	2	4	6	2	4	6
<input type="checkbox"/>	<input type="checkbox"/>	<input type="checkbox"/>	<input type="checkbox"/>	<input type="checkbox"/>	<input type="checkbox"/>	<input type="checkbox"/>	<input type="checkbox"/>	<input type="checkbox"/>
5x			5.5x					
1	3	5	1	3	5			
<input type="checkbox"/>	<input checked="" type="checkbox"/>	<input type="checkbox"/>	<input type="checkbox"/>	<input checked="" type="checkbox"/>	<input checked="" type="checkbox"/>			
2	4	6	2	4	6			
<input type="checkbox"/>	<input type="checkbox"/>	<input type="checkbox"/>	<input type="checkbox"/>	<input type="checkbox"/>	<input type="checkbox"/>			

\*default

## Celeron CPU jumper setting examples

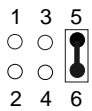
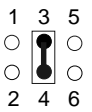
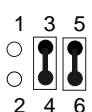
Celeron CPU	J4
300MHz	 <p>1 3 5 ○ ○ ○ ○ ○ ○ 2 4 6</p>
333MHz	 <p>1 3 5 ○ ○ ○ ○ ○ ○ 2 4 6</p>
366MHz	 <p>1 3 5 ○ ○ ○ ○ ○ ○ 2 4 6</p>

### Note:

Most Celeron CPUs' frequency ratio are pre-locked within the CPUs. These CPUs run at fixed speed (frequency) regardless of the configurations listed above.

If the CPU you are using requires higher ratio then 5.5X, it is most likely pre-locked.



## LCD clock signal select (J6)

You can select the LCD control signal by setting J6. The following charts show the available option.

### LCD clock signal select (J6)















	SFCLK-*	SHCLK
J6		

\*default

## COM2 RS-232/422/485 select (J7, J8)

The SBC-675 COM2 serial port can be selected as RS-232, RS-422, or RS-485 by setting J7 & J8.

### COM2 Select (J7, J8)

	RS-232*	RS-422	RS-485
J8	12 ○  10 9 ○  7 6 ○  4 3 ○  1	12  ○ 10 9  ○ 7 6  ○ 4 3  ○ 1	12  ○ 10 9  ○ 7 6  ○ 4 3  ○ 1
J7	5 ○ ○ 6 3 ○ ○ 4 1  2	5 ○ ○ 6 3  4 1 ○ ○ 2	5  6 3 ○ ○ 4 1 ○ ○ 2

\*default

## DOC address select (J9)

---

The DiskOnChip 2000 occupies an 8 Kbyte window in the upper memory address range of D400 to E000. You should ensure this does not conflict with any other device's memory address. J9 controls the memory address of the Flash disk.

---

DiskOnChip 2000 memory address (J9)

---

**Memory address (HEX)**

---

DISABLE

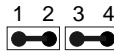

---

DC00

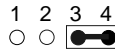

---

D400

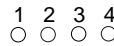

---

D800\*

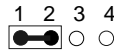

---

\* default

These addresses might conflict with the ROM BIOS of other peripheral boards. Please select the appropriate memory address to avoid memory conflicts.

## Power connectors (PWR1, CN17)

---

### Power connector (PWR1)

The power supply uses 12-pin connector shown below. Make sure you plug in the right direction.

---

ATX power connector (PWR1)

---

Pin	Signal
1	N.C.
2	+5V
3	+12V
4	-12V
5	GND
6	GND
7	GND
8	GND
9	-5V
10	+5V
11	+5V
12	+5V

---

### CPU fan power connector (CN17)

Plug in the fan cable to the 3-pin fan connector onboard. The fan connector is marked CN17.

---

CPU fan power connector (CN17)

---

Pin	Signal
1	Fan speed sense
2	+12V
3	GND

---

## Power LED and Keylock (CN1)

---

You can use an LED to indicate when the CPU card is on. Pin1 of CN1 supplies the LED's power, and Pin3 is the ground.

You can use a switch (or a lock) to disable the keyboard so the PC will not respond to any input. This is useful if you do not want anyone to change or stop a running program. Connect the switch between Pin 4 and 5 of CN1.

---

### Power LED and keylock (CN1)

---

<b>Pin</b>	<b>Function</b>
1	LED power (Vcc)
2	N.C.
3	GND
4	Keyboard lock
5	GND

---

## **IDE hard drive connector (CN2, CN8)**

---

You can attach up to four Enhanced Integrated Device Electronics hard disk drives to the mainboard's internal controller. The mainboard's IDE controller uses a PCI local-bus interface. This advanced interface supports faster data transfer and allows the IDE hard drive to exceed 528 MB.

### **Connecting the hard drive**

Connecting drives is done in a daisy-chain fashion and requires one of two cables, depending on the drive size.

Wire number 1 on the cable is normally red or blue, and the other wires are usually gray.

1. Connect one end of the cable to CN2 or CN8. Make sure that the red (or blue) wire corresponds to pin 1 on the connector, which is labeled on the board (on the right side).
2. Plug the other end of the cable to the Enhanced IDE hard drive, with pin 1 on the cable corresponding to pin 1 on the hard drives. (see your hard drive's documentation for the location of the connector).

Connect a second drive as described above.

Unlike floppy drives, IDE hard drives can connect to either end of the cable. If you install two drives, you will need to set one as the master and the other one as the slave by using jumpers on the drives. If you install just one drive, set it as the master.

## IDE hard drive connectors (CN2, CN8)

IDE hard drive connectors (CN2, CN8)

Pin	Signal	Pin	Signal
1	IDE RESET	2	GND
3	DATA 7	4	DATA 8
5	DATA 6	6	DATA 9
7	DATA 5	8	DATA 10
9	DATA 4	10	DATA 11
11	DATA 3	12	DATA 12
13	DATA 2	14	DATA 13
15	DATA 1	16	DATA 14
17	DATA 0	18	DATA 15
19	SIGNAL GND	20	N/C
21	N/C	22	GND
23	IO WRITE	24	GND
25	IO READ	26	GND
27	IO CHANNEL READY	28	ALE
29	N/C	30	GND
31	IRQ14	32	IOCS16
33	ADDR 1	34	N/C
35	ADDR 0	36	ADDR 2
37	HARDDISK SELECT 0	38	HARDDISK SELECT 1
39	IDE ACTIVE	40	MGND

## **Floppy drive connector (CN3)**

---

You can attach up to two floppy drives to the mainboard controller. You can use any combination of 5¼" (360 KB and 1.2 MB) and/or 3½" (720 KB, 1.44 MB, and 2.88 MB) drives.

A 34-pin daisy-chain drive connector cable is required for a dual-drive system. On one end of the cable is a 34-pin flat-cable connector. On the other end are two sets of floppy disk drive connectors. Each set consists of a 34-pin flat-cable connector (usually used for 3½" drives) and a printed-circuit board connector (usually used for 5¼" drives).

Wire number 1 on the cable is normally red or blue, and the other wires are usually gray.

### **Connecting the floppy drive**

1. Plug the 34-pin flat-cable connector into CN3. Make sure that the red or blue wire corresponds to pin 1 on the connector.
2. Attach the appropriate connector on the other end of the cable to the floppy drive(s). You can use only one connector in the set. The set on the end (after the twist in the cable) connects to the A: drive. The set in the middle connects to the B: drive.
3. If you are connecting a 5¼" floppy drive, line up the slot in the printed circuit board with the blocked-off part of the cable connector.

If you are connecting a 3½" floppy drive, you may have trouble determining which pin is pin number 1. Look for a number printed on the circuit board indicating pin number 1. Also, the connector on the floppy drive connector may have a slot. When the slot is up, pin number 1 should be on the right. Check the documentation that came with the drive for more information.

If you desire, connect the B: drive to the connectors in the middle of the cable as described above.

## Floppy drive connector (CN3)

Floppy drive connector (CN3)

Pin	Signal	Pin	Signal
1	GND	2	DENSITY SELECT
3	GND	4	N/C
5	GND	6	DRIVE TYPE
7	GND	8	INDEX
9	GND	10	MOTOR 0
11	GND	12	DRIVE SELECT 1
13	GND	14	DRIVE SELECT 2
15	GND	16	MOTOR 1
17	GND	18	DIRECTION
19	GND	20	STEP
21	GND	22	WRITE DATA
23	GND	24	WRITE GATE
25	GND	26	TRACK 0
27	GND	28	WRITE PROTECT
29	GND	30	READ DATA
31	GND	32	HEAD DELECT
33	GND	34	DISK CHANGE



## Hard drive LED (CN4)

---

You can connect an LED to CN4 to indicate when the HDD is active.

---

Hard drive LED (CN4)

---

Pin	Function
1	HD-LED+
2	HD-LED-

---

## Reset switch (CN5)

---

You can connect an external switch to easily reset your computer. This switch restarts your computer as if you had turned off the power, then turned it back on.

## USB connector (CN6)

---

The SBC-675 provides two USB (Universal Serial Bus) interfaces, which give complete plug and play, hot attach/detach for up to 127 external devices. The USB interfaces comply with USB specification Rev. 1.0, and can be disabled in the system BIOS setup.

---

USB connector (CN6)

---

Pin	Function	Pin	Function
1	Vcc	6	Vcc
2	USBDO-	7	USB1-
3	USBDO+	8	USB1+
4	GND	9	GND
5	GND	10	N.C.

---

# External speaker (CN7)

The CPU card has its own buzzer. You can also connect to the external speaker on your computer chassis. Pin assignments for CN7 are shown below:

---

## External speaker (CN7)

Pin	Function
1	Vcc (For external speaker use)
2	Speaker- (For external speaker use)
3	Internal Buzzer *
4	Speaker- *

\* default

---

## External speaker (CN7)

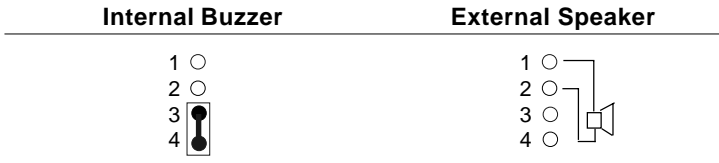

## Parallel port connector (CN9)

---

Normally, the parallel port is used to connect the board to a printer. The mainboard includes an onboard parallel port, accessed through CN9, a 26-pin flat-cable connector. You need an adapter cable if you use a traditional DB-25 connector. The cable has a 26-pin connector on one end and a DB-25 connector on the other.

### Parallel port IRQ

The mainboard supports one parallel port. The port is designated as LPT1 and can be disabled or changed to LPT2 or LPT3 in the system BIOS setup.

### Parallel port connector table (CN9)

---

Parallel port connector (CN9)

---

Pin	Signal	Pin	Signal
1	/STROBE	2	\AUTOFD
3	DO	4	ERR
5	D1	6	\INIT
7	D2	8	\SLCTINI
9	D3	10	GND
11	D4	12	GND
13	D5	14	GND
15	D6	16	GND
17	D7	18	GND
19	\ACK	20	GND
21	BUST	22	GND
23	PE	24	GND
25	SLCT	26	N/C

---

## IrDA connector (CN11)

---

The IrDA connector (CN11) can be configured to support wireless infrared module, with this module and application software such as laplink or Win95 Direct Cable connection, user can transfer files to or from laptops, notebooks, PDA, and printers. This connector supports HPSIR (115.2Kbps, 2 meters), ASK-IR (56Kbps) and Fast IR (4Mbps, 2 meters).

Install infrared module onto IrDA connector and enable infrared function from BIOS setup. Make sure to have correct orientation when you plug onto IrDA connector (CN11).

---

### IrDA connector (CN11)

---

<b>Pin</b>	<b>Signal</b>
1	Vcc
2	FIRx
3	IRx
4	GND
5	IRTx
6	CIrRx

---

## Display connectors (CN12, CN10)

---

The mainboard's PCI SVGA interface can drive conventional CRT displays and is capable of driving a wide range of flat panel displays, including electroluminescent (EL), gas plasma, passive LCD, and active LCD displays. The board has two connectors to support these displays, one for standard CRT VGA monitors and one for flat panel displays.

### VGA display connector (CN12)

---

VGA display connector (CN12)

---

Pin	Signal
1	Red video
2	Green video
3	Blue video
4	Not used
5	GND
6	Red return (GND)
7	Green return (GND)
8	Blue return (GND)
9	Key (on pin)
10	Sync return (GND)
11	Monitor ID (not used)
12	Monitor ID
13	Horizontal sync
14	Vertical sync
15	Not used

---

## LCD display connector (CN10)

CN10 is a 50-pin, dual-in-line header used for flat panel displays.

When the mainboard's power is applied, the control signal is low until just after the relevant flat panel signals are present.

Configuration of the VGA interface is done completely via the software utility. You do not have to set any jumpers.

LCD display connector (CN10)			
Pin	Signal	Pin	Signal
1	+12 V <sub>DC</sub>	2	+12 V <sub>DC</sub>
3	GND	4	GND
5	+5 V <sub>DC</sub>	6	+5 V <sub>DC</sub>
7	ENAVEE	8	GND
9	P0	10	P1
11	P2	12	P3
13	P4	14	P5
15	P6	16	P7
17	P8	18	P9
19	P10	20	P11
21	P12	22	P13
23	P14	24	P15
25	P16	26	P17
27	P18	28	P19
29	P20	30	P21
31	P22	32	P23
33	P24	34	P25
35	SHF CLK	36	FLM (V SYS)
37	M	38	LP (H SYS)
39	GND	40	ENABKL
41	P26	42	P27
43	P28	44	P29
45	P30	46	P31
47	P32	48	P33
49	P34	50	P35

## 100Base-Tx Ethernet connector (CN13)

---

This 100Base-Tx Ethernet connector CN13 is a standard RJ-45 connector.

The onboard Realtek RTL8139B fast Ethernet controller supports 10Mb/s and 100 Mb/s N-way auto-negotiation operation.

## Serial ports (CN16, CN14)

---

The SBC-675 offers two serial ports, one RS-232 (CN16) and one RS-232/422/485 (CN14). These ports allow you to connect them to serial devices (mouse, printers, etc.).

### COM2 RS-232/422/485 serial ports (CN14)

---

COM2 RS-232/422/485 serial port (CN14)

	PIN	SIGNAL	PIN	SIGNAL
COM2	1	DCDB (422TXD-/485DATA-)	6	DSRB
	2	RXDB (422TXD+/485DATA+)	7	RTSB
	3	TXDB (422RXD+)	8	CTSB
	4	DTRB (422RXD-)	9	RIB
	5	GND	10	N.C.

## Keyboard and PS/2 mouse connector (CN18, CN15)

---

The mainboard provides a keyboard connector which supports both a keyboard and a PS/2 style mouse. In most cases, especially in embedded applications, a keyboard is not used. The standard PC/AT BIOS will report an error or fail during power-on-self-test (POST) after a reset if the keyboard is not present. The mainboard BIOS Advanced setup menu allows you to select "Present" or "Absent" under the "System Keyboard" section. This allows no-keyboard operation in embedded system applications without the system halting under POST (power-on-self-test).

---

### Keyboard and PS/2 mouse connector (CN18)

---

Pin	Signal
1	KB DATA
2	MS DATA
3	GND
4	Vcc
5	KB CLOCK
6	MS CLOCK

---

---

### Internal keyboard connector (CN15)

---

Pin	Signal
1	KB CLOCK
2	KB DATA
3	N.C.
4	GND
5	Vcc

---



## DiskOnChip socket (U15)

The DiskOnChip 2000 family of products provides a single chip solid-state flash disk in a standard 32-pin DIP package. The DiskOnChip 2000 is a solid-state disk with no moving parts, resulting in a significant reduction in power consumption and an increase in reliability. The DiskOnChip is a small plug and play Flash disk. It is easy to use. And it saves integration overhead.

The DiskOnChip 2000 family of products is available in capacities ranging from 2MB up to 144MB, unformatted. In order to manage the disk, the DiskOnChip 2000 includes the TrueFFS, M-Systems Flash File System proprietary software. The DiskOnChip 2000 package is pin-to-pin compatible with a standard 32-pin EPROM device.

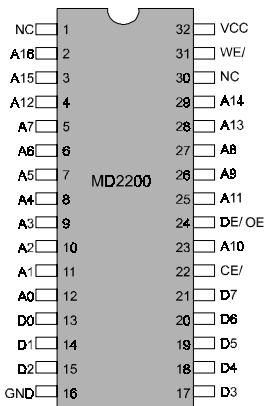

pin Name	Description	Pin Number	Direction	Note
A0-A12	Address bus	4-12,23,25-27	Inputs	
A13-A16	Address bus	2,3,28,29	Inputs	1
D0-D7	Data bus	13-15,17-21	I/O	
CE/	Chip Enable	22	Input	
OE/	Output Enable	24	Input	
WE/	Write Enable	31	Input	
NC	Not connected	1,30		2
VCC	Power	32		
GND	Ground	16		

Note 1: Pins A13 through A16 are not used by the MD2200. They are kept for socket backward compatibility with ED 1100 (DiskOnChip 1000)

Note 2: Pins 1 and 30 are not used by MD2200

# DiskOnChip (DOC) 2000 Installation

---

When the DOC is installed correctly, a DOC will work like an HDD or an FDD. To install the DOC on the mainboard, follow the instructions below:

1. Plug the DOC into the socket. Make sure pin 1 of the DOC is aligned with pin 1 of the socket.
2. Push the DOC into the socket until it is firmly seated in the socket.

**Caution: the DOC may be permanently damage if it is installed incorrectly.**

3. Set the jumper for the memory address of the DOC.

**Note:**

**The memory shadow function sometimes will create conflicts with the memory window. You should disable the memory shadow from the BIOS SETUP if the DOC cannot be accessed.**

**Configure DOC as a boot device**

To configure a DOC as a boot drive, you should copy the operating system files onto the DOC. The following procedure is an example of the initialization process.

1. Install a DOC into your system.
2. Insert a bootable floppy disk in drive A: and boot the system.
3. At the DOS prompt, type **SYS C:** to transfer the DOS system files to the DOC (assuming the DiskOnChip is installed as drive C:). Reboot the system.
4. Go to the BIOS Setup Utility by hitting the <DEL> key. Set the type of Primary Master or C: Drive as *Not Installed*.
5. Remove the floppy disk from the drive A: and leave the BIOS Setup Utility. The system should boot from the DOC.



## **Award BIOS Setup**

This chapter describes how to configure the BIOS for the system.

# Starting setup

---

The Award BIOS is immediately activated when you first turn on the computer. The BIOS reads system configuration information in CMOS RAM and begins the process of checking out the system and configuring it through the power-on self test (POST).

When these preliminaries are finished, the BIOS seeks an operating system on one of the data storage devices (hard drive, floppy drive, etc.). The BIOS launches the operating system and hands control of system operations to it.

During POST, you can start the Setup program in one of two ways:  
1. By pressing Del immediately after switching the system on, or  
2. By pressing Del or pressing Ctrl-Alt-Esc when the following message appears briefly at the bottom of the screen during POST:

TO ENTER SETUP BEFORE BOOT PRESS DEL KEY

If the message disappears before you respond and you still wish to enter Setup, restart the system to try again by turning it OFF then ON or pressing the RESET button on the system case. You may also restart by simultaneously pressing Ctr-Alt-Del. If you do not press the keys at the correct time and the system does not boot, an error message appears and you are again asked to

PRESS F1 TO CONTINUE, DEL TO ENTER SETUP

## Setup keys

---

These keys help you navigate in Setup:

Up arrow	Move to previous item
Down arrow	Move to next item
Left arrow	Move to the item in the left hand
Right arrow	Move to the item in the right hand
Esc	Main Menu: Quit and not save changes into CMOS RAM Other pages: Exit current page and return to Main Menu
PgDn/+	Increase the numeric value or make changes
PgDn/-	Decrease the numeric value or make changes
F1	General help, only for Status Page Setup Menu and Option Page Setup Menu
F2	Change color from total 16 colors. F2 to select color forward, Shift-F2 to select color backward
F3	Calendar, only for Status Page Setup Menu
F4	Reserved
F5	Restore the previous CMOS value from CMOS, only for Option Page Setup Menu
F6	Load the default CMOS RAM value from BIOS default table, only for Option Page Setup Menu
F7	Load the default
F8	Reserved
F9	Reserved
F10	Save all the CMOS changes, only for Main Menu

## Getting help

---

Press F1 to pop up a small help window that describes the appropriate keys to use and the possible selections for the highlighted item. To exit the Help Window press Esc or the F1 key again.

### In Case of Problems

If, after making and saving system changes with Setup, you discover that your computer no longer is able to boot, the **Award-BIOS** supports an override to the CMOS settings that resets your system to its default configuration.

You can invoke this override by immediately pressing Insert; when you restart your computer. You can restart by either using the ON/OFF switch, the RESET button or by pressing Ctrl-Alt-Delete.

The best advice is to alter only settings that you thoroughly understand. In particular, do not change settings in the Chipset screen without a good reason. The Chipset defaults have been carefully chosen by Award Software or your system manufacturer for the best performance and reliability. Even a seemingly small change to the Chipset setup may causing the system to become unstable.

# Main setup Menu



Standard CMOS	Options in the original PC AT-compatible BIOS.
BIOS Features	Award Software enhanced BIOS options.
Chipset Features	Options specific to your system chipset.
Power Management	Advanced Power Management (APM) options.
PnP/PCI Configuration	Plug and Play standard and PCI Local Bus configuration options.
Integrated Peripherals	I/O subsystems that depend on the integrated peripherals controller in your system.
Supervisor/User Password Setting	Change, set, or disable a password. In BIOS versions that allow separate user and supervisor passwords, only the supervisor password permits access to Setup. The user password generally allows only power-on access.
IDE HDD Auto Detection	Automatically detect and configure IDE hard disk parameters.



Load BIOS Defaults	BIOS defaults are factory settings for the most stable, minimal-performance system operations.
Load Setup Defaults	Setup defaults are factory settings for optimal-performance system operations.
Save & Exit Setup	Save settings in nonvolatile CMOS RAM and exit Setup.
Exit Without Save	Abandon all changes and exit Setup.

# Standard CMOS setup



When you choose the STANDARD CMOS SETUP option from the INITIAL SETUP SCREEN menu, the screen below is displayed.



This standard setup menu allows users to configure system components such as the date, time, hard disk drive, floppy drive, display, and memory. Online help for each field can be accessed by pressing F1.

### **Date and Time Configuration**

The BIOS determines the day of the week from the other date information. This field is for information only.

Press the left or right arrow key to move to the desired field (date, month, year). Press the PgUp/- or PgDn/+ key to increment the setting, or type the desired value into the field.

The time format is based on the 24-hour military-time clock. For example, 1 p.m. is 13:00:00. Press the left or right arrow key to move to the desired field. Press the PgUp/- or PgDn/+ key to increment the setting, or type the desired value into the field.

### **HARD DISKS**

The BIOS supports up to four IDE drives. This section does not show information about other IDE devices, such as a CD-ROM drive, or about other hard drive types, such as SCSI drives.

***NOTE:** We recommend that you select type AUTO for all drives.*

The BIOS can automatically detect the specifications and optimal operating mode of almost all IDE hard drives. When you select type AUTO for a hard drive, the BIOS detects its specifications during POST, every time the system boots.

If you do not want to select drive type AUTO, other methods of

selecting the drive type are available:

1. Match the specifications of your installed IDE hard drive(s) with the preprogrammed values for drive types 1 through 45.
2. Select USER and enter values into each drive parameter field.
3. Use the IDE HDD AUTO DETECTION function in Setup.

Here is a brief explanation of drive specifications:

- **Type:** The BIOS contains a table of pre-defined drive types. Each defined drive type has a specified number of cylinders, number of heads, write precompensation factor, landing zone, and number of sectors. Drives whose specifications do not accommodate any pre-defined type are classified as type USER.
- **Size:** Disk drive capacity (approximate). Note that this size is usually slightly greater than the size of a formatted disk given by a disk-checking program.
- **Cyls:** Number of cylinders
- **Head:** Number of heads
- **Precomp:** Write precompensation cylinder
- **Landz:** Landing zone
- **Sector:** Number of sectors
- **Mode:** Auto, Normal, large, or LBA
  - **Auto:** The BIOS automatically determines the optimal mode.
  - **Normal:** Maximum number of cylinders, heads, and sectors supported are 1024, 16, and 63.
  - **Large:** For drives that do not support LBA and have more than 1024 cylinders.

- **LBA** (Logical Block Addressing): During drive accesses, the IDE controller transforms the data address described by sector, head, and cylinder number into a physical block address, significantly improving data transfer rates. For drives with greater than 1024 cylinders.

**Drive A**  
**Drive B**

Select the correct specifications for the diskette drive(s) installed in the computer.

None	No diskette drive installed
360K, 5.25 in	5-1/4 inch PC-type standard drive; 360 kilobyte capacity
1.2M, 5.25 in	5-1/4 inch AT-type high-density drive; 1.2 megabyte capacity
720K, 3.5 in	3-1/2 inch double-sided drive; 720 kilobyte capacity
1.44M, 3.5 in	3-1/2 inch double-sided drive; 1.44 megabyte capacity
2.88M, 3.5 in	3-1/2 inch double-sided drive; 2.88 megabyte capacity

**LCD & CRT**

This field may appear as an alternative to the Video field. Select your video display device:

LCD	Liquid crystal display
CRT	Auxiliary monitor
Both	Display on both devices

**Pannel:**

This selection item allows user to select LCD BIOS to match the LCD types. There are eight LCD types available for users to select as their LCD display modes as below:

Brand name	Model name	Format
Sharp	LX 15X80	1024 x 768 DSTN
Sharp	LM 64183P	640 x 480 MONO
Sharp	LM 64C35P	640 x 480 DSTN
Sharp	LM 12S40	800 x 600 DSTN
NEC	NL 6448AC33-10	640 x 480 TFT (12 bits)
Toshiba	LTM 10C209A	640 x 480 (18 bits) TFT
NEC	NL 8060AC26-04	800 x 600 TFT
Sharp	14x03	1024x768 TFT (36 bits)

### **Halt On**

During the power-on-self-test (POST), the computer stops if the BIOS detects a hardware error. You can tell the BIOS to ignore certain errors during POST and continue the boot-up process. These are the selections:

- **No errors:** POST does not stop for any errors.
- **All errorsIf:** the BIOS detects any non-fatal error, POST stops and prompts you to take corrective action.
- **All, But Keyboard:** POST does not stop for a keyboard error, but stops for all other errors.All, But DiskettePOST does not stop for diskette drive errors, but stops for all other errors.
- **All, But Disk/Key:** POST does not stop for a keyboard or disk error, but stops for all other errors.

### **Memory**

You cannot change any values in the Memory fields; they are only for your information. The fields show the total installed random access memory (RAM) and amounts allocated to base memory, extended memory, and other (high) memory. RAM is counted in kilobytes (KB: approximately one thousand bytes) and megabytes (MB: approximately one million bytes).

RAM is the computer's working memory, where the computer stores programs and data currently being used, so they are accessible to the CPU. Modern personal computers may contain up to 64 MB, 128 MB, or more.

#### **•Base Memory**

Typically 640 KB. Also called conventional memory. The DOS operating system and conventional applications use this area.

•**Extended Memory**

Above the 1-MB boundary. Early IBM personal computers could not use memory above 1 MB, but current PCs and their software can use extended memory.

•**Other Memory**

Between 640 KB and 1 MB; often called High memory. DOS may load terminate-and-stay-resident (TSR) programs, such as device drivers, in this area, to free as much conventional memory as possible for applications. Lines in your CONFIG.SYS file that start with LOADHIGH load programs into high memory.



# BIOS features setup



By choosing the BIOS FEATURES SETUP option from the INITIAL SETUP SCREEN menu, the screen below is displayed.



The displayed configuration is based on the manufacturer's SETUP DEFAULTS settings.

### **Virus Warning**

When enabled, you receive a warning message if a program (specifically, a virus) attempts to write to the boot sector or the partition table of the hard disk drive. You should then run an anti-virus program. Keep in mind that this feature protects only the boot sector, not the entire hard drive.

*NOTE: Many disk diagnostic programs that access the boot sector table can trigger the virus warning message. If you plan to run such a program, we recommend that you first disable the virus warning.*

### **CPU Internal Cache/External Cache**

Cache memory is additional memory that is much faster than conventional DRAM (system memory). CPUs from 486-type and up contain internal cache memory, and most, but not all, modern PCs have additional (external) cache memory. When the CPU requests data, the system transfers the requested data from the main DRAM into cache memory, for even faster access by the CPU.

The External Cache field may not appear if your system does not have external cache memory.

### **CPU L2 Cache ECC Checking**

When you select Enabled, memory checking is enable when the external cache contains ECC SRAMs.

### **Quick Power On Self Test**

Select Enabled to reduce the amount of time required to run the power-on-self-test (POST). A quick POST skips certain steps. We recommend that you normally disable quick POST. Better to find a problem during POST than lose data during your work.

### **Boot Sequence**

The original IBM PCs loaded the DOS operating system from drive A (floppy disk), so IBM PC-compatible systems are designed to search for an operating system first on drive A, and then on drive C (hard disk). However, the BIOS now offers many boot sequence options.

### **Swap Floppy Drive**

This field is effective only in systems with two floppy drives. Selecting enabled assigns physical drive B to logical drive A, and physical drive A to logical drive B.

### **Boot Up Floppy Seek**

When Enabled, the BIOS tests (seeks) floppy drives to determine whether they have 40 or 80 tracks. Only 360-KB floppy drives have 40 tracks; drives with 720 KB, 1.2 MB, and 1.44 MB capacity all have 80 tracks. Because very few modern PCs have 40-track floppy drives, we recommend that you set this field to Disabled to save time.

### **Boot Up NumLock Status**

Toggle between On or Off to control the state of the NumLock key when the system boots. When toggled On, the numeric keypad generates numbers instead of controlling cursor operations.

### **Gate A20 Option**

Gate A20 refers to the way the system addresses memory above 1 MB (extended memory). When set to Fast, the system chipset controls Gate A20. When set to Normal, a pin in the keyboard controller controls Gate A20. Setting Gate A20 to Fast improves system speed, particularly with OS/2 and Windows.

### **Security Option**

If you have set a password, select whether the password is required every time the System boots, or only when you enter Setup.

## **Shadow**

Software that resides in a read-only memory (ROM) chip on a device is called firmware. The AwardBIOS permits shadowing of firmware such as the system BIOS, video BIOS, and similar operating instructions that come with some expansion peripherals, such as, for example, a SCSI adaptor.

Shadowing copies firmware from ROM into system RAM, where the CPU can read it through the 16-bit or 32-bit DRAM bus. Firmware not shadowed must be read by the system through the 8-bit X-bus. Shadowing improves the performance of the system BIOS and similar ROM firmware for expansion peripherals, but it also reduces the amount of high memory (640 KB to 1 MB) available for loading device drivers, etc.

Enable shadowing into each section of memory separately. Many system designers hardwire shadowing of the system BIOS and eliminate a System BIOS Shadow option.

Video BIOS shadows into memory area C0000-C7FFF. The remaining areas shown on the BIOS Features Setup screen may be occupied by other expansion card firmware. If an expansion peripheral in your system contains ROM-based firmware, you need to know the address range the ROM occupies to shadow it into the correct area of RAM.

# CHIPSET features setup



By choosing the CHIPSET FEATURES SETUP option from the INITIAL SETUP SCREEN menu, the screen below is displayed.



The displayed configuration is based on the manufacturer's SETUP DEFAULTS settings.

This section allows you to configure the system based on the specific features of the installed chipset. This chipset manages bus speeds and access to system memory resources, such as SDRAM. It also coordinates communications between the conventional ISA bus and the PCI bus. It must be stated that these items should never need to be altered. The default settings have been chosen because they provide the best operating conditions for your system. The only time you might consider making any changes would be if you discovered that data was being lost while using your system.

Because of the complexity and technical nature of some of the options, not all of the options are described here.

#### **SDRAM RAS-to-CAS Delay**

This field lets you control the number of DCLKs between a Row Activate command and a read or write command.

#### **SDRAM RAS Precharge Time**

The precharge time is the number of cycles it takes for the RAS to accumulate its charge before DRAM refresh. If insufficient time is allowed, refresh may be incomplete and the DRAM may fail to retain data. This field applies only if synchronous DRAM is installed in the system.

#### **SDRAM CAS Latency Time**

When synchronous DRAM is installed, you can control the number of CLKs between when the SDRAMs sample a read command and when the controller samples read data from the SDRAMs. Do not reset this field from the default value specified by the system designer.

**SDRAM Precharge Control**

When Enabled, all CPU cycles to SDRAM result in an All Banks Precharge Command on the SDRAM interface.

**DRAM Data Integrity Mode**

Select Non-ECC or ECC (error-correcting code), according to the type of installed DRAM.

**System BIOS Cacheable**

Selecting Enabled allows caching of the system BIOS ROM at F0000h-FFFFFh, resulting in better system performance. However, if any program writes to this memory area, a system error may result.

**Video BIOS Cacheable**

Selecting Enabled allows caching of the video BIOS ROM at C0000h to C7FFFh, resulting in better video performance. However, if any program writes to this memory area, a system error may result.

**Video RAM Cacheable**

Selecting Enabled allows caching of the video memory (RAM) at A0000h to AFFFFh, resulting in better video performance. However, if any program writes to this memory area, a memory access error may result.

**8/16 Bit I/O Recovery Time**

The I/O recovery mechanism adds bus clock cycles between PCI-originated I/O cycles to the ISA bus. This delay takes place because the PCI bus is so much faster than the ISA bus.

These two fields let you add recovery time (in bus clock cycles) for 16-bit and 8-bit I/O.

**Memory Hole at 15M-16M**

You can reserve this area of system memory for ISA adapter ROM. When this area is reserved, it cannot be cached. The user information of peripherals that need to use this area of system memory usually discusses their memory requirements.

**Passive Release**

When Enabled, CPU to PCI bus accesses are allowed during passive release. Otherwise, the arbiter only accepts another PCI master access to local DRAM.

**Delayed Transaction**

The chipset has an embedded 32-bit posted write buffer to support delay transactions cycles. Select Enabled to support compliance with PCI specification version 2.1.

**Auto Detect DIMM/PCI Clk**

When the Auto Detect DIMM/PCI clk enable, the Utility will automatically detect the DIMM/PCI clock in your system.

**Spread Spectrum**

When the system clock generator pulses, the extreme values of the pulse generate excess EMI. Enabling pulse spectrum spread modulation changes the extreme values from spikes to flat curves, thus reducing EMI. This benefit may in some cases be outweighed by problems with timing-critical devices, such as a clock-sensitive SCSI device

**IN0-IN6(V)**

These fields display the current voltage of up to seven voltage input lines, if your computer contains a monitoring system.





The displayed configuration is based on the manufacturer's SETUP DEFAULTS settings.

### **Power Management**

This option allows you to select the type (or degree) of power saving for Doze, Standby, and Suspend modes.

This table describes each power management mode:

Max Saving	Maximum power savings. Only Available for SL CPUs. Inactivity period is 1 minute in each mode.
User Define	Set each mode individually. Select time-out periods in the section for each mode, below.
Min Saving	Minimum power savings. Inactivity period is 1 hour in each mode (except the hard drive).

### **PM Control by APM**

If Advanced Power Management (APM) is installed on your system, selecting Yes gives better power savings.

### **Video Off Method**

Determines the manner in which the monitor is blanked.

V/H SYNC+Blank	System turns off vertical and horizontal synchronization ports and writes blanks to the video buffer.
DPMS Support	Select this option if your monitor supports the Display Power Management Signaling (DPMS) standard of the Video Electronics Standards Association (VESA). Use the software supplied for your video subsystem to select video power management values.
Blank Screen	System only writes blanks to the video buffer.

### **Video Off After**

As the system moves from lesser to greater power-saving modes, select the mode in which you want the monitor to blank.

### **MODEM Use IRQ**

Name the interrupt request (IRQ) line assigned to the modem (if any) on your system. Activity of the selected IRQ always awakens the system.

### **Doze Mode**

After the selected period of system inactivity, the CPU clock throttles to a small percentage of its duty cycle — between 10 percent and 25 percent for most chipsets. All other devices still operate at full speed.

**Standby Mode**

After the selected period of system inactivity, the CPU clock stops, the hard drive enters an idle state, and the L2 cache enters a power-save mode. All other devices still operate at full speed.

**Suspend Mode**

After the selected period of system inactivity, the chipset enters a hardware suspend mode, stopping the CPU clock and possibly causing other system devices to enter power management modes.

**HDD Power Down**

After the selected period of drive inactivity, any system IDE devices compatible with the ATA-2 specification or later power manage themselves, putting themselves into an idle state after the specified timeout and then waking themselves up when accessed.

**Throttle Duty Cycle**

When the system enters Doze mode, the CPU clock runs only part of the time. You may select the percent of time that the clock runs.

**VGA Active Monitor**

When Enabled, any video activity restarts the global timer for Standby mode.

**Reload Global Timer Events**

When Enabled, an event occurring on each device listed below restarts the global timer for Standby mode.

IRQ3-7, 9-15, NMI

Primary IDE 0

Primary IDE 1

Secondary IDE 0

Secondary IDE 1

Floppy Disk

Serial Port

Parallel Port

# PNP/PCI configuration setup



By choosing the PNP/PCI CONFIGURATION SETUP option from the initial SETUP SCREEN menu, the screen below is displayed.

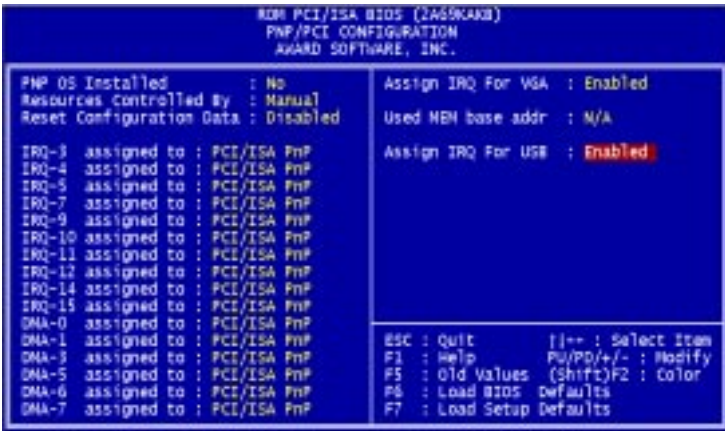

The displayed configuration is based on the manufacturer's SETUP DEFAULTS settings.

***NOTE:** This chapter describes all fields offered by Award Software in this screen. Your system board designer may omit or modify some fields.*

### **PNP OS Installed**

Select Yes if the system operating environment is Plug-and-Play aware (e.g., Windows 95).

### **Resources Controlled By**

The Plug and Play AwardBIOS can automatically configure all the boot and Plug and Play-compatible devices. If you select Auto, all the interrupt request (IRQ) and DMA assignment fields disappear, as the BIOS automatically assigns them.

### **Reset Configuration Data**

Normally, you leave this field Disabled. Select Enabled to reset Extended System Configuration Data (ESCD) when you exit Setup if you have installed a new add-on and the system reconfiguration has caused such a serious conflict that the operating system cannot boot.

### **IRQ n Assigned to**

When resources are controlled manually, assign each system interrupt as one of the following types, depending on the type of device using the interrupt:

Legacy ISA Devices compliant with the original PC AT bus specification, requiring a specific interrupt (such as IRQ4 for serial port 1).

PCI/ISA PnP Devices compliant with the Plug and Play standard, whether designed for PCI or ISA bus architecture.

**DMA n Assigned to**

When resources are controlled manually, assign each system DMA channel as one of the following types, depending on the type of device using the interrupt:

Legacy ISA Devices compliant with the original PC AT bus specification, requiring a specific DMA channel

PCI/ISA PnP Devices compliant with the Plug and Play standard, whether designed for PCI or ISA bus architecture.

**Assign IRQ for VGA**

If you are not using your system's VGA controller, select Disabled to free the IRQ resource.

**Used Mem base addr**

Select a base address for the memory area used by any peripheral that requires high memory.

**Assign IRQ for USB**

Select Enabled if your system has a USB controller and you have one or more USB devices connected. If you are not using your system's USB controller, select Disabled to free the IRQ resource.



# Load BIOS defaults/Load setup defaults

LOAD BIOS DEFAULTS loads the default system values directly from ROM. The BIOS DEFAULTS provides the most stable settings, though they do not provide optimal performance. LOAD SETUP DEFAULTS, on the other hand, provides for maximum system performance. If the stored record created by the setup utility becomes corrupted (and therefore unusable), BIOS defaults will load automatically when you turn the system on.

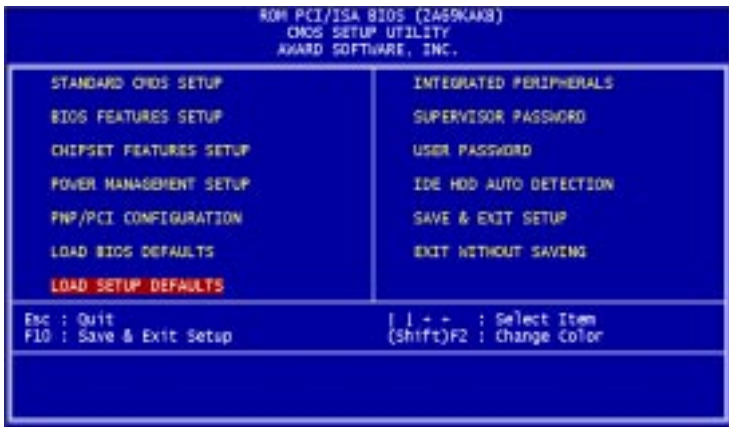
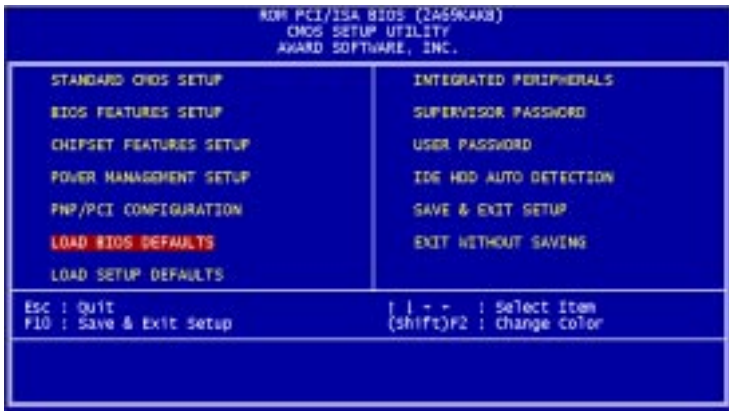

# Integrated peripherals setup



By choosing the INTEGRATED PERIPHERALS option from the initial SETUP SCREEN menu, the screen below is displayed.



The displayed configuration is based on the manufacturer's SETUP DEFAULTS settings.

#### **IDE HDD Block Mode**

Select Enabled only if your hard drives support block mode.

#### **IDE Primary/Secondary Master/Slave PIO**

The four IDE PIO (Programmed Input/Output) fields let you set a PIO mode (0-4) for each of up to four IDE devices that the internal PCI IDE interface supports. Modes 0 through 4 provide successively increased performance. In Auto mode, the system automatically determines the best mode for each device.

#### **IDE Primary /Secondary Master/Slave UDMA**

UDMA (Ultra DMA) is a DMA data transfer protocol that utilizes ATA commands and the ATA bus to allow DMA commands to transfer data at a maximum burst rate of 33 MB/s. When you select Auto in the four IDE UDMA fields (for each of up to four IDE devices that the internal PCI IDE interface supports), the system automatically determines the optimal data transfer rate for each IDE device.

#### **On-Chip PCI IDE Primary/Secondary**

The system chipset contains a PCI IDE interface with support for two IDE channels. Select Enabled to activate the primary and/or secondary IDE interface. Select Disabled to deactivate this interface, if you install a primary and/or secondary add-in IDE interface.

#### **USB Keyboard Support**

Select Enabled if your system contains a Universal Serial Bus (USB) controller and you have a USB keyboard.

#### **Onboard FDC Controller**

Select Enabled if your system has a floppy disk controller (FDC) installed on the system board and you wish to use it. If you install an add-in FDC or the system has no floppy drive, select Disabled in this field.

**Onboard Serial Ports (1, 2)**

Select a logical COM port address for the first and second serial ports.

**RxD, TxD Active**

Consult your IR peripheral documentation to select the correct setting of the TxD and RxD signals.

**ECP Mode Use DMA**

Select a DMA channel for the port.

**EPP Mode select**

Select EPP port type 1.7 or 1.9.

# Supervisor/User password setting

You can set either SUPERVISOR or USER PASSWORD, or both of them. The difference between the two is that the supervisor password allows unrestricted access to enter and change the options of the setup menus, while the user password only allows entry to the program, but not modify options.

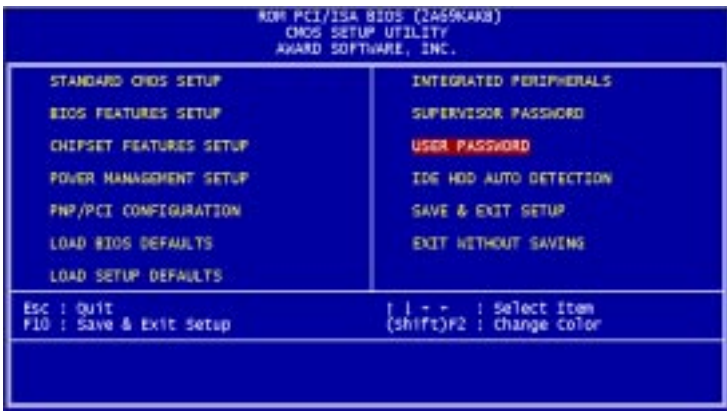

When you select this function, a message appears at the center of the screen:

### ENTER PASSWORD:

Type the password, up to eight characters, and press Enter. Typing a password clears any previously entered password from CMOS memory.

Now the message changes:

### CONFIRM PASSWORD:

Again, type the password and press Enter.

To abort the process at any time, press Esc.

In the Security Option item in the BIOS Features Setup screen, select System or Setup:

**System** Enter a password each time the system boots and when ever you enter Setup.

**Setup** Enter a password when ever you enter Setup.

***NOTE:** To clear the password, simply press Enter when asked to enter a password. Then the password function is disabled.*

## IDE HDD auto detection

The IDE HDD AUTO DETECTION utility can automatically detect the IDE hard disk installed in your system. You can use it to self-detect and/or correct the hard disk type configuration. You need to repeat the setup for each of the IDE combinations:

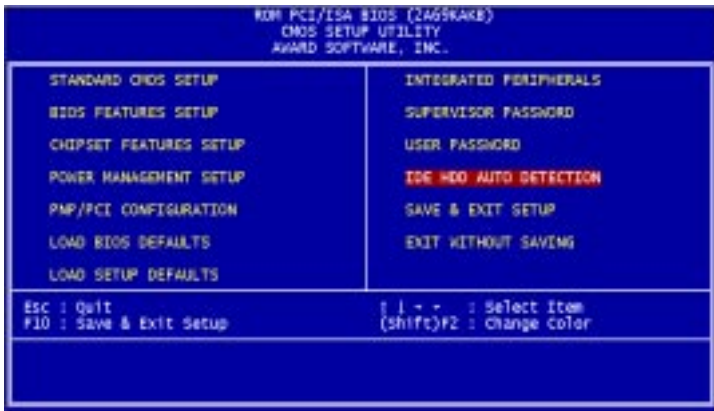

## Save & exit setup

---

If you select this option and press <ENTER>, the values entered in the setup utility will be recorded in the chipset's CMOS memory. The microprocessor will check this every time you turn your system on and compare this to what it finds as it checks the system. This record is required for the system to operate.

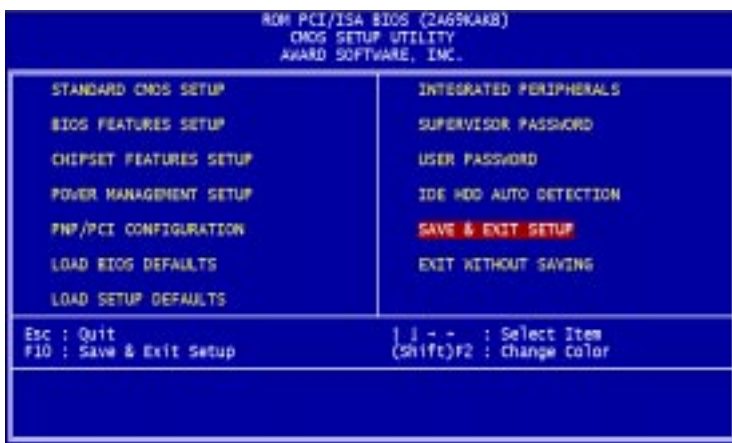





## **Flat Panel/CRT Controller Display Drivers and Utilities**

This chapter provides information about:

- Driver types and installation

## Software drivers

---

This chapter describes the operation and installation of the display drivers supplied on the *Supporting CD-ROM* that are shipped with your product.

The onboard VGA adapter is based on the CHIPS VGA Flat Panel/CRT controller and is fully IBM VGA compatible. This controller offers a large set of extended functions and higher resolutions. If you intend to use your VGA adapter in standard VGA modes only, you do not need to install any of these drivers. Since your VGA adapter is fully compatible, it does not require any special drivers to operate in standard modes.

The purpose of the enclosed software drivers is to take advantage of the extended features of the CHIPS VGA Flat Panel/CRT controller.

### Hardware configuration

Some of the high-resolution drivers provided in this package will work only in certain system configurations. If a driver does not display correctly, try the following:

1. Change the display controller to CRT-only mode, rather than flat panel or simultaneous display mode. Some high-resolution drivers will display correctly only in CRT mode.
2. If a high-resolution mode is not supported on your system, try using a lower-resolution mode. For example, 1024 x 768 mode will not work on some systems, but 800 x 600 mode is supported on most.

## **Necessary prerequisites**

The instructions in this manual assume that you understand elementary concepts of MS-DOS and the IBM Personal Computer. Before you attempt to install any driver or utility, you should:

- Know how to copy files from a CD-ROM to a directory on the hard disk
- Understand the MS-DOS directory structure

If you are uncertain about any of these concepts, please refer to the DOS or OS/2 user reference guides for more information *before* you proceed with the installation.

## **Before you begin**

Make sure you know the version of the application for which you are installing drivers. The *Supporting CD-ROM* contain drivers for several versions of certain applications. For your driver to operate properly, you must install the driver for your version of the application program.

# Windows® 95

These drivers are designed to work with Microsoft® Windows®. You just install these drivers through the Windows® operating system.

## Driver installation

1. Install Windows® 95 as you normally would for a VGA display. Click the **Start** button, go to **Settings** and click on **Control Panel**. Choose the **Display** icon and double click on the icon. In the *Display Properties* window, show as figure 1:

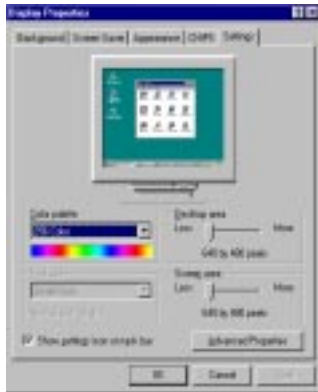

figure 1

Click the setting button, then click the Advanced Properties icon into the Advanced Display properties windows, show as figure2:

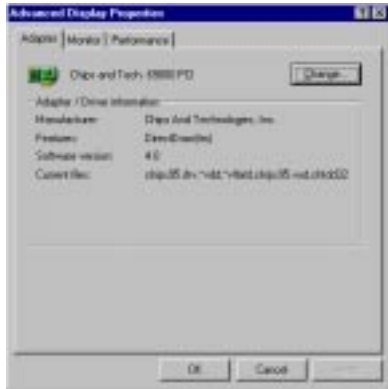

figure 2

click on **Change Display Type**. In the *Change Display Type* window, click on the **Change** button under Adapter Type into the select Device window show as figure(3):This will bring up the *Select Device* window.



figure 3

2. Place the *Supporting CD-ROM* in your CD-ROM drive.

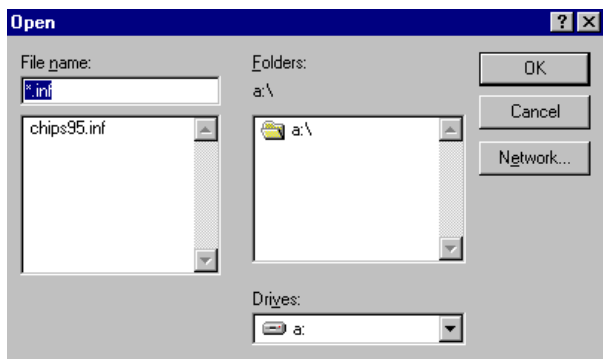

figure 4

In the *Select Device* window, click on **Have Disk**, Select **Browse**, and find the Win95 driver "*chips95.inf*" in the Supporting CD-ROM with the following path, and then click OK.

*cd-rom:* \CD-ROM\*model name*\driver\vga driver\win95\

"*cd-rom:*": the drive letter of your CD-ROM drive

"*model name*": the model number of your product



The name of the *Chips And Techn "69000 PCI "* driver will appear highlighted in the *Models* list boxflow as figure. Click OK to start the driver installation show as figure 6:



**figure 6**

3. Once the installation is complete, the *Advanced display Properties* window will reappear. Show as figure (7):

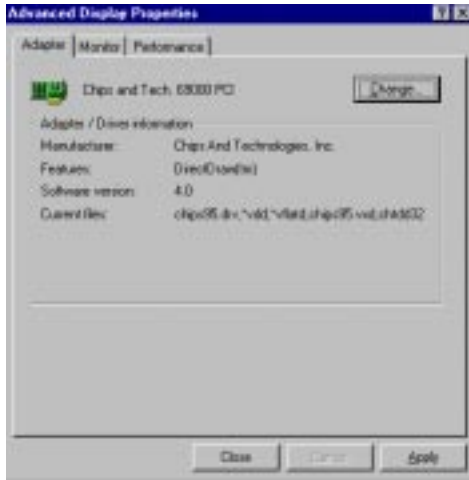

figure 7

Click on **close** to close the window. Then the *Display Properties* window will reappear. Show as figure (8):



figure 8

Click on **Apply**. Restart the system for the new settings to take effect, show as figure (9):

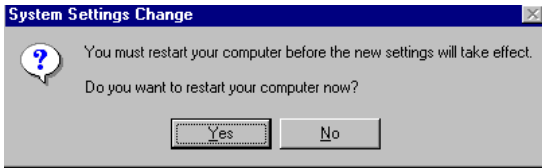

**figure 9**

# Windows® NT 3.51

---

These drivers are designed to work with Microsoft® Windows®.

## Driver installation

1. Install Windows® NT 3.51 as you normally would for a **VGA** display. Click the **Star** button, go to **Settings** and click on **Control Panel** icon. Then choose the **Display** and double click on the icon. In the **Display Properties** window, click the **Setting** button, then click the **Display Type** button into the **Display Type** windows, then click on **Change** button from the **Adapter Type** icon. And click on **Have Disk** button in the change display window.
2. Place the *Supporting CD-ROM* into your CD-ROM drive.

and type:

*cd-rom:* \CD ROM\*model name*\drive\vga drive\  
win98 nt\windows.nt\nt35\Oemsetup.inf

"*cd-rom:*": the drive letter of your CD-ROM drive

"*model name*": the model number of your product

Select the adapter "Chips and Tech 69000PCI" and click OK.

Click on Install to install the selected driver. Once the installation is complete, shut down and restart the system.

# Windows® NT 4.0

---

## Driver installation

1. Install Windows<sup>®</sup> NT 4.0 as you normally would for a **VGA** display. Click the **Star** button, go to **Settings** and click on **Control Panel** icon. Then choose the **Display** and double click on the icon. In the **Display Properties** window, click the **Setting** button, then click the **Display Type** button into the **Display Type** windows, then click on **Change** button from the **Adapter Type** icon. And click on **Have Disk** button in the change display window.
2. Place the *Supporting CD-ROM* into your CD-ROM drive. In the *Select Device* window, click on **Have Disk**, select "**Browse**" and find the NT 4.0 driver from:

*cd-rom* : \CD ROM\*model name*\dirver\vga driver\  
win98 nt\windows.nt\nt40\Oemsetup.inf

"*cd-rom*:" the drive letter of your CD-ROM drive

"*model name*": the model number of your product

and then click OK. The name of the *Chips and Technologies, Inc. Video Controller* driver will appear highlighted in the Modules list box. Select Chips and Tech. 69000 and Click **OK**. Click **OK** to start the driver installation.

3. Once the installation is complete, the *Change Display Type* window will reappear. Click on close to close the window. Then the *Display Properties* window will reappear. Click on **Apply**. Restart the system for the new settings to take effect.



## **Ethernet Software Configuration**

This chapter describes how to configure the Ethernet Card to match your application requirements.



# Ethernet software configuration

---

The onboard Ethernet interface supports all major network operating systems. I/O addresses and interrupts are easily configured via the Award BIOS Setup. To configure the medium type, to view the current configuration, or to run diagnostics, please refer to the following instruction:

1. Power the mainboard on. Ensure that the RSET8139.EXE file is located in the working drive.
2. At the prompt, type RSET8139.EXE and press <ENTER>. The Ethernet configuration program will then be displayed.
3. This simple screen shows all the available options for the Ethernet interface. Just highlight the option you wish to change by using the Up and DOWN keys. To change a selected item, press <ENTER>, and a screen will appear with the available options. Highlight your option and press <ENTER>. Each highlighted option has a helpful message guide displayed at the bottom of the screen for additional information.
4. After you have made your selections and the configuration is what you want, press <ESC>. A prompt will appear asking if you want to save the configuration. Press "Y" if you want to save.

The Ethernet Setup Menu also offers three very useful diagnostic functions. These are:

1. Run EEPROM test
2. Run Diagnostics on Board
3. Run Diagnostics on Network

Each option has its own display screen which shows the format and result of any diagnostic tests undertaken.

## **Programming the Watchdog Timer**

The mainboard is equipped with a watchdog timer that resets the CPU or generates an interrupt if processing comes to a standstill for whatever reason. This feature ensures system reliability in industrial stand-alone and unmanned environments.

# Programming the watchdog timer

---

## How to program the WATCHDOG TIMER

1. To set the time-out interval of watchdog timer:
  - output the desired value to port **0x443**. Since the data is of 1 byte, the maximum value will be 255. In our design 2 ~ 255 will denote 2 ~ 255 sec.
  - outportb(0x443, 30); // set watchdog to 30 seconds*
2. To set the time-out event:
  - output data to **port 0x444**,
  - 0: reset system
  - 1, 2, 3: IRQ 10, 15, 11 respectively
  - 4: NMI
  - e.g.
  - outportb(0x444, 0); // set time-out event to reset-system*
3. To disable watchdog timer:
  - output value 0 to port 0x443
  - outportb(0x443, 0); // disable watchdog timer*
4. To enable or refresh watchdog timer(the watchdog timer will return to its initial value, then count down):
  - access the I/O port **0x443**, e.g.
  - outportb(0x443, data); // refresh watchdog timer*
  - \* note: if you want to refresh the watchdog timer, you have to disable it first.

## Demo program

```
outputb(0x444, 0);           // set time-out event to reset-system
outputb(0x443x 10);        // set time-out interval to 10 seconds
customer_job();           // execute your job here, be sure your
                             // job will finished within 10 seconds

outputb(0x443, 0);        // refresh watchdog timer, otherwise
                             // the system will reset after time-out

outputb(0x443, 20);       // set time-out interval to 20 seconds
another_job();           // another job finished in 20 seconds
outputb(0x443, 0)        // disable watchdog timer

...

...
```

