

# LP-180

---

## Pico-ITX

### User's Manual

2013/7/29

Version: 1.3

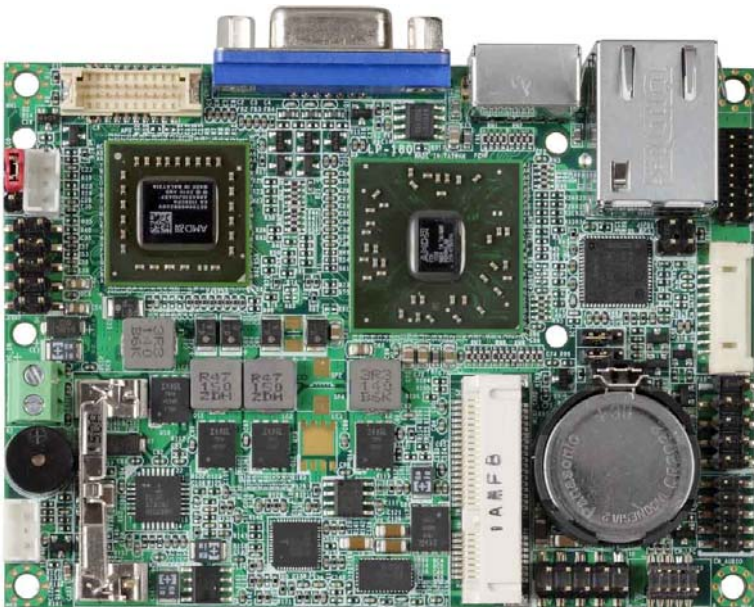



## **Copyright**

Copyright 2012. All rights reserved. This document is copyrighted and all rights are reserved. The information in this document is subject to change without prior notice to make improvements to the products.

This document contains proprietary information and protected by copyright. No part of this document may be reproduced, copied, or translated in any form or any means without prior written permission of the manufacturer.

All trademarks and/or registered trademarks contains in this document are property of their respective owners.

## **Disclaimer**

The company shall not be liable for any incidental or consequential damages resulting from the performance or use of this product.

The company does not issue a warranty of any kind, express or implied, including without limitation implied warranties of merchantability or fitness for a particular purpose.

The company has the right to revise the manual or include changes in the specifications of the product described within it at any time without notice and without obligation to notify any person of such revision or changes.

## **Trademark**

All trademarks are the property of their respective holders.

---

Any questions please visit our website at <http://www.commell.com.tw>

## Packing List:

Please check the package content before you starting using the board.

### Hardware:

LP-180 Pico-ITX Miniboard x 1

### Cable Kit:

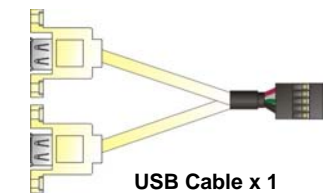

USB Cable x 1  
(OALUSBA-3)



PS/2 keyboard & mouse cable x 1  
(OALPS2/MK)



SATA Cable x 1  
(OALSATA22B-PM15SH15)



DC\_IN Power Cable x 1  
(OALDC-B)

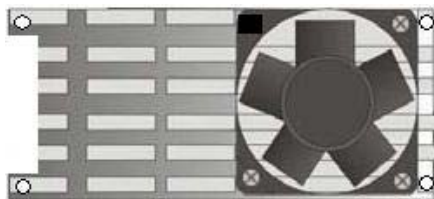

LP-180D/X Heatsink with Fan x 1  
(OHS-180F)

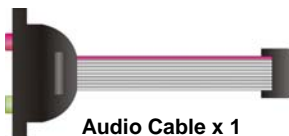

Audio Cable x 1  
(OALPJ-HDUNB)



DVI Module With DVI Cable x 1  
(BADPDVI\_A + OALDVI-DF13)  
**(LP-180D Only)**



Dual COM PORT cable  
(OALES-BKU2NB)

### Printed Matters:

Driver CD x 1 (Including User's Manual)

## Index

<b>Chapter 1 &lt;Introduction&gt;</b> .....	<b>6</b>
1.1 <Product Overview>.....	6
1.2 <Product Specification> .....	7
1.3 <Mechanical Drawing> .....	9
1.4 <Block Diagram> .....	10
<b>Chapter 2 &lt;Hardware Setup&gt;</b> .....	<b>11</b>
2.1 <Connector Location> .....	11
2.2 <Jumper Reference>.....	13
2.3 <Connector Reference> .....	14
2.3.1 <Internal Connector> .....	14
2.3.2 <External Connector> .....	14
2.4 <Memory Setup>.....	15
2.5 <CMOS & ATX Setup> .....	16
2.6 <SATA Interface> .....	17
2.8 <LAN Interface> .....	18
2.9 <Onboard Display Interface> .....	19
2.9.1 <Analog VGA Interface>.....	19
2.9.2 <Digital Display> (LP-180X) .....	20
2.9.3 <DVI Interface > (LP-180D).....	24
2.10 <Onboard Audio Interface>.....	25
2.11 <USB2.0 Interface>.....	26
2.12 <Serial Port Jumper Setting >.....	27
2.13 <Power & FAN Connector > .....	28
2.13.1 <Power Input>.....	28
2.13.2 <Power Output> .....	29
2.13.3 <Fan Connector>.....	29
2.14 <Indicator and Switch>.....	31
<b>Chapter 3 &lt;BIOS Setup &gt;</b> .....	<b>33</b>
<b>Appendix A &lt;I/O Port Pin Assignment&gt;</b> .....	<b>35</b>

A.1 <SATA Port> .....	35
A.2 < CRT Port > .....	35
A.3 <LAN Port>.....	35
A.4 <LAN LED Port>.....	36
A.5 <LPC Port> .....	36
<b>Appendix B &lt;Flash BIOS&gt;.....</b>	<b>37</b>
B.1 BIOS Auto Flash Tool.....	37
B.2 Flash Method .....	37
<b>Appendix C &lt;System Resources&gt; .....</b>	<b>38</b>
C.1 <I/O Port Address Map>.....	38
C.2 <Memory Address Map > .....	40
C.3 < System IRQ Resources >.....	42
<b>Appendix D &lt;Watch Dog timer Setting &gt; .....</b>	<b>44</b>
<b>Appendix E &lt;AMD Hing Definition Audio Device &gt; .....</b>	<b>45</b>
<b>Contact Information.....</b>	<b>47</b>

(This page is left for blank)

## Chapter 1 <Introduction>

### 1.1 <Product Overview>

**LP-180** is the PICO-ITX miniboard with AMD G-T56N platform, with onboard VGA, Realtek ALC888 HD Codec audio, Giga LAN interface. Based on the AMD G-T56N Processor , the board provides many advanced features for reduced power consumption.

#### **A55E Chipset**

The board integrates AMD A55E, to provide built-in UniChrome Pro 3D / 2D Graphics with MPEGII decoder, and supports DDR3 1066/1333 memory up to 4G of capacity.

#### **18-bit LVDS LCD interface**

The board provides onboard 18-bit LVDS LCD interface, supports up to 1400 x 1050 of UXGA high resolution.

#### **Flexible Extension Interface**

The board also provides one Mini card socket.



## 1.2 <Product Specification>

### General Specification

Form Factor	PICO-ITX miniboard
CPU	AMD G-Series T56N Processor 1.65GHz
Memory	1 x 204-pin DDR3 1066/1333 SO-DIMM SDRAM up to 4G
Chipset	AMD A55E FCH
Watchdog Timer	System reset programmable watchdog timer with 1 ~ 255 sec./min. of timeout value
Real Time Clock	Chipset integrated RTC with onboard lithium battery
Serial ATA	1 x serial ATAll interface with 300MB/s transfer rate (Only 2.5" HDD and No RAID Function)

### Multi-I/O Port

Chipset	Winbond W83627DHG-P
Serial Port	Two RS-232 serial port
USB Port	Four Hi-Speed USB 2.0 ports with 480Mbps of transfer rate
K/B & Mouse	PS/2 keyboard and mouse port

### VGA Display Interface

Chipset	AMD G-Series T56N Processor
Frame Buffer	Up to 512MB shared with system memory
Display Type	CRT, LCD monitor with analog display, single channel LVDS(LP-180X only), DVI(LP-180D only)
Connector	External DB15 female connector 5-Pin(molex_53261) LCD Backlight inverter connector and Onboard 20-Pin(DF13-20DP) header (LP-180X is LVDS signal) (LP-180D is DVI signal)

### Ethernet Interface

Controller	1 x Intel® 82583V Gigabit Ethernet controller
Type	Triple speed 10/100/1000Base-T auto-switching Fast Ethernet Full duplex, IEEE802.3U compliant
Connector	One External RJ45 connector with LED

### Audio Interface

Chipset	REALTEK ALC888
Interface	Stereo audio Line-out and MIC-in
Connector	Onboard audio connector with pin header

### Expansive Interface

PCIE Mini Card	1 x PCIE Mini Card socket
----------------	---------------------------

### Power and Environment

## LP-180 User's Manual

---

Power Requirement	DC only +5V input with onboard 2-pin connector
Dimension	100 (L) x 72(H) mm
Temperature	Operating within 0 ~ 60°C Storage within -20 ~ 85°C

---

### Ordering Code

---

LP-180D	Same as LP-180, support DVI
LP-180X	Same as LP-180, support Chipset Integrated 18-bit single channel LVDS

---

The specifications may be different as the actual production.

For further product information please visit the website at <http://www.commell.com.tw>

### 1.3 <Mechanical Drawing>

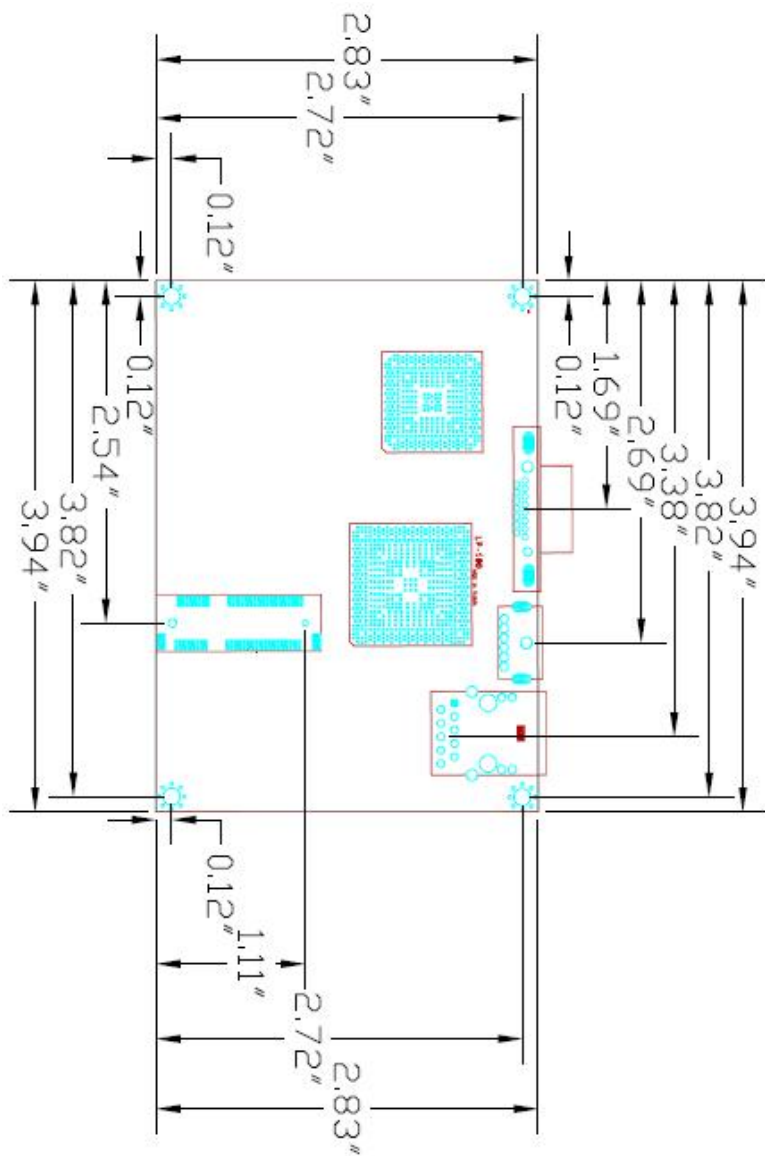

Unit: inch

## 1.4 <Block Diagram>

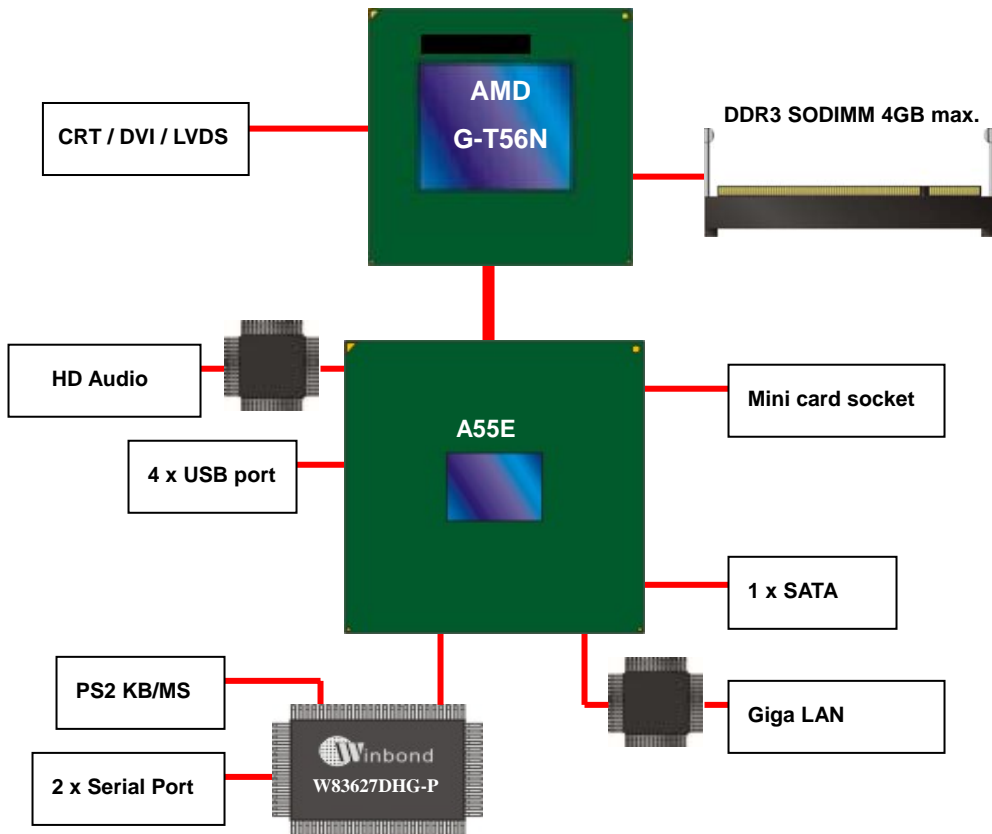

## Chapter 2 <Hardware Setup>

### 2.1 <Connector Location>

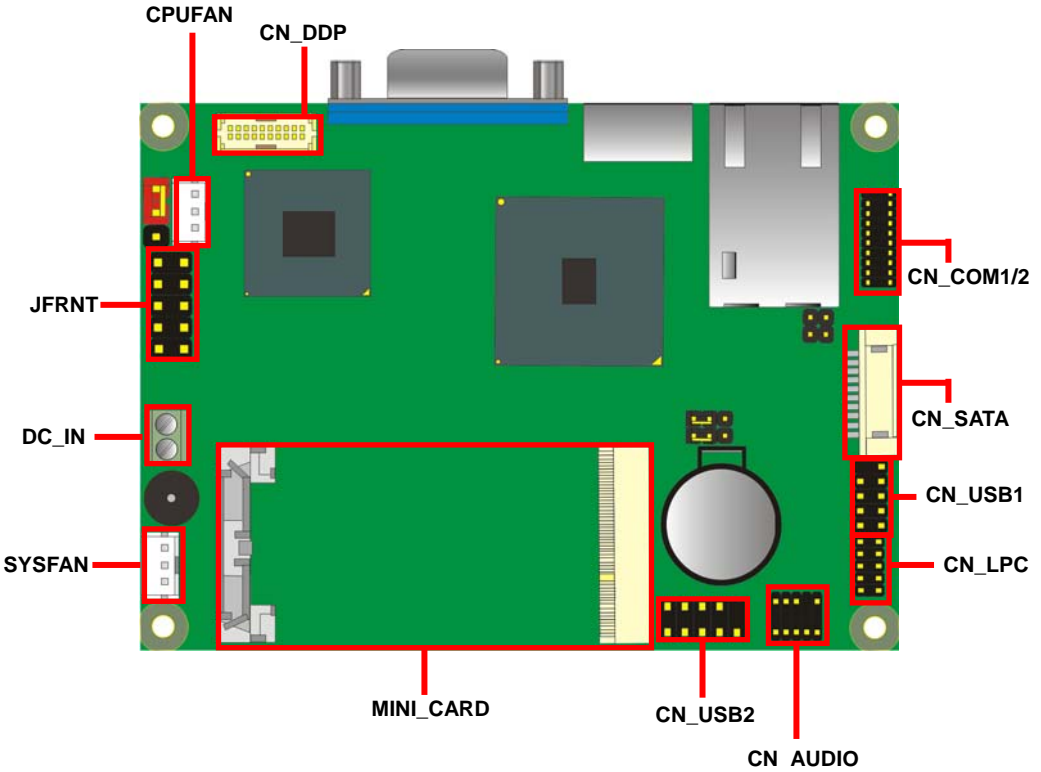

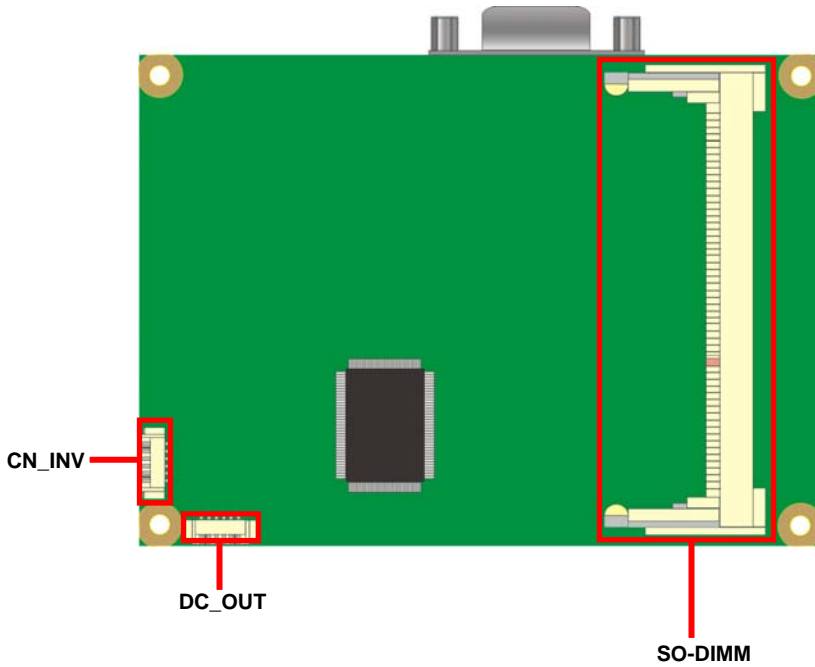

## LP-180

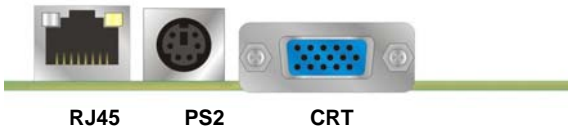

## 2.2 <Jumper Reference>

Jumper	Function
JRTC	CMOS Operating/Clear Setting
JAT	AT/ATX Mode Setting
JVLCD	LCD Panel Voltage Setting

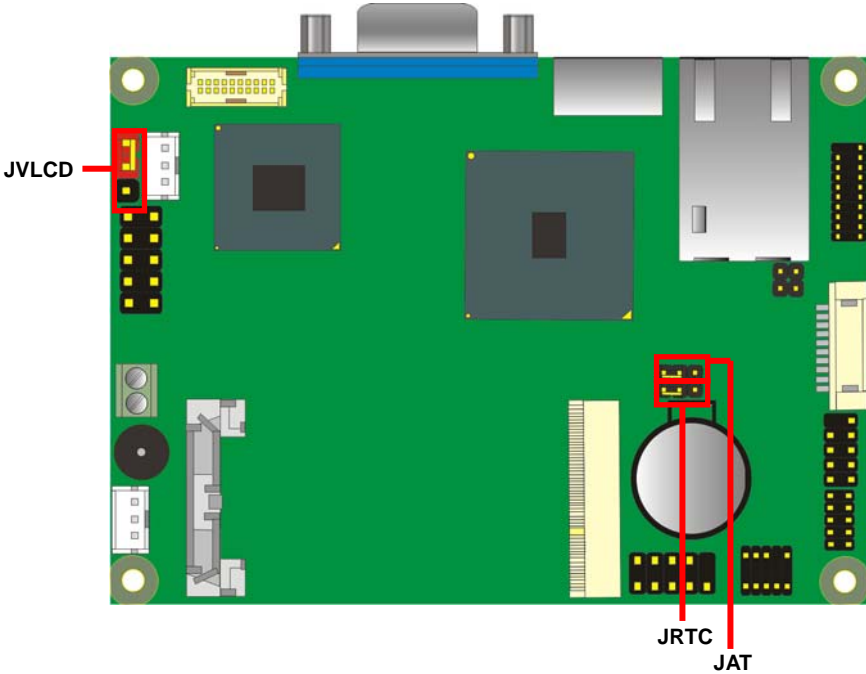

## 2.3 <Connector Reference>

### 2.3.1 <Internal Connector>

Connector	Function	Remark
SO-DIMM	204 -pin DDR3 SO-DIMM SDRAM slot	
CN_SATA	10-pin SATA Cable connector	
MINI_CARD	PCIe mini card socket	
CN_DDP	20 -pin(DF13-20DP) header (LP-180X is LVDS signal) (LP-180D is DVI signal)	
CN_INV	5-pin LCD Backlight inverter connector	
CN_USB1/2	5 x 2-pin USB connector	
CN_AUDIO	5 x 2-pin audio connector	
CN_LPC	5 x 2-pin header for LPC Port	
JFRNT	10-pin switch/indicator connector	
CPUFAN	4-pin CPU cooler fan connector	
SYSFAN	3-pin system cooler fan connector	
DC_OUT	6-pin power output connector	
DC_IN	DC input connector	

### 2.3.2 <External Connector>

Connector	Function	Remark
CRT	DB15 VGA connector	
PS2	PS/2 keyboard and mouse connector	
RJ45	RJ45 LAN connector	



## 2.4 <Memory Setup>

The board provides one 204-pin DDR3 SO-DIMM to support DDR3 1066/1333 memory modules up to 4GB. Only Non-ECC memory is supported.

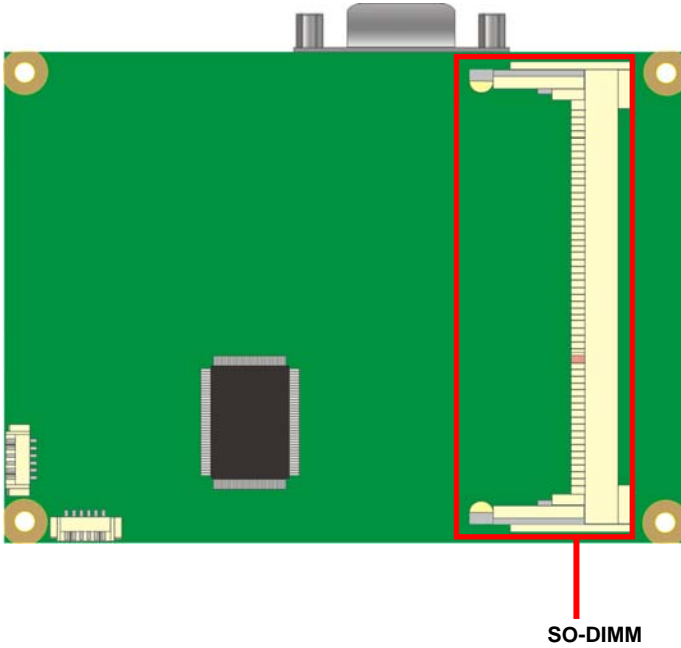

## 2.5 <CMOS & ATX Setup>

The board's data of CMOS can be setting in BIOS. If the board refuses to boot due to inappropriate CMOS settings, please remove battery to clear (reset) the CMOS to its default values.

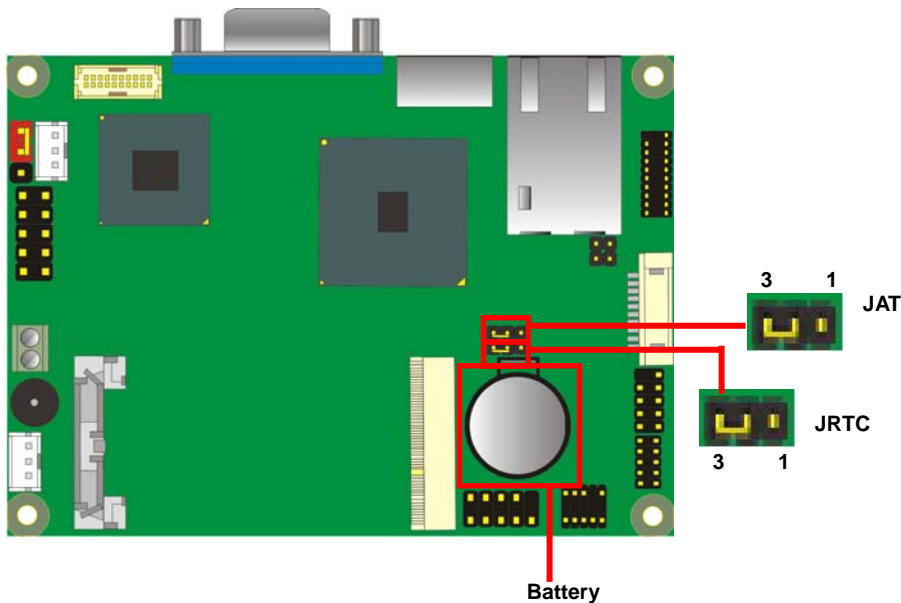

The board has a jumper to switch AT power mode (automatic power on) or standard ATX mode.

Jumper: **JAT**

Type: onboard 3-pin jumper

JAT	Mode
1-2	AT Mode
2-3	ATX Mode

Default setting

Jumper: **JRTC**

Type: onboard 3-pin jumper

JRTC	Mode
1-2	Clear CMOS
2-3	Normal Operation

Default setting

## 2.6 <SATA Interface>

Based on AMD A55E, the board provides one Serial ATAII interfaces with up to 300MB/s of transfer rate.

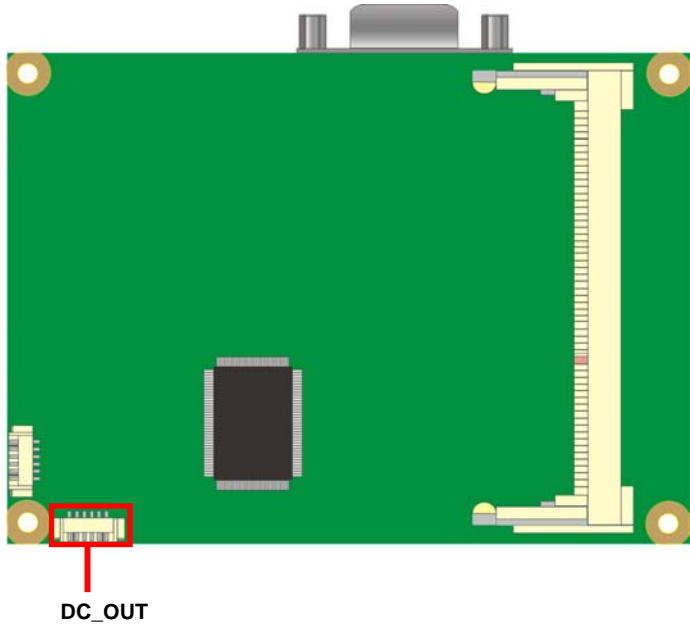
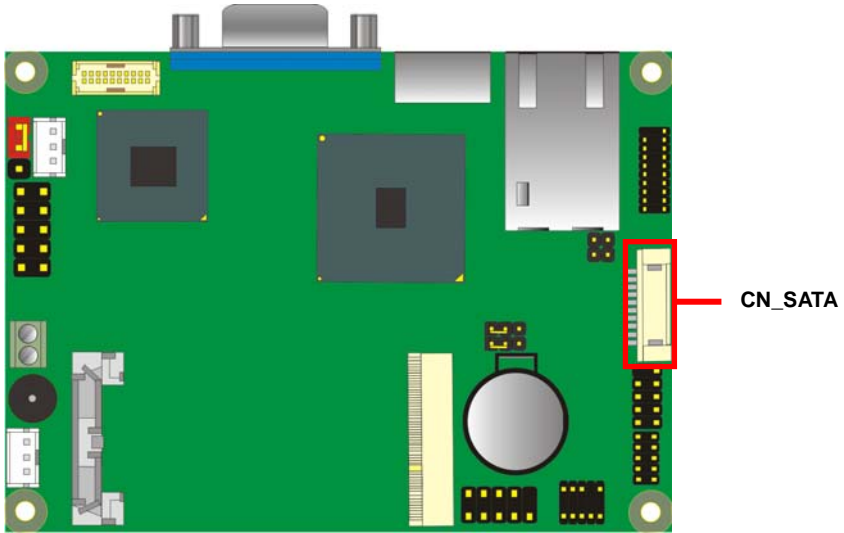

**Remark:** Only catch 2.5" HDD

## 2.8 <LAN Interface>

The board integrates with one Intel 82583V Gigabit Ethernet controller. The Intel® 82583V supports triple speed of 10/100/1000Base-T, with IEEE802.3 compliance and Wake-On-LAN supported.



## 2.9 <Onboard Display Interface>

Based on AMD G-T56N chipset with built-in AMD Radeon HD 6300 series Graphics, the board provides one DB15 connector on rear external I/O port, and one 20-pin DVI (LP-180D) or one LVDS interface with 5-pin LCD backlight inverter connector(LP-180X). The board provides dual display function with clone mode and extended desktop mode for CRT, DVI (LP-180D) or LVDS (LP-180X).

### 2.9.1 <Analog VGA Interface>

Please connect your CRT or LCD monitor with DB15 male connector to the onboard DB15 female connector on rear I/O port.

The board supports up to 1920 x 1200 (WUXGA) of resolution.

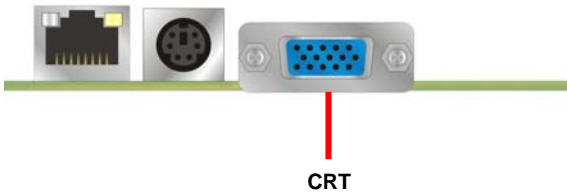

## 2.9.2 <Digital Display> (LP-180X only)

The board provides one 20-pin LVDS connector for 18 bit single channel panel, supports up to 1400 x 1050 of resolution, with one LCD backlight inverter connector and one jumper for panel voltage setting.

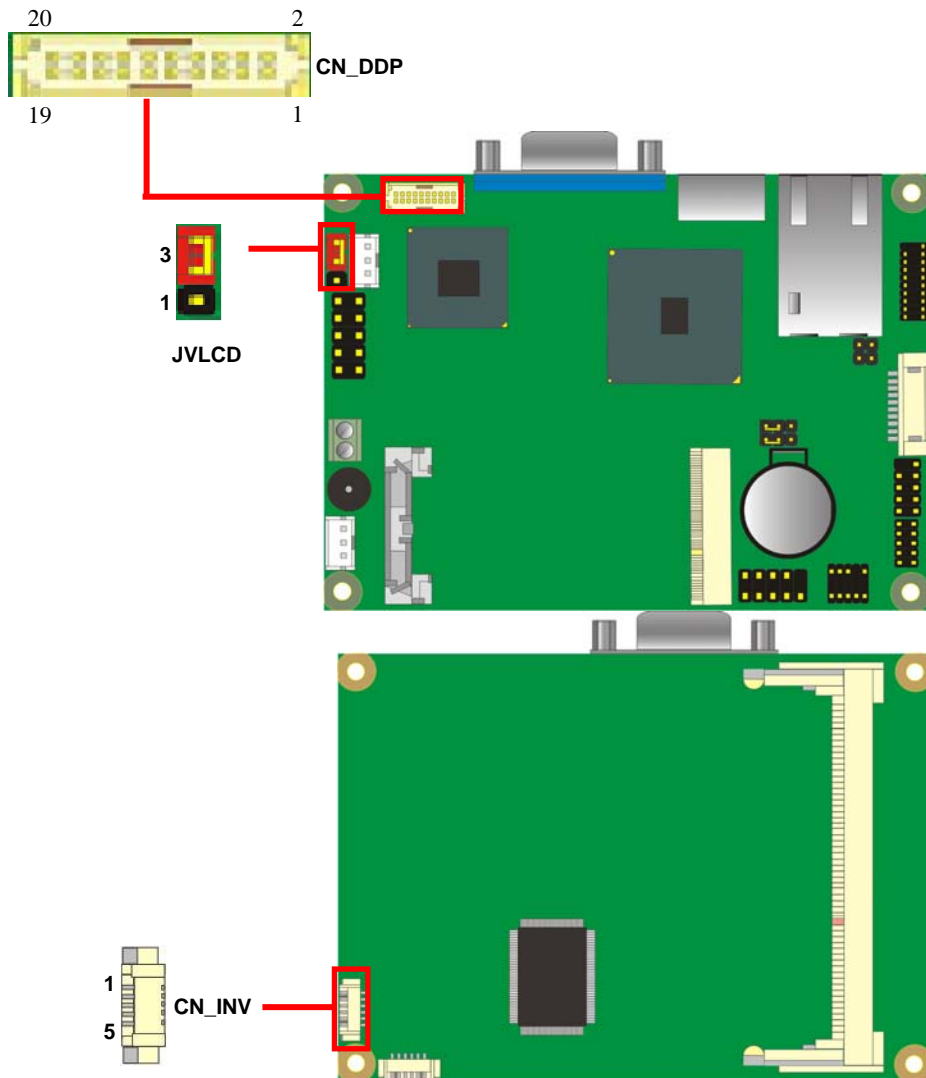

Connector: **CN\_INV**

Type: 5-pin Inverter power connector

Connector model: **molex\_53261-5pin** or compatible

Pin	Description
1	+3.3V
2	GND
3	+5V
4	GND
5	Enable

Jumper: **JVLCD**

Type: 3-pin Power select jumper

Pin	Description
1-2	+5V
2-3	+3.3V

**Default: 2-3**

Connector: **CN\_DDP**

Type: onboard 20-pin connector for LVDS connector

Connector model: **HIROSE DF13-20DP-1.25V** or compatible

Pin	Signal	Pin	Signal
1	LCDVCC	2	LCDVCC
3	HPD0	4	GND
5	TX0N	6	TX0P
7	GND	8	TX1N
9	TX1P	10	GND
11	TX2N	12	TX2P
13	GND	14	CLKN
15	CLKP	16	GND
17	DVI_DA(LP-180D)	18	DVI_SL(LP-180D)
19	AUXN	20	AUXP

## LP-180 User's Manual

To setup the LCD, you need the component below:

1. A panel with LVDS interfaces.
2. An inverter for panel's backlight power.
3. A LCD cable and an inverter cable.

For the cables, please follow the pin assignment of the connector to make a cable, because every panel has its own pin assignment, so we do not provide a standard cable; please find a local cable manufacture to make cables.

### LCD Installation Guide:

1. Preparing the LP-180, LCD panel and the backlight inverter

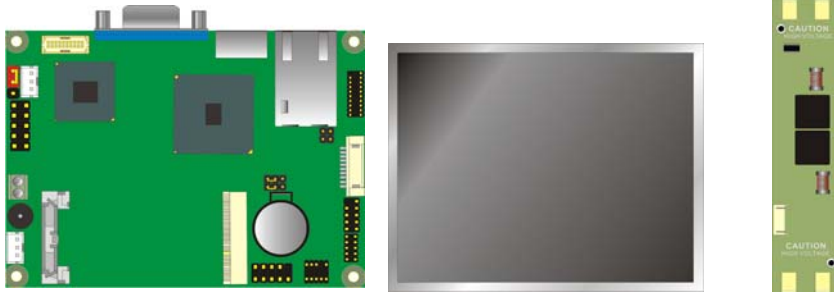

2. You would need a LVDS type cable.



3. To connect all of the devices well.

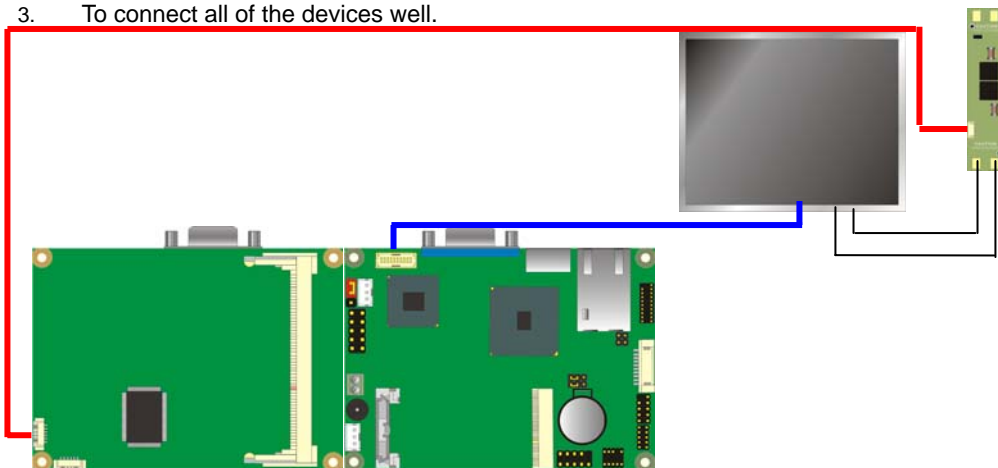



After setup the devices well, you need to select the LCD panel type in the BIOS.

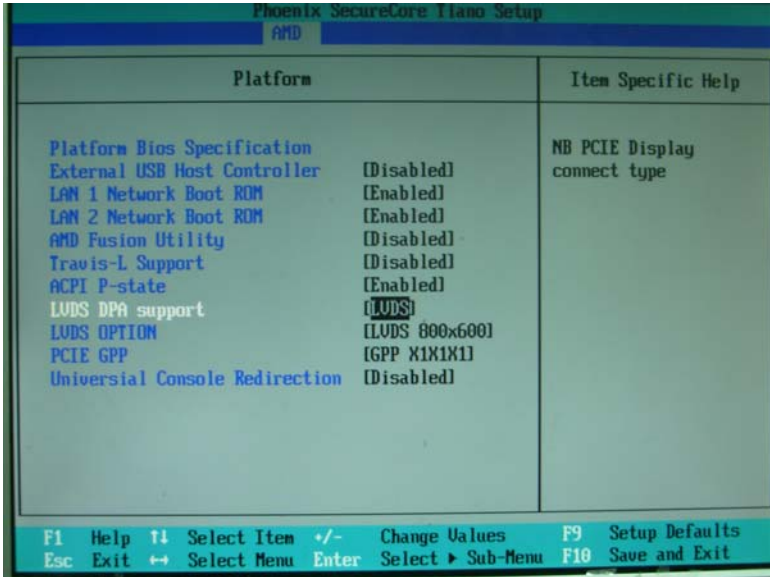

The panel type mapping is list below:

LP-180 BIOS panel type selection form		
On board Single channel LVDS		
18bit		
NO.	Output format	
1	800 x 600	
2	1024 x 768	
3	1280 x 720	
4	1280 x 800	
5	1280 x 1024	
6	1366 x 768	
7	1440 x 900	

**2.9.3 <DVI Interface > (LP-180D only)**

The board also comes with a DVI interface. Supports up to 1920 x 1200 (WUXGA) of resolution.

Connector: **CN\_DDP**

Type: onboard 20-pin connector for DVI connector

Connector model: HIROSE DF13-20DP-1.25V or compatible

Pin Number	Assignment	Pin Number	Assignment
1	LCDVCC	2	LCDVCC
3	HPD0	4	GND
5	TX0N	6	TX0P
7	GND	8	TX1N
9	TX1P	10	GND
11	TX2N	12	TX2P
13	GND	14	CLKN
15	CLKP	16	GND
17	DVI_DA	18	DVI_SL
19	AUXN	20	AUXP

## 2.10 <Onboard Audio Interface>

The board provides the onboard high definition audio with Realtek ALC888

**Connector: CN\_AUDIO**

Type: 10-pin (2 x 5) 1.27mm x 2.54mm-pitch header

Pin	Description	Pin	Description
1	MIC2_L	2	AGND
3	MIC2_R	4	AVCC
5	FP_OUT_R	6	MIC2_JD
7	SENSE_B	8	N/C
9	FP_OUT_L	10	LINE2_JD

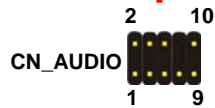
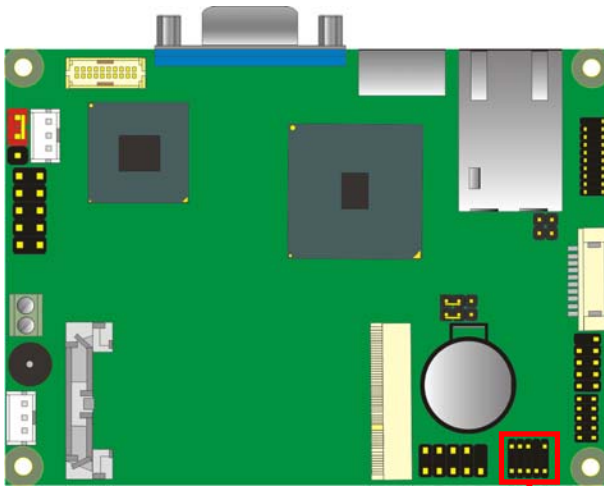

## 2.11 <USB2.0 Interface>

Based on AMD A55E FCH, the board provides 4 USB2.0 ports. The USB2.0 interface provides up to 480Mbps of transferring rate.

Interface	USB2.0
Controller	A55E
Transfer Rate	Up to 480Mb/s
Output Current	500mA

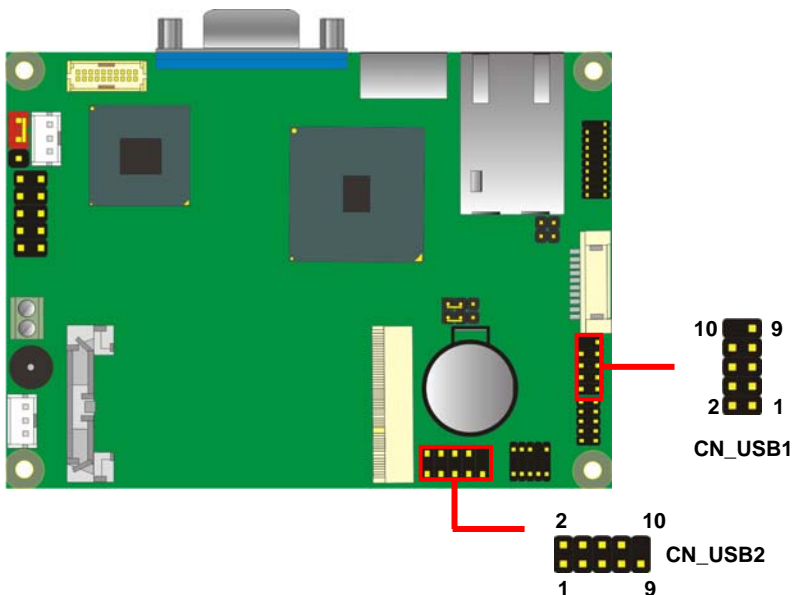

Connector: **CN\_USB**

Type: 10-pin (5 x 2) header for USB Port

Pin	Description	Pin	Description
1	VCC	2	VCC
3	D0-	4	D1-
5	D0+	6	D1+
7	Ground	8	Ground
9	Ground	10	N/C

PS: The USB2.0 will be only active when you connecting with the USB2.0 devices, if you insert an USB1.1 device, the port will be changed to USB1.1 protocol automatically. The transferring rate of USB2.0 as 480Mbps is depends on device capacity, exact transferring rate may not be up to 480Mbps.

## 2.12 <Serial Port Jumper Setting >

The board provides two RS232 serial ports

Connector: **CN\_COM1/2**

Type: 20-pin (10 x 2) 1.27mm x 2.54mm-pitch header for COM1/2

Pin	Description	Pin	Description
1	MDCD1-	2	MSIN1-
3	MSO1-	4	MDTR1-
5	N/C	6	MDSR1-
7	MRTS1-	8	MCTS1-
9	MRI1-	10	N/C
11	MDCD2-	12	MSIN2-
13	MSO2-	14	MDTR2-
15	GND	16	MDSR2-
17	MRTS2-	18	MCTS2-
19	MRI2-	20	N/C

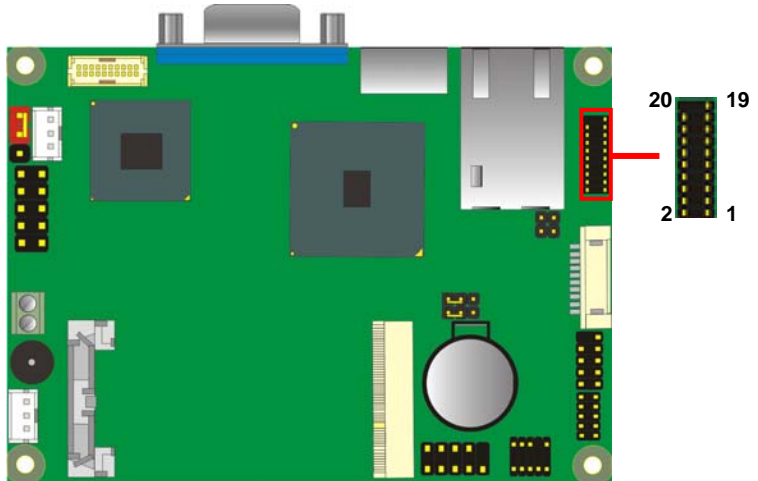

## 2.13 <Power & FAN Connector >

The board requires DC input with 2-pin header, the input voltage range is from 5V for the input current, please take a reference of the power consumption report on appendix.

### 2.13.1 <Power Input>

Connector: DC\_IN

Type: 2-pin header

Pin	Description	Pin	Description
1	Ground	2	+5V

**Remark:** DC input voltage only +5V

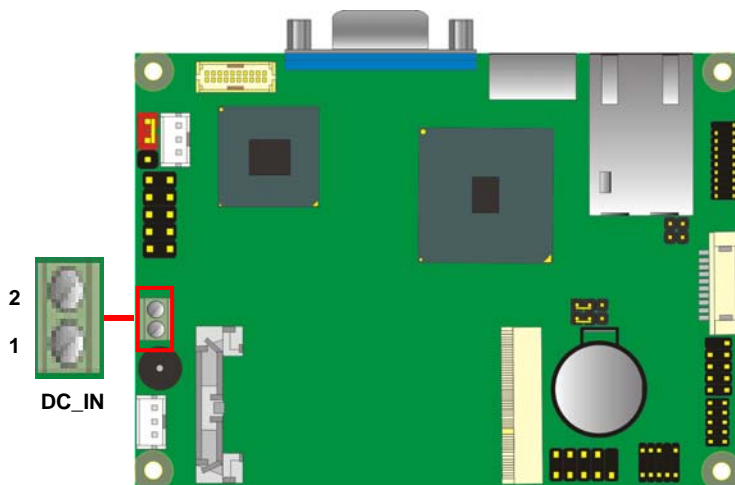

### 2.13.2 <Power Output>

Connector: **DC\_OUT**

Type: 6-pin connector for **+5V output**

Pin	Description	Pin	Description	Pin	Description
1	N/C	2	N/C	3	Ground
4	Ground	5	+5V	6	+5V

**Note: Maximum output current 5V/1A**

### 2.13.3 <Fan Connector>

Connector: **SYSFAN**

Type: 3-pin fan wafer connector

Connector model: 2001-WS-03-LF

Pin	Description	Pin	Description	Pin	Description
1	Ground	2	+5V	3	CSFAN

Connector: **CPUFAN**

Type: 3-pin fan wafer connector

Connector model: 2001-WS-03-LF

Pin	Description
1	Ground
2	+5V
3	P1FAN

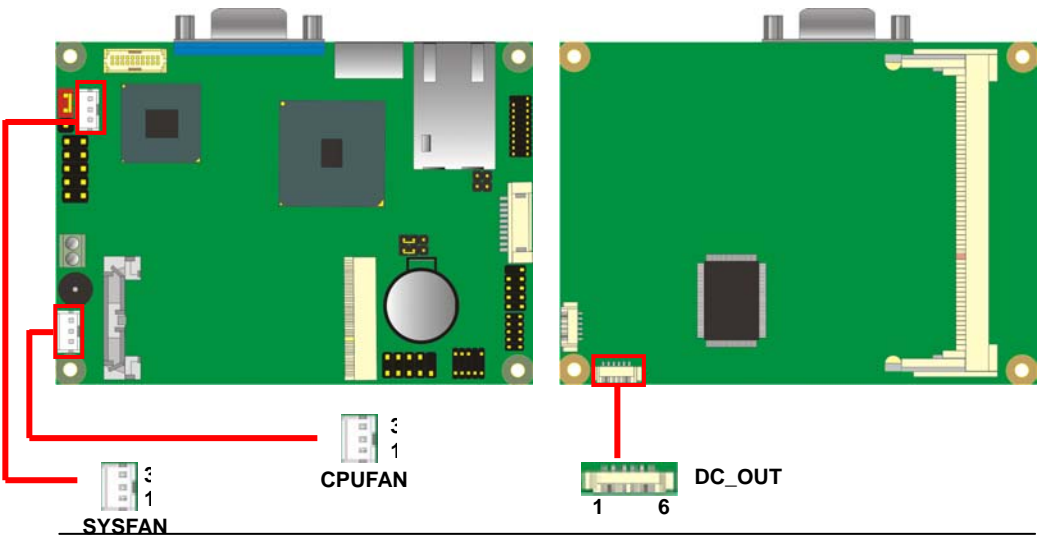





## 2.14 <Indicator and Switch>

The **JFRNT** provides front control panel of the board, such as power button, reset and beeper, etc. Please check well before you connecting the cables on the chassis.

Connector: **JFRNT**

Type: onboard 10-pin (2 x 5) 2.54-pitch header

Function	Signal	PIN		Signal
Power	PWRBT-	1	2	PWRBT+
Speaker	SPK-	3	4	SPK+
HDD LED	HLED-	5	6	HLED+
Power LED	GND	7	8	PWLED+
Reset	Reset-	9	10	GND

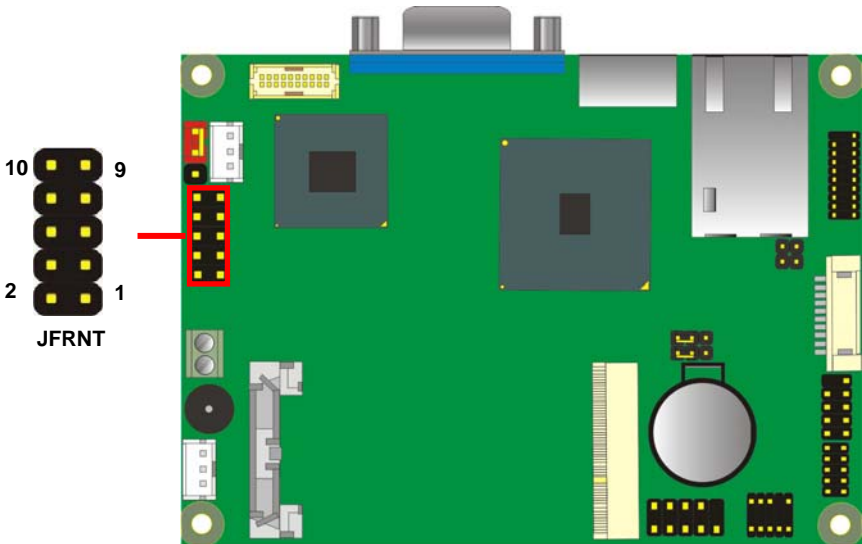

(This Page is Left For Blank)

## Chapter 3 <BIOS Setup>

The motherboard uses the Award BIOS for the system configuration. The Award BIOS in the single board computer is a customized version of the industrial standard BIOS for IBM PC AT-compatible computers. It supports Intel® x86 and compatible CPU architecture based processors and computers. The BIOS provides critical low-level support for the system central processing, memory and I/O sub-systems.

The BIOS setup program of the single board computer let the customers modify the basic configuration setting. The settings are stored in a dedicated battery-backed memory, NVRAM, retains the information when the power is turned off. If the battery runs out of the power, then the settings of BIOS will come back to the default setting.

The BIOS section of the manual is subject to change without notice and is provided here for reference purpose only. The settings and configurations of the BIOS are current at the time of print, and therefore they may not be exactly the same as that displayed on your screen.

To activate CMOS Setup program, press <DEL> key immediately after you turn on the system. The following message “Press DEL to enter SETUP” should appear in the lower left hand corner of your screen. When you enter the CMOS Setup Utility, the Main Menu will be displayed as **Figure 4-1**. You can use arrow keys to select your function, press <Enter> key to accept the selection and enter the sub-menu.

**Figure 4-1** CMOS Setup Utility Main Screen



(This Page is Left for Blank)

## Appendix A <I/O Port Pin Assignment>

### A.1 <SATA Port>

Connector: **SATA**

Type: 10-pin header for SATA Port

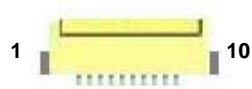

Pin	Description	Pin	Description
1	Ground	2	TXP
3	TXN	4	Ground
5	N/C	6	N/C
7	Ground	8	RXN
9	RXP	10	Ground

### A.2 < CRT Port >

Connector: **CRT**

Type: 15-pin D-sub female connector on rear panel

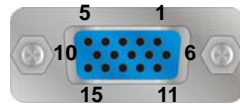

Pin	Description	Pin	Description	Pin	Description
1	RED	6	Ground	11	N/C
2	GREEN	7	N/C	12	5VCCA
3	BLUE	8	Ground	13	HSYNC
4	N/C	9	LVGA5V	14	VSYNC
5	-CRTATCH	10	-CRTATCH	15	5VCLK

### A.3 <LAN Port>

Connector: **RJ45**

Type: RJ45 connector with LED on rear panel

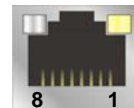

Pin	1	2	3	4	5	6	7	8
Description	TRD0+	TRD0-	TRD1+	TRD2+	TRD2-	TRD1-	TRD3+	TRD3-

## A.4 <LAN LED Port>

Connector: **JSPD1**

Type: 2-pin header for LAN Speed LED connector RJ45 connector with LED on rear panel

When Lan speed 10/100Mbps

Pin	Description
1	LED-
2	LED+

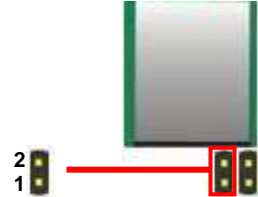

When Lan speed 1Gbps

Pin	Description
1	LED+
2	LED-

Connector: **JACT1**

Type: 5-pin header for LAN Activity LED connector

Pin	Description
1	LED-
2	LED+

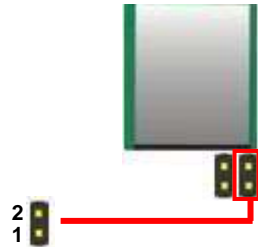

## A.5 <LPC Port>

Connector: **CN\_LPC**

Type: 10-pin header for LPC Port

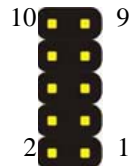

Pin	Description	Pin	Description
1	LPC_CLK	2	RESET-
3	LFRAME-	4	LAD3
5	LAD2	6	LAD1
7	LAD0	8	+3.3V
9	Ground	10	Ground

## Appendix B <Flash BIOS>

### B.1 BIOS Auto Flash Tool

The board is based on Award BIOS and can be updated easily by the BIOS auto flash tool. You can download the tool online at the address below:

<http://www.phoenix.com/en/home/>

[http://www.commell.com.tw/Support/Support\\_SBC.htm](http://www.commell.com.tw/Support/Support_SBC.htm)

File name of the tool is "Pflash.exe", it's the utility that can write the data into the BIOS flash chip and update the BIOS.

### B.2 Flash Method

1. Please make a bootable floppy disk.
2. Get the last .bin files you want to update and copy it into the disk.
3. Copy awardflash.exe to the disk.
4. Power on the system and flash the BIOS.  
(Example: C:/Pflash /sa /bbl /cvar XXX.bin)
5. Re-start the system.

Any question about the BIOS re-flash please contact your distributors or visit the web-site at below:

































<http://www.commell.com.tw/support/support.htm>

## Appendix C <System Resources>









































### C.1 <I/O Port Address Map>

	[00000000 - 0000001F]	Direct memory access controller
	[00000000 - 00000CF7]	PCI bus
	[00000020 - 00000021]	Programmable interrupt controller
	[00000022 - 00000023]	Motherboard resources
	[0000002E - 0000002F]	Motherboard resources
	[00000040 - 00000043]	System timer
	[00000060 - 00000060]	Standard 101/102-Key or Microsoft Natural PS/2 Keyboard
	[00000061 - 00000061]	System speaker
	[00000064 - 00000064]	Standard 101/102-Key or Microsoft Natural PS/2 Keyboard
	[00000070 - 00000071]	System CMOS/real time clock
	[00000072 - 00000073]	Motherboard resources
	[00000080 - 00000080]	Motherboard resources
	[00000081 - 0000008F]	Direct memory access controller
	[00000092 - 00000092]	Motherboard resources
	[000000A0 - 000000A1]	Programmable interrupt controller
	[000000B0 - 000000B1]	Motherboard resources
	[000000B2 - 000000B2]	Motherboard resources
	[000000B8 - 000000B8]	Motherboard resources
	[000000BC - 000000BC]	Motherboard resources
	[000000C0 - 000000DE]	Direct memory access controller
	[000000F0 - 000000F0]	Motherboard resources
	[000000F0 - 000000FE]	Numeric data processor
	[00000170 - 00000177]	Secondary IDE Channel
	[000001F0 - 000001F7]	Primary IDE Channel
	[00000274 - 00000277]	ISAPNP Read Data Port





























	[00000279 - 00000279]	ISAPNP Read Data Port
	[000002F8 - 000002FF]	Communications Port (COM2)
	[00000376 - 00000376]	Secondary IDE Channel
	[000003B0 - 000003BB]	AMD Radeon HD 6300 series Graphics
	[000003C0 - 000003DF]	AMD Radeon HD 6300 series Graphics
	[000003F6 - 000003F6]	Primary IDE Channel
	[000003F8 - 000003FF]	Communications Port (COM1)
	[00000408 - 0000040B]	Direct memory access controller
	[000004D0 - 000004D1]	Motherboard resources
	[000004D6 - 000004D6]	Direct memory access controller
	[00000530 - 00000537]	Motherboard resources
	[00000800 - 00000827]	Motherboard resources
	[00000830 - 00000830]	Motherboard resources
	[00000840 - 00000847]	Motherboard resources
	[00000A79 - 00000A79]	ISAPNP Read Data Port
	[00000B00 - 00000B1F]	Motherboard resources
	[00000B20 - 00000B3F]	Motherboard resources
	[00000C00 - 00000C01]	Motherboard resources
	[00000C14 - 00000C14]	Motherboard resources
	[00000C50 - 00000C52]	Motherboard resources
	[00000CD0 - 00000CD1]	Motherboard resources
	[00000CD2 - 00000CD3]	Motherboard resources
	[00000CD4 - 00000CD5]	Motherboard resources
	[00000CD6 - 00000CD7]	Motherboard resources
	[00000CD8 - 00000CDF]	Motherboard resources
	[00000CF9 - 00000CF9]	Motherboard resources
	[00000D00 - 0000FFFF]	PCI bus
	[00000F50 - 00000F51]	Motherboard resources
	[00001000 - 0000101F]	Intel(R) 82583V Gigabit Network Connection
	[00001000 - 00001FFF]	PCI standard PCI-to-PCI bridge
	[00002000 - 000020FF]	AMD Radeon HD 6300 series Graphics
	[00002100 - 0000210F]	Standard Dual Channel PCI IDE Controller
	[00008100 - 000081FF]	Motherboard resources
	[00008200 - 000082FF]	Motherboard resources

## C.2 <Memory Address Map >

	[000A0000 - 000BFFFF]	AMD Radeon HD 6300 series Graphics
	[000A0000 - 000BFFFF]	PCI bus
	[000C0000 - 000C1FFF]	PCI bus
	[000C2000 - 000C3FFF]	PCI bus
	[000C4000 - 000C5FFF]	PCI bus
	[000C6000 - 000C7FFF]	PCI bus
	[000C8000 - 000C9FFF]	PCI bus
	[000CA000 - 000CBFFF]	PCI bus
	[000CC000 - 000CDFFF]	PCI bus
	[000CE000 - 000CFFFF]	PCI bus
	[000D0000 - 000D1FFF]	PCI bus
	[000D2000 - 000D3FFF]	PCI bus
	[000D4000 - 000D5FFF]	PCI bus
	[000D6000 - 000D7FFF]	PCI bus
	[000D8000 - 000D9FFF]	PCI bus
	[000DA000 - 000DBFFF]	PCI bus
	[000DC000 - 000DDFFF]	PCI bus
	[000DE000 - 000DFFFF]	PCI bus
	[000E0000 - 000E1FFF]	PCI bus
	[000E0000 - 000FFFFFF]	System board
	[000E2000 - 000E3FFF]	PCI bus
	[000E4000 - 000E5FFF]	PCI bus
	[000E6000 - 000E7FFF]	PCI bus
	[000E8000 - 000E9FFF]	PCI bus
	[000EA000 - 000EBFFF]	PCI bus
	[000EC000 - 000EDFFF]	PCI bus
	[000EE000 - 000EFFFF]	PCI bus
	[3F000000 - DFFFFFFF]	PCI bus
	[40000000 - 4FFFFFFF]	AMD Radeon HD 6300 series Graphics
	[50000000 - 507FFFFFFF]	PCI standard PCI-to-PCI bridge
	[50800000 - 5081FFFF]	Intel(R) 82583V Gigabit Network Connection
	[50800000 - 50FFFFFFF]	PCI standard PCI-to-PCI bridge
	[50820000 - 50823FFF]	Intel(R) 82583V Gigabit Network Connection
	[51000000 - 5103FFFF]	AMD Radeon HD 6300 series Graphics
	[51040000 - 51043FFF]	Microsoft UAA Bus Driver for High Definition Audio
	[51044000 - 51047FFF]	Microsoft UAA Bus Driver for High Definition Audio
	[51048000 - 51048FFF]	Standard OpenHCD USB Host Controller
	[51049000 - 51049FFF]	Standard OpenHCD USB Host Controller
	[5104A000 - 5104AFFF]	Standard OpenHCD USB Host Controller
	[5104B000 - 5104BFFF]	Standard OpenHCD USB Host Controller
	[5104C000 - 5104C3FF]	Standard Dual Channel PCI IDE Controller

	[5104C400 - 5104C4FF]	Standard Enhanced PCI to USB Host Controller
	[5104C500 - 5104C5FF]	Standard Enhanced PCI to USB Host Controller
	[5104C600 - 5104C6FF]	Standard Enhanced PCI to USB Host Controller
	[E0000000 - E1FFFFFF]	Motherboard resources
	[E1000000 - FFFFFFFF]	PCI bus
	[FEC00000 - FEC00FFF]	Motherboard resources
	[FEC10000 - FEC1001F]	System board
	[FED00000 - FED003FF]	System board
	[FED61000 - FED613FF]	System board
	[FED80000 - FED80FFF]	System board
	[FEE00000 - FEE00FFF]	Motherboard resources
	[FFE00000 - FFFFFFFF]	System board

### C.3 < System IRQ Resources >

	(ISA) 0	System timer
	(ISA) 1	Standard 101/102-Key or Microsoft Natural PS/2 Keyboard
	(ISA) 3	Communications Port (COM2)
	(ISA) 4	Communications Port (COM1)
	(ISA) 8	System CMOS/real time clock
	(ISA) 9	Microsoft ACPI-Compliant System
	(ISA) 12	PS/2 Compatible Mouse
	(ISA) 13	Numeric data processor
	(ISA) 14	Primary IDE Channel
	(PCI) 16	Intel(R) 82583V Gigabit Network Connection
	(PCI) 16	Microsoft UAA Bus Driver for High Definition Audio
	(PCI) 16	PCI standard PCI-to-PCI bridge
	(PCI) 16	PCI standard PCI-to-PCI bridge
	(PCI) 16	PCI standard PCI-to-PCI bridge
	(PCI) 16	PCI standard PCI-to-PCI bridge
	(PCI) 16	PCI standard PCI-to-PCI bridge
	(PCI) 17	PCI standard PCI-to-PCI bridge
	(PCI) 17	Standard Enhanced PCI to USB Host Controller
	(PCI) 17	Standard Enhanced PCI to USB Host Controller
	(PCI) 17	Standard Enhanced PCI to USB Host Controller
	(PCI) 18	AMD Radeon HD 6300 series Graphics
	(PCI) 18	PCI standard PCI-to-PCI bridge
	(PCI) 18	Standard OpenHCD USB Host Controller
	(PCI) 18	Standard OpenHCD USB Host Controller
	(PCI) 18	Standard OpenHCD USB Host Controller
	(PCI) 18	Standard OpenHCD USB Host Controller
	(PCI) 19	Microsoft UAA Bus Driver for High Definition Audio
	(PCI) 19	PCI standard PCI-to-PCI bridge



## Appendix D <Watch Dog timer Setting >

The watchdog timer makes the system auto-reset while it stops to work for a period. The integrated watchdog timer can be setup as system reset mode by program.

### Timeout Value Range

- 1 to 255
- Second or Minute

### Program Sample

Watchdog timer setup as system reset with 5 second of timeout

---

2E, 87	
2E, 87	
2E, 07	
2F, 08	Logical Device 8
2E, 30	
2F, 01	Activate
2E, F5	
2F, 02	Set as Second*
2E, F6	
2F, 05	Set as 5

---

\* Minute: bit 3 = 1; Second: bit 3 = 0

You can select Timer setting in the BIOS, after setting the time options, the system will reset according to the period of your selection.

## Appendix E <AMD Hing Definition Audio Device >

1. Copy the CD Driver folder to disk, Ex: C:\ , D:\ ...
2. Please choose "Device Manager"
3. You can see other devices "Audio Device on High Definition Audio Bus"

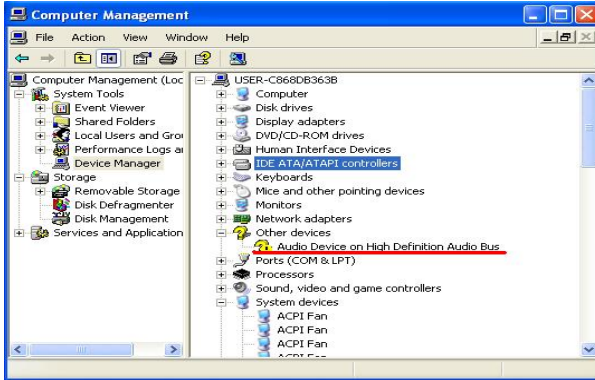

4. Please choose "Audio Device on High Definition Audio Bus" then press Update Driver
5. Please choose "NO, not this time"
6. Install software for " Audio Device on High Definition Audio Bus " Please choose "Install from a list or specific location"
7. Please choose "Search for the best driver in these location" Check "Include this location in the search" then press "Browse"
8. Please select the file location "D:\LP-180\Audio(XP)\XP"

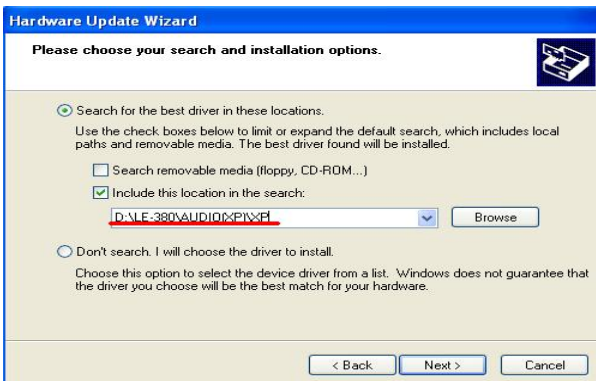

9. Install finish

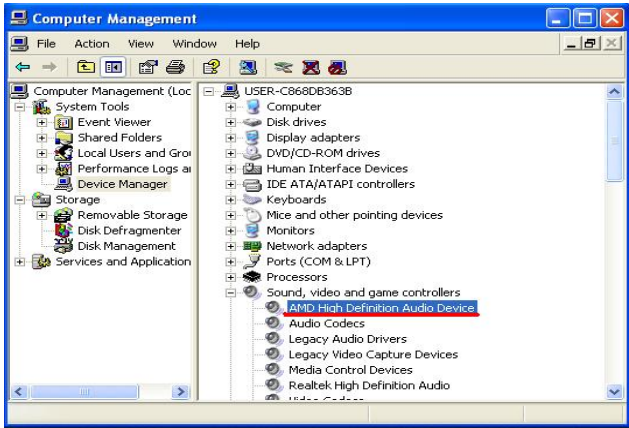

(This Page is Left for Blank)



## Contact Information

Any advice or comment about our products and service, or anything we can help you please don't hesitate to contact with us. We will do our best to support you for your products, projects and business.

### Taiwan Commate Computer Inc.

---

Address	19F., No.94, Sec. 1, Xintai 5th Rd., Xizhi Dist., New Taipei City 22102, Taiwan
TEL	+886-2-26963909
FAX	+886-2-26963911
Website	<a href="http://www.commell.com.tw">http://www.commell.com.tw</a>
E-Mail	<a href="mailto:info@commell.com.tw">info@commell.com.tw</a> (General Information) <a href="mailto:tech@commell.com.tw">tech@commell.com.tw</a> (Technical Support)
Facebook	<a href="https://www.facebook.com/pages/Taiwan-Commate-Computer-Inc/547993955271899">https://www.facebook.com/pages/Taiwan-Commate-Computer-Inc/547993955271899</a>
Twitter	<a href="https://twitter.com/Taiwan_Commate">https://twitter.com/Taiwan_Commate</a>

---

**Commell is our trademark of industrial PC division**