

LP-178

Pico-ITX Motherboard

User's Manual

Edition 1.4

2023/05/05

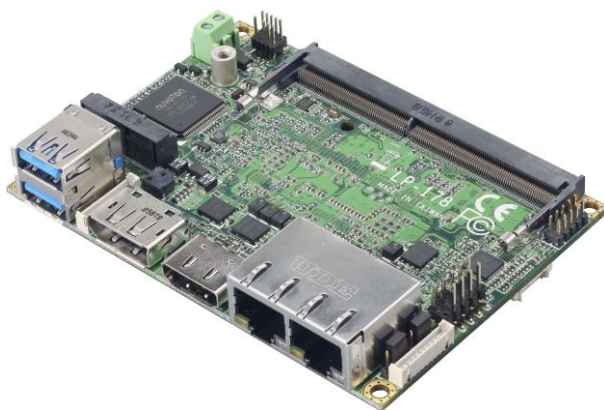

Copyright

Copyright 2023, all rights reserved. This document is copyrighted and all rights are reserved. The information in this document is subject to change without prior notice to make improvements to the products.

This document contains proprietary information and protected by copyright. No part of this document may be reproduced, copied, or translated in any form or any means without prior written permission of the manufacturer.

All trademarks and/or registered trademarks contains in this document are property of their respective owners.

Disclaimer

The company shall not be liable for any incidental or consequential damages resulting from the performance or use of this product.

The company does not issue a warranty of any kind, express or implied, including without limitation implied warranties of merchantability or fitness for a particular purpose.

The company has the right to revise the manual or include changes in the specifications of the product described within it at any time without notice and without obligation to notify any person of such revision or changes.

Trademark

All trademarks are the property of their respective holders.

Any questions please visit our website at <http://www.commell.com.tw>

Packing List:

Please check the package content before you starting using the board.



1 x LP-178 Pico-ITX Motherboard
(Including Cooler Fan)



1 x DC Input Power Cable
(OALDC-B / 1040513)



1 x SATA & SATA Power Cable
(OALSATA22B-PM15SH15 / 1040512)

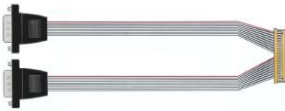

1 x Dual COM Cable
(OALES-BKU2-H14NB / 1040379)

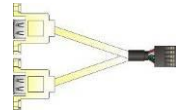

1 x USB2.0 cable
(OALUSBA-3 / 1040173)



1 x Audio cable
(OALPJ-HDUNB / 1040123)



1 x Driver CD
(Including User's Manual)

Optional module:



ADP-3355
DisplayPort to VGA module



ADP-3460E
DisplayPort to LVDS module

Index

Chapter 1 <Introduction>	5
1.1 <Product Overview>.....	5
1.2 <Product Specification>	6
1.3 <Block Diagram>.....	7
Chapter 2 <Hardware setup>	8
2.1 <Connector Location and Reference>	8
2.1.1 <Internal connectors list>	9
2.1.2 <External connectors list>.....	9
2.2 <Jumper Location and Reference>	10
2.2.1 <Jumper list>	10
2.2.2 <Clear CMOS and Power on type selection>.....	11
2.3 <Installing the Memory>	12
2.4 <I/O interface>	13
2.4.1 <Serial ATA interface>.....	13
2.4.2 <Ethernet interface>.....	14
2.4.3 <Display interface>	14
2.4.4 <Serial Port interface>	16
2.4.5 <USB interface>.....	17
2.4.6 <Audio interface>.....	18
2.4.7 <Expansion slot>.....	19
2.4.8 <Front panel switch and indicator>	20
2.4.9 <SMBus and Other Interface>	21
2.5 <Power supply>	23
2.5.1 <Power input>.....	23
2.5.2 <Power output>.....	23
Appendix A <Flash BIOS>	25
Appendix B <LCD Panel Type select>	26
Appendix C <Programmable Watch Dog Timer>	28
Appendix D <Hardware Monitor>	30
Appendix E <Setup ADP-3355,ADP-3460E>	31
Contact information	32

Chapter 1 <Introduction>

1.1 <Product Overview>

LP-178 is a Pico-ITX Motherboard which supports 8th Generation Intel® Core™ U-Series processors, integrated HD Graphics, DDR4 memory, Realtek High Definition Audio, Intel Gigabit LAN, USB3.1 Gen2, SATA3 with AHCI function for a system.

New feature for Whiskey Lake

Whiskey Lake U processors are based on the 14nm++ process node, and offer long-life availability. They have a TDP of 15W, and integrate Gen 9.5 Intel Graphics GT2. It allows triple independent display with 4K resolution.

All in One multimedia solution

The board provides high performance onboard graphics, and supports DisplayPort, HDMI, and High Definition Audio, to meet the very requirement of the multimedia application.

Whiskey Lake support Windows10 64bit RS5 and Linux

Intel recommends using Windows 10 64bit RS5. It may lose some drivers if you use other Windows version.

1.2 <Product Specification>

System

Processor	Intel® Whiskey Lake Processor FCBGA1528 package
Memory	1 x DDR4 SO-DIMM 2400 MHz up to 32GB (Note1), Support Non-ECC, unbuffered memory
Watchdog Timer	Generates a system reset with internal timer for 1min/s ~ 255min/s
Real Time Clock	Chipset integrated RTC with onboard lithium battery
Expansion	1 x M.2 (Key E) for Wi-Fi and Bluetooth 2230mm

Graphics

Chipset	Intel® Gen 9.5 integrated HD Graphics
Display Interface	1 x DisplayPort, 1 x HDMI

LAN

Chip	1 x Intel® I210-AT Gigabit LAN, 1 x Intel® I219-LM Gigabit PHY LAN (Support iAMT12.0)
------	--

I/O

Serial ATA	1 x SATA3
Audio	Realtek ALC262 HD Audio
Internal I/O	1 x SATA3, 2 x USB2.0, 2 x RS232, 1 x Header for LVDS or VGA, 1 x Audio, 1 x LPC, 1 x SMBus
Rear I/O	1 x DisplayPort, 1 x HDMI, 2 x USB3.1 Gen2, 2 x LAN

Mechanical & Environmental

Power Requirement	DC input 12V±5%
Size	100 mm x 72mm (L x W)
Temperature	Operating within 0°C~60°C (32°F~140°F) Storage within -20°C~80°C (-4°F~176°F)
Relative Humidity	10%~90%, non-condensing

Note1: Celeron 4305UE support up to 2133 MHz.

1.3 <Block Diagram>

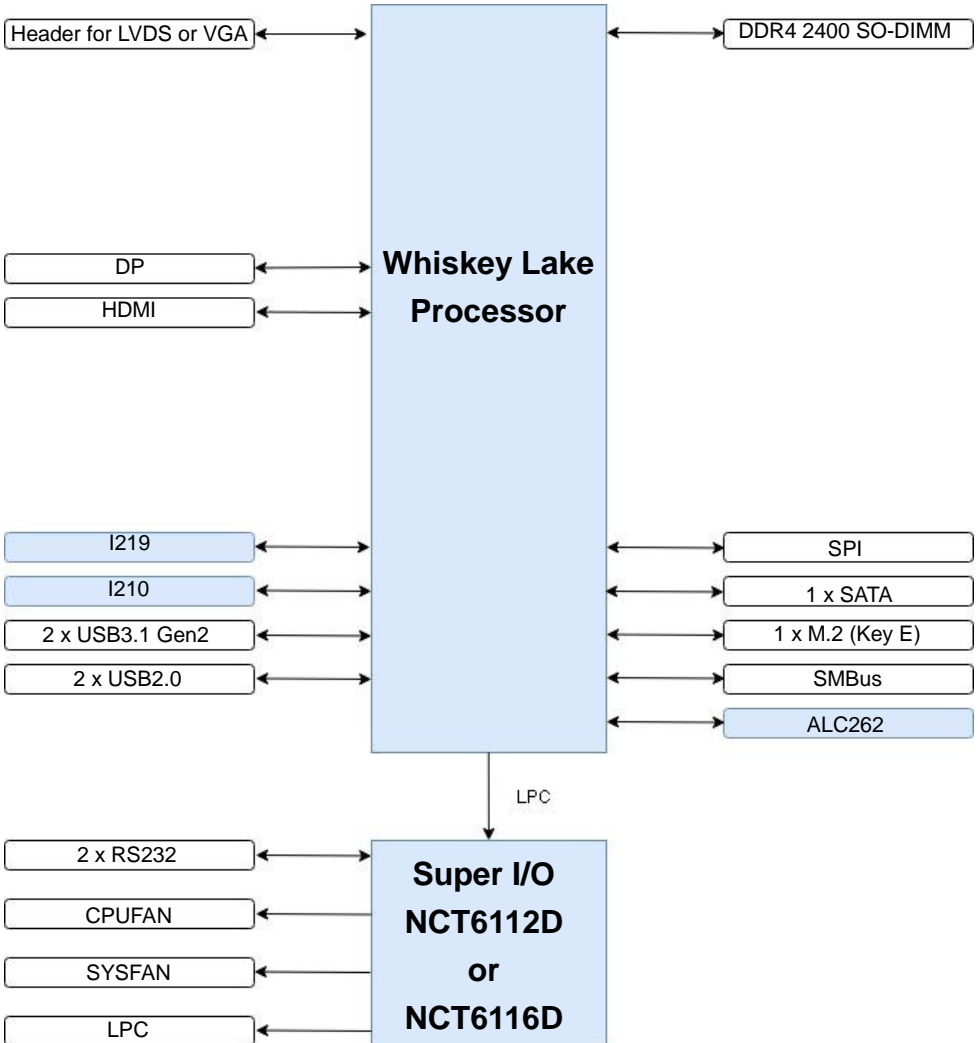

Chapter 2 <Hardware setup>

2.1 <Connector Location and Reference>

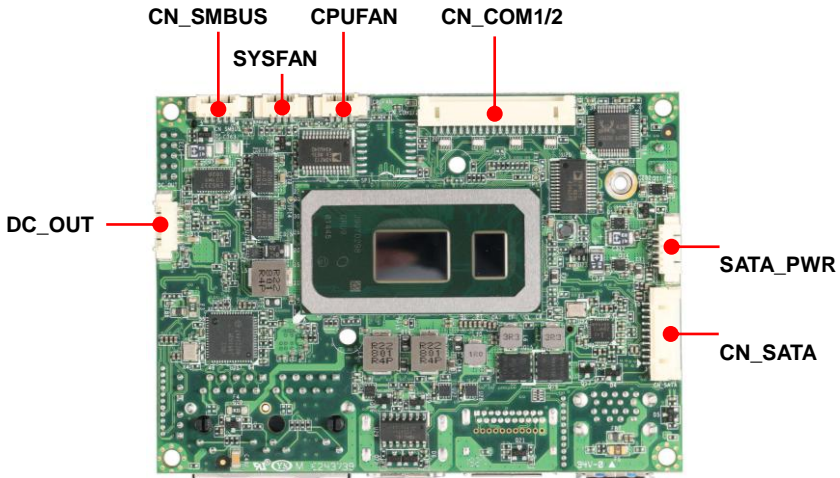
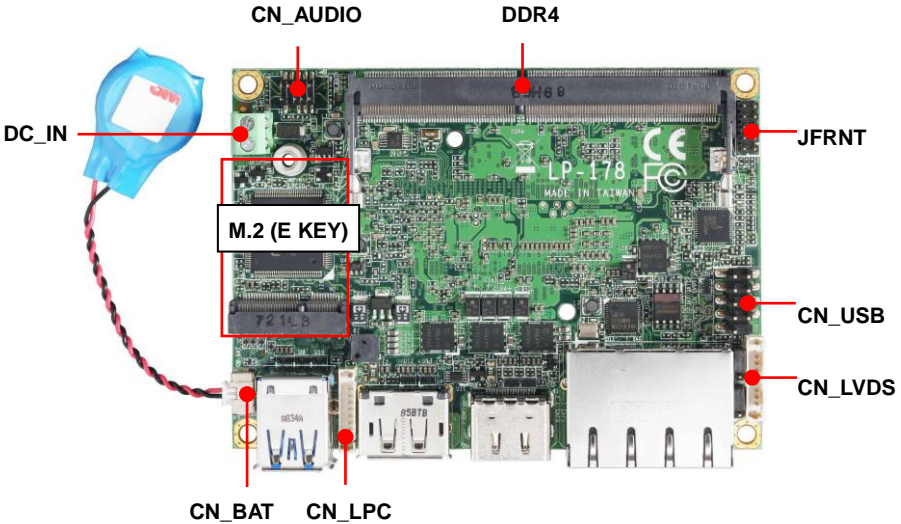

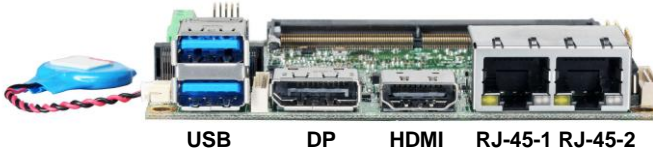

2.1.1 <Internal connectors list>

Connector	Function
DDR4	260-pin DDR4 SO-DIMM slot
CN_SATA	10-pin Serial ATA3 connector
CN_AUDIO	5 x 2-pin audio pin header
CN_LPC	11-pin LPC pin header
CN_LVDS	11-pin connector (For ADP-3460E or ADP-3355)
CN_COM1/2	19-pin RS232 connector
CN_USB	5 x 2-pin USB2.0 pin header
CN_SMBus	5-pin SMBus connector
CPUFAN	4-pin CPU fan connector
SYSFAN	4-pin System fan connector
JFRNT	5 x 2-pin front panel switch/indicator pin header
M2	75-pin M.2 Key E slot
DC_OUT	6-pin Power connector
SATA_PWR	6-pin SATA Power connector
DC_IN	2-pin power input Terminal Block (DC 12V±5% ONLY)

2.1.2 <External connectors list>

Connector	Function
HDMI	HDMI connector
DP	DisplayPort connector
USB	2 x USB3.1 Gen2 connector
RJ-45-1	RJ45 connector (I219)
RJ-45-2	RJ45 connector (I210)

2.2 <Jumper Location and Reference>

2.2.1 <Jumper list>

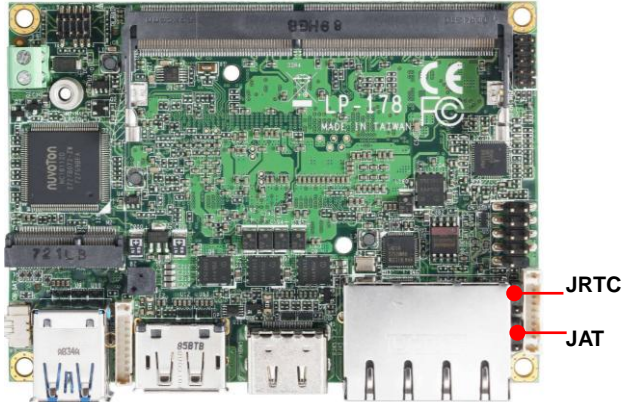

Jumper	Function
JAT	Power mode select
JRTC	CMOS Normal/Clear Setting

2.2.2 <Clear CMOS and Power on type selection>

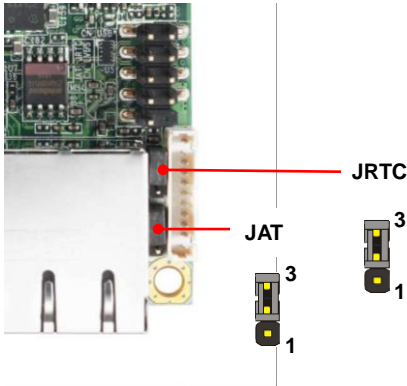

JRTC: Clear CMOS data jumper

Jumper settings	Function
1-2	Clear CMOS
2-3	Normal (Default)

JAT: AT/ATX mode select jumper

Jumper settings	Function
1-2	AT mode
2-3	ATX mode (Default)

2.3 <Installing the Memory>

LP-178 has 260-pin DDR4 SODIMM support up to 32GB of memory capacity and 1.2 Voltage. Only Non-ECC memory is supported.

In the process, the board must be powered off.

1. Put the memory tilt into the slot. Note the Memory notch key aligned slot key.
2. Then press down till lock into the mounting notch.

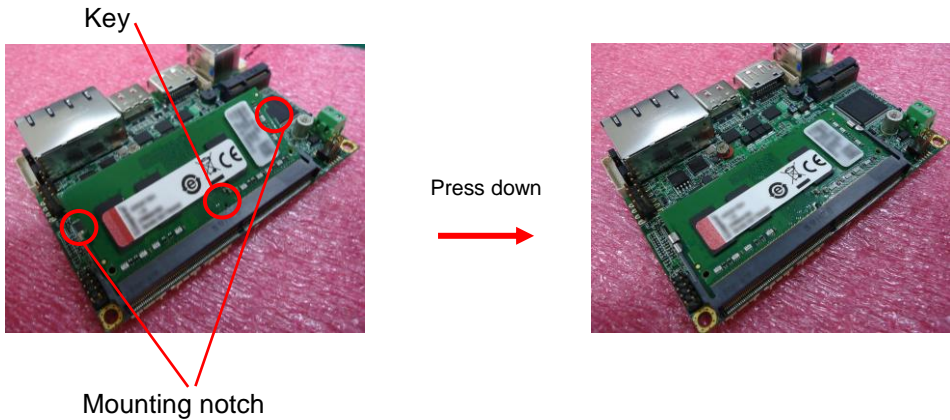

3. To remove the memory, push outward on both sides of the latch.

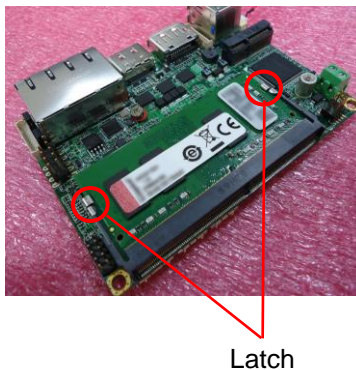

2.4 </I/O interface>

2.4.1 <Serial ATA interface>

CN_SATA: SATA3 10-pin connector

Pin	Signal
1	GND
2	TX+
3	TX-
4	GND
5	NA
6	NA
7	GND
8	RX-
9	RX+
10	GND

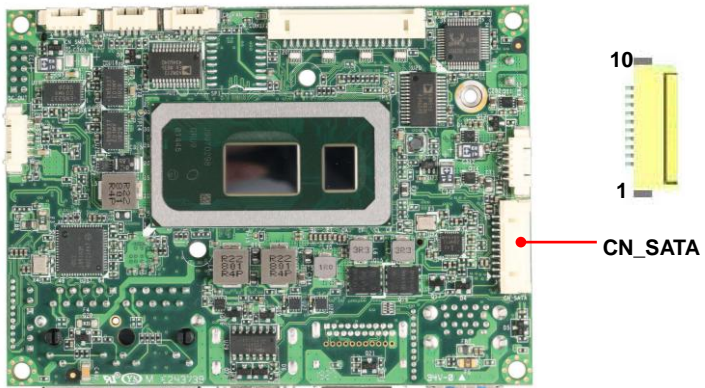

2.4.2 <Ethernet interface>

The board provides I210-AT and I219-LM Gigabit Ethernet which support Wake on LAN. It supports Intel® AMT 12.0 feature on I219-LM.

(Note that the CPU must support vPro technology.)



I219 I210

2.4.3 <Display interface>

Based on the 8th Gen CPU with built-in HD Graphics, the DisplayPort resolution up to 3840x2160 @ 60Hz or 4096x2304 @ 60Hz, the HDMI up to 4096x2304 @ 24Hz and LVDS up to 1920x1200 @ 60Hz supports single bus or dual bus LVDS signaling with color depths of 18 bits or 24 bits. About select LCD Panel Type in BIOS, please refer [Appendix B](#). The built-in HD Graphics support triple display function with clone mode and extended mode.



CN_LVDS
11

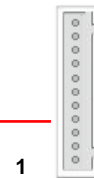

1



DP HDMI

CN_LVDS: 11-pin connector

Pin	Signal	Pin	Signal
1	eDP_0+	2	eDP_0-
3	GND	4	eDP_1+
5	eDP_1-	6	GND
7	eDP_AUX+	8	eDP_AUX-
9	GND	10	HPD
11	3.3V		

There are two modules [ADP-3355](#) and [ADP-3460E](#), you can choose the one to support VGA or LVDS, please refer [Appendix E](#).

2.4.4 <Serial Port interface>

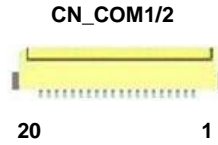
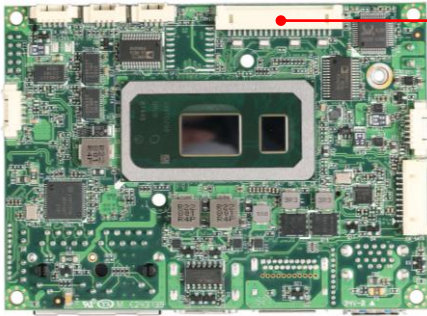

CN_COM1/2: RS232 20-pin connector

Pin	Signal	Pin	Signal
1	DCD1	2	RXD1
3	TXD1	4	DTR1
5	GND	6	DSR1
7	RTS1	8	CTS1
9	RI1	10	NC
11	DCD2	12	RXD2
13	TXD2	14	DTR2
15	GND	16	DSR2
17	RTS2	18	CTS2
19	RI2	20	Key

2.4.5 <USB interface>

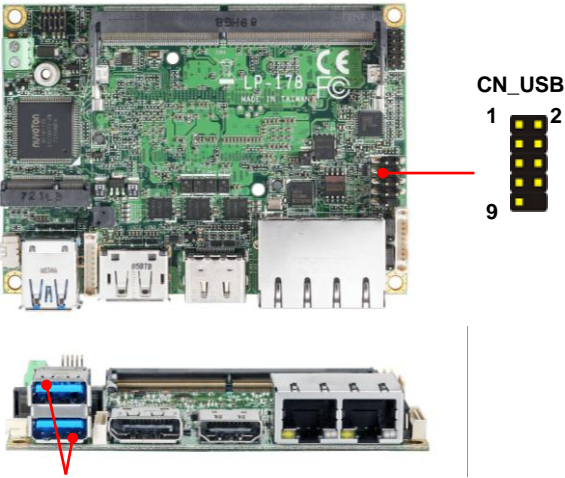

USB3.1 Gen2

CN_USB: Front panel USB2.0 10-pin header (Pitch 2.54mm)

Pin	Signal	Pin	Signal
1	5VSB	2	5VSB
3	DATA0-	4	DATA1-
5	DATA0+	6	DATA1+
7	GND	8	GND
9	GND	10	Key

2.4.6 <Audio interface>



CN_AUDIO: Front panel audio 10-pin header (Pitch 1.27mm x 2.54mm)

Pin	Signal	Pin	Signal
1	MIC_L	2	GND
3	MIC_R	4	NC
5	FP_OUT_R	6	MIC_DETECT
7	SENSE	8	Key
9	FP_OUT_L	10	FP_OUT_DETECT

2.4.7 <Expansion slot>

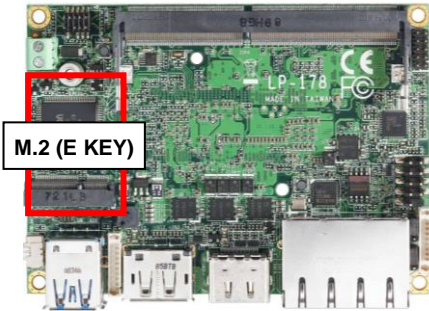

M2 (Key E) with 2 x PCI Express x1 support WI-FI and Bluetooth Module

2.4.8 <Front panel switch and indicator>

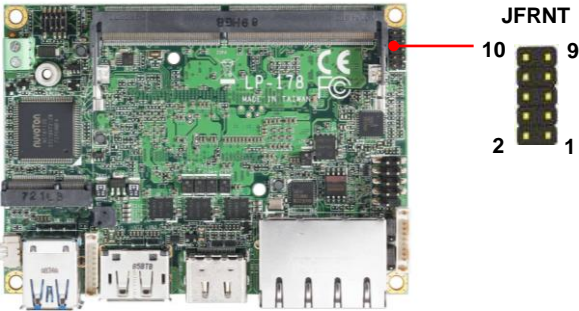

JFRNT: Front panel switch and indicator 10-pin header

Pin	Signal	Pin	Signal
1	Power_ON-	2	Power_ON+
3	Speaker-	4	Speaker+
5	HDD_LED-	6	HDD_LED+
7	Power_LED-	8	Power_LED+
9	Reset+	10	Reset-

2.4.9 <SMBus and Other Interface>

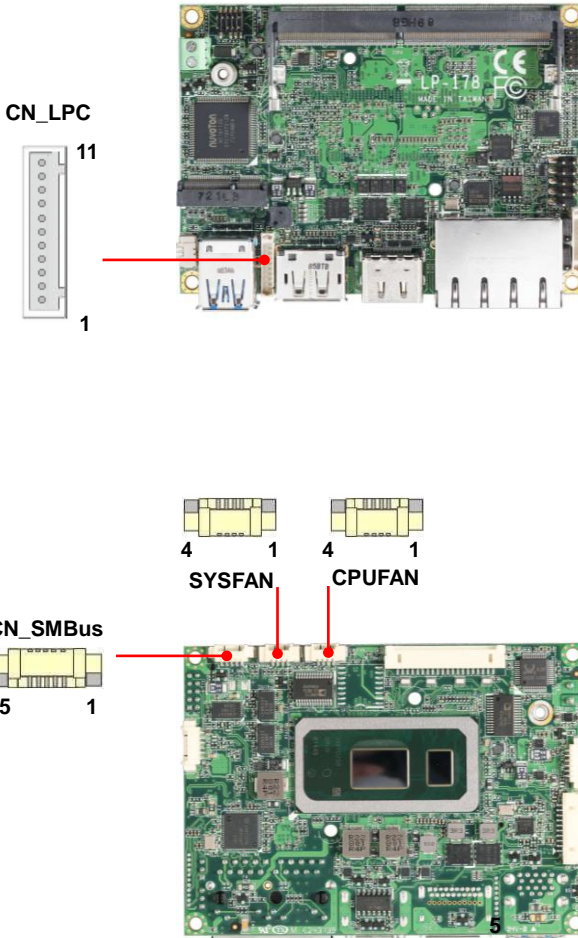

CN_SMBus: SMBus 5-pin connector

Pin	Signal
1	5V
2	NC
3	SMBDAT
4	SMBCLK
5	GND

CPUFAN: CPU cooler fan 4-pin connector

Pin	1	2	3	4
Signal	GND	12V	Sensor	Control

SYSFAN: System cooler fan 4-pin connector

Pin	1	2	3	4
Signal	GND	12V	Sensor	Control

CN_LPC: LPC 11-pin header

Pin	Signal
1	CLK
2	RST
3	-LFRAME
4	LAD3
5	LAD2
6	LAD1
7	LAD0
8	3.3V
9	SERIRQ
10	GND
11	NC

2.5 <Power supply>

2.5.1 <Power input>

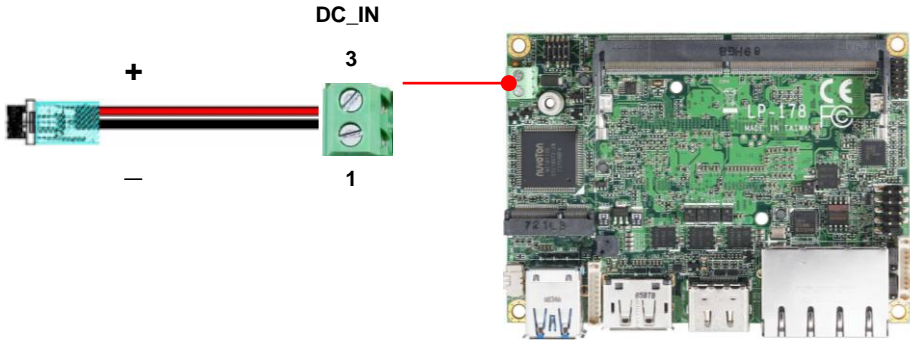

DC_IN: Terminal block 2-pin power connector

Pin	Signal	Pin	Signal
1	GND	3	12V \pm 5%

2.5.2 <Power output>

DC_OUT

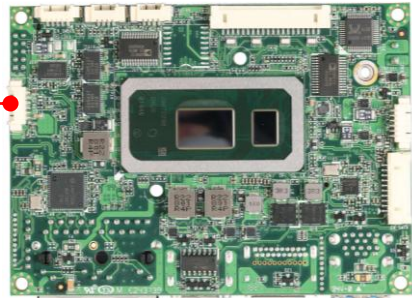
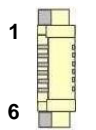

DC_OUT: power 6-pin connector

Pin	Signal
1	12V
2	12V
3	GND
4	GND
5	5V
6	5V

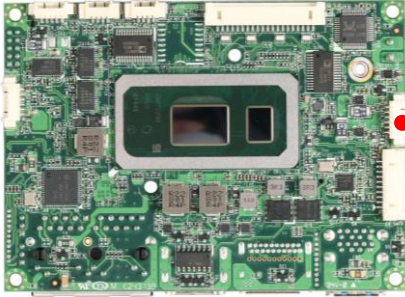

SATA_PWR

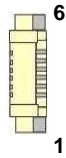

SATA_PWR: power 6-pin connector

Pin	Signal
1	NC
2	NC
3	GND
4	GND
5	5V
6	5V

Appendix A <Flash BIOS>

A.1 <Flash tool>

The board is based on Insyde BIOS and can be updated easily by the BIOS auto flash tool. You can download the tool online at the address below:

[FPT Tool](#)

The tool's file name is "FPT.exe", it's the utility that can write the data into the BIOS flash chip and update the BIOS.

A.2 <Flash BIOS process>

1. Press Del to Enter BIOS Menu
2. On Front Page screen, click Setup Utility
3. On Advanced screen, click PCH-IO Configuration, then click Security Configuration
4. Set BIOS Lock to [Disabled], then save changes.

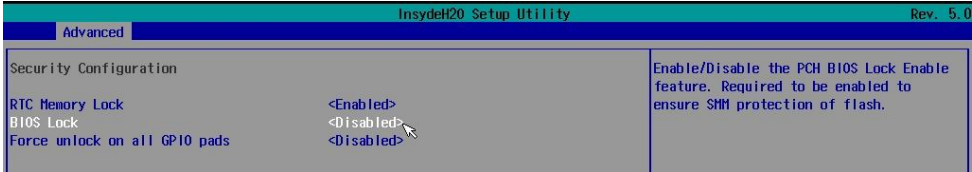

5. Please make a boot-able Disk which could boot into DOS environment.
6. Un-zip attached files and copies it into boot-able Disk.
7. Power on the system and flash the BIOS under the DOS environment.

The instruction will be "C:/fpt_-savemac_-f_XXXX.BIN"

Note: a. Underscore means Space

b. xxxx.bin means the BIOS file that you want to update

8. Please turn off the system and clean CMOS by Jumper.
9. Turn on the system and update BIOS successful.

Appendix B <LCD Panel Type select>

According to your panel, it needs to select the correct resolution in the BIOS. If there is no fit for your panel type, please provide feedback for us to make an OEM model.

Find the setting from

Front Page-> Setup Utility

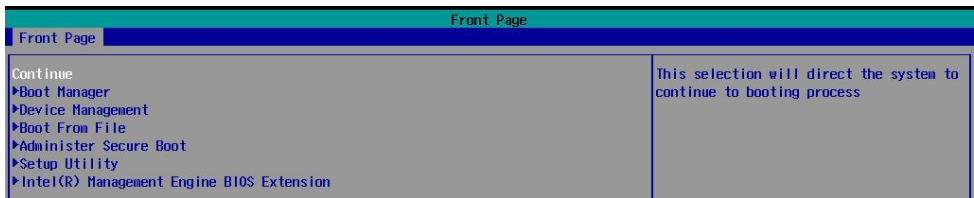

Advanced → LVDS Configuration



Set 18bit /24bit, Single /Dual channel in LVDS configuration

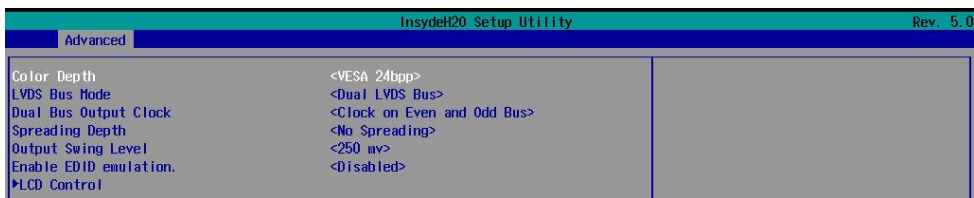

LVDS configuration → LCD Control

There are 16 resolutions in LCD Panel Type. (For Dual boot and Legacy boot)

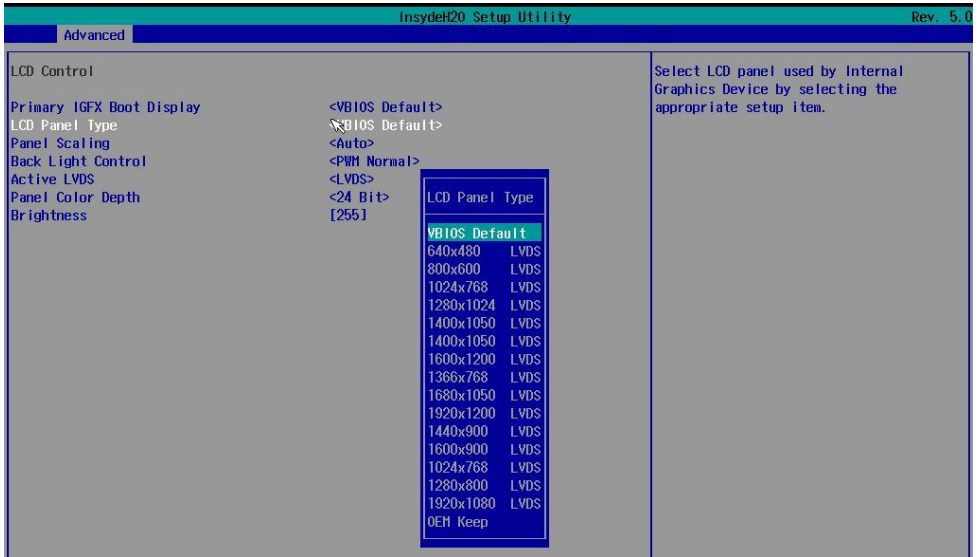
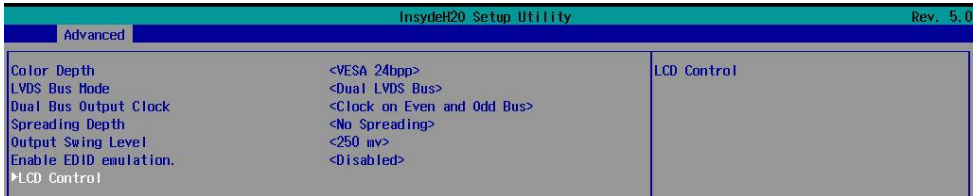

Appendix C <Programmable Watch Dog Timer>

The watchdog timer makes the system auto-reset while it stops to work for a period. The integrated watchdog timer can be setup as system reset mode by program. You can select Timer setting in the BIOS, after setting the time options, the system will reset according to the period of your selection.

Find the setting from

Advanced→Super IO Configuration

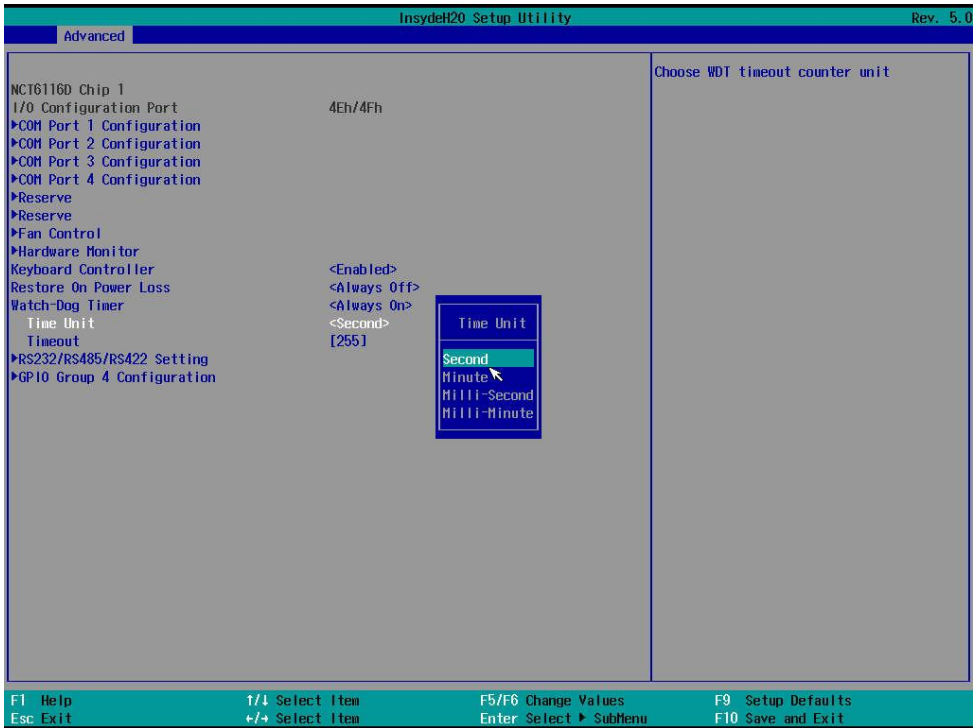

Timeout value range

1 to 255 Minute and Second

Program sample

Watchdog timer setup as system reset with 5 second of timeout

```
-o 4E 87      ;enter configuration
-o 4E 87
-o 4E 07
-o 4F 08      ;select Logical Device
-o 4E 30
-o 4F 01      ; activate WDTO# function
-o 4E F0
-o 4F 00      ;set "00" is second mode, set "08" is minute mode
-o 4E F1
-o 4F 05      ;00h: Timeout Disable
                ;01h: Timeout occurs after 1 minute only
                ;02h: Timeout occurs after 2 second/minute
                ;03h: Timeout occurs after 3 second/minute
                ;
                ;
                ;FFh: Timeout occurs after 255 second/minute
                (The deviation is approx 1 second.)
```

For further information, please refer to Nuvoton NCT6116D/NCT6112D datasheet

Appendix D <Hardware Monitor>

Find the setting from

Advanced → Super IO Configuration → Hardware Monitor

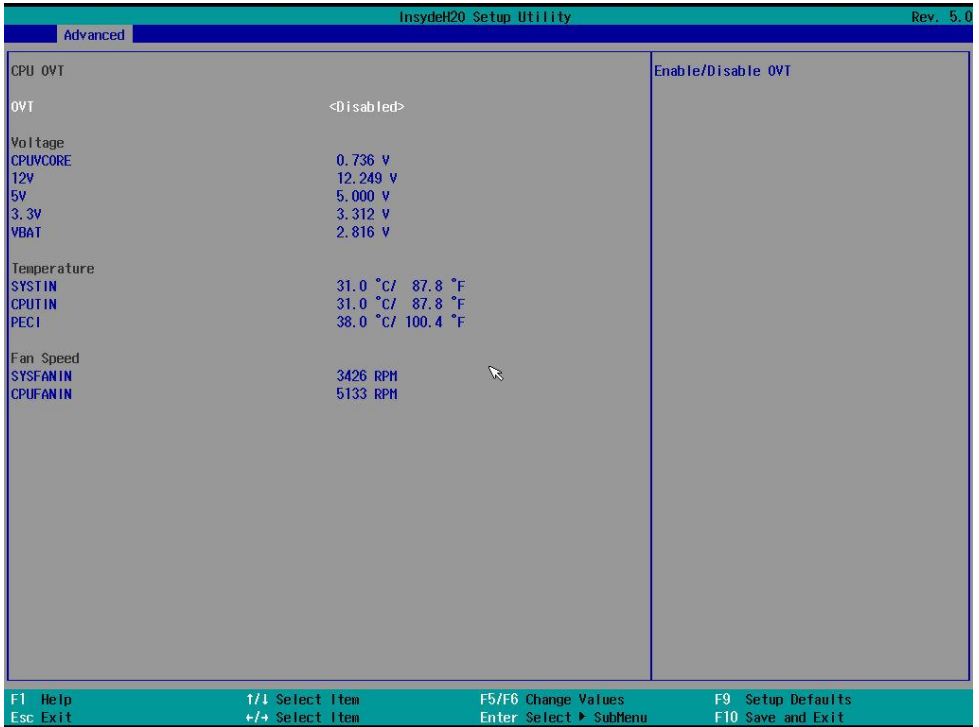

InsydeH20 Setup Utility		Rev. 5.0
Advanced		
CPU OVT		Enable/Disable OVT
OVT	<Disabled>	
Voltage		
CPUV CORE	0.736 V	
12V	12.249 V	
5V	5.000 V	
3.3V	3.312 V	
VBAT	2.816 V	
Temperature		
SYSTEM	31.0 °C/ 87.8 °F	
CPU	31.0 °C/ 87.8 °F	
PCH	38.0 °C/ 100.4 °F	
Fan Speed		
SYSFAN IN	3426 RPM	
CPUFAN IN	5133 RPM	

F1 Help ↑/↓ Select Item F5/F6 Change Values F9 Setup Defaults
 Esc Exit ←/→ Select Item Enter Select ▶ Submenu F10 Save and Exit

Appendix E <Setup ADP-3355,ADP-3460E>

LP-178 have a Header for VGA or LVDS , it's no need install extra driver.

You have to connect SMBus cable to LP-178 (Please see the [picture](#) below), then LVDS Configuration in BIOS Setup menu can work.

For further information, please refer to the manual.

[ADP-3355 manual](#)

[ADP-3460 manual](#)

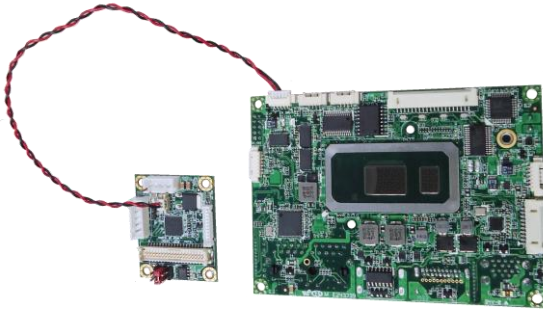

Contact information

Any advice or comment about our products and service, or anything we can help you please don't hesitate to contact with us. We will do our best to support you for your products, projects and business.

Taiwan Commate computer Inc.

Address	19F., NO.94, Sec. 1, Xintai 5 th Rd., Xizhi Dist., New Taipei City 22102, Taiwan.
TEL	+886-2-26963909
Website	www.commell.com.tw
E-mail	info@commell.com.tw (General information) tech@commell.com.tw (Technical Support)

Commell is a brand name of Taiwan Commate computer Inc.