

LP-177

Pico-ITX Motherboard

User's Manual

Edition 1.7

2021/03/29

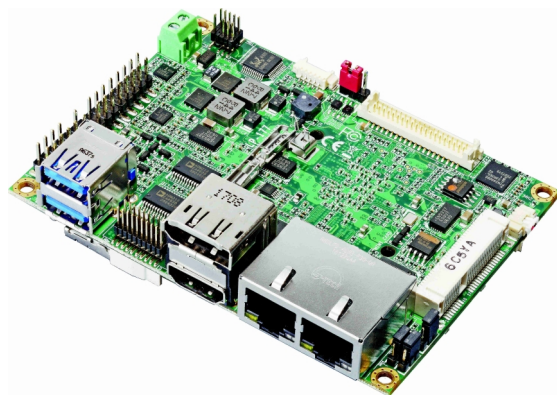

Copyright

Copyright 2021, all rights reserved. This document is copyrighted and all rights are reserved. The information in this document is subject to change without prior notice to make improvements to the products.

This document contains proprietary information and protected by copyright. No part of this document may be reproduced, copied, or translated in any form or any means without prior written permission of the manufacturer.

All trademarks and/or registered trademarks contains in this document are property of their respective owners.

Disclaimer

The company shall not be liable for any incidental or consequential damages resulting from the performance or use of this product.

The company does not issue a warranty of any kind, express or implied, including without limitation implied warranties of merchantability or fitness for a particular purpose.

The company has the right to revise the manual or include changes in the specifications of the product described within it at any time without notice and without obligation to notify any person of such revision or changes.

Trademark

All trademarks are the property of their respective holders.

Any questions please visit our website at <http://www.commell.com.tw>

Packing List:

Please check the package content before you starting using the board.



1 x LP-177 Motherboard



1 x SATA Cable
(OALSATA22B-PM15SH15) / (1040512)



1 xDC Input Power Cable
(OALDC-B / 1040513)



1 x PS/2 Keyboard & Mouse cable
(OALPS2/KM / 1040131)

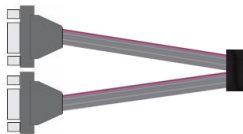

1 x Dual COM cable
(OALE5-BKU2NB / 1040090)

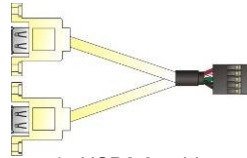

1 xUSB2.0 cable
(OALUSBA-3 / 1040173)

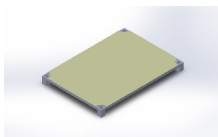

1 x Heat spreader
(OHS-176 / 2181110015)
(For LP-177P(T)N3(4)S)



1 x Audio cable
(OALPJ-HDUNB / 1040123)

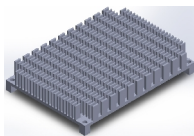

1 x Heatsink (Optional)
(OHS-176-01 / 2181110026)

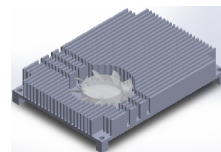

1 x Cooler fan
(OHSF-177 / 2181010032)(For LP-177P(T)N3(4)F)
(OHSF-177E / 2181010037)(For LP-177P(T)EF)



1 x Driver CD
(Including User's Manual)



1 x DDR3L SO-DIMM (Optional)
(DSDM8GB-DDR3L-1600-SO-1.35V / 1140092)

Index

Chapter 1 <Introduction>	4
1.1 <Product Overview>	4
1.2 <Product Specification>	5
1.3 <Block Diagram>	6
Chapter 2 <Hardware setup>	7
2.1 <Connector Location and Reference>	7
2.1.1 <Internal connectors list>	8
2.1.2 <External connectors list>	8
2.2 <Jumper Location and Reference>	9
2.2.1 <Jumper list>	9
2.2.2 <Clear CMOS and Power on type selection>	9
2.3 <Installing the Memory>	10
2.4 <Installing Heat Spreader/ Cooler fan>	11
2.5 <I/O interface>	15
2.5.1 <Serial ATA interface>	15
2.5.2 <Ethernet interface>	15
2.5.3 <Display interface>	16
2.5.4 <Serial Port interface>	18
2.5.5 <USB interface>	19
2.5.6 <Audio interface>	20
2.5.7 <Expansion slot>	21
2.5.8 <Front panel switch and indicator>	22
2.5.9 <Other interface>	23
2.6 <Power supply>	25
2.6.1 <Power input>	25
2.6.2 <Power output>	25
Appendix A <Flash BIOS>	26
A.1 BIOS Auto Flash Tool	26
A.2 Flash Method	26
Appendix B <LCD Panel Type select>	27
Appendix C <Programmable Watch Dog Timer>	29
Appendix D <Setup ADP-3355, ADP-3460>	30
Appendix E <SuperIO Setting>	30
Contact information	31

Chapter 1 <Introduction>

1.1 <Product Overview>

LP-177 is pico Motherboard which is design based on Celeron® Processor N3350, Pentium® N4200, and Atom™ x7-E3950(Apollo Lake SoC), delivering outstanding compute, graphical, and media performance while operating in an extended range of thermal conditions. The SoC bases on the Silvermont microarchitecture, utilizing Intel's industry-leading 14nm process technology with 3-D Tri-Gate transistors, which deliver significant improvements in computational performance and energy efficiency.

New features for Apollo Lake

Celeron® Processor N3350, and Pentium® Processor N4200 have a lower TDP 6W, it provides new HD Graphics to support triple display, 4K resolution, maximum memory size is up to 8GB of DDR3L, and more enhanced security that is suitable for a variety of intelligent systems the ideal choice.

All in One multimedia solution

The board provides high performance onboard graphics, 18/24-bit single/dual channel LVDS interface, DisplayPort, HDMI, and High Definition Audio, to meet the very requirement of the multimedia application.

Flexible Expansion Interface

The board provides one MiniPCIe and support mSATA.

Apollo Lake only support Windows10 64bit

So far Intel just support Windows 10 64bit. It may lose some drivers if you use other Windows version.

1.2 <Product Specification>

System

Processor	Intel® Apollo Lake Series Processor N3350/ N4200/x7-E3950, FCBGA1296 package
Chipset	Apollo Lake SoC
Memory	1 x DDR3L SO-DIMM 1866 MHz up to 8GB, Support Non-ECC, unbuffered memory only
Watchdog Timer	Generates a system reset with internal timer for 1min/s ~ 255min/s
Real Time Clock	Chipset integrated RTC with lithium battery
Expansion	1 x MiniPCIe (support mSATA)

Graphics

Chipset	Intel® HD Graphics
Display Interface	1 x LVDS, 1 x HDMI, 1 x DisplayPort/VGA/ 2nd LVDS(Optional)

LAN

Chip	2 x Intel® I210-AT Gigabit LAN
------	--------------------------------

I/O

Serial ATA	1 x SATA3
Audio	Realtek ALC262 HD Audio
Internal I/O	1 x SATA3, 2 x RS232, 2 x USB2.0, 1 x LPC, 1 x PS/2, 1 x SMBUS, 1 x LVDS, 1 x LCD inverter, 1 x Audio, 1 x VGA(Optional) 1 x 2nd LVDS(Optional)
Rear I/O	2 x USB3.0, 1 x LAN, 1 x HDMI, 1 x DisplayPort(Optional).

Mechanical & Environmental

Power Requirement	DC INPUT 5V
Size & Thickness	100mm x 72mm (L x W)
Temperature	Operating within 0°C~60°C Storage within -20°C~80°C (For LP-177 N3350/N4200 Series) Operating within -40°C~85°C Storage within -40°C~85°C (For LP-177 x7-E3950 Series)
Relative Humidity	10%~90%, non-condensing

1.3 <Block Diagram>

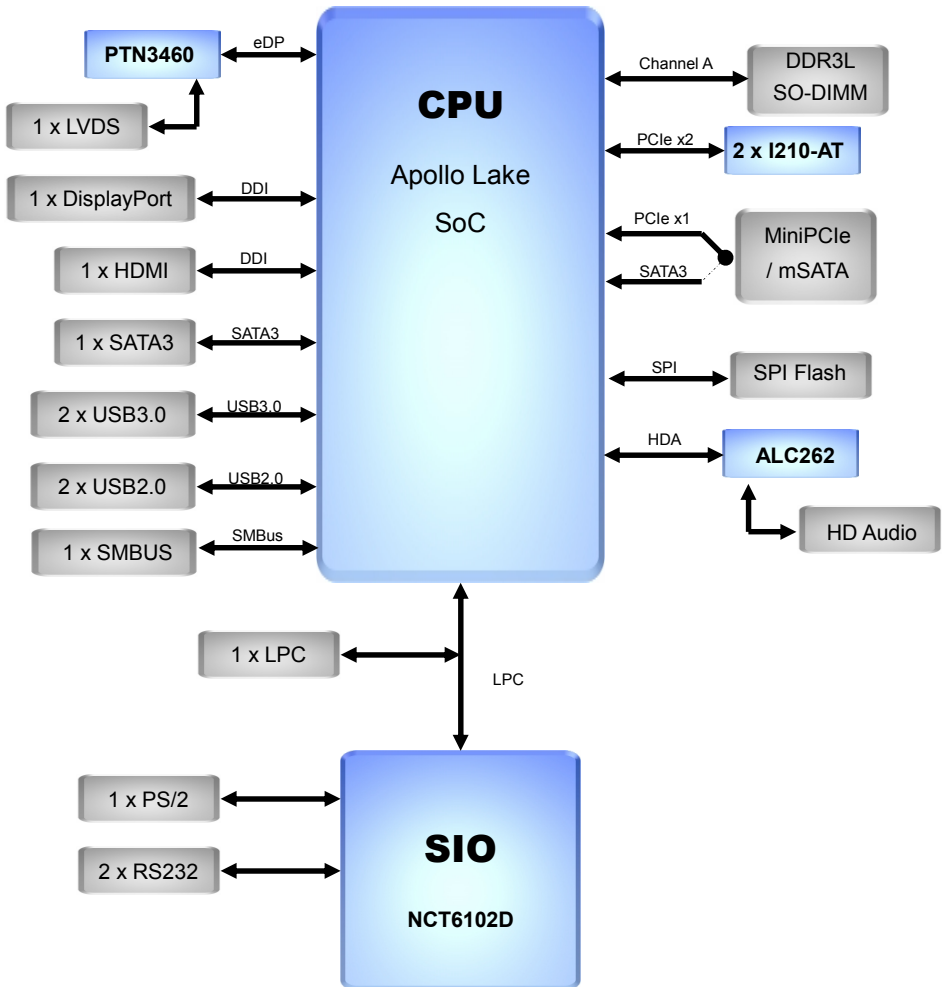

Chapter 2 <Hardware setup>

2.1 <Connector Location and Reference>

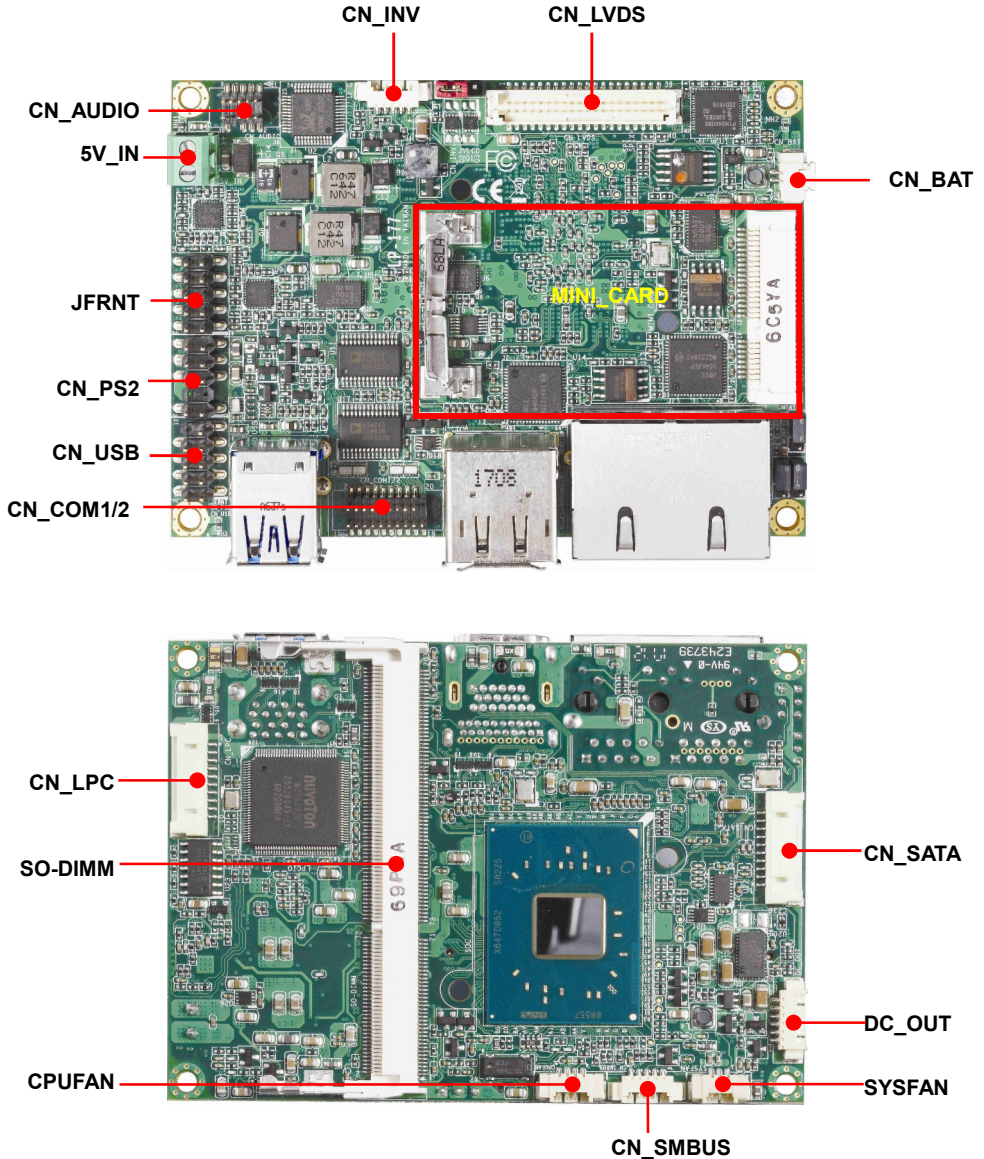

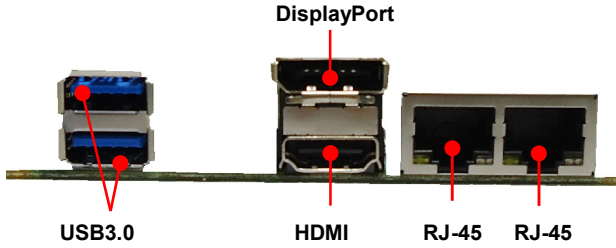

2.1.1 <Internal connectors list>

Connector	Function
SO-DIMM	204-pin DDR3L SO-DIMM slot
CN_SATA	10-pin Serial ATA3 connector
CN_AUDIO	5 x 2-pin audio pin header
CN_LPC	10 pin LPC pin header
CN_LVDS	20 x 2-pin LVDS connector
CN_INV	5-pin LCD inverter connector
CN_SMBUS	5-pin SMBus connector
CN_COM 1/2	19-pin RS232 connector
CN_USB	5 x 2-pin USB2.0 pin header
CN_PS2	5 x 2-pin PS/2 pin header
CPUFAN	4-pin CPU fan connector
SYSFAN	3-pin system fan connector
JFRNT	5 x 2-pin front panel switch/indicator pin header
MINI_CARD	52-pin MiniPCIe card slot
DC_OUT	6-pin SATA Power connector
5V_IN	2-pin power input Terminal Block (5V Only)

2.1.2 <External connectors list>

Connector	Function
DisplayPort	DisplayPort connector
HDMI	HDMI connector
USB3	2 x USB3.0 connector
RJ45	2 x RJ45 LAN connector

2.2 <Jumper Location and Reference>

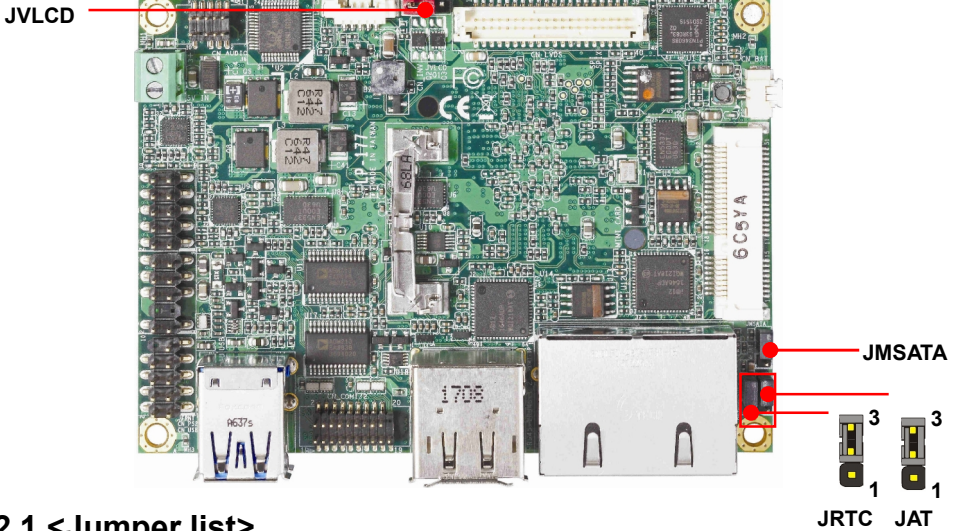

2.2.1 <Jumper list>

Jumper	Function
JAT	Power mode select
JRTC	CMOS Normal/Clear Setting
JVLCD	Panel Voltage Setting
JMSATA	MiniCard mSATA Setting

2.2.2 <Clear CMOS and Power on type selection>

JRTC: Clear CMOS data jumper

Jumper settings	Function
1-2	Clear CMOS
2-3	Normal (Default)

JAT: AT/ATX mode select jumper

Jumper settings	Function
1-2	AT mode
2-3	ATX mode (Default)

2.3 <Installing the Memory>

In the process, the board must be powered off.

1. In order to enhance the Heat dissipation when installed Heat Sink, We recommend to change the Memory sticker to another side.
2. Put the memory tilt into the slot. Note the Memory notch key aligned slot key.
3. Then press down till lock into the mounting notch.

Mounting notch

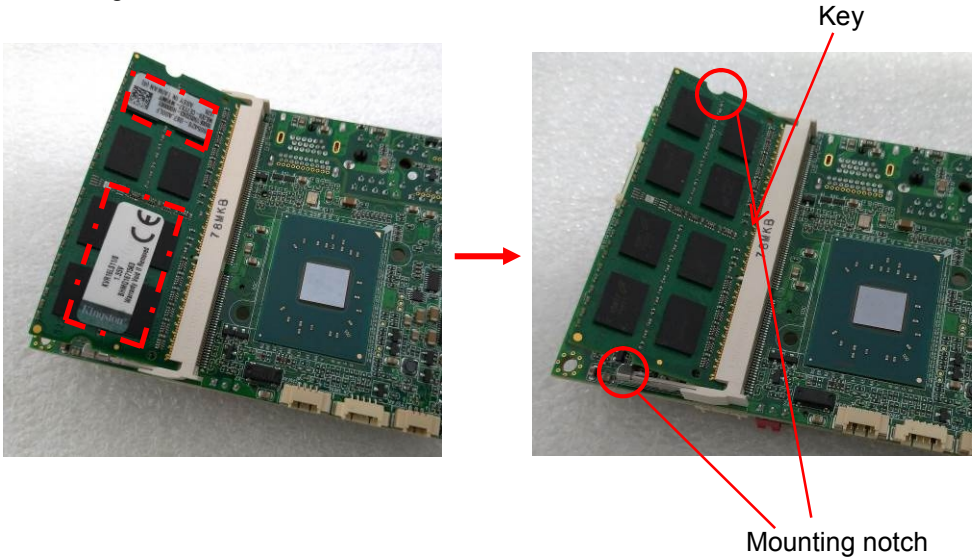

4. To remove the memory, push outward on both sides of the latch.

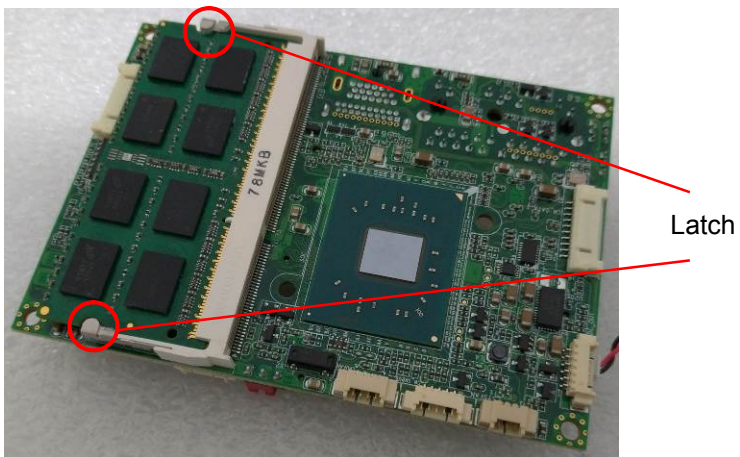

2.4 <Installing Heat Spreader/ Cooler fan>

1. Tears the film on the Thermal Pad of Heat Spreader/ Cooler Fan.

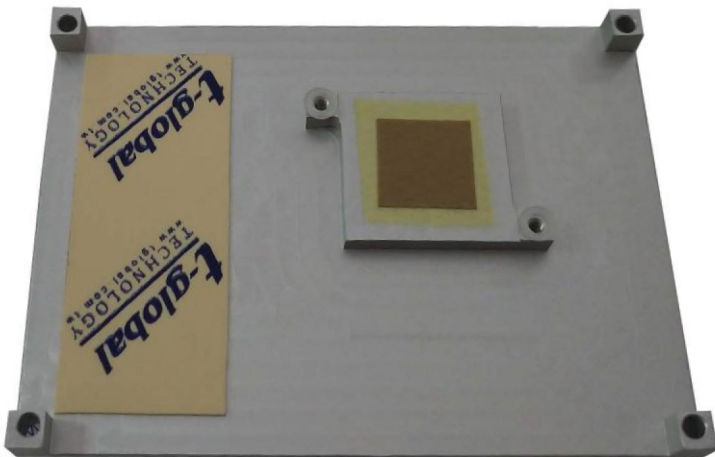
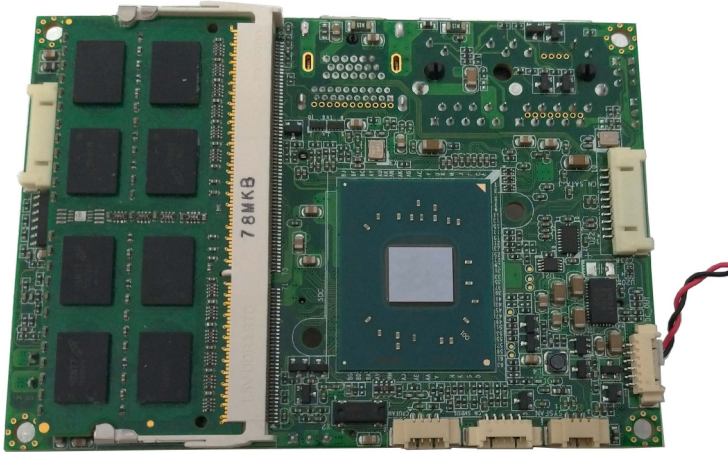

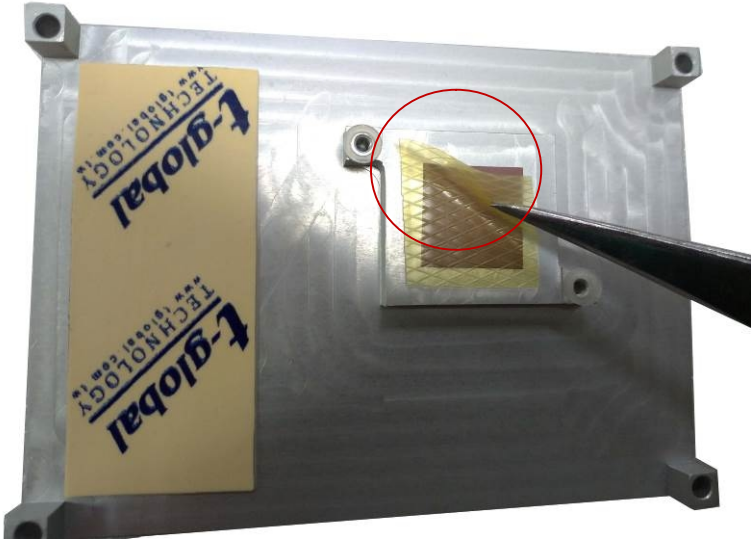

2. Install Heat Spreader/ Cooler Fan on LP-177.

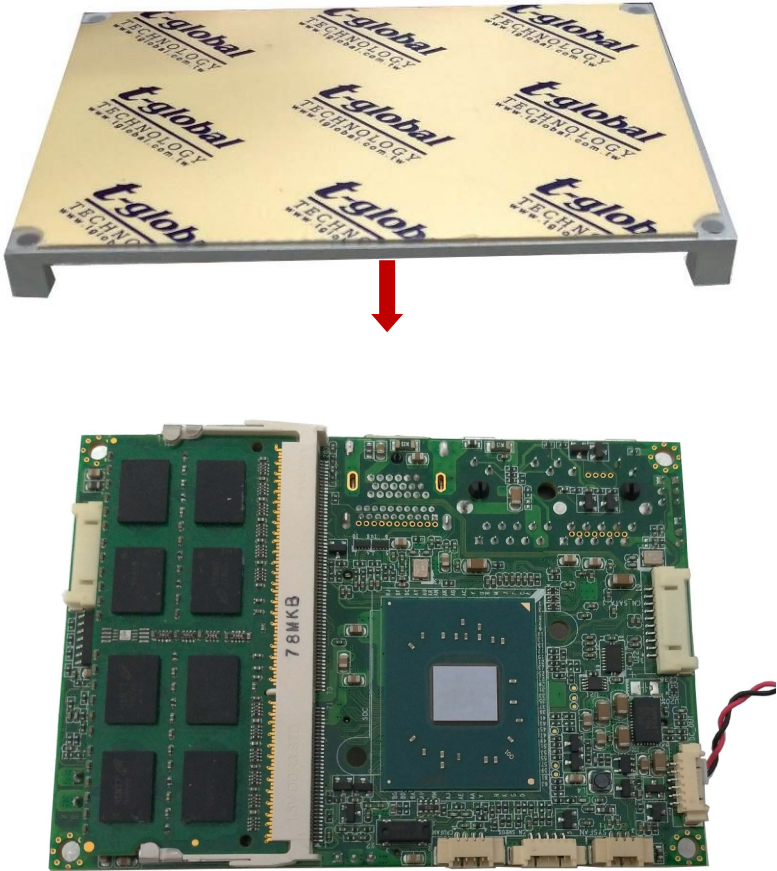

3. Place two washers and tighten two screws.

The suggestion screw torque of the Heat Spreader/ Cooler is 1.3KGf-cm

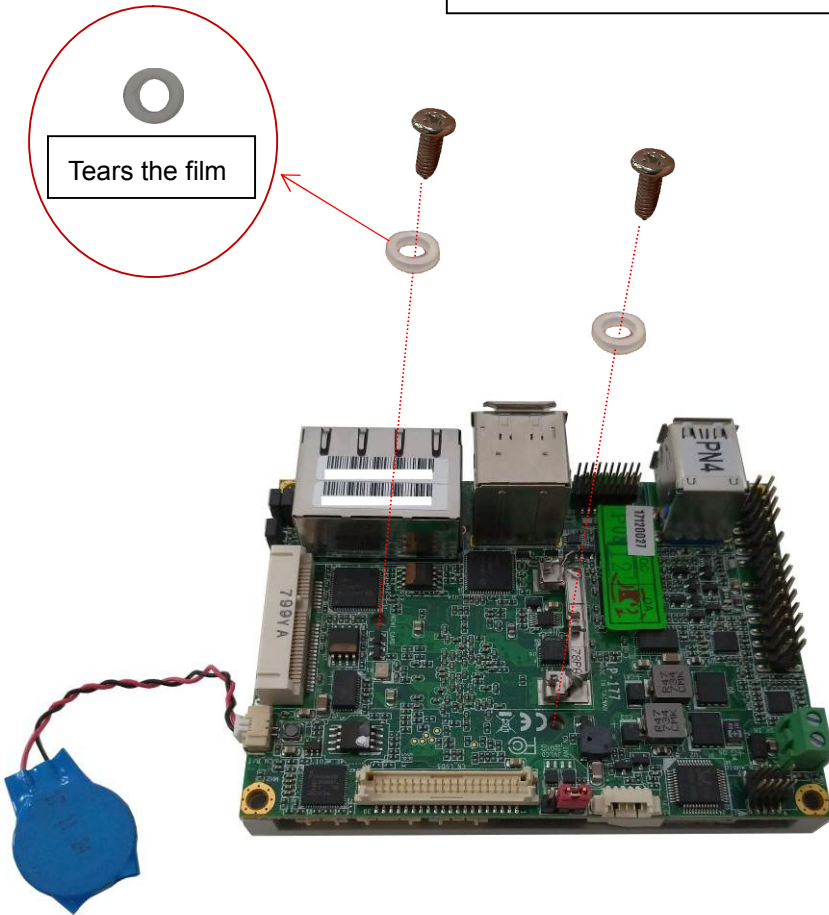

2.5 <I/O interface>

2.5.1 <Serial ATA interface>

CN_SATA: SATA3 10-pin connector

Pin	Signal
1	GND
2	TX+
3	TX-
4	GND
5	NC
6	NC
7	GND
8	RX-
9	RX+
10	GND

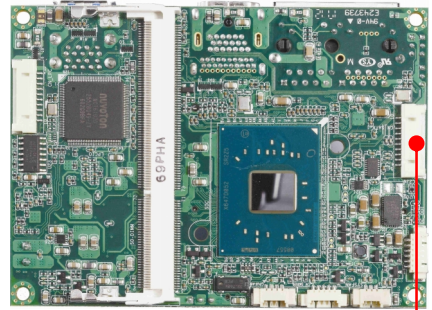

2.5.2 <Ethernet interface>

The board provide I210-AT Gigabit Ethernet which supports WOL on rear I/O.

Find the setting from

Front Page→Setup utility→

Advanced→South Cluster Configuration→ Miscellaneous Configuration→

Wake on LAN [Disable] (default)

(You have to turn off fast startup in Windows10)

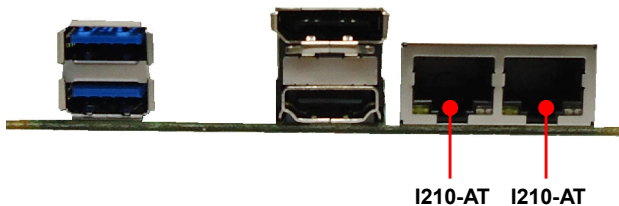

2.5.3 <Display interface>

Based on the Apollo Lake SoC with built-in HD Graphics, the DisplayPort1.2 up to **4096x2160 @ 60Hz** on rear I/O. About the internal Display, the HDMI1.4b resolution up to **3840x2160 @ 30Hz** and LVDS (PTN3460) up to **1920x1200 @ 60Hz** support 18/24-bit color depth and single/dual channel. About select LCD Panel Type in BIOS, please refer **Appendix B**. The built-in HD Graphics support triple display function with clone mode and extended mode.

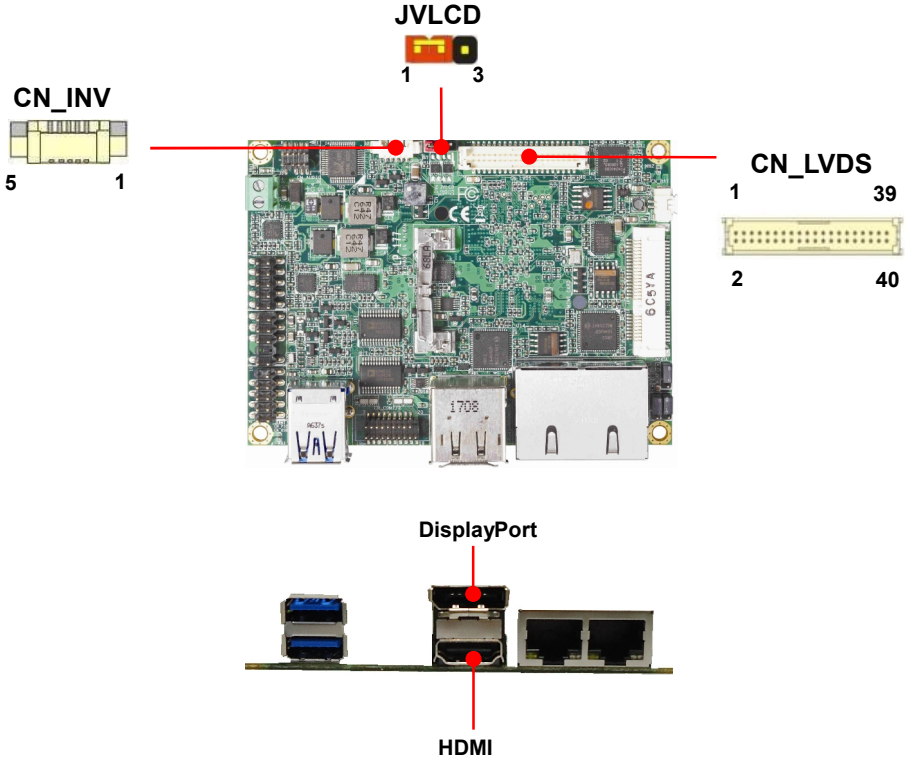

JVLCD: LVDS panel power select jumper

Jumper settings	Function
1-2	3.3V (Default)
2-3	5V

Effective patterns of connection: 1-2 / 2-3

Other may cause damage

CN_LVDS: LVDS 40-pin connector (Model: HIROSE DF13-40DP-1.25V compatible)

Pin	Signal	Pin	Signal
1	Set by JVLCD	2	Set by JVLCD
3	GND	4	Detect (Active low)
5	B_LVDS_0-	6	A_LVDS_0-
7	B_LVDS_0+	8	A_LVDS_0+
9	GND	10	GND
11	B_LVDS_1-	12	A_LVDS_1-
13	B_LVDS_1+	14	A_LVDS_1+
15	GND	16	GND
17	B_LVDS_2-	18	A_LVDS_2-
19	B_LVDS_2+	20	A_LVDS_2+
21	GND	22	GND
23	B_LVDS_3-	24	A_LVDS_CLK-
25	B_LVDS_3+	26	A_LVDS_CLK+
27	GND	28	GND
29	B_LVDS_CLK-	30	A_LVDS_3-
31	B_LVDS_CLK+	32	A_LVDS_3+
33	GND	34	GND
35	NC	36	LVDS_DDCSCL
37	NC	38	LVDS_DDCSDA
39	NC	40	NC

Note: Pin4 only need to be connected to GND

CN_INV: LVDS 5-pin Backlight power connector

Pin	Signal
1	3.3V
2	Backlight Control
3	5V
4	GND
5	Enable Backlight

2.5.4 <Serial Port interface>

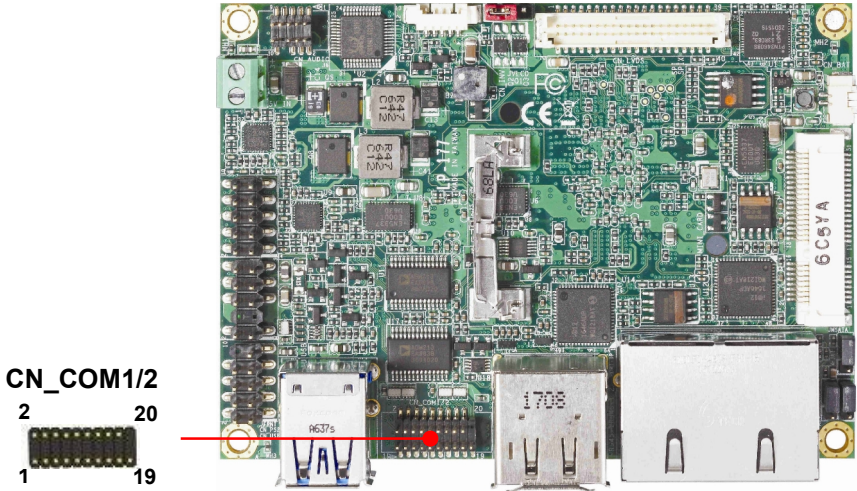

CN_COM1/2: RS232 20-pin header (Pitch 1.27mm x 2.54mm)

Pin	Signal	Pin	Signal
1	DCD1	2	RXD1
3	TXD1	4	DTR1
5	GND	6	DSR1
7	RTS1	8	CTS1
9	RI1	10	NC
11	DCD2	12	RXD2
13	TXD2	14	DTR2
15	GND	16	DSR2
17	RTS2	18	CTS2
19	RI2	20	Key

2.5.5 <USB interface>

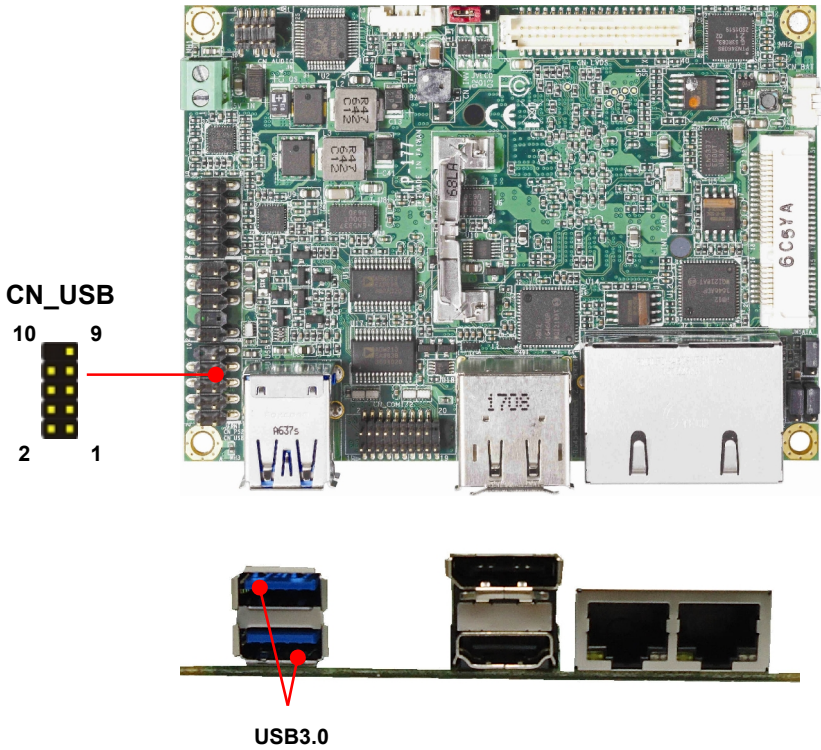

CN_USB: Front panel USB2.0 10-pin header (Pitch 2.54mm)

Pin	Signal	Pin	Signal
1	5VSB	2	5VSB
3	DATA0-	4	DATA1-
5	DATA0+	6	DATA1+
7	GND	8	GND
9	GND	10	Key

2.5.6 <Audio interface>

CN_AUDIO

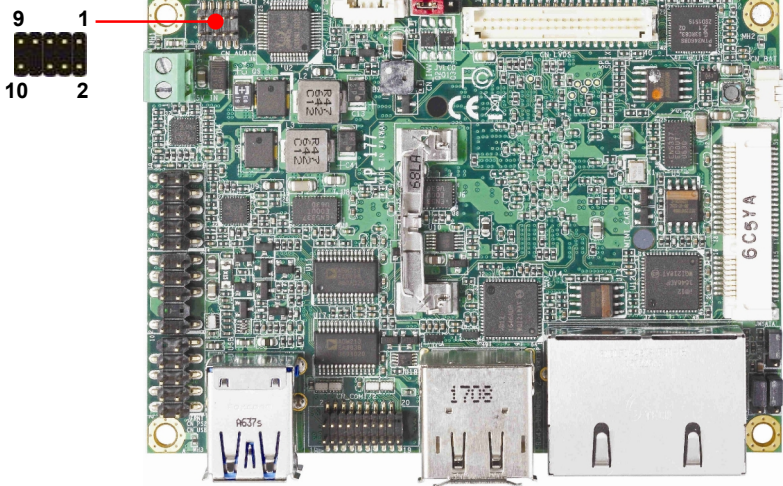

CN_AUDIO: Front panel audio 10-pin header (Pitch 1.27mm x 2.54mm)

Pin	Signal	Pin	Signal
1	MIC_L	2	GND
3	MIC_R	4	3.3V
5	FP_OUT_R	6	MIC_DETECT
7	SENSE	8	Key
9	FP_OUT_L	10	FP_OUT_DETECT

2.5.7 <Expansion slot>

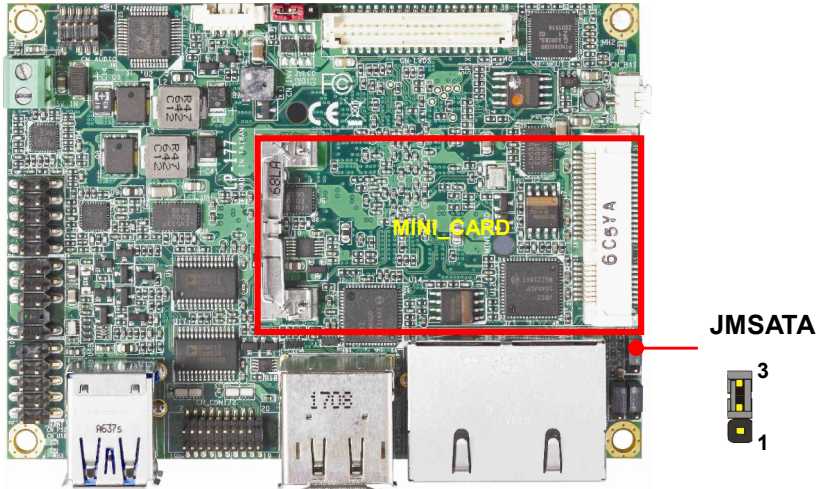

MINI_CARD support mSATA by JMSATA

MINI_CARD have some special design to compatible our mini-PCIe card.

(ex: MPX-574D2, MPX-210D2 etc)

JMSATA: Setting MINI_CARD to support PCIe/mSATA

Jumper settings	Function
1-2	Support mSATA
2-3	Normal operation (Default)

2.5.8 <Front panel switch and indicator>

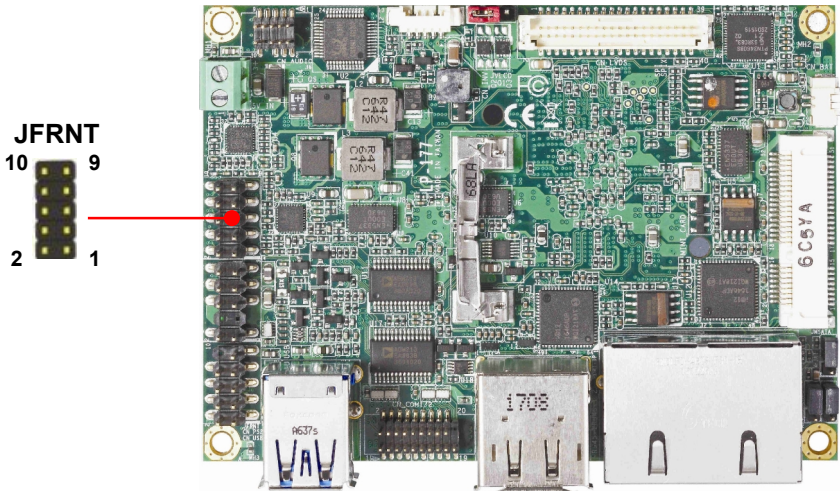

JFRNT: Front panel switch and indicator 10-pin header (Pitch 2.54mm)

Pin	Signal	Pin	Signal
1	Power_ON-	2	Power_ON+
3	Speaker-	4	Speaker+
5	HDD_LED-	6	HDD_LED+
7	Power_LED-	8	Power_LED+
9	Reset+	10	Reset-

2.5.9 <Other interface>

CN_PS2

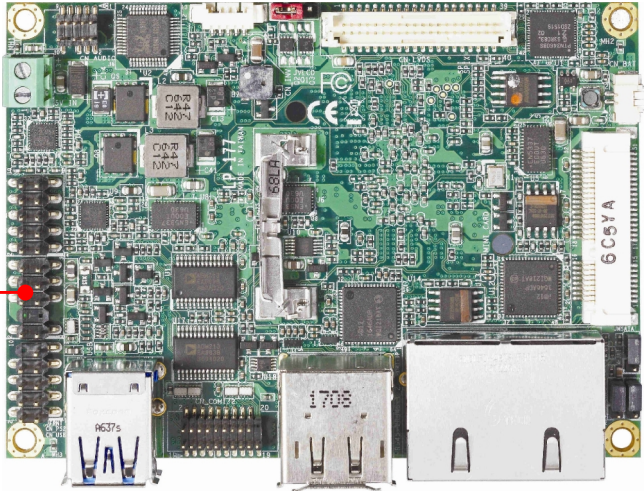
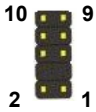

CN_LPC

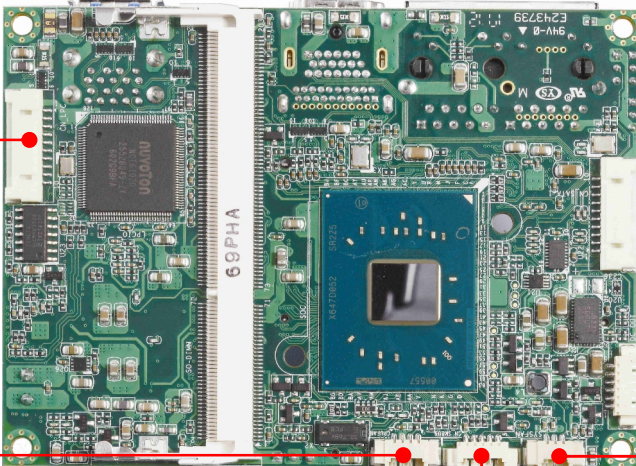
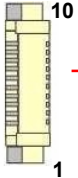

CPUFAN



SYSFAN

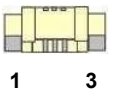

CN_SMBUS

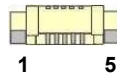

CN_LPC: LPC 10-pin header (Pitch 2.00mm)

Pin	Signal	Pin	Signal
1	CLK	2	RST
3	-LFRAME	4	LAD3
5	LAD2	6	LAD1
7	LAD0	8	3.3V
9	SERIRQ	10	GND

CN_PS/2: PS/2 10-pin header (Pitch 2.54mm)

Pin	Signal	Pin	Signal
1	KB_DATA	2	M_DATA
3	NC	4	NC
5	GND	6	GND
7	VCC	8	VCC
9	KB_CLK	10	M_CLK

CN_SMBUS: SMBus 5-pin connector

Pin	Signal
1	5V
2	NC
3	SMBDAT
4	SMBCLK
5	GND

CPUFAN: CPU cooler fan 4-pin connector

Pin	1	2	3	4
Signal	GND	5V	Sensor	Control

SYSFAN: System cooler fan 3-pin connector

Pin	1	2	3
Signal	GND	5V	Sensor

2.6 <Power supply>

2.6.1 <Power input>

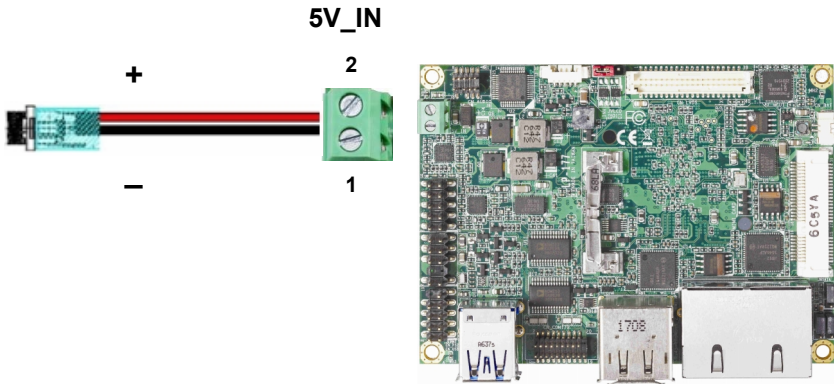

5V_IN: Terminal Block 2-pin power connector

Pin	Signal	Pin	Signal
1	GND	2	Power in (5V ONLY)

2.6.2 <Power output>

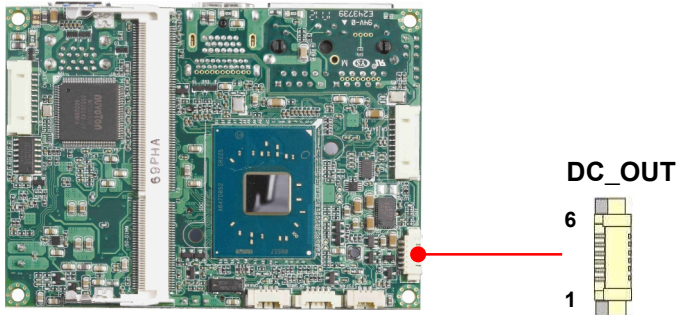

DC_OUT: SATA power 6-pin connector

Pin	Signal	Pin	Signal
1	NC	2	NC
3	GND	4	GND
5	5V	6	5V

Appendix A <Flash BIOS>

A.1 BIOS Auto Flash Tool

The board is based on Insyde BIOS and can be updated easily by the BIOS auto flash tool. You can download the tool online at the address below:

[LP-177 DOS reflash tool](#)

A.2 Flash Method

1. Please make a bootable UFD which can boot into DOS environment.
2. Unzip the flash tool and copy it into bootable UFD.
3. Add a bin file to the same folder..
4. Power on the system and flash the BIOS under the DOS environment.
(Command: H2OFFT xxx.bin -all)
5. Power off the system and then power on

Any question about the BIOS re-flash please contact your distributors or visit the web-site at below:

http://www.commell.com.tw/contact/contact_info.htm

Appendix B <LCD Panel Type select>

According to your panel, it needs to select the correct resolution in the BIOS.

If there is no fit for your panel type, please feedback for us to make an OEM model.

Find the setting from

Front page-----> Setup Utility

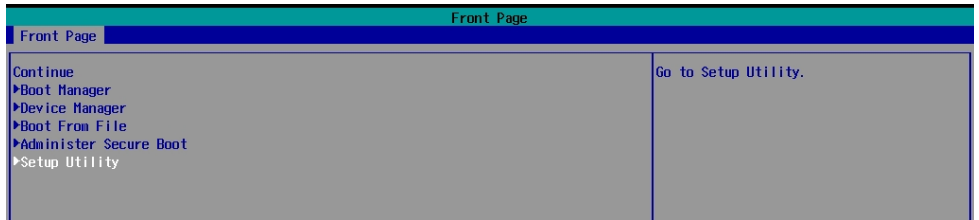

Advanced-----> Uncore Configuration----->VBT Hook Configuration

You can change 18bit /24bit, Single /Dual channel in PTN3460 configuration

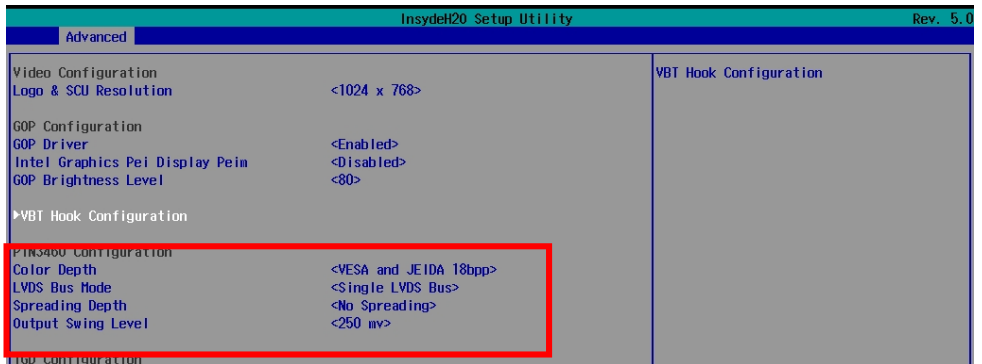

There are 16 resolutions in Panel Number.

InsydeH20 Setup Utility Rev. 5.0

Advanced

VBT Hook Configuration

LFP 1 Configuration <eDP>
 Output Port <eDP Port A>
 Aux Channel <DP Port A>
 Panel Number <640 x 480>
 EDID Support <Disabled>
 HPD Inversion <Enabled>
 DDI Lane Reversal <Disabled>

EFP 1 Configuration <HDMI/DVI>
 Output Port <HDMI Port B>
 DDC Bus Pin <HDMI Port B>
 Aux Channel <DP Port B>
 HDMI Level Shifter <400 mV 0.0dB>
 Onboard LSPCON for HDMI 2.0 <Disabled>
 HPD Inversion <Enabled>
 DDI Lane Reversal <Disabled>
 USB TypeC Dongle <Disabled>
 Dockable Port <Disabled>

EFP 2 Configuration <DisplayPort>
 Output Port <DP Port C>
 DDC Bus Pin <HDMI Port C>
 Aux Channel <DP Port C>
 HDMI Level Shifter <800 mV 3.5dB>
 Onboard LSPCON for HDMI 2.0 <Disabled>
 HPD Inversion <Enabled>
 DDI Lane Reversal <Disabled>
 USB TypeC Dongle <Enabled>
 Dockable Port <Disabled>

EFP 3 Configuration <No Device>

Select LFP panel number (Panel Type define in VBT table)

Panel Number

VBT Default

640 x 480

800 x 600

1024 x 768

1280 x 1024

1400 x 1050

1400 x 1050

1600 x 1200

1366 x 768

1680 x 1050

1920 x 1200

1440 x 900

1600 x 900

1024 x 768

1280 x 800

1920 x 1080

OEM Keep

F1 Help ↑/↓ Select Item F5/F6 Change Values F9 Setup Defaults

Esc Exit ←/→ Select Item Enter Select ▸ SubMenu F10 Save and Exit

BIOS panel type selection form (BIOS Version:1.0)			
Single / Dual channel		Single / Dual channel	
NO.	Type	NO.	Type
1	Auto	9	1366 x 768
2	640 x 480	10	1680 x 1050
3	800 x 600	11	1920 x 1200
4	1024 x 768	12	1400 x 900
5	1280 x 1024	13	1600 x 900
6	1400 x 1050 Reduced Blanking	14	1024 x 768
7	1400 x 1050 non-Reduced Blanking	15	1280 x 800
8	1600 x 1200	16	1920 x 1080
		17	OEM keep

Appendix C <Programmable Watch Dog Timer>

Timeout value range

1 to 255 Minute and Second

Program sample

Watchdog timer setup as system reset with 5 second of timeout

```
-o 4E 87      ;enter configuration
-o 4E 87
-o 4E 07
-o 4F 08      ;select Logical Device
-o 4E 30
-o 4F 01      ; activate WDTO# function
-o 4E F0
-o 4F 00      ;set "00" is second mode, set "08" is minute mode
-o 4E F1
-o 4F 05      ;00h: Timeout Disable
                ;01h: Timeout occurs after 1 minute only
                ;02h: Timeout occurs after 2 second/minute
                ;03h: Timeout occurs after 3 second/minute
                ;
                ;FFh: Timeout occurs after 255 second/minute
                (The deviation is approx 1 second.)
```

For further information, please refer to Nuvoton NCT6102D datasheet

Appendix D <Setup ADP-3355, ADP-3460>

LP-177T Series have a CRT or 2nd LVDS, it's no need install extra driver.

For further information, please refer to the manual.

ADP-3355 manual [Link](#)

ADP-3460 manual [Link](#)

Appendix E <SuperIO Setting>

Press **Delete** to enter BIOS Setup menu

On **Front Page** screen, click Setup Utility

On **Advanced** screen, click **SIO NUVOTON6106D**

There are 5 functions in the page.

- 1.WDT(Watch Dog Timer)
- 2.Power Loss setting
- 3.Hardware monitor
- 4.Smart fan
- 5.OVT (Over temperature)

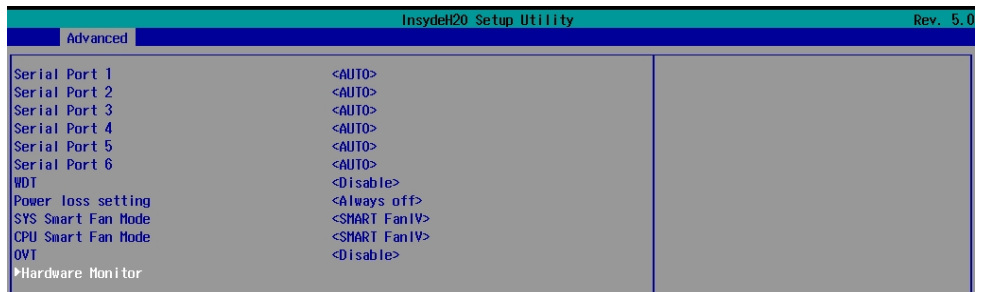

Advanced		InsydeH20 Setup Utility	Rev. 5.0
Hardware Monitor			
Voltage			
CPU Core		0.712 V	
V12S		11.932 V	
V5S		5.000 V	
V3.3S		3.280 V	
VBAT		3.088 V	
Temperature			
System (°C/°F)		43.0 C/ 109.4 F	
CPU (°C/°F)		44.5 C/ 112.1 F	
Fan Speed			
SYS FAN		0 RPM	
CPU FAN		0 RPM	

Contact information

Any advice or comment about our products and service, or anything we can help you please don't hesitate to contact with us. We will do our best to support you for your products, projects and business.

Taiwan Commate computer Inc.

Address	19F., NO.94, Sec. 1, Xintai 5 th Rd., Xizhi Dist., New Taipei City 22102, Taiwan.
TEL	+886-2-26963909
FAX	+886-2-26963911
Website	www.commell.com.tw
E-mail	info@commell.com.tw (General information) tech@commell.com.tw (Technical Support)

Commell is a brand name of Taiwan Commate computer Inc.