

TriGem

Motherboard

User's Guide
LI545

BIOS

COMPUTER

 TriGem

Disclaimer and Copyright Notice

All rights reserved. No part of this publication may be reproduced, stored in a retrieval system, or transmitted, in any form or by any means, electronic, mechanical, photocopying, recording, or otherwise, without the prior written permission of TriGem Computer, Inc. No patent liability is assumed with respect to the use of information contained herein. While every precaution has been taken in the preparation of this publication, TriGem Computer, Inc. assumes no responsibility for errors or omissions. There is no liability assumed for damages resulting from the use of the information contained herein. Further, this publication and features described herein are subject to change without notice.

Trademarks

TriGem is a registered trademark of TriGem Computer, Incorporated. Other product names herein are for identification purposes only and may be trademarks of their respective owners. TriGem disclaims any and all rights to those marks.

- Intel is a registered trademark of Intel Corporation, MMX is a trademark of Intel Corporation.
- AMD is a registered trademark of Advanced Micro Devices, Incorporated.
- Cyrix is a registered trademark of Cyrix Corporation.
- PS/2 and VGA are trademarks of International Business Machines Corporation.
- Microsoft, MS-DOS, Microsoft Windows 95, Microsoft Windows NT are registered trademarks of Microsoft Corporation.

Copyright(c) 1997 by TriGem Computer, Inc.

Safety Information

Battery Warning Instruction

Caution

If battery is incorrectly replaced there poses a danger of explosion. Replace battery only with the same or equivalent type recommended by the manufacturer. Discard used batteries according to the manufacturer's instructions.

Attention

Il y a danger d'explosion s'il y a remplacement incorrect de la batterie. Remplacer uniquement avec une batterie du meme type ou d'un type recommande par le constructeur. Mettre au rebut les batteries usagees conformement aux instructions du fabricant.

Vorsicht

Explosionsgefahr bei unsachgemäß em Austausch der Batterie. Ersatz nur durch denselben oder einen vom Hersteller empfohlenen ähnlichen Typ. Entsorgung gebraushter Batterien nach Angaben des Herstellers.

Fuse Warning Instruction

Caution

For continued protection against risk of fire, replace only with same type and rating of fuse. Disconnect input power before servicing. Only connect this equipment to an earthed socket outlet.

Vorsicht

Vor jeder service-arbeit netzstecker ziehen! Apparatet ma kun tilkobles jordet stikkontakt.

Attention

Debrancher avant d'ouvrir. Apparatet skall anslutas till jordat nätuttag.

Atencion

Desconecte fuerza electrica antes del servicio. Laite on liitettävä suojäkosketinistoraasian.

CONTENTS

Chapter 1 Motherboard Description

Features	1-1
Motherboard Overview	1-3
Motherboard Connectors	1-4
Power Supply Connector	1-4
Front Panel Connectors	1-5
Rear Panel Connectors	1-6
Board Expansion Connectors	1-9
FDD Connector	1-9
Primary and Secondary E-IDE Connectors	1-10

Chapter 2 Using the CMOS Setup Program

About the Setup Program	2-1
Entering the Setup Program	2-2
Exiting the Setup Program	2-4
Setup Menu	2-5
Standard Setup Menu	2-5
Advanced Setup Menu	2-8
Chipset Setup Menu	2-11
Power Control Setup Menu	2-12
PCI/PnP Setup Menu	2-13
Peripheral Setup Menu	2-15
Utility Menu	2-17
Detect IDE	2-17
Color Set	2-18

Security Menu.....	2-18
Supervisor/User	2-18
Default Menu	2-22
Original	2-23
Optimal	2-23

Chapter 3 Installing and Removing Board Options

Before You Begin	3-1
Installing and Removing the Microprocessor	3-2
Installing the Microprocessor	3-2
Setting the Processor Speed	3-5
Removing the Microprocessor	3-5
Installing and Removing Memory Modules	3-7
Installing a Memory Module	3-8
Removing a Memory Module	3-8
Changing DIP Switches and Jumper Settings	3-9
Locations of the DIP Switches and Jumpers	3-9
DIP Switch and Jumper Settings	3-10
The Things to do in Post-installation	3-11

Chapter 4 Audio Drivers and Applications

Installing the Audio Drivers	4-1
Installing and Using the Audio Applications.....	4-6
Installing the Audio Applications	4-6
Using the Audio Applications	4-9

Chapter 5 Update on Installing Windows 95

Installing the USB Driver	5-2
Installing the ACPI Driver	5-3
Installing the DirectX-5 Driver	5-5
Installing the AGP VxD Driver	5-6

Appendix A Specifications

Form Factor	A-1
Processor	A-1
Main Memory	A-1
Apollo VP3 AGPset and PCI/IDE Interface	A-2
I/O features	A-2
Six usable expansion slots	A-3
Other features	A-3
Manufacturing Options	A-3
Power Supply	A-3

Appendix B Error and Information Messages

BIOS Error Messages	B-1
BIOS Beep Codes	B-2

Appendix C Motherboard Resources

DMA Channels	C-1
Interrupts	C-2

Figures

Figure 1. Motherboard overview	1-3
Figure 2. Motherboard connectors	1-4
Figure 3. Connecting the power supply	1-5
Figure 4. Front panel connectors	1-5
Figure 5. Rear panel connectors	1-6
Figure 6. Connecting the keyboard.....	1-6
Figure 7. Connecting the mouse.....	1-7
Figure 8. Connecting the USB devices	1-7
Figure 9. Connecting the serial device	1-8
Figure 10. Connecting the parallel device	1-8
Figure 11. Connecting the audio devices	1-9
Figure 12. Opening the ZIF socket.....	3-2
Figure 13. Alignin the microprocessor on the ZIF socket	3-3
Figure 14. Inserting the microprocessor in the ZIF socket	3-3
Figure 15. Connecting the heatsink fan connector	3-4
Figure 16. Removing the heatsink fan connector	3-5
Figure 17. Removing the microprocessor from the ZIF socket	3-6
Figure 18. Installing a memory module	3-8
Figure 19. Removing a memory module	3-8
Figure 20. DIP switches and jumpers	3-9

Chapter 1

Motherboard Description

This chapter describes the major features of your motherboard.

Features

The motherboard supports the following features:

- Smallest PCB size in the ATX form factor
- Intel Pentium P54C(S), Intel Pentium P55C-MMX, AMD K5/K6, or Cyrix 6x86/6x86MX
- Three 168 pin DIMM sockets, support up to 384 MB of synchronous DRAM (SDRAM) memory and support unbuffered EDO DRAM
- 512 KB of synchronous Pipeline Burst SRAM external cache
- Two built-in PCI bus Enhanced IDE hard disk drive controllers, each channel supports up to two hard disk drives or CD-ROM drives
- VT82C597 Single chip north bridge (PCI/AGP/Memory controller)
- VT82C586B PCI/ISA/IDE Xcelerator
- IT8661F super I/O controller
- CX4236B audio controller and CS9236 wavetable (Ready for CS4235 with 3D)
- Three 32-bit PCI slots, one 16-bit ISA slot, and one shared PCI/ISA slot
- One AGP (Accelerated Graphics Port) slot

- System and video BIOS shadow RAM
- Plug-and-Play (PnP) BIOS feature
- A built-in PS/2 style keyboard connector and a built-in PS/2 compatible mouse connector
- Two Universal Serial Bus (USB) interfaces
- Two serial ports and one parallel port
- One Joystick and three audio I/O interface port

The following are manufacturing options:

- Wake up on LAN connector
- System chassis intrusion
- Management extension hardware

Note

The Accelerated Graphics Port (AGP) is a high-performance interconnect for graphic-intensive applications, such as 3D applications. AGP is independent of the PCI bus and is intended for exclusive use with graphical-display devices.

Note

The motherboard has two USB ports; one USB peripheral can be connected to each port. For more than two USB devices, an external hub can be connected to either port. The motherboard fully supports the universal host controller interface (UHCI) and uses UHCI-compatible software drivers.

Note

The Wake up on LAN header allows the computer to wake from sleep mode, or power on when a call is received on a network device, such as a LAN. The first incoming call powers up the computer. A second call must be made to access the computer.

Motherboard Overview

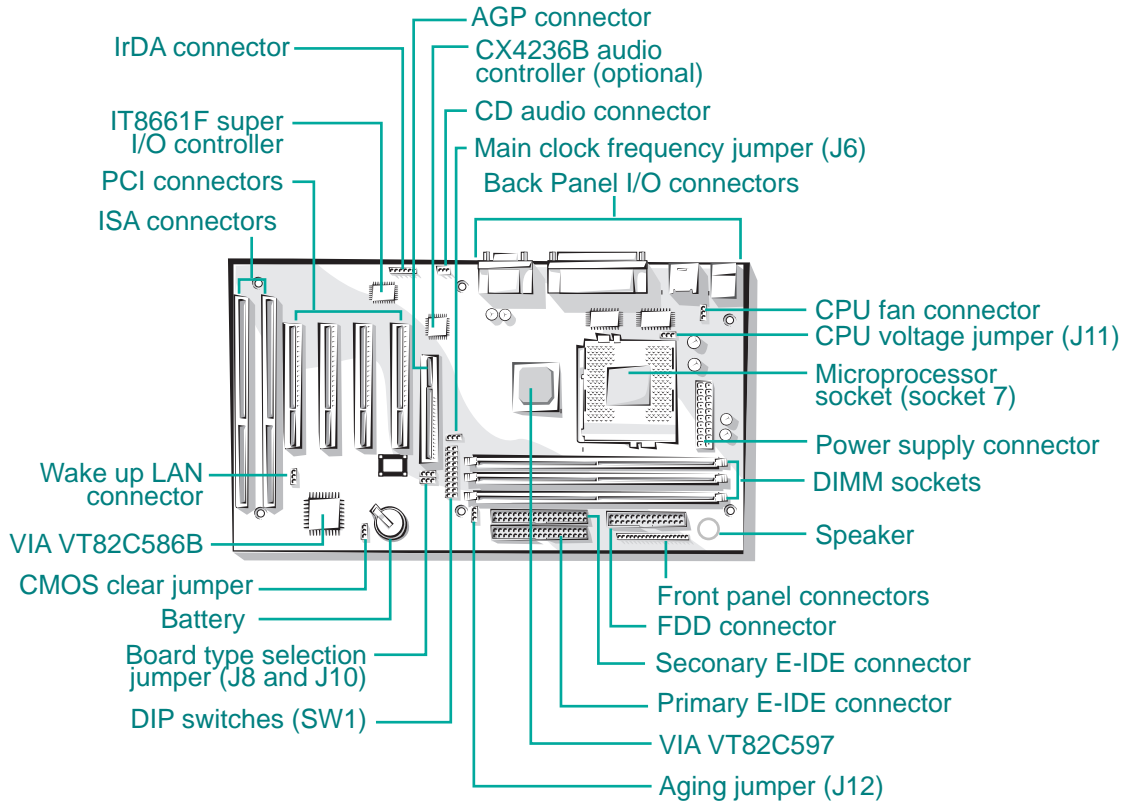

Figure 1. Motherboard overview

Motherboard Connectors

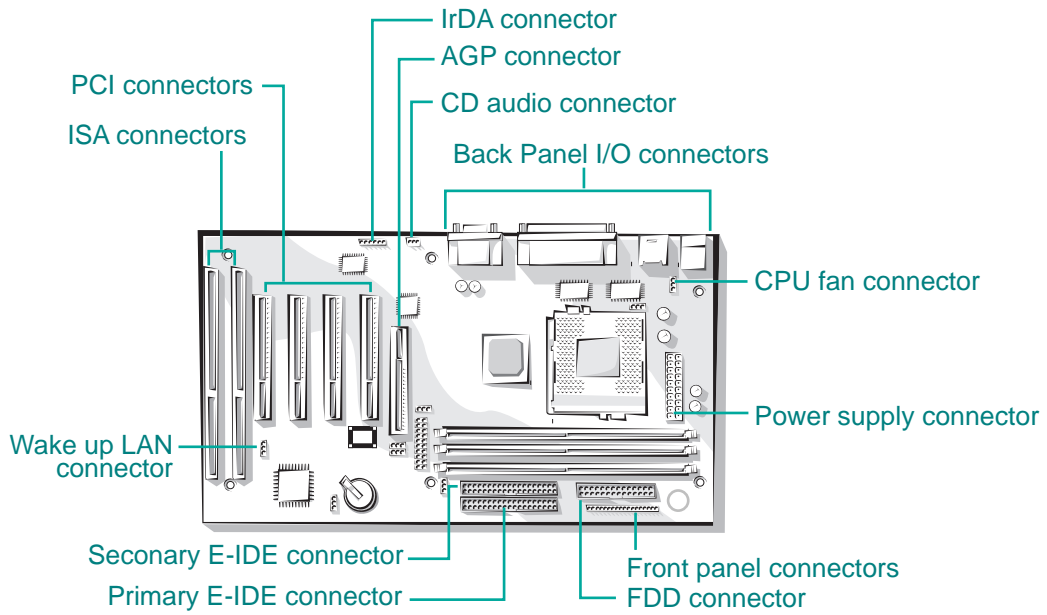

Figure 2. Motherboard connectors

Power Supply Connector

The power supply converts AC power from a wall outlet to the DC voltages required by motherboard and devices in your system. The power supply has a large motherboard connector and several internal device (hard disk, CD-ROM, and floppy disk drive, etc.) connectors.

The power supply should match the physical configuration of the chassis. Before attaching all components, make sure the proper voltage has been selected. Power supplies often can run on a wide range of voltages and must be set (usually via a switch) to the proper range.

You can connect the power supply cable to the power connector on the motherboard.

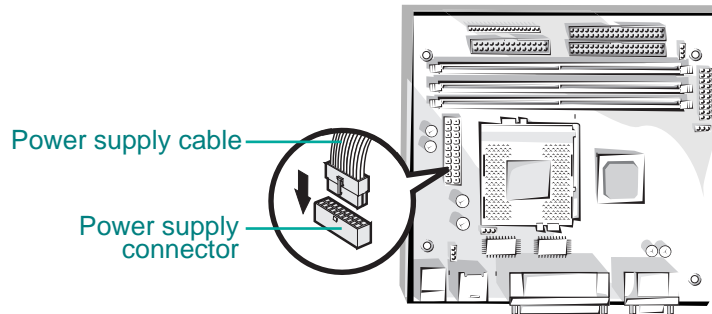

Figure 3. Connecting the power supply

Front Panel Connectors

The motherboard has connectors for controls and indicators typically located on the front panel of the computer.

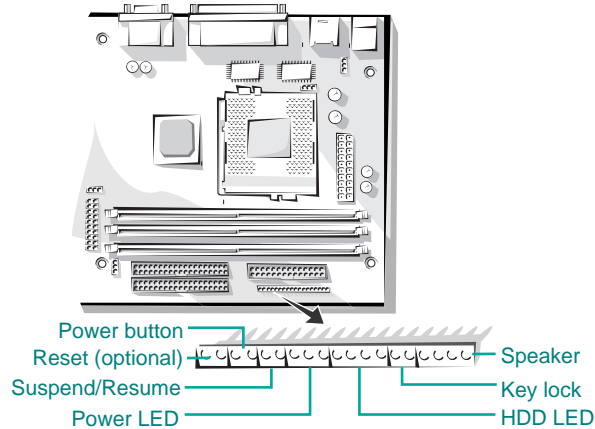

Figure 4. Front panel connectors

Rear Panel Connectors

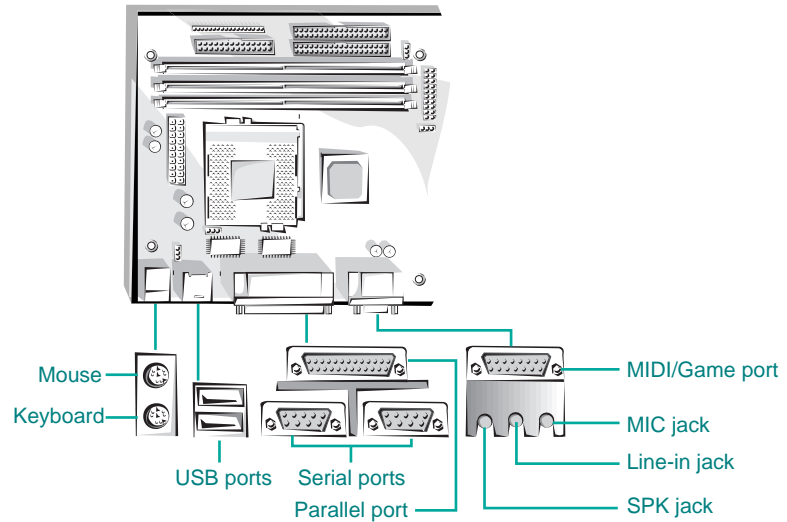

Figure 5. Rear panel connectors

Keyboard Connector

Your system's PS/2 style keyboard plugs into the keyboard connector.

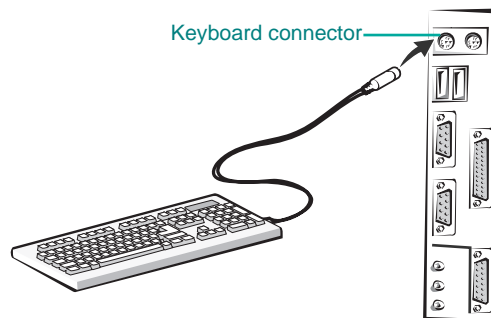

Figure 6. Connecting the keyboard

Mouse Connector

Your system's PS/2 compatible mouse plugs into the mouse connector.

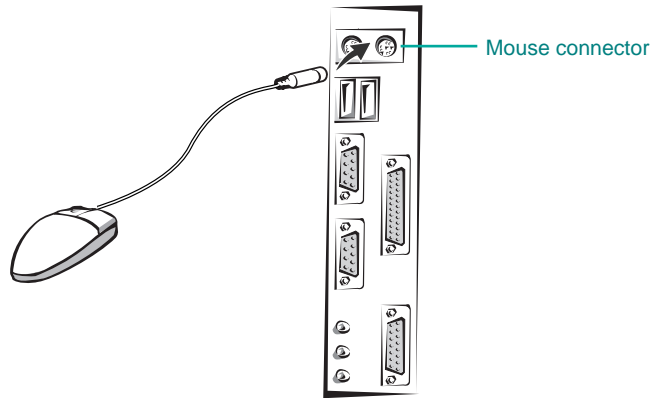

Figure 7. Connecting the mouse

USB Connectors

You can connect any USB compliant devices to either of the USB connectors. USB devices include low-speed peripherals such as microphone, digital joystick, and speaker.

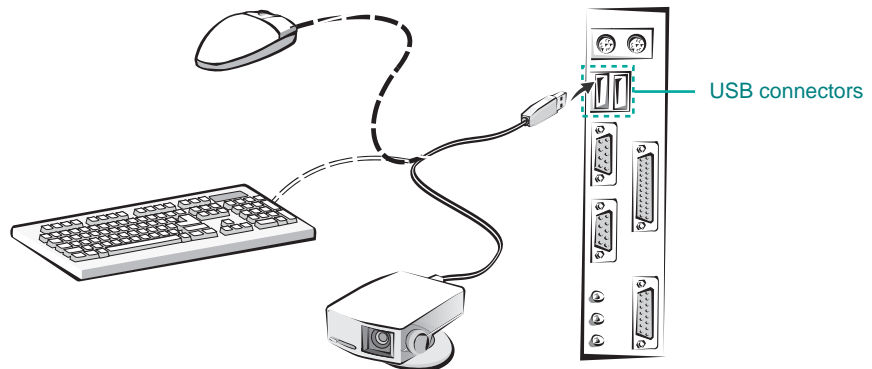

Figure 8. Connecting the USB devices

Serial Port (COM1, 2) Connectors

You can connect a serial device, such as an external modem and printer, to the serial port connectors.

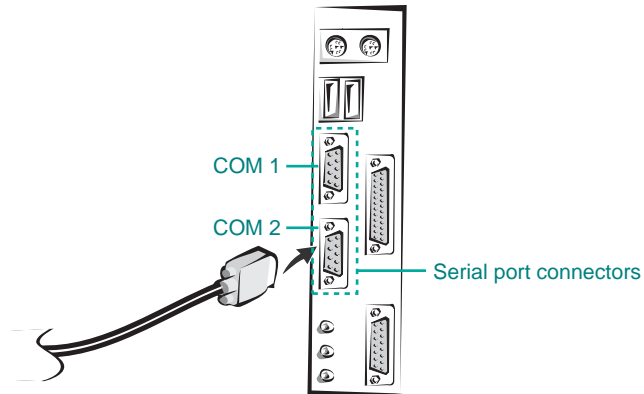

Figure 9. Connecting the serial device

Parallel Port (LPT1) Connector

You can connect a parallel device, such as a printer, to the parallel port.

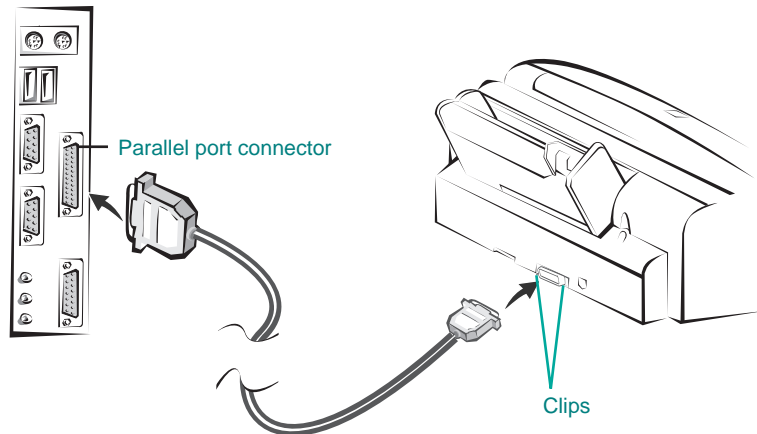

Figure 10. Connecting the parallel device

Audio Connectors (Optional)

Your motherboard has three audio jacks (SPK, Line-in, and MIC) and one MIDI/Game port connector. Your optional audio devices and MIDI/Game device are connected to these connectors, as shown below.

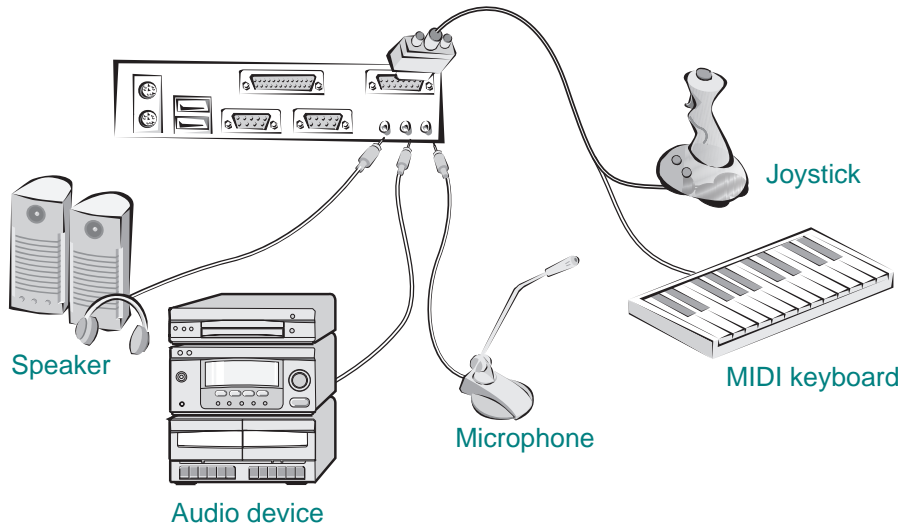

Figure 11. Connecting the audio devices

Board Expansion Connectors

There are three PCI slots, one ISA slot, and one shared slot (for a PCI or ISA card). The PCI bus supports up to four bus masters through the four PCI connectors.

FDD Connector

You can connect your diskette drive(s) to the diskette drive connector on the motherboard by using the diskette drive ribbon cable. The diskette drive ribbon cable has two connectors for diskette drives in general. After connecting the one end of the diskette drive ribbon cable to the motherboard, attach the connector(s) on the other end to the diskette drive(s).

Primary and Secondary E-IDE Connectors

Your motherboard has two built-in PCI E-IDE interfaces (primary and secondary). Each interface supports up to two IDE drives (master and slave). After connecting the one end of the IDE ribbon cable to the primary or secondary E-IDE connector on the motherboard, connect the connector(s) at the other end to your IDE drive(s) such as the hard disk drive or CD-ROM drive.

If you install two hard disks by using one IDE ribbon cable, you must configure the second drive to slave mode by setting its jumper accordingly. See the manual of your hard disk for the jumper settings.

You may configure two hard disk drives to be both masters by connecting one ribbon cable (one hard disk drive will be attached to it) to the primary E-IDE connector and another ribbon cable (the other hard disk drive will be attached to it) to the secondary IDE connector. When you install one operating system on an IDE drive and another on the other IDE drive, you can select the boot device through the Setup program.

The BIOS in the motherboard supports boot up from IDE CD-ROM drive, floptical drive, SCSI drive or network drive. So, you can select a CD-ROM drive or floptical drive as a boot device by setting the 1st/2nd /3rd Boot Device option to CD-ROM or Floptical in the Advanced Setup menu of the Setup program.

NOTE : The hard disk drive controller on the motherboard supports Ultra DMA/33, a DMA data transfer protocol for hard disk drives. This allows DMA commands to transfer data at a maximum burst rate of 33MB/sec. Both the controller and the hard disk must be capable of supporting Ultra DMA/33 in order to enable this feature.

Chapter 2

Using the CMOS Setup Program

About the Setup Program

This chapter explains how to use the CMOS Setup program. You can use the Setup program to change the computer's configuration information and boot-up sequence, etc.

The Setup program is stored in the computer's read only memory (ROM), so you can run the program at any time when you turn on or reset your computer. You need not insert a diskette or access the hard disk.

The Setup program lets you verify or change the followings:

- On the Setup menu, you can set up and modify some of the basic options of a system, such as time, date, diskette drives and hard disk drives.
- On the Utilities menu, you can perform system functions.
- On the Security menu, you can specify password that can be used to limit access to the system.
- On the Default menu, you can select a group of settings for all CMOS Setup options.

The configuration you define through the Setup program is stored in a special area of memory called CMOS RAM. The battery on the main board backs up this memory, so the memory is not erased when you turn off or reset the computer. Whenever you reboot the computer, it checks the settings, and if it discovers a difference between the information in the CMOS RAM and its actual hardware configuration, it prompts you to run the Setup program.

You may see a message such as the following:

CMOS Settings Wrong
Press F1 to Resume

If this happens, just press F1 to run the Setup program and then correct the setting.

Entering the Setup Program

To enter the Setup program, turn the computer on and press when you see the message:

"Hit DEL if you want to run SETUP."

As soon as you see this message, hit the DEL key. If you do not press DEL key quickly, the computer starts loading the operating system and you will not be able to run the Setup program. If this happens, reset the computer again.

Note

For reference purposes, you should write down the current Setup settings. When you make changes to the settings, update this record.

When you enter the Setup program, you will see the Setup menu.

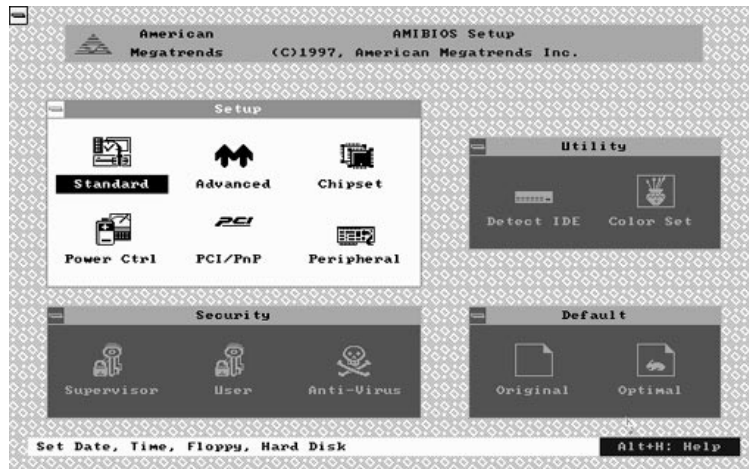

The Setup program is composed of four windows that contain several icons. An information line at the bottom of the menu displays simple explanations for each option.

You can use your keyboard or mouse to select the options.

The mouse functions are click (change or select both global and current field) or double click (perform an operation in the selected field).

The following list provides an overview of function keys in the Setup program.

Setup Key	Description
Tab	Moves to the next window or field.
←, →, ↑, or ↓	Move to the next field to the right, left, above, or below.
Enter	Selects the current field.
+	Increases a value.
-	Decreases a value.
Esc	Closes the current operation and return to previous level.
PgUp	Returns to the previous page.
PgDn	Advances to the next page.
Home	Returns to the beginning of the text.
End	Advances to the end of the text.
Alt-H	Accesses a help window. It describes the keys available in Setup.
Alt-Spacebar	Exits System Setup
Alphabetic keys	A to Z are used in your keyboard.
Numeric keys	0 to 9 are used in either the numeric keys along the top of the keyboard or the numeric keypad.

Exiting the Setup Program

To exit the Setup program, press Alt and Spacebar keys simultaneously. If you press these keys, you can see the following window.

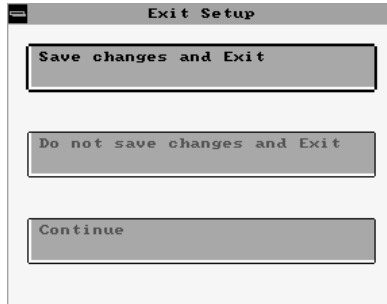

To save the settings and exit, select Save changes and Exit. The system reboots with your new settings.

If you want to exit the Setup program without saving your settings, select Do not save changes and Exit. The system reboots with your original settings.

To return to the Setup menu to make corrections, select Continue.

If you saved your changes or quitted without saving the settings, the Setup program resets the system and the computer performs its power on diagnostic tests.

If your computer detects a problem in your Setup configuration, you may see an error message and a prompt to run the Setup program when it is rebooting. Follow the instructions on the screen to run the Setup program and correct the problem.

Setup Menu

The Setup menu has 6 icons, each of which contains a submenu.

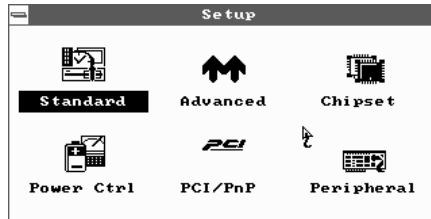

Standard Setup Menu

Standard Setup options are displayed by choosing the Standard icon from the BIOS Setup menu. All Standard Setup options are described below.

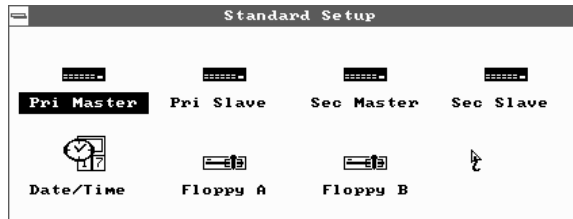

Pri Master/Pri Slave/Sec Master/Sec Slave

Choose these icons to configure the hard disk drive named in the option. When you click on an icon, the following parameters are listed: Type, LBA/Large Mode, Block Mode, 32Bit Mode, and PIO Mode.

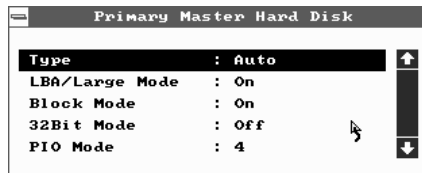

Type

You can choose the appropriate hard disk and CD-ROM drives type for yours.

- Type : The number for a drive with certain identification parameters.
- Cyl : The number of cylinders in the disk drive.
- HD : The number of heads.
- WP : The size of a sector gets progressively smaller as the track diameter diminishes. Yet each sector must still hold 512 bytes. Write precompensation circuitry on the hard disk compensates for the physical difference in sector size by boosting the write current for sectors on inner tracks. This parameter is the track number where write precompensation begins.
- Sec : The number of sectors per track. MFM drives have 17 sectors per track. RLL drives have 26 sectors per track. ESDI drives have 34 sectors per track. SCSI and IDE drives have more sectors per track.
- Size (MB) : The formatted capacity of the drive. (Size = Number of heads × Number of cylinders × Number of sectors per track × 512 bytes per sector.)
- User : If you are configuring a drive with drive parameters that do not match drive types, you can select the User in the Type field. You must then enter the drive parameters on the screen that appears.
- AUTO : If the hard disk drive to be configured is an IDE drive, select the appropriate drive icon (Pri Master, Pri Slave, Sec Master, or Sec Slave). Select the IDE Detect icon to automatically detect all drive parameters.

BIOS automatically detects the IDE drive parameters (including ATAPI CD-ROM drives) and displays them. Click on the OK button to accept these parameters or you can set the parameters manually if you are absolutely certain that you know the correct IDE drive parameters.

- CDROM : Select the appropriate drive icon (Pri Master, Pri Slave, Sec Master, or Sec Slave). Choose the Type parameter and select CDROM. You can boot the computer from a CD-ROM drive. You can also choose Auto and let BIOS will automatically set the correct drive parameters.
- Floptical : If a floptical drive is connected to the IDE connector, select FLOPTICAL for the drive. You can boot the computer from the floptical drive.

LBA/Large Mode

To use the IDE drives with capacities greater than 528 MB, set this option to On. The settings are On and Off.

Block Mode

To use the IDE drives that use Block transfer Mode, set this option to On. The settings are On and Off.

32Bit Mode

Set it to On to support IDE drives that permit 32-bit accesses. The settings are On and Off.

PIO Mode

This option selects the IDE Programmed I/O mode. PIO programming also works with ATAPI CD-ROM drives. The settings are Auto, 0, 1, 2, 3, 4, and 5.

Choose Auto to allow BIOS to automatically find the PIO mode that the IDE drive being configured uses. If you select 0-5 you must make absolutely certain that you are selecting the PIO mode supported by the IDE drive being configured.

Date/Time

Select the Date/Time option to change the date or time. The current date and time are displayed. Enter new values through the displayed window.

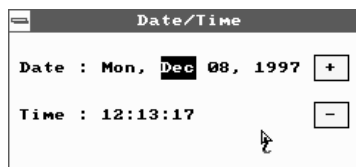

Floppy Drive A, B

Choose the Floppy Drive A or B icon to specify the floppy drive type. The settings are Not Installed, 360 KB 5 1/4, 1.2 MB 5 1/4, 720 KB 3 1/2, 1.44 MB 3 1/2, and 2.88 MB 3 1/2.

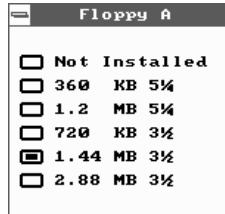

Advanced Setup Menu

Advanced Setup options are displayed by choosing the Advanced icon from the BIOS Setup main menu. All Advanced Setup options are described in this section.

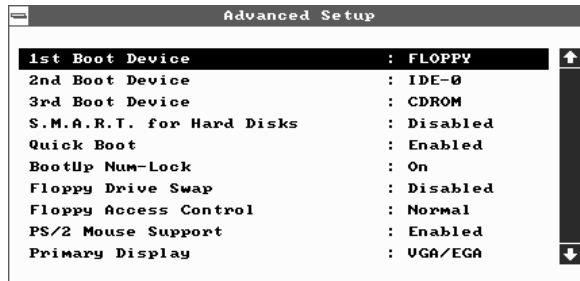

1st/2nd/3rd Boot Device

Each menu allows you to select the first, second and third devices the computer checks when it looks for the operating system. The settings available for the 1st Boot Device option are Disabled, IDE-0, IDE-1, IDE-2, IDE-3, Floppy, FLOPTICAL, CDROM, and SCSI. The settings available for 2nd Boot Device and 3rd Boot Device are Disabled, IDE-0, Floppy, FLOPTICAL, and CDROM.

S.M.A.R.T. for Hard Disks

S.M.A.R.T. (Self-Monitoring, Analysis and Reporting Technology) predicts the hardware failure. This technology is developed to manage the reliability of the hard disk. The settings are Disabled and Enabled.

Quick Boot

Set it to Enabled to instruct BIOS to boot quickly when the computer is powered on. The settings are:

- Disabled : BIOS test all system memory. BIOS waits up to 40 seconds for a READY signal from the IDE hard disk drive. BIOS waits for .5 seconds after sending a RESET signal to the IDE drive to allow the IDE drive time to get ready again.
- Enabled : BIOS does not test system memory above 1 MB. BIOS does not wait up to 40 seconds for a READY signal from the IDE hard disk drive. If a READY signal is not received immediately from the IDE drive, BIOS does not configure that drive. BIOS does not wait for .5 seconds after sending a RESET signal to the IDE drive to allow the IDE drive time to get ready again.

BootUp Num-Lock

This option determines the beginning state of the Num Lock feature on your keyboard, when system is turned on or reset. The settings are On and Off.

Floppy Drive Swap

If you are using two diskette drives, you can easily switch between drives A and B. For example, if you are using a 1.44MB diskette drive as drive A and a 1.2MB diskette drive as drive B, you can switch the drives vice versa by enabling the option. When you set the option, you must switch between the settings for both drives from the Floppy A and Floppy B options in the Standard Setup menu. The settings are Disabled and Enabled.

Floppy Access Control

This option sets read/write access for all attached diskette drives. The settings are Normal and Read Only. Normal means read/write access for drives.

If you select Read Only for each option, you can read a diskette and copy data from it, but you cannot store new data on it or delete any files it contains.

PS/2 Mouse Support

If you enable this option, you can use a PS/2 mouse. The settings are Disabled and Enabled.

Primary Display

This option lets you define the type of adapter you are using for your primary display. The settings are Absent, VGA/EGA, CGA40X25, CGA80X25, and Mono.

Password Check

This option sets the type of password protection. The settings are Setup and Always. If you select Setup, every time you run the Setup program, the computer checks your password. Once you set password, you should enter your password whenever you run the Setup program.

If you select Always, every time you run the Setup program or turn on or reset the computer, it checks your password.

Boot To OS/2

If your system has above 64MB of main memory, set this option to Yes to allow the system to run OS/2 Warp version 3.0 properly. The settings are Yes and No.

External Cache

The option sets the type of caching algorithm for L2 external cache memory. The settings are Disabled and Enabled.

C000 / C400, 16K Shadow

These options allow you to shadow the contents of video ROM listed on the screen to the system's RAM. The settings are Disabled and Enabled.

C800 / CC00 / D000 / D400 / D800 / DC00, 16K Shadow

These options allow you to shadow the contents of the adapter ROM listed on the screen to the system's RAM. The settings are Disabled and Enabled.

Chipset Setup Menu

If you select the Chipset icon from the Setup main menu, the Chipset Setup menu is displayed.

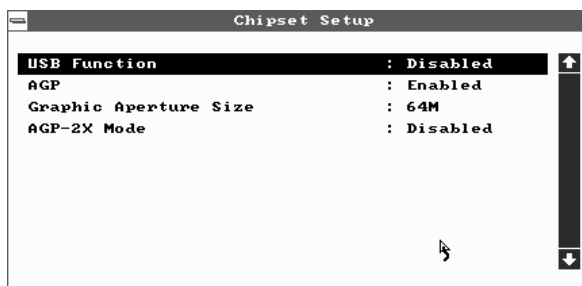

USB Function

To use the USB function, set this option to Enabled. The settings are Enabled and Disabled.

AGP

This option is automatically set by BIOS. When you install the AGP card in the system, BIOS detects it and sets this option to Enabled.

Graphic Aperture Size

The base of the Graphics Aperture can be anywhere in the system virtual address space on an address boundary determined by the aperture size. This option is only available if the setting for the AGP option is Enabled.

AGP-2X Mode

The AGP protocol provides Qword access granularity. Qword transfers normally take two clock cycles in the 1X mode. Likewise, sideband address commands normally take two clocks per each 16bit command. This option is only available if the setting for the AGP option is Enabled.

Power Control Setup Menu

If you select the Power Ctrl icon from the Setup main menu, the Power Control Setup menu is displayed.

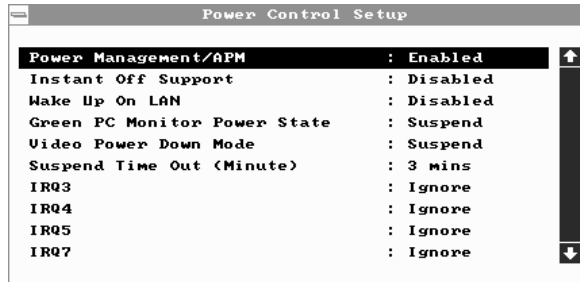

Power Management / APM

Set the option to Enabled to enable the power management and APM (Advanced Power Management) features. If you set Disabled for the option, you will not see any options in the Power Control Setup menu. The settings are Disabled and Enabled.

Instant Off Support

When the option is set to Enabled, normally pressing the power button after power-on self-test makes the system immediately turned off. When the option is set to Disabled, you should press the power button for more than 4 seconds to turn off the system after finishing power-on self-test. The settings are Enabled and Disabled.

Wake Up On LAN

If you want to use Wake Up and Power On by a LAN, set this option to Enabled.

Green PC Monitor Power State

This option specifies the power management state that the Green PC-compliant video monitor enters after the specified period of display inactivity has expired. The settings are Disabled, Off, Standby, and Suspend.

Video Power Down Mode

This option specifies the power management state that the video subsystem enters after the specified period of display inactivity has expired. The settings are Disabled, Standby, or Suspend.

Suspend Time Out

The option specifies the length of the period of system inactivity for going into suspend mode. When the specified period expires, the computer enters suspend mode, beeping twice. If there are activities of devices described below, the computer exits the suspend mode. The settings are 1mins, 2mins, 3mins, 10mins, 15mins, 30mins, and 60mins.

IRQ 3, 4, 5, 7, 9, 10, 11, 13, 14, and 15

These options enable event monitoring. When the computer is in a power saving mode, activity on the named interrupt request line is monitored by AMIBIOS. When any activity occurs, the computer enters Full On mode. Each of these options can be set to Monitor or Ignore.

PCI/PnP Setup Menu

If you select the PCI/PnP icon from the Setup main menu, the PCI/PnP Setup menu is displayed.

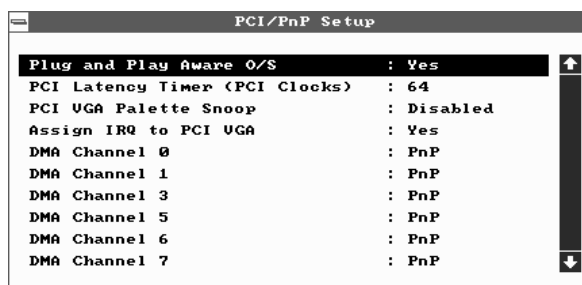

Plug and Play Aware O/S

The option enables the computer to boot with an operating system capable of managing Plug and Play add-in cards. Set it to Yes if the operating system (such as Windows 95) installed in the computer follows the Plug and Play specification. AMIBIOS only detects and enables PnP ISA adapter cards that are required for system boot. The Windows 95 operating system detects and enables all other PnP-aware adapter cards. Windows 95 is PnP-aware. Set the option to No if the operating system (such as DOS, OS/2, Windows 3.X) does not use PnP. You must set this option correctly, or PnP-aware adapter cards installed in the computer will not be configured properly. The settings are No and Yes.

PCI Latency Timer (PCI Clocks)

This option sets the length of time (measured in the number of PCI clock cycles) that a device on the PCI bus can hold the bus when another device has requested the bus. The clock choices include every 32nd value between 32 and 248 clocks. The settings are 32, 64, 96, 128, 160, 192, 224, and 248.

PCI VGA Palette Snoop

The option controls the ability of a primary PCI graphics controller to share a common palette with an ISA add-in video card. The settings are Disabled and Enabled.

Assign IRQ to PCI VGA

This option allows you to assign IRQ to PCI VGA card.

DMA Channel 0, 1, 3, 5, 6, and 7

These options allow you to reserve DMAs for legacy ISA adapter cards. The settings are PnP and ISA.

IRQ 3, 4, 5, 7, 9, 10, 11, 14, and 15

These options set the status of the IRQ. If these interrupts are available for use by a PCI/PnP add-in card, the interrupts are assigned for the computer to use. If the computer contains an ISA agent that uses one of these interrupts, select ISA for that interrupt. The settings are PCI/PnP and ISA.

Peripheral Setup Menu

The Peripheral Setup menu is displayed if you select the Peripheral icon from the Setup main menu.

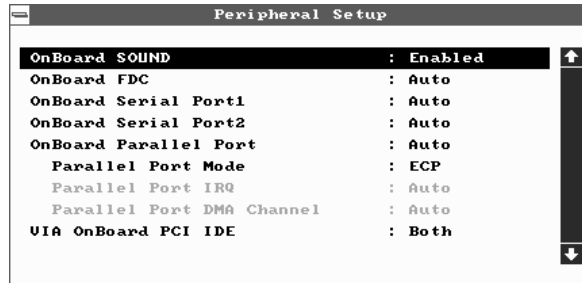

OnBoard Sound

Set this option to Enabled to use the onboard audio subsystem in the motherboard. The settings are Enabled and Disabled. This option doesn't appear if your motherboard has not built-in audio system.

OnBoard FDC

Set this option to Enabled to enable the built-in diskette drive controller. If you install another FDC card, disable this option. The settings are Auto, Disabled, and Enabled.

OnBoard Serial Port 1 and 2

These options specify the base I/O port addresses of built-in serial ports 1 and 2 (optional). The settings are Auto, Disabled, 3F8h, 2F8h, 3E8h, and 2E8h.

OnBoard Parallel Port

It specifies the base I/O port address of the built-in parallel port. The settings are Auto, Disabled, 378, 278, and 3BC.

Parallel Port Mode

It specifies the parallel port mode. ECP and EPP are both bi-directional data transfer schemes that adhere to the IEEE P1284 specifications. The settings are:

- Normal : Use this option to operate the parallel port in Standard Parallel Port (SPP) mode and bi-directional mode.
- EPP : The parallel port can be used with devices that adhere to the Enhanced Parallel Port (EPP) specification. EPP uses the existing parallel port signals to provide asymmetric bi-directional data transfer driven by the host device.
- ECP : The parallel port can be used with devices that adhere to the Extended Capabilities Port (ECP) specification. ECP uses the DMA protocol to achieve transfer rates of approximately 2.5 Mbs. ECP provides symmetric bi-directional communications.

Parallel Port IRQ

It is only available when the On Board Parallel Port option is not set to Auto. The settings are 5 and 7.

Parallel Port DMA Channel

It is only available if the setting for the Parallel Port Mode option is ECP. The settings are 0, 1, and 3.

VIA OnBoard PCI IDE

The option allows you to set the built-in IDE controller you want to use. The settings are Disabled, Primary, Secondary, and Both.

Utility Menu

There are 2 icons in the Utility menu.

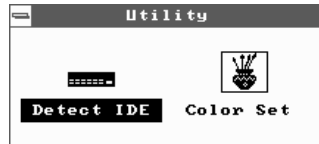

Detect IDE

If an IDE-type hard disk drive, a CD-ROM drive, or a floptical drive is connected to the primary or secondary IDE controller, this option allows for automatic detection of the hard disk drive or CD-ROM drive type. Once SETUP detects the type of the hard disk or CD-ROM drive installed, it will display the relative information.

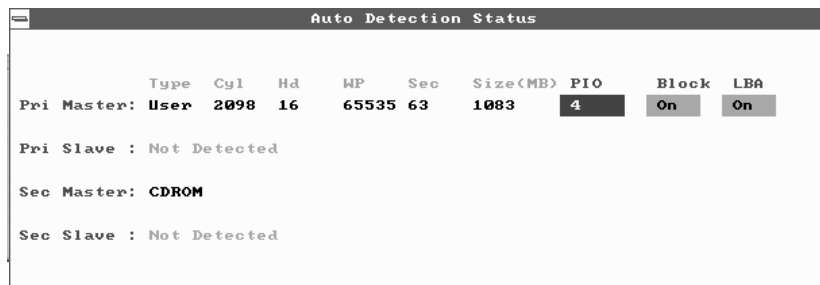

Auto Detection Status									
	Type	Cyl	Hd	WP	Sec	Size(MB)	PIO	Block	LBA
Pri Master:	User	2098	16	65535	63	1083	4	On	On
Pri Slave :	Not Detected								
Sec Master:	CDROM								
Sec Slave :	Not Detected								

After SETUP detects all IDE drives, the hard disk drive type will be forced to be User and the CD-ROM drive type will be forced to be CDROM.

Color Set

This option allows you to change the color of the System Setup screen. The settings are Sky, Army, Pastel, and LCD.



Security Menu

Three icons appear in the Security menu.



Supervisor / User

These two options make it possible to restrict access to the Setup program and to restrict who can boot the computer by enabling you to set passwords for two different access modes: Supervisor mode and User mode.

A Supervisor password and a User password can be set for the Setup program and for booting the computer.

Supervisor mode has full access to all the Setup options whereas User mode has limited access to the options. Setting separate Supervisor and User passwords enables a system supervisor to restrict who can change critical Setup values.

When you run the Setup program by entering your User password, you can change the three items only: Advanced, User, and Color Set.

If you set both the Supervisor and User passwords, you must set the Supervisor password first. Once both are set, you can enter either the Supervisor password or the User password to access the Setup or the computer.

The system can be configured so that all users can enter a password every time you turn on or reset the system, or run the Setup program, using Supervisor password only or both passwords.

The table shows the effects of setting the Supervisor and User passwords.

Password set	Password during boot	Password to enter the Setup Program	Supervisor mode	User mode
Neither	None	None	Can change all options	Can change all options
Supervisor and User set	Supervisor or User	Supervisor or User	Can change all options	Can change a limited number of options
Supervisor only	Supervisor	Supervisor	Can change all options	–

Setting a Password

Follow these steps to set your password:

- When you see "Enter New Password" in the Supervisor or User window, type the letter you want to use using the keyboard or click it using the mouse. You can type up to six characters using the keys listed in the window. The screen displays an asterisk for each character you type. After typing the password, press Enter.

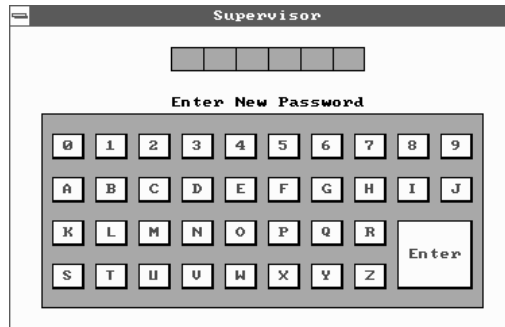

- 2 When you see "Confirm New Password", type your password again and press Enter. If the password you type is different from your password, the screen displays the message "Enter New Password". As you see the following message, press Enter.

Supervisor Password Installed

or

User Password Installed

- 3 When you exit the SETUP program, save your new settings. When you turn on or reset your computer or run SETUP (depending on the setting in Password Check of the Advanced Setup menu), you will see the password prompt.

Note

Be sure to remember the password you enter or write it down. If you cannot remember it, you will not be able to access the computer the next time you turn it on or run SETUP. However, if you forgot your password, there is a way to use your system again. See "Accessing Your Current Password" for more information.

Deleting or Changing a Password

If you want to delete the current password, display the Supervisor or User window and then follow these steps:

- 1 Select the Supervisor or User icon from the Security menu.
- 2 When you see "Enter Current Password", type the current password and press Enter. If you select the User icon, the message does not appear.
- 3 When you see "Enter New Password", just press Enter to delete your current password.
- 4 When you see "Confirm New Password", press Enter again.

5 When you see the following message, press Enter.

Both Passwords Uninstalled
or
User Password Uninstalled

To change the current password, type your new password before pressing Enter on steps 3 and 4.

Disabling a Forgotten Password

If you forget your current password and cannot use your computer or run the Setup, follow these steps:

- 1** Turn off the computer and disable the password function by setting the DIP switch 3 to Off.
- 2** Turn on the computer. You will not see the prompt that asks you to enter your password when you turn on the computer or run the Setup program.
- 3** If you want to set a new password, turn off the computer and enable the password function by setting the DIP switch 3 to On.
- 4** Turn on the computer. As soon as the "Hit Del if you want to run SETUP" message appears on the screen, press the Del key.

If you set a new password, the prompt that asks you to enter the password will appear on the screen when you turn on or reset the computer or run the Setup program.

If you did not set a new password, you would immediately use your system.

If you attempt to set a new password after you set the DIP switch 3 to Off to disable your password, the password will not be saved to CMOS RAM.

Anti-Virus

This option allows the user to protect the hard disk driver or diskette's boot sector from unnecessary writing. The available settings are Enabled and Disabled.

Setting this option to Disabled makes writing on the boot sector possible.

If you select Enabled for this option, when you use the FORMAT, DISKCOPY, or SYS command or any program that tries to write on the boot sector, you will see the following warning message.

Boot Sector Write!!!

Possible VIRUS: Continue (Y/N)? _

At this point if you want to complete the running of the program regardless of the message above, press Y.

If you see the message above in spite of having not run programs described above, viruses may try to write on the boot sector. Select N to prevent the virus from writing on the boot sector.

Notice that if you want to install MS-DOS, Windows 95, Windows NT, or OS/2, set this option to Disabled.

Default Menu

The icons in this section permit you to select a group of settings for all Setup options. Not only can you use these icons to quickly set system configuration parameters, you can choose a group of settings that have a better chance of working when the system is having configuration-related problems.

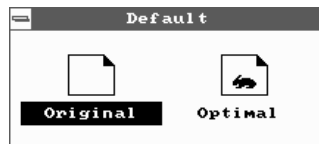

Original

Choose the Original icon to return to the system configuration values present in Setup when you first began this Setup session.

Optimal

You can load the optimal default settings for the Setup by selecting the Optimal icon. The Optimal default settings are best-case values that should optimize system performance. If NVRAM is corrupted, the Optimal settings are loaded automatically.

Chapter 3

Installing and Removing Board Options

This Chapter describes how to install and remove optional board options in your computer. You can use these instructions to install and remove a variety of devices and board options. Although your board options may look a bit different from the ones illustrated herein, you can install and remove it the same way.

Before You Begin

Warning

The procedures in this chapter assume familiarity with the general terminology associated with personal computers and with the safety practices and regulatory compliance required for using and modifying electronic equipment.

Disconnect the computer from its power source and from any telecommunications links, networks, or modems before performing any of the procedures described in this chapter. Failure to disconnect power, telecommunications links, networks, or modems before you open the computer or perform any procedures can result in personal injury or equipment damage. Some circuitry on the mother-board can continue to operate even though the front panel power button is off.

Caution

Electrostatic discharge (ESD) can damage components. Perform the procedures described in this chapter only at an ESD workstation. If such a station is not available, you can provide some ESD protection by wearing an antistatic wrist strap and attaching it to a metal part of the computer chassis.

Installing and Removing the Microprocessor

The ZIF (Zero Insertion Force) socket in your system enables you to replace your CPU in its socket with other CPU.

You can install a microprocessor in a ZIF socket in your system to enhance the performance and speed of your system. However, if the socket contains a microprocessor, you must remove it before installing the new microprocessor.

Note

The processor can be different from illustrations described herein. There are two types, passive heat-sink type (described herein) and active heat-sink fan type, of the processor, but no functional difference.

Installing the Microprocessor

Follow these steps to install the microprocessor:

- 1 Lift up the socket handle up to open the ZIF socket. If there is a microprocessor on the motherboard, you must remove it from its socket.

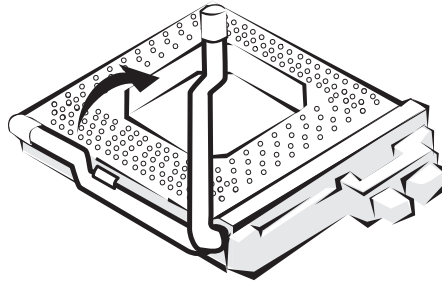

Figure 12. Opening the ZIF socket

- 2 Position the microprocessor over the socket, as shown below, so the notched corner on the microprocessor marked with a dot is aligned with the notched corner on the socket.

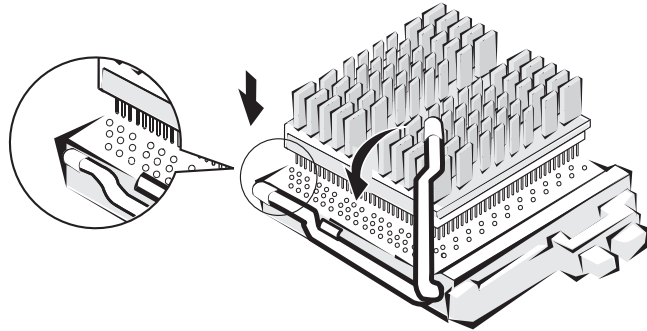

Figure 13. Aligning the microprocessor on the ZIF socket

- 3 Gently push the microprocessor into the socket, and press it until its pins are inserted into the holes of the socket. Then press the ZIF handle downward to close the ZIF socket.

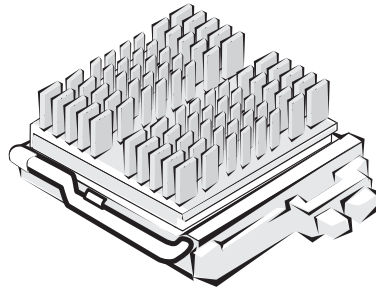

Figure 14. Inserting the microprocessor in the ZIF socket

- 4 If there is a heatsink fan and its cable on the microprocessor, insert the fan cable connector to the fan connector located on the motherboard.

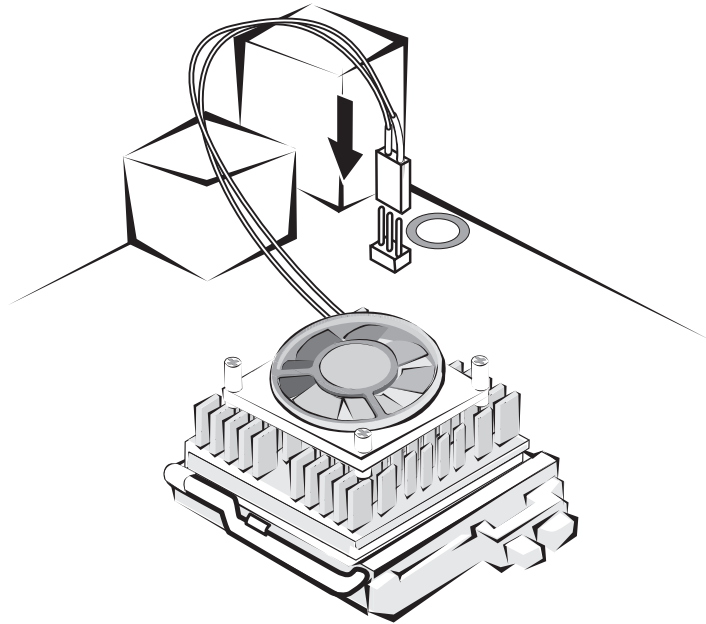

Figure 15. Connecting the heatsink fan connector

Setting the Processor Speed

After you install the processor on the motherboard, set the processor speed by changing the settings of the DIP switches and jumper.

Refer to "Changing the DIP Switch and Jumper Settings" in this Chapter

Removing the Microprocessor

- 1 If there is a heatsink fan on the microprocessor and its cable connector is inserted on the motherboard, pull out the connector from the motherboard.

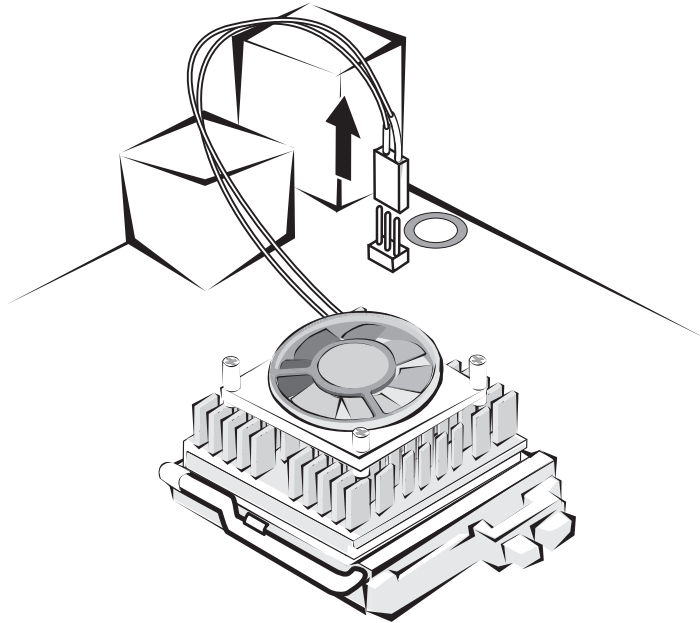

Figure 16. Removing the heatsink fan connector

- 2 Lift up the socket handle up to open the ZIF socket and remove a microprocessor from its socket.

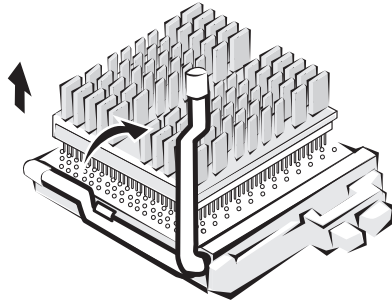

Figure 17. Removing the microprocessor from the ZIF socket

- 3 Press the ZIF handle downward to close the ZIF socket.

Installing and Removing Memory Modules

The motherboard has three dual inline memory module (DIMM) sockets. Minimum memory size is 8 MB; maximum memory size is 384 MB. The BIOS automatically detects memory type, size, and speed.

Each DIMM socket supports the following memory features:

- 168-pin 3.3 V unbuffered DIMMs with gold-plated contacts
- EDO DRAM
- Non-ECC (64-bit) and ECC (72-bit) memory

Single or double sided DIMMs in the following sizes:
8MB, 16MB, 32MB, 64MB, and 128MB.

Note

To purchase a DIMM, contact your dealer or an authorized service center for assistance.

Memory can be installed in one, two, or three sockets. Memory size and speed can vary between sockets.

Installing a Memory Module

Follow these steps to install DIMMs:

- 1 Make sure the clips at either end of the socket are pushed away from the socket.
- 2 Position it by aligning the notches in the DIMM's edge connector with the crossbars in the socket. Insert the bottom edge of the DIMM into the socket.
- 3 Press the DIMM straight down until retaining tabs snap into place around the ends of the DIMM.

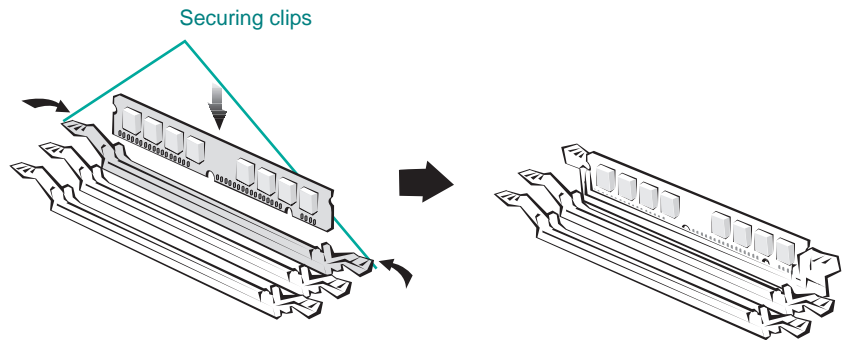

Figure 18. Installing a memory module

Removing a Memory Module

To remove memory modules, press down the retaining tabs that secure the DIMM at each end, using your fingers. Then carefully remove DIMM from the socket.

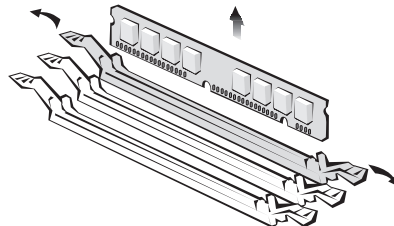

Figure 19. Removing a memory module

Changing DIP Switch and Jumper Settings

A DIP (Dual Inline Package) switch is a small switch and a jumper is a small electrical connector that controls one of the functions of your computer. The settings of DIP switches and jumpers in your computer are preset at the factory; however, you can alter the functions by changing the standard settings:

- Specify CPU clock speed
- Enable or disable the password function
- Clear the CMOS settings
- Select the motherboard type, etc.

Locations of the DIP Switches and Jumpers

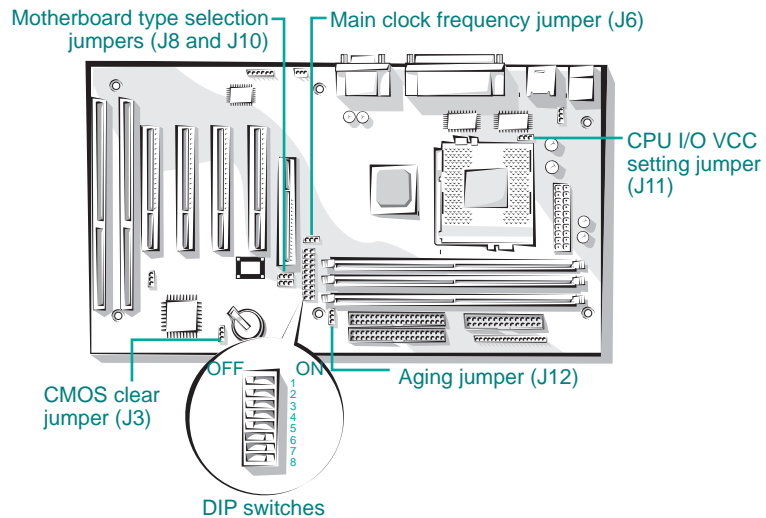

Figure 20. DIP switches and jumpers

DIP Switch and Jumper Settings

DIP switches 5 through 7 allow you to adjust CPU clock speed in according to the type of your system. The following table lists their settings.

Switch 7	Switch 6	Switch 5	Bus frequency				
			Intel				
			P54C	P54CS	P55C	6x86/6x86MX	K5/K6
OFF	ON	ON	-	150MHz 166MHz	150MHz 166MHz	PR166MHz PR200MHz	150MHz 166MHz
OFF	ON	OFF	-	200MHz	200MHz	PR233MHz	200MHz
OFF	OFF	ON	120MHz 133MHz	120MHz 133MHz	120MHz 133MHz	PR133MHz	120MHz 133MHz
OFF	OFF	OFF	90MHz 100MHz	120MHz 133MHz	233MHz	PR266MHz	233MHz
ON	ON	ON	-	-	-	-	300MHz
ON	ON	OFF	-	-	-	-	300MHz
ON	OFF	ON	-	-	-	-	266MHz
ON	OFF	OFF	-	-	-	-	Reserved

The following table lists the settings of DIP switches 1 through 4 and a jumper (J11).

J11	Switch 1	Switch 2	Switch 3	Switch 4	Output	CPU type
1-2	ON	ON	OFF	OFF	2.2V	AMD K6
1-2	OFF	OFF	OFF	ON	2.8V	Intel P55C
1-2	ON	OFF	OFF	ON	2.9V	AMD K6, Cyrix 6x86MX
1-2	OFF	OFF	ON	ON	3.2V	AMD K6
2-3	OFF	ON	ON	ON	3.4V	Other non-MMX CPU*

* Other non-MMX CPU : Intel P54C(S), AMD K5, and Cyrix 6x86

Note

To set a DIP switch, push the DIP switch to the OFF or ON position.

Caution

Do not move the DIP switches or jumpers with the power on. Always turn off the power and unplug the power cord from the computer before changing the DIP switches and jumpers.

The following table lists the settings of the motherboard type.

J8	J10	Motherboard type
2-3	2-3	Without sound system and hardware monitoring function
2-3	1-2	Without sound system, but with hardware monitoring function
1-2	2-3	With sound system and hardware monitoring function
1-2	1-2	Reserved

The following table lists the DIP switch and jumper settings for others.

	Setting	Function
J6 (set the clock)	1-2	66.8 MHz (CPU), 33.4 MHz (PCI)
	2-3	60.0 MHz (CPU), 30.0 MHz (PCI)
J12 (aging)	1-2	Normal
	2-3	Final aging (Manufacturing setting)
Switch8 (Password)	ON	Disabled the password
	OFF	Enabled the Password

The Things to do in Post-installation

After you install or remove board options, if necessary, be sure to run Setup program to update the configuration of you system. See Chapter 2 for detail information.

If you installed a new optional equipment and Windows 95 has installed in your system, you need to have Windows 95 detects it. See Windows 95 manual and the manual that came with your optional equipment for detail information.

Chapter 4

Audio Drivers and Applications

The Crystal 4236B audio controller is built in the motherboard. If your system comes with a hard disk drive installed, the audio drivers and applications will be already installed in your system. However, if you need to reinstall them, install them using the Driver CD that comes with your system as described in this chapter.

Installing the Audio Drivers

Follow these steps to reinstall the audio drivers for Windows 95:

- 1 Start the Windows 95 operating system.
- 2 Insert the driver CD into the CD-ROM drive.
- 3 From the Start menu, select Run. Click Browse, select “D:\audio\win95\English\Setup.exe,” click Open, and click OK.

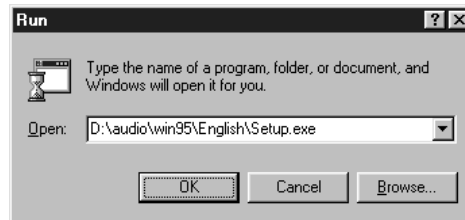

Note

The Setup will do an automatic cleaning up of the Windows 95 Crystal Audio registry entries. Many problems with reinstallation occur because of existing registry entries from previous installations and because of the "\\WINDOWS\\INF\\OEMx.INF" files. After running setup, the various Crystal devices from the Control Panel should disappear. It is recommended that prior to running Setup, remove the device entries in the Sound, Video, and Game Controller of the System Device Manager, and Crystal entries (if any) in the Other detected devices section of the Device Manager.

- 4 At the Crystal Semiconductor dialog box, click Install Driver.



- 5 When the Complete Installation dialog box appears, click Restart.



- 6 Windows 95 is restarted.
- 7 Windows 95 automatically recognizes new PnP audio hardware, creates a database for the hardware, and proceeds with the installation of Crystal device drivers.
- 8 If the Update Device Driver Wizard window appears, click Next.



- 9 Click Other Locations. When the Select Other Location dialog box appears, click Browse, select “D:\audio\win95\English,” and click OK.



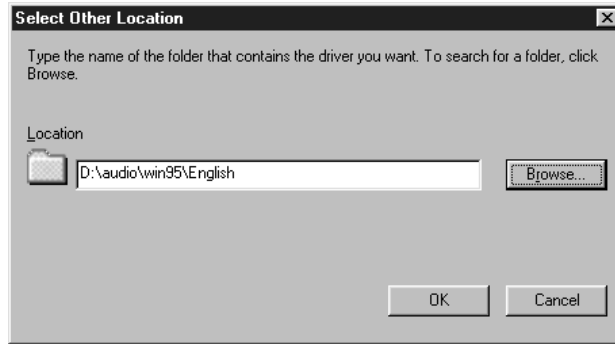

- 10 When the Select Other Location dialog box appears again, click OK and then click Finish in the Update Device Driver Wizard window.
- 11 When the Insert Disk dialog box appears, click OK.
- 12 If the Copying Files dialog box appears prompting for the location of additional files, click Browse, select “D:\AUDIO\WIN95\ENGLSIH\CWB3DSND.EXE,” and click OK.
- 13 Click OK in the Copying Files dialog box.

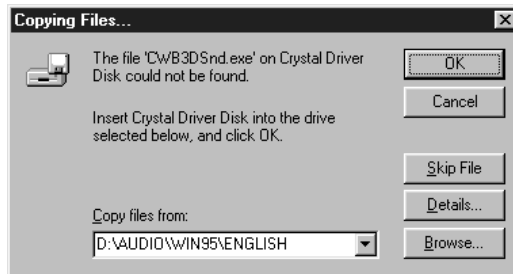

- 14 When the Insert Disk dialog box appears prompting for inserting the Windows 95 CD-ROM, remove the Driver CD, insert the Windows 95 CD, and click OK.

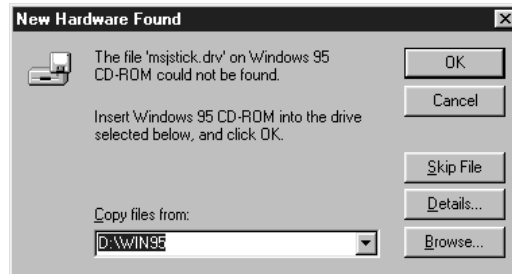

- 15 When the Insert Disk dialog box appears prompting for inserting the Crystal Driver Disk, remove the Windows 95 CD, insert the Driver CD into the CD-ROM drive, and click OK.
- 16 When the New Hardware Found dialog box appears and “D:\ AUDIO\WIN95\ ENGLISH” is selected, click OK.

If you select Settings | Control Panel from the Start menu and select System icon, the System Properties window will appear. If you select the Device Manager tab at this window after installing the audio drivers, you will see an additional line for the audio drivers, "Sound, video and game controllers" in the Device Manager window. Double clicking on the "Sound, video and game controllers" entry in the Device Manager window, will expand the line to list the Crystal codec Logical Devices installed as shown below.

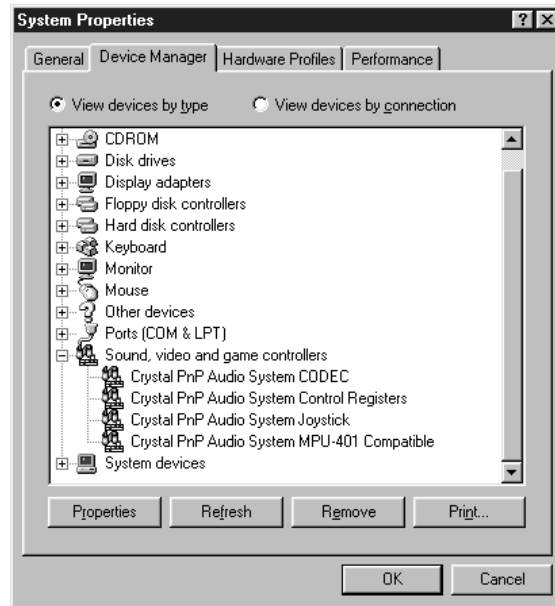

Installing and Using the Audio Applications

Installing the Audio Applications

Follow these steps to install the audio utilities:

- 1 Insert the Driver CD into the CD-ROM drive.

- From the Start menu, select Run. Click Browse, select “D:\audio\Voyetra\Setup.exe,” click Open, and click OK.

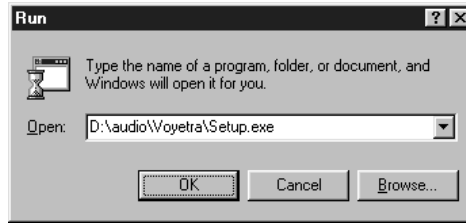

- When the Software License Agreement window appears, click Yes.

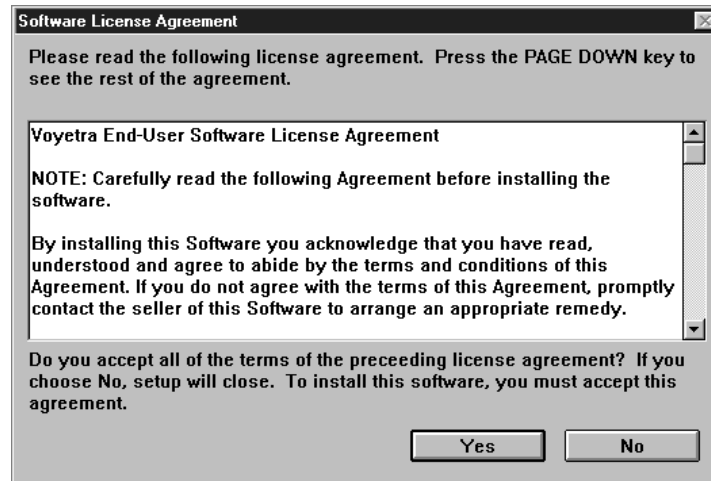

- When the Welcome dialog box is displayed, click Continue.



- 5 Accept the folder displayed on the window or change folder. Then click Install.

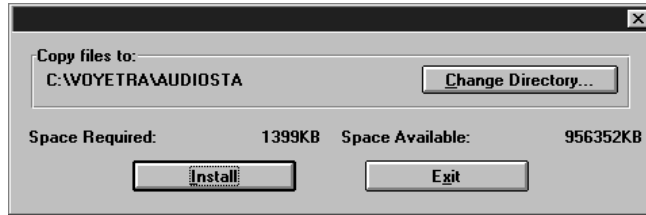

- 6 When Restart Windows appears, click Restart Windows for the changes to take effect.



- 7 After you restart your operating system, the Voyetra program group would be displayed on the screen and under Programs from the Start menu.

Using the Audio Applications

To use the audio applications (AudioStation and WinDAT), follow the next steps:

- 1 Start Windows 95.
- 2 Click the Start button, point to Programs, point to Yamaha, and then select AudioStation or WinDAT.

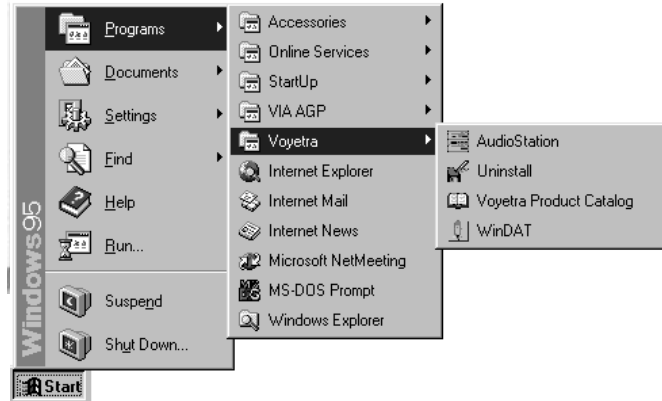

AudioStation

AudioStation is a component audio system that can play or record audio CDs, digital audio files (WAV or VOC), or MIDI files (MID, RMI or ORC). This consists of Audio Mixer, CD Player, Digital Audio Player, and MIDI Player.

Audio Mixer lets you adjust the volumes of the various audio components and set recording levels for digital audio. You can play audio CDs with the CD Player. You can play digital audio (WAV) files with the Digital Audio Player and edit digital audio files using WinDAT displayed by pressing the Edit button. With the MIDI Player, you can play MIDI files. You can audition CD, WAV and MIDI files and create custom playlists.

See the online help by clicking the  button for information on using AudioStation.



WinDAT

WinDAT is a digital audio editor that can playback, record, or edit digital audio files (WAV or VOC). This can be selected from the Start menu or be launched from the Digital Audio Player of AudioStation.

See the online help by pressing F1 for information on using WinDAT.



Chapter 5

Update on Installing Windows 95

If you reinstalled or upgraded Windows 95, you need to install the drivers. Follow the next steps:

- 1 Installing the USB driver
- 2 Installing the ACPI driver
- 3 Installing the AGP driver (optional, if you installed the AGP card in your system : for more information, refer to the manual that comes with your optional AGP card)
- 4 Installing the DirectX-5 driver (if you installed the AGP driver)
- 5 Installing the AGP VxD driver (if you installed the AGP driver)
- 6 Installing the Audio drivers (manufacturing option, see chapter 4 “Audio Drivers and Applications”)

Installing the USB Driver

Your motherboard has two USB ports. USB is the next generation of peripheral interface design. USB allows easy attachment of peripherals to your system.

Note

It is recommended that prior to running Usbsupp to install the USB driver, remove the PCI Universal Serial Bus entries (if any) in the Other Devices of the Device Manager from the Control Panel.

The USB driver is included in your Windows 95 CD.

Note

To install from your Windows 95 CD, be sure your Windows95 CD is OSR2 with USB support version. (See on the surface of Windows 95 CD title.)

Follow these steps for USB driver installation.

- 1 Insert Windows 95 CD-ROM into CD-ROM drive.
- 2 Click the Start button, and then click Run.
- 3 Set the path to "D:\other\usb\usbsupp.exe" and click OK to install the Microsoft USB Supplement to your system.

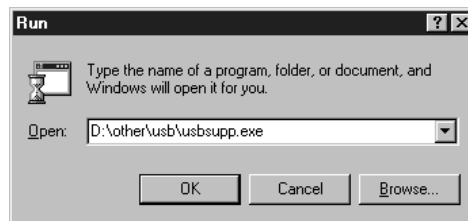

- 4 Click Yes, and then click Yes to accept the agreement.
- 5 Setup will scan your system. Click OK to complete setup when the installation is finished. Setup will restart your system.

- 6 If an "Update Device Driver Wizard" window appears after Windows 95 reboots, follow the instructions on screen. Proceed to step 7, otherwise USB installation is finished.
- 7 Click Next to continue.
- 8 Click the Finish button.
- 9 Set the path to "C:\windows\system" and click OK.

Installing the ACPI Driver

The Advanced Configuration and Power Interface (ACPI) specification provides a key element in Operating System Directed Power Management (OSPM). OSPM and ACPI both apply to all classes of computers.

ACPI evolves the existing collection of power management BIOS code, APM APIs, PNPBIOS APIs, and so on into a well-specified power management and configuration mechanism.

Follow these steps to install the ACPI driver:

- 1 Click the Start button, and then click Run.
- 2 Insert the Driver CD into your CD-ROM drive.
- 3 Click Browse, select "D:\VIA\ACPI Driver\Setup.exe," click Open, and click OK.

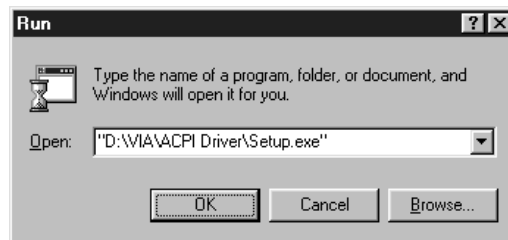

- 4 When the VIA Power Management Controller window is displayed, click Next.



- 5 Select Install VIA ACPI Patch and click the Next button.

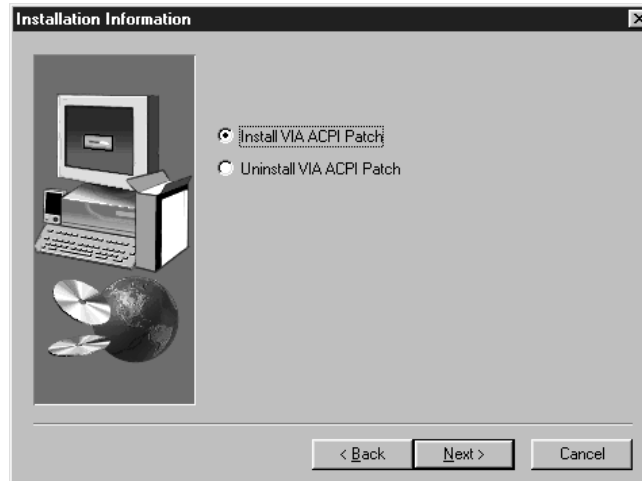

- 6 Select "Yes, I want to restart my computer now." and click the Finish button to restart the computer.

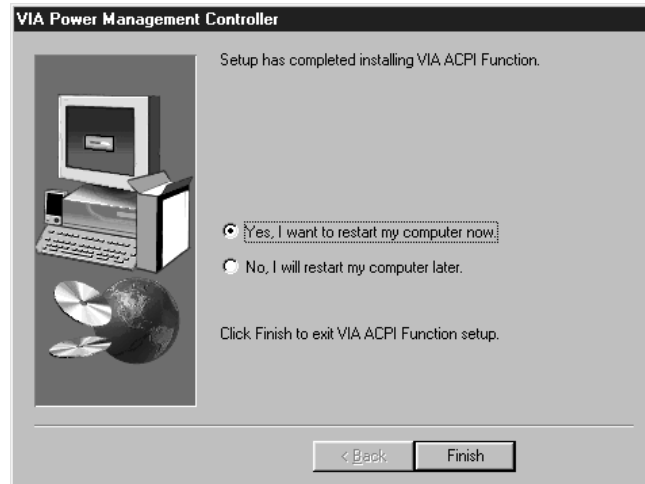

Installing the DirectX-5 Driver

To use the AGP driver, install the DirectX-5 driver.

Follow these steps to install the DirectX-5 driver:

- 1 Click the Start button, and then click Run.
- 2 Insert the Driver CD into your CD-ROM drive.
- 3 Click Browse, select "D:\DX-5\Setup.exe," click Open, and click OK.

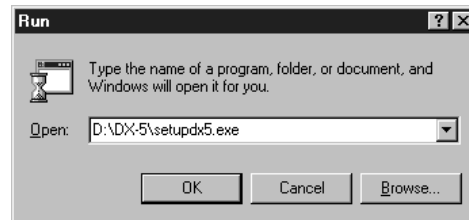

- 4 The DirectX-5 driver will be installed in your hard disk drive.



Installing the AGP VxD Driver

Follow these steps to install the AGP VxD driver:

- 1 Click the Start button, and then click Run.
- 2 Insert the Driver CD into your CD-ROM drive.
- 3 Click Browse, select “D:\VIA\AGP VxD for WIN95\Setup.exe,” click Open, and click OK.

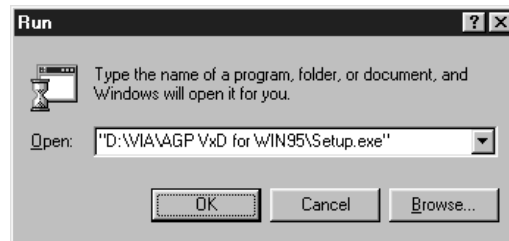

- 4 When the VIAGART Setup Program window is displayed, click Next.



- 5 Select Install VIA AGP VxD and click the Next button.



- 6 Select "Yes, I want to restart my computer now." and click the Finish button to restart the computer.



Appendix A

Specifications

Form Factor

ATX form factor of 12 * 7.75 inches

Processor

- Intel Pentium up to 200 MHz processor
- Intel Pentium up to 233 MHz processor with MMX technology
- AMD K5/K6 up to 233 MHz processor (Ready for up to 300MHz)
- Cyrix 6x86 or 6x86MX/PR 200MHz processor

Main Memory

- Three 168-pin DIMM sockets
- Supports up to 384 MB of synchronous DRAM (SDRAM) memory
- Supports EDO DRAM
- ECC or non-ECC memory

Apollo VP3 AGPset and PCI/IDE Interface

- VT82C597 single chip north bridge (PCI/AGP/Memory controller (PAC))
 - Integrated PCI bus mastering controller
 - Integrated Accelerated Graphics Port (AGP) controller
 - Integrated memory controller
- VT82C586B PCI/ISA/IDE Xcelerator
 - Supports up to four IDE drives or devices
 - PC-97 compatible PCI-to-ISA bridge
 - USB and DMA controllers
 - Keyboard and mouse controller
 - Two fast IDE interfaces
 - Power management logic
 - Real-time clock controller

I/O features

- IT8661F Super I/O controller
 - Integrates standard I/O functions: floppy-drive interface, one multimode parallel port, two FIFO serial ports, IrDA-compatible interface
- Two Universal Serial Bus (USB) interfaces

Six usable expansion slots

- One ISA slot
- Three PCI slots
- One shared PCI/ISA slot
- Onboard AGP connector

Other features

- AMI BIOS
- Plug and Play compatible
- Advanced Power Management (APM, ACPI)

Manufacturing Options

- Management extension hardware (Sound system and hardware monitoring function)

Power Supply

For typical configurations, the motherboard is designed to operate with at least a 200 W power supply. A higher-wattage power supply should be used for heavily-loaded configurations. The power supply must meet the following requirements:

- Rise time for power supply: 2 ms to 20 ms
- Minimum delay for reset to Power Good: 100 ms
- Minimum Powerdown warning: 1 ms
- 3.3 V output must reach its minimum regulation level within (20 ms of the +5 V output reaching its minimum regulation level)

Appendix B

Error and Information Messages

BIOS Error Messages

Error Message	Explanation
Timer Error	The timer test failed. Requires repair of system motherboard.
CMOS battery Low	CMOS RAM is powered by a battery. The battery power is low. Replace the battery.
CMOS Checksum Bad	After CMOS RAM values are saved, a checksum value is generated for error checking. The previous value is different from the current value. Run BIOS Setup.
CMOS Settings Wrong	The values stored in CMOS RAM are either corrupt or nonexistent. Run BIOS Setup.
CMOS Display Type Wrong	The video type in CMOS RAM does not match the type detected by the BIOS. Run Setup.
Unlock Keyboard	The keyboard lock on the computer is engaged. The computer must be unlocked to continue.
Keyboard Error	Keyboard not working.
KB/Interface Error	There is an error in the keyboard connector.
CMOS Memory Size Wrong	The amount of memory on the motherboard is different than the amount in CMOS RAM. Run BIOS Setup.
FDC Failure	The BIOS cannot communicate with the floppy disk drive controller. Check all appropriate connections after the computer is powered down.
Pri Master(Slave) HDD Error	Primary Master (Slave) HDD is not working or not configured properly. Check to see if fixed disk is installed properly.

Error Message	Explanation
Sec Master(Slave) HDD Error	Secondary Master (Slave) HDD is not working or not configured properly. Check to see if fixed disk is installed properly.
CMOS Date/Time Not Set	Run Standard Setup to set the date and time in CMOS RAM.
A: Drive Error or B: Drive error	Drive A or B is present but fails the POST diskette tests. Check that the drive is defined with the proper diskette type in Setup and that the diskette drive is installed correctly.
Cache Memory Error	Cache memory is defective.
GA20 Error	Gate A20 on the keyboard controller is not working.
DMA Error	Error in the DMA controller.

BIOS Beep Codes

Beeps codes represent a terminal error. If the BIOS detects a terminal error condition, it outputs an error beep code, halts the POST, and attempts to display a port 80h code on the POST card's LED display.

Beeps	80h Code	Description
1	B4h	One short beep before boot
1-2	98h	Search for option ROMs
1-2-2-3	16h	BIOS ROM checksum
1-3-1-1	20h	Test DRAM refresh
1-3-1-3	22h	Test 8742 keyboard controller
1-3-4-1	2Ch	RAM failure on address line xxxx*
1-3-4-3	2Eh	RAM failure on data bits xxxx* of low byte of memory bus
1-4-1-1	30h	RAM failure on data bits xxxx* of high byte of memory bus
2-1-2-3	46h	Check ROM copyright notice
2-2-3-1	58h	Test for unexpected interrupts

Appendix C

Motherboard Resources

DMA Channels

DMA Channel Number	Data Width	System Resource
0	8- or 16-bits	Audio (if present, else user available)
1	8- or 16-bits	Audio / parallel port (if present, else user available)
2	8- or 16-bits	Floppy drive (if present, else user available)
3	8- or 16-bits	Parallel port (for ECP)/audio (if present, else user available)
4		Reserved - cascade channel
5	16-bits	Reserved
6	16-bits	Reserved
7	16-bits	Reserved

Interrupts

IRQ	System Resource
NMI	I/O channel check
0	Interval timer
1	Keyboard
2	Cascade interrupt from slave PIC
3	COM2*
4	COM1*
5	LPT2 (Plug and Play option) / audio (if present, else user available)
6	Floppy drive
7	LPT1*
8	Real time clock
9	User available
10	User available
11	Windows Sound System* / USB (if present, else user available)
12	Onboard mouse port (if present, else user available)
13	Math coprocessor
14	Primary IDE (if present, else user available)
15	Secondary IDE (if present, else user available)

* Default, but can be changed to another IRQ

Declaration of Conformity (CE)

Application of Council Directives	89/336/EEC EMC Directive	
Manufacturer's Name	TriGem Computer Inc.	
Manufacturer's Address	1055 Shin-gil-Dong, Ansan City, Kyunggi Do, Republic of Korea	
European Representative Name	TriGem Computer (U.K.) Ltd.	
European Representative Address	69 Bucking Ave. Trading Estate Slough Berkshire SL1 4PN U.K.	
Equipment Type/Environment	Main Board	
Model Name	LI545	
Conformance to	European	International
	EN 55022 (1995 Class B)	CISPR 22 (1985 Class B)
	EN 50082-1 (1992)	IEC 801-2 (1984 Level 3)
	EN 61000-3-2 (1995)	IEC 801-3 (1984 Level 2)
	EN 61000-3-3 (1995)	IEC 801-4 (1988 Level 2)

We hereby declare that the equipment specified conforms to the above Directives.

Manufacturer	Legal Representative in Europe
Full Name	Full Name
Sang-Ryong Ko	Hyun Woo Choi
Position	Position
Dept. Manager	President
Place	Place
1055 Shin-gil-Dong, Ansan City, Kyunggi Do, Republic of Korea	69 Bucking Ave. Trading Estate Slough Berkshire SL1 4PN U.K.
Date	Date
December, 1997	December, 1997