

LE-578

5.25" Embedded Miniboard

User's Manual

Edition 1.7
2020/01/10

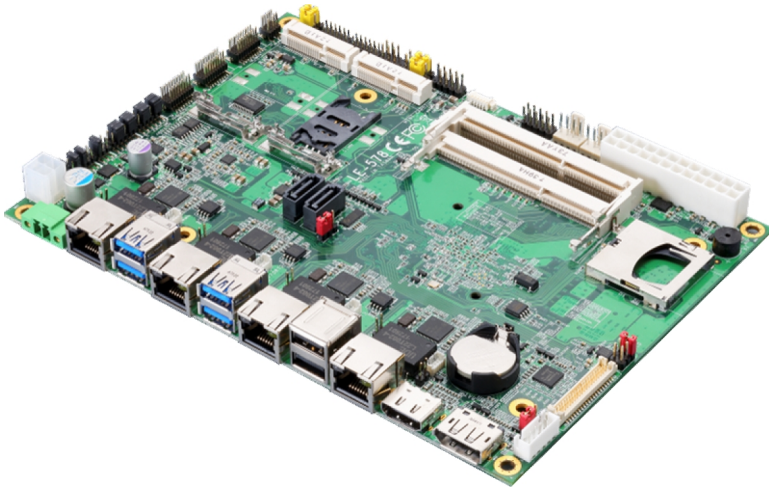

Copyright

Copyright 2017, all rights reserved. This document is copyrighted and all rights are reserved. The information in this document is subject to change without prior notice to make improvements to the products.

This document contains proprietary information and protected by copyright. No part of this document may be reproduced, copied, or translated in any form or any means without prior written permission of the manufacturer.

All trademarks and/or registered trademarks contains in this document are property of their respective owners.

Disclaimer

The company shall not be liable for any incidental or consequential damages resulting from the performance or use of this product.

The company does not issue a warranty of any kind, express or implied, including without limitation implied warranties of merchantability or fitness for a particular purpose.

The company has the right to revise the manual or include changes in the specifications of the product described within it at any time without notice and without obligation to notify any person of such revision or changes.

Trademark

All trademarks are the property of their respective holders.

Any questions please visit our website at <http://www.commell.com.tw>

Packing List:

Please check the package content before you starting using the board.



1 x LE-578 Mini-ITX Motherboard
(include Heat sink)

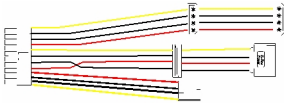

1 x Power Cable
(OALATX-P3S2 / 1040058)



2 x SATA Cable
(OALSATA3-L / 1040529)



1 x Dual COM cable
(OALBS-BKU2NB / 1040090)



1 x Audio cable
(OALPJ-HDUNB / 1040123)

Optional:

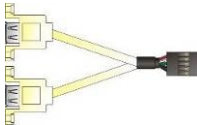

1 x USB2.0 cable
(OALUSBA-3) / (1040173)



1 x PS/2 Keyboard & Mouse cable
(OALPS2/KM / 1040131)



1 x DDR3L SO-DIMM
(DSDM8GB-DDR3L-1600-SO-1.35V / 1140073)

Printed Matters:

Driver CD (Including User's Manual) x 1

Index

Chapter 1 <Introduction>	4
1.1 <Product Overview>.....	4
1.2 <Product Specification>	5
1.3 <Block Diagram>.....	6
Chapter 2 <Hardware setup>	7
2.1 <Connector Location and Reference>	7
2.1.1 <Internal connectors list>	8
2.1.2 <External connectors list>.....	8
2.2 <Jumper Location and Reference>	9
2.2.1 <Jumper list>	9
2.2.2 <Clear CMOS and Power on type selection>.....	10
2.3 <Installing the Memory>	10
2.4 <I/O interface>	11
2.4.1 <Serial ATA interface>	11
2.4.2 <Ethernet interface>.....	12
2.4.3 < Power Sourcing Equipment >	12
2.4.4 <Display interface>	12
2.4.5 <Serial Port interface>	14
2.4.6 <USB interface>.....	17
2.4.7 <Audio interface>	18
2.4.8 <Expansion slot>.....	19
2.4.8.1 < MINI_CARD Setting >	20
2.4.8.2 < SIMM Setup>	20
2.4.9 <Front panel switch and indicator>	21
2.4.10 <Other interface>	21
2.5 <Power supply>	23
2.5.1 <Power input>	23
2.5.2 <Power output>.....	25
Appendix A <Flash BIOS>	26
Appendix B <LCD Panel Type select>	27
Appendix C <Programmable Watch Dog Timer>	29
Appendix D <Programmable GPIO >	30
Appendix E <SuperIO Setting>	31
Appendix F <RS485 auto flow Setting>	32
Appendix G <Setup PoE device>	33
Contact information	35

Chapter 1 <Introduction>

1.1 <Product Overview>

LE-578 is Mini-ITX Motherboard which is design based on Intel® Celeron® Processor N3350, and Intel® Pentium® Processor N4200 (Apollo Lake SoC), delivering outstanding compute, graphical, and media performance while operating in an extended range of thermal conditions. The SoC bases on the Silvermont microarchitecture, utilizing Intel's industry-leading 14nm process technology with 3-D Tri-Gate transistors, which deliver significant improvements in computational performance and energy efficiency.

New features for Apollo Lake

The Intel® Celeron® Processor N3350, and Intel® Pentium® Processor N4200 have a lower TDP 6W, it provides new HD Graphics to support triple display, 4K resolution, maximum memory size is up to 8GB of DDR3L, and more enhanced security that is suitable for a variety of intelligent systems the ideal choice.

All in One multimedia solution

The board provides high performance onboard graphics, 18/24-bit single/dual channel LVDS interface, DisplayPort, HDMI, and High Definition Audio, to meet the very requirement of the multimedia application.

Flexible Expansion Interface

The board provides one MiniPCIe and support mSATA.

Apollo Lake only support Windows10 64bit

So far Intel just support Windows 10 64bit. It may lose some drivers if you use other Windows version.

1.2 <Product Specification>

System

Processor	Intel® Apollo Lake Series Processor N3350/ N4200/E3940, FCBGA1296 package
Chipset	Apollo Lake SoC
Memory	2 x DDR3L DIMM 1866 MHz up to 8GB, Support Non-ECC, unbuffered memory only
Watchdog Timer	Generates a system reset with internal timer for 1min/s ~ 255min/s
Real Time Clock	Chipset integrated RTC with onboard lithium battery
Expansion	2 x MiniPCle (Card1 Support mSATA), 1 x SIM slot 1 x SD Card slot

Graphics

Processor	Intel® HD Graphics
Display Interface	1 x LVDS, 1 x DisplayPort, 1 x HDMI

LAN

Chip	4 x Intel® I210-AT Gigabit LAN
PSE	With ADP-PSE4 support four independent PSE function capable of delivering up to 90W.

I/O

Serial ATA	2 x SATA3 interface with 600MB/s transfer rate (mSATA shared with SATA3-2)
Audio	Realtek ALC262 HD Audio
Internal I/O	2 x SATA3, 2 x RS232/422/485, 4 x RS232, 2 x USB2.0, 1 x LPC, 1 x GPIO, 1 x PS/2, 1 x SMBUS, 1 x Audio, 1 x LVDS, 1 x LCD inverter
Rear I/O	4 x USB3.0, 2 x USB2.0, 4 x LAN 1 x HDMI, 1 x Display Port

Mechanical & Environmental

Power Requirement	ATX or DC input 6~35V
Size	203mm x 146mm (L x W)
Temperature	Operating within 0°C~60°C (32°F~140°F) Storage within -20°C~80°C (-4°F~176°F)
Relative Humidity	10%~90%, non-condensing

1.3 <Block Diagram>

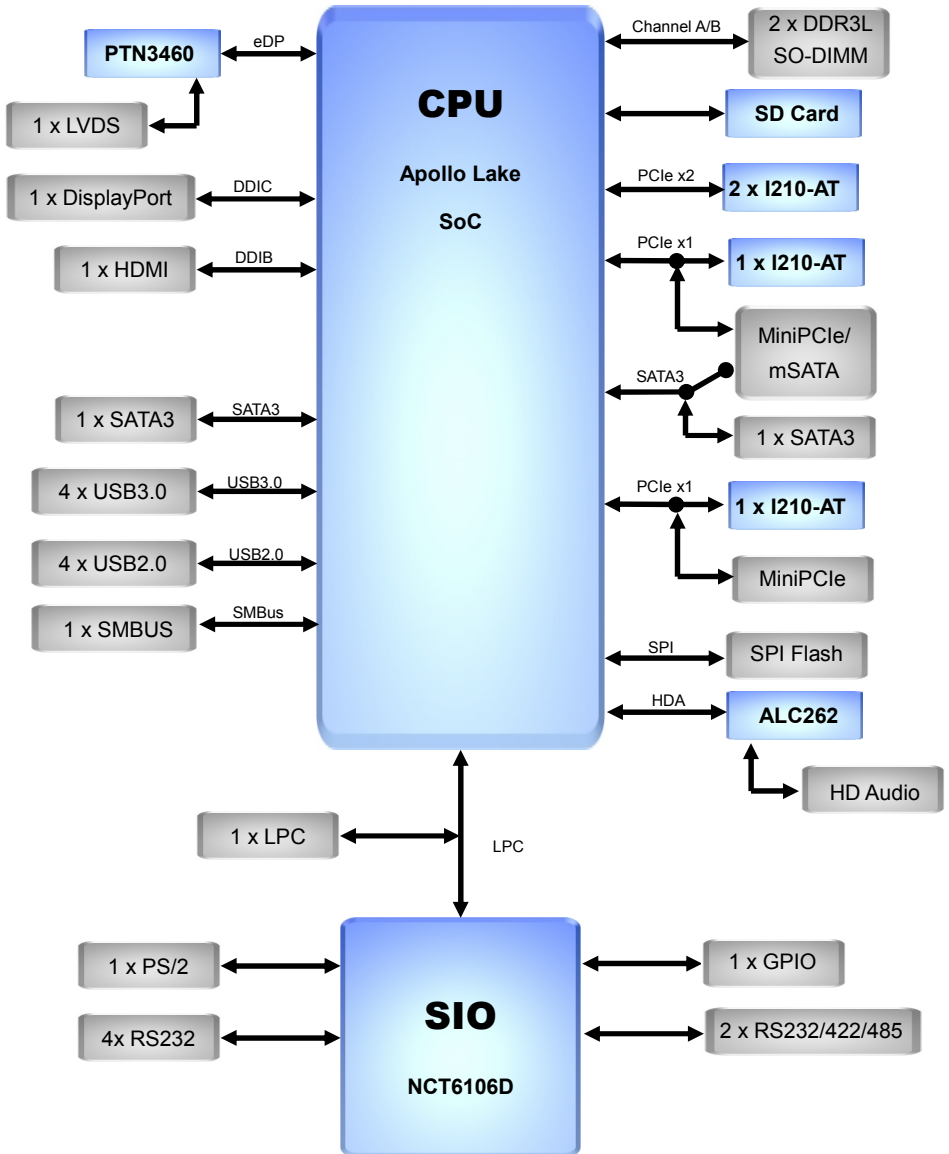

Chapter 2 <Hardware setup>

2.1 <Connector Location and Reference>

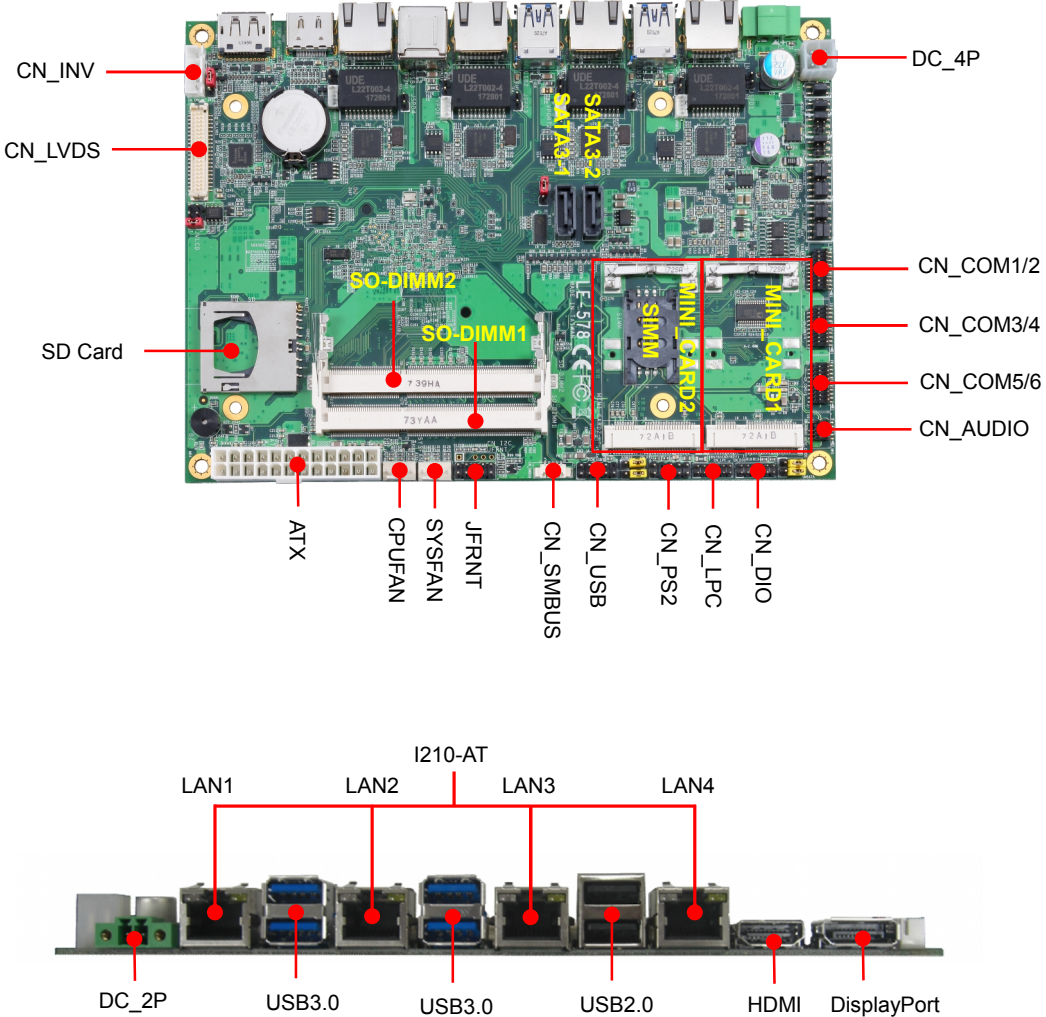

2.1.1 <Internal connectors list>

Connector	Function
SO-DIMM1/2	204-pin DDR3L SO-DIMM slot
SATA3-1/2	7-pin Serial ATA3 connector
CN_AUDIO	5 x 2-pin audio pin header
CN_LPC	6 x 2-pin LPC pin header
CN_DIO	6 x 2-pin General Purpose In/Out pin header
CN_PS2	5 x 2-pin PS/2 pin header
CN_LVDS	20 x 2-pin LVDS connector
CN_INV	5-pin LCD inverter connector
CN_COM1/2	20-pin RS232/RS485/RS422 pin header
CN_COM3/4	20-pin RS232 pin header
CN_COM5/6	20-pin RS232 pin header
CN_SMBUS	5-pin SMBus pin header
CN_USB	5 x 2-pin USB2.0 pin header
SIMM	6-pin SIM card slot
CPUFAN	4-pin CPU fan connector
SYSFAN	4-pin system fan connector
JFRNT	5 x 2-pin front panel switch/indicator pin header
SD card	9-pin SD card slot
MINI_CARD1/2	52-pin MiniPCIe card slot
DC_4P	ATX12V connector support DC 6~35V input
ATX	20+4-pin main power connector

2.1.2 <External connectors list>

Connector	Function
DC_2P	2-pin Terminal block support DC 6~35V input
LAN1/2/3/4	RJ45 connector
DisplayPort	DisplayPort connector
HDMI	HDMI connector
USB3.0	USB3.0 connector
USB2.0	USB2.0 connector

2.2 <Jumper Location and Reference>

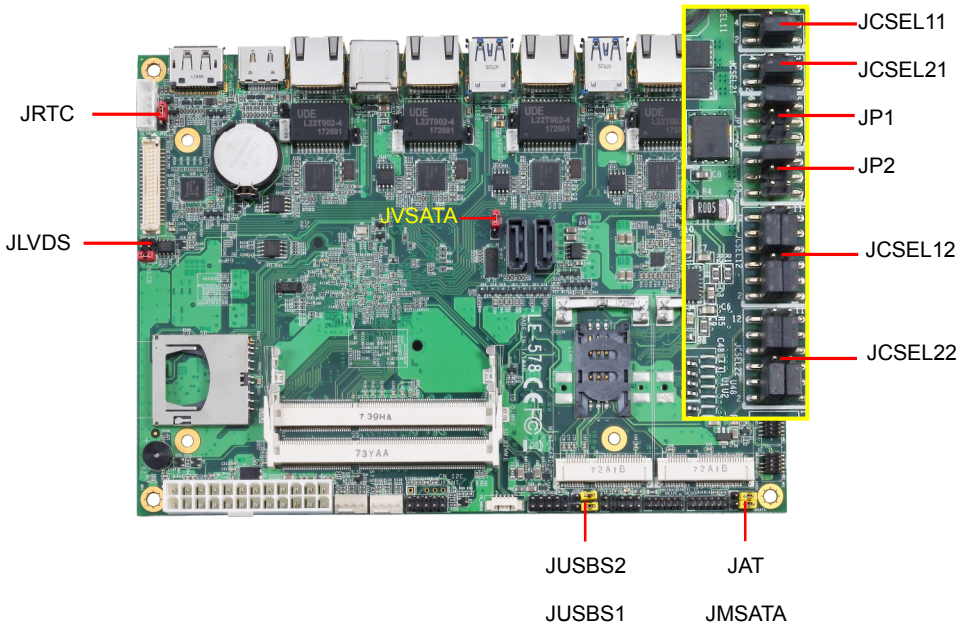

2.2.1 <Jumper list>

Jumper	Function
JAT	Power mode select
JMSATA	MiniCard mSATA Setting
JRTC	CMOS Normal/Clear Setting
JUSBS	MiniCard USB Setting
JVLCD	Panel Voltage Setting
JCSEL12/22	COM1/2 RS232/422/485 select
JCSEL11/21	COM1/2 RS232/422/485 select
JP1/2	COM1 and COM2 Voltage Setting (For Pin 9)

2.2.2 <Clear CMOS and Power on type selection>

JAT: AT/ATX mode select jumper

Jumper settings	Function
1-2	AT mode
2-3	ATX mode (Default)

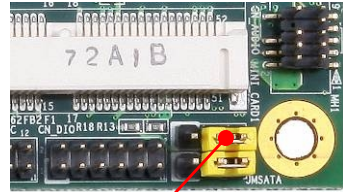

JRTC: Clear CMOS data jumper

Jumper settings	Function
1-2	Clear CMOS
2-3	Normal (Default)



2.3 <Installing the Memory>

In the process, the board must be powered off.

1. Put the memory tilt into the slot. Note the Memory notch key aligned slot key.
2. Then press down till lock into the mounting notch.

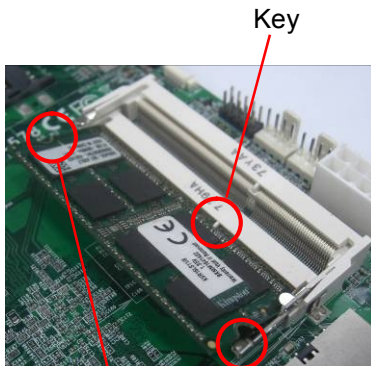

Press down



Mounting notch

3. To remove the memory, push outward on both sides of the latch.

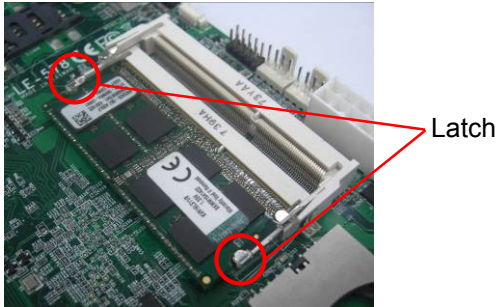

2.4 <I/O interface>

2.4.1 <Serial ATA interface>

SATA3-1/2: SATA3 7-pin connector

Pin	Signal
1	GND
2	TX+
3	TX-
4	GND
5	RX-
6	RX+
7	GND

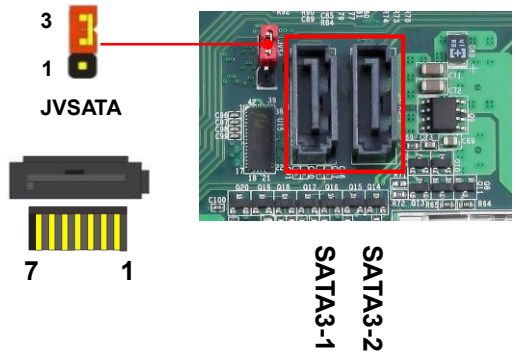

JVSATA: SATA3/SATADOM mode select jumper (change pin7 to 5V)

Jumper settings	Function
1-2	SATA3-2 SATADOM
2-3	SATA3-2 SATA3 (Default)

2.4.2 <Ethernet interface>

The board provide I210-AT Gigabit Ethernet which supports WOL on rear I/O.

Find the setting from

Front Page→Setup utility→

Advanced→South Cluster Configuration→ Miscellaneous Configuration→

Wake on LAN [Disable] (default)

(You have to turn off fast startup in Windows10)

2.4.3 < Power Sourcing Equipment >

With ADP-PSE4 support four independent PSE function capable of delivering up to 90W.

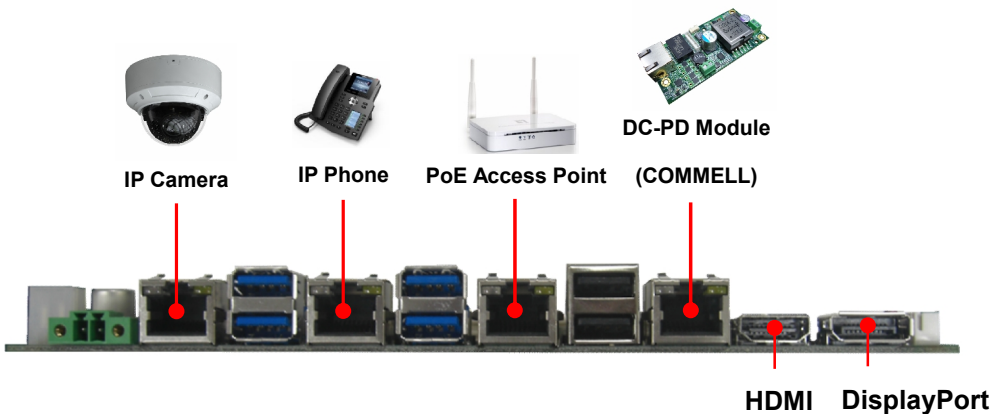

2.4.4 <Display interface>

Based on the Apollo Lake SoC with built-in HD Graphics, the DisplayPort1.2 up to **4096x2160 @ 60Hz** on rear I/O.About the internal Display, the HDMI1.4b resolution up to **3840x2160 @ 30Hz** and LVDS (PTN3460) up to **1920x1200 @ 60Hz** support 18/24-bit color depth and single/dual channel. About select LCD Panel Type in BIOS, please refer [Appendix B](#).The built-in HD Graphics support triple display function with clone mode and extended mode.

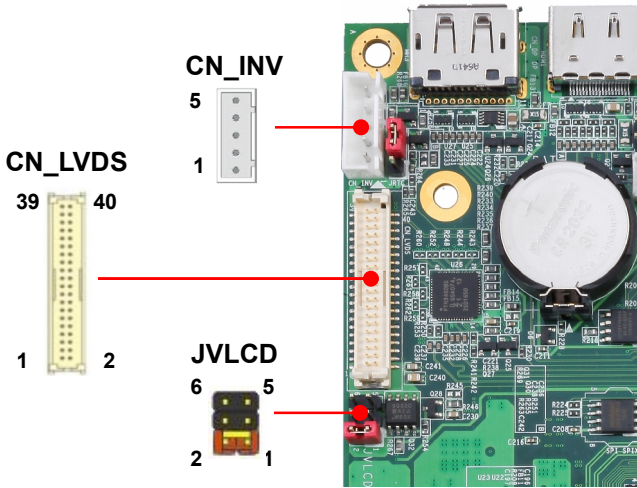

CN_LVDS: LVDS 40-pin connector (Model: HIROSE DF13-40DP-1.25V compatible)

Pin	Signal	Pin	Signal
2	Set by JVLCD	1	Set by JVLCD
4	Detect (Active low)	3	GND
6	A_LVDS_0-	5	B_LVDS_0-
8	A_LVDS_0+	7	B_LVDS_0+
10	GND	9	GND
12	A_LVDS_1-	11	B_LVDS_1-
14	A_LVDS_1+	13	B_LVDS_1+
16	GND	15	GND
18	A_LVDS_2-	17	B_LVDS_2-
20	A_LVDS_2+	19	B_LVDS_2+
22	GND	21	GND
24	A_LVDS_CLK-	23	B_LVDS_3-
26	A_LVDS_CLK+	25	B_LVDS_3+
28	GND	27	GND
30	A_LVDS_3-	29	B_LVDS_CLK-
32	A_LVDS_3+	31	B_LVDS_CLK+
34	GND	33	GND
36	LVDS_DDCSCL	35	NC
38	LVDS_DDCSDA	37	NC
40	NC	39	NC

Note: Pin4 only need to be connected to GND

CN_INV: LVDS 5-pin Backlight power connector

Pin	Signal
1	12V
2	Backlight Control
3	GND
4	GND
5	Enable Backlight

JVLCD: LVDS panel power select jumper

Jumper settings	Function
1-2	3.3V (Default)
3-4	5V
5-6	12V

Effective patterns of connection: 1-2 / 3-4 / 5-6

Other may cause damage

2.4.5 <Serial Port interface>

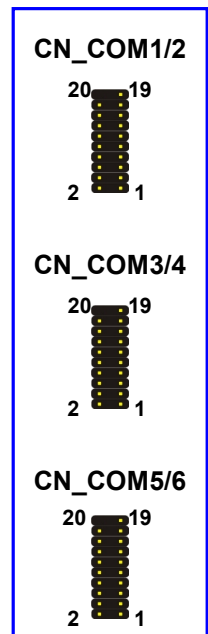
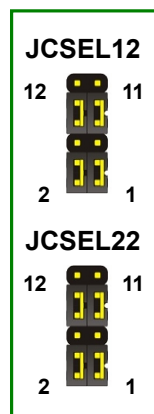
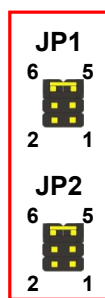
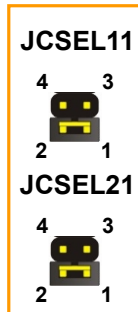
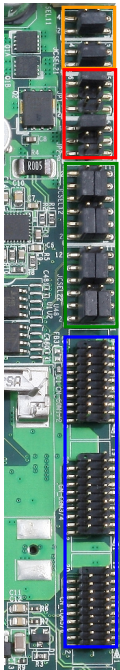

COM1/2: RS232/422/485 20-pin header (Pitch 1.27mm x 2.54mm)

Pin	Signal	Pin	Signal
1	DCD/ 422TX-/ 485-	2	RXD/ 422TX+/ 485+
3	TXD/ 422RX+	4	DTR/ 422RX-
5	GND	6	DSR
7	RTS	8	CTS
9	Set by JP2	10	N/C
11	DCD/ 422TX-/ 485-	12	RXD/ 422TX+/ 485+
13	TXD/ 422RX+	14	DTR/ 422RX-
15	GND	16	DSR
17	RTS	18	CTS
19	Set by JP1	20	N/C

Note: COM1 Use JCSEL12 select communication mode.

COM2 Use JCSEL 22 select communication mode.

COM3/4 ,5/6: RS232 20-pin header (Pitch 1.27mm x 2.54mm)

Pin	Signal	Pin	Signal
1	DCD1	2	RXD1
3	TXD1	4	DTR1
5	GND	6	DSR1
7	RTS1	8	CTS1
9	RI1	10	NC
11	DCD2	12	RXD2
13	TXD2	14	DTR2
15	GND	16	DSR2
17	RTS2	18	CTS2
19	RI2	20	Key







JP2, JP1: COM1, COM2 pin-9 setting

Jumper settings	Function
1-2	5V
3-4	12V
5-6	RI (Default)

Effective patterns of connection: 1-2 / 3-4 / 5-6

Other may cause damage

JCSEL12/22, JCSEL11/21: For configure COM1 &COM2 communication mode

Function	JCSEL12/ JCSEL22	JCSEL11/ JCSEL21
RS232 (Default)		
RS485		
RS422		

RS-485

Com1 RTX- Data- : short Pin1& Pin4

Com1 RTX+ Data+ : short Pin2& Pin3

Com2 RTX- Data- : short Pin1& Pin4

Com2 RTX+ Data+ : short Pin2& Pin3

Note1: Set up RS485 via bios to support auto flow, please refer [Appendix F](#).

Note2:The RS-422/485 can optionally isolate transceiver, default wasn't supported isolate

2.4.6 <USB interface>

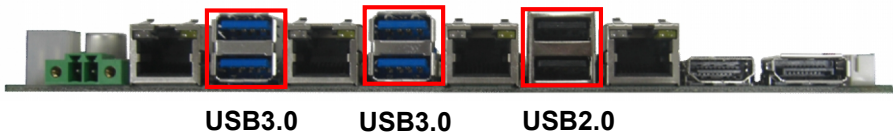
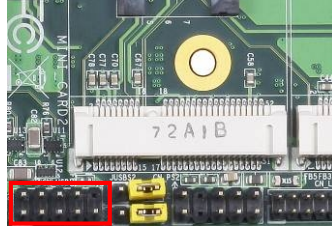
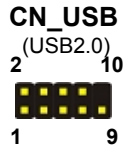

CN_USB: Front panel USB2.0 10-pin header (Pitch 2.54mm)

Pin	Signal	Pin	Signal
1	5VSB	2	5VSB
3	DATA0-	4	DATA1-
5	DATA0+	6	DATA1+
7	GND	8	GND
9	GND	10	Key

2.4.7 <Audio interface>

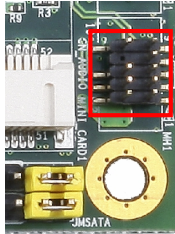

CN_AUDIO

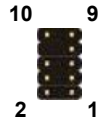

CN_AUDIO: Front panel audio 10-pin header (Pitch 2.54mm)

Pin	Signal	Pin	Signal
1	MIC_L	2	GND
3	MIC_R	4	NC
5	FP_OUT_R	6	MIC_DETECT
7	SENSE	8	Key
9	FP_OUT_L	10	FP_OUT_DETECT

2.4.8 <Expansion slot>

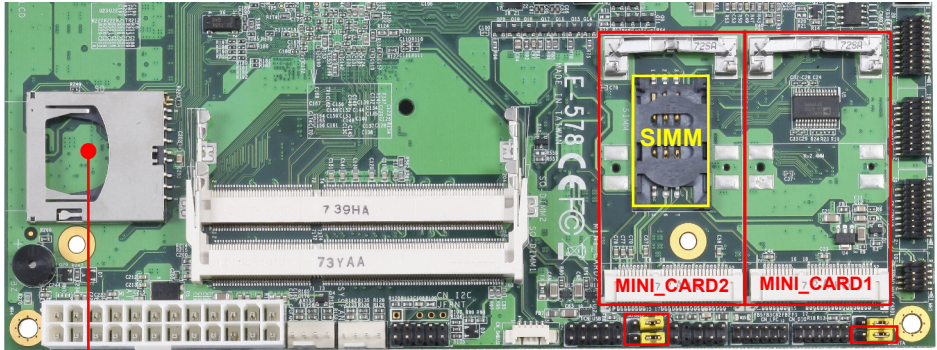

SD Slot

JUSBS2 

1 3

JUSBS1 

1 3

JMSATA 

1 3

SD Slot:

Pin	Signal	Pin	Signal
1	SD_D3	2	SD_CMD
3	3.3V	4	NC
5	SD_CLK	6	GND
7	SD_D0	8	SD_D1
9	SD_D2	10	SD_CD
11	GND	12	GND
13	SD_WP		

2.4.8.1 < MINI_CARD Setting >

MINI_CARD1 have special design to compatible our MiniPCIe card (ex: MPX-4232, MPX-7202) supports mSATA set by JMSATA.

MINI_CARD2 connect SIM card to use 3G module.

JMSATA: Setting MINI_CARD to support PCIe/mSATA

Jumper settings	Function
1-2	Support mSATA
2-3	Normal operation (Default)



JUSBS1/2: Setting MINI_CARD1/2 to support USB signal

Jumper settings	Function
1-2	MINI_CARD1/2 Support USB
2-3	CN_USB connector (Default)



2.4.8.2 < SIMM Setup>

This is for 3G miniPCIe card which doesn't have SIM slot.

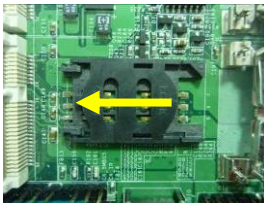

Slide the direction of the arrow open the cover.



Then press down and slide the direction of the arrow close the cover.

Insert the SIM card and make sure the direction is correct

2.4.9 <Front panel switch and indicator>

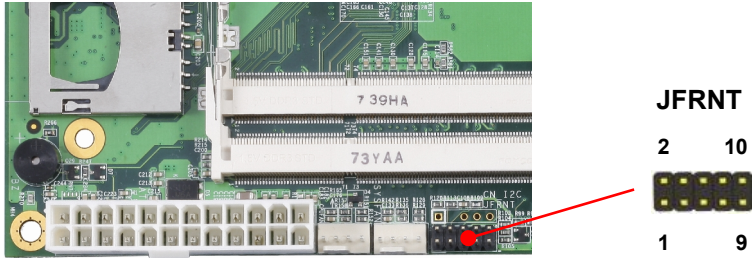

JFRNT: Front panel switch and indicator 14-pin header (Pitch 2.54mm)

Pin	Signal	Pin	Signal
1	Power_ON-	2	Power_ON+
3	Speaker-	4	Speaker+
5	HDD_LED-	6	HDD_LED+
7	Power_LED-	8	Power_LED+
9	Reset+	10	Reset-

2.4.10 <Other interface>

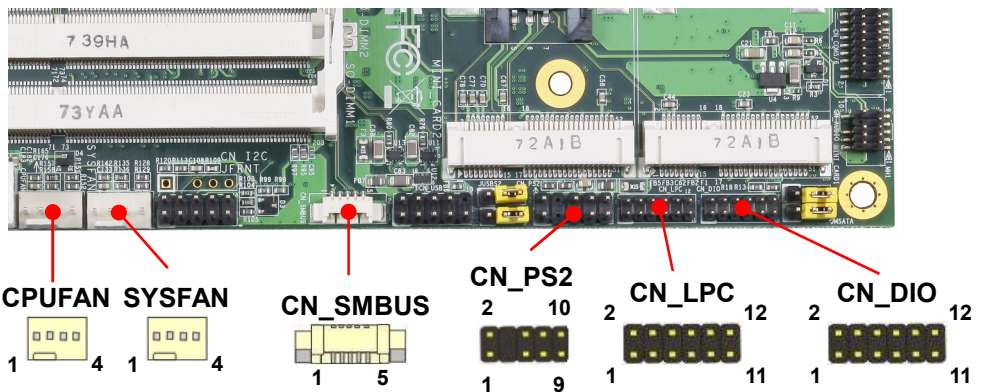

CN_DIO: GPIO 12-pin header (Pitch 2.00mm)

Pin	Signal	Pin	Signal
1	GND	2	GND
3	GPIO0	4	GPIO4
5	GPIO1	6	GPIO5
7	GPIO2	8	GPIO6
9	GPIO3	10	GPIO7
11	5V	12	12V

CN_LPC: LPC 12-pin header (Pitch 2.00mm)

Pin	Signal	Pin	Signal
1	CLK	2	RST
3	-LFRAME	4	LAD3
5	LAD2	6	LAD1
7	LAD0	8	3.3V
9	SERIRQ	10	GND
11	3.3VSB	12	NC

Note: Support TPM module.

CN_PS2: PS/2 10-pin header (Pitch 2.54mm)

Pin	Signal	Pin	Signal
1	KB_DATA	2	M_DATA
3	NC	4	NC
5	GND	6	GND
7	VCC	8	VCC
9	KB_CLK	10	M_CLK

CN_SMBUS: SMBus 5-pin connector

Pin	Signal
1	5V
2	NC
3	SMBDAT
4	SMBCLK
5	GND

CPUFAN & SYSFAN: cooler fan 4-pin connector

Pin	1	2	3	4
Signal	GND	12V	Sensor	Control

2.5 <Power supply>

2.5.1 <Power input>

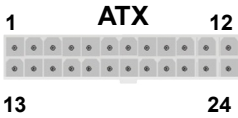
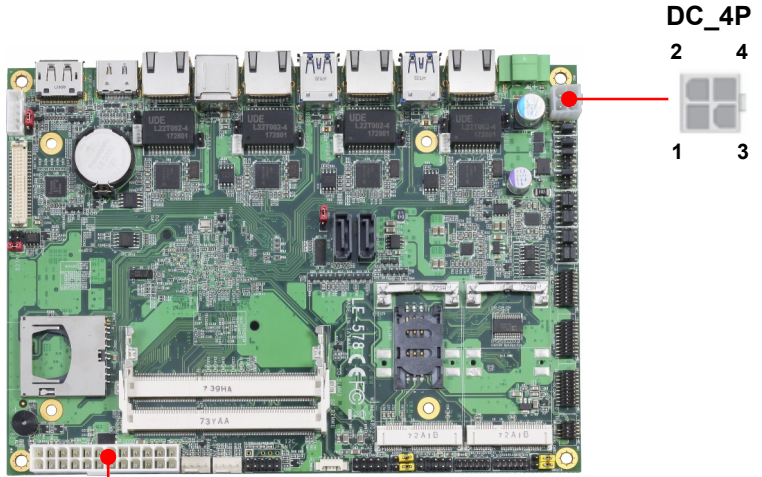

The DC_4P and DC_2P are CO-LAY design, support 6 ~ 35V wide voltage input.

Note that the DC_4P and ATX do not use at the same time, it will certainly cause damage.

DC_4P: ATX12V 4-pin connector

Pin	Signal	Pin	Signal
1	GND	2	GND
3	6~35V	4	6~35V

Note that the DC_2P and ATX do not use at the same time, it will certainly cause damage.

DC_2P: 2-pin Terminal Block connector

Pin	Signal	Pin	Signal
1	6~35V	3	GND

ATX: main power 24-pin connector (As input)

Pin	Signal	Pin	Signal
1	3.3V	13	3.3V
2	3.3V	14	NC
3	GND	15	GND
4	5V	16	-PSON
5	GND	17	GND
6	5V	18	GND
7	GND	19	GND
8	Power_OK	20	NC
9	5VSB	21	5V
10	12V	22	5V
11	12V	23	5V
12	3.3V	24	GND

2.5.2 <Power output>

It is supply to the HDD, CD-ROM or other device.

If using DC_4P or DC_2P as input, that ATX will be the output.

ATX: main power 24-pin connector (As output)

Pin	Signal	Pin	Signal
1	N/C	13	N/C
2	N/C	14	N/C
3	GND	15	GND
4	5V	16	PSON
5	GND	17	GND
6	5V	18	GND
7	GND	19	GND
8	POK	20	N/C
9	5VSB	21	5V
10	12V	22	5V
11	12V	23	5V
12	N/C	24	GND

Note that Maximum output power: 12V/2A, 5V/3A, 3.3V/3A

Appendix A <Flash BIOS>

A.1 <Flash tool>

The board is based on Insyde BIOS and can be updated easily by the BIOS auto flash tool. You can download the tool online at the address below:

[LE-578 reflash tool](#)

A.2 <Flash BIOS process>

1. Please make a bootable UFD which can boot into DOS environment.
2. Unzip the flash tool and copy it into bootable UFD.
3. Add a bin file to the same folder..
4. Power on the system and flash the BIOS under the DOS environment.

(Command: H2OFFT xxxxx.bin -all)

5. Power off the system and then power on.

Appendix B <LCD Panel Type select>

According to your panel, it is necessary to select the correct resolution in the BIOS. If there is no fit for your panel type, please provide feedback for us to make an OEM model.

Find the setting from

Front page-----> Setup Utility

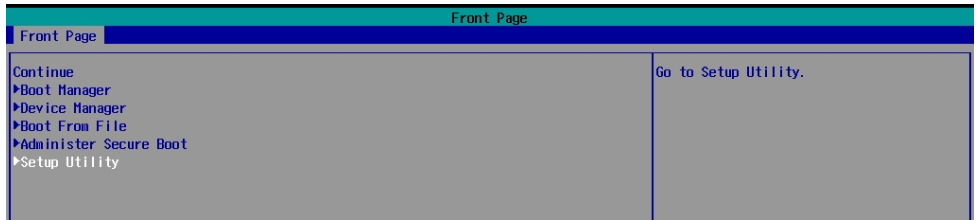

Advanced-----> Uncore Configuration----->VBT Hook Configuration

You can change 18bit /24bit, Single /Dual channel in PTN3460 configuration

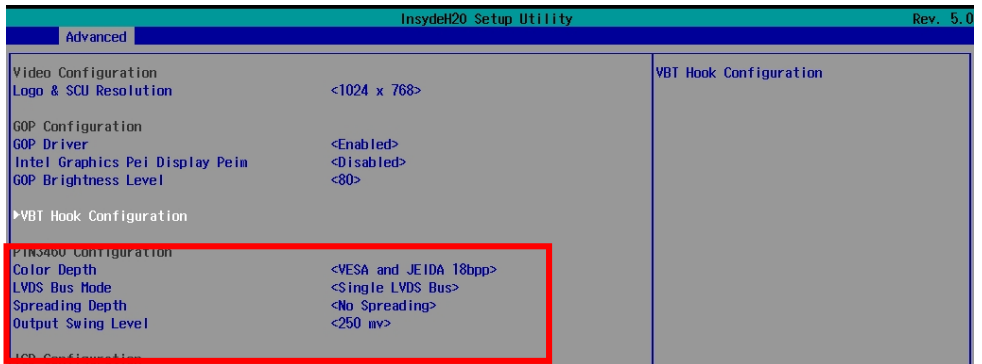

There are 16 resolutions in Panel Number.

InsydeH20 Setup Utility Rev. 5.0

Advanced

VBT Hook Configuration

LFP 1 Configuration <eDP>

 Output Port <eDP Port A>

 Aux Channel <DP Port A>

 Panel Number <640 x 480>

 EDID Support <Disabled>

 HPD Inversion <Enabled>

 DDI Lane Reversal <Disabled>

EFP 1 Configuration <HDMI/DVI>

 Output Port <HDMI Port B>

 DDC Bus Pin <Disabled>

 Aux Channel <DP Port B>

 HDMI Level Shifter <400 mV 0.0dB>

 Onboard LSPCON for HDMI 2.0 <Disabled>

 HPD Inversion <Enabled>

 DDI Lane Reversal <Disabled>

 USB TypeC Dongle <Disabled>

 Dockable Port <Disabled>

EFP 2 Configuration <DisplayPort>

 Output Port <DP Port C>

 DDC Bus Pin <HDMI Port C>

 Aux Channel <DP Port C>

 HDMI Level Shifter <800 mV 3.5dB>

 Onboard LSPCON for HDMI 2.0 <Disabled>

 HPD Inversion <Enabled>

 DDI Lane Reversal <Disabled>

 USB TypeC Dongle <Enabled>

 Dockable Port <Disabled>

EFP 3 Configuration <No Device>

Select LFP panel number (Panel Type define in VBT table)

Panel Number	VBT Default
640 x 480	640 x 480
800 x 600	800 x 600
1024 x 768	1024 x 768
1280 x 1024	1280 x 1024
1400 x 1050	1400 x 1050
1400 x 1050	1400 x 1050
1600 x 1200	1600 x 1200
1366 x 768	1366 x 768
1680 x 1050	1680 x 1050
1920 x 1200	1920 x 1200
1440 x 900	1440 x 900
1600 x 900	1600 x 900
1024 x 768	1024 x 768
1280 x 800	1280 x 800
1920 x 1080	1920 x 1080
OEM Keep	OEM Keep

F1 Help ↑/↓ Select Item F5/F6 Change Values F9 Setup Defaults
 Esc Exit ←/→ Select Item Enter Select ▸ Submenu F10 Save and Exit

BIOS panel type selection form (BIOS Version:1.0)			
Single / Dual channel		Single / Dual channel	
NO.	Type	NO.	Type
1	640 x 480	9	1680 x 1050
2	800 x 600	10	1920 x 1200
3	1024 x 768	11	1440 x 900
4	1280 x 1024	12	1600 x 900
5	1400 x 1050 Reduced Blanking	13	1024 x 768
6	1400 x 1050 non-Reduced Blanking	14	1280 x 800
7	1600 x 1200	15	1920 x 1080
8	1366 x 768	16	OEM Keep

Appendix C <Programmable Watch Dog Timer>

Timeout value range

1 to 255 Minute and Second

Program sample

Watchdog timer setup as system reset with 5 second of timeout

```
-o 4E 87      ;enter configuration
-o 4E 87
-o 4E 07
-o 4F 08      ;select Logical Device
-o 4E 30
-o 4F 01      ; activate WDTO# function
-o 4E F0
-o 4F 00      ;set "00" is second mode, set "04" is minute mode
-o 4E F1
-o 4F 05      ;00h: Timeout Disable
                ;01h: Timeout occurs after 1 minute only
                ;02h: Timeout occurs after 2 second/minute
                ;03h: Timeout occurs after 3 second/minute
                ;
                ;
                ;FFh: Timeout occurs after 255 second/minute
                (The deviation is approx 1 second.)
```

For further information, please refer to Nuvoton NCT6106D datasheet

Appendix D <Programmable GPIO >

The GPIO' can be programmed with the MS-DOS debug program using simple IN/OUT commands.

GPIO	0	1	2	3	4	5	6	7
bit	0	1	2	3	4	5	6	7

- o 4E 87 ;enter configuration
- o 4E 87
- o 4E 07
- o 4F 07 ;select Logical Device
- o 4E 30
- o 4F 10 ;activate GPIO function (The board use GPIO4)
- o 4E F0
- o 4F XX ;set "01" GPIO as input, set "00" GPIO as output
- o 4E F1
- o 4F XX ;if set GPIO as output, this register's value can be set "00~ FF"

Optional

- o 4E F2
- o 4F XX ;set "01", the respective bit are inverted (Both input and output)
- ;set "00", the respective bit are normal

For further information, please refer to Nuvoton NCT6106D datasheet

Appendix E <SuperIO Setting>

Press **Delete** to enter BIOS Setup menu

On **Front Page** screen, click **Setup Utility**

On **Advanced** screen, click **SIO NUVOTON6106D**

There are 5 functions in the page.

- 1.WDT(Watch Dog Timer)
- 2.Power Loss setting
- 3.Hardware monitor
- 4.Smart fan
- 5.OVT (Over temperature)

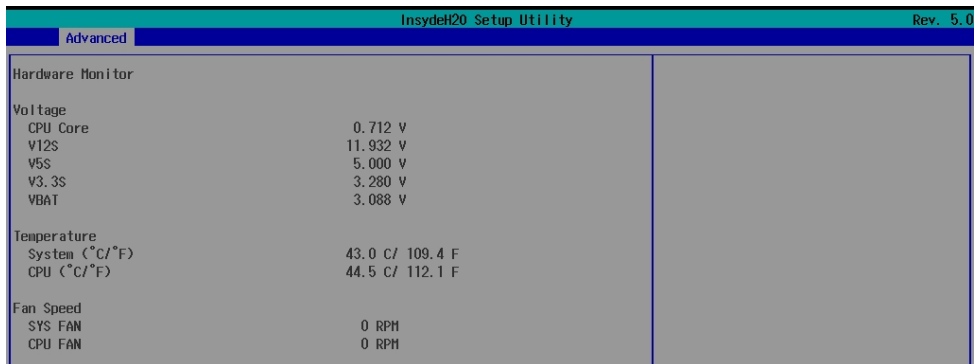

Appendix F <RS485 auto flow Setting>

Press **Delete** to enter BIOS Setup menu

On **Front Page** screen, click **Setup Utility**

On **Advanced** screen, click **SIO NUVOTON6106D**

You can change RS232 /RS485 in Serial Port1/2 configuration



Appendix G <Setup PoE device>

LE-578 have two ways to support PoE function.

1. LE-578 work with [DC-DC5](#) and [ADP-PSE4](#)

Power Supply

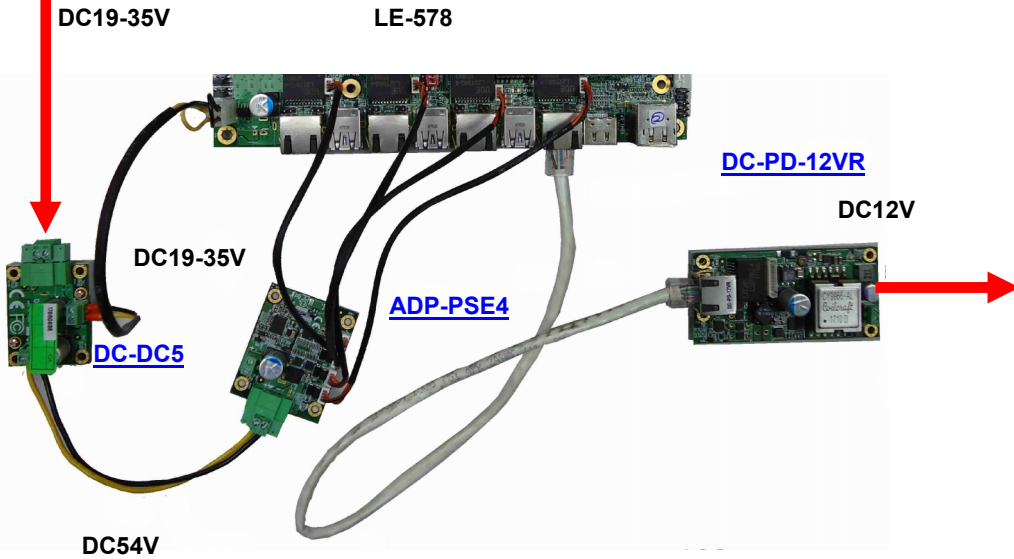

2. LE-578 work with [ADP-PSE4](#) and [DC-PD-12VT](#)

LE-578

[DC-PD-12VT](#)

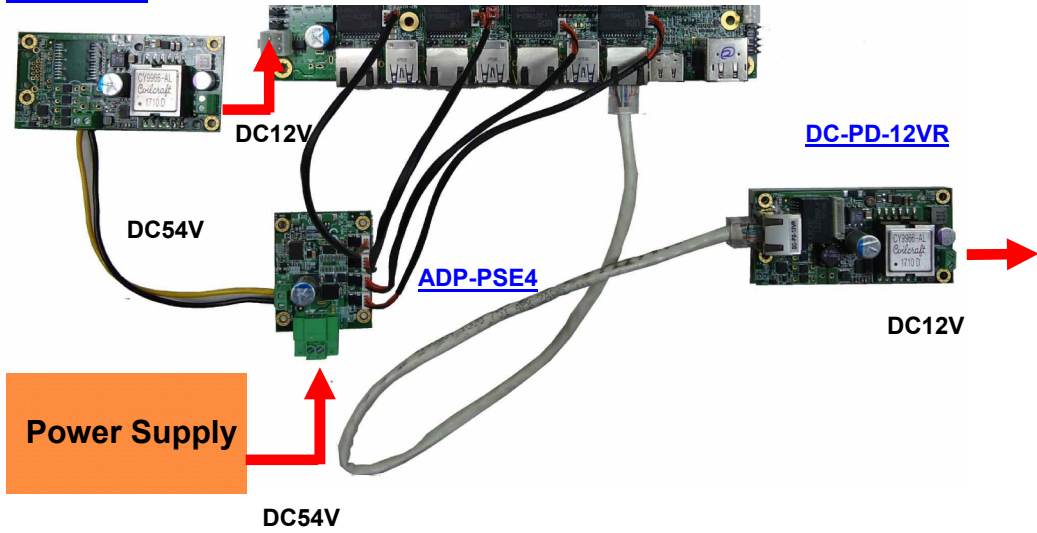

Contact information

Any advice or comment about our products and service, or anything we can help you please don't hesitate to contact with us. We will do our best to support you for your products, projects and business.

Taiwan Commate computer Inc.

Address	19F., NO.94, Sec. 1, Xintai 5 th Rd., Xizhi Dist., New Taipei City 22102, Taiwan.
TEL	+886-2-26963909
FAX	+886-2-26963911
Website	www.commell.com.tw
E-mail	info@commell.com.tw (General information) tech@commell.com.tw (Technical Support)

Commell is a brand name of Taiwan Commate computer Inc.