

LE-375

3.5 inch Miniboard

User's Manual

Edition 1.4
2015/06/16



Copyright

Copyright 2009. All rights reserved. This document is copyrighted and all rights are reserved. The information in this document is subject to change without prior notice to make improvements to the products.

This document contains proprietary information and protected by copyright. No part of this document may be reproduced, copied, or translated in any form or any means without prior written permission of the manufacturer.

All trademarks and/or registered trademarks contains in this document are property of their respective owners.

Disclaimer

The company shall not be liable for any incidental or consequential damages resulting from the performance or use of this product.

The company does not issue a warranty of any kind, express or implied, including without limitation implied warranties of merchantability or fitness for a particular purpose.

The company has the right to revise the manual or include changes in the specifications of the product described within it at any time without notice and without obligation to notify any person of such revision or changes.

Trademark

All trademarks are the property of their respective holders.

Any questions please visit our website at <http://www.commell.com.tw>

Packing List:

Please check the package content before you starting using the board.

Hardware:

LE-375 3.5" Miniboard x 1

Cable Kit:

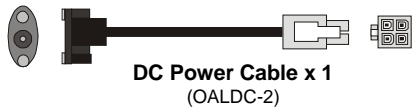

DC Power Cable x 1
(OALDC-2)

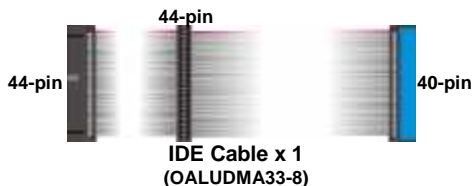

IDE Cable x 1
(OALUDMA33-8)



1 to 3 power output cable
(OAL4P-2)

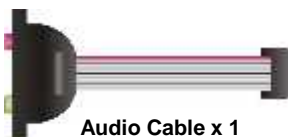

Audio Cable x 1
(OALPJ-HDUNB)

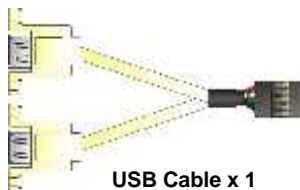

USB Cable x 1
(OALUSBA-3)



COM port Cable x 1
(OALES-BKU1NB)

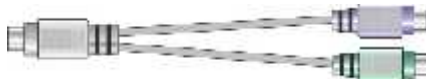

PS/2 keyboard & mouse cable x 1
(OALPS2/MK)

Printed Matters:

Driver CD x 1 (Including User's Manual)

Index

Chapter 1 <Introduction>	5
1.1 <Product Overview>.....	5
1.2 <Product Specification>	7
1.3 <Mechanical Drawing>	10
1.4 <Block Diagram>	11
Chapter 2 <Hardware Setup>	12
2.1 <Connector Location>	12
2.2 <Jumper Reference>.....	14
2.3 <Connector Reference>	15
2.3.1 <Internal Connector>	15
2.3.2 <External Connector>	15
2.4 <CPU and Memory Setup>	16
2.5 <ATX Setup>	17
2.6 <Enhanced IDE & CF Interface>	18
2.7 <SDIO Interface>	19
2.8 <LAN Interface>	19
2.9 <Onboard Display Interface>	20
2.9.1 <Analog VGA Interface> (LE-375QT/RT/PT only).....	20
2.9.2 <Digital Display>.....	21
The LE-375X series supports dual channel 24bit LVDS, if need support other resolution flat panel, please contact Commell tech support team for customize BIOS and driver.	24
2.9.3 <DVI Interface >(LE-375QD/RD/PD only).....	25
2.10 <Onboard Audio Interface>.....	26
2.11 <USB2.0 Interface>.....	27
2.12 <GPIO Interface>	28
2.13 <Serial Port Jumper Setting >.....	29
2.14 <Power & FAN Connector >	30
2.14.1 <Power Input>.....	30

2.14.2 <Power Output>.....	31
2.14.3 <Fan Connector>	31
2.15 <Indicator and Switch>	32
Chapter 3 <BIOS Setup>	34
Appendix A <I/O Port Pin Assignment>	35
A.1 <IDE Port>	35
A.2 <IrDA Port>.....	35
A.3 <SMBUS Port>	36
A.4 <LPC Port>.....	36
A.5 < CRT Port >	36
A.6 <Serial Port>.....	37
A.7 <LAN Port>.....	37
Appendix B <Flash BIOS>.....	38
B.1 BIOS Auto Flash Tool.....	38
B.2 Flash Method	38
Appendix C <System Resources>	39
C.1 <I/O Port Address Map>.....	39
C.2 <Memory Address Map >	41
C.3 < System IRQ Resources >	42
Appendix D <Programming GPIO's>	43
Appendix E <Watch Dog timer Setting >	44
Contact Information	45

Chapter 1 <Introduction>

1.1 <Product Overview>

LE-375 is the 3.5 inch miniboard, with Intel® Atom Z510P/Z510PT/Z520PT processor for 400/533 MHz front side bus, Intel® US15WP/US15WPT SCH, integrated GMA500 graphics, DDR2 SO-DIMM memory, Realtek HD Audio, CF, SD and one Intel® 82574L/82574IT Gigabit LAN.

Intel® Atom Processor

The Intel® Atom Z510P/Z510PT single core processor is with 400 MHz front side bus, 512KB L2 cache. It's built on 45nm process technology support Hyper-Threading Technology, Enhanced Intel® SpeedStep® Technology reduces average system power consumption.

The Intel® Atom Z520PT single core processor is with 533 MHz front side bus, and The Intel® Atom Z510PT/Z520PT processor with Industrial Temperature (IT) support covering a wider range of temperature conditions (-40° to +85°C).

Embedded Intel® SCH

The board integrates Intel® US15WP/US15WPT SCH. The chipset features power-efficient graphics with an integrated 32-bit 3D graphics engine based on Intel® Graphics Media Accelerator 500 architecture with DVI, LVDS, CRT display ports. It provides I/O capabilities and flexibility via high-bandwidth interfaces such as PCIE and Hi-Speed USB 2.0 connectivity. It also includes a single channel for 400/533 MHz DDR2 system memory (SODIMM), HD Audio.

Based on Intel® US15WP/US15WPT SCH, the board provides high performance onboard graphics, Hardware acceleration of H.264, MPEG2, MPEG4, VC1 and WMV, 18/24-bit LVDS interface and HD Audio to meet the every requirement of the multimedia application.

Flexible Extension Interface

The board also provides Compact Flash Type II socket and one PCIE mini card socket.

1.2 <Product Specification>

General Specification

Form Factor	3.5 inch miniboard
CPU	Intel® Atom™ Z510P/Z510PT processor 1.1GHz Intel® Atom™ Z520PT processor 1.33GHz Package type: 437pin FCBGA8 with an IHS, Front side bus: 400/533MHz
Memory	1 x 200-pin DDR2 SO-DIMM SDRAM up to 2GB Unbuffered, none-ECC memory supported only *Memory chip with width x16 bits is strongly recommended!
Chipset	Intel® SCH US15WP/US15WPT
BIOS	Phoenix-Award v6.00PG 8Mb SPI flash BIOS
Green Function	Power saving mode includes doze, standby and suspend modes. ACPI version 1.0 and APM version 1.2 compliant
Watchdog Timer	System reset programmable watchdog timer with 1 ~ 255 sec./min. of timeout value
Real Time Clock	Intel® SCH built-in RTC with lithium battery
Enhanced IDE	UltraDMA33 IDE interface supports up to 2 ATAPI devices One 44-pin IDE port onboard One CompactFlash Type II socket on solder side
SDIO	Intel® SCH integrates SDIO revision 1.1 controller One SD socket onboard

Multi-I/O Port

Chipset	Intel® SCH with Winbond® W83627DHG controller
Serial Port	One RS-232/422/485 serial port and one RS-232
USB Port	Two external & four internal Hi-Speed USB 2.0 ports with 480Mbps of transfer rate
IrDA Port	One IrDA compliant Infrared interface supports SIR
K/B & Mouse	PS/2 keyboard and mouse port
GPIO	One 12-pin Digital I/O connector with 8-bit programmable I/O interface

VGA Display Interface

Chipset	Intel® US15WP/US15WPT SCH (System Controller Hub)
Frame Buffer	Up to 256MB shared with system memory
Display Type	CRT, LCD monitor with analog display (LE-375QT, LE-375RT, LE-375PT only), DVI(LE-375QD, LE-375RD, LE-375PD only), Dual channel LVDS (LE-375QX, LE-375RX, LE-375PX only)
Connector	External DB15 female connector (LE-375QT, LE-375RT, LE-375PT only) External DVI connector (LE-375QD, LE-375RD, LE-375PD only) Onboard 40-Pin LVDS and 5-Pin inverter connector

Ethernet Interface

Controller	1 x Intel® 82574L/82574IT Gigabit Ethernet controller
Type	Triple speed 10/100/1000Base-T auto-switching Fast Ethernet Full duplex, IEEE802.3U compliant
Connector	One External RJ45 connector with LED

Audio Interface

Chipset	REALTEK ALC888
Interface	Stereo audio Line-out and MIC-in
Connector	Onboard audio connector with pin header Onboard CD-IN connector

Expansive Interface

PCIE mini card	1 x PCIE mini card socket
----------------	---------------------------

Power and Environment

Power Requirement	DC 9~24V input with onboard 4-pin connector
Dimension	146 (L) x 101(H) mm
Temperature	Operating within 0 ~ 60°C Storage within -20 ~ 85°C
Wide-Temperature	Operating within -40 ~ 85°C Storage within -40 ~ 85°C

Ordering Code

LE-375QT	Support Intel® Atom Z510P processor with onboard VGA , LVDS, Audio, Giga LAN, USB2.0, CF, SD, GPIO, PCIE mini card
LE-375QD	Same as LE-375QT but without VGA, support DVI
LE-375QX	Same as LE-375QT but without VGA, support 24bit dual channel LVDS
LE-375RT	Support Intel® Atom Z510PT processor with onboard VGA , LVDS, Audio, Giga LAN, USB2.0, CF, SD, GPIO, PCIE mini card, Wide-Temperature Range .
LE-375RD	Same as LE-375RT but without VGA, support DVI .
LE-375RX	Same as LE-375RT but without VGA, support 24bit dual channel LVDS 1280 x 1024 resolution .
LE-375PT	Support Intel® Atom Z520PT processor with onboard VGA , LVDS, Audio, Giga LAN, USB2.0, CF, SD, GPIO, PCIE mini card, Wide-Temperature Range .
LE-375PD	Same as LE-375PT but without VGA, support DVI
LE-375PX	Same as LE-375PT but without VGA, support 24bit dual channel LVDS 1280 x 1024 resolution .

The specifications may be different as the actual production.

For further product information please visit the website at <http://www.comnell.com.tw>

1.3 <Mechanical Drawing>

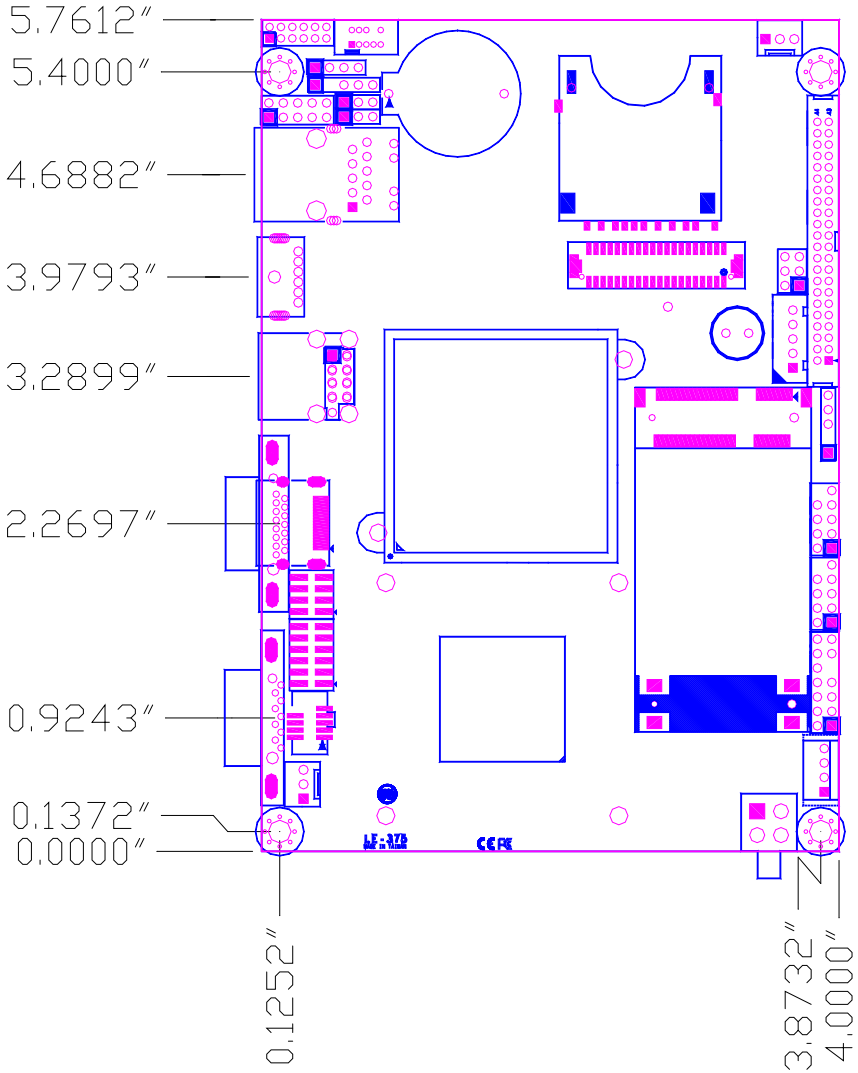

Unit: inch

1.4 <Block Diagram>

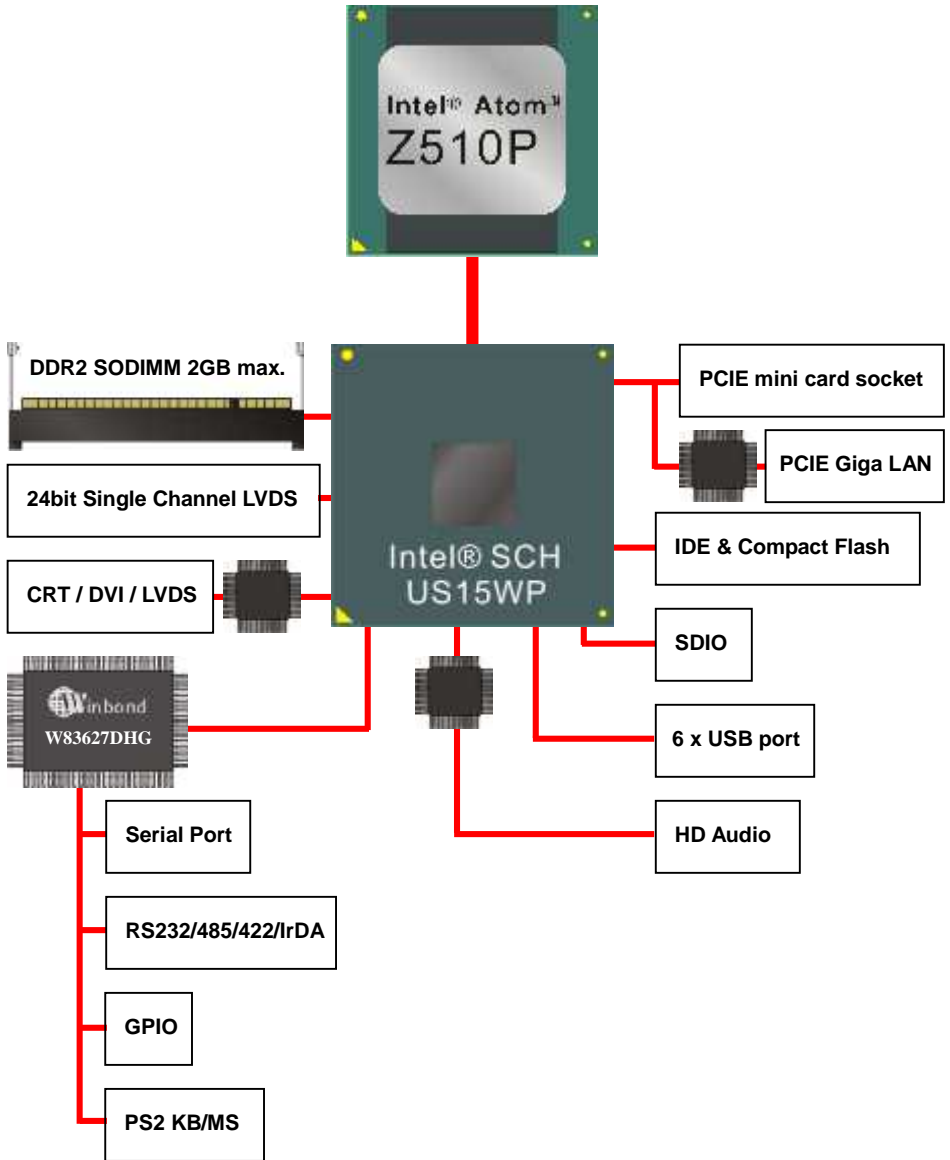

Chapter 2 <Hardware Setup>

2.1 <Connector Location>

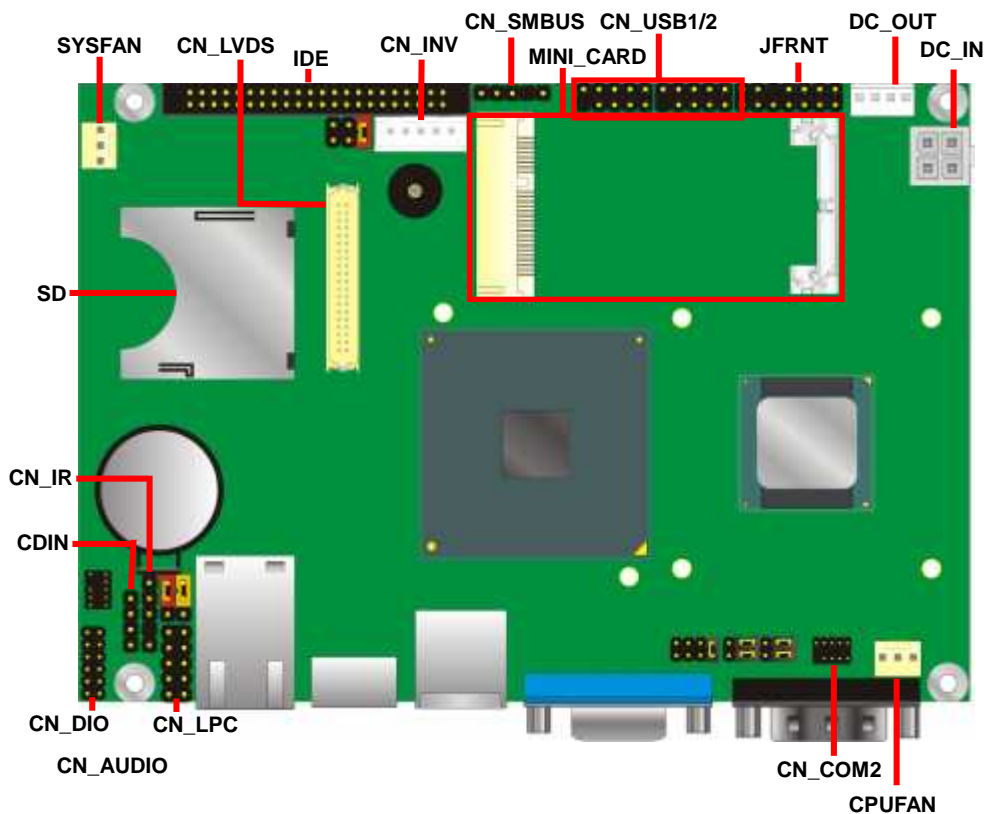

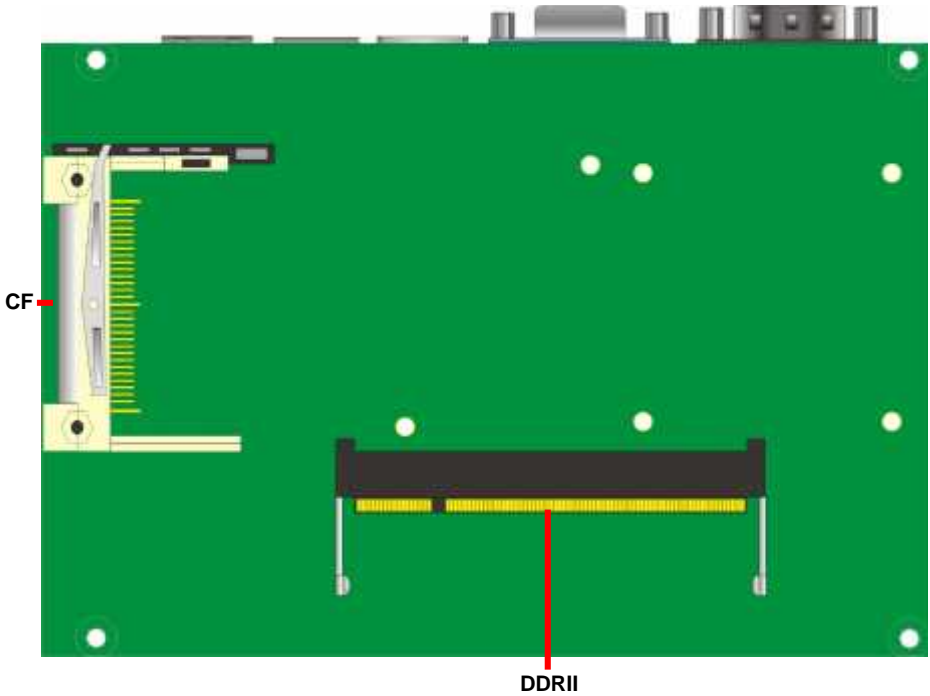

LE-375QT/RT/PT

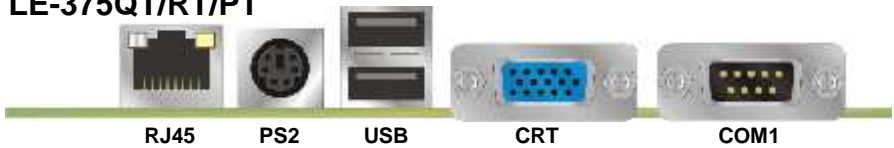

LE-375QD/RD/PD



LE-375QX/RX/PX



2.2 <Jumper Reference>

Jumper	Function
JVLCD	LCD Panel Voltage Setting
JAT	AT/ATX Mode Setting
JCSEL1/2	COM2 RS232/422/485/IrDA Mode Setting

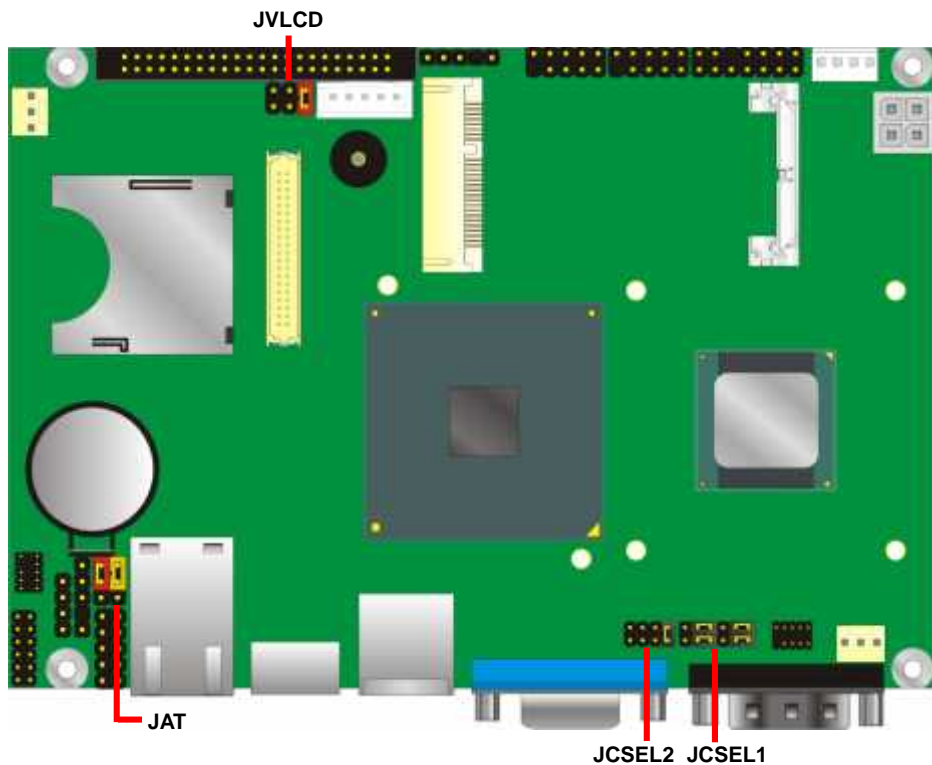

2.3 <Connector Reference>

2.3.1 <Internal Connector>

Connector	Function	Remark
DDRII	200 -pin DDR2 SO-DIMM SDRAM slot	Standard
IDE	44-pin primary IDE connector	Slim
CF	Compact Flash Type II socket	Standard
MINI_CARD	PCIE mini card socket	Standard
CN_LVDS	20 x 2-pin LVDS connector	Standard
CN_INV	5-pin LCD inverter connector	Standard
CN_USB1/2	5 x 2-pin USB connector	Standard
CN_AUDIO	5 x 2-pin audio connector	Slim
CDIN	4-pin CD-ROM audio input connector	Standard
CN_COM2	5 x 2-pin com connector	Slim
CN_IR	5-pin IrDA connector	Standard
CN_DIO	6 x 2-pin digital I/O connector	Standard
JFRNT	14-pin switch/indicator connector	Standard
CPUFAN	3-pin CPU cooler fan connector	Standard
SYSFAN	3-pin system cooler fan connector	Standard
DC_OUT	4-pin power output connector	Standard
DC_IN	DC input connector	Standard

2.3.2 <External Connector>

Connector	Function	Remark
COM1	DB9 Serial port connector	Standard
CRT	DB15 VGA connector	Standard
DVI	Type A DVI connector	Standard
USB	Dual USB 2.0 connector	Standard
PS2	PS/2 keyboard and mouse connector	Standard
RJ45	RJ45 LAN connector	Standard

2.4 <CPU and Memory Setup>

The board provides one 200-pin DDR2 SO-DIMM to support DDR2 400/533 memory modules up to 2GB of capacity. Non-ECC, unbuffered memory is supported only.

***Memory chip with width x16 bits is strongly recommended!**

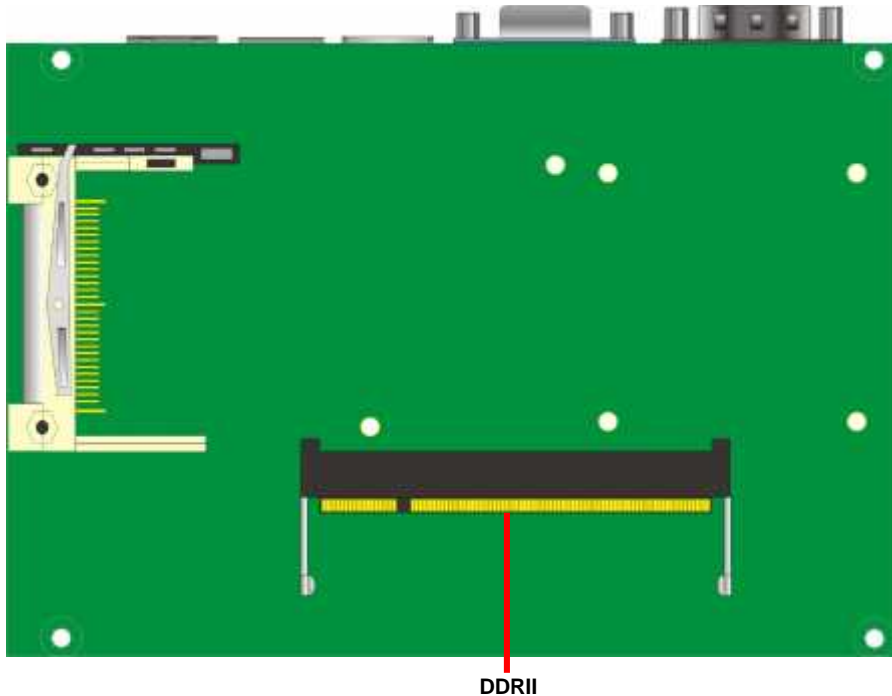

2.5 <ATX Setup>

The board has a jumper to switch AT power mode (automatic power on) or standard ATX mode (manual power on).

Jumper: **JAT**

Type: onboard 3-pin jumper

JAT	Mode
1-2	AT Mode
2-3	ATX Mode

Default setting

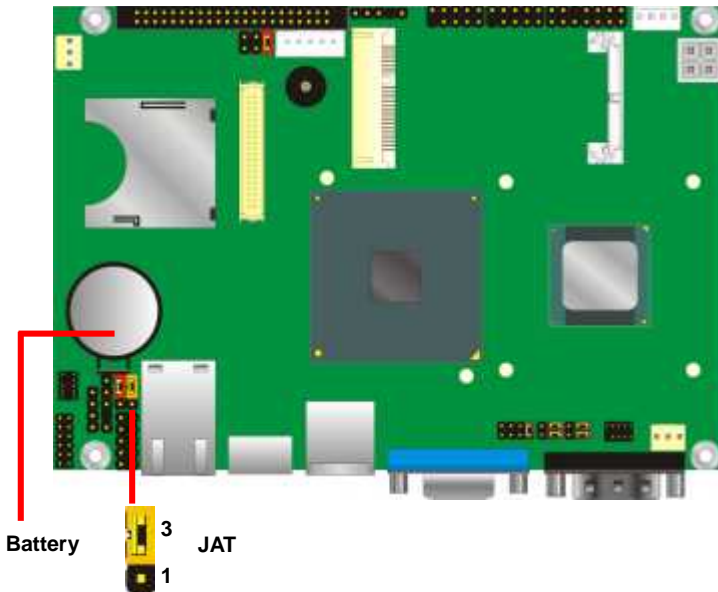

2.6 <Enhanced IDE & CF Interface>

The board has one Ultra DMA33 IDE interface to support up to 2 ATAPI devices and one Compact Flash Type II socket on the solder side.

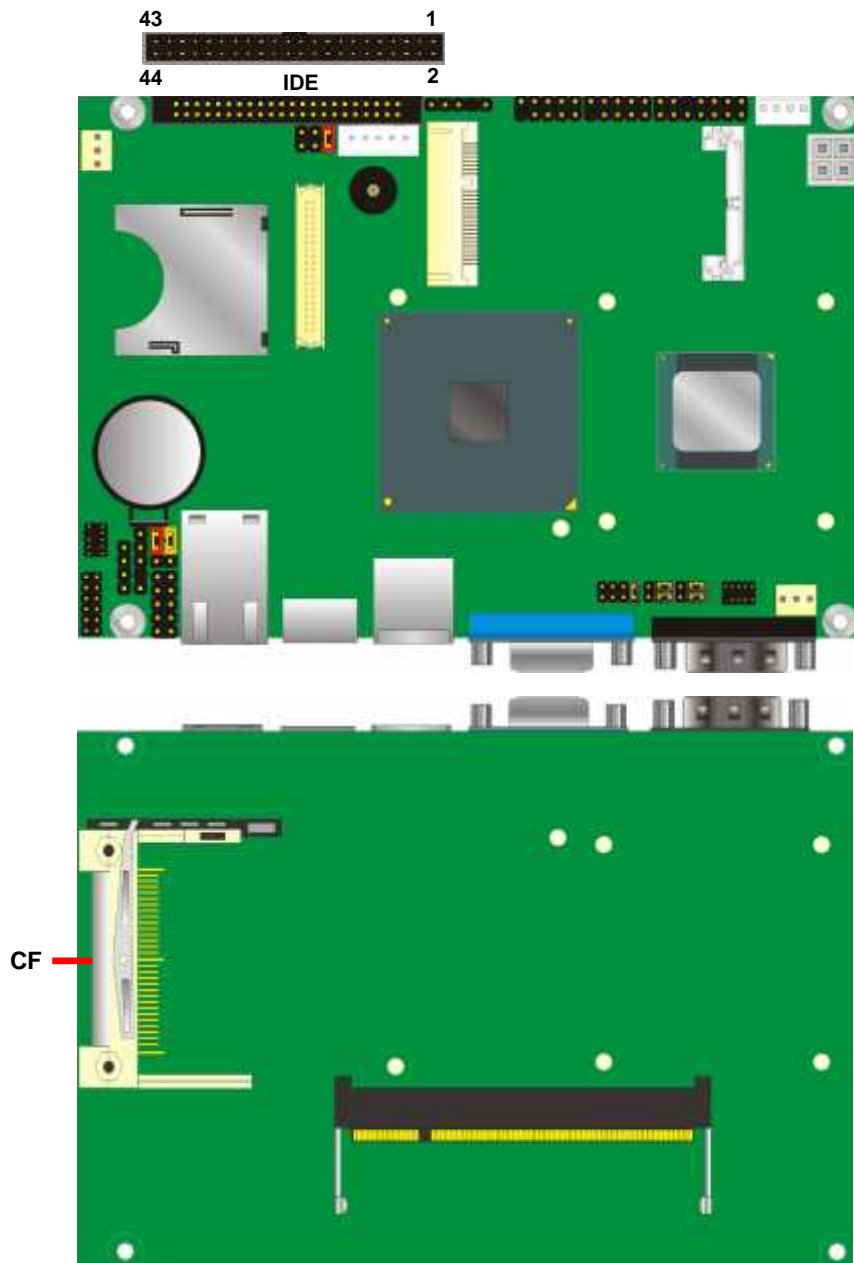

2.7 <SDIO Interface>

Based on Intel® SCH, the board provides One SDIO interfaces with SD slot.

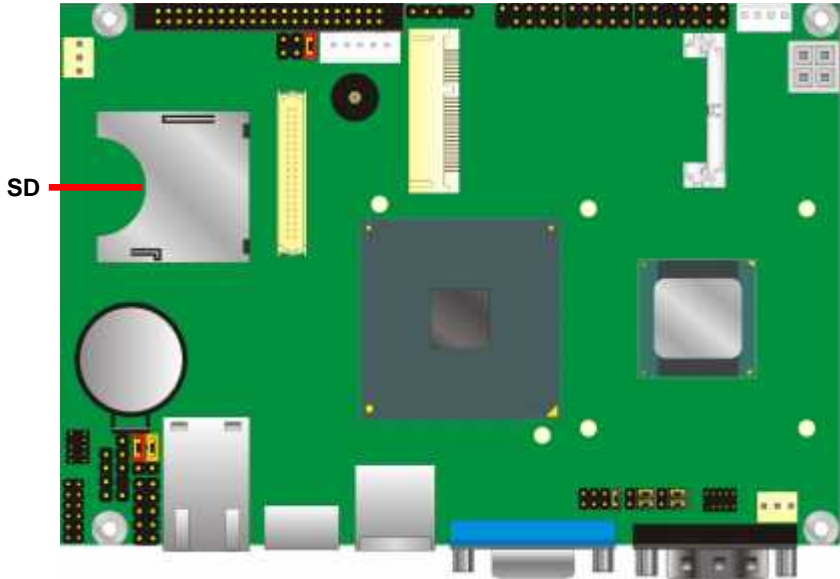

2.8 <LAN Interface>

The Intel® 82574L supports triple speed of 10/100/1000Base-T, with IEEE802.3 compliance and Wake-On-LAN supported.



2.9 <Onboard Display Interface>

Based on Intel® SCH chipset with built-in GMA (Graphic Media Accelerator) 500 graphics, the board provides one DB15 or DVI connector on rear external I/O port, and one 40-pin LVDS interface with 5-pin LCD backlight inverter connector. The board provides dual display function with clone mode and extended desktop mode for CRT, DVI and LVDS.

2.9.1 <Analog VGA Interface> (LE-375QT/RT/PT only)

Please connect your CRT or LCD monitor with DB15 male connector to the onboard DB15 female connector on rear I/O port.

The board supports up to 1920 x 1080 (WUXGA) of resolution.

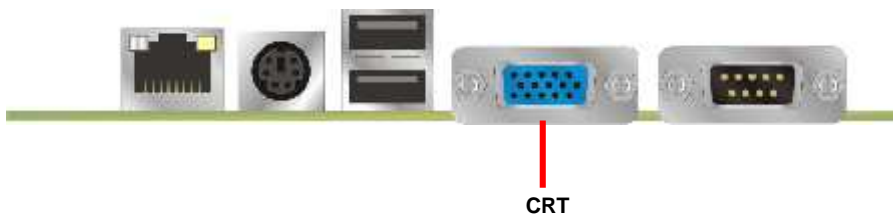

2.9.2 <Digital Display>

The board provides one 40-pin LVDS connector for 18 or 24 bit dual channel panels, supports up to 1920 x 1080 (WUXGA) of resolution, with one LCD backlight inverter connector and one jumper for panel voltage setting

Note: LE-375QT/RT/PT or QD/RD/PD supports single channel
LE-375QX/RX/TX supports dual channel

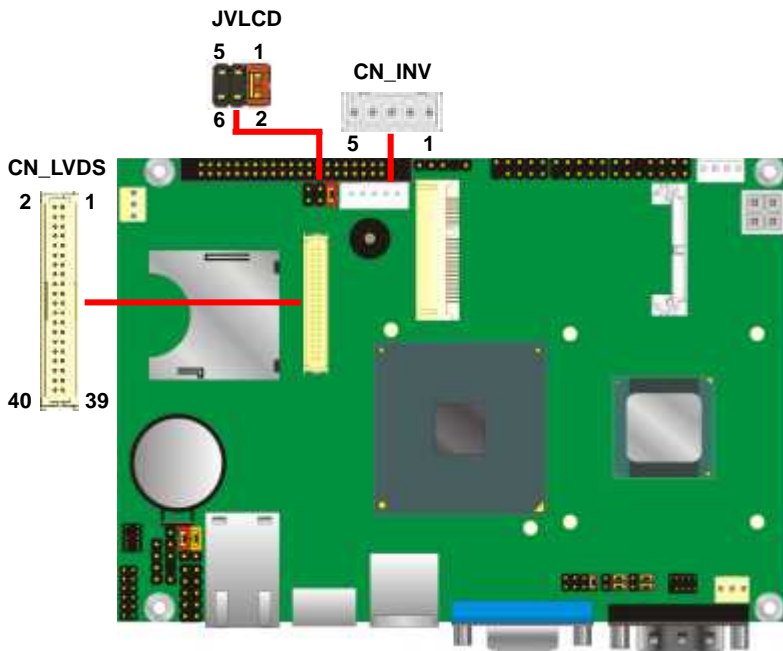

Connector: **CN_INV**

Type: 5-pin Inverter power connector

Connector model: **JST B5B-XH-A**

Pin	Description
1	+12V
2	GND
3	GND
4	GND
5	ENABKL

Jumper: **JVLCD**

Type: 3-pin Power select jumper

Pin	Description
1-2	+3.3V
3-4	+5V
5-6	+12V
Default: 1-2	

Connector: **CN_LVDS**

Type: onboard 40-pin connector for LVDS connector

Connector model: **HIROSE DF13-40DP-1.25V**

Pin	Signal	Pin	Signal
2	LCDVCC	1	LCDVCC
4	GND	3	GND
6	ATX0-	5	BTX0-(LE-375X)
8	ATX0+	7	BTX0+(LE-375X)
10	GND	9	GND
12	ATX1-	11	BTX1-(LE-375X)
14	ATX1+	13	BTX1+(LE-375X)
16	GND	15	GND
18	ATX2-	17	BTX2-(LE-375X)
20	ATX2+	19	BTX2+(LE-375X)
22	GND	21	GND
24	ACLK-	23	BTX3-(LE-375X)
26	ACLK+	25	BTX3+(LE-375X)
28	GND	27	GND
30	ATX3-	29	BCLK-(LE-375X)
32	ATX3+	31	BCLK+(LE-375X)
34	GND	33	GND
36	N/C	35	N/C
38	N/C	37	N/C
40	N/C	39	N/C

LE-375 User's Manual

To setup the LCD, you need the component below:

1. A panel with LVDS interfaces.
2. An inverter for panel's backlight power.
3. A LCD cable and an inverter cable.

For the cables, please follow the pin assignment of the connector to make a cable, because every panel has its own pin assignment, so we do not provide a standard cable; please find a local cable manufacture to make cables.

LCD Installation Guide:

1. Preparing the LE-375, LCD panel and the backlight inverter

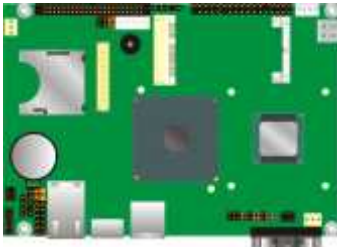

2. Please check the datasheet of the panel to see the voltage of the panel, and set the jumper **JVLCD** to +5V or +3.3V.
3. You would need a LVDS cable.



4. To connect all of the devices well.



2.9.3 <DVI Interface >(LE-375QD/RD/PD only)

The board also comes with a DVI interface with Chrontel CH7307C for digital video interface. Supports up to 1600 x 1200 (UXGA) of resolution.

Connector: **DVI**

Connector type: 19-pin Type A DVI connector

Pin Number	Assignment	Pin Number	Assignment
1	TMDS_D2+	2	Ground
3	TMDS_D2-	4	TMDS_D1+
5	Ground	6	TMDS_D1-
7	TMDS_D0+	8	Ground
9	TMDS_D0-	10	TMDS_CLK+
11	Ground	12	TMDS_CLK-
13	N/C	14	N/C
15	DVI_SCL	16	DVI_SDA
17	Ground	18	PVDD
19	HPDET		

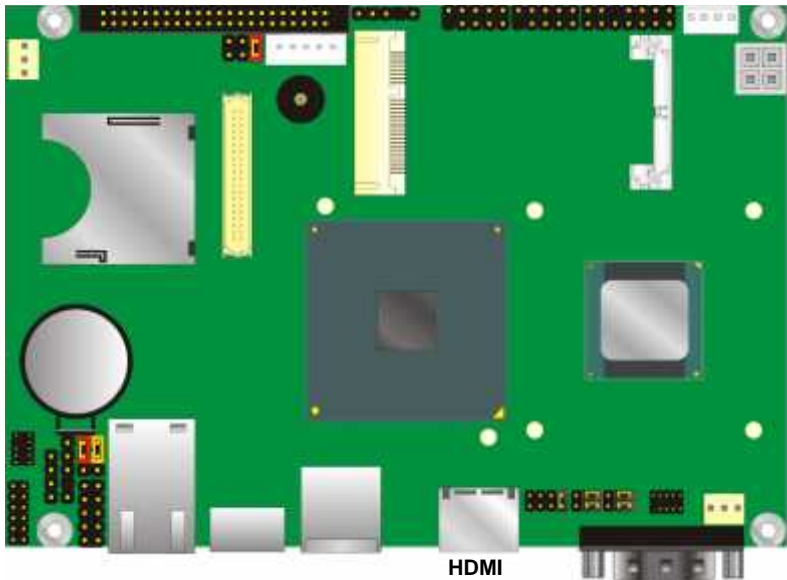

2.10 <Onboard Audio Interface>

The board provides the onboard high definition audio with Realtek ALC888

Connector: CN_AUDIO

Type: 10-pin (2 x 5) 1.27mm x 2.54mm-pitch header

Pin	Description	Pin	Description
1	MIC_L	2	Ground
3	MIC_R	4	N/C
5	SPK_R	6	MIC_JD
7	SENSE	8	N/C
9	SPK_L	10	SPK_JD

Connector: CDIN

Type: 4-pin header (pitch = 2.54mm)

Pin	Description
1	CD – Left
2	Ground
3	Ground
4	CD – Right

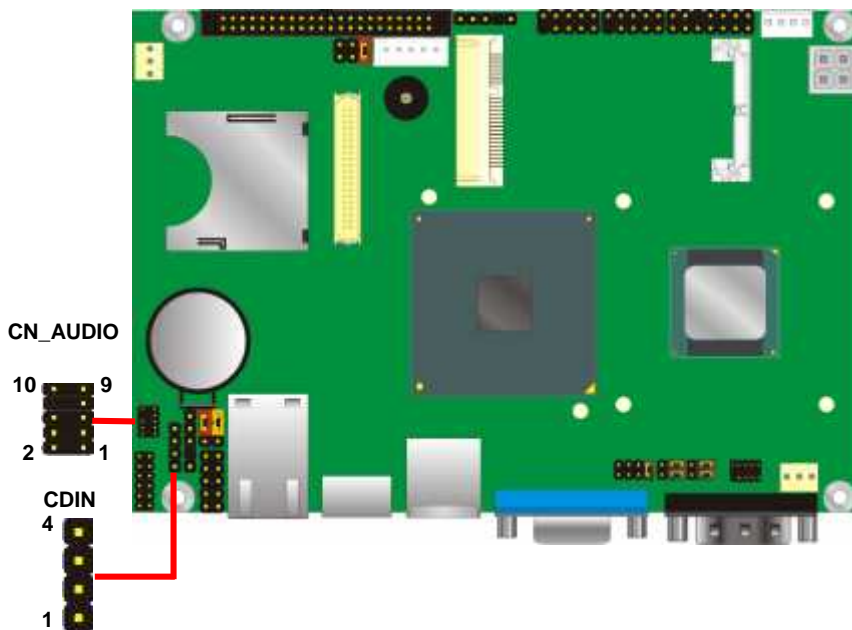

2.11 <USB2.0 Interface>

Based on Intel® SCH , the board provides 6 USB2.0 ports. The USB2.0 interface provides up to 480Mbps of transferring rate.

Interface	USB2.0
Controller	US15WP/US15WPT
Transfer Rate	Up to 480Mb/s
Output Current	500mA

CN_USB1/2

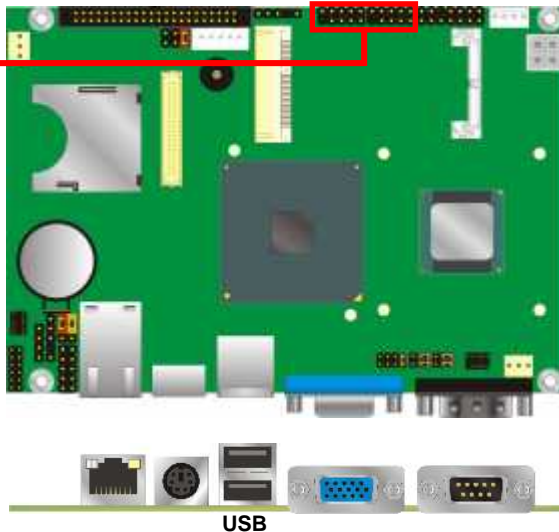

Connector: **CN_USB**

Type: 10-pin (5 x 2) header for USB Port

Pin	Description	Pin	Description
1	VCC	2	VCC
3	Data0-	4	Data1-
5	Data0+	6	Data1+
7	Ground	8	Ground
9	Ground	10	N/C

PS: The USB2.0 will be only active when you connecting with the USB2.0 devices, if you insert an USB1.1 device, the port will be changed to USB1.1 protocol automatically. The transferring rate of USB2.0 as 480Mbps is depends on device capacity, exact transferring rate may not be up to 480Mbps.

2.12 <GPIO Interface>

The board provides a programmable 8-bit digital I/O interface; you can use this general purpose I/O port for system control like POS or KIOSK.

Connector: **CN_DIO**

Type: onboard 2 x 6-pin header, pitch=2.0mm

Pin	Description	Pin	Description
1	Ground	2	Ground
3	GP0	4	GP4
5	GP1	6	GP5
7	GP2	8	GP6
9	GP3	10	GP7
11	VCC	12	+12V

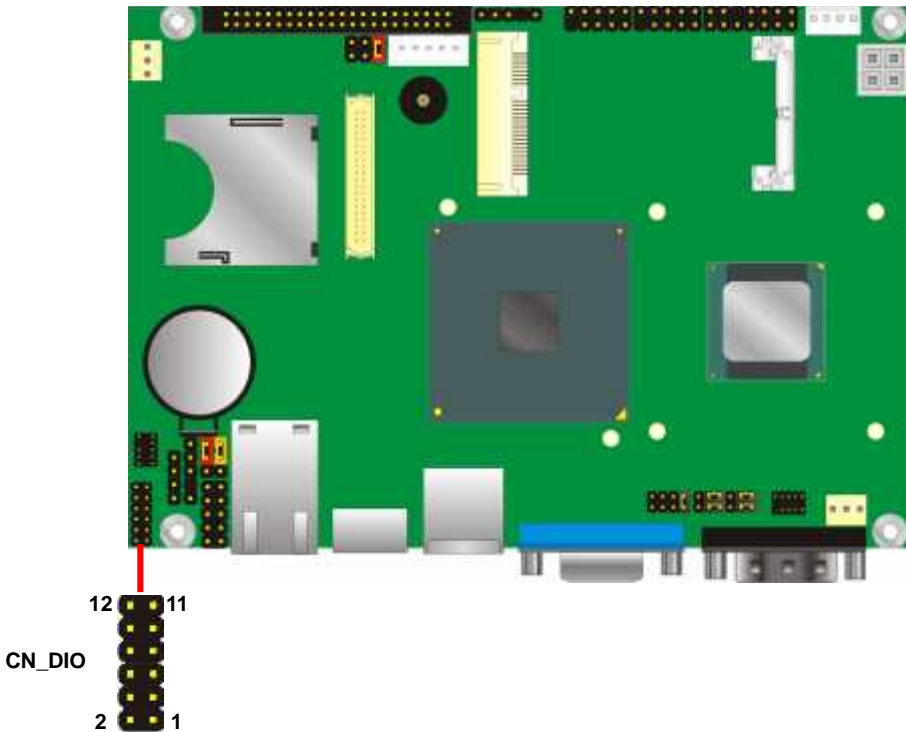

2.13 <Serial Port Jumper Setting >

The board provides two RS232 serial ports, with jumper selectable RS422/485/IrDA for COM2.





Connector: **CN_COM2**

Type: 10-pin (5 x 2) 1.27mm x 2.54mm-pitch header for COM2

Pin	Description	Pin	Description
1	DCD/422TX-/485-	2	RXD/422TX+/485+
3	TXD/422RX+	4	DTR/422RX-
5	GND	6	DSR
7	RTS	8	CTS
9	RI	10	N/C

Jumper: **JCSEL1,JCSEL2**

Type: 12-pin (6 x 2) & 8-pin (4 x 2) for set COM2 mode jumper

	RS232	RS485	RS422	IrDA
JCSEL1				
JCSEL2				

Default: RS232

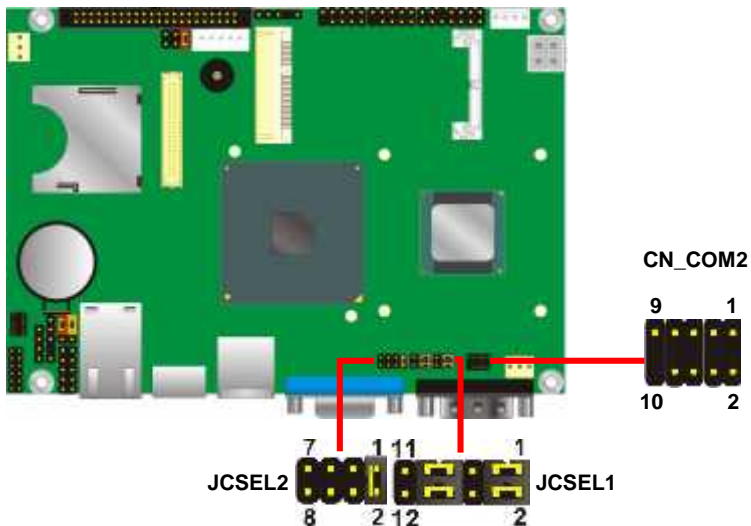

2.14 <Power & FAN Connector >

The board requires DC input with 4-pin header, the input voltage range is from 9V to 24V, for the input current, please take a reference of the power consumption report on appendix.

2.14.1 <Power Input>

Connector: DC_IN

Type: 4-pin header

Pin	Description	Pin	Description
1	Ground	4	+12V
2	Ground	3	+12V

Remark: DC input voltage range 9~24V

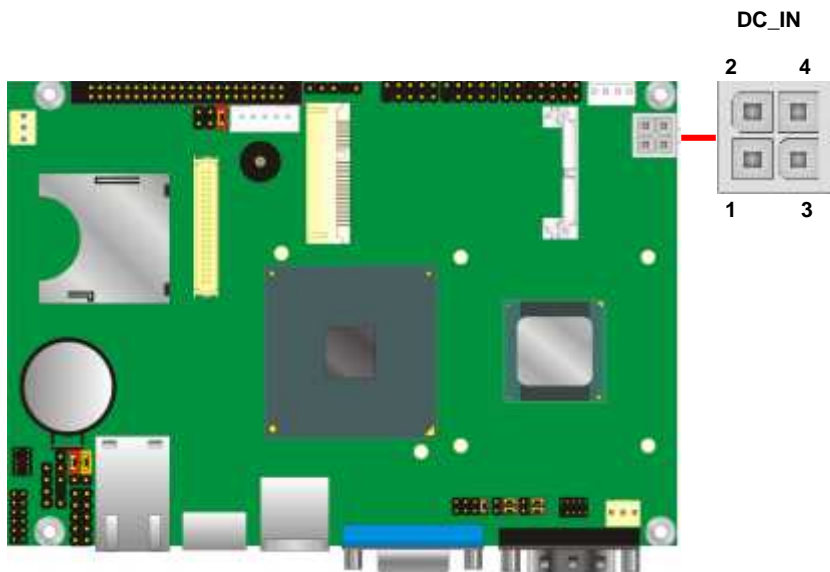

2.14.2 <Power Output>

Connector: DC_OUT

Type: 4-pin connector for +5V/+12V **output**

Pin	Description	Pin	Description	Pin	Description	Pin	Description
1	+12V	2	Ground	3	Ground	4	+5V

Note: Maximum output current 12V/3A, 5V/3A

2.14.3 <Fan Connector>

Connector: SYSFAN, CPUFAN

Type: 3-pin fan wafer connector

Pin	Description	Pin	Description	Pin	Description
1	Ground	2	+12V	3	Speed detect

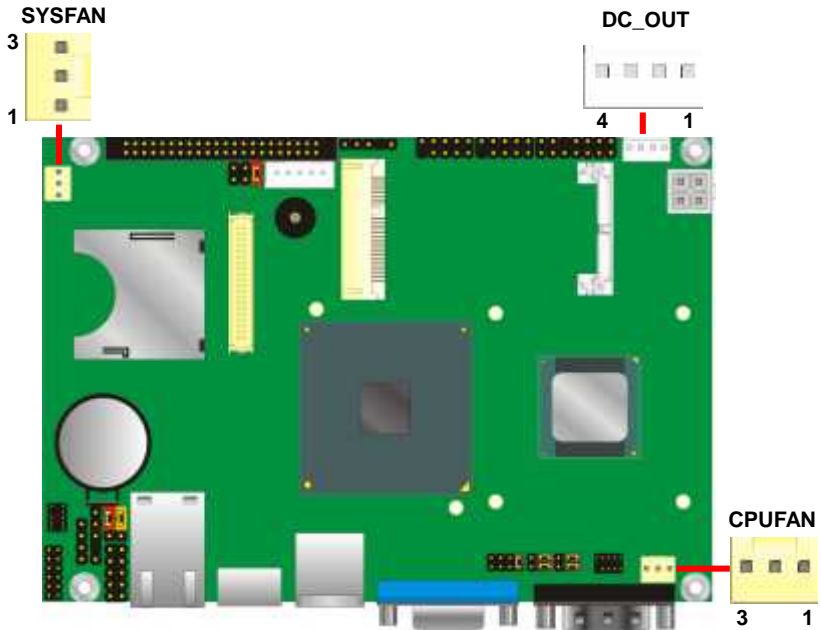

2.15 <Indicator and Switch>

The **JFRNT** provides front control panel of the board, such as power button, reset and beeper, etc. Please check well before you connecting the cables on the chassis.

Connector: **JFRNT**

Type: onboard 14-pin (2 x 7) 2.54-pitch header

Function	Signal	PIN		Signal	Function
IDE LED	HDLED+	1	2	PWRLED+	Power LED
	HDLED-	3	4	N/C	
Reset	Reset+	5	6	PWRLED-	Speaker
	Reset-	7	8	SPK+	
N/C		9	10	N/C	
Power Button	PWRBT+	11	12	N/C	
	PWRBT-	13	14	SPK-	

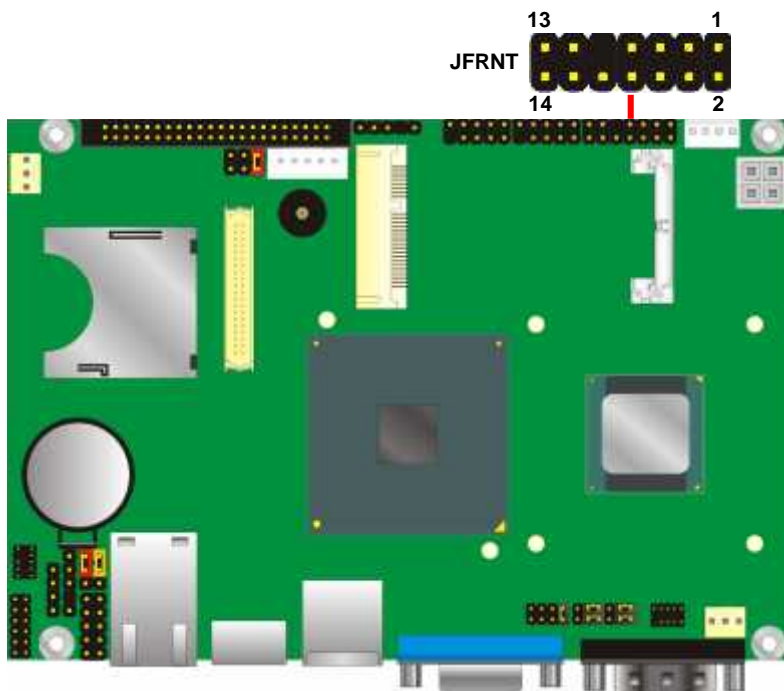

Chapter 3 <BIOS Setup>

The motherboard uses the Award BIOS for the system configuration. The Award BIOS in the single board computer is a customized version of the industrial standard BIOS for IBM PC AT-compatible computers. It supports Intel® x86 and compatible CPU architecture based processors and computers. The BIOS provides critical low-level support for the system central processing, memory and I/O sub-systems.

The BIOS setup program of the single board computer let the customers modify the basic configuration setting. The settings are stored in a dedicated battery-backed memory, NVRAM, retains the information when the power is turned off. If the battery runs out of the power, then the settings of BIOS will come back to the default setting.

The BIOS section of the manual is subject to change without notice and is provided here for reference purpose only. The settings and configurations of the BIOS are current at the time of print, and therefore they may not be exactly the same as that displayed on your screen.

To activate CMOS Setup program, press key immediately after you turn on the system. The following message "Press DEL to enter SETUP" should appear in the lower left hand corner of your screen. When you enter the CMOS Setup Utility, the Main Menu will be displayed as **Figure 4-1**. You can use arrow keys to select your function, press <Enter> key to accept the selection and enter the sub-menu.

Figure 4-1 CMOS Setup Utility Main Screen



Appendix A <I/O Port Pin Assignment>

A.1 <IDE Port>

Connector: IDE

Type: 44-pin (22 x 2) box header



Pin	Description	Pin	Description
1	Reset	2	Ground
3	D7	4	D8
5	D6	6	D9
7	D5	8	D10
9	D4	10	D11
11	D3	12	D12
13	D2	14	D13
15	D1	16	D14
17	D0	18	D15
19	Ground	20	N/C
21	REQ	22	Ground
23	IOW-/STOP	24	Ground
25	IOR-/HDMARDY	26	Ground
27	IRDY/DDMARDY	28	Ground
29	DACK-	30	Ground
31	IRQ	32	N/C
33	A1	34	SD
35	A0	36	A2
37	CS1	38	CS3
39	ASP1	40	Ground
41	Vcc	42	Vcc
43	Ground	44	Ground

A.2 <IrDA Port>

Connector: CN_IR

Type: 5-pin header for SIR Port



Pin	Description
1	VCC
2	N/C
3	IRRX
4	Ground
5	IRTX

A.3 <SMBUS Port>

Connector: **CN_SMBUS**

Type: 5-pin header for SMBUS Port



Pin	Description
1	VCC
2	N/C
3	SMDATA
4	SMCLK
5	Ground

A.4 <LPC Port>

Connector: **CN_LPC**

Type: 10-pin header for LPC Port



Pin	Description	Pin	Description
1	LPC_CLK	2	RESET-
3	LFRAME-	4	LAD3
5	LAD2	6	LAD1
7	LAD1	8	+3.3V
9	Ground	10	Ground

A.5 <CRT Port >

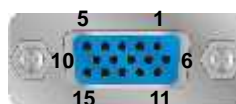

Connector: CRT

Type: 15-pin D-sub female connector on rear panel

Pin	Description	Pin	Description	Pin	Description
1	RED	6	Ground	11	N/C
2	GREEN	7	Ground	12	5VCDA
3	BLUE	8	Ground	13	HSYNC
4	N/C	9	LVGA5V	14	VSYNC
5	Ground	10	Ground	15	5VCLK

A.6 <Serial Port>

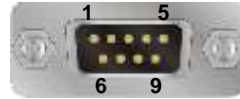

Connector: **COM1**

Type: 9-pin D-sub male connector on rear panel

Pin	Description	Pin	Description
1	DCD	6	DSR
2	SIN	7	RTS
3	SO	8	CTS
4	DTR	9	RI
5	Ground		

A.7 <LAN Port>

Connector: **RJ45**

Type: RJ45 connector with LED on rear panel

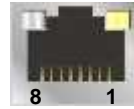

Pin	1	2	3	4	5	6	7	8
Description	TRD0+	TRD0-	TRD1+	TRD2+	TRD2-	TRD1-	TRD3+	TRD3-

Appendix B <Flash BIOS>

B.1 BIOS Auto Flash Tool

The board is based on Award BIOS and can be updated easily by the BIOS auto flash tool. You can download the tool online at the address below:

<http://www.award.com>

<http://www.commell.com.tw/support/support.htm>

File name of the tool is "awdfash.exe", it's the utility that can write the data into the BIOS flash ship and update the BIOS.

B.2 Flash Method

1. Please make a bootable floppy disk.
2. Get the last .bin files you want to update and copy it into the disk.
3. Copy awardflash.exe to the disk.
4. Power on the system and flash the BIOS. (Example: C:/ awardflash XXX.bin)
5. Re-star the system.

Any question about the BIOS re-flash please contact your distributors or visit the web-site at below:

<http://www.commell.com.tw/support/support.htm>

Appendix C <System Resources>

C.1 <I/O Port Address Map>

[00000000 - 0000000F]	Direct memory access controller
[00000000 - 00000CF7]	PCI bus
[00000010 - 0000001F]	Motherboard resources
[00000020 - 00000021]	Programmable interrupt controller
[00000022 - 0000003F]	Motherboard resources
[00000040 - 00000043]	System timer
[00000044 - 0000005F]	Motherboard resources
[00000060 - 00000060]	Standard 101/102-Key or Microsoft Natural PS/2 Keyboard
[00000061 - 00000061]	System speaker
[00000062 - 00000063]	Motherboard resources
[00000064 - 00000064]	Standard 101/102-Key or Microsoft Natural PS/2 Keyboard
[00000065 - 0000006F]	Motherboard resources
[00000070 - 00000073]	System CMOS/real time clock
[00000074 - 0000007F]	Motherboard resources
[00000080 - 00000090]	Direct memory access controller
[00000091 - 00000093]	Motherboard resources
[00000094 - 0000009F]	Direct memory access controller
[000000A0 - 000000A1]	Programmable interrupt controller
[000000A2 - 000000BF]	Motherboard resources
[000000C0 - 000000DF]	Direct memory access controller
[000000E0 - 000000EF]	Motherboard resources
[000000F0 - 000000FF]	Numeric data processor
[00000170 - 00000177]	Secondary IDE Channel
[000001F0 - 000001F7]	Primary IDE Channel
[00000274 - 00000277]	ISAPNP Read Data Port
[00000279 - 00000279]	ISAPNP Read Data Port
[000002F8 - 000002FF]	Communications Port (COM2)
[00000376 - 00000376]	Secondary IDE Channel
[000003B0 - 000003BB]	Intel(R) Graphics Media Accelerator 500
[000003C0 - 000003DF]	Intel(R) Graphics Media Accelerator 500
[000003F6 - 000003F6]	Primary IDE Channel
[000003F8 - 000003FF]	Communications Port (COM1)
[000004D0 - 000004D1]	Motherboard resources
[00000880 - 0000088F]	Motherboard resources
[00000900 - 000009BF]	Motherboard resources
[00000A79 - 00000A79]	ISAPNP Read Data Port
[00000D00 - 0000FFFF]	PCI bus
[0000E000 - 0000EFFF]	Intel(R) SCH Family PCI Express Root Port 1 - 8110
[0000EF00 - 0000EF1F]	Intel(R) 82574L Gigabit Network Connection
[0000FB00 - 0000FB0F]	Standard Dual Channel PCI IDE Controller

[0000FC00 - 0000FC1F] Intel(R) SCH Family USB Universal Host Controller - 8116

[0000FD00 - 0000FD1F] Intel(R) SCH Family USB Universal Host Controller - 8115

[0000FE00 - 0000FE1F] Intel(R) SCH Family USB Universal Host Controller - 8114

[0000FF00 - 0000FF07] Intel(R) Graphics Media Accelerator 500

C.2 <Memory Address Map >

[00000000 - 0009FFFF]	System board
[000A0000 - 000BFFFF]	Intel(R) Graphics Media Accelerator 500
[000A0000 - 000BFFFF]	PCI bus
[000C0000 - 000DFFFF]	PCI bus
[000E0000 - 000EFFFF]	PCI bus
[000E0000 - 000EFFFF]	System board
[000F0000 - 000FFFFFF]	PCI bus
[000F0000 - 000FFFFFF]	System board
[00100000 - 7F6DFFFF]	System board
[7F6E0000 - 7F6FFFFFF]	System board
[7F700000 - 7F7FFFFFF]	System board
[7F800000 - FEBFFFFFF]	PCI bus
[D8000000 - DFFFFFFF]	Intel(R) Graphics Media Accelerator 500
[E0000000 - EFFFFFFF]	Motherboard resources
[FDC00000 - FDCFFFFFF]	Intel(R) SCH Family PCI Express Root Port 1 - 8110
[FDD00000 - FDDFFFFFF]	Intel(R) SCH Family PCI Express Root Port 1 - 8110
[FDDC0000 - FDDDFFFF]	Intel(R) 82574L Gigabit Network Connection
[FDDFC000 - FDDFFFFFF]	Intel(R) 82574L Gigabit Network Connection
[FDF00000 - FDF7FFFF]	Intel(R) Graphics Media Accelerator 500
[FDFC0000 - FDFDFFFF]	Intel(R) Graphics Media Accelerator 500
[FDFF8000 - FDFFBFFF]	Microsoft UAA Bus Driver for High Definition Audio
[FDFFD000 - FDFFD0FF]	SDA Standard Compliant SD Host Controller
[FDFFE000 - FDFFE0FF]	SDA Standard Compliant SD Host Controller
[FDFFF000 - FDFFF3FF]	Intel(R) SCH Family USB2 Enhanced Host Controller - 8117
[FEC00000 - FEC00FFF]	System board
[FED00000 - FED000FF]	System board
[FED00000 - FED003FF]	High precision event timer
[FED13000 - FED1DFFF]	System board
[FED20000 - FED8FFFF]	System board
[FEE00000 - FEE00FFF]	System board
[FFB00000 - FFB7FFFF]	System board
[FFB80000 - FFBFFFFFF]	Intel(R) 82802 Firmware Hub Device
[FFF00000 - FFFFFFFF]	System board

C.3 < System IRQ Resources >

(ISA) 0	High precision event timer
(ISA) 1	Standard 101/102-Key or Microsoft Natural PS/2 Keyboard
(ISA) 3	Communications Port (COM2)
(ISA) 4	Communications Port (COM1)
(ISA) 8	High precision event timer
(ISA) 9	Microsoft ACPI-Compliant System
(ISA) 12	PS/2 Compatible Mouse
(ISA) 13	Numeric data processor
(ISA) 14	Primary IDE Channel
(PCI) 16	Intel(R) 82574L Gigabit Network Connection
(PCI) 16	Intel(R) Graphics Media Accelerator 500
(PCI) 16	Intel(R) SCH Family PCI Express Root Port 1 - 8110
(PCI) 16	Intel(R) SCH Family USB Universal Host Controller - 8114
(PCI) 16	Microsoft UAA Bus Driver for High Definition Audio
(PCI) 16	SDA Standard Compliant SD Host Controller
(PCI) 17	Intel(R) SCH Family USB Universal Host Controller - 8115
(PCI) 17	SDA Standard Compliant SD Host Controller
(PCI) 18	Intel(R) SCH Family USB Universal Host Controller - 8116
(PCI) 19	Intel(R) SCH Family USB2 Enhanced Host Controller - 8117

Appendix D <Programming GPIO's>

The GPIO can be programmed with the MS-DOS debug program using simple IN/OUT commands. The following lines show an example how to do this.

```
GPIO0.....GPIO7  bit0.....bit7
-o 2E 87                ;enter configuration.
-o 2E 87
-o 2E 07
-o 2F 09                ;select logic device 9.
-o 2E 30
-o 2F 02                ;active GPIO3.
-o 2E F0
-o 2F xx                ;set GPIO as input/output; set '1' for input,'0' for
                        output.
-o 2E F1
-o 2F xx                ;if set GPIO's as output,in this register its value
                        can be set
```

Optional :

```
-o 2E F2
-o 2F xx                ; Data inversion register ; '1' inverts the current
                        valus of the bits ,'0' leaves them as they are
```

For further information, please refer to Winbond W83627DHG datasheet.

Appendix E <Watch Dog timer Setting >

The watchdog timer makes the system auto-reset while it stops to work for a period. The integrated watchdog timer can be setup as system reset mode by program.

Timeout Value Range

- 1 to 255
- Second or Minute

Program Sample

Watchdog timer setup as system reset with 5 second of timeout

```

2E, 87
2E, 87
2E, 07
2F, 08      Logical Device 8
2E, 30
2F, 01      Activate
2E, F5
2F, 00      Set as Second*
2E, F6
2F, 05      Set as 5

```

* Minute: bit 3 = 1; Second: bit 3 = 0

You can select Timer setting in the BIOS, after setting the time options, the system will reset according to the period of your selection.

(This Page is Left for Blank)



Contact Information

Any advice or comment about our products and service, or anything we can help you please don't hesitate to contact with us. We will do our best to support you for your products, projects and business.

Taiwan Commate Computer Inc.

Address	19F, No. 94, Sec. 1, Xintai 5th Rd., Xizhi Dist New Taipei City, Taiwan
TEL	+886-2-26963909
FAX	+886-2-26963911
Website	http://www.commell.com.tw
E-Mail	info@commell.com.tw (General Information) tech@commell.com.tw (Technical Support)
Facebook	https://www.facebook.com/pages/Taiwan-Commate-Computer-Inc/547993955271899
Twitter	https://twitter.com/Taiwan_Commate

Commell is our trademark of industrial PC division