

# Preface

## Copyright

This publication, including all photographs, illustrations and software, is protected under international copyright laws, with all rights reserved. Neither this manual, nor any of the material contained herein, may be reproduced without written consent of the author.

Version 1.1

## Disclaimer

The information in this document is subject to change without notice. The manufacturer makes no representations or warranties with respect to the contents hereof and specifically disclaims any implied warranties of merchantability or fitness for any particular purpose. The manufacturer reserves the right to revise this publication and to make changes from time to time in the content hereof without obligation of the manufacturer to notify any person of such revision or changes.

## Trademark Recognition

Microsoft, MS-DOS and Windows are registered trademarks of Microsoft Corp.

MMX, Pentium, Pentium-II, Pentium-III, Celeron are registered trademarks of Intel Corporation.

Other product names used in this manual are the properties of their respective owners and are acknowledged.

## Federal Communications Commission (FCC)

This equipment has been tested and found to comply with the limits for a Class B digital device, pursuant to Part 15 of the FCC Rules. These limits are designed to provide reasonable protection against harmful interference in a residential installation. This equipment generates, uses, and can radiate radio frequency energy and, if not installed and used in accordance with the instructions, may cause harmful interference to radio communications. However, there is no guarantee that interference will not occur in a particular installation. If this equipment does cause harmful interference to radio or television reception, which can be determined by turning the equipment off and on, the user is encouraged to try to correct the interference by one or more of the following measures:

- Reorient or relocate the receiving antenna.
- Increase the separation between the equipment and the receiver.
- Connect the equipment onto an outlet on a circuit different from that to which the receiver is connected.
- Consult the dealer or an experienced radio/TV technician for help.

Shielded interconnect cables and a shielded AC power cable must be employed with this equipment to ensure compliance with the pertinent RF emission limits governing this device. Changes or modifications not expressly approved by the system's manufacturer could void the user's authority to operate the equipment.

## Declaration of Conformity

This device complies with part 15 of the FCC rules. Operation is subject to the following conditions:

- This device may not cause harmful interference, and
- This device must accept any interference received, including interference that may cause undesired operation.

## Canadian Department of Communications

This class B digital apparatus meets all requirements of the Canadian Interference-causing Equipment Regulations.

Cet appareil numérique de la classe B respecte toutes les exigences du Règlement sur le matériel brouilleur du Canada.

## About the Manual

The manual consists of the following:

<b>Chapter 1</b> <b>Introducing the Mainboard</b>	Describes features of the mainboard, and provides a shipping checklist.  Go to ⇒ page 1
<b>Chapter 2</b> <b>Installing the Mainboard</b>	Describes installation of mainboard components.  Go to ⇒ page 8
<b>Chapter 3</b> <b>Using BIOS</b>	Provides information on using the BIOS Setup Utility.  Go to ⇒ page 28
<b>Chapter 4</b> <b>Using the Mainboard Software</b>	Describes the mainboard software.  Go to ⇒ page 52

---

## TABLE OF CONTENTS

---

<b>Preface</b>	<b>i</b>
<b>CHAPTER 1</b>	<b>1</b>
<b>Introducing the Mainboard</b>	<b>1</b>
<i>Introduction</i> .....	1
<i>Checklist</i> .....	2
Standard Items.....	2
<i>Features</i> .....	3
<i>Choosing a Computer Case</i> .....	5
<i>Mainboard Components</i> .....	6
<b>CHAPTER 2</b>	<b>8</b>
<b>Installing the Mainboard</b>	<b>8</b>
<i>Safety Precautions</i> .....	8
<i>Quick Guide</i> .....	8
<i>Installing the Mainboard in a Case</i> .....	9
<i>Checking Jumper Settings</i> .....	9
Setting Jumpers.....	9
Checking Jumper Settings.....	10
Jumper Settings.....	10
Connecting Case Components.....	11
Front Panel Connector.....	13
<i>Installing Hardware</i> .....	14
Installing the Processor.....	14
Installing Memory Modules.....	17
Installing a Hard Disk Drive/CD-ROM.....	18
Installing a Floppy Diskette Drive.....	20
Installing Add-on Cards.....	21
Connecting Optional Devices.....	23
<i>Connecting I/O Devices</i> .....	26
External Connector Color Coding.....	27
<b>CHAPTER 3</b>	<b>28</b>
<b>Using BIOS</b>	<b>28</b>
<i>About the Setup Utility</i> .....	28
The Standard Configuration.....	28
Entering the Setup Utility.....	29
Updating the BIOS.....	29
<i>Using BIOS</i> .....	30
Standard CMOS Features.....	31

Advanced BIOS Setup Option.....	33
Advanced Chipset Features Option .....	36
Integrated Peripherals .....	38
Power Management Setup Option .....	43
PNP/PCI Configurations.....	47
PC Health Status Option.....	48
Frequency/Voltage Control.....	49
Load Fail-Safe Defaults Option.....	50
Load Optimized Defaults Option.....	50
Set Supervisor/User Password.....	51
Save & Exit Setup Option .....	51
Exit Without Saving .....	51

**CHAPTER 4** **52**

<b>Using the Mainboard Software</b>	<b>52</b>
<i>About the Software CD-ROM</i> .....	52
<i>Auto-installing under Windows 98/ME/2000/XP</i> .....	52
Running Setup .....	53
<i>Manual Installation</i> .....	55
<i>Utility Software Reference</i> .....	55

## Chapter 1

# Introducing the Mainboard

---

### Introduction

Thank you for choosing the L4S8A2 mainboard. The L4S8A2 mainboard is a high-performance, enhanced function mainboard that supports Socket 478 Pentium 4 processors with system speeds up to 533MHz for high-end business or personal desktop markets.

The mainboard incorporates the SiS648 Northbridge and SiS963 Southbridge chipsets. The SiS648 Northbridge chipset provides a 12-level In-Order-Queue to support maximum outstanding transactions on host up to 12. The memory controller offers high-bandwidth up to 2.7GB/s under DDR333 in order to sustain the bandwidth demand from the host processor, as well as the multi I/O masters and AGP masters. While the SiS963 Southbridge integrates the Universal Serial Bus 2.0 Host Controllers, 1394a and Audio Controller with AC 97 interface.

The L4S8A2 is designed to give customers an advanced, multimedia solution at a very low cost. It is equipped with advanced full set of I/O ports, such as dual channel IDE interfaces, a floppy controller, two high-speed serial port, an EPP/ECP capable bi-directional parallel port connector, four USB (Universal Serial Bus) connector, a PS/2 keyboard and mouse connectors. One AGP slot, five PCI local bus slots and one communication and networking riser (CNR - *optional*) slot provide expandability for add-on peripheral cards.

---

**Note:** SDRAM provides 800 MBps or 1 GBps data transfer depending on whether the bus is 100 MHz or 133 MHz. Double Data Rate SDRAM (DDR SDRAM) doubles the rate to 1.6 GBps or 2.7 GBps by transferring data on both the rising and falling edges of the clock. DDR SDRAM uses additional power and ground lines and requires 184-pin DIMM modules rather than the 168-pin DIMMs used by SDRAM.

---

---

## **Checklist**

Compare the mainboard's package contents with the following checklist:

### **Standard Items**

- One mainboard
- One diskette drive ribbon cable (optional)
- One IDE drive ribbon cable
- One auto-install software support CD
- One I/O panel
- One cooling fan retention module
- This user's manual

## Features

<b>Processor</b>	<p>The L4S8A2 mainboard uses a micro PGA 478-pin socket that has the following features:</p> <ul style="list-style-type: none"> <li>• Supports 400/533 MHz system bus</li> <li>• Supports “Hyper-Threading” technology CPU</li> <li>• Accommodates Pentium 4 processors at 1.5G/1.6G/1.7G... 2.5G and above</li> </ul> <p>“Hyper-Threading” technology enables the operating system into thinking it’s hooked up to two processors, allowing two threads to be run in parallel, both on separate ‘logical’ processors within the same physical processor.</p>
<b>Chipset</b>	<p>The SiS648 and SiS963 chipsets are based on an innovative and scalable architecture with proven reliability and performance. A few of the chipset’s advanced features are:</p> <ul style="list-style-type: none"> <li>• Supports Intel Pentium 4 series CPU with data transfer rate up to 533MHz</li> <li>• Support 12 outstanding transactions and out-of-order completion</li> <li>• Supports 64-bit high performance DDR333/DDR266 Memory Controller</li> <li>• Universal AGP v3.0 compliant and supports AGP 8X/4X Interface with Fast Write Transaction</li> <li>• Distributed arbitration strategy with long contiguous data streaming up to 1GB/s</li> <li>• PCI 2.2 specification compliance</li> <li>• Integrated multi-threaded I/O link mastering with read pipelined streaming</li> <li>• Supports Ultra DMA 33/66/100/133</li> </ul> <p>Additional key features include support for six USB 2.0 ports, Fast Ethernet MAC controller, AC97 interface, advanced power management, integrated DMA controller and keyboard controller.</p>
<b>Memory</b>	<ul style="list-style-type: none"> <li>• Supports DDR SDRAM up to 200/266/333 MHz memory module</li> <li>• Accommodates three unbuffered 2.5V 184-pin slots</li> <li>• Each slot supports up to 1 GB with a total maximum capacity of 3 GB</li> </ul>
<b>AGP</b>	<p>The L4S8A2 includes an 8xAGP slot that provides eight times the bandwidth of the original AGP specification. The AGP 3.0 (8xAGP) offers a significant increase in performance along with feature enhancements to AGP2.0. This interface represents the natural evolution from the existing AGP to meet the ever-increasing demands placed on the graphic interfaces within the workstation and desktop environments.</p>
<b>AC’ 97 Audio Codec</b>	<p>The AC’ 97 Audio codec is compliant with the AC’ 97 2.2 specification, and supports 18-bit ADC (Analog Digital Converter) and DAC (Digital Analog Converter) resolution as well as 18-bit stereo full-duplex codec with independent and variable sampling rates. Further features include support for four analog line-level stereo inputs.</p>

<b>Expansion Options</b>	<p>The mainboard comes with the following expansion options:</p> <ul style="list-style-type: none"> <li>• Five 32-bit PCI slots</li> <li>• One 8x/4x AGP slot</li> <li>• A Communications Network Riser (CNR) slot (AC97 interface only) (<i>optional</i>)</li> <li>• Two IDE connectors which support four IDE channels and a floppy disk drive interface</li> </ul> <p>The L4S8A2 supports Ultra DMA bus mastering with transfer rates of 33/66/100/133 MB/sec.</p>
<b>Onboard LAN (optional)</b>	<p>RTL8201BL is a Fast Ethernet Phyceiver with an MII (Media Independent Interface)/SNI (Serial Network Interface). It can be used as a Network Interface Adapter, MAU, CNR, ACR, Ethernet Hub, and Ethernet Switch.</p> <p>It is incorporated in the chipset providing the mainboard with 10/100Mbps fast Ethernet controller and integrated Ethernet PCI LAN capabilities.</p>
<b>Integrated I/O</b>	<p>The mainboard has a full set of I/O ports and connectors:</p> <ul style="list-style-type: none"> <li>• Two PS/2 ports for mouse and keyboard</li> <li>• Two serial port (COM2 – optional)</li> <li>• One parallel port</li> <li>• Four USB ports</li> <li>• One LAN port (optional)</li> <li>• Audio jacks for microphone, line-in and line-out</li> </ul>
<b>BIOS Firmware</b>	<p>This mainboard uses Award BIOS that enables users to configure many system features including the following:</p> <ul style="list-style-type: none"> <li>• Power management</li> <li>• Wake-up alarms</li> <li>• CPU parameters</li> <li>• CPU and memory timing</li> </ul> <p>The firmware can also be used to set parameters for different processor clock speeds.</p>



Some hardware specifications and software items are subject to change without prior notice.



---

## **Choosing a Computer Case**

There are many types of computer cases on the market. The mainboard complies with the specifications for the ATX system case. Some features on the mainboard are implemented by cabling connectors on the mainboard to indicators and switches on the system case. Ensure that your case supports all the features required. The mainboard can support one or two floppy diskette drives and four enhanced IDE drives. Ensure that your case has sufficient power and space for all the drives that you intend to install.

Most cases have a choice of I/O templates in the rear panel. Make sure that the I/O template in the case matches the I/O ports installed on the rear edge of the mainboard.

This mainboard has an ATX form factor of 305 x 190 mm. Choose a case that accommodates this form factor.

## Mainboard Components

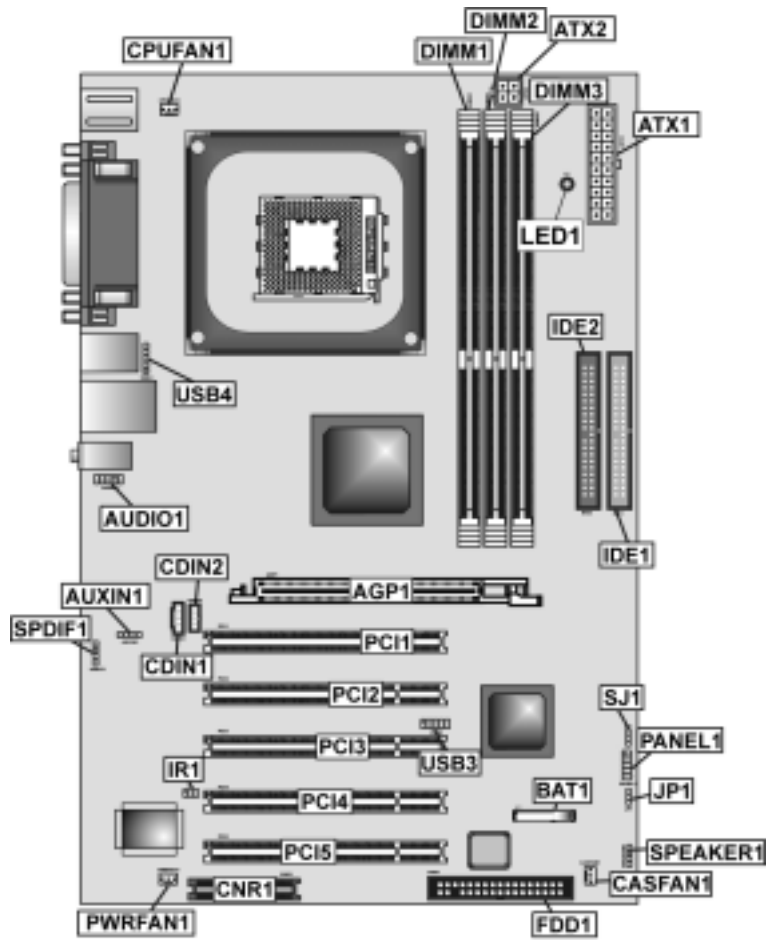

## Table of Mainboard Components

Label	Component
AGP1	Accelerated Graphics Port
ATX1	Standard 20-pin ATX power connector
ATX2	CPU Vcore power connector
AUDIO1	Front audio connector
AUXIN1*	Extra line-in connector
BT1	Three volt realtime clock battery
CASFAN1	Case fan connector
CDIN1	Primary CD-in connector
CDIN2*	Secondary CD-in connector
CNR1*	Communications Networking Riser slot
CPU SOCKET	Micro PGA 478-pin socket for Pentium 4 CPUs
CPUFAN1	Cooling fan for CPU
DIMM1, DIMM2, DIMM3	Three 184-pin DDR SDRAM
FDD1	Floppy disk drive connector
IDE 1	Primary IDE channel
IDE 2	Secondary IDE channel
IR1	Infrared port
JP1	Clear CMOS jumper
LED1 <sup>1</sup>	Memory module LED
PANEL1	Connector for case front panel switches and LED indicators
PCI1 ~ PCI5	Five 32-bit add-on card slots
PWRFAN1*	Power fan connector
SJ1	Single color LED header
SPEAKER1	Speaker connector
SPDIF1*	SPDIF out header
USB3	Connector for front panel USB ports
USB4	USB Card Reader header

\*Optional component

This concludes Chapter 1. The next chapter explains how to install the mainboard.

---

<sup>1</sup> The red indicator LED1 (optional) turns on if your system is still powered, at which time memory modules cannot be installed or uninstalled.

## Chapter 2

# Installing the Mainboard

---

### Safety Precautions

Follow these safety precautions when installing the mainboard:

- Wear a grounding strap attached to a grounded device to avoid damage from static electricity.
- Discharge static electricity by touching the metal case of a safely grounded object before working on the mainboard.
- Leave components in the static-proof bags they came in.
- Hold all circuit boards by the edges. Do not bend circuit boards.

---

### Quick Guide

This Quick Guide suggests the steps you can take to assemble your system with the mainboards.

The following table provides a reference for installing specific components:

<b>Locating Mainboard Components</b>	Go to page 6
<b>Installing the Mainboard in a Case</b>	Go to page 9
<b>Setting Jumpers</b>	Go to page 9
<b>Installing Case Components</b>	Go to page 11
<b>Installing the CPU</b>	Go to page 14
<b>Installing Memory</b>	Go to page 17
<b>Installing an HDD and CD-ROM Drive</b>	Go to page 18
<b>Installing an FDD</b>	Go to page 20
<b>Installing Add-on Cards</b>	Go to page 21
<b>Connecting Options</b>	Go to page 23
<b>Connecting Peripheral (I/O) Devices</b>	Go to page 26

---

## Installing the Mainboard in a Case

Refer to the following illustration and instructions for installing the mainboard in a case:

This illustration shows an example of a mainboard being installed in a tower-type case:

**Note:** Do not overtighten the screws as this can stress the mainboard.

Most system cases have mounting brackets installed in the case, which correspond to the holes in the mainboard. Place the mainboard over the mounting brackets and secure the mainboard onto the mounting brackets with screws.

2. Secure the mainboard with screws where appropriate.

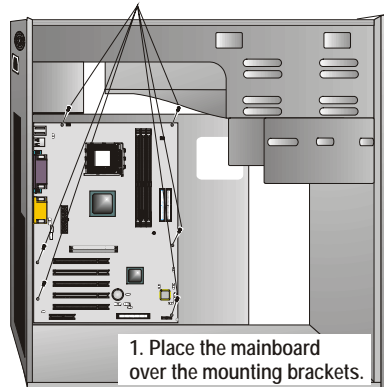

Ensure that your case has an I/O template that supports the I/O ports and expansion slots on your mainboard.

---

## Checking Jumper Settings

This section explains how to set jumpers for correct configuration of the mainboard.

### Setting Jumpers

Use the mainboard jumpers to set system configuration options. Jumpers with more than one pin are numbered. When setting the jumpers, ensure that the jumper caps are placed on the correct pins.

The illustrations below show a 2-pin jumper. When the jumper cap is placed on both pins, the jumper is **SHORT**. If you remove the jumper cap, or place the jumper cap on just one pin, the jumper is **OPEN**.

This illustration shows a 3-pin jumper. Pins 1 and 2 are **SHORT**.

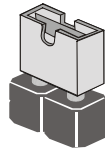

**Short**

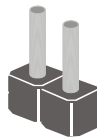

**Open**

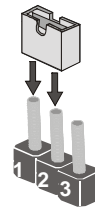

## Checking Jumper Settings

The following illustration shows the location of the mainboard jumpers. Pin 1 is labeled.



## Jumper Settings

Jumper	Type	Description	Setting (default)
JP1	3-pin	Clear CMOS	1-2: Normal 2-3: Clear CMOS 

**JP1** – Enables you to clear the BIOS. Follow these instructions:

1. Turn the system off.
2. Short pins 2 and 3 on jumper 1.
3. Return the jumper to the normal setting.
4. Turn the system on. The BIOS is returned to the default settings.

## Connecting Case Components

After you have installed the mainboard into a case, you can begin connecting the mainboard components. Refer to the following:

<ol style="list-style-type: none"> <li>1. Connect the Pentium 4 processor auxiliary case power supply connector to <b>ATX2</b>.</li> <li>2. Connect the standard power supply connector to <b>ATX1</b>.</li> <li>3. Connect the CPU cooling fan cable to <b>CPUFAN1</b>.</li> <li>4. Connect the power cooling fan connector to <b>PWRFAN1</b> (<i>optional</i>).</li> <li>5. Connect the case cooling fan connector to <b>CASFAN1</b>.</li> <li>6. Connect the case switches and indicator to <b>PANEL1</b>.</li> <li>7. Connect the case speaker cable to <b>SPEAKER1</b>.</li> <li>8. Connect the case LED cable to <b>SJ1</b>.</li> </ol>	
---	--

### ATX2: ATX 12V Power Connector

Pin	Signal Name
1	+12V
2	+12V
3	Ground
4	Ground

### ATX1: ATX 20-pin Power Connector

Pin	Signal Name	Pin	Signal Name
1	+3.3V	11	+3.3V
2	+3.3V	12	-12V
3	Ground	13	Ground
4	+5V	14	PS ON#
5	Ground	15	Ground
6	+5V	16	Ground
7	Ground	17	Ground
8	PWRGD	18	+5V
9	+5VSB	19	+5V
10	+12V	20	+5V

**CPUFAN1/PWRFAN1 (optional)/CASFAN1: FAN Power Connectors**

Pin	Signal Name	Function
1	GND	System Ground
2	+12V	Power +12V
3	Sense	Sensor

**SPEAKER1: Internal speaker**

Pin	Signal Name
1	Signal
2	Key
3	Ground
4	VCC

**SJ1: Single color LED header**

Pin	Signal Name	Function
1	ACPI LED	MSG LED (-) green
2	ACPI LED	MSG LED (-) green
3	SB5V	Power LED (+)

**ACPI LED function:**

 SJ1 1	S0	S1	S3	S4/S5
	Light	Blinking	Blinking	Dark



## Front Panel Connector

The front panel connector (PANEL1) provides a standard set of switch and LED connectors commonly found on ATX or micro-ATX cases. Refer to the table below for information:



Pin	Signal Name	Function
1	HD_LED_P	Hard disk LED (positive)
2	FP_PWR/SLP	MSG LED [dual color or single color (+)]
3	HD_LED_N	Hard disk active LED (negative)
4	FP_PWR/SLP	MSG LED [dual color or single color (-)]
5	RST_SW_N	Reset Switch
6	PWR_SW_P	Power Switch
7	RST_SW_P	Reset Switch
8	PWR_SW_N	Power Switch
9	RSVD	Reserved
10	NC	No pin

PANEL1

### **Hard Drive Activity LED**

Connecting pins 1 and 3 to a front panel mounted LED provides visual indication that data is being read from or written to the hard drive. For the LED to function properly, an IDE drive should be connected to the onboard IDE interface. The LED will also show activity for devices connected to the SCSI (hard drive activity LED) connector.

### **Power / Sleep / Message Waiting LED**

Connecting pins 2 and 4 to a single- or dual-color, front panel mounted LED provides power on/off, sleep, and message waiting indication.

### **Reset Switch**

Supporting the reset function requires connecting pins 5 and 7 to a momentary-contact switch that is normally open. When the switch is closed, the board resets and runs POST.

### **Power Switch**

Supporting the power on/off function requires connecting pins 6 and 8 to a momentary-contact switch that is normally open. The switch should maintain contact for at least 50 ms to signal the power supply to switch on or off. The time requirement is due to internal debounce circuitry. After receiving a power on/off signal, at least two seconds elapses before the power supply recognizes another on/off signal.

---

## Installing Hardware

### Installing the Processor

**Caution:** When installing a CPU heatsink and cooling fan make sure that you **DO NOT** scratch the mainboard or any of the surface-mount resistors with the clip of the cooling fan. If the clip of the cooling fan scrapes across the mainboard, you may cause serious damage to the mainboard or its components.

On most mainboards, there are small surface-mount resistors near the processor socket, which may be damaged if the cooling fan is carelessly installed.

Avoid using cooling fans with sharp edges on the fan casing and the clips. Also, install the cooling fan in a well-lit work area so that you can clearly see the mainboard and processor socket.

### Before installing the Processor

This mainboard automatically determines the CPU clock frequency and system bus frequency for the processor. You may be able to change these settings by making changes to jumpers on the mainboard, or changing the settings in the system Setup Utility. We strongly recommend that you do not overclock processors or other components to run faster than their rated speed.

**Warning:** Overclocking components can adversely affect the reliability of the system and introduce errors into your system. Overclocking can permanently damage the mainboard by generating excess heat in components that are run beyond the rated limits.

This mainboard has a Socket 478 processor socket. When choosing a processor, consider the performance requirements of the system. Performance is based on the processor design, the clock speed and system bus frequency of the processor, and the quantity of internal cache memory and external cache memory.

### CPU Installation Procedure

The following illustration shows CPU installation components:

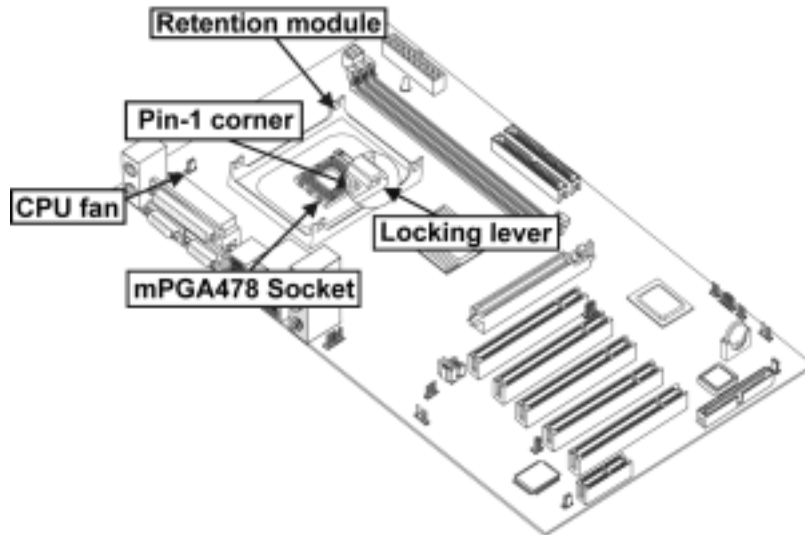

---

**Note:** The pin-1 corner is marked with an arrow

---

Follow these instructions to install the Retention Module and CPU:

1. Remove the existing retention module (if applicable).
  
2. Position the backplate against the underside of the mainboard; secure the 4 screws firmly on the retention module.

---

**Note:** Do not over tighten the screws.

---

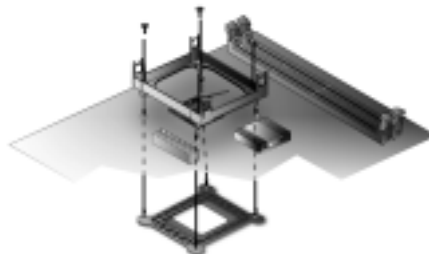

3. Install your CPU. Pull up the lever away from the socket and lift up to 90-degree angle.

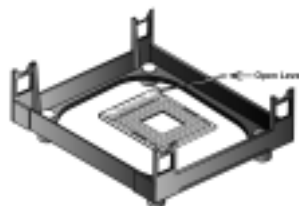

4. Locate the CPU cut edge (the corner with the pinhole noticeably missing). Align and insert the CPU correctly.

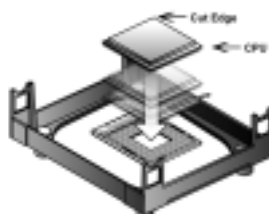

5. Press the lever down.

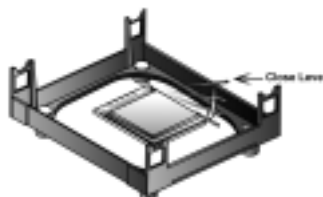

6. Apply thermal grease on top of the CPU.

7. Put the CPU Fan down on the retention module and snap the four retention legs of the cooling fan into place.



8. Flip the levers over to lock the heat sink in place.

9. Connect the CPU Cooling Fan power cable to the CPUFAN1 connector. This completes the installation.



- Notes:**
- To achieve better airflow rates and heat dissipation, we suggest that you use a high quality fan with 4800 rpm at least.
  - CPU fan and heatsink installation procedures may vary with the type of CPU fan/heatsink supplied. The form and size of fan/heatsink may also vary.

## Installing Memory Modules

This mainboard accommodates three 184-pin 2.5V unbuffered Double Data Rate (DDR) SDRAM memory modules. The memory chips must be standard or registered SDRAM (Synchronous Dynamic Random Access Memory). The memory bus can run up to 166 MHz.

When you installed DDR333 memory modules, the memory bus can run up to 166 MHz. If you have DDR266, this can operate over a 133 MHz. For DDR200, it can only run up to 100 MHz.

---

**Note:** SDRAM provides 800 MBps or 1 GBps data transfer depending on whether the bus is 100MHz or 133MHz. Double Data Rate SDRAM (DDR SDRAM) doubles the rate to 1.6 GBps and 2.1 GBps. DDR SDRAM uses additional power and ground lines and requires 184-pin DIMM modules rather than the 168-pin DIMMs used by SDRAM.

---

The mainboard accommodates three memory modules. You must install at least one module in any of the three slots. Each module can be installed with 32 MB to 1 GB of memory; total memory capacity is 3 GB.



Do not remove any memory module from its antistatic packaging until you are ready to install it on the mainboard. Handle the modules only by their edges. Do not touch the components or metal parts. Always wear a grounding strap when you handle the modules.

## Installation Procedure

Refer to the following to install the memory modules.

1. This mainboard supports unbuffered DDR SDRAM only. Do not attempt to insert any other type of DDR SDRAM into the slots.



2. Push the latches on each side of the DIMM slot down.

3. Align the memory module with the slot. The DIMM slots are keyed with notches and the DIMMs are keyed with cutouts so that they can only be installed correctly.

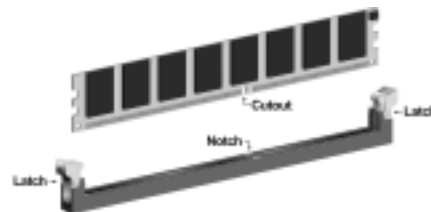

4. Check that the cutouts on the DIMM module edge connector match the notches in the DIMM slot.

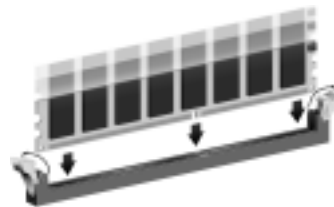

5. Install the DIMM module into the slot and press it firmly down until it seats correctly. The slot latches are levered upwards and latch on to the edges of the DIMM.

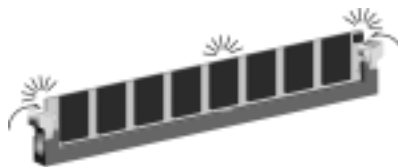

6. Install any remaining DIMM modules.

**DDR SDRAM memory module table:**

DDR 266	3 DIMMS
DDR 333	2 DIMMS
DDR 400	1 DIMM

---

**Note:** We do not guarantee that all DDR 400 memory modules will work properly with your mainboard.

---

## Installing a Hard Disk Drive/CD-ROM

This section describes how to install IDE devices such as a hard disk drive and a CD-ROM drive.

### About IDE1 and IDE2 Devices

Your mainboard has a primary and secondary IDE channel interface (IDE1 and IDE2). An IDE ribbon cable supporting two IDE devices is bundled with the mainboard.

If you want to install more than two IDE devices, get a second IDE cable and you can add two more devices to the secondary IDE channel.

IDE devices have jumpers or switches that are used to set the IDE device as MASTER or SLAVE. Refer to the IDE device user's manual. When installing two IDE devices on one cable, ensure that one device is set to MASTER and the other device is set to SLAVE. The documentation of your IDE device explains how to do this.

### About UltraDMA

This mainboard supports UltraDMA 66/100/133. UDMA is a technology that accelerates the performance of devices in the IDE channel. To maximize performance, install IDE devices that support UDMA and use 80-pin IDE cables that support UDMA 66/100/133.

## Installing a Hard Disk Drive

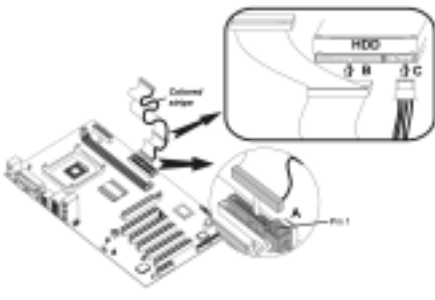
1. Install the hard disk drive into the drive cage in your system case.	
<p>2. Plug the IDE cable into IDE1 (A):</p> <p><b>Note:</b> Ribbon cable connectors are usually keyed so that they can only be installed correctly on the device connector. If the connector is not keyed, make sure that you match the pin-1 side of the cable connector with the pin-1 side of the device connector. Each connector has the pin-1 side clearly marked. The pin-1 side of each ribbon cable is always marked with a colored stripe on the cable.</p>	
3. Plug an IDE cable connector into the hard disk drive IDE connector (B). It doesn't matter which connector on the cable you use.	
4. Plug a power cable from the case power supply into the power connector on the hard disk drive (C).	

When you first start up your system, the BIOS should automatically detect your hard disk drive. If it doesn't, enter the Setup Utility and use the IDE Hard Disk Auto Detect feature to configure the hard disk drive that you have installed. See IDE HDD Auto-Detection on page 32 for more information.

## Installing a CD-ROM/DVD Drive

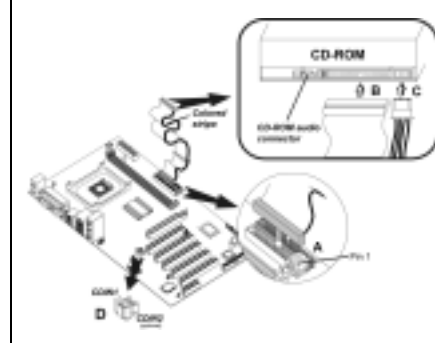
1. Install the CD-ROM/DVD drive into the drive cage in your system case.	
<p>2. Plug the IDE cable into IDE1 (A). If you have already installed an HDD, use the other connector on the IDE cable.</p> <p><b>Note:</b> Ribbon cable connectors are usually keyed so that they can only be installed correctly on the device connector. If the connector is not keyed, make sure that you match the pin-1 side of the cable connector with the pin-1 side of the device connector. Each connector has the pin-1 side clearly marked. The pin-1 side of each ribbon cable is always marked with a colored stripe on the cable.</p>	
3. Plug an IDE cable connector into the CD-ROM/DVD drive IDE connector (B). It doesn't matter which connector on the cable you use.	
4. Plug a power cable from the case power supply into the power connector on the CD-ROM/DVD drive (C).	
5. Use the audio cable provided with the CD-ROM/DVD drive to connect to the mainboard CD-in connector CDIN1 or CDIN2 (D).	

When you first start up your system, the BIOS should automatically detect your CD-ROM/DVD drive. If it doesn't, enter the Setup Utility and configure the CD-ROM/DVD drive that you have installed. See IDE Primary/Secondary

Master/Slave on page 32 for more information.

## Installing a Floppy Diskette Drive

The mainboard has a floppy diskette drive (FDD) interface and ships with a diskette drive ribbon cable that supports one or two floppy diskette drives. You can install a 5.25-inch drive and a 3.5-inch drive with various capacities. The floppy diskette drive cable has one type of connector for a 5.25-inch drive and another type of connector for a 3.5-inch drive.

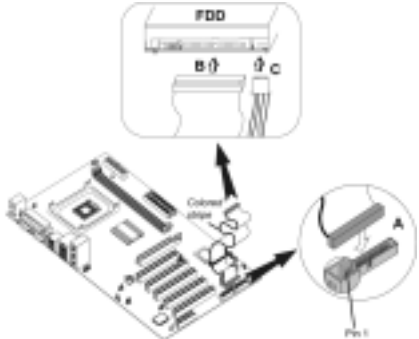
1. Install the FDD into the drive cage in your system case.	
2. Plug the FDD cable into FDD1 (A): <b>Note:</b> Ribbon cable connectors are usually keyed so that they can only be installed correctly on the device connector. If the connector is not keyed, make sure that you match the pin-1 side of the cable connector with the pin-1 side of the device connector. Each connector has the pin-1 side clearly marked. The pin-1 side of each ribbon cable is always marked with a colored stripe on the cable.	
3. Plug the correct connector on the FDD cable for the 5.25-inch or 3.5-inch drive into the FDD connector (B).	
4. Plug a power cable from the case power supply into the power connector on the FDD (C).	

When you first start up your system, go immediately to the Setup Utility to configure the floppy diskette drives that you have installed. See Standard CMOS Features on page 31 for more information.



## Installing Add-on Cards

The slots in this mainboard are designed to hold expansion cards and connect them to the system bus. Expansion slots are a means of adding or enhancing the mainboard's features and capabilities. With these efficient facilities, you can increase the mainboard's capabilities by adding hardware which performs tasks that are not part of the basic system.

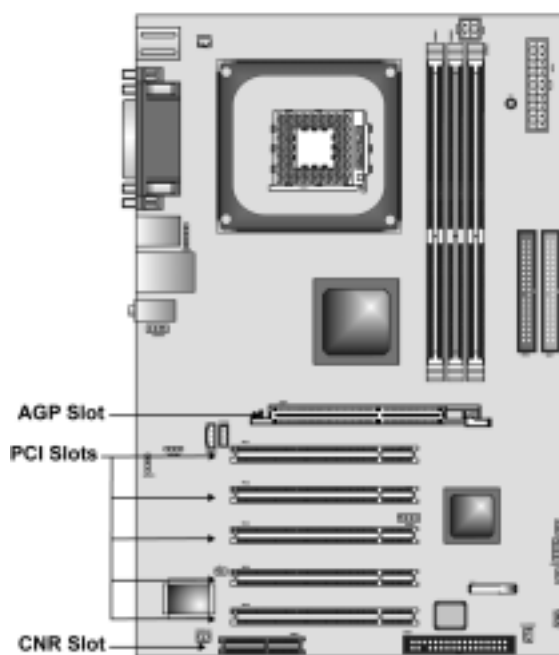

- PCI Slots** PCI slots are used to install expansion cards that have the 32-bit PCI interface.
- AGP Slot** The AGP slot is used to install a graphics adapter that supports the 8x AGP specification and has an 8x AGP edge connector.
- 
- Note:** The layout is for reference only. The AGP slot may be different from your mainboard. Please refer to actual shipment.
- 
- CNR Slot (optional)** This slot is used to insert CNR cards with Modem and Audio functionality.
- 
- Note:** Before installing an add-on card, check the documentation for the card carefully. If the card is not Plug and Play, you may have to manually configure the card before installation.
-

Follow these instructions to install an add-on card:

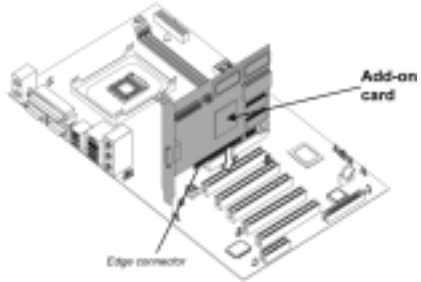
1. Remove a blanking plate from the system case corresponding to the slot you are going to use.	
2. Install the edge connector of the add-on card into the expansion slot. Ensure that the edge connector is correctly seated in the slot.	
3. Secure the metal bracket of the card to the system case with a screw.	

**Note:** For some add-on cards, for example graphics adapters and network adapters, you have to install drivers and software before you can begin using the add-on card.

## Connecting Optional Devices

Refer to the following for information on connecting the mainboard's optional devices:

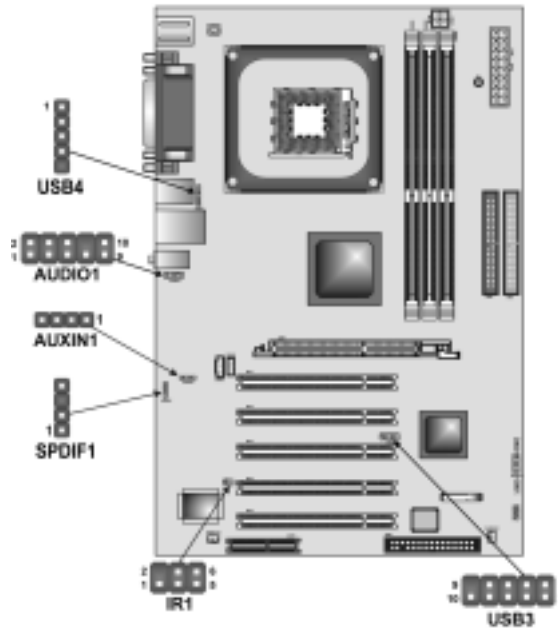

### AUDIO1: Front Panel Audio header

This header allows the user to install auxiliary front-oriented microphone and line-out ports for easier access.

Pin	Signal Name	Function
1	AUD_MIC	Front Panel Microphone input signal
2	AUD_GND	Ground used by Analog Audio Circuits
3	AUD_MIC_BIAS	Microphone Power
4	AUD_VCC	Filtered +5 V used by Analog Audio Circuits
5	AUD_FPOUT_R	Right Channel Audio signal to Front Panel
6	AUD_RET_R	Right Channel Audio signal to Return from Front Panel
7	HP_ON	Reserved for future use to control Headphone Amplifier
8	KEY	No Pin
9	AUD_FPOUT_L	Left Channel Audio signal to Front Panel
10	AUD_RET_L	Left Channel Audio signal Return from Front Panel

## USB3: Front panel USB connectors

The mainboard has four USB ports installed on the rear edge I/O port array. Additionally, some computer cases have USB ports at the front of the case. If you have this kind of case, use auxiliary USB connectors USB3 to connect the front-mounted ports to the mainboard.

Pin	Signal Name	Function
1	VREG_FP_USBPWR0	Front Panel USB Power
2	VREG_FP_USBPWR1	Front Panel USB Power
3	USB_FP_P0-	USB Port 0 Negative Signal
4	USB_FP_P1-	USB Port 1 Negative Signal
5	USB_FP_P0+	USB Port 0 Positive Signal
6	USB_FP_P1+	USB Port 1 Positive Signal
7	GND	Ground
8	GND	Ground
9	KEY	No pin
10	USB_FP_OC0	Overcurrent signal

**Note:** Please make sure that the USB cable has the same pin assignment as indicated above. A different pin assignment may cause damage or system hang-up.

## IR1: Infrared port

Infrared ports allow the wireless exchange of information between your computer and similarly equipped devices such as printers, laptops, Personal Digital Assistants (PDAs), and other computers.

Pin	Signal Name	Function
1	Not assigned	Not assigned
2	KEY	No pin
3	+5V	IR Power
4	GND	Ground
5	IRTX	IrDA serial output
6	IRRX	IrDA serial input

## SPDIF1: SPDIF out header (optional)

You can purchase an optional 24-bit digital audio extension bracket from a third-party vendor. You can use the audio RCA jacks to connect to digital audio devices. If your CD-ROM/DVD drive has digital audio output, you can connect it to the input pins of the SPDIF connector.

Pin	Signal Name	Function
1	SPDIF	SPDIF digital output
2	+5VA	5V analog power
3	NC	Not connected
4	GND	Ground

### AUXIN1: Extra line-in connector (optional)

This connector is an additional line-in audio connector. It allows you to attach a line-in cable when your rear line-in jack is set as line out port for 4-channel function.

Pin	Signal Name	Function
1	AUX_L	AUX In left channel
2	GND	Ground
3	GND	Ground
4	AUX_R	AUX In right channel

### USB4: USB Card Reader connector

This connector is for connecting internal USB card reader. You can use a card reader to read or transfer files and digital images to your computer.

Pin	Signal Name	Function
1	USBVCC2	+5V dual
2	USB2-	Data signal port 2-
3	USB2+	Data signal port 2+
4	GND	Ground
5	Key	No pin

**Note:** The USB4 is shared with one of the USB ports of the I/O back panel. The USB port is located beside the serial port connectors. See “Connecting I/O Devices” for more information.



Please check the pin assignment of the cable and the USB header on the mainboard. Make sure the pin assignment will match before plugging in. Any incorrect usage may cause unexpected damage to the system.

---

## Connecting I/O Devices

The backplane of the mainboard has the following I/O ports:

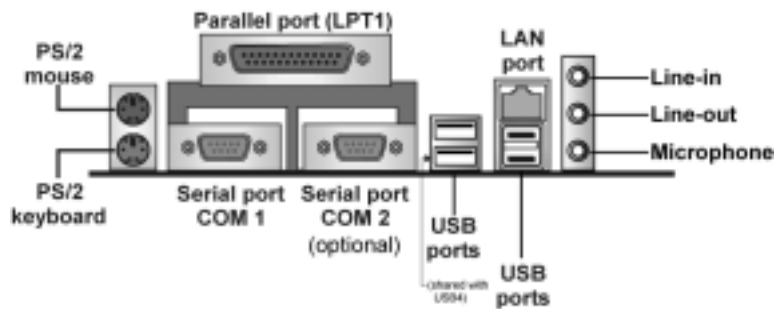

<b>PS/2 Mouse</b>	Use the upper PS/2 port to connect a PS/2 pointing device.
<b>PS/2 Keyboard</b>	Use the lower PS/2 port to connect a PS/2 keyboard.
<b>LPT1</b>	Use LPT1 to connect printers or other parallel communications devices.
<b>COM1/2</b>	Use the COM ports to connect serial devices such as mice or fax/modems. COM1 is identified by the system as COM1/3. COM2 is identified by the system as COM2/4.
<b>Audio Ports</b>	Use the three audio ports to connect audio devices. The first jack is for stereo line-in signal. The second jack is for stereo line-out signal. The third jack is for microphone.
<b>LAN Port (optional)</b>	Connect an RJ-45 jack to the LAN port to connect your computer to the Network.
<b>USB Ports</b>	Use the USB ports to connect USB devices.

---

**Note:** The USB port located below the 1394a port is shared with the USB4 connector.

---

## External Connector Color Coding

Many connectors now use standard colors as shown in the table below.

<b>Connector</b>	<b>Color</b>
Audio line-in	Light blue
Audio line-out	Lime
Digital monitor/flat panel	White
IEEE 1394	Grey
Microphone	Pink
MIDI/game	Gold
Parallel	Burgundy
PS/2-compatible keyboard	Purple
PS/2-compatible mouse	Green
Serial	Teal or Turquoise
Speaker out/subwoofer	Orange
Right-to-left speaker	Brown
USB	Black
Video out	Yellow
SCSI, network, telephone, modem	None

This concludes Chapter 2. The next chapter covers the BIOS.

## *Chapter 3*

# Using BIOS

---

### **About the Setup Utility**

The computer uses the latest Award BIOS with support for Windows Plug and Play. The CMOS chip on the mainboard contains the ROM setup instructions for configuring the mainboard BIOS.

The BIOS (Basic Input and Output System) Setup Utility displays the system's configuration status and provides you with options to set system parameters. The parameters are stored in battery-backed-up CMOS RAM that saves this information when the power is turned off. When the system is turned back on, the system is configured with the values you stored in CMOS.

The BIOS Setup Utility enables you to configure:

- Hard drives, diskette drives, and peripherals
- Video display type and display options
- Password protection from unauthorized use
- Power management features

The settings made in the Setup Utility affect how the computer performs. Before using the Setup Utility, ensure that you understand the Setup Utility options.

This chapter provides explanations for Setup Utility options.

### **The Standard Configuration**

A standard configuration has already been set in the Setup Utility. However, we recommend that you read this chapter in case you need to make any changes in the future.

This Setup Utility should be used:

- when changing the system configuration
- when a configuration error is detected and you are prompted to make changes to the Setup Utility
- when trying to resolve IRQ conflicts
- when making changes to the Power Management configuration
- when changing the password or making other changes to the Security Setup



## Entering the Setup Utility

When you power on the system, BIOS enters the Power-On Self Test (POST) routines. POST is a series of built-in diagnostics performed by the BIOS. After the POST routines are completed, the following message appears:

### **Press DEL to enter SETUP**

Pressing the delete key  accesses the BIOS Setup Utility:

Phoenix – AwardBIOS CMOS Setup Utility

▶ Standard CMOS Features	▶ Frequency/Voltage Control
▶ Advanced BIOS Features	Load Fail-Safe Defaults
▶ Advanced Chipset Features	Load Optimized Defaults
▶ Integrated Peripherals	Set Supervisor Password
▶ Power Management Setup	Set User Password
▶ PnP/PCI Configurations	Save & Exit Setup
▶ PC Health Status	Exit Without Saving
Esc : Quit	↑ ↓ → ← : Select Item
F10 : Save & Exit Setup	
Time, Date, Hard Disk Type . . .	

## BIOS Navigation Keys

The BIOS navigation keys are listed below:

Key	Function
Esc	Exits the current menu
←↑↓→	Scrolls through the items on a menu
+/-/PU/PD	Modifies the selected field's values
F10	Saves the current configuration and exits setup
F1	Displays a screen that describes all key functions
F5	Loads previously saved values to CMOS
F6	Loads a minimum configuration for troubleshooting.
F7	Loads an optimum set of values for peak performance

## Updating the BIOS

You can download and install updated BIOS for this mainboard from the manufacturer's Web site. New BIOS provides support for new peripherals, improvements in performance, or fixes for known bugs. Install new BIOS as follows:

1. If your mainboard has a BIOS protection jumper, change the setting to allow BIOS flashing.

2. If your mainboard has an item called Firmware Write Protect in Advanced BIOS features, disable it. (Firmware Write Protect prevents BIOS from being overwritten.)
3. Create a bootable system disk. (Refer to Windows online help for information on creating a bootable system disk.)
4. Download the Flash Utility and new BIOS file from the manufacturer's Web site. Copy these files to the system diskette you created in Step 3.
5. Turn off your computer and insert the system diskette in your computer's diskette drive. (You might need to run the Setup Utility and change the boot priority items on the Advanced BIOS Features Setup page, to force your computer to boot from the floppy diskette drive first.)
6. At the A:\ prompt, type the Flash Utility program name and press <Enter>. You see a screen similar to the following:

FLASH MEMORY WRITER V7.33	
(C) Award Software 1999 All Rights Reserved	
For (MAINBOARD NAME)	DATE: 10/26/2000
Flash Type	
File Name to Program :	<input type="text"/>
Error Message	

7. Type the filename of the new BIOS in the "File Name to Program" text box. Follow the onscreen directions to update the mainboard BIOS.
8. When the installation is complete, remove the floppy diskette from the diskette drive and restart your computer. If your mainboard has a Flash BIOS jumper, reset the jumper to protect the newly installed BIOS from being overwritten.

---

## Using BIOS

When you start the Setup Utility, the main menu appears. The main menu of the Setup Utility displays a list of the options that are available. A highlight indicates which option is currently selected. Use the cursor arrow keys to move the highlight to other options. When an option is highlighted, execute the option by pressing <Enter>.

Some options lead to pop-up dialog boxes that prompt you to verify that you wish to execute that option. Other options lead to dialog boxes that prompt you for information.

Some options (marked with a triangle ►) lead to submenus that enable you to change the values for the option. Use the cursor arrow keys to scroll through the items in the submenu.

In this manual, default values are enclosed in parenthesis. Submenu items are denoted by a triangle ►.

## Standard CMOS Features

This option displays basic information about your system.

Phoenix – AwardBIOS CMOS Setup Utility  
Standard CMOS Feature

Date (mm:dd:yy)	Tue, Jun 11 2002	Item Help
Time (hh:mm:ss)	15 : 6 : 23	
▶ IDE Primary Master		Menu Level ▶
▶ IDE Primary Slave	[None]	Change the day, month, year and century.
▶ IDE Secondary Master	[None]	
▶ IDE Secondary Slave		
Drive A	[1.44M, 3.5 in.]	
Drive B	[None]	
Floppy 3 Mode Support	[Disabled]	
Video	[EGA/VGA]	
Halt On	[All Errors]	
Base Memory	640K	
Extended Memory	65472K	
Total Memory	1024K	

↑↓→← : Move    Enter : Select    +/-/PU/PD:Value:    F10: Save    ESC: Exit    F1:General Help  
F5:Previous Values    F6:Fail-Safe Defaults    F7:Optimized Defaults

### Date and Time

The Date and Time items show the current date and time on the computer. If you are running a Windows OS, these items are automatically updated whenever you make changes to the Windows Date and Time Properties utility.

#### ▶ IDE Devices (None)

Your computer has two IDE channels (Primary and Secondary) and each channel can be installed with one or two devices (Master and Slave). Use these items to configure each device on the IDE channel.

Press <Enter> to display the IDE submenu:

Phoenix – AwardBIOS CMOS Setup Utility  
IDE Primary Master

IDE HDD Auto-Detection	[Press Enter]	Item Help
IDE Primary Master Access Mode	[Auto]	
Capacity	0 MB	Menu Level ▶▶
Cylinder	0	To auto-detect the HDD's size, head . . . on this channel
Head	0	
Precomp	0	
Landing Zone	0	
Sector	0	

↑↓→← : Move    Enter : Select    +/-/PU/PD:Value:    F10: Save    ESC: Exit    F1:General Help  
F5:Previous Values    F6:Fail-Safe Defaults    F7:Optimized Defaults

### **IDE HDD Auto-Detection**

Press <Enter> while this item is highlighted to prompt the Setup Utility to automatically detect and configure an IDE device on the IDE channel.

---

**Note:** If you are setting up a new hard disk drive that supports LBA mode, more than one line will appear in the parameter box. Choose the line that lists LBA for an LBA drive.

---

### **IDE Primary/Secondary Master/Slave**

Leave this item at Auto to enable the system to automatically detect and configure IDE devices on the channel. If it fails to find a device, change the value to Manual and then manually configure the drive by entering the characteristics of the drive in the items described below.

Refer to your drive's documentation or look on the drive casing if you need to obtain this information. If no device is installed, change the value to None.

---

**Note:** Before attempting to configure a hard disk drive, ensure that you have the configuration information supplied by the manufacturer of your hard drive. Incorrect settings can result in your system not recognizing the installed hard disk.

---

### **Access Mode**

This item defines ways that can be used to access IDE hard disks such as LBA (Large Block Addressing). Leave this value at Auto and the system will automatically decide the fastest way to access the hard disk drive.

Press <Esc> to return to the Standard CMOS Features page.

### **Drive A/Drive B (1.44M, 3.5 in./None)**

These items define the characteristics of any diskette drive attached to the system. You can connect one or two diskette drives.

### **Floppy 3 Mode Support (Disabled)**

Floppy 3 mode refers to a 3.5-inch diskette with a capacity of 1.2 MB. Floppy 3 mode is sometimes used in Japan.

### **Video (EGA/VGA)**

This item defines the video mode of the system. This mainboard has a built-in VGA graphics system; you must leave this item at the default value.

### **Halt On (All Errors)**

This item defines the operation of the system POST (Power On Self Test) routine. You can use this item to select which types of errors in the POST are sufficient to halt the system.

### **Base Memory, Extended Memory, and Total Memory**

These items are automatically detected by the system at start up time. These are display-only fields. You cannot make changes to these fields.

## Advanced BIOS Setup Option

This option defines advanced information about your system.

Phoenix – AwardBIOS CMOS Setup Utility  
Advanced BIOS Features

Anti-Virus Protection	[Disabled]		Item Help
CPU L1 & L2 Cache	[Enabled]		Menu Level ▶
CPU L2 Cache ECC Checking	[Enabled]		Allows you to choose the VIRUS warning feature for IDE Hard
Quick Power On Self Test	[Enabled]		Disk boot sector protection. If this function is enabled and someone attempts to write data into this area, BIOS will show a warning message on screen and alarm beep
First Boot Device	[Floppy]		
Second Boot Device	[HDD-0]		
Third Boot Device	[CDROM]		
Boot Other Device	[Enabled]		
Swap Floppy Drive	[Disabled]		
Boot Up Floppy Seek	[Disabled]		
Boot Up NumLock Status	[On]		
Gate A20 Option	[Fast]		
BIOS Write Protect	[Disabled]		
ATA 66/100 IDE Cable Msg.	[Disabled]		
Typematic Rate Setting	[Disabled]		
x Typematic Rate (Chars/Sec)	6		
x Typematic Delay (Msec)	250		
Security Option	[Setup]		
APIC Mode	[Enabled]		
OS Select For DRAM > 64MB	[Non-OS2]		
HDD S.M.A.R.T Capability	[Disabled]		

↑↓ : Move    ← : Select    +/ - /PU/PD: Value:    F10: Save    ESC: Exit    F1: General Help  
                                      F5: Previous Values    F6: Fail-Safe Defaults    F7: Optimized Defaults

### Anti-Virus Protection (Disabled)

When enabled, this item provides protection against viruses that try to write to the boot sector and partition table of your hard disk drive. You need to disable this item when installing an operating system. We recommend that you enable this item as soon as you have installed an operating system.

---

**Note:** For complete protection against viruses, install virus software in your operating system and update the virus definitions regularly.

---

### CPU L1 and L2 Cache (Enabled)

All processors that can be installed in this mainboard use internal level 1 (L1) and external level 2 (L2) cache memory to improve performance. Leave this item at the default value for better performance.

### CPU L2 Cache ECC Checking (Enabled)

This item allows you to enable or disable the CPU L2 Cache ECC Checking.

### Quick Power On Self Test (Enabled)

Enable this item to shorten the power on testing (POST) and have your system start up faster. You might like to enable this item after you are confident that your system hardware is operating smoothly.

### First/Second/Third Boot Device (Floppy/HDD-0/CDROM)

Use these three items to select the priority and order of the devices that your

system searches for an operating system at start-up time.

**Boot Other Device (Enabled)**

When enabled, the system searches all other possible locations for an operating system if it fails to find one in the devices specified under the First, Second, and Third boot devices.

**Swap Floppy Drive (Disabled)**

If you have two floppy diskette drives in your system, this item allows you to swap the assigned drive letters so that drive A becomes drive B, and drive B becomes drive A.

**Boot Up Floppy Seek (Disabled)**

If this item is enabled, it checks the size of the floppy disk drives at start-up time. You don't need to enable this item unless you have a legacy diskette drive with 360K capacity.

**Boot Up NumLock Status (On)**

This item defines if the keyboard Num Lock key is active when your system is started.

**Gate A20 Option (Fast)**

This item defines how the system handles legacy software that was written for an earlier generation of processors. Leave this item at the default value.

**BIOS Write Protect (Disabled)**

This item protects the BIOS from accidental corruption by unauthorized users or computer viruses. When set to disabled, the BIOS' data cannot be changed when attempting to update the BIOS with a Flash utility. If you want to update the BIOS, you need to set this item to enable.

**ATA 66/100 IDE Cable Msg. (Disabled)**

This item enables or disables the display of the ATA 66/100 Cable MSG.

**Typematic Rate Setting (Disabled)**

If this item is enabled, you can use the following two items to set the typematic rate and the typematic delay settings for your keyboard.

- **Typematic Rate (Chars/Sec):** Use this item to define how many characters per second are generated by a held-down key.
- **Typematic Delay (Msec):** Use this item to define how many milliseconds must elapse before a held-down key begins generating repeat characters.

**Security Option (Setup)**

If you have installed password protection, this item defines if the password is required at system start up, or if it is only required when a user tries to enter the Setup Utility.

**APIC Mode (Enabled)**

This item allows you to enable or disable the APIC (Advanced Programmable Interrupt Controller) mode. APIC provides symmetric multi-processing (SMP)

for systems, allowing support for up to 60 processors.

**OS Select For DRAM > 64 MB (Non-OS2)**

This item is only required if you have installed more than 64 MB of memory and you are running the OS/2 operating system. Otherwise, leave this item at the default.

**HDD S.M.A.R.T Capability (Disabled)**

The S.M.A.R.T. (Self-Monitoring, Analysis, and Reporting Technology) system is a diagnostics technology that monitors and predicts device performance. S.M.A.R.T. software resides on both the disk drive and the host computer.

The disk drive software monitors the internal performance of the motors, media, heads, and electronics of the drive. The host software monitors the overall reliability status of the drive. If a device failure is predicted, the host software, through the Client WORKS S.M.A.R.T applet, warns the user of the impending condition and advises appropriate action to protect the data.

**Report No FDD For WIN 95 (Yes)**

If you are running a system with no floppy drive and using Windows 95, select Yes for this item to ensure compatibility with the Windows 95 logo certification. Otherwise, select No.

**Video BIOS Shadow (Enabled)**

This item determines whether the BIOS will be copied to RAM for faster execution.

**Small Logo (EPA) Show (Disabled)**

Enables or disables the display of the EPA logo during boot.

## Advanced Chipset Features Option

These items define critical timing parameters of the mainboard. You should leave the items on this page at their default values unless you are very familiar with the technical specifications of your system hardware. If you change the values incorrectly, you may introduce fatal errors or recurring instability into your system.

### Phoenix – AwardBIOS CMOS Setup Utility Advanced Chipset Features

		Item Help
▶ DRAM Clock/Timing Control	[Press Enter]	
▶ AGP & P2P Bridge Control	[Press Enter]	
Prefetch Caching	[Disabled]	Menu Level ▶
System BIOS Cacheable	[Disabled]	
Video RAM Cacheable	[Disabled]	
Memory Hole at 15M-16M	[Disabled]	

↑↓→← : Move    Enter : Select    +/-/PU/PD:Value:    F10: Save    ESC: Exit    F1:General Help  
 F5:Previous Values    F6:Fail-Safe Defaults    F7:Optimized Defaults

### ▶ DRAM Clock/Timing Control

Scroll to this item and press <Enter> to view the following screen:

### Phoenix – AwardBIOS CMOS Setup Utility DRAM Clock/Timing Control

		Item Help
DRAM Timing Control	[By SPD]	
x DRAM CAS Latency	2.5T	Menu Level ▶
x RAS Active Time (tRAS)	6T	
x RAS Precharge Time (tRP)	3T	
x RAS to CAS Delay (tRCD)	3T	
DRAM Addr/Cmd Rate	[Auto Mode]	

↑↓→← : Move    Enter : Select    +/-/PU/PD:Value:    F10: Save    ESC: Exit    F1:General Help  
 F5:Previous Values    F6:Fail-Safe Defaults    F7:Optimized Defaults

### DRAM Timing Control (By SPD)

Enables you to select the CAS latency time in HCLKs of 2, 2.5, or 3. The value is set at the factory depending on the DRAM installed. Do not change the values in this field unless you change specifications of the installed DRAM or the installed CPU.

### DRAM CAS LATENCY (2.5T)

This item controls the timing delay (in clock cycles) before the DRAM starts a



read command after receiving it.

**RAS Active Time (tRAS) (6T)**

This item allows you to set the amount of time a RAS can be kept open for multiple accesses. High figures will improve performance.

**RAS Precharge Time (tRP) (3T)**

This is the duration of the time interval during which the Row Address Strobe signal to a DRAM is held low during normal Read and Write Cycles. This is the minimum interval between completing one read or write and starting another from the same (non-page mode) DRAM. Techniques such as memory interleaving, or use of Page Mode DRAM are often used to avoid this delay. Some chipsets require this parameter in order to set up the memory configuration properly. The RAS Precharge value is typically about the same as the RAM Access (data read/write) time.

**RAS to CAS Delay (tRCD) (3T)**

This is the amount of time a CAS is performed after a RAS. The lower the better, but some DRAM does not support low figures.

**DRAM Addr/Cmd Rate (AUTO)**

This option allows you to set the lead off DRAM read and write cycles. When set to Delay 1T, memory read/write commands are sent one clock cycle behind the memory address. When set to Normal, read/write and memory address commands are sent simultaneously.

Press <Esc> to return to the Advanced Chipset Features screen.

► **AGP & P2P Bridge Control**

Scroll to this item and press <Enter> to view the following screen:

Phoenix – AwardBIOS CMOS Setup Utility  
AGP & P2P Bridge Control

AGP Aperture Size	[128MB]	Item Help
Graphic Window WR Combin	[Enabled]	Menu Level ►

↑↓→← : Move    Enter : Select    +/-/PU/PD:Value:    F10: Save    ESC: Exit    F1:General Help  
                  F5:Previous Values    F6:Fail-Safe Defaults    F7:Optimized Defaults

**AGP Aperture Size**

This setting controls just how much system RAM can be allocated to AGP for video purposes. The aperture is a portion of the PCI memory address range dedicated to graphics memory address space. Host cycles that hit the aperture range are forwarded to the AGP without any translation.

**Graphic Window WR Combin**

This item determines whether the graphic windows base address is valid or not.

Press <Esc> to return to the Advanced Chipset Features screen.

**Prefetch Caching (Disabled)**

Enables PCI slave prefetch caching. Enabling this increased performance.

**System BIOS Cacheable (Disabled)**

When this item is enabled, the System BIOS will be cached for faster execution.

**Video RAM Cacheable (Disabled)**

When this is enabled, the Video RAM will be cached resulting to better performance. However, if any program was written to this memory area, this may result to system error.

**Memory Hole at 15M-16M (Disabled)**

When enabled, you can reserve an area of system memory for ISA adapter ROM. When this area is reserved, it cannot be cached. Refer to the user documentation of the peripheral you are installing for more information.

**Integrated Peripherals**

These options display items that define the operation of peripheral components on the system's input/output ports.

Phoenix – AwardBIOS CMOS Setup Utility  
Integrated Peripherals

▶ SIS OnChip IDE Device	[Press Enter]	Item Help
▶ SIS OnChip PCI Device	[Press Enter]	
▶ Onboard SuperI/O Device	[Press Enter]	Menu Level ▶
IDE HDD Block Mode	[Enabled]	
Init Display First	[PCI Slot]	
IDECH0 Access Interface	[EDB Bus]	
IDECH1 Access Interface	[EDB Bus]	
USB0 Access Interface	[EDB Bus]	
USB1 Access Interface	[EDB Bus]	
USB2 Access Interface	[EDB Bus]	
USB2.0 Access Interface	[EDB Bus]	
MAC Access Interface	[EDB Bus]	
Audio Access Interface	[EDB Bus]	

↑↓→← : Move Enter: Select +/-/PU/PD: Value: F10: Save ESC: Exit F1:General Help  
F5:Previous Values F6:Fail-Safe Defaults F7:Optimized Defaults

## ► SIS OnChip IDE Device

Scroll to this item and press <Enter> to view the following screen:

Phoenix – AwardBIOS CMOS Setup Utility  
SIS OnChip IDE Device

			Item Help
Internal PCI/IDE		[Both]	Menu Level ►►
IDE Primary Master	PIO	[Auto]	
IDE Primary Slave	PIO	[Auto]	
IDE Secondary Master	PIO	[Auto]	
IDE Secondary Slave	PIO	[Auto]	
Primary Master	UltraDMA	[Auto]	
Primary Slave	UltraDMA	[Auto]	
Secondary Master	UltraDMA	[Auto]	
Secondary Slave	UltraDMA	[Auto]	
IDE DMA transfer access		[Enabled]	
IDE Burst Mode		[Enabled]	

↑↓→← : Move    Enter: Select    +/-/PU/PD: Value:    F10: Save    ESC: Exit    F1:General Help  
                  F5:Previous Values    F6:Fail-Safe Defaults    F7:Optimized Defaults

### **Internal PCI/IDE (Both)**

Use these items to enable or disable the internal PCI IDE channels that are integrated on the mainboard.

### **IDE Primary/Secondary Master/Slave PIO (Auto)**

Each IDE channel supports a master device and a slave device. These four items let you assign the kind of PIO (Programmed Input/Output) was used by the IDE devices. Choose Auto to let the system auto detect which PIO mode is best, or select a PIO mode from 0-4.

### **IDE Primary/Secondary Master/Slave UltraDMA (Auto)**

Each IDE channel supports a master device and a slave device. This mainboard supports UltraDMA technology, which provides faster access to IDE devices.

If you install a device that supports UltraDMA, change the appropriate item on this list to Auto. You may have to install the UltraDMA driver supplied with this mainboard in order to use an UltraDMA device.

### **IDE DMA transfer access (Enabled)**

This item allows you to enabled the transfer access of the IDE DMA then burst onto the PCI bus and nonburstable transactions do not.

### **IDE Burst Mode (Enabled)**

This option, when enabled will instruct the system to send every write transaction to the write buffer. Burstable transactions then burst onto the PCI bus and nonburstable transactions do not.

Press <Esc> to return to the Integrated Peripherals screen.

### ► SIS OnChip PCI Device

Scroll to this item and press <Enter> to view the following screen:

Phoenix – AwardBIOS CMOS Setup Utility  
SIS OnChip PCI Device

SIS USB Controller	[Enabled]	Item Help
USB Ports Number	[6 Ports]	Menu Level ►►
USB 2.0 Support	[Enabled]	
USB Keyboard Support	[Disabled]	
SIS AC97 AUDIO	[Enabled]	
SIS S/W Modem	[Enabled]	
SIS 10/100M ETHERNET	[Enabled]	
Onboard LAN Boot ROM	[Disabled]	
SIS 1394 Controller	[Enabled]	

↑↓→← : Move    Enter : Select    +/-/PU/PD:Value:    F10: Save    ESC: Exit    F1:General Help  
F5:Previous Values    F6:Fail-Safe Defaults    F7:Optimized Defaults

#### **SIS USB Controller (Enabled)**

This item enables the USB controller. Leave this at the default “Enabled” if you want to connect USB devices to your computer.

#### **USB Ports Number (6 Ports)**

This item enables you to determine the number of USB ports.

#### **USB 2.0 Support (Enabled)**

Enable this item if your system supports USB 2.0

#### **USB Keyboard Support (Disabled)**

Enable this item if you plan to use a keyboard connected through the USB port in a legacy operating system (such as DOS) that does not support Plug and Play.

#### **SIS AC97 AUDIO (Enabled)**

This option allows you to control the onboard AC97 audio. Disable this item if you are going to install a PCI audio add-on card.

#### **SIS S/W Modem (Enabled)**

This option allows you to control the onboard S/W modem. Disable this item if you are going to install an external modem.

#### **SIS 10/100M ETHERNET (Enabled)**

This option allows you to control the onboard LAN.

#### **Onboard LAN Boot ROM (Disabled)**

Use this item to enable and disable the booting from the onboard LAN or a network add-in card with a remote boot ROM installed.

#### **SIS 1394 Controller (Enabled)**

This option allows you to control the onboard 1394 controller.

Press <Esc> to return to the Integrated Peripherals screen.

► **Onboard SuperIO Device**

Scroll to this item and press <Enter> to view the following screen:

Phoenix – AwardBIOS CMOS Setup Utility  
Onboard SuperIO Device

Onboard FDC Controller	[Enabled]	Item Help
Onboard Serial Port 1	[3F8/IRQ4]	Menu Level ►►
Onboard Serial Port 2	[2F8/IRQ3]	
UART Mode Select	[Normal]	
UR2 Duplex Mode	[Half]	
Onboard Parallel Port	[378/IRQ7]	
Parallel Port Mode	[ECP]	
ECP Mode Use DMA	[3]	

↑↓→← : Move    Enter: Select    +/-/PU/PD: Value:    F10: Save    ESC: Exit    F1:General Help  
                       F5:Previous Values                    F6:Fail-Safe Defaults                    F7:Optimized Defaults

**Onboard FDC Controller (Enabled)**

This option enables the onboard floppy disk drive controller.

**Onboard Serial Port 1 (3F8/IRQ4)**

This option is used to assign the I/O address and interrupt request (IRQ) for onboard serial port 1 (COM1).

**Onboard Serial Port 2 (2F8/IRQ3)**

This option is used to assign the I/O address and interrupt request (IRQ) for onboard serial port 2 (COM2).

**UART Mode Select (Normal)**

This field is available if the Onboard Serial Port 2 field is set to any option but Disabled. UART Mode Select enables you to select the infrared communication protocol-Normal (default), IrDA, or ASKIR. IrDA is an infrared communication protocol with a maximum baud rate up to 115.2K bps. ASKIR is Sharp's infrared communication protocol with a maximum baud rate up to 57.6K bps.

**UR2 Duplex Mode (Half)**

This field is available when UART 2 Mode is set to either ASKIR or IrDA. This item enables you to determine the infrared function of the onboard infrared chip. The options are Full and Half (default).

Full-duplex means that you can transmit and send information simultaneously. Half-duplex is the transmission of data in both directions, but only one direction at a time.

### **Onboard Parallel Port (378/IRQ7)**

This option is used to assign the I/O address and interrupt request (IRQ) for the onboard parallel port.

### **Parallel Port Mode (ECP)**

Enables you to set the data transfer protocol for your parallel port. There are four options: SPP (Standard Parallel Port), EPP (Enhanced Parallel Port), ECP (Extended Capabilities Port) and ECP+EPP.

SPP allows data output only. Extended Capabilities Port (ECP) and Enhanced Parallel Port (EPP) are bi-directional modes, allowing both data input and output. ECP and EPP modes are only supported with EPP- and ECP-aware peripherals.

### **ECP Mode Use DMA (3)**

When the onboard parallel port is set to ECP mode, the parallel port can use DMA 3 or DMA 1.

Press <Esc> to return to the Integrated Peripherals screen.

### **IDE HDD Block Mode (Enabled)**

Enable this field if your IDE hard drive supports block mode. Block mode enables BIOS to automatically detect the optimal number of block read and writes per sector that the drive can support. It also improves the speed of access to IDE devices.

### **Init Display First (PCI Slot)**

Use this item to specify whether your graphics adapter is installed in one of the PCI slots or is integrated on the mainboard.

### **IDECH0/IDECH1 Access Interface (EDB BUS)**

This item determines whether the IDE access interface is the PCI bus or the embedded bus.

### **USB0/USB1/USB2/USB2.0 Access Interface (EDB BUS)**

This option determines whether the USB0/USB1/USB2/USB2.0 access interface is the embedded bus or the PCI bus.

### **MAC Access Interface (EDB BUS)**

This option determines whether the MAC access interface is the embedded bus or a PCI bus.

### **Audio Access Interface (EDB BUS)**

This option determines whether the audio access interface is the embedded bus or a PCI bus.

## Power Management Setup Option

This option lets you control system power management. The system has various power-saving modes including powering down the hard disk, turning off the video, suspending to RAM, and software power down that allows the system to be automatically resumed by certain events.

### Power Management Timeouts

The power-saving modes can be controlled by timeouts. If the system is inactive for a time, the timeouts begin counting. If the inactivity continues so that the timeout period elapses, the system enters a power-saving mode. If any item in the list of Reload Global Timer Events is Enabled, then any activity on that item will reset the timeout counters to zero.

### Wake Up Calls

If the system is suspended, or has been powered down by software, it can be resumed by a wake up call that is generated by incoming traffic to a modem, a LAN card, a PCI card, or a fixed alarm on the system realtime clock.

Phoenix – AwardBIOS CMOS Setup Utility  
Power Management Setup

		Item Help
ACPI function	[Enabled]	
ACPI Suspend Type	[S1(POS)]	
Power Management	[User Define]	
Suspend Mode	[Disabled]	Menu Level ▶
Video Off Option	[Susp, Stby --> Off]	
Video Off Method	[DPMS Supported]	
Switch Function	[Break/Wake]	
MODEM Use IRQ	[Auto]	
Hot Key Function as	[Power Off]	
HDD Off After	[Disabled]	
Power Button Override	[Instant-Off]	
Power State Resume Control	[Always Off]	
▶ PM Wake Up Events	[Press Enter]	
Delay Prior to Thermal	[None]	

↑ ↓ → ← : Move    Enter: Select    +/-/PU/PD: Value:    F10: Save    ESC: Exit    F1:General Help  
F5:Previous Values    F6:Fail-Safe Defaults    F7:Optimized Defaults

### ACPI Function (Enabled)

This mainboard supports ACPI (Advanced Configuration and Power management Interface). Use this item to enable or disable the ACPI feature.

---

**Note:** ACPI is a power management specification that makes hardware status information available to the operating system. ACPI enables a PC to turn its peripherals on and off for improved power management. It also allows the PC to be turned on and off by external devices, so that mouse or keyboard activity wakes up the computer.

---

### **ACPI Suspend Type (S1(POS))**

Use this item to define how your system suspends. In the default, S1(POS), the suspend mode is equivalent to a software power down. If you select S3 (STR), the suspend mode is a suspend to RAM, i.e., the system shuts down with the exception of a refresh current to the system memory.

### **Power Management (User Define)**

This item acts like a master switch for the powersaving modes and hard disk timeouts. If this item is set to Max Saving, power-saving modes occur after a short timeout. If this item is set to Min Saving, power-saving modes occur after a longer time-out. If the item is set to User Define, you can insert your own timeouts for the power-saving modes. There are four options:

- User Define: allows you to customize all power saving timer features
- Max Saving: recommended setting for general use
- Min Saving: sets power saving at minimum values

### **Suspend Mode (Disabled)**

After the selected period of system inactivity, all devices except the CPU shut off.

### **Video Off Option (Susp, Stby --> Off)**

This option defines if the video is powered down when the system is put into suspend mode.

### **Video Off Method (DPMS Supported)**

This item defines how the video is powered down to save power. This item is set to DPMS (Display Power Management Software) by default.

### **Switch Function (Break/Wake)**

You can choose whether or not to permit your system or enter complete suspend mode. Suspend mode offers greater power savings, with a correspondingly longer with a correspondingly longer awakening period.

### **MODEM Use IRQ (Auto)**

If you want an incoming call on a modem to automatically resume the system from a power-saving mode, use this item to specify the interrupt request line (IRQ) that is used by the modem. You might have to connect the fax/modem to the mainboard Wake On Modem connector for this feature to work.

### **Hot Key Function As (Power Off)**

This option allows you to set the Hot Key functionality to one of the following states: Disable (turn off Hot Key functionality), Power Off, Suspend.

### **HDD Off After (Disabled)**

The IDE hard drive will spin down if it is not accessed within a specified length of time. Options are from 1 Min to 15 Min and Disable.

### **Power Button Override (Instant Off)**

Under ACPI (Advanced Configuration and Power management Interface) you can create a software power down. In a software power down, the system can be resumed by Wake Up Alarms. This item lets you install a software power



down that is controlled by the power button on your system. If the item is set to Instant-Off, then the power button causes a software power down. If the item is set to Delay 4 Sec. then you have to hold the power button down for four seconds to cause a software power down.

**Power State Resume Control (Always Off)**

This sets the power state after a shutdown due to an unexpected interrupt of AC power.

► **PM Wake Up Events**

Scroll to this item and press <Enter> to view the following screen:

Phoenix – AwardBIOS CMOS Setup Utility  
PM Wake Up Events

		Item Help
IRQ [3-7, 9-15], NMI	[Enabled]	
IRQ 8 Break Suspend	[Disabled]	
Ring/WOL/WOM PowerUp Control	[Disabled]	Menu Level ►
MACPME Power Up Control	[Enabled]	
PCIPME Power Up Control	[Enabled]	
PS2KB Wakeup from S3	[Hot Key]	
PS2MS Wakeup from S3	[Disabled]	
Power Up by Alarm	[Disabled]	
x Month Alarm	NA	
x Date (of Month)	0	
x Time (hh:mm:ss)	0 0 0	
** Reload Global Timer Events **		
Primary IDE	[Disabled]	
Secondary IDE	[Disabled]	
FDD, COM, LPT Port	[Disabled]	
PCI PIRQ[A-D]#	[Disabled]	

↑ ↓ → ← : Move    Enter : Select    +/-/PU/PD: Value:    F10: Save    ESC: Exit    F1: General Help  
F5: Previous Values    F6: Fail-Safe Defaults    F7: Optimized Defaults

This item opens a submenu that enables you to set events that will resume the system from a power saving mode.

**IRQ [3-7, 9-15], NMI (Enabled)**

This option determines whether any activity for IRQ 3-7/9-15 will cause the system to wake from a power saving mode.

**IRQ 8 Break Suspend (Disabled)**

Determines whether the system will monitor IRQ 8 activity and wake the system from a power saving mode when IRQ 8 is activated.

**Ring/WOL/WOM PowerUp Contl (Disabled)**

Use this item to enable LAN or modem activity to wakeup the system from a power saving mode.

**MACPME Power Up Control (Enabled)**

Use this item to enable MAC activity to wakeup the system from a power saving mode.

**PCIPME Power Up Control (Enabled)**

Use this item to enable PCI activity to wakeup the system from a power saving mode.

**PS2KB Wakeup from S3 (Hot Key)**

This option allows you to set hot key combination to turn on the system by keyboard.

**PS2MS Wakeup from S3 (Disabled)**

This option allows you to set the mouse action to turn on the system.

**Power Up by Alarm (Disabled)**

When set to Enabled, the following three fields become available: Month Alarm, Day of Month Alarm, and Time Alarm Upon arrival of the alarm time, it will instruct the system to wake up.

When set to 0 (zero) for the day of the month, the alarm will power on your system every day at the specified time.

**\*\* Reload Global Timer Events \*\***

These fields determine which events waken the system from power saving mode.

**Primary/Secondary IDE (Disabled)**

When this item is enabled, the system power will resume the system from a power saving mode if there is any activity on primary or secondary IDE channels 0 or 1.

**FDD, COM, LPT Port (Disabled)**

When this item is enabled, the system will restart the power-saving timeout counters when any activity is detected on the floppy disk drive, serial ports, or the parallel port.

**PCI PIRQ[A-D]# (Disabled)**

When this item is enabled, any activity from one of the listed devices wakes up the system.

Press <Esc> to return to the Power Management Setup screen.

**Delay Prior to Thermal (None)**

Enables you to set the delay time before the CPU enters auto thermal mode.

## PNP/PCI Configurations

These options configure how PnP (Plug and Play) and PCI expansion cards operate in your system. Both the ISA and PCI buses on the Mainboard use system IRQs (Interrupt ReQuests) and DMAs (Direct Memory Access). You must set up the IRQ and DMA assignments correctly through the PnP/PCI Configurations Setup utility for the mainboard to work properly. Selecting PnP/PCI Configurations on the main program screen displays this menu:

Phoenix - AwardBIOS CMOS Setup Utility  
PnP/PCI Configurations

Reset Configuration Data	[Disabled]	Item Help
Resources Controlled by	[Auto(ESCD)]	Menu Level ►
x IRQ Resources	Press Enter	Default is Disabled.
PCI/VGA Palette Snoop	[Disabled]	Select Enabled to reset
INT Pin 1 Assignment	[Auto]	Extended System
INT Pin 2 Assignment	[Auto]	Configuration Data (ESCD)
INT Pin 3 Assignment	[Auto]	when you exit Setup if you
INT Pin 4 Assignment	[Auto]	have installed a new add-
INT Pin 5 Assignment	[Auto]	on and the system
INT Pin 6 Assignment	[Auto]	reconfiguration has
INT Pin 7 Assignment	[Auto]	caused such a serious
INT Pin 8 Assignment	[Auto]	conflict that the OS cannot
		boot

↑↓→← : Move    Enter : Select    +/-/PU/PD:Value:    F10: Save    ESC: Exit    F1:General Help  
F5:Previous Values    F6:Fail-Safe Defaults    F7:Optimized Defaults

### Reset Configuration Data (Disabled)

If you enable this item and restart the system, any Plug and Play configuration data stored in the BIOS Setup is cleared from memory.

### Resources Controlled By (Auto(ESCD))

You should leave this item at the default Auto(ESCD). Under this setting, the system dynamically allocates resources to Plug and Play devices as they are required.

If you cannot get a legacy ISA (Industry Standard Architecture) expansion card to work properly, you might be able to solve the problem by changing this item to Manual, and then opening up the IRQ Resources submenu.

In the IRQ Resources submenu, if you assign an IRQ to Legacy ISA, then that Interrupt Request Line is reserved for a legacy ISA expansion card. Press <Esc> to close the IRQ Resources submenu.

### PCI/VGA Palette Snoop (Disabled)

This item is designed to overcome problems that can be caused by some non-standard VGA cards. This board includes a built-in VGA system that does not require palette snooping so you must leave this item disabled.

### INT Pin 1-8 Assignment (Auto)

Identifies the interrupt request (IRQ) line assigned to a device connected to

the PCI interface of your system.

## PC Health Status Option

On mainboards that support hardware monitoring, this item lets you monitor the parameters for critical voltages, critical temperatures, and fan speeds.

Phoenix – AwardBIOS CMOS Setup Utility  
PC Health Status

<b>Shutdown Temperature</b> <b>[Disabled]</b>	<b>Item Help</b>
CPU Core Voltage	<b>Menu Level</b> ▶
Vcc      1.8V	
Vcc      3.3V	
Vcc      5.0V	
+12V	
StandBy 3.3V	
StandBy 5.0V	
Voltage Battery	
CPU Temperature	
System Temperature	
CPU Fan Speed	
CHS Fan1 Speed	
BAK Fan1 Speed	

↑↓→← : Move    Enter: Select    +/-/PU/PD: Value:    F10: Save    ESC: Exit    F1:General Help  
                  F5:Previous Values    F6:Fail-Safe Defaults    F7:Optimized Defaults

### Shutdown Temperature

Enables you to set the maximum temperature the system can reach before powering down.

### System Component Characteristics

These fields provide you with information about the systems current operating status. You cannot make changes to these fields.

## Frequency/Voltage Control

This item enables you to set the clock speed and system bus for your system. The clock speed and system bus are determined by the kind of processor you have installed in your system.

CMOS Setup Utility – Copyright (C) 1984 – 2001 Award Software  
Frequency/Voltage Control

CPU Clock Ratio	[10 X]	Item Help
Auto Detect DIMM/PCI Clk	[Enabled]	
Spread Spectrum	[Enabled]	Menu Level ▶
▶ Over Clock Function	[Press Enter]	

↑↓→← : Move    Enter: Select    +/-/PU/PD: Value:    F10: Save    ESC: Exit    F1:General Help  
F5:Previous Values    F6:Fail-Safe Defaults    F7:Optimized Defaults

### CPU Clock Ratio (10 X)

Use the CPU Host/SDRAM/PCI Clock to set the frontside bus frequency for the installed processor (usually 133 MHz, 100 MHz or 66 MHz). Then use *CPU Clock Ratio Jumpless* to set a multiple. The multiple times the frontside bus must equal the core speed of the installed processor e.g., *3.5 (multiple) x 100 MHz (frontside bus) = 350 MHz (installed processor clock speed)*.

### Auto Detect DIMM/PCI Clk (Enabled)

When this item is enabled, BIOS will disable the clock signal of free DIMM and PCI slots.

### Spread Spectrum (Enabled)

If you enable spread spectrum, it can significantly reduce the EMI (Electro-Magnetic Interference) generated by the system.

## ► Over Clock Function

Scroll to this item and press <Enter> to view the following screen:

Phoenix – AwardBIOS CMOS Setup Utility  
Over Clock Function

		Item Help
CPU Frequency	[100]	
Over CPU Vcore Function	[Normal]	
Over DDR Vcc Function	[Normal]	
CPU: DRAM Frequency Ratio	[SPD]	Menu Level ►►
DRAM Frequency		

↑↓→← : Move    Enter : Select    +/-/PU/PD: Value: F10: Save    ESC: Exit    F1: General Help  
                  F5: Previous Values    F6: Fail-Safe Defaults    F7: Optimized Defaults

### CPU Frequency (Default)

Use the CPU Host Clock to set the frontside bus frequency for the installed processor (usually 133 MHz, 100 MHz or 66 MHz).

### CPU: DRAM Frequency Ratio (SPD)

This item controls the ratio of the CPU FSB clock and DRAM Frequency to enable the CPU and DRAM to run at different frequency combination.

## Load Fail-Safe Defaults Option

This option opens a dialog box that lets you install fail-safe defaults for all appropriate items in the Setup Utility:

Press <Y> and then <Enter> to install the defaults. Press <N> and then <Enter> to not install the defaults. The fail-safe defaults place no great demands on the system and are generally stable. If your system is not functioning correctly, try installing the fail-safe defaults as a first step in getting your system working properly again. If you only want to install fail-safe defaults for a specific option, select and display that option, and then press <F6>.

## Load Optimized Defaults Option

This option opens a dialog box that lets you install optimized defaults for all appropriate items in the Setup Utility. Press <Y> and then <Enter> to install the defaults. Press <N> and then <Enter> to not install the defaults. The optimized defaults place demands on the system that may be greater than the performance level of the components, such as the CPU and the memory. You can cause fatal errors or instability if you install the optimized defaults when

your hardware does not support them. If you only want to install setup defaults for a specific option, select and display that option, and then press <F7>.

## Set Supervisor/User Password

When this function is selected, the following message appears at the center of the screen to assist you in creating a password.

### ENTER PASSWORD

Type the password, up to eight characters, and press <Enter>. The password typed now will clear any previously entered password from CMOS memory. You will be asked to confirm the password. Type the password again and press <Enter>. You may also press <Esc> to abort the selection.

To disable password, just press <Enter> when you are prompted to enter password. A message will confirm the password being disabled. Once the password is disabled, the system will boot and you can enter BIOS Setup freely.

### PASSWORD DISABLED

If you have selected "**System**" in "Security Option" of "BIOS Features Setup" menu, you will be prompted for the password every time the system reboots or any time you try to enter BIOS Setup.

If you have selected "**Setup**" at "Security Option" from "BIOS Features Setup" menu, you will be prompted for the password only when you enter BIOS Setup.

Supervisor Password has higher priority than User Password. You can use Supervisor Password when booting the system or entering BIOS Setup to modify all settings. Also you can use User Password when booting the system or entering BIOS Setup but can not modify any setting if Supervisor Password is enabled.

## Save & Exit Setup Option

Highlight this item and press <Enter> to save the changes that you have made in the Setup Utility and exit the Setup Utility. When the Save and Exit dialog box appears, press <Y> to save and exit, or press <N> to return to the main menu:

## Exit Without Saving

Highlight this item and press <Enter> to discard any changes that you have made in the Setup Utility and exit the Setup Utility. When the Exit Without Saving dialog box appears, press <Y> to discard changes and exit, or press <N> to return to the main menu.

---

**Note:** If you have made settings that you do not want to save, use the "Exit Without Saving" item and press <Y> to discard any changes you have made.

---

This concludes Chapter 3. Refer to the next chapter for information on the software supplied with the mainboard.

## Using the Mainboard Software

---

### About the Software CD-ROM

The support software CD-ROM that is included in the mainboard package contains all the drivers and utility programs needed to properly run the bundled products. Below you can find a brief description of each software program, and the location for your mainboard version. More information on some programs is available in a README file, located in the same directory as the software.

---

**Note:** Never try to install software from a folder that is not specified for use with your mainboard.

---

Before installing any software, always inspect the folder for files named README.TXT, INSTALL.TXT, or something similar. These files may contain important information that is not included in this manual.

---

### Auto-installing under Windows 98/ME/2000/XP

The Auto-install CD-ROM makes it easy for you to install the drivers and software for your mainboard.

---

**Note:** If the Auto-install CD-ROM does not work on your system, you can still install drivers through the file manager for your OS (for example, Windows Explorer). Refer to Utility Folder Installation Notes later in this chapter.

---

The support software CD-ROM disc loads automatically under Windows 98/ME/2000/XP. When you insert the CD-ROM disc in the CD-ROM drive, the autorun feature will automatically bring up the install screen. The screen has three buttons on it, Setup, Browse CD and Exit.





---

**Note:** If the opening screen doesn't appear, double-click the file "setup.exe" in the root directory.

---

## Setup Tab

<b>Setup</b>	Click the <b>Setup</b> button to run the software installation program. Select from the menu which software you want to install.
<b>Browse CD</b>	<p>The <b>Browse CD</b> button is the standard Windows command that allows you to open Windows Explorer and show the contents of the support CD.</p> <p>Before installing the software from Windows Explorer, look for a file named README.TXT, INSTALL.TXT or something similar. This file may contain important information to help you install the software correctly.</p> <p>Some software is installed in separate folders for different operating systems, such as DOS, WIN NT, or WIN98/95. Always go to the correct folder for the kind of OS you are using.</p> <p>To install the software, execute a file named SETUP.EXE or INSTALL.EXE by double-clicking the file and then following the instructions on the screen.</p>
<b>Exit</b>	The <b>Exit</b> button closes the Auto Setup window.

## Application Tab

Lists the software utilities that are available on the CD.

## Read Me Tab

Displays the path for all software and drivers available on the CD.

## Running Setup

Follow these instructions to install device drivers and software for the mainboard:

1. Click **Setup**. The installation program begins:



**Note:** The following screens are examples only. The screens and driver lists will be different according to the mainboard you are installing.

The mainboard identification is located in the upper left-hand corner.

2. Click **Next**. The following screen appears:

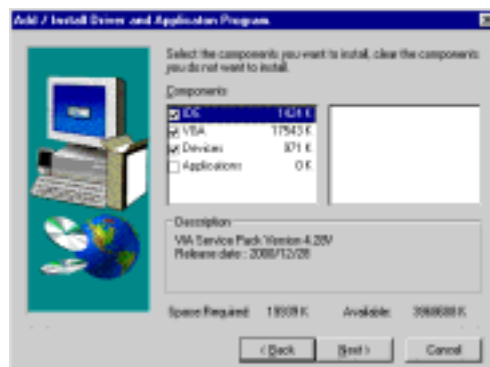

3. Check the box next to the items you want to install. The default options are recommended.
4. Click **Next** run the Installation Wizard. An item installation screen appears:



5. Follow the instructions on the screen to install the items.

Drivers and software are automatically installed in sequence. Follow the onscreen instructions, confirm commands and allow the computer to restart a few times to complete the installation.

---

## Manual Installation

Insert the CD in the CD-ROM drive and locate the PATH.DOC file in the root directory. This file contains the information needed to locate the drivers for your mainboard.

Look for the chipset and mainboard model; then browse to the directory and path to begin installing the drivers. Most drivers have a setup program (SETUP.EXE) that automatically detects your operating system before installation. Other drivers have the setup program located in the operating system subfolder.

If the driver you want to install does not have a setup program, browse to the operating system subfolder and locate the readme text file (README.TXT or README.DOC) for information on installing the driver or software for your operating system.

---

## Utility Software Reference

All the utility software available from this page is Windows compliant. They are provided only for the convenience of the customer. The following software is furnished under license and may only be used or copied in accordance with the terms of the license.

---

**Note:** These software(s) are subject to change at anytime without prior notice. Please refer to the support CD for available software.

---

## **AWARD Flash Memory Utility**

This utility lets you erase the system BIOS stored on a Flash Memory chip on the mainboard, and lets you copy an updated version of the BIOS to the chip. Proceed with caution when using this program. If you erase the current BIOS and fail to write a new BIOS, or write a new BIOS that is incorrect, your system will malfunction. Refer to Chapter 3, *Using BIOS* for more information.

## **WinFlash Utility**

The Award WinFlash utility is a Windows version of the DOS Award BIOS flash writer utility. The utility enables you to flash the system BIOS stored on a Flash Memory chip on the mainboard while in a Windows environment. This utility is currently available for WINXP\ME\2000\98SE. To install the WinFlash utility, run WINFLASH.EXE from the following directory:

UTILITY\WINFLASH 1.51

## **PC-CILLIN 2002**

The PC-CILLIN 2002 software program provides anti-virus protection for your system. This program is available for Windows 2000/ME/98SE/XP and Windows NT. Be sure to check the readme.txt and install the appropriate anti-virus software for your operating system.

We strongly recommend users to install this free anti-virus software to help protect your system against viruses.

## **MediaRing Talk – Telephony Software**

To install the MediaRing Talk voice modem software for the built-in modem, go to the directory \UTILITY\MEDIARING TALK, then run MRTALK-SETUP72.EXE to install the application software.

## **Super Voice – Fax/Modem Software**

To install the Super Voice voice, fax, data communication application for use with the built-in fax/modem, go the directory \UTILITY\SUPER\_VOICE, then run PICSHELL.EXE to install the application software.

## **PageABC**

The PageABC application software enables you to create your very own home page. To install the PageABC, go to the directory \UTILITYPageABC, and then run SETUP.EXE to install the application software.

This concludes Chapter 4.