

KTAPRO
(VIA VT8363A (KT133A) Chipset)
ATX Form Factor
Main Board
User's Manual
(Ver.:1.0)

Copyright

Copyright© 2001 by this company. No part of this document may be reproduced, transmitted, transcribed, stored in a retrieval system, or translated into any language or computer language, in any form or by any means without prior written permission. This manual and the information contained herein are protected by copyright. All rights reserved.

Copyright 2001. All Rights Reserved.

Revision History

Revision	Date	Release Notes	Ref.NO
1.0	Mar-2001	First Official Release	3053330

Warning and Disclaimer

This manual is designed to provide information about the AMD[®] Athlon[™] processor main board. Every effort has been made to make this manual as accurate as possible, but no warranty or fitness is implied. All the information is provided on an 'as is' basis. The author and his corresponding publishing company shall have neither liability nor responsibility to any person or entity with respect to any loss or damages arising from the information contained in this manual or from the use of the system board that accompanies it.

Information contained in this manual is subject to change without notice. The manufacturer of the system board will not be held responsible for technical or editorial omissions made herein, nor for the incidental or consequential damages resulting from its furnishing, performance, functionality or use. Subsequent changes to this manual will be incorporated into the next edition. We welcome any suggestion regarding this manual or our computer products.

Trademarks

- IBM[®] is a registered trademark of International Business Machines
- Microsoft[®] is a registered trademark of Microsoft[®] Corporation.
- PCI[®] is a registered trademark of PCI Special Interest Groups.
- AWARD[®] is a registered trademark of Award Software Inc.

All other trademarks are the property of their respective owners.

Table of Contents

Chapter 1	Introduction.....	3
1-1	Main Specifications.....	4
1-2	Other Features.....	6
1-3	Package Contents.....	7
 C h a p t e r 2		
I n s t a l l a t i o n		8
2-1	Mainboard Overview.....	8
2-1-1	Short Description of Main Sockets and Connectors.....	9
2-2	CPU Installation.....	10
2-2-1	CPU Frequency setting.....	13
2-2-2	CPU and System Cooling.....	17
	Fan Headers.....	17
2-3	Memory.....	19
2-3-1	Memory Installation 1.....	20
2-4	PCI and ISA.....	22
2-4-1	Wake On Lan Header.....	23
2-4-2	Wake On Modem Header.....	23
2-4-3	IO Voltage Selection.....	24
2-5	AGP Slot.....	25
2-6	Interrupts.....	27
2-7	On Board Audio.....	31
2-7-1	Backpanel Audio Connectors.....	31
2-7-2	Onboard Audio Connectors.....	31
2-8	AMR (Audio Modem Riser)	32
2-9	Back Panel Connectors.....	33
2-9-1	PS/2 Mouse and Keyboard.....	33
2-9-2	USB.....	34
2-9-3	Serial Ports.....	34
2-9-4	Parallel Port.....	35
2-10	IrDA(Infrared Remote Link)	35
2-11	IDE1 and IDE2	36
2-12	FDD1(Floppy Disk)	37
2-13	PWR1(ATX Power Supply)	38
2-14	Front Panel Connectors.....	39
Chapter 3	Software Installation.....	41
3-1	Driver Installation.....	41
3-2	Registry Error When Installing The VIA 4-IN-1 Drivers.....	42

Chapter 4	The BIOS.....	43
4-1	Updating the BIOS.....	44
4-2	T h C M O S Memory.....	45
4-3	The BIOS Setup Pages.....	47
4-3-1	Standard CMOS Setup.....	50
4-3-2	Advanced BIOS Features.....	54
4-3-3	Advanced Chipset Features.....	59
4-3-4	Integrated Peripherals.....	64
4-3-5	Power Management Setup.....	69
4-3-6	PNP/PCI Configuration Setup.....	74
4-3-7	PC Health Status.....	76
4-3-8	Frequency/Voltage Control.....	77
4-3-9	Passwords.....	79
Chapter 5	Frequently Asked Questions.....	81
5-1	Boot Issues.....	81
5-2	System Cooling.....	83
5-2-1	Suitable Socket a CPU Coolers.....	84
5-2-2	Video Issues.....	86
5-3	Memory Issues.....	87
Chapter 6	Appendix.....	89

Important Warnings:



WARNING: NEVER run the processor without the heatsink properly and firmly attached. This will damage the processor within SECONDS. Also do NOT try to use Pentium Heatsinks, these will NOT fit and do NOT provide adequate cooling.



WARNING: Make sure your power supply can deliver the power your system needs. We recommend AT LEAST a 250W power supply. Even better, get a 300W power supply, especially when using many peripherals.

Chapter 1 Introduction

Thank you for purchasing this high quality Motherboard, we are confident that you will be able to use this motherboard to your full satisfaction. This manual is divided into 6 main sections, as described below:

Introduction

The introduction contains information on the main specifications for this motherboard, the package contents and cautionary notes.

Hardware Installation

The Hardware Installation section is the most important in the manual. It describes in detail how to set the motherboard up for operation. Read all information and follow all steps, especially if you are a new user.

Software Installation

The software section describes the drivers that need be installed to make your OS operate properly. The drivers are provided on the driver CD.

BIOS Setup

Information on how to enter the BIOS setup and change settings is given here. In addition all individual BIOS items are described. Although some BIOS setting information is given in the hardware installation section where appropriate, refer to the BIOS Setup Section for details.

Trouble Shooting

In the case you run into trouble using your motherboard, this section will provide you with much information and practical tips to help you solve your problem. Some of the tips are also given in the Hardware and Software Installation Sections where relevant.

Appendix

Provides useful information

1-1 Main Specifications

■ Supported CPUs

Can support the least Socket A-based AMD™ Athlon XP, Athlon & Duron CPUs.

Athlon™ XP (1200+, 1300+, 1400+, 1500+, 1600+, 1700+, 1800+)

Athlon™ (600, 650, 700, 750, 800, 850, 900, 950, 1000, 1100, 1200, 1300, 1400MHz)

Duron™ (700, 750, 800, 800, 850, 900, 950, 1000, 1100MHz)

■ Chipset Northbridge

The VIA™ VT8363A (VIA Apollo KT133A) system controller supports a 200/266 MHz Front Side Bus (FSB); up to 1.5GB of PC133/PC100 SDRAM / VC 133 Virtual Channel Memory (VCM) SDRAM; The KTAPRO complies with AGP 2.0 specifications for 4X, 2X, and 1X AGP modes and PCI 2.2. bus interface with support for 5 PCI masters. It was designed especially to deliver enhanced AMD Athlon™ / Duron™ processor system performance.

■ Chipset Southbridge

The VIA VT82C686B PCI Super-I/O Integrated Peripheral Controller (PSIPC) supports UltraDMA/100, which allows burst mode data transfer rates of up to 100MB/sec; AC97 audio (Using the on-board VIA 1611A Audio Codec); USB controller with root hub and four function ports.

■ Memory

This motherboard comes equipped with three Dual Inline Memory Module (DIMM) sockets to support Intel PC133/PC100-compliant (64, 128, 256, or 512MB) DIMM modules up to 1.5GB. In addition NECs VC133-compliant Virtual Channel (VC) SDRAM is also supported. (VC SDRAM is a new DRAM architecture that greatly improves the system memory ability to service high multimedia requirements.)

■ PCI Expansion Slots

With five 32-bit PCI (Rev. 2.2) expansion slots, which can support Bus Master PCI cards, such as LAN or Video-grabber cards (PCI supports up to 133MB/s maximum throughput), this motherboard is ready for the most demanding applications.

■ ISA Expansion Slot

With one 16-bit ISA expansion slot, which can accept plug-in boards that control the sound, and other peripherals.

- **AGP Slot**

This motherboard comes with an **AGP Pro Slot with** Support for AGP/AGP Pro cards for high performance. The AGP 133MHz 4X mode is supported as well, further increasing system performance.

- **AMR Slot**

An Audio Modem Riser (AMR) slot also is supported, a very affordable audio and/or modem riser card can be used in combination with this slot.

- **USB interface**

With support for up to 4 USB ports, two on the back panel and two on-board, this motherboard provides ample USB expansion room.

- **IDE interface**

This motherboard comes with an onboard PCI Bus Master IDE controller with two connectors that support four ATA66/33 devices on two channels (ATA100 is also supported for this motherboard that come with the 686B southbridge). Supports UDMA/66, UDMA/33, PIO Modes 3 & 4 and Bus Master IDE DMA Mode 2, and Enhanced IDE devices, such as CD-R/ RW, DVD-ROM, CD-ROM, Tape Backup and LS-120 drives.

- **Super Multi-I/O**

This functionality is integrated into the southbridge of the chipset. It provides two high-speed UART compatible serial ports and one parallel port with EPP and ECP capabilities.

- **Infrared (IrDA) Connector**

This functionality is also integrated into the southbridge of the chipset. The IrDA connector supports an optional IR remote control device for wireless interfacing with external peripherals, personal gadgets, or an optional remote controller.

1-2 Other Features

■ Wake-On-LAN and Wake-On-Modem

These 3 pin connectors allow the motherboard to wake up on network (WOL) or Modem (WOM) activity.

■ PC Status Monitoring

This functionality provides a reliable way to examine and manage system status information, such as CPU and system voltages, temperatures, and fan speed. This information is available in the BIOS or through the VIA Hardware Monitor Software.

System BIOS

This motherboard comes with a 2MB BIOS that provides CPU/ SDRAM frequency and CPU Vcore adjustments, boot block write protection, and HD/ SCSI/ CD/ Floppy boot selection. DMI is also supported through BIOS, which allows hardware to communicate within a standard protocol creating a higher level of compatibility.

Color-coded Connectors

The Back-panel connectors of this motherboard are all color coded. This allows the user to easily locate certain connectors.

1-3 Package Contents

- ➔ This Motherboard
- ➔ 1 Manual
- ➔ 1 Driver Installation CD-ROM
- ➔ 1 IDE ATA 66/100 Flat-Cable
- ➔ 1 Floppy Disk Drive Flat-Cable



Please verify that all items listed above are included in your motherboard package. If one of the items is missing, please contact the dealer where you bought your motherboard.

Chapter 2 Hardware Installation

2-1 Mainboard overview

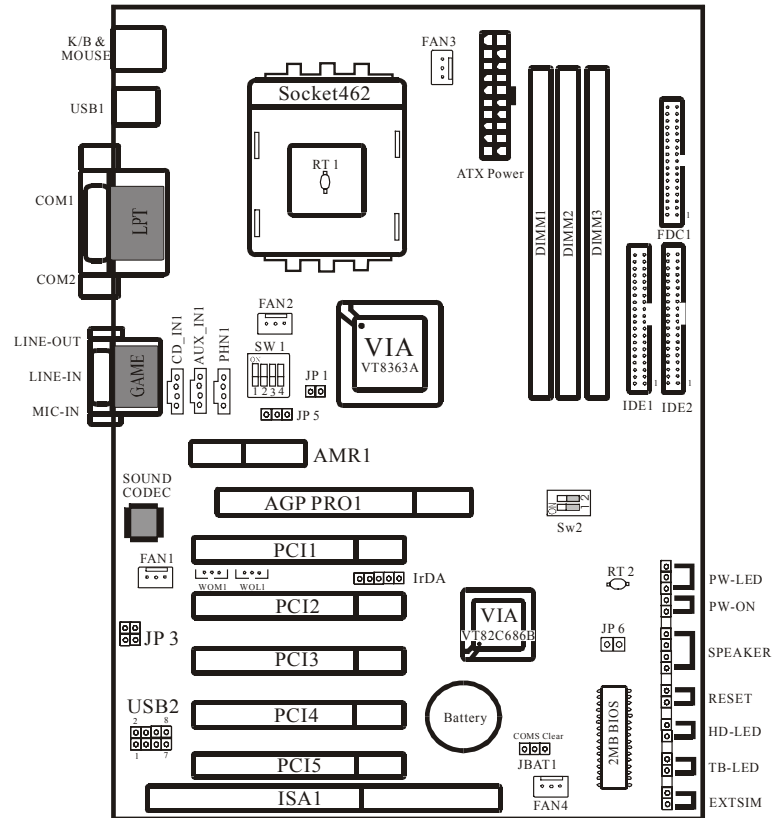

2-1-1 Short description of main sockets and connectors

- **Socket 462 (CPU Socket)**

Insert your Athlon or Duron CPU into this socket. See the description in the CPU Installation section below for more information.

- **DIMM 1,2,3**

These are the memory module slots. Please refer to the Memory Installation section.

- **IDE 1,2**

Insert the IDE cable from your HDD/CD-ROM devices to these connectors.

- **ATX power**

The power cable coming from your ATX power supply must be inserted to this connector.

- **AGP Pro Slot**

Insert an AGP or AGP Pro video card into this slot.

- **PCI Slots**

For expansion PCI Cards (Network, Modem, SCSI, etc).

- **ISA slot**

For expansion ISA cards (Sound card, etc)

- **AMR Slot**

A Modem Riser card can be inserted into this slot.

Other components and jumper settings will be described in the respective sections that follow.

2-2 CPU Installation

The first step in the installation of your CPU is the insertion of the CPU into the 462-pin CPU socket. Please follow the steps as outlined below carefully to avoid damage to the CPU.

Avoid Static Electricity

The AMD Athlon and AMD Duron processors and your motherboard contain sensitive electronic components that can be easily damaged by static electricity. We recommend that you leave the processor in its original packaging until you are ready to install it. You should only touch the edges of the processor, NEVER touch the processor pins to avoid static discharge.

First take a moment to inspect your CPU for obvious damage due to shipping or handling. Be sure that no noticeable damage exists before proceeding. You should have the following items:

- 1 AMD Athlon or AMD Duron processor.
- 1 good heatsink and fan assembly.

Step 1

The following figure shows the processor socket. Note that the release lever on the right side of the socket is down and latched. This position is used to lock the processor in place. The lever must be raised to install the processor. To do this, first push the lever sideways to unlatch it, then raise it all the way up (approximately 90 degrees).

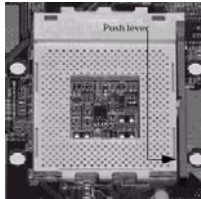

Step 2

The processor pin array at the top two corners is angled and has no pins in the corners. Notice that at the top of the socket on the motherboard (near where it says "Socket 462") the corners also do not have positions for pins. The processor must be positioned so the pins match up properly. When you do that, the corner of processor that is cut off will be positioned next to the release pivot.

It should take no force to install the processor, this is a zero insertion force (ZIF) socket. If it takes any force you are doing something wrong. Check the pin alignment and also make sure the release lever is raised up completely. After placing the CPU lower the release lever to lock the processor in place.

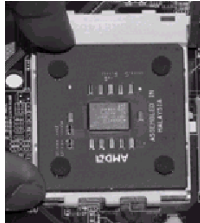

Now with the processor properly installed, you can proceed to install the heatsink. It is important to note that if you have never installed a heatsink on an AMD Athlon or AMD Duron processor before it may be difficult. We recommend you do a dry run a few times before doing the final installation. To allow you to do this read the following instructions. Do not remove the film on the thermally conductive compound until you are ready to do the final installation.



WARNING: Never run the processor without the heatsink properly and firmly attached.

Step3

The picture below shows the bottom of the heatsink. Notice the step in the heatsink surface, this portion fits over the top of the socket, where the legend "Socket 462" is molded into the plastic. The heatsink must be mounted with this step above the top of the socket or the heatsink will not be touching the processor properly.



The next picture shows the removal of the plastic film from the thermally conductive compound. The thermal compound is a thin layer of material that increases the efficiency of the heatsink by filling microscopic surface voids in the processor or heatsink surface with a thermally conductive material. Please do not remove the plastic film until you have practiced installing the heatsink and mounting the clips on the socket. It can take a few tries to get used to doing this.



The following picture shows a side view of the heatsink with the retaining clip at the bottom of the heatsink. Make sure this retaining clip is at the bottom of the heatsink before trying to install it.



The following picture shows the non-moveable end of the heatsink retaining clip installed on the lug at the bottom of the processor socket. This end of the clip simply slides over the lug when you tilt the heatsink / fan assembly towards the lug.

Now lock the locking clip for the retaining strap over the lug at the other (pivot end) of the processor socket. This is an easy procedure after you do it a few times, but initially it will require you to use a finger on one hand to push the latch down and use your other hand to push the latch in. This is the part you need to practice to install the clip properly. When you are holding the heatsink, make sure you do apply pressure to the fan. You could damage it and cause thermal failure of the processor.



WARNING: Be careful not to scrape the motherboard during the mounting of the fan or else damage may occur to the motherboard.

Now connect the wire from the heatsink fan to the FAN 3 connector on the motherboard. This connector is keyed and can only be installed one way. If you use a heatsink assembly that has two cooling fans, connect one to FAN 3 and the other to FAN 2. For more information on the FAN connectors, refer to the FAN connector section later in this section.

2-2-1 CPU Frequency settings

The frequency the CPU runs at internally depends on the FSB (Front Side Bus) Frequency that is provided to it and the multiplier setting. As example, a 800MHz CPU would run at 100MHz with a multiplier setting of 8x.



Frequency

The KTAPRO motherboard allows for setting of the frequency through the BIOS. To change the CPU frequency, go to the *Voltage / Frequency Control* page in the BIOS setup, the *CPU Host / PCI Clock* item will allow you select the CPU frequency. This is explained in more detail in the BIOS section.

Multiplier

















The KTAPRO motherboard allows you use the default CPU multiplier. This can be selected through JP1. If JP1 is open, the default CPU multiplier (recommended) is used by the motherboard, if JP1 is closed, the multiplier set by SW1 is used.

JP1: Multiplier Source Select:

	CPU Default	
JP1 Setting		



Closing JP1 allows setting of the multiplier through SW1, refer to the table below:

SW1: Multiplier Override

SW1	Ratio	SW1	Ratio	SW1	Ratio	SW1	Ratio
	5		7		9		11
	5.5		7.5		9.5		11.5
	6		8		10		12
	6.5		8.5		10.5		12.5

You need to close JP1 only in case you plan to run the CPU at a frequency higher than it was specified for (known as overclocking). Note however that we do not guarantee proper functioning of your system if you overclock your CPU. In case of overclocking the fan becomes even more important, since the higher frequency causes the CPU to generate more heat.

SW2:External Frequency Selection

CPU	1	2	
100MHz	ON	ON	
133MHz	OFF	OFF	

This potion tells the clock generator what frequency to send to the CPU, DRAM and the PCI bus. This allows the selection of the CPU’s External Frequency(or Bus Clock). The Bus Clock multiplied by the Frequency Multiple equals the CPU’s Internal frequency (the advertified cpu speed).



WARNING:Frequencies other them the recommended CPU bus frequencies are not guaranteed to be stable!

The following list contains the standard settings for the AMD Athlon and Duron CPUs known at time of publication:

CPU Name	Multiplier	Bus Frequency
Athlon 1.2GHz	12.0x	100MHz
Athlon 1.2GHz	9.0x	133MHz
Athlon 1.13GHz	8.5x	133MHz
Athlon 1GHz	7.5x	133MHz
Athlon 1GHz	10.0x	100MHz
Athlon 950MHz	9.5x	100MHz
Athlon 900MHz	9.0x	100MHz
Athlon 850MHz	8.5x	100MHz
Athlon 800MHz	8.0x	100MHz
Athlon 750MHz	7.5x	100MHz
Athlon 700MHz	7.0x	100MHz
Athlon 650MHz	6.5x	100MHz
Athlon 600MHz	6.0x	100MHz
Duron 700MHz	7.0x	100MHz
Duron 650MHz	6.5x	100MHz
Duron 600MHz	6.0x	100MHz



CPU Technical Background

The CPU socket on your KTAPRO motherboard is known as Socket A. This name was given to it by AMD, it supports both the Duron™ and the AMD Athlon™ processors.

Athlon CPU

There are several types of Athlon CPUs, Model 1, 2 and 4. The principal difference between the earlier Athlon Model 1 and Model 2 processors and the model 4 is the use of 256kB on-die cache, rather than 512kB of off-die cache. This allows the cache to run at the clockspeed of the processor, rather than at a fraction (1/3, 2/5, 1/2) as in the earlier Athlons. This constraint is the principal performance limit for the higher speed Athlon Model 2 processors. The use of on-die cache also allows the CPU to use a 0.05V lower core voltage and a corresponding reduction in power consumption of approximately 10-20%. This reduces the temperature of the processor.

There are two model 4 socket A CPUs, one using copper interconnects and the other aluminium. The former is coloured blue and the latter green. The copper-based Athlon CPUs run cooler than the aluminium versions.

Duron CPU

The Duron is AMD's low cost processor. It is very similar to the Athlon, using the same Socket A interface. The principal difference between the Athlon and the Duron is in the amount of full speed on-die L2 cache (64k rather than 256k) and a core voltage of 1.5v rather than 1.7v to 1.8v, meaning a lower power consumption of just 22W. According to tests it runs at about 90% of the performance of an Athlon of the same clock frequency and at about 92-99% of the performance of an Athlon Model 1 or 2 of the same clock frequency. It easily beats the same clock speed Intel Celeron processor and often out-classes even the Pentium-III of the same specification.

The following gives a technical summary of the main CPU features:

System Bus: The processor system bus is the first x86 platform bus running at or above 200MHz. At present, AMD Athlon processors are available with 266MHz and 200MHz system buses. As one of the fastest x86 processor buses currently available, the design delivers as high as 100 percent more peak bandwidth than any x86 system bus.

Floating Point Engine: The AMD Athlon processor includes the first fully pipelined, superscalar floating point engine for x86 platforms. The resulting floating point capability is the most powerful ever delivered in an x86 processor.

Enhanced 3DNow!™ Technology: The first x86 instruction set to use superscalar SIMD floating point techniques. Enhanced 3DNow! technology adds 24 instructions-19 to improve MMX integer math calculations and enhance data movement for Internet streaming applications and 5 DSP extensions for soft modem, soft ADSL, Dolby Digital, and MP3 applications.

Cache Architecture: The AMD Athlon processor boasts a 384K total full-speed on-chip system cache including 128K L1 cache--four times that of Intel's Pentium® III processor--and 256K on-chip full-speed L2 cache.

2-2-2 CPU and System Cooling

Any attempt to operate the AMD Athlon™ Processor without a suitable cooling solution will result in permanent damage to the processor and potentially other components within the system.

Fan Headers

This motherboard allows the use of in all 4 FANS. Of these 4 FANS, 2 can be used by the CPU Heatsink assembly (Some heatsink assembly come with 2 FANS). The other 2 FAN Headers allow connection of a Chassis Fan and a Power Supply FAN respectively. For a the location of the FAN connectors, refer to the following picture:

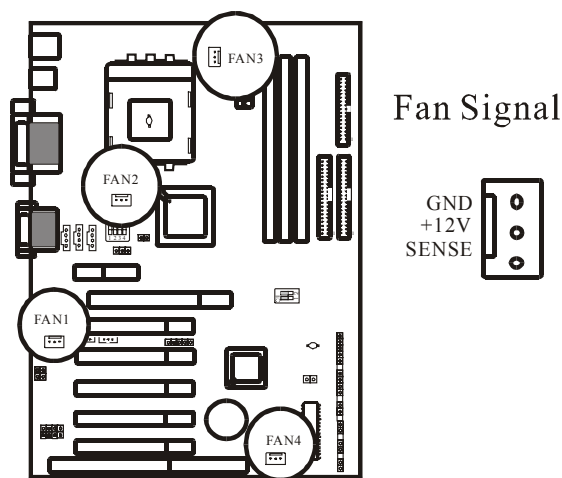

- FAN3: CPU Main FAN , FAN2: CPU Secondary FAN
- FAN1: Chassis FAN
- FAN4: POWER Supply FAN

The lay-out of all FAN Headers is the same, please refer to the picture below:
(Note: RPM Sens only for FAN3 & FAN4)

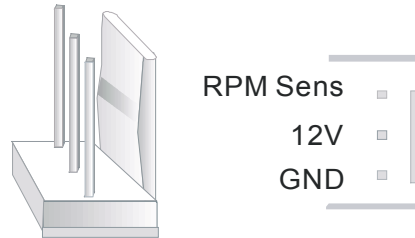

Cooling Technical Background

As processor technology pushes to faster speeds and higher performance, thermal management becomes increasingly crucial when building computer systems. Maintaining the proper thermal environment is key to reliable, long-term system operation. The overall goal in providing the proper thermal environment is keeping the processor module below its specified maximum plate temperature.

Heatsinks induce improved processor heat dissipation through increased surface area and concentrated airflow from attached fans. In addition, interface materials allow effective transfers of heat from the processor to the heatsink. You can go the AMD website (www.amd.com) to find a list of AMD recommended FANs.

Note: If your case comes with a case FAN or a possibility to install a case FAN, we recommend you use it.

2-3 Memory

This motherboard supports only Dual Inline Memory Modules (DIMMs). Three sockets are available for 3.3Volt unbuffered SDRAM (Synchronous Dynamic Random Access Memory). The sizes that are supported are: 8, 16, 32, 64, 128, 256, or 512MB, memory sizes between 8MB to 1.5GB can be formed this way. This motherboard also supports NEC's Virtual Channel (VC) SDRAMs. Refer to the picture below for the position of the DIMM slots:

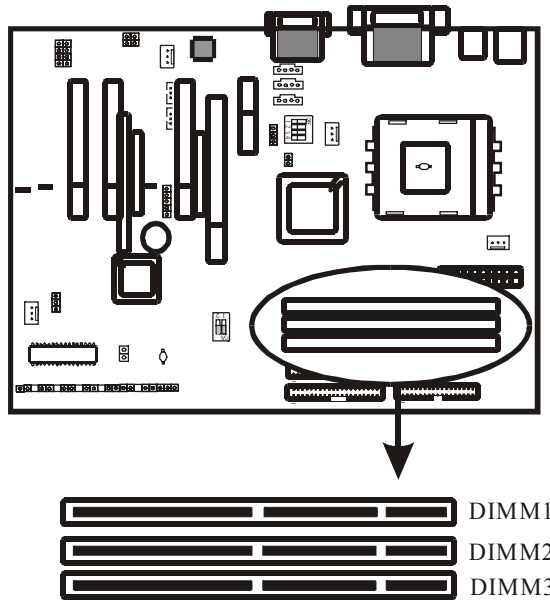

Memory speed is controlled through the BIOS, on the Advanced Chipset Features Setup page you will find several items related to SDRAM speed. Refer to the BIOS section for more details.



WARNING:

- DIMM modules that have more than 18 chips are not supported on this motherboard. (Due to signal integrity)
- If the system CPU bus operates at 100MHz/133MHz, use only PC100-/PC133-compliant DIMMs. (System won't boot otherwise)
- DO NOT attempt to mix PC133 SDRAMs with VCM SDRAMs.

2-3-1 Memory Installation

The DIMM modules can be inserted in DIMM slots 1 to 3. Because of the two notches in the DIMM module it can be inserted in only one way. Please refer to the picture below for information on how to insert the DIMM modules.

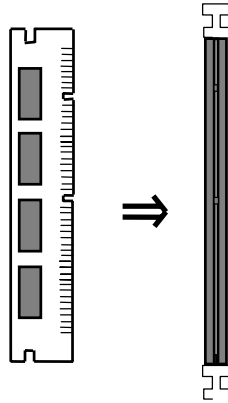

WARNING:

Make sure that you unplug your power supply when adding or removing memory modules or other system components. Failure to do so may cause severe damage to both your motherboard and expansion cards



Memory Technical Background

Memory Facts

- All new motherboards support SPD (Serial Presence Detect) DIMMs. These DIMMs have a little EEPROM (memory IC) on the module that allows the BIOS to read the specifications for the DIMM module.
- The BIOS shows the amount and type of SDRAM memory on the bootup screen.
- Single-sided DIMMs come in 16, 32, 64, 128, 256MB; double-sided come in 32, 64, 128, 256, 512MB.

DIMM Type

The type of buffer and the working voltage of a DIMM module can be read from the position of the two notches. Please refer to the following diagram for more information:

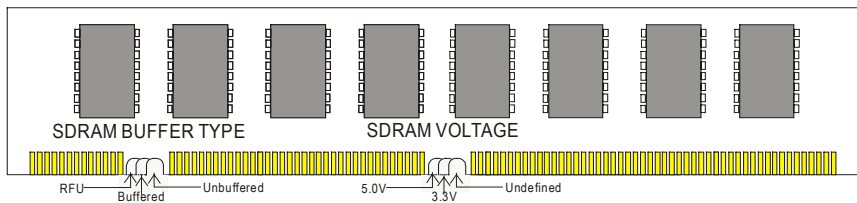

VCRAM

Virtual Channel RAM is a technology that was initially developed by NEC. VCRAM increases the memory bus efficiency and performance of the memory module by providing a set of fast static registers between the memory core and I/O pins, resulting in reduced data access latency and reduced power consumption. Each data request from a memory master contains separate and unique characteristics. Multiple requests from multiple memory masters can cause page trashing and bank conflicts, which result in low memory bus efficiency. The VCRAM architecture assigns virtual channels to each memory master. Since virtual channels maintain the individual characteristics of each memory master request, bus efficiency is dramatically increased.

2-4 PCI and ISA

The PCI slots allow for expansion cards to be added to the system. Expansion cards come in a great variety, Video cards, SCSI cards, Sound cards to name but a few. Refer to the picture below for the location of the PCI and ISA slots:

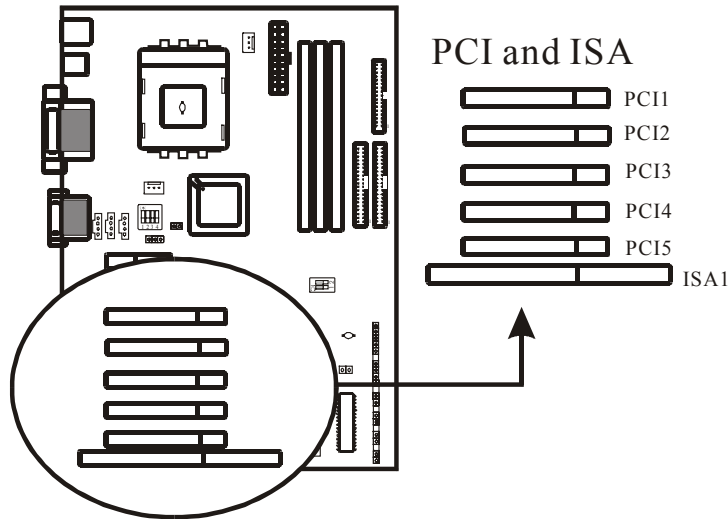

General steps to install a new Expansion Card:

- Read the documentation for your expansion card and make any necessary hardware or software settings for your expansion card, such as jumpers.
- Remove the cover of your computer system case and the bracket plate on the slot you intend to use. Retain the bracket for possible future use.
- Carefully align the card to the slot and press firmly.
- Now secure the card in the slot with the screw you removed.
- Replace the computer case cover.
- Set up the BIOS if necessary (This includes interrupts)
- Install the necessary software drivers for your expansion card.

If you run into problems with expansion cards this may be due to interrupt issues. Please refer to the interrupt section later in this chapter.

2-4-1 Wake On LAN Header

The Wake On LAN Header is described under the PCI section because the WOL Header can accept a cable from a PCI LAN Card that supports Wake On LAN. For the pin lay-out of the WOL header, please refer to the picture below.

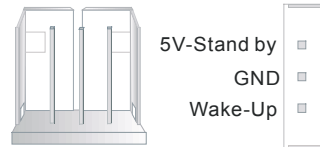

WOL Technical Background

The Wake-On-LAN feature provides the capability to remotely power-on client systems that support Wake-On-LAN by simply sending a Wake-On-LAN packet. After waking up files can be uploaded to or downloaded from the client. With this feature, network administrators can flexibly perform client maintenance during off-hours so that Total Cost of Ownership (TCO) will be lower. Wake-On-LAN is a remote management tool with advantages that can reduce system management workload, provide flexibility to the system administrator's job, and of course save time-consuming efforts and costs.

Using Wake-On-LAN on your system requires a LAN adapter that supports the Wake-On-LAN and software such as LDCM Rev 3.1x or later that can send and receive wake-up packets.

2-4-2 Wake On Modem Header

The Wake On Modem Header is described under the PCI section because the WOM Header can accept a cable from a PCI Modem Card that supports Wake On Modem (Also known as Wake On Ring). For the pin lay-out of the WOL header, please refer to the picture below.

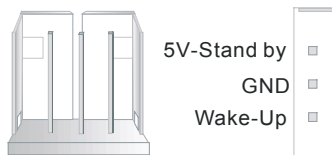

After connecting the WOM cable from your modem to the WOM header, you can set the BIOS to allow the system to wake up when the Modem Card receives a Ring signal.

2-4-3 IO Voltage Selection





This motherboard allows modifying of the 3.3V IO Voltage. The following lists all the devices on the motherboard that use this voltage:

- PCI Slots
- Memory
- Southbridge (to which the IDE and FDD connectors are also connected)

As can be seen, many devices are fed from this 3.3V IO Voltage. Normally setting this voltage to 3.3V is recommended. But if you 'overclock' your system it will become more stable by increasing the IO voltage.

The PCI Bus is normally supposed to run at 33MHz (the PCI and CPU frequencies can be set through the *frequency/ voltage control* page in the BIOS setup), if it runs at a higher frequency and your system is not stable you may try increasing the IO voltage to 3.4V or 3.5V. Note that we do not guarantee proper system functioning when it is not operating within its specifications.

Refer to the following table for the IO voltage settings:

	3.3V	3.4V	3.5V	3.6V
JP3 setting				

2-5 AGP Slot

Your Motherboard supports AGP cards up to 4X mode, yielding high graphics performance. To use 4X mode AGP cards, make sure to enable the 4X mode in the BIOS, on the Advanced Chipset Features page.

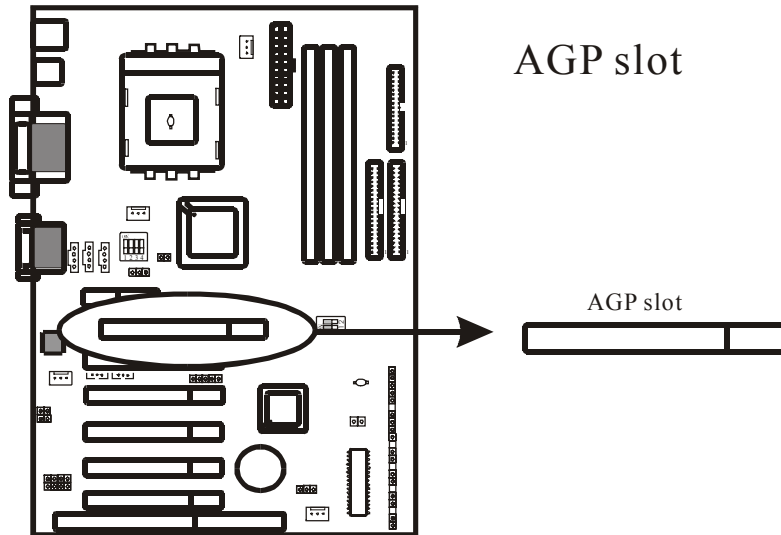

The following picture shows the position of the AGP port:

Take the following steps to install your AGP card:

- Remove the cover of your computer system case and the bracket plate on the slot you intend to use. Retain the bracket for possible future use.
- Carefully align the card to the AGP slot and press firmly. AGP Pro cards are longer but will fit in the AGP slot.
- Now secure the card in the slot with the screw you removed.
- Replace the computer case cover.
- Set up the BIOS to support 4X mode if your AGP card supports it.
- Install the necessary software drivers for your AGP card (See the Software Installation chapter)



AGP Technical Background

Speed of data transfers

The PCI Bus runs at 33MHz, the AGP at double that frequency, 66MHz. This is independent of the mode that is used. AGP cards currently are available in 3 modes, 1X, 2X and 4X. These are explained in more detail below:

- 1X mode: The data is clocked only at the rising edge of the clock. Since the databus is 32 bits (4 bytes) wide the transfer rate is $66 \times 4 = 264\text{MB/s}$.
- 2X mode: The data is clocked on both the rising and falling edge of the clock, yielding a transfer rate of $133 \times 4 = 532\text{MB/s}$.
- 4X mode: The sideband signals allow a transfer rate of $266 \times 4 = 1064\text{MB/s}$. 4X mode is only supported in the AGP 2.0 Specification.

Note that the transfer rates above are ideal rates, the real transfer rates will be lower due to main memory latency.

Sideband signals

The 32-bit bus in AGP is used for both address and data. While transactions (reads or writes) are running, commands (address + commands) cannot be issued for queuing until the transactions finish. Sideband addressing prevents this by separating the commands and transactions paths. So, the transactions can keep on running without intervening with commands.

Memory Sharing

Texture data take a large amount of memory in 3D games. If the memory on the AGP card is insufficient performance will suffer. Consider a graphics card with 4 Mbytes memory. Under resolution 800x600 with 16-bit color depth & 16-bit Z-buffer, 2.74Mbytes are used under double buffer configuration and only 1.36Mbytes are left for texture cache. That is not enough for most games, so textures will constantly be swapped in and out of local memory. Now with textures located in the shared AGP memory, only one access is required. That is, from AGP memory to frame buffer instead of a copy from system memory to VGA local memory, and next, from VGA local memory to frame buffer. The amount of memory shared is known as the AGP Aperture, the size can be set in the BIOS. Other names for memory sharing are AGP Execute Mode, DME, and DIME.

2-6 Interrupts

Because Interrupts are an important part of the motherboard, and many customers run into trouble when adding expansion cards that need interrupts, we have added this section on interrupts. First of all, what are interrupts?

When a device (like the Harddisk Controller) is told to provide some information it may not be able to provide it right away. (The Harddisk needs to first seek the location of the information for instance). If the CPU would be forced to wait for the information unacceptable delays would occur. That is where interrupts come in, if the device has completed the action it was supposed to do, it will generate an interrupt. Now the CPU can read (or write) the information it needs without any delays. While the device is performing the requested operation the CPU is free to perform other tasks, when the device finishes the interrupt notifies the CPU.

The original XT PC upon which many of the modern PC standards are founded had 16 interrupt lines available for devices. (Another name for interrupt is IRQ, which is short for InterRupt reQuest). Because the Expansion Bus used on those first PCs was the ISA bus, these interrupts are also known as ISA interrupts. As IRQ2 was used for cascading two 8 line IRQ controllers, IRQ2 was unavailable (this is true even in modern day systems, that need to stay compatible). The following table details the standard ISA IRQ assignments:

IRQ line	Assigned to	IRQ line	Assigned to
0	System Timer	8	Real Time Clock (RTC)
1	Keyboard Controller	9	Available
2	Cascade (not available)	10	Available
3	Serial Port 1	11	Available
4	Serial Port 2	12	PS/2 Mouse Port
5	Sound Card (or LPT 2)	13	Math Coprocessor
6	Floppy Disk Controller	14	Primary IDE Controller
7	Printerport 1 (LPT 1)	15	Secondary IDE Controller

As can be seen, many interrupts are fixed and only a few are available. The interrupts on the ISA Bus are not shareable. That means if a device is using an interrupt, then that interrupt can not be used by another device.

With the introduction of the PCI bus things got more complicated. The PCI Bus supports 4 Interrupts, known as INT-A, INT-B, INT-C and INT-D. The good thing about PCI interrupts is that devices can share them, but the limitation that the driver for that device must support interrupt sharing. If the driver does not support interrupt sharing, then other PCI devices cannot share the PCI interrupt used by that device.

Plug and Play Interrupts

Because of the interrupts under the ISA specification being fixed by hardware, many conflict situations occurred. To solve this problem the PnP (Plug and Play) specification was developed. PnP devices tell the BIOS what system resources they require, and the BIOS assigns system resources in a way that avoids conflict situations.

The PnP BIOS can only assign interrupts that are NOT used by legacy ISA devices (See the table above). The set of interrupts that is available to the PnP BIOS for assignment to PnP devices is called the PnP Interrupt pool.

PnP PCI Devices can be assigned whatever IRQ is available from the PnP Interrupt pool, but PnP ISA devices provide the PnP BIOS with a list of what IRQs can be assigned to it, the PnP BIOS will then assign an IRQ from the PnP Interrupt pool from that list.

Of the interrupts assigned to legacy ISA devices, some can be made available (released) to the PnP Interrupt pool. Some Legacy device interrupts can by definition not be released. The following table explains how to free legacy ISA interrupts for use by the PnP Interrupt pool.

Interrupt line	How to set the BIOS to release the IRQ to the PnP interrupt pool	
	PnP / PCI Configuration page	Integrated Peripherals
IRQ 0	Fixed, not available	
IRQ 1	Fixed, not available	
IRQ 2	Fixed, not available	
IRQ 3	IRQ 3: PCI / ISA PnP	Onboard Serial Port 2: disabled
	Note: If set to Auto, IRQ3 will be released only if COM2 has no device attached to it.	
IRQ 4	IRQ 4: PCI / ISA PnP	Onboard Serial Port 1: disabled
	Note: If set to Auto, IRQ4 will be released only if COM1 has no device attached to it.	
IRQ 6	Fixed, not available	
IRQ 7	IRQ 7: PCI / ISA PnP	Onboard Parallel Port: disabled
IRQ 8	Fixed, not available	
IRQ 12	IRQ 12: PCI / ISA PnP	IRQ 12 will be released automatically if no PS/2 mouse is used.
IRQ 13	Fixed, not available	
IRQ 14	IRQ 14: PCI / ISA PnP	On-chip IDE channel 0: Disabled
IRQ 15	IRQ 15: PCI / ISA PnP	On-chip IDE channel 1: Disabled

Note: IRQs not mentioned (5, 9, 10, 11) are always available to the PnP interrupt pool.

If you use an ISA Card that does not support PnP (an ISA legacy card), the interrupt used by the card must be set to Legacy ISA instead of PCI / ISA PnP in the BIOS. This will make sure that the interrupt used by the ISA card is not included in the PnP interrupt pool.

PCI Interrupts

The PCI interrupts (INT A ~ D) are routed to free interrupts in the PnP interrupt pool by the BIOS. PCI cards all support PnP, so the BIOS knows what system resources they require. The A,B,C,D Interrupt Request lines are mapped to physical devices in the following way:

	PCI slot 1	PCI slot 2	PCI slot 3	PCI slot 4	PCI slot 5	AGP port	USB
INT A				X		X	
INT B					X		
INT C		X					
INT D	X		X				X

USB and PCI slot 1 and PCI slot 3 use the same interrupt, and AGP, PCI slot 5 use the same interrupt. Because PCI interrupts are shareable this is OK. The BIOS contains the following items related to PCI interrupts:

BIOS item	Settings	Explanation
Assign IRQ to USB	Enabled/disabled	If the USB ports are not used, the user can set this item to disabled. This will make sure that PCI INT D is only granted to PCI slot 1, PCI slot 3.
Assign IRQ to VGA	Enabled/disabled	Most modern VGA cards require an interrupt to function. If yours does not, disable this item to free the PCI interrupt.

ACPI Interrupt

The ACPI specification defines that devices that support ACPI (Advanced Configuration and Power Interface) can issue interrupts to the OS to notify it of an ACPI event. This interrupt is called the SCI (System Control Interrupt), and it is always mapped to IRQ 9. If ACPI is enabled (see the FAQ chapter, ACPI section), PCI devices will be able to make use of IRQ 9, because PCI interrupts are shareable. But ISA PnP cards can not use IRQ9 if ACPI is enabled.

Therefore the BIOS contains an item that allows the user to disable ACPI. This will release IRQ 9 to the PnP interrupt pool for use by ISA PnP cards.

Assignment Sequence

The interrupts are assigned to the devices in the following sequence:

1. The fixed interrupts are hardwired and are left out of the assignment process (IRQs 0,1,2,6,8 and 13)
2. The BIOS determines what legacy ISA devices have been disabled in the BIOS setup and releases these IRQs into the PnP interrupt pool
3. The PnP interrupt pool now contains the free interrupts that can be assigned to PnP devices.

There are 2 possible ways of assignment now, depending on the setting in the BIOS for the PnP OS installed item. (On the PnP/PCI Configuration Setup page). If set to no, the A sequence applies, if set to yes the B sequence.

A PnP OS Installed: No The BIOS will now assign all interrupts

1. The BIOS first assigns the interrupts to the ISA PnP cards from the interrupt pool. The interrupts (if available) are assigned in the following order: 15, 11, 10, 12, 14, 3, 4, 5, 7, 9. As mentioned, if ACPI is enabled, IRQ 9 will not be available.
2. Now the BIOS assigns the PCI interrupts from the remaining interrupts in the pool. The interrupts are assigned in the A, D, B, C order. (With other words, the AGP IRQ is first assigned, then the USB IRQ with the others trailing). The USB, VGA and ACPI IRQs can be disabled in the BIOS as mentioned before.

B PnP OS Installed: Yes The BIOS will only assign the PCI interrupts. The interrupts are assigned in the same order as mentioned above.

After assigning the interrupts control is passed to the OS. The OS will now assign the ISA PnP interrupts from the remaining IRQs in the pool. However, since ISA PnP cards pass the OS a list of IRQs that can be assigned to it, if the OS finds that all the IRQs on the list are already assigned, it may reassign an IRQ that was assigned to PCI by the BIOS. This means concretely that the OS can change BIOS settings, and that settings made in the BIOS are not necessarily correct when using a PnP OS.

2-7 On board Audio

This motherboard southbridge supports AC'97, a standard that allows low cost Audio and Modem Codecs to be added to the motherboard. Your motherboard comes with a VIA VT1611 Audio codec. The AC'97 standard defines primary and secondary codecs, the onboard VIA codec is configured as the primary codec. A secondary AC'97 codec can be added to the motherboard through the AMR slot, refer to the next section for information on that.

2-7-1 Backpanel audio connectors

The backpanel Audio connectors allow connection of speakers, a microphone, and MIDI devices etc. Refer to the following picture:

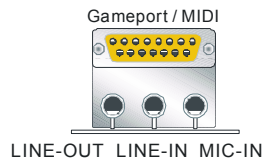

The Gameport can be used with joysticks, or alternatively as MIDI port. The Line-out is for speakers, be sure to use only amplified speakers. The Line-IN and Mic-IN are inputs that can be used for recording.

2-7-2 Onboard audio connectors

The onboard connectors can be used with additional devices, refer to the picture below:

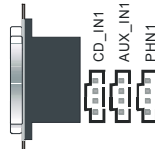



- The CD_IN1 input is for the CD-ROM Audio connector.
- The AUX_IN1 input is for use with a DVD Add-on card with a Line-in connector.
- The PHN1 input is for use with a modem with an internal voice connector.

2-8 AMR (Audio Modem Riser)

As explained in the audio section the AMR slot allows a expansion card to make use of the AC'97 functionality. If you want to use a primary codec on the AMR Card then you must set jumper 5 accordingly, see the following table

JP5: Primary Codec Select

	Onboard Audio Codec is primary codec	AMR Card codec is primary codec
JP5 Setting		

Note: pin 1 can be recognized by the thicker white line around it.

2-9 back panel connectors

The back-panel contains most standard IO connectors. Please refer to the picture below:

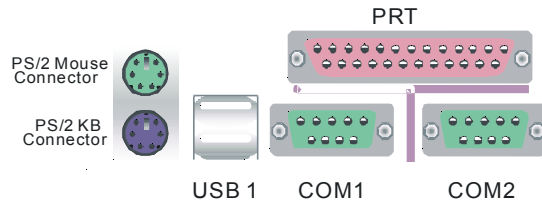

2.-9-1 PS/2 Mouse and Keyboard

These connectors allow for a PS/2 style mouse and keyboard to be connected.

PS/2 Keyboard

The keyboard can be plugged in in only one way. Please do not force the connector in, it may get damaged by use of excessive force. It is easy to make the mistake of reversing the PS/2 keyboard and mouse connectors. If your keyboard does not work, check this first. The keyboard must be inserted into the lower connector.

PS/2 Mouse

The mouse can be plugged in in only one way. Please do not force the connector in, it may get damaged by use of excessive force.

2-9-2 USB

This motherboard supports 4 USB connectors in all. Two of those USB connectors are available through the back-panel. The lay-out of the USB connector is as follows:

If you want to make use of the other onboard USB ports you will need to purchase a USB extension cable / bracket. This will connect to the onboard USB2 header. For the lay-out of the USB2 header, refer to the following table:

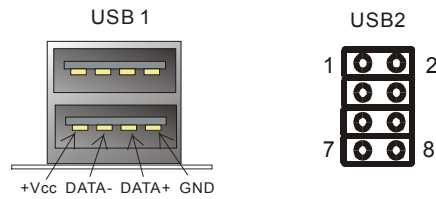

	Pin 1	Pin 2	Pin 3	Pin 4	Pin 5	Pin 6	Pin 7	Pin 8
USB2	+5V	GND	DATA1-	DATA2+	DATA1+	DATA2-	GND	+5V

2-9-3 Serial Ports

The serial ports can be used to connect devices such as a serial mouse and a modem. A serial mouse is usually connected to COM1. Please refer to the following table for the pin lay-out of the serial ports:

Pin 1	DCD (Data Carrier Detect)	Pin 6	DSR (Data Set Ready)
Pin 2	SIN (Serial IN or Receive Data)	Pin 7	RTS (Request To Send)
Pin 3	SOUT (Serial OUT or transmit data)	Pin 8	CTS (Clear To Send)
Pin 4	DTR (Data Terminal Ready)	Pin 9	RI (Ring Indicate)
Pin 5	GND		

2-9-4 Parallel Port

The parallel or printer port is used, as its name suggests, primarily to connect printers. But devices like cameras and scanners do also come with parallel port interfaces. The pin lay-out of the parallel port is as follows:

Pin 1	Strobe	Pin 10	ACK#
Pin 2	Data 0	Pin 11	BUSY
Pin 3	Data 1	Pin 12	PE
Pin 4	Data 2	Pin 13	SELECT
Pin 5	Data 3	Pin 14	AUTO FEED#
Pin 6	Data 4	Pin 15	ERR#
Pin 7	Data 5	Pin 16	INIT#
Pin 8	Data 6	Pin 17	SLIN#
Pin 9	Data 7	18-25	GND

2-10 IrDA (InfraRed Remote Link)

If you want to make use of an InfraRed Remote device you can use IR1, a 5-pin header on the motherboard. You will need to buy a separate IR device from your dealer. The motherboard supports both ASKIR and HPSIR specifications, you will need to set the standard you want to use in the BIOS on the integrated peripherals page. The pin lay-out of IR1 is as follows:

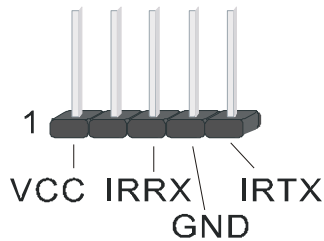

2-11 IDE 1 and IDE 2

The IDE connectors are used to connect IDE devices such as Harddisks and CD-ROM drives to the motherboard. Each connector constitutes an IDE channel, each channel accepts 2 IDE devices, one Master and one Slave. The IDE 1 connector is also known as the primary channel, IDE 2 is the secondary channel. Therefore the primary Master is the IDE device connected to IDE 1 as Master, the primary Slave is the IDE device connected to IDE 1 as Slave. Jumpers on the IDE device determine Master and Slave settings. Your harddisk or CD-ROM should have a sticker with jumper settings. Make sure that you set these jumpers correct. Please use the following advise as reference:

- If you have only device connected to an IDE connector, always set it as Master.
- If you have one HDD and CD-ROM in your system, then connect the HDD to IDE 1 as Master, and the CD-ROM to IDE 2 as Master.
- If you have one Harddisk and one CD-ROM connected to the same IDE connector, set the HDD to Master and the CD-ROM to Slave.

Ultra DMA

This motherboard supports Ultra DMA 66 IDE devices, if your southbridge is the 82C686B it will even support Ultra DMA 100. If the UDMA mode for the IDE channels are set to auto in the BIOS the motherboard will use the fastest possible interface to communicate with your IDE devices. (Note however that windows may not support UDMA 100 yet, see the FAQ chapter)

For the location of the IDE connectors, refer to the following picture:

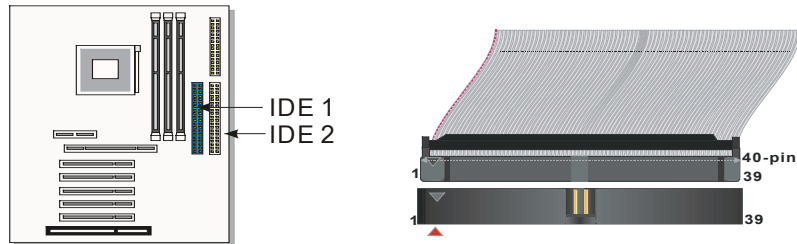

2-12 FDD1 (Floppy Disk)

The floppy disk connector allows connection of a floppy drive. In all two floppy drives can be connected to the motherboard, known as floppy A and B. The BIOS allows you to disable the floppy controller if you do not use any floppy drives, that will free an Interrupt. The BIOS also allows swapping of floppy A and B although this will not be useful to most users. For the floppy disk connector location, refer to the following picture:

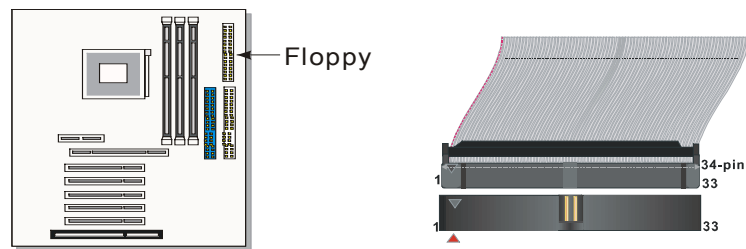

2-13 PWR1 (ATX power supply)

The ATX power supply connector is where your power supply plug must be inserted. Note that this motherboard only supports ATX style power supplies, AT style power supplies are not supported. Note the following:

- We recommend use of at least a 250W power supply, if you use a very fast CPU (> 900MHz) and have many peripheral devices we recommend use of a 300W power supply. **Do not save on the power supply, it feeds the whole system.**
- If you use WOL and WOM, make sure that power supply can support at least 720mA on the 5V standby line. Anything LESS is unacceptable. Even better, get a 1A 5V standby power supply.

For the lay-out of the AXT connector, please refer to the following picture:

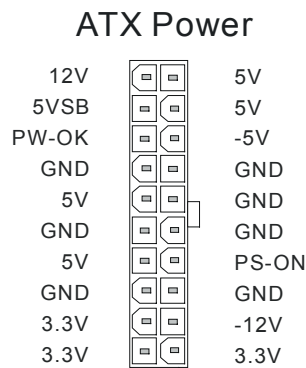

2-14 Front panel connectors

The front panel connector strip is located near the battery and the BIOS IC. It will allow you to connect LEDs and Switches in your case to the motherboard. Please refer to the following picture for the lay-out of the front panel connector strip:

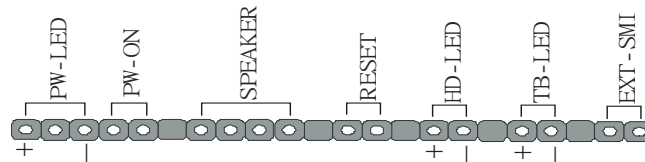

Descriptions of each individual connector follow:

■ PW-LED

The Power LED connector allows you to connect a three pin LED from the case. Notice the polarity, LEDs will only light up if the polarity is correct.

■ PW-ON

The Power ON connector is to be used with the push-button power switch in the case. This push button should be a momentarily contact type switch (that is, it should not lock in the ON state but flip back OFF as soon as you release it). All ATX cases come with such a switch. The BIOS allows you to select the power down mode. Either power down immediately on a button push, or with a 4 second delay.

■ Speaker

The speaker connector is for the internal case speaker. This speaker will enable the BIOS to give spoken messages in case of boot up trouble. The BIOS beep codes also use this speaker. For Games and Music this speaker will not be used, but rather the back panel line-out connector.

■ Reset

The reset connector is for connection of the reset switch. This switch, when pressed, will immediately reset the system (that is, no matter what you were doing, the system will restart. This is very similar to powering to system off and then on again). Note that Windows, Linux and other operating systems do not appreciate the use of the reset switch. When you are working under windows, always use the shutdown feature under the start button (Yes, very logical).

- **HDD LED**

This LED will light up whenever one of your IDE devices is being accessed. Usually this will be a harddisk, as such the name HDD LED.

- **TB-LED**

This is the Turbo LED, this LED is always on and is similar in function to the Power LED.

- **Ext-SMI**

This is the External System Management Interrupt Button connector. Connect the second button on your ATX case to this connector. Pressing that button will force the system into suspend mode. (The BIOS allows specifying of the suspend state, and of the wake-up events that can wake the system up again).

Chapter 3 Software Installation

It is recommended to do a clean installation of Windows when you first install your motherboard. Immediately after installing Windows 98 or Windows 2000 you should install the latest VIA drivers for the motherboard. The original VIA drivers are included on the driver CD which accompanied this motherboard, but the latest drivers can be found at <http://www.via.com.tw/drivers/index.htm> or www.viatech.com/drivers/index.htm.

3-1 Driver Installation

The following installation procedure for Windows 98(SE) is a safe way of installation of all drivers:

- Boot into DOS using a start up floppy, now
 - Use FDISK to create DOS partition on disk (this destroys existing data on disk)
 - Format C: /S to format disk (this destroys existing data on disk)
- Install Windows
- Install the latest VIA 4in1 service pack from CD
 - Go to the 4 in 1 directory on the CD and run the setup.exe file
- Install the latest VIA Sound driver from CD
 - Go to the VIA AC97 directory on the CD and run the setup.exe file
- Optional: Install the latest DirectX and latest patches.
 - Go to the Direct X directory on the CD and run the setup.exe file
- Install the latest video drivers.
 - This driver must have come with your AGP / PCI graphics card
- Optional: Install the latest sound card drivers.
 - Only necessary if you use a sound card. Disable the onboard sound in that case and do not install the VIA sound driver.
- Install the other latest drivers, e.g. joystick, graphics tablet, etc
- Install the applications.

The principle is to work up from the most basic software towards the higher level applications. It may be advisable to defrag before and after installing DirectX, but this should be unnecessary if the disk was formatted before installation.

3-2 Registry error when installing the VIA 4in1 drivers

Some users have the onboard IDE controllers disabled, because SCSI disks are used. Installation of the VIA 4in1 drivers under Windows98 then gives a "Registry error! Please reboot computer" error message while the setup file unpacks. Enabling the IDE controllers during the installation will solve this issue.

Chapter4 The BIOS

The BIOS is a piece of software (Basic Input Output System) that performs most low level tasks. When you start up your system, the BIOS is the first code that gets to run. The BIOS resides in a FLASH ROM, and the code in the FLASH ROM can be updated through a special utility called AWDFLASH. (Award Flash). This is generally not necessary, but in some cases updating the BIOS is necessary to support new devices that were not on the market at the time the motherboard was released. For the physical location of the BIOS FLASH ROM IC on your motherboard, refer to the picture below:

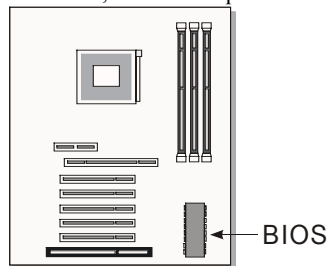

The BIOS IC is inserted in an IC socket, which means that it can be removed and exchanged for another IC if necessary.

Is updating my BIOS necessary?

As a general rule if your system is functioning properly and you are not an experienced user, do not try to update the BIOS. Only if you have specific problems that a BIOS update may solve may it be advisable to update the BIOS.

The update process is pretty complex, and you should bear in mind that if updating the BIOS goes wrong you may render your system unbootable. Therefore, do not update unless you know what you are doing.

Finding the latest official BIOS revision

For the latest official BIOS revision, please go to our website at www.lucky-star.com.tw. On the support page you can find the latest BIOS files for our motherboards.

4-1 Updating the BIOS

As said, this procedure is complicated, ONLY update your BIOS when you experience

problems with your system. Because each BIOS release completely overwrites the previous version and there is no need to update to intermediate BIOS releases when updating the BIOS. Therefore always use the latest BIOS revision when doing a BIOS update. The BIOS update procedure is as follows:

- In order to flash update the BIOS, you will need 2 files:
The BIOS binary file (.bin file from the website)
AWDFLASH.EXE utility file. (This utility can be downloaded from our website)
- Create a directory on your C harddisk drive: and name it FLASH
- Put the BIOS .bin file and the AWDFLASH utility in the FLASH directory.
You may want to jot the BIOS .bin file name down on a piece of paper.
- Restart the computer, press DEL to go into the BIOS, then please disable the following:
System BIOS Cacheable (in Advanced Chipset Features)
Video BIOS Shadow (in Advanced BIOS Features)
Save the changes by selecting 'save and exit', and restart the computer.
- Press Ctrl + F5 just before Windows is starting up (right after the second BIOS screen) for a DOS boot, you will see the message "Windows is bypassing all your startup files". You end up at a DOS prompt.
- Now type `cd FLASH` to change to the newly created directory.
- Here type `AWDFLASH mybios.bin /py /cc /sn /cd`, where mybios.bin is the file name for the BIOS binary file you want your BIOS to upgrade to. Now the upgrading will begin.



WARNING:

Do NOT in any way disturb the system during upgrading. If for any reason the system is stalled your system may not be able to boot again.

- After the upgrading has ended press F1 to reset, press DEL to go into BIOS and make the following changes:
Load Setup Defaults.
Go into the Frequency/Voltage Control page to adjust your CPU speed and voltage (please make sure the CPU voltage matches your CPU specs, in case of doubts leave it to 'default').
Save your settings and you are done.

4-2 The CMOS memory

The BIOS uses the CMOS memory to store all the settings that have been made through the BIOS Setup pages.

Battery

The CMOS memory remembers all settings, even when the system is switched off, by use of a 3V Lithium battery. If this battery runs low CMOS is unable to keep its settings and you will need to replace the battery. The BIOS will give you an error message when it detects a low battery voltage. The error message 'CMOS checksum error' may also point to a low battery problem.

Restoring default settings

You can load default values into the CMOS memory by selecting 'Load Optimized Defaults' in the BIOS Setup. If you need to force the CMOS settings to default without entering the BIOS Setup page you can use the JBAT1 jumper. For the location of the jumper and the battery, refer to the following picture:

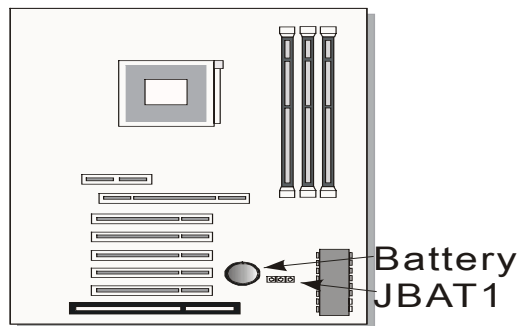



Normally JBAT1 will be in the 1-2 position, this will connect the battery to the southbridge of the chipset which contains the CMOS memory. If JBAT1 is temporarily set to 2-3 this will interrupt the battery electricity flow, and the CMOS memory will be erased, this will however only work if the power supply is not switched on. Now at the next reboot the BIOS will automatically load the CMOS default values.

Take the following steps to clear CMOS memory:

- Take the power cord from the power supply.
- Temporarily set JBAT1 to 2 – 3, and set it back to 1 – 2.
- Put the power cord back and restart the system, the default values will be loaded.

JBAT1 Setting:

	Retain CMOS settings	Clear CMOS Settings
JBAT1	 1 2 3	 1 2 3

The following part of this chapter will describe the individual BIOS Setup pages and all the items that can be adjusted to fine tune your system.

4-3 The BIOS Setup Pages

To enter the BIOS Setup pages, take the following steps:

- Start up the system.
- After memory counting has finished, press [DEL] to enter the BIOS Setup pages.

Now the following menu will appear:

<i>CMOS SETUP UTILITY Copyright © 1984 – 2001 Award Software</i>	
<i>▶ Standard CMOS Features</i>	<i>▶ PC Health Status</i>
<i>▶ Advanced BIOS Features</i>	<i>▶ Frequency/Voltage Control</i>
<i>▶ Advanced Chipset Features</i>	<i>Load Optimized Defaults</i>
<i>▶ Integrated Peripherals</i>	<i>Set Password</i>
<i>▶ Power Management Setup</i>	<i>Save & Exit Setup</i>
<i>▶ PnP/PCI Configurations</i>	<i>Exit Without Saving</i>
<i>Esc : Quit F9: Menu in BIOS</i>	<i>↑↓→← : Select Item</i>
<i>F10 : Save & Exit Setup</i>	
<i>Time, Date, Hard Disk Type . . .</i>	

Selecting items

To Select items, use the following method:

- Use the arrow keys to move between items and select fields.
- Press [enter] to enter the selected submenu.

Submenus

All items that start with a ▶ are submenus. Pressing [enter] when a submenu is selected will enter that submenu.

Modifying selected items

The [Up]/[Down] keys can be used to modify values within the selected fields. Note that some fields also let you enter values directly.

Hot Keys

Throughout the BIOS Setup Pages the hot keys will give you access to a group of commands. Refer to the following table for the hot keys and their function:

Key	Command	Description
F10	Save & Exit Setup	Saves the changes made and reboots the system.
[Esc]	Quit	Returns to the previous menu
F1	Help	General Help
F2	Help	Help for specific item
F5	Previous values	Restores the previous values. These are the values that the user started the current session with.
F7	Optimized Defaults	Loads all options with the Optimized Default values.

Save & Exit Setup

When you select the [SAVE & EXIT SETUP] option from the Main Menu, all changes that you made will be saved to the CMOS memory and the setup utility will exit, rebooting your system.

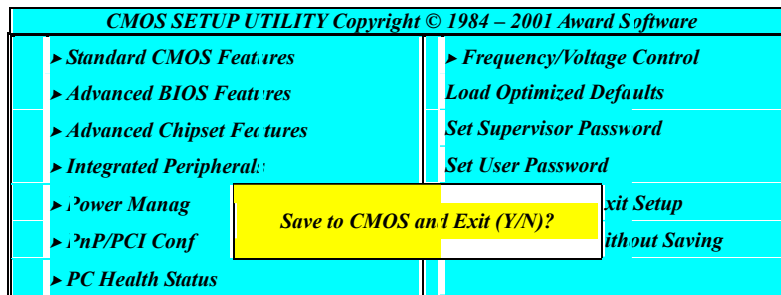

Pressing [Y] and [enter] will save the changes, pressing [N] and [enter] will keep the old settings.

Exit Without Saving

Selecting 'Exit Without Saving' will exit Setup without saving changes to CMOS.

CMOS SETUP UTILITY Copyright © 1984 – 2001 Award Software	
▶ <i>Standard CMOS Features</i>	▶ <i>Frequency/Voltage Control</i>
▶ <i>Advanced BIOS Features</i>	<i>Load Optimized Defaults</i>
▶ <i>Advanced Chipset Features</i>	<i>Set Supervisor Password</i>
▶ <i>Integrated Peripheral:</i>	<i>Set User Password</i>
▶ <i>Power Manag</i>	<i>Exit Setup</i>
▶ <i>PnP/PCI Conf</i>	<i>Exit Without Saving</i>
▶ <i>PC Health Status</i>	

Quit without Saving (Y/N)?

Pressing [Y] and [enter] will Exit without saving, pressing [N] and [enter] will not Exit.

4-3-1 Standard CMOS Setup

Select the [STANDARD CMOS SETUP] option from the Main Menu and press [Enter] key.

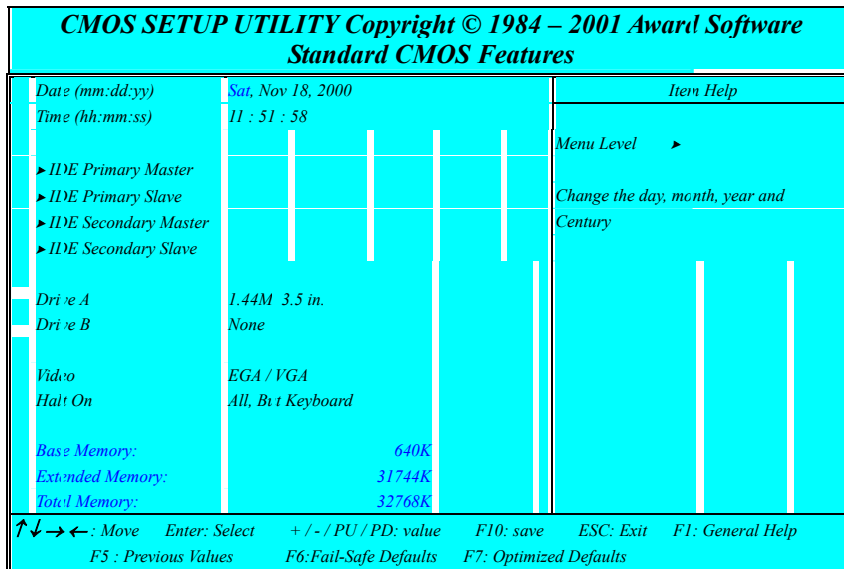

This screen allows you to change the basic CMOS Settings such as date and time, harddisk type etc. After you have made the changes you need to make press [ESC] to return to the main menu.

Date and Time

	Default	Possible Settings	Notes
Date	Weekday, month, day, year	Type the current date. (weekday auto changes)	Using the P-Up / P-Dn keys to toggle is possible
Time	hh:mm:ss	Type the current time	24-hour clock for nat. (15:15:00 = 3:15:00)

IDE Devices

When you select one of the IDE devices, a submenu will pop up. Refer to the picture below.

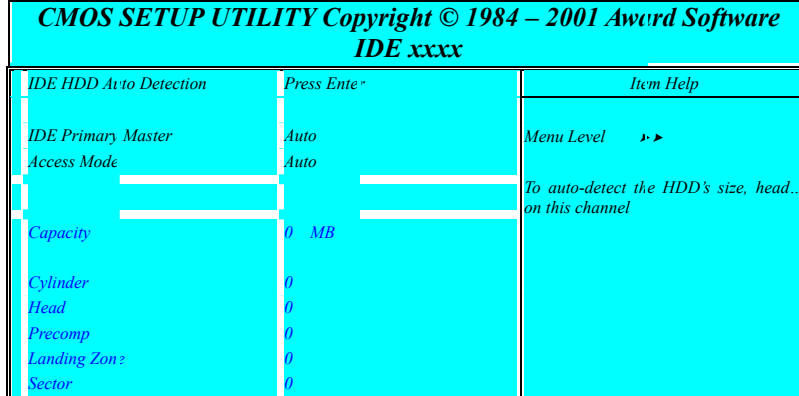

This Menu is the same for all 4 IDE devices:

- Primary Master IDE 1 first device
- Primary Slave IDE 1 second device
- Secondary Master IDE 2 first device
- Secondary Slave IDE 2 second device

	Values	Meaning
IDE HDD Auto Detection	Press Enter	Pressing Enter will make the BIOS auto detect the IDE device on this channel. The result will be displayed below, starting with the 'capacity' item. (These items are read only)
IDE xxx	Auto	This will auto detect the device at each boot up.
	Manual	This will use the setting set by the user. No auto detection at start up will take place.
	None	This setting means no device is present. This will prevent the BIOS from looking for a device and speed up booting.
Access Mode	CHS	Selects the CHS access mode.
	LBA	Logical Block Addressing, for HDD drives larger than 504MB (All modern HDDs)
	Large	For very large HDDs.
	Auto	The BIOS will automatically detect the best access mode.

Drive A and Drive B

The Drive A / B items allow you select the type of device that you have attached to the Floppy (FDD1) connector on the motherboard. You can select between different floppy disk drive types by using the Page-Up and Page-Down keys. If you press [enter] while Drive A or B is selected the following menu will pop up that will allow to choose a device as well:

Drive X		
None	...	[]
360K, 5.25 in.	...	[]
1.2M, 5.25 in.	...	[]
720K, 3.5 in.	...	[]
1.44M, 3.5 in.	...	<input checked="" type="checkbox"/>
2.88M, 3.5 in.	...	[]
↑↓: Move Enter: Accept ESC: Abort		

Video

The Video item allows you to select a video mode. Since most modes are outdated we advise you to always select EGA/VGA. You can select between different video modes by using the Page-Up and Page-Down keys. If you press [enter] a menu pops up.

(Mono is for a monochrome screen that can only display one color)

Video		
EGA/VGA	...	<input checked="" type="checkbox"/>
CGA 40	...	[]
CGA 80	...	[]
MONO	...	[]
↑↓: Move Enter: Accept ESC: Abort		

Halt On

The BIOS will stop booting when an error is detected. You can set through this item what errors will stop the system booting. You can select between different error modes by using the Page-Up and Page-Down keys.

	Values	Meaning
	All Errors	Stop booting on all errors.
	No Errors	Always Boot, no matter what error is detected.
	All, but keyboard	Stop booting on all errors, but not on a keyboard error.
<i>Halt On</i>	All, but diskette	Stop booting on all errors, but a diskette error.
	All, but disk/key	Stop booting on all errors, but keyboard and diskette errors.

4-3-2 Advanced BIOS Features

Select the [Advanced BIOS Features] option from the Main Menu and press [Enter] key.

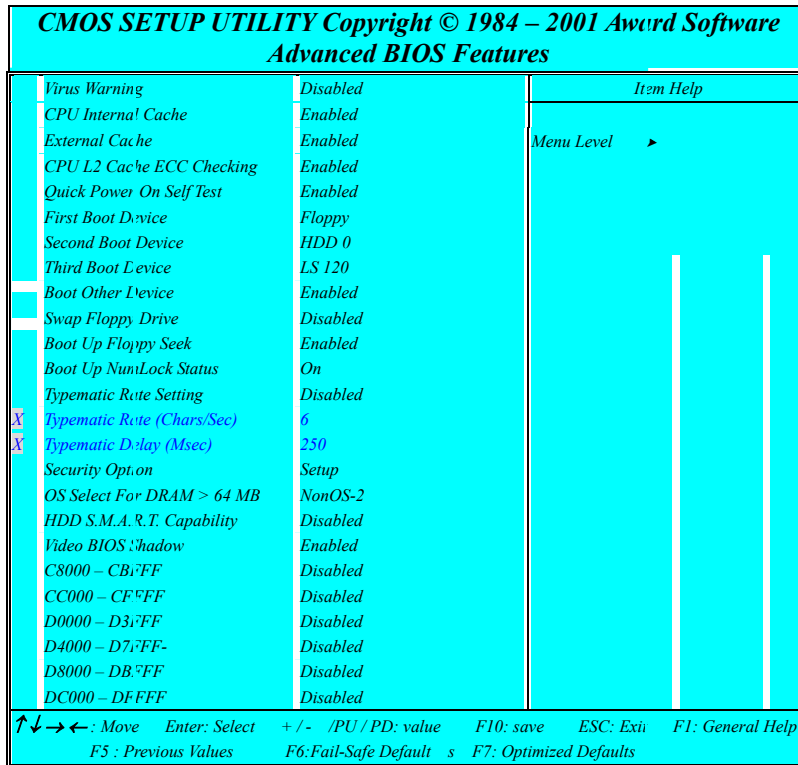

The screen is not as long on your monitor. You can use the arrow keys to scroll down and up the page. The following explains all individual items and their meaning.

Virus protection

	Values	Meaning
<i>Virus Warning</i>	Enabled	The BIOS will give a beep and a warning whenever an attempt is made to write to the boot sector of the HDD.
	Disabled	The BIOS will allow write attempts to the boot sector

CPU Cache settings

	Values	Meaning
<i>CPU Internal Cache</i>	Enabled	This will enable the Internal L1 cache of your CPU.
	Disabled	(Not recommended)
<i>External Cache</i>	Enabled	This will enable the Internal L2 cache of your CPU.
	Disabled	(Not recommended)
<i>CPU L2 Cache ECC checking</i>	Enabled	This will enable CPU Internal L2 cache ECC (Error Checking).
	Disabled	(Not recommended)

Quick Power On Self Test

	Values	Meaning
<i>Quick Power On Self Test</i>	Enabled	The BIOS will execute test routines that test most parts of the motherboard during boot up.
	Disabled	The BIOS will skip the tests, speeding up the boot process. Errors will on the other hand not be detected.

Boot Devices

The first to third boot device items allow you to select what device the system should boot from. If the BIOS fails to boot from the first boot device, it will attempt to boot from the second boot device, if that fails too, the third boot device is tried. If you set the *boot other device* item to enabled, the BIOS will try to boot from other devices if the first to third choices all fail. If you set this item to disabled, the BIOS will not boot if the first to third devices all fail to boot.

The list you can choose from for the first to third device is the same, refer to the table below:

	Values	Meaning
<i>First ~ Third boot device</i>	Floppy	The system attempt to boot from diskette. (first boot device default)
	LS 120	The system will attempt to boot from an attached LS 120 drive. (Third boot device default)
	HDD 0	The system will attempt to boot from the first HDD. (Second boot device default)
	SCSI	The system will attempt to boot from the first device attached to the first SCSI interface.
	CD-ROM	The system will attempt to boot from the first CD-ROM found.
	HDD1	The system will attempt to boot from the second HDD.
	HDD2	The system will attempt to boot from the third HDD.
	HDD3	The system will attempt to boot from the fourth HDD.
	ZIP100	The system will attempt to boot from an attached ZIP 100 drive
	LAN	The system will attempt to boot over the network. You will require a LAN card with boot BIOS for this option to function.
	Disabled	This disables booting from this device.

Floppy Drive Settings

	Values	Meaning
<i>Swap Floppy Drive</i>	Enabled	This will swap floppy A and B. Most systems not even have 2 floppy drives, so this item is irrelevant .
	Disabled	Floppy A and B are not swapped
<i>Boot-up Floppy Seek</i>	Enabled	The BIOS will test whether the floppy has 40 or 80 tracks during boot up. All new floppy drives are 80 tracks.
	Disabled	The BIOS will not test the amount of tracks.

Keyboard Typematic Rate and Delay Settings

If you set the *typematic rate setting* item to disabled, the system will use the defaults of 6 and 250 for the rate and delay items. If you set it to enabled you can select the values yourself. Refer to the table below:

	Values	Meaning
<i>Typematic Rate</i>	6 ~ 30	This value sets the amount of time a character is repeated per second if it is kept down on the keyboard. Choose from the following values: 6, 8, 10, 12, 15, 20, 24, 30.
<i>Typematic Delay</i>	250 ~ 1000	This value sets the amount of time in ms before a character starts repeating after it was pressed on the keyboard. Choose from 250, 500, 750 and 1000 ms.

Security Option

The security option item allows you to select when the password needs to be entered. Refer to the table below:

	Values	Meaning
<i>Security Option</i>	Setup	Password must be entered only when the user wants to enter the BIOS setup.
	System	The password must always be entered at boot.

OS Select for DRAM > 64MB

	Values	Meaning
<i>OS select for DRAM > 64MB</i>	Non-OS2	If your OS is not OS2, always select this setting.
	OS2	Select this setting only if your OS is OS2

HDD SMART Capability

	Values	Meaning
<i>HDD Smart Capability</i>	Enabled	Some Harddisks support SMART, a diagnostic standard that allows the HDD to tell the system about problems. Enable this item only if your HDD supports SMART.
	Disabled	Default setting.

Shadow Options

The shadow options allow the BIOS to shadow (write to RAM) certain parts of the BIOS code. This will speed up running the code, since running from RAM is much faster than running from FLASH ROM.

The individual memory ranges refer to BIOS code that may be present on expansion cards. Normally you will not need to enable shadowing for these ranges. Refer to the table below for details:

	Values	Meaning
<i>Video BIOS Shadow</i>	Enabled	This will allow the BIOS to write the video BIOS to RAM. This will speed up execution and is the default setting.
	Disabled	No shadowing is allowed.
<i>xxxx-xxxx Shadow</i>	Enabled	This enables shadowing of the selected memory range. Set to enabled only when you are sure an expansion card uses this memory range.
	Disabled	Default setting.

4-3-3 Advanced Chipset Features

Select the [Advanced BIOS Features] option from the Main Menu and press [Enter] key.

CMOS SETUP UTILITY Copyright © 1984 – 2001 Award Software		
Advanced BIOS Features		
	DRAM timing by SPD	Enabled
X	DRAM Clock	100MHz
X	SDRAM Cycle Length	3
X	Bank Interleave	Disabled
	Memory Hole	Disabled
	PCI Master Pipeline Req.	Enabled
	P2C / C2P Concurrency	Enabled
	Fast R/W Turn Around	Disabled
	System BIOS Cacheable	Enabled
	Video RAM Cacheable	Enabled
	AGP Aperture size	128MB
	AGP-4X mode	Enabled
	AGP Driving Control	Auto
X	AGP Driving Value	DA
	On chip USB	Enabled
	USB Keyboard Support	Disabled
	Onchip Sound	Auto
	Onchip Modem	Disabled
	CPU to PCI Write Buffer	Enabled
	PCI Dynamic Bursting	Enabled
	PCI Master 0 WS write	Enabled
	PCI Delay Transaction	Enabled
	PCI #2 Access #1 Retry	Enabled
	AGP Master 1 WS Write	Disabled
	AGP Master 1 WS Read	Disabled
Item Help		
	Menu Level	▶
↑ ↓ → ← : Move Enter: Select + / - / PU / PD: value F10: save ESC: Exit F1: General Help F5 : Previous Values F6: Fail-Safe Defaults F7: Optimized Defaults		

The screen is not as long on your monitor. You can use the arrow keys to scroll down and up the page. The following explains all individual items and their meaning.

DRAM timing

If the DRAM Timing by SPD item is set to Enabled, the three items below will automatically be set by the BIOS. To do this the BIOS will read information out of the SPD EPROM that is located on the DIMM module, this information will tell the BIOS how to best access the memory. If you set this item to disabled, you can set the memory access items yourself. A word of warning though, if you are not familiar with DRAM settings do NOT make any changes (for the sake of system stability). Refer to the table below for the meaning of the individual DRAM items:

	Values	Meaning
<i>DRAM Clock</i>	100 MHz	If your DIMM modules are PC-100 compliant, select this setting.
	133 MHz	Only when your DIMM modules are PC-133 compliant can you use this setting. In case of instability always select 100MHz.
<i>DRAM Cycle Length</i>	2	2 is the fastest setting, use this setting only if your DIMM modules support CAS 2
	3	This is the default setting, always use this setting when the system is unstable.
<i>Bank Interleave</i>	Disabled	This is the safest setting (default).
	2bank	This setting is faster than disabled.
	4 bank	This is fastest setting.

Memory Hole

Some old devices need a memory hole to be present between 15M and 16M. CPU Cycles matching the hole will be passed on to the PCI bus instead of accessing the memory. Normally you can disable this setting, but if one of your devices needs it set it to enabled.

	Values	Meaning
<i>Memory Hole</i>	Disabled	There is no memory hole.
	15M – 16M	A memory hole exists between 15 and 16MB.

PCI Bus Timing Settings

The following settings are all related to PCI timing, there is no need to change them from their default setting unless you are an experienced user.

	Values	Meaning
<i>PCI Master Pipeline Req.</i>	Enabled	A PCI Master can request a pipeline.
	Disabled	No pipeline is granted to any Master.
<i>P2C / C2P concurrency</i>	Enabled	The CPU Host is free for other transactions while a PCI transaction takes place.
	Disabled	The CPU Host bus is always forced to wait while a PCI transaction takes place.
<i>Fast R-W turnaround</i>	Enabled	If a memory read is addressed to a location whose latest write is being held in a buffer before being written to memory, the read is satisfied through the buffer contents, and the read is not sent to the DRAM.
	Disabled	This feature is disabled.
<i>CPU to PCI write buffer</i>	Enabled	When enabled CPU writes to PCI are buffered, the CPU will not have to wait for the transaction to finish.
	Disabled	The CPU will have to wait for each PCI write to finish before a new write can be initiated.
<i>PCI dynamic bursting</i>	Enabled	All transactions are buffered, and transactions that are burstable (successive) will be conducted in a PCI burst transaction.
	Disabled	PCI burst transactions are disabled.
<i>PCI Master 0 WS write</i>	Enabled	
	Disabled	
<i>PCI delay transaction</i>	Enabled	The chipset has a write buffer that supports delayed transactions. Enable this item for PCI 2.1 compliance.
	Disabled	This will shut down use of the integrated buffer, no delayed transactions are allowed.
<i>PCI #2 Access #1 retry</i>	Enabled	When #2 (AGP port) tries to access #1 (PCI) and an error occurs, the transaction will be tried again.
	Disabled	No retry will occur.

AGP Settings

	Values	Meaning
<i>AGP Aperture Size</i>	4 – 128MB	This item allows setting of the portion of the main memory that is assigned to the AGP card. Normally about half or less of the total memory should be assigned. Choose from 4, 8, 16, 32, 64, and 128MB, default is 128MB.
<i>AGP 4X Mode</i>	Enabled	Set to enabled only if your AGP card supports 4x mode
	Disabled	For AGP cards that support 1x and 2x mode.
<i>AGP Driving Control</i>	Auto	The BIOS sets the value automatically
	Manual	The AGP Driving Value item below can be used to set the value.
<i>AGP Driving Value</i>	00 - FF	This value sets the timing of the signal that the video card driver uses to communicate over the AGP bus. The range is from 00 – FF Hex (00 – 255 Dec). The default value is DA. For more information on settings see the FAQ chapter.

AGP Bus Timing Settings

The following settings are related to AGP timing, there is no need to change them from their default setting unless you are an experienced user.

	Values	Meaning
<i>AGP Master 1 WS Write</i>	Enabled	AGP Writes are executed with 1 wait state, enable only if your AGP card supports this.
	Disabled	AGP Writes take longer than 1 wait state, default setting.
<i>AGP Master 1 WS Read</i>	Enabled	AGP Reads are executed with 1 wait state, enable only if your AGP card supports this.
	Disabled	AGP Reads take longer than 1 wait state, default setting.

Cache Settings

The following settings are related to cacheability of video RAM and the system BIOS, change them only if you are an experienced user.

	Values	Meaning
<i>System BIOS Cacheable</i>	Enabled	This will enable caching of the system BIOS memory section. This means that BIOS code can run faster when called often.
	Disabled	This will not cache any BIOS code, meaning that BIOS code will have to be read from memory each time.
<i>Video RAM Cacheable</i>	Enabled	This will enable caching of Video memory, which speeds up video operations. This can only be done if the Video card does not access the video memory itself in the mean time.
	Disabled	No caching of Video data is done, meaning that Video data will have to be read from / written to memory each time.

USB Settings

	Values	Meaning
<i>Onchip USB</i>	Enabled	This will enable use of the USB functionality integrated into the chipset.
	Disabled	If you do not make use of USB, use this setting.
<i>USB Keyboard Support</i>	Enabled	Set to enabled if you make use of a USB keyboard.
	Disabled	If you do not use a USB keyboard, use this setting.

On Chip Devices

	Values	Meaning
<i>Onchip Sound</i>	Auto	The BIOS scans for a on board Sound device and enables it.
	Disabled	The BIOS does not enable on board sound devices.
<i>Onchip Modem</i>	Auto	The BIOS scans for a on board Modem and enables it
	Disabled	The BIOS does not enable on board modems.

4-3-4 Integrated Peripherals

Select the [Integrated Peripherals] option from the Main Menu and press [Enter] key.

CMOS SETUP UTILITY Copyright © 1984 – 2001 Award Software		
Integrated Peripherals		
		Item Help
Onchip IDE Channel 0	Enabled	
Onchip IDE Channel 1	Enabled	
IDE Prefetch Mode	Enabled	Menu Level ▶
Primary Master PIO	Auto	
Primary Slave PIO	Auto	
Secondary Master PIO	Auto	
Secondary Slave PIO	Auto	
Primary Master UDMA	Auto	
Primary Slave UDMA	Auto	
Secondary Master UDMA	Auto	
Secondary Slave UDMA	Auto	
Init Display First	AGP	
IDE HDD Block Mode	Enabled	
Onboard FDD Controller	Enabled	
Onboard Serial Port 1	Auto	
Onboard Serial Port 2	Auto	
UART 2 Mode	Standard	
X IR Function Duplex	Half	
X TX, RX Inverting Enable	No, Yes	
Onboard Parallel Port	378/IRQ:	
Onboard Parallel Mode	Normal	
ECP Mode Use DMA	3	
Parallel port EPP type	EPP1.9	
Onboard legacy audio	Enabled	
Sound Blaster	Disabled	
SB IO Base Address	220H	
SB IRQ Select	IRQ 5	
SB DMA Select	DMA 1	
MPU-401	Disabled	
MPU-401 IC Address	330 – 33: H	
Game Port (200 – 207)	Enabled	
↑ ↓ → ← : Move Enter: Select + / - / PU / PD: value F10: save ESC: Exit F1: General Help F5 : Previous Values F6:Fail-Safe Defaults F7: Optimized Defaults		

The screen is not as long on your monitor. You can use the arrow keys to scroll up and down the page.

IDE Channel Settings

The following table explains IDE channel settings and what they mean:

	Values	Meaning
<i>Onchip IDE Channel 0</i>	Enabled	Enables the use of the first (primary) IDE channel.
	Disabled	This will disable the use of the first (primary) IDE channel.
<i>Onchip IDE Channel 1</i>	Enabled	Enables the use of the secondary IDE channel.
	Disabled	This will disable the use of the secondary IDE channel.
<i>xxx PIO</i>	Auto	The BIOS will assign a PIO mode to this device automatically when appropriate
	Mode 0	Select a PIO Mode here. PIO mode 0 is slowest, PIO mode 4 is fastest, check your HDD to see what PIO mode it supports.
	Mode 1	If your IDE device supports UDMA mode, then it best to enable that mode since it is considerably faster than PIO mode. (Set to auto for auto-detection)
	Mode 2	
	Mode 3	
<i>xxx - UDMA</i>	Auto	The BIOS will automatically use Ultra DMA Mode if the IDE device supports it.
	Disabled	This will disable the use of Ultra DMA for this device.
<i>IDE HDD Block Mode</i>	Enabled	Block mode allows faster transfer of data between the system and the HDD. Most modern HDDs support it.
	Disabled	Block Mode is not used.

Display Initialization

	Values	Meaning
<i>Init Display First</i>	PCI Slot	The BIOS will first search for a VGA adapter on the PCI bus, if one is found it will be used as primary display.
	AGP	The AGP Bus is first scanned.

Floppy Drive

	Values	Meaning
--	--------	---------

<i>Onboard FDD Controller</i>	Enabled	This will allow use of a floppy drive.
	Disabled	If you do not need a floppy drive, set this item to disabled.

COM ports (Serial Ports)

	Values	Meaning
<i>Onboard serial port 1 / 2</i>	Auto	The bios will automatically use serial ports.
	Disabled	If you do not need the serial port in question, set this item to disabled.
	3F8/IRQ4 2F8/IRQ3 3E8/IRQ4 2E8/IRQ3	Set an IO address and an IRQ to be used by serial ports.

IR Control

	Values	Meaning
<i>UART 2 Mode</i>	Standard	This will assign UART 2 to serial port 2, the IR port is disabled. The two items below can not be changed.
	ASKIR	Allows use of the IR port in ASKIR mode.
	HPSIR	Allows use of the IR port in HPSIR mode.
<i>IR Function Duplex</i>	Half	Select if your IR device supports Half duplex only.
	Full	For IR devices that support full duplex.
<i>TX, RX inverting enable</i>	No, No	Will not invert any signal
	No, Yes	Will invert the RX signal (Default)
	Yes, No	Will invert the TX signal
	Yes, Yes	Will invert both signals

Parallel Port (Printer Port)

	Values	Meaning
--	--------	---------

<i>On board Parallel Port</i>	Disable	Disables use of the parallel port.
	3BC / IRQ7	
	378 / IRQ7	Select an IO Address and an IRQ to be used by the parallel port.
	278 / IRQ5	
<i>On board Parallel Mode</i>	Normal	This is the standard printer port configuration.
	EPP	Enables use of EPP devices.
	ECP	Enables use of EPP devices.
	EPP / ECP	Enables use of EPP / ECP devices.
<i>ECP mode use DMA</i>	1 or 3	Select either DMA channel 1 or 3 (This is only relevant if ECP was selected above). Default is channel 3.
<i>Parallel port EPP type</i>	EPP1.7 or EPP1.9	Select the EPP mode. (This is only relevant if EPP was selected above). Default is EPP1.9.

Legacy Audio

	Values	Meaning
<i>Onboard Legacy Audio</i>	Enabled	This will software that requires legacy audio (such as DOS) games to function properly.
	Disabled	Legacy Audio is disabled.
<i>Sound Blaster</i>	Enabled	If you added a Sound Blaster or compatible sound card to your system, the three items below allow specifying details about IO and IRQ..
	Disabled	No Sound Blaster (or compatible) cards in the system.
<i>SB IO Base Address</i>	220H – 280H	Specify the IO Base Address for your Sound Blaster card. Choose from 220, 240, 260 and 280H. Default is 220H.
<i>SB IRQ Select</i>	5,7,9,10	Specify the IRQ for your Sound Blaster card. Default is IRQ 5.
<i>SB DMA Select</i>	0, 1, 2, 3	Specify the DMA Channel for your Sound Blaster card. The Default is DMA Channel 1.

MIDI

	Values	Meaning
--	--------	---------

<i>MPU-401</i>	Enabled	Allows of use of MIDI.
	Disabled	No need for MIDI.
<i>MPU-401 IO address</i>	300 – 303	Select the IO address for the MIDI functionality. Choose from 300 – 303, 310 – 313, 320 – 323 and 330 – 333.
	330 – 333	

Game Port

	Values	Meaning
<i>Game Port</i>	Enabled	This will allow you to make use of the game port (joy sticks etc)
	Disabled	If you do not need the game port, set this item to disabled.

4-3-5 Power Management Setup

Select the [Power Management Setup] option from the Main Menu and press [Enter] key.

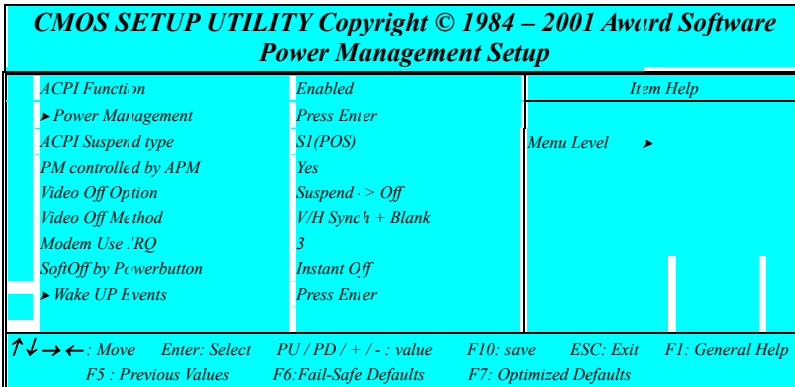

ACPI Function

For a detailed description of ACPI and what it does, refer to the FAQ chapter, ACPI section. ACPI can be either enabled or disabled on this BIOS Setup page. For the ACPI Suspend type there are two options:

- S1 (POS)
- S3 (STR)

STR is the so called Suspend to RAM suspend type. This will save the system context all to RAM and it will shut down the system. The standby voltage of the power supply backs up the RAM contents. (Therefore we recommend to use a power supply that can support a current of 1A at the standby line). When the user want the system to wake up again, the system is powered up, the BIOS detects a STR and the system restores itself to where it left off. Start up time is much faster than a normal boot would take.

Power Management

Pressing [enter] when the power management item is selected will have the following sub menu appear:



<i>Power Management</i>	<i>User Define</i>	<i>Item Help</i>
<i>HDD Power Down</i>	<i>Disabled</i>	
<i>Doze Mode</i>	<i>Disabled</i>	<i>Menu Level</i> >>
<i>Suspend Mode</i>	<i>Disabled</i>	

Refer to the following table for an explanation of the items above:

	Values	Meaning
<i>Power Management</i>	User Define	The three items below can be set by the user
	Min Saving	The three items below are set to: disabled, 1 hour, 1hour respectively.
	Max Saving	The three items below are set to: disabled, 1 min, 1min respectively.
<i>HDD Power Down</i>	1 – 15 Min	Will power down the HDD if it is idle for the amount of minutes selected here.
	Disabled	Will not power down the HDD.
<i>Doze Mode</i>	1 Min to 1 Hour	Selecting a time will force the system into doze mode after being idle for that time. Choose from the following time intervals: 1, 2, 4, 6, 8, 10, 20, 30, 40 min and 1 Hour
	Disabled	The system will never enter doze mode.
<i>Suspend Mode</i>	1 Min to 1 Hour	Selecting a time will force the system into suspend mode after being idle for that time. Choose from the following time intervals: 1, 2, 4, 6, 8, 10, 20, 30, 40 min and 1 Hour
	Disabled	The system will never enter suspend mode.

PM control

<i>PM control by APM</i>	Yes	Power Management will be done through the APM (Advanced Power Management) interface. Select this setting for Windows OSes. (Not Win NT)
	No	The BIOS will control PM directly.

Video Options

--	--	--	--

<i>Video Off Option</i>	Always On	The monitor will always be on, no matter what the state of the system
	Suspend-> Off	The monitor will be turned off in suspend mode. The item below will specify what off method to use.
	All modes -> Off	The monitor will be turned off in doze and suspend mode. The item below will specify what off method to use.
<i>Video Off Method</i>	Blank Screen	The screen will be blank (black) only.
	V/H sync + blank	The vertical and horizontal sync pulses will be stopped, and the screen will be blank.
	DPMS support	If your monitor supports DPMS, it can be switched off through that.

Modem IRQ

<i>Modem Use IRQ</i>	NA	This disables the modem IRQ
	3 - 11	Select an IRQ line that will be assigned to your modem here. Choose from: 3 (default), 4, 5, 7, 9, 10, 11.

Power Button

<i>Soft off by power button</i>	Instant-off	Switches the system off immediately when pressing the power button.
	Delay 4 Sec	This requires you to press the power button for at least 4 seconds before the system switches off.

Wake Events

When the system has entered doze or suspend mode, it can wake up through a wake event. These wake up events are triggered by interrupts that are monitored by the BIOS. If you press [Enter] when the Wake Up Events item is selected you will see the following sub menu appear:

**CMOS SETUP UTILITY Copyright © 1984 – 2001 Award Software
Wake Up Events**

VGA	OFF	Item Help
LPT & COM	LPT / COM	Menu Level >>
HDD & FDD	ON	
PCI Master	OFF	
Modem Ring Resume	Disabled	
RTC Alarm Resume	Disabled	
Date (of Month)	0	
Resume time (hh:mm:ss)	0 : 0 : 0	
Primary INTR	ON	
> IRQs Activity Monitoring	Press Enter	

Refer to the following table for more details:

VGA	OFF	Will not allow the system to wake up on the VGA IRQ
	ON	When a VGA IRQ occurs the system will wake up.
LPT & COM	None	Neither LPT or COM IRQs will wake the system up.
	LPT	A LPT (printer port) IRQ will wake up the system
	COM	A COM (serial port) IRQ will wake up the system
	LPT/COM	Both LPT and COM can wake up the system
HDD & FDD	OFF	Will not allow the system to wake up on HDD / FDD IRQs
	ON	When a HDD / FDD IRQ occurs the system will wake up.
PCI Master	OFF	Will not allow the system to wake up on a IRQ from a PCI master.
	ON	The system will wake up on a PCI master IRQ.
Modem Ring Resume	Disabled	The system will not wake up on a modem ring signal.
	Enabled	When the modem detects a ring signal, the system will wake up.
RTC Alarm Resume	Disabled	The system will not wake up on a RTC Alarm.
	Enabled	When the time set in the two items below is reached, the RTC will generate an IRQ and the system will wake up.
Date (of Month)	0 - 31	Set the day of month for the system to wake up on.
Resume time	xx:xx:xx	Set the time (hh:mm:ss) for the system to wake up on.
Primary INTR	ON	You can select IRQs that allow the system to wake up in the IRQ Activity Monitoring item below.

	OFF	The IRQ Activity Monitoring item is disabled
--	-----	--

IRQ Activity Monitoring

If you select ON for the Primary INTR item, pressing [Enter] on the IRQ Activity Monitoring item will show the following sub menu.

<i>CMOS SETUP UTILITY Copyright © 1984 – 2001 Award Software</i>		
<i>Wake Up Events</i>		
		<i>Item Help</i>
<i>IRQ3 (COM 2)</i>	<i>Enabled</i>	
<i>IRQ4 (COM 1)</i>	<i>Enabled</i>	
<i>IRQ5 (LPT 2)</i>	<i>Enabled</i>	
<i>IRQ6 (Floppy Disk)</i>	<i>Enabled</i>	
<i>IRQ7 (LPT 1)</i>	<i>Enabled</i>	
<i>IRQ8 (RTC Alarm)</i>	<i>Disabled</i>	
<i>IRQ9 (IRQ2 Redirection)</i>	<i>Disabled</i>	
<i>IRQ10 (Reserved)</i>	<i>Disabled</i>	
<i>IRQ11 (Reserved)</i>	<i>Disabled</i>	
<i>IRQ12 (PS/2 Mouse)</i>	<i>Enabled</i>	
<i>IRQ13 (Coprocessor)</i>	<i>Enabled</i>	
<i>IRQ14 (HDL)</i>	<i>Enabled</i>	
<i>IRQ15 (Reserved)</i>	<i>Disabled</i>	
		<i>Menu Level >>></i>

You can select IRQs that will allow the system to wake up if activity is detected on them. Setting to enabled allows an IRQ to wake up the system.

4-3-6 PnP / PCI Configurations

Select the [PnP / PCI Configurations] option from the Main Menu and press [Enter] key.

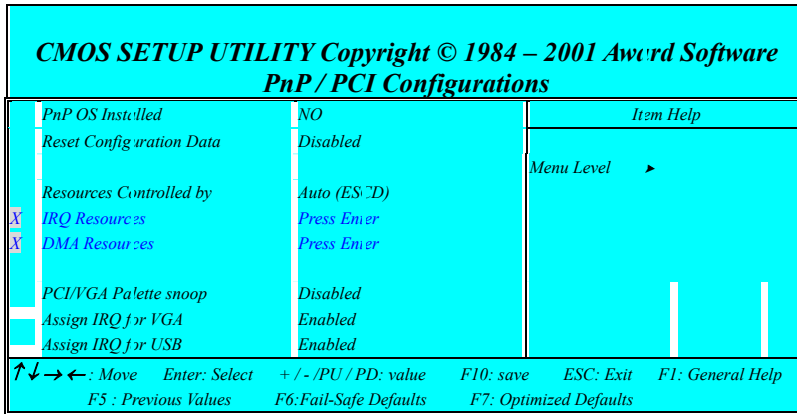

PnP Aware OS

	Values	Meaning
PnP OS Installed	No	If your OS is not capable of handling PnP (Such as Win NT) this item should be set to No.
	Yes	If your OS is PnP aware (Such as windows 95, 98, 2000 etc) set this item to Yes.

Reset Configuration Data

	Values	Meaning
Reset Configuration Data	Disabled	This will not reset the system configuration data (IRQs, DMAs) on reboot.
	Enabled	This will reset the configuration data. Remember to enable this item every time you make a change to your system (such as switching PCI cards etc).

PCI / VGA Palette Snoop

	Values	Meaning
--	--------	---------

<i>PCI / VGA Palette Snoop</i>	Disabled	Default setting.
	Enabled	This will allow the system to look at the palette the VGA uses to display. Some applications speed up with this setting but it is mostly obsolete.

Assign IRQs

	Values	Meaning
<i>Assign IRQ for VGA</i>	Enabled	This will assign an interrupt to your VGA card. Make sure to enable this item if your card needs one.
	Disabled	The BIOS will not assign an interrupt to the VGA card
<i>Assign IRQ for USB</i>	Enabled	If you plan to make use of USB devices, set this item to enabled.
	Disabled	The BIOS will not assign an interrupt to USB.

Resources

If you set the Resources Controlled by item to Auto (ESCD), the BIOS will manage all resources for you. If you set it to manual to two items below will allow you to assign the resources manually.

	Values	Meaning
<i>IRQ-x assigned to (x = 3 to 15)</i>	PCI/ISA	This setting means the BIOS will assign the interrupt as needed.
	PnP	This means that it is not fixed to a device
	Legacy ISA	If you need to make sure that a certain interrupt is assigned to an ISA device, set that interrupt to legacy ISA.
<i>DMA-x assigned to (x = 0, 1, 3, 5, 6, 7)</i>	PCI/ISA	This setting means the BIOS will assign the DMA Channel as needed, it is not fixed to a device
	PnP	
	Legacy ISA	If you need to make sure that a certain DMA channel is assigned to an ISA device, set that channel to legacy ISA.

4-3-7 PC Health Status

Select the [PC Health Status] option from the Main Menu and press [Enter] key.

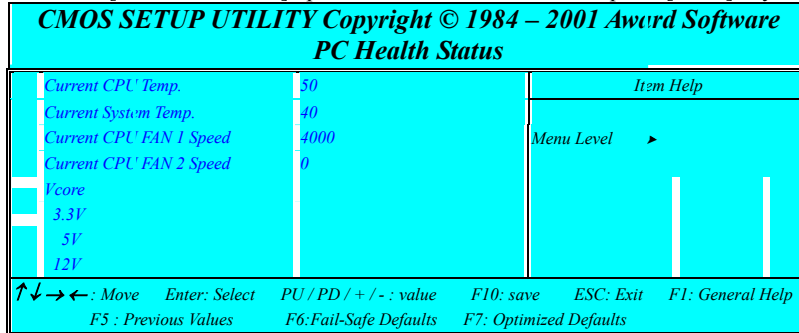

The values shown in this picture are just examples, the values shown on screen reflect the real status of your system. All items on this page are read only. A short description of each item follows:

	Meaning
Current CPU Temp.	This item reflects the CPU temperature as measured by RT1, the thermistor located under the CPU. Temperatures over 60 degrees are too high and a better cooling solution must be found for the CPU
Current system Temp.	This item reflects the system temperature as measured by RT2, the thermistor located close to the BIOS IC. Temperatures over 45 degrees are too high and a better cooling solution must be found for the computer case (like adding a case FAN)
Current CPU FAN 1 Speed	The speed of the CPU FAN connected to FAN 1 is displayed here. If you have problems with this item, please refer to the FAQ chapter boot section.
Current CPU FAN 2 Speed	The speed of the CPU FAN connected to FAN 2 is displayed here
Voltage X	The Voltage for the voltage line (Vcore, 3.3V, 5V, 12V) are displayed here. A small deviation of the ideal value is not a problem because voltages always fluctuate.

4.3.8 Frequency / Voltage Control

Select the [Frequency / Voltage Control] option from the Main Menu and press [Enter] key.

CMOS SETUP UTILITY Copyright © 1984 – 2001 Award Software		
Frequency / Voltage Control		
Auto Detect DIMM / PCI Clock	Disabled	Item Help
Spread Spectrum Modulated	Disabled	
CPU Host / PCI Clock	Default	Menu Level ▶
CPU Core Voltage	Default	
↑↓ → ← : Move Enter: Select + / - / PU / PD: value F10: save ESC: Exit F1: General Help F5 : Previous Values F6: Fail-Safe Defaults F7: Optimized Defaults		

The following table will explain the items in more detail:

	Values	Meaning
Auto Detect DIMM / PCI Clock	Enabled	If set to enabled the BIOS will detect the values for the PCI and DIMM clocks
	Disabled	If disabled, the BIOS will use the values set on this page and on the Advanced Chipset Features page.
Spread Spectrum Modulated	Enabled	If set to enabled, the clock generator will modulate each clock signal with a low frequency signal. This will improve EM (Electro-Magnetic) Interference.
	Disabled	The clock generator will not modulate the clock signals
CPU Host / PCI Clock	Default Or 90/30 – 166/41	This item allows setting of the CPU and PCI bus frequencies. If set to default, the BIOS will select the values automatically. Otherwise, if you have a 100MHz FSB CPU we recommend you use the 100 / 33 Setting. If you have a 133Mhz FSB CPU we recommend you use the 133 / 33 setting. Any other setting will make the system operate without its specifications and we cannot guarantee proper functioning in that case. The other settings are:
	90 / 30	95 / 31
	100 / 33	101 / 33
	102 / 34	
	103 / 34	105 / 35
	107 / 35	109 / 36
	110 / 36	
	111 / 37	113 / 37
	115 / 38	117 / 39
	120 / 40	
125 / 31	130 / 32	
133 / 33	135 / 33	
137 / 34		
139 / 34	140 / 35	
143 / 35	145 / 36	
148 / 37		
150 / 37	155 / 38	
166 / 41		

<i>CPU Core Voltage</i>	Default Or 1.5 – 1.85	This item allows setting of the CPU core voltage. If set to default, the BIOS will select the value automatically. If you set it manually yourself, be sure not to increase the voltage too much, since this may lead to CPU damage. The possible voltages are: 1.5V, 1.55V, 1.6V, 1.65V, 1.70V, 1.75V, 1.80V, 1.85V
-------------------------	---	--

4-3-9 Passwords

The BIOS Setup program allows you to specify passwords in the Main menu. The passwords control access to the BIOS during system startup. The passwords are not case sensitive. In other words, it makes no difference whether you enter a password using upper or lowercase letters. The BIOS Setup program allows you to specify two separate passwords:

- Supervisor password
- User password.

The function of the supervisor password depends on the setting for the Security Option item on the Advanced BIOS Features page. If set to System, the supervisor password must be given every time the system boots, if set to setup, the password must be given only when you want to enter the BIOS Setup.

The user password has the same functionality, with the only difference that anybody logging in with the user password may only change the user password when entering the BIOS Setup page. All other items in the BIOS Setup will be disabled (unchangeable).

When both passwords are disabled, anyone may access all BIOS Setup program functions.

Setting the password

To set the Supervisor password, select the Set Supervisor Password item in the main BIOS Setup Menu. Now a dialog will pop up asking you to enter a password.

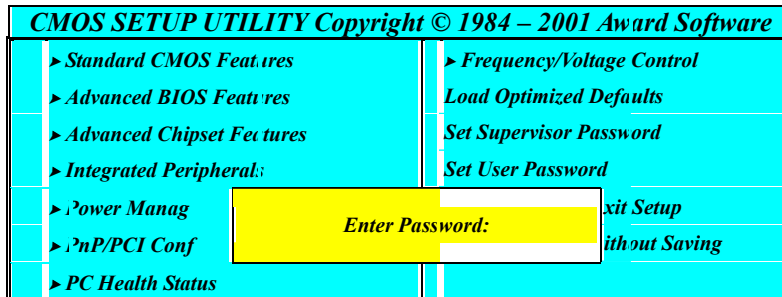

Now you can enter your password, after entering the password the menu will pop up again and will ask you to reconfirm the password. After entering and pressing [enter] the password will be stored to CMOS RAM and the password will be enabled.

Disabling the password

To disable the password, simply press [enter] without entering any other letters or numbers. This will disable the password, the BIOS will tell you by displaying the following dialog:

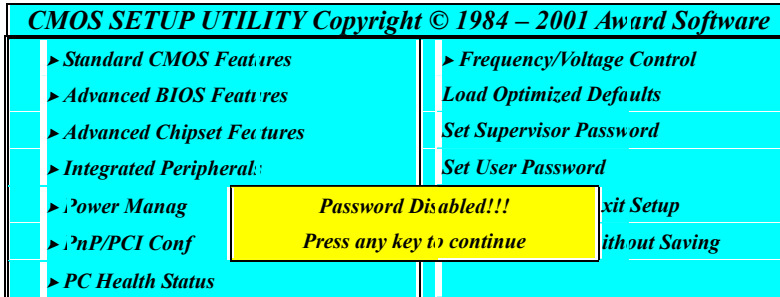

Password Unknown

If you forgot the password, you can clear the password by erasing the CMOS RAM. The RAM data containing the password information is powered by the onboard button cell battery. Please refer to the CMOS RAM section earlier in this chapter. After clearing the CMOS memory, hold down <Delete> during bootup and enter BIOS setup to re-enter user preferences.

Chapter 5 Frequently Asked Questions

5-1 Boot Issues

AWARD BIOS Beep Codes

In case of errors the AWARD BIOS will send beeps to the system speaker. Although the spoken error messages replace the beep codes, it may still be convenient to know what the beep codes mean.

Beeps	Meaning
No beep at all	This means your motherboard is dead, either due to a defective or underrated power supply, poorly seated CPU or RAM, or a Dead-On-Arrival (DOA) board.
One beep	The board is working fine.
Long-short-short	This means no video card detected (or a poorly seated video card)
Repeated single tone	This is a memory problem (could be the DIMM, the memory controller or the internal CPU cache memory).
two-tone siren	Generally caused by overheating or out of specification voltages.
Rapid beeps	this means a key is stuck on your keyboard, it is not properly plugged in, or the keyboard is incompatible in some way

The AWARD BIOS offers no other codes, any other error messages are displayed on the screen. (As explained above)

Below you will find a list of other possible causes of boot problems. Please go through them one by one to find the source of your boot problem if the methods described above did not help you.

AGP Speed setting

If AGPx4 is enabled in the BIOS (Advanced Chipset Features page) and you do not use AGP card, or your AGP graphics card that doesn't support 4x mode? disable it in those cases

USB devices

The board may fail to start the memory check during the boot sequence, this may be related to a USB device (such as a scanner) attached to the system. Try disconnecting all USB devices from the system.

Proper insertion of the CPU and other parts

If the board does not boot up at all but the FANs are working it may be that the CPU is incorrectly seated in the motherboard. Also, if using an AGP graphics card, verify that it is seated correctly. Try without the AGP card screwed into the case, this can sometimes cause the AGP card to rest in the slot at an angle. Also try reseating your DIMMs (Press them into their sockets firmly, but do not apply too much force)

My machine does not boot, FANs turn on, but the floppy light just stays on

Your floppy disk cable may be connected the wrong way round. Try reversing it. If this doesn't help check the floppy drive ribbon cable. At one end of the cable, seven of the strands should be split and twisted compared with the rest of the ribbon. If not, and your cable is completely flat throughout, then you need to get a ribbon cable with a "twist" in.

5-2 System Cooling

In older computer systems cooling was not a big issue. But with CPU speed constantly increasing improper cooling of the system as a whole can lead to hard to trace problems. This motherboard comes with 4 FAN Headers, make use of them!

The following is an excerpt from a warning AMD released on this issue:

The new PGA (Pin Grid Array) AMD Athlon(tm) and AMD Duron(tm) processors have very different thermal specifications from any preceding AMD processor. Due to these differences, the AMD Athlon and AMD Duron processors should NEVER be run without a heatsink, not even for a few seconds. Doing so will cause the processor to overheat and fail immediately, resulting in permanent damage. While testing a processor by booting it up for several seconds without a heatsink installed may be common industry practice, it should never be attempted with the new PGA AMD Athlon and AMD Duron processors... Additionally, the new exposed flip-chip design of the PGA AMD Athlon and AMD Duron processors requires a clip load between 12 and 24 pounds (typically 16 pounds), a load that may not be met by most older heatsink designs. A thermal compound, such a thermal grease or phase-change material, must ALWAYS be applied between the processor and heatsink as well. Typically, AMD recommended heatsinks that include the thermal compound. If the thermal compound must be purchased separately, a list of suggested compounds can be found in the 'AMD Thermal, Mechanical, and Chassis Cooling Design Guide'. Refer to the AMD website.

5-2-1 Suitable Socket A CPU coolers

AMD maintains a list of approved thermal solutions for the Athlon processor. Please do NOT use Pentium heatsinks, Duron processors may crack when trying to force Pentium heatsinks and fans onto them. The processors have slightly different sizes so this is not a good idea. Make sure the cooler is approved for Socket A use.

In addition Duron processors come with four little "feet" on top of the processor, do not buy a cooler which also has these feet (or remove them if it does). Eight feet are bad news, since the cooler won't make proper contact with the CPU and it may get damaged. Please refer to the AMD website at www.amd.com to find a list of approved cooling FANs. We strongly recommend that you use only FANs found there.

Why is my CPU running so hot?

If your CPU temperature is over 70 degrees C you have a cooling problem. By far the most common cause of this is the improper removal of the protective square over the pre-applied thermal paste. (See the hardware installation CPU section). For the adventurous, you may remove the original thermal paste layer by using a solvent (such as oil free nail varnish remover), and apply a standard thermal conducting compound or Artic Silver instead. Make sure that the thermal contact between CPU and Heatsink is OK.

Take care in connecting the heatsink to the CPU

Note that the CPU core (the little raised green rectangle on the CPU) is very fragile. It is very important to not use any horizontal force or any rocking motions when installing a CPU FAN. The heatsink can grind the corners and edges off of the CPU incredibly easily. It's fairly loud when it happens, Dealers will generally refuse a refund when you damage your CPU like this therefore be CAREFULL.

Normal CPU temperature readings

The temperature of your CPU depends upon its speed in MHz, the core voltage, your CPU FAN, the movement of air through your case and the ambient air temperature. However, a typical CPU temperature (not overclocked) as measured by the on board thermister should be around 40-50 degrees Celcius. The case temperature should be approximately 5-10 degrees above room temperature (or less). Do not worry if your figures are slightly higher than these, but you should begin to think about improved cooling if your CPU temperature is 50 degrees C or higher. The maximum temperature is 90 degrees C according to AMD, but your processor is very unlikely to be stable at temperatures near this! Also, processor life is directly related to temperature.

Maximum FAN Current and Wattage

The maximum current that the FAN headers on the KTAPRO board can provide is 0.5A. Because Wattage = Voltage x Current (I), this means that at 12V the wattage the KTAPRO can support on each header is 6W.

5-3 Video Issues

Setting AGP speed

In the BIOS setup on the Advanced Chipset Features page you can set the AGP 4X mode item to either enabled or disabled. It is not possible to select between AGPx1 and AGPx2 using the BIOS, this is selected automatically depending on the AGP card you use.

If you use a Creative graphics card the AGP speed can be selected using Creative's apwizard which is available for download at www.creative.com. Note that this utility will not work with non-Creative graphics cards.

determining AGP speed

To determine the AGP speed, a utility such as WCPUID (available under downloads at <http://www.h-oda.com>) can be used.

Setting the AGP aperture

The AGP aperture is the official name for the stretch of main memory that is reserved for AGP. The size of the aperture can be set through the BIOS setup. Go to the Advanced Chipset Features page and use the AGP Aperture size item to set the size. It is advisable to set the AGP aperture to half the system RAM - i.e. set to 32MB with 64MB of RAM. The default value is 128MB, which is best set back if you have less than 256MB of memory.

AGP driving control explained

The manual hex range (00h-FFh) allows the user to set the timing of the signal that the video card driver uses to communicate over the AGP bus. Default for the AGP Driving control is 'Auto', this is the lowest-common denominator settings that provides the widest compatibility.

As for how to find out the specific settings recommended for various video cards, the best recommendation would be to contact your video card vendor first (attempting to contact the chipset provider as well may be advisable). Ask them what their recommended manual timing is.

5-4 Memory Issues

Memory related BIOS settings

Depending on the type and speed of your SDRAM memory settings will be different. Below two types of settings will be given, one optimized for speed, and one optimized for stability. If your system is unstable with the speed optimized settings, try increasing the IO voltage one step. (This will have your system run out of specs, we recommend you use the settings optimized for stability instead). Moving the DIMM module to another DIMM slot may sometimes help as well. You should normally place your first SDRAM module in DIMM3, the next in DIMM2 and so on. DIMM3 is furthest from the processor.

Settings optimized for speed

BIOS Page	Item	Setting
Advanced Chipset Features	DRAM timing by SPD	Disabled
Advanced Chipset Features	DRAM Clock	100MHz for PC-100 133MHz for PC-133
Advanced Chipset Features	SDRAM Cycle length	2 for CAS 2 PC133 SDRAM 3 for PC100 SDRAM, most unbranded PC133 SDRAM and PC133 CAS 3 SDRAM
Advanced Chipset Features	Bank Interleave	4 bank
Advanced Chipset Features	Fast R-W Turn Around	Enabled

Settings optimized for stability

If your machine is experiencing stability problems and you suspect your SDRAM is the cause of the problem, you will need to set the SDRAM on its most conservative settings. First try:

BIOS Page	Item	Setting
Advanced Chipset Features	DRAM timing by SPD	Enabled

This will force the system to use the timing as specified in the SPD EPROM on the SDRAM module. If this does not work, use the following conservative settings:

BIOS Page	Item	Setting
Frequency / Voltage Control	CPU host/PCI clock	100/33
Advanced Chipset Features	DRAM timing by SPD	Disabled
Advanced Chipset Features	DRAM Clock	100MHz
Advanced Chipset Features	SDRAM Cycle length	3
Advanced Chipset Features	Bank Interleave	Disabled
Advanced Chipset Features	Fast R-W Turn Around	Disabled

Typical signs of SDRAM instability include failure to pass the Power On Self Test (POST) when booting, frequent error messages from Windows describing Page Faults or other system errors and random freezes of the machine requiring a reset.

Support of DDR SDRAM

The KTAPRO motherboard is unable to support DDR (Double Data Rate) SDRAM due to limitations of the VIA Apollo KT133A chipset.

Support of ECC SDRAM

The KTAPRO motherboard is unable to support ECC (Error Correcting) SDRAM due to limitations of the VIA Apollo KT133A chipset.

Chapter 6 Appendix

standard ISA IO map

IO Address Range	IO Device
000 – 01F	DMA Controller 1
020 – 03F	Interrupt Controller 1
040 – 05F	System Timer
060 – 06F	Keyboard Controller
070 – 07F	Real Time Clock, CMOS and NMI mask
080 – 09F	DMA page register
0A0 – 0BF	Interrupt Controller 2
0C0 – 0DF	DMA Controller 2
0F0 – 0FF	Math Coprocessor
1F0 – 1F8	Hard Disk Controller
200 – 207	Game IO
20C – 20D	Reserved
21F	Reserved
278 – 27F	Parallel Printer Port 2
2B0 – 2DF	Alternate Enhanced Graphics Adapter
2E1	GPIB Adapter 0
2E2 – 2E3	Data Acquisition Adapter 0
2F8 – 2FF	Serial Port 2
300 – 31F	Prototype Card
360 – 363	PC Network low address
364 – 367	Reserved
368 – 36B	PC Network high address
36C – 36F	Reserved
378 – 37F	Parallel Printer Port 1
380 – 38F	SDLC, Bisynchronous 2
390 – 393	Cluster
3A0 – 3AF	SDLC, Bisynchronous 1
3B0 – 3BF	Monochrome Display and Printer Adapter
3C0 – 3CF	Enhanced Graphics Adapter
3D0 – 3DF	Color / Graphics Monitor Adapter
3F0 – 3F7	Diskette Driver Controller
3F8 – 3FF	Serial Port 1
6E2 – 6E3	Data Acquisition Adapter 1
790 – 793	Cluster Adapter 1
AE2 – AE3	Data Acquisition Adapter 2
B90 – B93	Cluster Adapter 2
EE2 – EE3	Data Acquisition Adapter 3