

Preface

Copyright

This publication, including all photographs, illustrations and software, is protected under international copyright laws, with all rights reserved. Neither this manual, nor any of the material contained herein, may be reproduced without written consent of the author.

Version 1.0

Disclaimer

The information in this document is subject to change without notice. The manufacturer makes no representations or warranties with respect to the contents hereof and specifically disclaims any implied warranties of merchantability or fitness for any particular purpose. The manufacturer reserves the right to revise this publication and to make changes from time to time in the content hereof without obligation of the manufacturer to notify any person of such revision or changes.

Trademark Recognition

Microsoft, MS-DOS and Windows are registered trademarks of Microsoft Corp.

MMX, Pentium, Pentium-II, Pentium-III, Celeron are registered trademarks of Intel Corporation.

Other product names used in this manual are the properties of their respective owners and are acknowledged.

**Copyright © 2001
All Rights Reserved
KOB KT266 FSX, V1.0**

Federal Communications Commission (FCC)

This equipment has been tested and found to comply with the limits for a Class B digital device, pursuant to Part 15 of the FCC Rules. These limits are designed to provide reasonable protection against harmful interference in a residential installation. This equipment generates, uses, and can radiate radio frequency energy and, if not installed and used in accordance with the instructions, may cause harmful interference to radio communications. However, there is no guarantee that interference will not occur in a particular installation. If this equipment does cause harmful interference to radio or television reception, which can be determined by turning the equipment off and on, the user is encouraged to try to correct the interference by one or more of the following measures:

- Reorient or relocate the receiving antenna.
- Increase the separation between the equipment and the receiver.
- Connect the equipment onto an outlet on a circuit different from that to which the receiver is connected.
- Consult the dealer or an experienced radio/TV technician for help.

Shielded interconnect cables and a shielded AC power cable must be employed with this equipment to ensure compliance with the pertinent RF emission limits governing this device. Changes or modifications not expressly approved by the system's manufacturer could void the user's authority to operate the equipment.

Declaration of Conformity

This device complies with part 15 of the FCC rules. Operation is subject to the following conditions:

- This device may not cause harmful interference, and
- This device must accept any interference received, including interference that may cause undesired operation.

Canadian Department of Communications

This class B digital apparatus meets all requirements of the Canadian Interference-causing Equipment Regulations.

Cet appareil numérique de la classe B respecte toutes les exigences du Règlement sur le matériel brouilleur du Canada.

About the Manual

The manual consists of the following:

Chapter 1
Introducing the Mainboard

Describes features of the mainboard, and provides a shipping checklist.

Go to ⇒ page 1

Chapter 2
Installing the Mainboard

Describes installation of mainboard components.

Go to ⇒ page 7

Chapter 3
Using BIOS

Provides information on using the BIOS Setup Utility.

Go to ⇒ page 31

Chapter 4
Using the Mainboard Software

Describes the mainboard software.

Go to ⇒ page 63

Appendix A
Setting Jumpers

Provides a reference to the jumpers on the mainboard.

Go to ⇒ page 68

TABLE OF CONTENTS

Preface	i
CHAPTER 1	1
Introducing the Mainboard	1
<i>Introduction</i>	1
<i>Checklist</i>	1
Standard Items	1
<i>Features</i>	2
<i>Mainboard Components</i>	4
<i>Choosing a Computer Case</i>	6
CHAPTER 2	7
Installing the Mainboard	7
<i>Safety Precautions</i>	7
<i>Quick Guide</i>	8
<i>Checking Jumper Settings</i>	9
Setting Jumpers	9
Checking Jumper Settings	10
Jumper Settings	11
<i>Installing the Mainboard in a Case</i>	13
<i>Connecting Case Components</i>	14
The Panel Connector	15
<i>Installing Hardware</i>	16
Installing the Processor	16
Install Memory Modules	18
Installing a Hard Disk Drive/CD-ROM	20
Installing a Floppy Diskette Drive	23
Installing Add-on Cards	24
Connecting Optional Devices	26
<i>Connecting I/O Devices</i>	29
External Connector Color Coding	30
CHAPTER 3	31
Using BIOS	31
<i>About the Setup Utility</i>	31
The Standard Configuration	32
Entering the Setup Utility	33
Updating the BIOS	34

<i>Using BIOS</i>	35
Standard CMOS Features	35
Advanced BIOS Setup Option.....	38
Advanced Chipset Features Option	41
Integrated Peripherals Option.....	46
Power Management Setup Option.....	50
PNP/PCI Configuration Option.....	56
PCI Health Status Option	58
Frequency/Voltage Control.....	59
Load Fail-Safe Defaults Option.....	60
Load Optimized Defaults Option	60
Set Supervisor and User Passwords Options	61
Save & Exit Setup Option	62
Exit Without Saving	62
CHAPTER 4	63
Using the Mainboard Software	63
<i>About the Software CD-ROM</i>	63
<i>Drivers Installation</i>	64
<i>Utility Software Reference</i>	66
APPENDIX A	68
Setting Jumpers	68
The Panel Connector	70

Introducing the Mainboard

Introduction

Congratulations on purchasing the KOB KT266 FSX mainboard. The KOB KT266 FSX mainboard is an ATX mainboard that uses a 4-layer printed circuit board and measures 220 mm x 304 mm. The mainboard features a Socket 462 that accommodates AMD Athlon processors supporting frontside bus (FSB) speeds up to 133 MHz.

The KOB KT266 FSX incorporates the VIA VT8366 Northbridge and VT8233 Southbridge chipsets which combine support for the new high-bandwidth Double Data Rate (DDR) 266 SDRAM, and the AC 97 audio codec.

Note: SDRAM provides 800 MBps or 1 GBps data transfer depending on whether the bus is 100 MHz or 133 MHz. Double Data Rate SDRAM (DDR SDRAM) doubles the rate to 1.6 GBps or 2.1 GBps by transferring data on both the rising and falling edges of the clock. DDR SDRAM uses additional power and ground lines and requires 184-pin DIMM modules rather than the 168-pin DIMMs used by SDRAM.

Checklist

Compare the mainboard's package contents with the following checklists:

Standard Items

- One mainboard
- One diskette drive ribbon cable and bracket
- One IDE drive ribbon cable and bracket
- One auto-install software support CD
- This user's manual

Features

Processor	<p>The KOB KT266 FSX mainboard uses an AMD 462-pin Socket A that has the following features:</p> <ul style="list-style-type: none">• Supports 100/133 MHz frontside bus (FSB)• Accommodates AMD Athlon/Duron processors
Chipset	<p>The VIA KT266 Northbridge and Southbridge chipsets are based on an innovative and scalable architecture with proven reliability and performance. A few of the chipset's advanced features are:</p> <ul style="list-style-type: none">• An advanced V-Link memory controller architecture that provides the bandwidth and performance necessary for even the most demanding Internet and 3D graphics• A low 2.5-volt DDR266 SDRAM power consumption which makes it an excellent solution for notebooks and desktops with a small footprint• Support for a 4xAGP interface providing vivid 3D graphics and video performance• An ATA 100 interface on the chipset, which helps boost system performance by providing a high-speed connection to ATA 100 Hard Disk Drives, delivering maximum sustained data transfer rates of 100 MB/sec <p>Additional key features include support for six USB ports, an AC 97 link for audio and modem, hardware monitoring, and ACPI/OnNow power management.</p>
Memory	<p>The mainboard accommodates DDR200/266 or PC1600/PC2100 DDR SDRAM (Double Data Rate Synchronous DRAM) up to 3 GB using three 2.5V unbuffered DIMM modules.</p>
VGA	<p>The KOB KT266 FSX includes a 4xAGP slot that provides four times the bandwidth of the original AGP specification. AGP technology provides a direct connection between the graphics subsystem and the processor so that the graphics do not have to compete for processor time with other devices on the PCI bus.</p>

AC'97 Audio Codec	The AC'97 Audio codec is compliant with the AC'97 2.1 specification, and supports 18-bit ADC (Analog Digital Converter) and DAC (Digital Analog Converter) resolution as well as 18-bit stereo full-duplex codec with independent and variable sampling rates. Further features include support for four analog line-level stereo inputs.
Expansion Options	<p>The mainboard comes with the following expansion options:</p> <ul style="list-style-type: none"> • Five 32-bit PCI slots • An 4xAGP slot • A Communications Network Riser (CNR) slot • Two IDE channels and a floppy disk drive interface <p>The KOB KT266 FSX supports Ultra DMA bus mastering with transfer rates of 33/66/100 MB/sec.</p>
Integrated I/O	<p>The mainboard has a full set of I/O ports and connectors:</p> <ul style="list-style-type: none"> • Two PS/2 ports for mouse and keyboard • Two serial ports • One parallel port • One MIDI/game port • Two USB ports • Audio jacks for microphone, line-in and line-out
BIOS Firmware	<p>This mainboard uses Award BIOS that enables users to configure many system features including the following:</p> <ul style="list-style-type: none"> • Power management • Wake-up alarms • CPU parameters • CPU and memory timing <p>The firmware can also be used to set parameters for different processor clock speeds.</p>

Mainboard Components

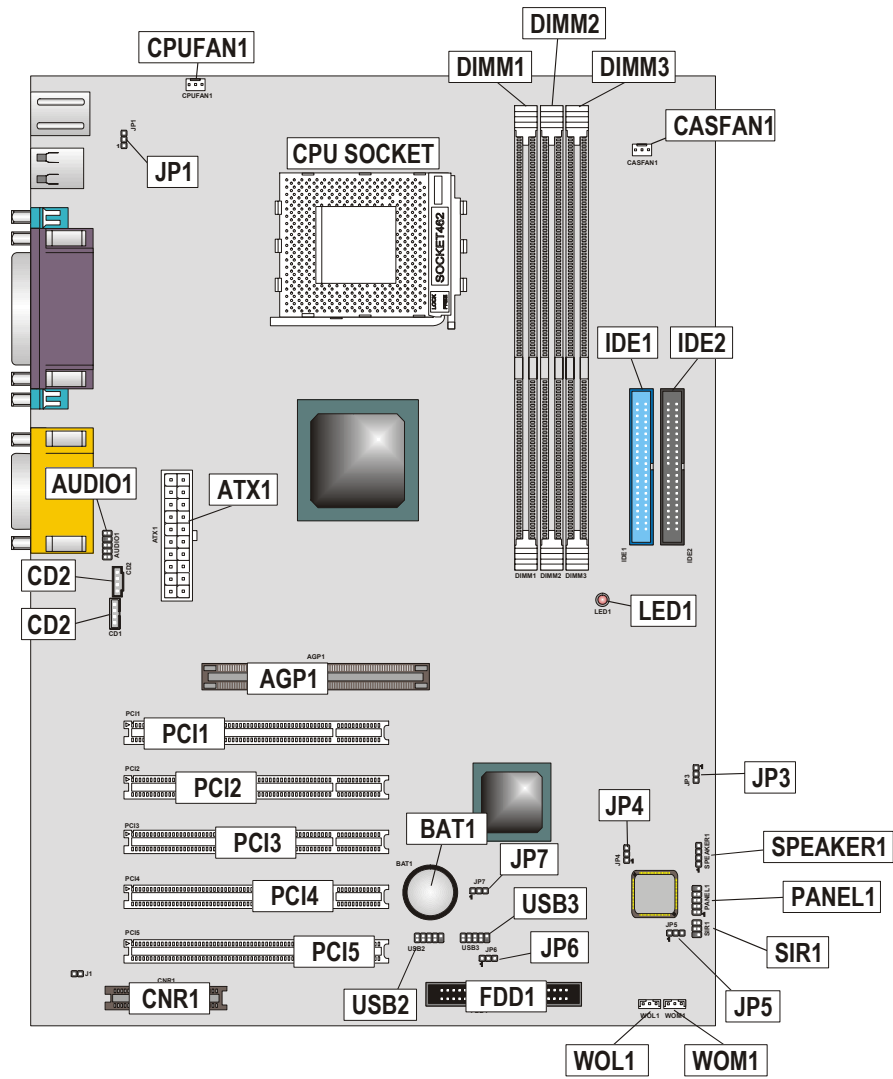

Table of Mainboard Components

Label	Component
JP1	Keyboard and USB power on jumper
CPUFAN1	Cooling fan for CPU
SOCKET 462	Socket A for AMD Athlon processor
DIMM1 ~ DIMM3	Three 184-pin DIMM sockets
CASFAN1	Auxiliary case cooling fan
IDE 1	Primary IDE channel
IDE 2	Secondary IDE channel
LED1 ¹	Memory module LED
ATX1	Power connector
AUDIO 1	Front-oriented microphone/line-out port header
CD1	Primary CD-in connector
CD2	Secondary CD-in connector
AGP1	Accelerated Graphics Port
PCI1 ~ PCI5	Five 32-bit add-in card slots
J1	Case open alarm header
CNR1	Communications Networking Riser slot
BT1	Three volt realtime clock battery
JP7	Clear CMOS jumper
USB2/3	Front panel USB headers
JP6	USB2/3 power on jumper
FDD1	Floppy disk drive connector
JP4	BIOS volt selection jumper
JP3	CPU frequency selection jumper
PANEL1	Connector for case front panel switches and LED indicators
JP5	BIOS protection jumper
SIR1	Serial infrared cable header
WOL1	Wake On LAN wakeup connector
WOM1	Wake On Modem wakeup connector

¹ The red indicator LED1 turns on if your system is still powered, at which time memory modules cannot be installed or uninstalled.

Choosing a Computer Case

There are many types of computer cases on the market. The mainboard complies with the specifications for the ATX system case. Some features on the mainboard are implemented by cabling connectors on the mainboard to indicators and switches on the system case. Ensure that your case supports all the features required. The mainboard can support one or two floppy diskette drives and four enhanced IDE drives. Ensure that your case has sufficient power and space for all the drives that you intend to install.

Most cases have a choice of I/O templates in the rear panel. Make sure that the I/O template in the case matches the I/O ports installed on the rear edge of the mainboard.

This mainboard has an ATX form factor of 220 x 304 mm. Choose a case that accommodates this form factor.

This concludes Chapter 1. Chapter 2 explains how to install the mainboard.

Chapter 2

Installing the Mainboard

Safety Precautions

Follow these safety precautions when installing the mainboard:

- Wear a grounding strip attached to a grounded device to avoid damage from static electricity.
- Discharge static electricity by touching the metal case of a safely grounded object before working on the mainboard.
- Leave components in the static-proof bags they came in.
- Hold all circuit boards by the edges. Do not bend circuit boards.

Quick Guide

This Quick Guide suggests the steps you can take to build your system with the mainboards.

The following table describes installing specific components:

Locating Mainboard Components	Go to page 4
Installing Jumpers	Go to page 9
Installing the Mainboard in a Case	Go to page 13
Installing Case Components	Go to page 14
Installing the CPU	Go to page 16
Installing Memory	Go to page 18
Installing an HDD and CD-ROM Drive	Go to page 20
Installing an FDD	Go to page 23
Installing Add-on Cards	Go to page 24
Connecting Options	Go to page 26
Connecting Peripheral (I/O) Devices	Go to page 29

Note: The appendix provides a quick reference for jumper settings.

Checking Jumper Settings

This section explains how to set jumpers for correct configuration of the mainboard.

Setting Jumpers

Use the mainboard jumpers to set system configuration options. Jumpers with more than one pin are numbered. When setting the jumpers, ensure that the jumper caps are placed on the correct pins.

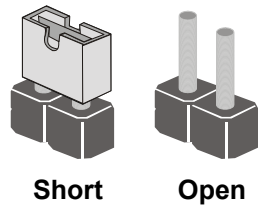

This illustration shows a 2-pin jumper. When the jumper cap is placed on both pins, the jumper is SHORT. If you remove the jumper cap, or place the jumper cap on just one pin, the jumper is OPEN.

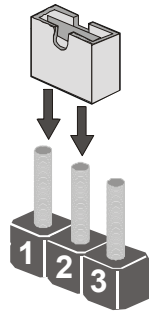





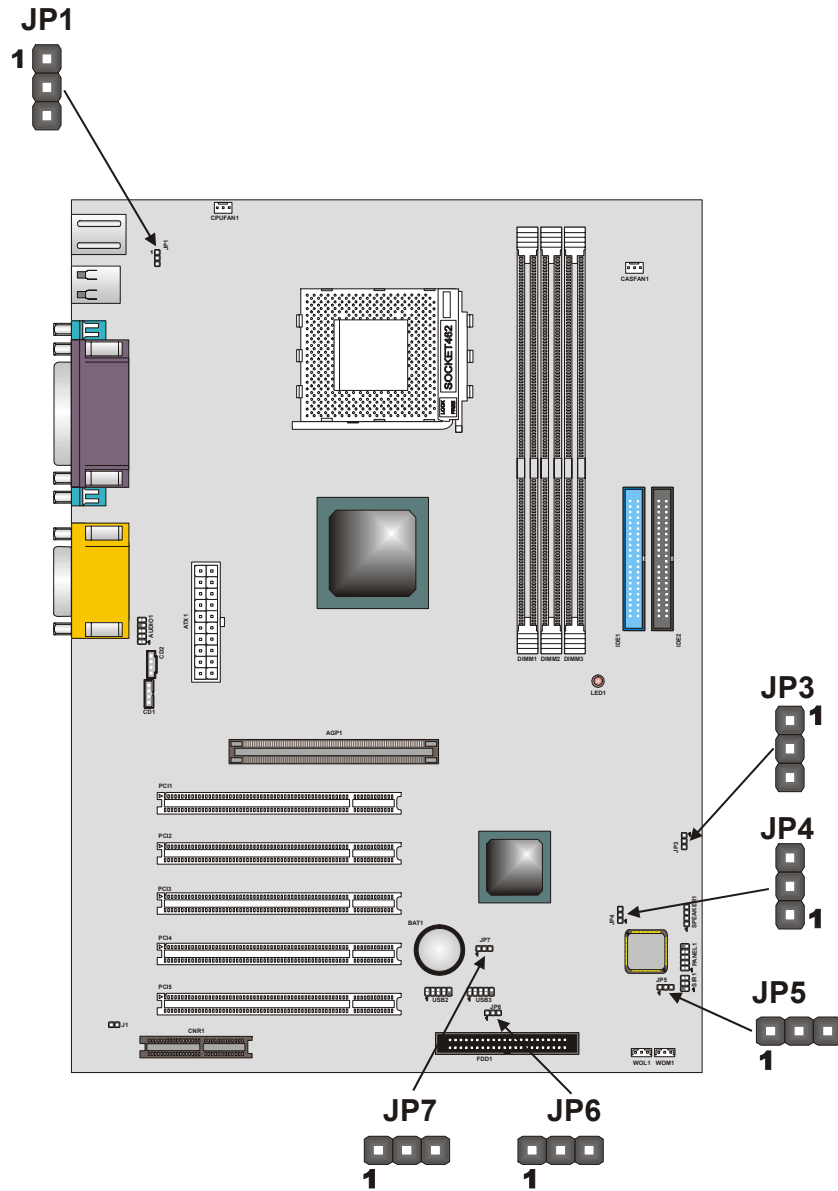

This illustration shows a 3-pin jumper. Pins 1 and 2 are SHORT.

Checking Jumper Settings

In the following illustration, pin 1 is shown.



Jumper Settings

Jumper	Type	Description	Setting (default)
JP1	3 pin	KB/USB power on	1-2: Disable 2-3: <i>Enable</i> 
JP3	3 pin	CPU frequency select	1-2: 100 MHz 2-3: 133 MHz 
JP4	3 pin	BIOS voltage select	1-2: 5V 2-3: 3.3V 
JP5	3 pin	BIOS protection	1-2: Disable 2-3: <i>Enable</i> 
JP6	3 pin	USB2/3 power on	1-2: <i>Disable</i> 2-3: Enable 
JP7	3 pin	Clear CMOS	1-2: <i>Normal</i> 2-3: Clear 

Jumper 1 – enable this jumper if you want keyboard or USB activity to awaken the system from power saving mode.

Jumper 3 – Use this jumper to select the CPU frequency.

Jumper 4 – selects the BIOS voltage parameters. DO NOT make any adjustments to this jumper.

Jumper 5 – enables you to prevent the BIOS from being updated (flashed). Set the jumper to disabled if you are going to update your BIOS. After updating the BIOS, return it to the default setting (enabled). For instructions on updating the BIOS refer to Chapter 3.

Jumper 6 – enable this jumper if you want device activity on front panel USB ports 2/3 activity to turn on the computer.

Jumper 7 – enables you to clear the BIOS:

1. Turn the system off.
2. Short pins 2 and 3 on jumper 7.
3. Return the jumper to the normal setting.
4. Turn the system on. The BIOS is returned to the default settings.

Installing the Mainboard in a Case

Refer to the following illustration and instructions for installing the mainboard in a case:

This illustration shows an example of a mainboard being installed in a tower-type case:

Note: Do not over-tighten the screws as this can stress the mainboard.

Most system cases have mounting brackets installed in the case, which correspond to the holes in the mainboard. Place the mainboard over the mounting brackets and secure the mainboard into the mounting brackets with screws.

2. Secure the screws in the mainboard holes that align with the chassis holes

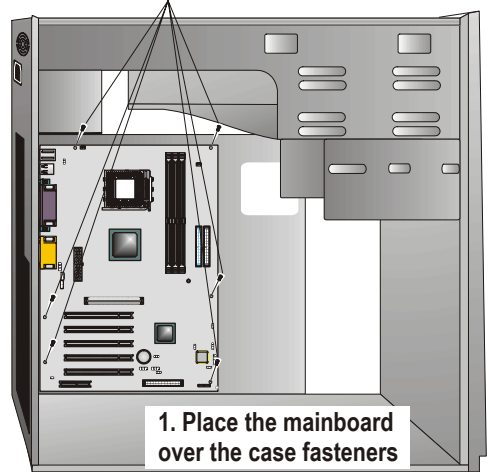

The mainboard has a set of I/O ports on the rear edge. Ensure that your case has an I/O template that supports the I/O ports and expansion slots.

Connecting Case Components

After you have installed the mainboard into a case, you can begin connecting the mainboard components. Refer to the following:

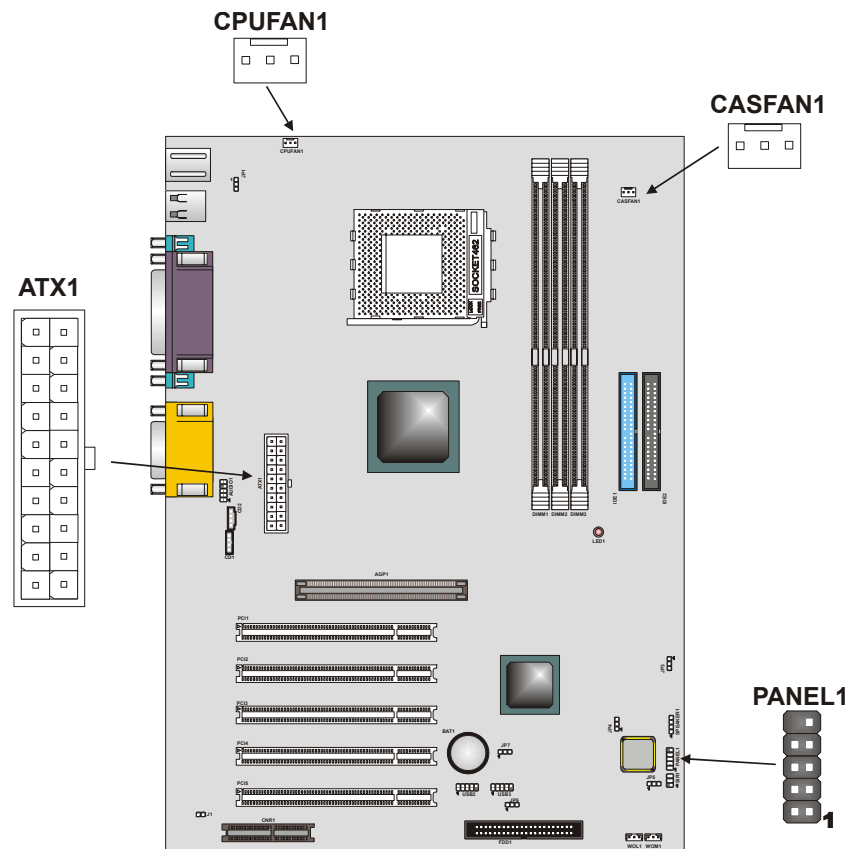

1. Connect the case power supply connector to ATX1.
2. Connect the CPU cooling fan cable to CPUFAN1.
3. Connect the case cooling fan connector to CASFAN1.

The following page explains how to make panel connections.

The Panel Connector

The panel connector provides a standard set of switch and LED connectors usually found on ATX or micro-ATX cases. Refer to the table below for information:

Device	Pins
Empty	10
N/C	9
Power ON/OFF	6, 8
Reset Switch	5, 7
Green LED Indicator	2, 4
HDD LED	+1, -3

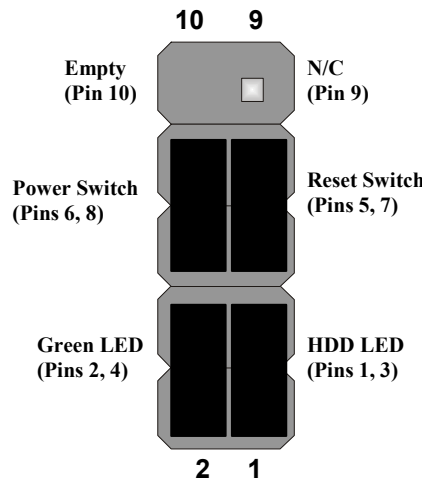

Note: The plus sign (+) indicates a pin which must be connected to a positive voltage.

Installing Hardware

Installing the Processor

Caution: When installing a CPU heatsink and cooling fan make sure that you DO NOT scratch the mainboard or any of the surface-mount resistors with the clip of the cooling fan. If the clip of the cooling fan scrapes across the mainboard, you may cause serious damage to both the mainboard and the processor.

On most mainboards, there are small surface-mount resistors near the processor socket, which may be damaged if the cooling fan is carelessly installed.

Avoid using cooling fans with sharp edges on the fan casing and the clips. Also, install the cooling fan in a well-lit work area so that you can clearly see the mainboard and processor socket.

Before installing the Processor

This mainboard automatically determines the CPU clock frequency and system bus frequency for processor. You may be able to change these automatic settings by making changes to jumpers on the mainboard, or changing the settings in the system Setup Utility. We strongly recommend that you do not overclock the mainboard to run processors or other components faster than their rated speed.

Warning: Overclocking components can adversely affect the reliability of the system and introduce errors into your system. Overclocking can permanently damage the mainboard by generating excess heat in components that are run beyond the rated limits.

This mainboard has a Socket 462 processor socket. When choosing a processor, consider the performance requirements of the system. Performance is based on the processor design, the clock speed and system bus frequency of the processor, and the quantity of internal cache memory and external cache memory.

CPU Installation Procedure

The following illustration shows CPU installation components:

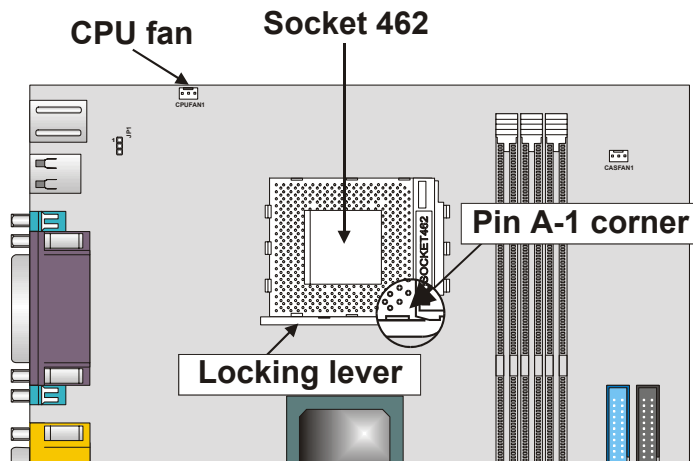

Follow these instructions to install the CPU:

1. Pull the CPU socket locking lever away from the socket to unhook it and raise the locking lever to the upright position.
2. Identify the pin A-1 corner on the CPU socket and the pin A-1 corner on the processor.
3. Match the pin A-1 corners and insert the processor into the socket. Do not use force.
4. Swing the locking lever down and hook it under the latch on the edge of the socket.
5. Plug the CPU fan power cable into the CPU cooling fan power supply on the mainboard (CPUFAN1).

Note: After you have assembled the system, you must set the correct clock speed and frontside bus (FSB) speed. Check the jumper section in Appendix A and refer to Chapter 3 “Frequency Voltage Control” for more information.

Install Memory Modules

This mainboard accommodates 184-pin 2.5V unbuffered Double Data Rate (DDR) SDRAM memory modules. The memory chips must be standard or registered SDRAM (Synchronous Dynamic Random Access Memory).

The memory bus can run at 100 MHz or 133 MHz. If your processor operates over a 100 MHz system bus, you can install PC100 or PC133 memory modules that operate over a 100 MHz or 133 MHz memory bus. If your processor operates over a 133 MHz system bus, you can only install PC133 memory modules that operate over a 133 MHz memory bus.

Note: SDRAM provides 800 MBps or 1 GBps data transfer depending on whether the bus is 100MHz or 133MHz. Double Data Rate SDRAM (DDR SDRAM) doubles the rate to 1.6 GBps and 2.1 GBps. DDR SDRAM uses additional power and ground lines and requires 184-pin DIMM modules rather than the 168-pin DIMMs used by SDRAM.

Installation Procedure

The mainboard accommodates three memory modules. You must install at least one module in any of the three slots. Each module can be installed with 32 MB to 512 MB of memory; total memory capacity is 1.5 GB.

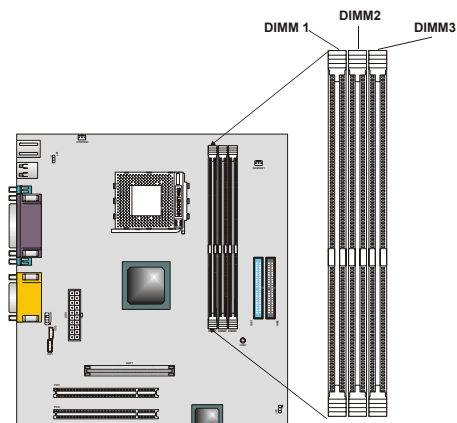

1. Align the memory module with the slot. The DIMM slots are keyed with notches and the DIMMs are keyed with cutouts so that they can only be installed correctly. Check that the cutouts on the DIMM module edge connector match the notches in the DIMM slot:

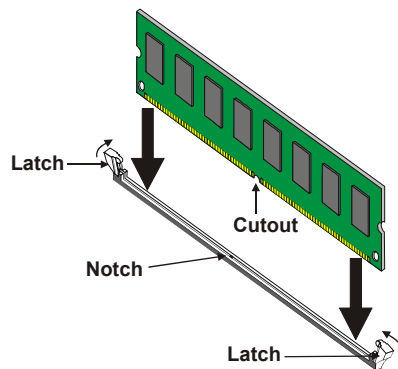

2. Push the latches on each side of the DIMM slot down.
3. Install the DIMM module into the slot and press it firmly down so that it seats correctly. The slot latches are levered upwards and latch on to the edges of the DIMM when it is installed correctly.

Installing a Hard Disk Drive/CD-ROM

This section describes how to install IDE devices such as a hard disk drive and a CD-ROM drive.

About IDE Devices

Your mainboard has a primary and secondary IDE channel interface (IDE1 and IDE2). An IDE ribbon cable supporting two IDE devices is bundled with the mainboard. IDE devices have jumpers or switches that are used to set the IDE device as MASTER or SLAVE. Refer to the IDE device user's manual.

If you want to install more than two IDE devices, get a second IDE cable and you can add two more devices to the secondary IDE channel.

When installing two IDE devices on one cable, ensure that one device is set to MASTER and the other device is set to SLAVE. The documentation of your IDE device explains how to do this.

About UDMA

This mainboard supports UltraDMA 66/100. UDMA is a technology that accelerates the performance of devices in the IDE channel. Install IDE devices that support UDMA and use IDE cables that support UDMA for better performance.

Installing a Hard Disk Drive

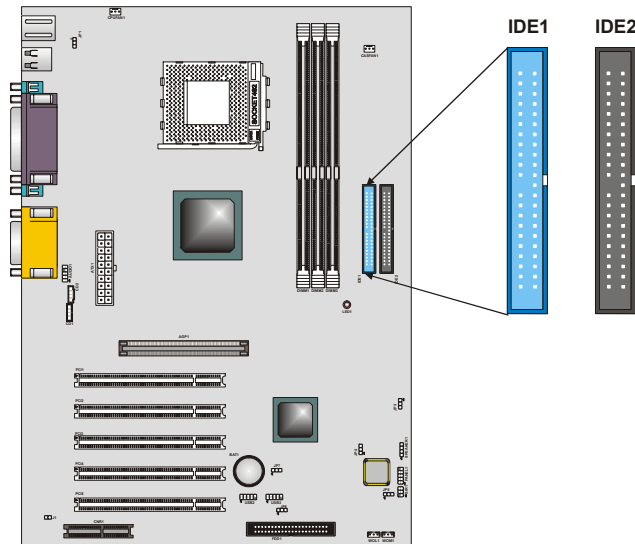

1. Install the hard disk drive into the drive cage in your ATX system case.
2. Plug the IDE cable into IDE1.

Note: Ribbon cable connectors are usually keyed so that they can only be installed correctly on the device connector. If the connector is not keyed, make sure that you match the pin-1 side of the cable connector with the pin-1 side of the device connector. Each connector has the pin-1 side clearly marked. The pin-1 side of each ribbon cable is always marked with a colored stripe on the cable.

3. Plug an IDE cable connector into the hard disk drive IDE connector. It doesn't matter which connector on the cable you use. Ensure that the pin-1 side of the cable is matched with the pin-1 side of the connector. Refer to the previous note.
4. Plug a power cable from the case power supply into the power connector on the hard disk drive.

When you first start up your system, the BIOS should automatically detect your hard disk drive. If it doesn't, enter the Setup Utility and use the IDE Hard Disk Auto Detect feature to configure the hard disk drive that you have installed. See Chapter 3 for more information.

Installing a CD-ROM/DVD Drive

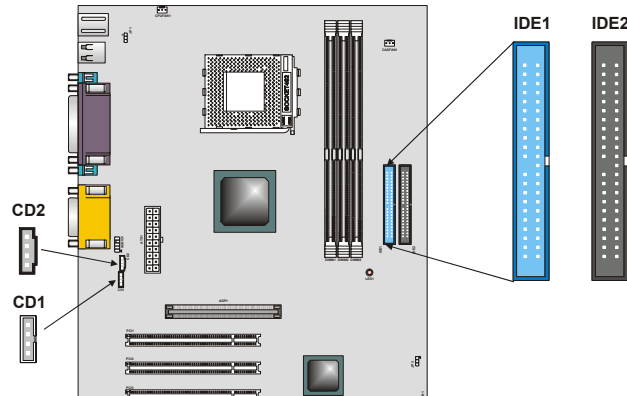

1. Install the CD-ROM/DVD drive into the drive cage in your ATX system case.
2. Plug the IDE cable into IDE1. If you have already installed an HDD, you can use the free connector on its IDE cable.

Note: Ribbon cable connectors are usually keyed so that they can only be installed correctly on the device connector. If the connector is not keyed, make sure that you match the pin-1 side of the cable connector with the pin-1 side of the device connector. Each connector has the pin-1 side clearly marked. The pin-1 side of each ribbon cable is always marked with a colored stripe on the cable.

3. Plug an IDE cable connector into the CD-ROM/DVD drive IDE connector. It doesn't matter which connector on the cable you use. Ensure that the pin-1 side of the cable is matched with the pin-1 side of the connector. Refer to the previous note.
4. Use the audio cable provided with the CD-ROM/DVD drive to connect to the mainboard CD-in connector CD1 or CD2.
5. Plug a power cable from the case power supply into the power connector on the CD-ROM/DVD drive.

When you first start up your system, the BIOS should automatically detect your CD-ROM/DVD drive. If it doesn't, enter the Setup Utility and configure the CD-ROM/DVD drive that you have installed. See Chapter 3 for more information.

Installing a Floppy Diskette Drive

The mainboard has a floppy diskette drive (FDD) interface ships with a diskette drive ribbon cable that supports one or two floppy diskette drives. You can install a 5.25-inch drive and a 3.5-inch drive with various capacities. The floppy diskette drive cable has one type of connector for a 5.25-inch drive and another type of connector for a 3.5-inch drive

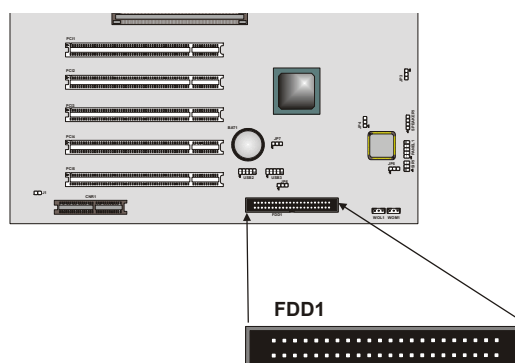

1. Install the FDD into the drive cage in your ATX system case.
2. Plug the FDD cable into FDD1.

Note: Ribbon cable connectors are usually keyed so that they can only be installed correctly on the device connector. If the connector is not keyed, make sure that you match the pin-1 side of the cable connector with the pin-1 side of the device connector. Each connector has the pin-1 side clearly marked. The pin-1 side of each ribbon cable is always marked with a colored stripe on the cable.

3. Plug one of the connectors on the FDD cable into the FDD connector. It doesn't matter which connector on the cable you use. Ensure that the pin-1 side of the cable is matched with the pin-1 side of the connector. Refer to the previous note.
4. Plug a power cable from the case power supply into the power connector on the FDD.

When you first start up your system, go immediately to the Setup Utility and use the Standard page to configure the floppy diskette drives that you have installed. See Chapter 3 for more information.

Installing Add-on Cards

This mainboard has five 32-bit PCI (Peripheral Components Interconnect) expansion slots, one 4xAGP slot, and one Communications and Networking Riser (CNR) slot.

- PCI Slots** PCI slots are used to install expansion cards that have the 32-bit PCI interface.
- 4xAGP Slot** The 4xAGP slot is used to install a graphics adapter that supports the 4xAGP specification and has a 4xAGP edge connector.
- CNR Slot** This slot is used to insert CNR cards including LAN, Modem, and Audio functions.

Note: Before installing an add-in card, check the documentation for the card carefully. If the card is not Plug and Play, you may have to manually configure the card before installation.

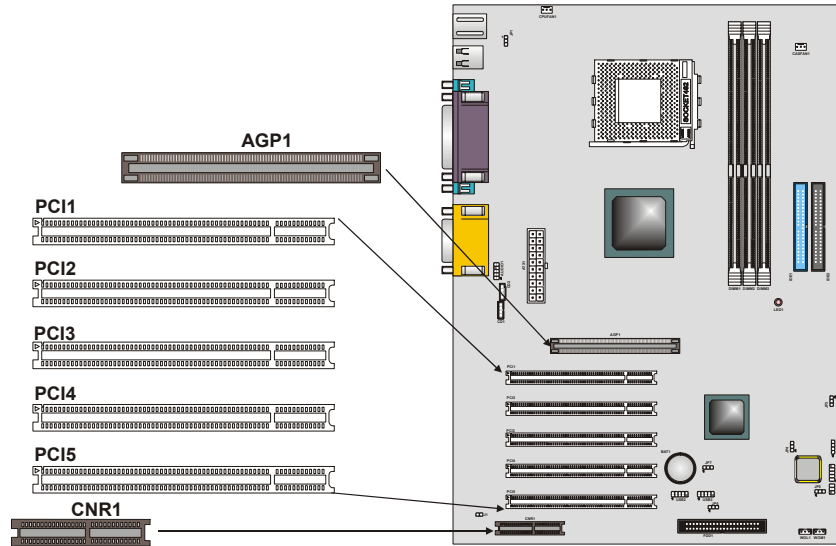

1. Remove a blanking plate from the system case corresponding to the slot you are going to use.
2. Install the edge connector of the add-in card into the expansion slot. Ensure that the edge connector is correctly seated in the slot.
3. Secure the metal bracket of the card to the system case with a screw.

Note: For some add-in cards, for example graphics adapters and network adapters, you have to install drivers and software before you can begin using the add-in card.

Connecting Optional Devices

Refer to the following for information on connecting the main-board's optional devices:

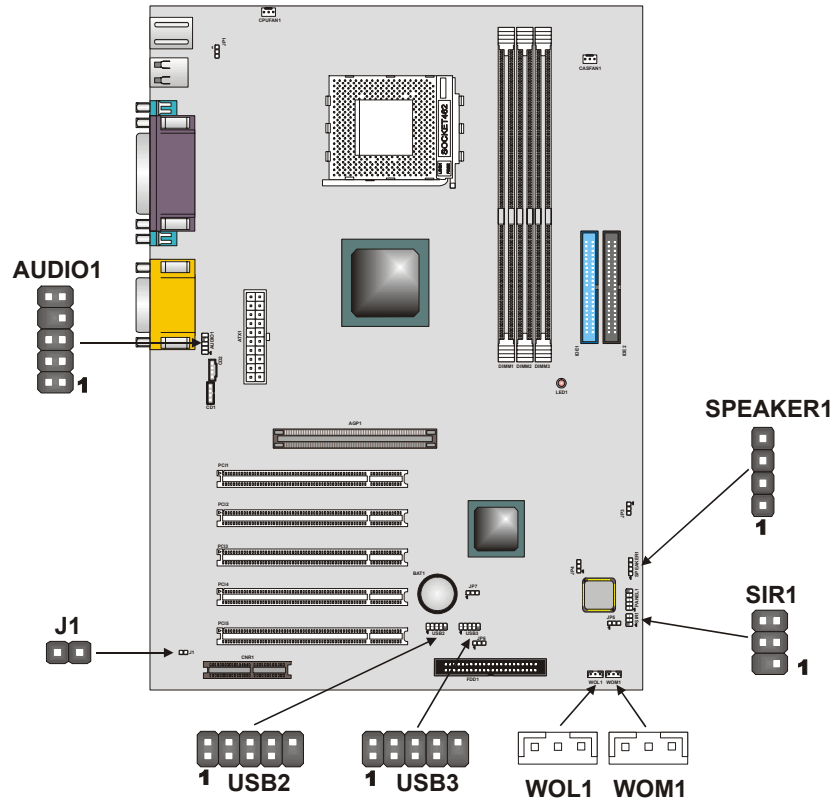

AUDIO 1: Front panel MIC/line-out

This header allows the user to install auxiliary front-oriented microphone and line-out ports for easier access.

Pin	Signal Name	Pin	Signal Name
1	AUD_MIC	6	AUD_RET_R
2	AUD_GND	7	HP_ON
3	AUD_MIC_BIAS	8	KEY
4	AUD_VCC	9	AUD_FPOUT_L
5	AUD_FPOUT_R	10	AUD_RET_L

J1: Case open

This jumper prevents unauthorized access to your computer by enabling an alarm that alerts you when your computer case has been opened.

USB2/USB3: USB port 3, 4 and 5, 6

The mainboard has two USB ports installed on the rear edge I/O port array. However, some computer cases have a special module that mounts USB ports at the front of the case. If you have this kind of case, use auxiliary USB connectors USB2 and USB3 to connect the front-mounted ports to the mainboard.

Pin	Signal Name	Pin	Signal Name
1	VREG_FP_USBPWR0	6	USB_FP_P1+
2	VREG_FP_USBPWR0	7	Ground
3	USB_FP_P0-	8	Ground
4	USB_FP_P1-	9	Key
5	USB_FP_P0+	10	USB_FP-OC0

WOL1/WOM: Wake On LAN/Wake On Modem

If you have installed a LAN card, use the cable provided with the card to plug into the mainboard WOL1 connector. This enables the Wake On LAN (WOL) feature. When your system is in a power-saving mode, any LAN signal automatically resumes the system. You must enable this item using the Power Management page of the Setup Utility.

Pin	Signal Name
1	5VSB
2	Ground
3	SENSE

If you have installed a modem, use the cable provided with the modem to plug into the mainboard WOM1 connector. This enables the Wake On Modem (WOM) feature. When your system is in a power-saving mode, any modem signal automatically resumes the system. You must enable this item using the Power Management page of the Setup Utility. See Chapter 3 for more information.

SIR1: Serial infrared port

The mainboard supports a Serial Infrared (SIR) data port. Infrared ports allow the wireless exchange of information between your computer and similarly equipped devices such as printers, laptops, Personal Digital Assistants (PDAs), and other computers.

Pin	Signal Name
1	Not assigned
2	(No Pin)
3	+5V
4	Ground
5	IRTX
6	IRRX

SPEAKER1: Internal speaker

Connect the internal speaker connector to this header.

Pin	Signal Name
1	SPKR
2	NC
3	Ground
4	+5V

Connecting I/O Devices

The backplane of the mainboard has a full set of I/O ports:

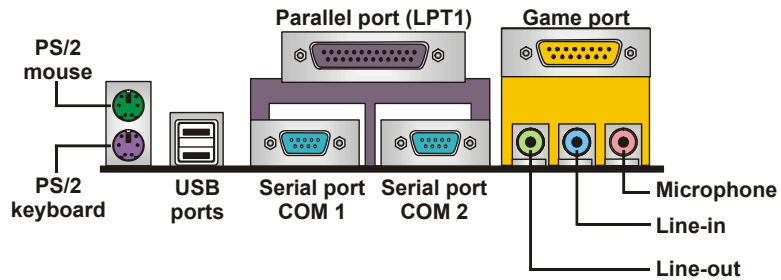

1. Use the upper PS/2 port to connect a PS/2 pointing device. Use the lower PS/2 port to connect a PS/2 keyboard.
2. Use the USB ports to connect USB devices.
3. Use LPT1 to connect printers or other parallel communications devices.
4. Use the COM ports to connect serial devices such as mice or fax/modems. COM1 is identified by the system as COM1/3. COM2 is identified by the system as COM2/4.
5. Use the game port to connect a joystick or a MIDI device.
6. Use the three audio ports to connect audio devices. The left side jack is for a stereo line-out signal. The middle jack is for a stereo line-in signal. The right side jack is for a microphone.

External Connector Color Coding

Many connectors now use standard colors as shown in the table below.

Connector	Color
Analog VGA	Blue
Audio line in	Light blue
Audio line out	Lime
Digital monitor / flat panel	White
IEEE 1394	Grey
Microphone	Pink
MIDI/Game	Gold
Parallel	Burgundy
PS/2 compatible keyboard	Purple
PS/2 compatible mouse	Green
Serial	Teal or Turquoise
Speaker out/subwoofer	Orange
Right-to-left speaker	Brown
USB	Black
Video out	Yellow
SCSI, network, telephone, modem	None

This concludes Chapter 2. Chapter 3 covers the BIOS.

Chapter 3

Using BIOS

About the Setup Utility

The computer uses the latest Award BIOS with support for Windows Plug and Play. The CMOS chip on the mainboard contains the ROM setup instructions for configuring the mainboard BIOS.

The BIOS (Basic Input and Output System) Setup Utility displays the system's configuration status and provides you with options to set system parameters. The parameters are stored in battery-backed-up CMOS RAM that saves this information even when the power is turned off. When the system is turned back on, the system is configured with the values found in CMOS.

The BIOS Setup Utility enables you to configure:

- Hard drives, diskette drives, and peripherals
- Video display type and display options
- Password protection from unauthorized use
- Power management features

The settings made in the Setup Utility affect how the computer performs. Before using the Setup Utility, ensure that you understand the Setup Utility options. Only change settings appropriate for the way you use the computer.

This chapter provides explanations for Setup Utility options.

The Standard Configuration

A standard configuration has already been set in the Setup Utility. However, we recommend that you read this chapter in case you need to make any changes in the future.

This Setup Utility should be used:

- when changing the system configuration
- when a configuration error is detected and you are prompted to make changes to the Setup Utility
- when trying to resolve IRQ conflicts
- when making changes to the Power Management configuration
- when changing the password or making other changes to the Security Setup

Updating the BIOS

You can download and install updated BIOS for this mainboard from the manufacturer's web site. New BIOS provides support for new peripherals, improvements in performance, or fixes for known bugs. Install new BIOS as follows:

1. If your mainboard has a BIOS protection jumper, change the setting to allow BIOS flashing. Refer to Appendix A for jumper settings.
2. If your mainboard has an item called Firmware Write Protect in Advanced BIOS features, disable it. Firmware Write Protect prevents BIOS from being overwritten.
3. Create a bootable system disk. Refer to Windows online help for information on creating a bootable system disk.
4. Download the Flash Utility and new BIOS file from the manufacturer's Web site. Copy these files to the system diskette you created in Step 3.
5. Turn off your computer and insert the system diskette in your computer's diskette drive. You might need to run the Setup Utility and change the boot priority items on the Advanced BIOS Features Setup page, to force your computer to boot from the floppy diskette drive first.
6. At the A:\ prompt, type the Flash Utility program name and press <Enter>. You see a screen similar to the following:

FLASH MEMORY WRITER V7.33	
(C) Award Software 1999 All Rights Reserved	
For (MAINBOARD NAME)	DATE: 10/26/2000
Flash Type	
File Name to Program :	<input type="text"/>
Error Message	

7. Type the filename of the new BIOS in the "File Name to Program" text box. Follow the onscreen directions to update the mainboard BIOS.
8. When the installation is complete, remove the floppy diskette from the diskette drive and restart your computer. If your mainboard has a Flash BIOS jumper, reset the jumper to protect the newly installed BIOS from being overwritten.

Using BIOS

When you start the Setup Utility, the main menu appears. The main menu of the Setup Utility displays a list of the options that are available. A highlight indicates which option is currently selected. Use the cursor arrow keys to move the highlight to other options. When an option is highlighted, execute the option by pressing <Enter>.

Some options lead to pop-up dialog boxes that prompt you to verify that you wish to execute that option. Other options lead to dialog boxes prompt you for information.

Some options (marked with a triangle ►) lead to submenus that enable you to change the values for the option. Use the cursor arrow keys to scroll through the items in the submenu.

In this manual, default values are enclosed in parenthesis. Sub-menu items are denoted by a triangle ►.

Standard CMOS Features

This option displays a table of items defining basic information about your system.

CMOS Setup Utility – Copyright (C) 1984 – 2001 Award Software
Standard CMOS Features

Date (mm:dd:yy)	Tue, July 11 2000	Item Help
Time (hh:mm:ss)	12 : 8 : 59	
► IDE Primary Master		Menu Level ►
► IDE Primary Slave		Change the day, month, year and century.
► IDE Secondary Master		
► IDE Secondary Slave		
Drive A	[1.44M, 3.5 in.]	
Drive B	[None]	
Floppy 3 Mode Support	[Disabled]	
Video	[EGA/VGA]	
Halt On	[All,But Keyboard]	
Base Memory	640K	
Extended Memory	31744K	
Total Memory	32768K	

↑↓→← : Move Enter : Select +/-/PU/PD:Value: F10: Save ESC: Exit F1:General Help
F5:Previous Values F6:Fail-Safe Defaults F7:Optimized Defaults

Date and Time

The Date and Time items show the current date and time on the computer. If you are running a Windows OS, these items are automatically updated whenever you make changes to the Windows Date and Time Properties utility.

► IDE Devices (None)

Your computer has two IDE channels (Primary and Secondary) and each channel can be installed with one or two devices (Master and Slave). Use these items to configure each device on the IDE channel.

Press <Enter> to display the IDE sub-menu:

CMOS Setup Utility – Copyright © 1984 – 2000 Award Software
IDE Primary Master

IDE HDD Auto-Detection	Press Enter	Item Help
IDE Primary Master	[Auto]	Menu Level ►► To auto-detect the HDD's size, head . . . on this channel
Access Mode	[Auto]	
Capacity	0 MB	
Cylinder	0	
Head	0	
Precomp	0	
Landing Zone	0	
Sector	0	

↑↓ → ← : Move Enter : Select +/-/PU/PD: Value: F10: Save ESC: Exit F1: General Help
F5: Previous Values F6: Fail-Safe Defaults F7: Optimized Defaults

IDE HDD Auto-Detection

Press <Enter> while this item is highlighted to prompt the Setup Utility to automatically detect and configure an IDE device on the IDE channel.

Note: If you are setting up a new hard disk drive that supports LBA mode, more than one line will appear in the parameter box. Choose the line that lists LBA for an LBA drive.

IDE Primary/Secondary Master/Slave (Auto)

Leave this item at Auto to enable the system to automatically detect and configure IDE devices on the channel. If it fails to find a device, change the value to Manual and then manually configure the drive by entering the characteristics of the drive in the items described below.

Refer to your drive's documentation or look on the drive casing if you need to obtain this information. If no device is installed, change the value to None.

Note: Before attempting to configure a hard disk drive, ensure that you have the configuration information supplied by the manufacturer of your hard drive. Incorrect settings can result in your system not recognizing the installed hard disk.

Access Mode

This item defines ways that can be used to access IDE hard disks such as LBA (Large Block Addressing). Leave this value at Auto and the system will automatically decide the fastest way to access the hard disk drive.

Press <Esc> to return to the Standard CMOS Features page.

Drive A/Drive B (1.44M, 3.5 in./None)

These items define the characteristics of any diskette drive attached to the system. You can connect one or two diskette drives.

Floppy 3 Mode Support (Disabled)

Floppy 3 mode refers to a 3.5-inch diskette with a capacity of 1.2 MB. Floppy 3 mode is sometimes used in Japan.

Video (EGA/VGA)

This item defines the video mode of the system. This mainboard has a built-in VGA graphics system; you must leave this item at the default value.

Halt On (All Errors)

This item defines the operation of the system POST (Power On Self Test) routine. You can use this item to select which types of errors in the POST are sufficient to halt the system.

Base Memory, Extended Memory, and Total Memory

These items are automatically detected by the system at start up time. These are display-only fields. You cannot make changes to these fields.

External Cache (Enabled)

Most processors that can be installed in this system use external level 2 (L2) cache memory to improve performance. Leave this item at the default value for better performance.

CPU L2 Cache ECC Checking (Enabled)

This item enables or disables ECC (Error Correction Code) error checking on the CPU cache memory. We recommend that you leave this item at the default value.

Processor Number Feature (Enabled)

Some new processors are installed with a unique processor number. This number may be used for verification in Internet transactions and e-commerce. If you prefer not to use or distribute the unique processor number, disable this item to suppress the processor number.

Quick Power On Self Test (Enabled)

Enable this item to shorten the power on testing (POST) and have your system start up faster. You might like to enable this item after you are confident that your system hardware is operating smoothly.

1st/2nd/3rd Boot Device (Floppy/HDD-0/LS120)

Use these three items to select the priority and order of the devices that your system searches for an operating system at start-up time.

Boot Other Device (Enabled)

When enabled, the system searches all other possible locations for an operating system if it fails to find one in the devices specified under the first, second, and third boot devices.

Swap Floppy Drive (Disabled)

If you have two floppy diskette drives in your system, this item allows you to swap the assigned drive letters so that drive A becomes drive B, and drive B becomes drive A.

Boot Up Floppy Seek (Enabled)

If this item is enabled, it checks the size of the floppy disk drives at start-up time. You don't need to enable this item unless you have a legacy diskette drive with 360K capacity.

Boot Up NumLock Status (On)

This item defines if the keyboard Num Lock key is active when your system is started.

Gate A20 Option (Fast)

This item defines how the system handles legacy software that was written for an earlier generation of processors. Leave this item at the default value.

Typematic Rate Setting (Disabled)

If this item is enabled, you can use the following two items to set the typematic rate and the typematic delay settings for your keyboard.

- **Typematic Rate (Chars/Sec):** Use this item to define how many characters per second are generated by a held-down key.
- **Typematic Delay (Msec):** Use this item to define how many milliseconds must elapse before a held-down key begins generating repeat characters.

Security Option (Setup)

If you have installed password protection, this item defines if the password is required at system start up, or if it is only required when a user tries to enter the Setup Utility.

OS Select For DRAM > 64 MB (Non-OS2)

This item is only required if you have installed more than 64 MB of memory and you are running the OS/2 operating system. Otherwise, leave this item at the default.

HDD S.M.A.R.T Capability (Disabled)

The S.M.A.R.T. (Self-Monitoring, Analysis, and Reporting Technology) system is a diagnostics technology that monitors and predicts device performance. S.M.A.R.T. software resides on both the disk drive and the host computer.

The disk drive software monitors the internal performance of the motors, media, heads, and electronics of the drive. The host software monitors the overall reliability status of the drive. If a device failure is predicted, the host software, through the Client WORKS S.M.A.R.T applet, warns the user of the impending condition and advises appropriate action to protect the data.

Report No FDD For WIN95 (Yes)

If you are running a system with no floppy drive and using Windows 95, select Yes for this item to ensure compatibility with the Windows 95 logo certification. Otherwise, select No.

Advanced Chipset Features Option

This option displays a table of items that define critical timing parameters of the mainboard. You should leave the items on this page at their default values unless you are very familiar with the technical specifications of your system hardware. If you change the values incorrectly, you may introduce fatal errors or recurring instability into your system.

CMOS Setup Utility – Copyright (C) 1984 – 2001 Award Software
Advanced Chipset Features

▶ DRAM Clock/Drive Control	[Press Enter]	Item Help
▶ AGP & P2P Bridge Control	[Press Enter]	
▶ CPU & PCI Bus Control	[Press Enter]	
Memory Hole	[Disabled]	Menu Level ▶
System BIOS Cacheable	[Enabled]	
Video RAM Cacheable	[Enabled]	

↑↓→← : Move Enter : Select +/-/PU/PD:Value: F10: Save ESC: Exit F1:General Help
 F5:Previous Values F6:Fail-Safe Defaults F7:Optimized Defaults

► DRAM Clock/Drive Control

Scroll to this item and press <Enter> to view the following screen:

CMOS Setup Utility – Copyright (C) 1984 – 2001 Award Software
DRAM Clock/Drive Control

Current FSB Frequency		Item Help
Current DRAM Frequency		
DRAM Clock	[100 MHz]	
DRAM Timing	[By SPD]	Menu Level ►
x SDRAM Cycle Length	3	
x Bank Interleave	Disabled	
DRAM Command Rate	[2T Command]	

↑↓→← : Move Enter : Select +/-/PU/PD:Value: F10: Save ESC: Exit F1:General Help
F5:Previous Values F6:Fail-Safe Defaults F7:Optimized Defaults

Current FSB Frequency

This item displays the frontside bus (FSB) frequency. This is a display-only item. You cannot make changes to this field.

Current DRAM Frequency

This item displays the memory (DRAM) frequency. This is a display-only item. You cannot make changes to this field.

DRAM Clock (100 MHz)

This item enables you to manually set the DRAM Clock. We recommend that you leave this item at the default value.

DRAM Timing (By SPD)

Set this to the default value to enable the system to automatically set the SDRAM timing by SPD (Serial Presence Detect). SPD is an EEPROM chip on the DIMM module that stores information about the memory chips it contains, including size, speed, voltage, row and column addresses, and manufacturer. If you disable this item, you can use the following three items to manually set the timing parameters for the system memory

SDRAM Cycle Length (3)

When synchronous DRAM is installed, the number of clock

cycles of CAS latency depends on the DRAM timing. We recommend that you leave this item at the default value.

Bank Interleave (Disabled)

Enable this item to increase memory speed. When enabled, separate memory banks are set for odd and even addresses and the next byte of memory can be accessed while the current byte is being refreshed.

DRAM Command Rate (2T Command)

This item enables you to specify the waiting time for the CPU to issue the next command after issuing the command to the DDR memory. We recommend that you leave this item at the default value.

Press <Esc> to return to the Advanced Chipset Features page.

► AGP & P2P Bridge Control

Scroll to this item and press <Enter> to view the following screen:

CMOS Setup Utility – Copyright (C) 1984 – 2001 Award Software
AGP & P2P Bridge Control

AGP Aperture Size	[64M]	Item Help
AGP Mode	[4X]	
AGP Driving Control	[Auto]	Menu Level ►
x AGP Driving Value	DA	
AGP Fast Write	[Disabled]	
AGP Master 1 WS Write	[Disabled]	
AGP Master WS Read	[Disabled]	

↑↓→← : Move Enter : Select +/-/PU/PD:Value: F10: Save ESC: Exit F1:General Help
F5:Previous Values F6:Fail-Safe Defaults F7:Optimized Defaults

AGP Aperture Size (64 MB)

This item defines the size of the aperture if you use an AGP graphics adapter. The AGP aperture refers to a section of the PCI memory address range used for graphics memory. We recommend that you leave this item at the default value.

AGP Mode (4X)

This item allows you to enable or disable the caching of display data for the processor video memory. Enabling AGP-4X

Mode can greatly improve the display speed. Disable this item if your graphics display card does not support this feature.

AGP Driving Control (Auto)

This item is used to signal driving current on AGP cards to auto or manual. Some AGP cards need stronger than normal driving current in order to operate. We recommend that you set this item to the default.

- **AGP Driving Value:** When AGP Driving Control is set to Manual, use this item to set the AGP current driving value.

AGP Fast Write (Disabled)

This item lets you enable or disable the caching of display data for the video memory of the processor. Enabling this item can greatly improve the display speed. Disable this item if your graphics display card does not support this feature.

AGP Master 1 WS Write (Disabled)

This implements a single delay when writing to the AGP Bus. By default, two-wait states are used by the system, providing greater stability.

AGP Master 1 WS Read (Disabled)

This implements a single delay when reading to the AGP Bus. By default, two-wait states are used by the system, allowing for greater stability.

Press <Esc> to return to the Advanced Chipset Features page.

► CPU & PCI Bus Control

Scroll to this item and press <Enter> to view the following screen:

CMOS Setup Utility – Copyright (C) 1984 – 2001 Award Software
AGP & P2P Bridge Control

PCI1 Master 0 WS Write	[Enabled]	Item Help Menu Level ►
PCI2 Master 0 WS Write	[Enabled]	
PCI1 Post Write	[Enabled]	
PCI2 Post Write	[Enabled]	
PCI Delay Transaction	[Disabled]	

↑↓→← : Move Enter : Select +/-/PU/PD:Value: F10: Save ESC: Exit F1:General Help
F5:Previous Values F6:Fail-Safe Defaults F7:Optimized Defaults

PCI 1/2 Master 0 WS Write (Enabled)

When enabled, writes to the PCI bus are executed with zero wait states, providing faster data transfer.

PCI 1/2 Post Write (Enabled)

When enabled, writes from the CPU to PCU bus are buffered, to compensate for the speed differences between the CPU and PCI bus. When disabled, the writes are not buffered and the CPU must wait until the write is complete before starting another write cycle.

PCI Delay Transaction (Disabled)

The mainboard's chipset has an embedded 32-bit post write buffer to support delay transactions cycles. Select Enabled to support compliance with PCI specification version 2.1.

Press <Esc> to return to the previous screen.

Memory Hole (Disabled)

This item is used to reserve memory space for ISA expansion cards that require it.

System BIOS/Video RAM Cacheable (Enabled)

These items allow the video and system to be cached in memory for faster execution. Leave these items at the default value for better performance.

Integrated Peripherals Option

This option displays a list of items that defines the operation of peripheral components on the system's input/output ports.

CMOS Setup Utility – Copyright (C) 1984 – 2001 Award Software
Integrated Peripherals

▶ OnChip IDE Device	[Press Enter]	Item Help Menu Level ▶
▶ OnChip PCI Device	[Press Enter]	
▶ Super I/O Device	[Press Enter]	
Initi Display First	[PCI Slot]	
OnChip USB Controller	[All Enabled]	
USB keyboard Support	[Disabled]	
IDE HDD Block Mode	[Enabled]	

↑↓→← : Move Enter : Select +/-/PU/PD:Value: F10: Save ESC: Exit F1:General Help
F5:Previous Values F6:Fail-Safe Defaults F7:Optimized Defaults

▶ OnChip IDE Device

Scroll to this item and press <Enter> to view the following screen:

CMOS Setup Utility – Copyright (C) 1984 – 2001 Award Software
OnChip IDE Device

OnChip IDE Channel0	[Enabled]	Item Help Menu Level ▶▶
OnChip IDE Channel1	[Enabled]	
IDE Prefetch Mode	[Enabled]	
Primary Master	PIO [Auto]	
Primary Slave	PIO [Auto]	
Secondary Master	PIO [Auto]	
Secondary Slave	PIO [Auto]	
Primary Master	UDMA [Auto]	
Primary Slave	UDMA [Auto]	
Secondary Master	UDMA [Auto]	
Secondary Slave	UDMA [Auto]	

↑↓→← : Move Enter : Select +/-/PU/PD:Value: F10: Save ESC: Exit F1:General Help
F5:Previous Values F6:Fail-Safe Defaults F7:Optimized Defaults

On-Chip IDE Channel 0/1 (Enabled)

Use these items to enable or disable the PCI IDE channels that are integrated on the mainboard.

IDE Prefetch Mode (Enabled)

The onboard IDE drive interfaces supports IDE prefetching, for faster drive access. If you install a primary and secondary add-in IDE interface, set this field to Disabled if the interface does not support prefetching.

IDE Primary/Secondary Master/Slave PIO (Auto)

Each IDE channel supports a master device and a slave device. These four items let you assign which kind of PIO (Programmed Input/Output) is used by IDE devices. Choose Auto to let the system auto detect which PIO mode is best, or select a PIO mode from 0-4.

IDE Primary/Secondary Master/Slave UDMA (Auto)

Each IDE channel supports a master device and a slave device. This mainboard supports UltraDMA technology, which provides faster access to IDE devices.

If you install a device that supports UltraDMA, change the appropriate item on this list to Auto. You may have to install the UltraDMA driver supplied with this mainboard in order to use an UltraDMA device.

Press <Esc> to return to the Integrated Peripherals screen.

► OnChip PCI Device

Scroll to this item and press <Enter> to view the following screen:

CMOS Setup Utility – Copyright (C) 1984 – 2001 Award Software
OnChip PCI Device

OnChip AC97 Audio	[Auto]	Item Help
VIA-3068 MC97 Modem	[Auto]	
		Menu Level ►►

↑ ↓ → ← : Move Enter : Select +/-/PU/PD:Value: F10: Save ESC: Exit F1:General Help
F5:Previous Values F6:Fail-Safe Defaults F7:Optimized Defaults

OnChip AC97 Audio (Auto)

Enables and disables the onboard audio chip. Disable this item if you are going to install a PCI audio add-in card.

VIA-3068 MC97 Modem (Auto)

Enables and disables the onboard modem. Disable this item if you are going to install an external modem.

Press <Esc> to return to the Integrated Peripherals screen.

► SuperIO Device

Scroll to this item and press <Enter> to view the following screen:

CMOS Setup Utility – Copyright (C) 1984 – 2001 Award Software
SuperIO Device

POWER ON Function	[Hot KEY]	Item Help
KB Power ON Password	[Enter]	
Hot Key Power ON	[Ctrl-F12]	
Onboard FDC Controller	[Enabled]	Menu Level ►►
Onboard Serial Port 1	[3F8/IRQ4]	
Onboard Serial Port 2	[2F8/IRQ3]	
UART Mode Select	[Normal]	
UR2 Duplex Mode	[Half]	
Onboard Parallel Port	[378/IRQ7]	
Parallel Port Mode	[ECP]	
ECP Mode Use DMA	[3]	
Game Port Address	[201]	
Midi Port Address	[330]	
Midi Port IRQ	[10]	

↑↓→← : Move Enter : Select +/-/PU/PD:Value: F10: Save ESC: Exit F1:General Help
 F5:Previous Values F6:Fail-Safe Defaults F7:Optimized Defaults

POWER ON Function (Hot KEY)

Enables computer power on by keyboard, mouse, or hotkey activity.

KB Power ON Password

Enables you to set a password to be entered when using the keyboard to power on the computer.

Hot Key Power ON (Ctrl-F12)

Enables you to select a hot key to turn on the computer.

Onboard FDC Controller (Enabled)

This option enables the onboard floppy disk drive controller.

Onboard Serial Port 1 (3F8/IRQ4)

This option is used to assign the I/O address and address and interrupt request (IRQ) for onboard serial port 1 (COM1).

Onboard Serial Port 2 (2F8/IRQ3)

This option is used to assign the I/O address and address and interrupt request (IRQ) for onboard serial port 2 (COM2).

UART Mode Select (Normal)

This field is available if the Onboard Serial Port 2 field is set to any option but Disabled. UART Mode Select enables you to select the infrared communication protocol-Normal (default), IrDA, or ASKIR. IrDA is an infrared communication protocol with a maximum baud rate up to 115.2K bps. ASKIR is Sharp's infrared communication protocol with a maximum baud rate up to 57.6K bps.

UR2 Duplex Mode (Half)

This field is available when UART 2 Mode is set to either ASKIR or IrDA. This item enables you to determine the infrared (IR) function of the onboard infrared chip. The options are Full and Half (default).

Full-duplex means that you can transmit and send information simultaneously. Half-duplex is the transmission of data in both directions, but only one direction at a time.

Onboard Parallel Port (378/IRQ7)

This option is used to assign the I/O address and interrupt request (IRQ) for the onboard parallel port.

Parallel Port Mode (ECP)

Enables you to set the data transfer protocol for your parallel port. There are four options: SPP (Standard Parallel Port), EPP (Enhanced Parallel Port), ECP (Extended Capabilities Port) and ECP+EPP.

SPP allows data output only. Extended Capabilities Port (ECP) and Enhanced Parallel Port (EPP) are bi-directional modes, allowing both data input and output. ECP and EPP modes are only supported with EPP and ECP aware peripherals.

ECP Mode Use DMA (3)

When the onboard parallel port is set to ECP mode, the parallel port can use DMA 3 or DMA 1.

Game Port Address (201)

This item sets the I/O address for the game port.

Midi Port Address (330)

This item sets the I/O address for the Midi function.

Midi Port IRQ (10)

This item sets the interrupt request for the Midi function.

Press <Esc> to return to the Integrated Peripherals screen.

Init Display First (PCI Slot)

Use this item to specify whether your graphics adapter is installed in one of the PCI slots or is integrated on the mainboard.

OnChip USB Controller (All Enabled)

Enable this item if you plan to use the Universal Serial Bus ports on this mainboard.

USB Keyboard Support (Disabled)

Enable this item if you plan to use a keyboard connected through the USB port in a legacy operating system (such as DOS) that does not support Plug and Play.

IDE HDD Block Mode (Enabled)

Enable this field if your IDE hard drive supports block mode. Block mode enables BIOS to automatically detect the optimal number of block read and writes per sector that the drive can support and improves the speed of access to IDE devices.

Power Management Setup Option

This option displays items that let you control the system power management. Modern operating systems take care of much of the power management. This mainboard supports ACPI (Advanced Configuration and Power Interface). The system has various power saving modes including powering down the hard disk, turning off the video, suspending to RAM, and a software power down that allows the system to be automatically resumed by certain events.

Power Management Timeouts

The power-saving modes can be controlled by timeouts. If the system is inactive for a time, the timeouts begin counting. If the inactivity continues so that the timeout period elapses, the system enters a power-saving mode. If any item in the list of Reload Global Timer Events is Enabled, then any activity on that item will reset the timeout counters to zero.

Wake Up Calls

If the system is suspended, or has been powered down by software, it can be resumed by a wake up call that is generated by incoming traffic to a modem, a LAN card, a PCI card, or a fixed alarm on the system realtime clock,

CMOS Setup Utility – Copyright (C) 1984 – 2001 Award Software
Power Management Setup

ACPI function	[Enabled]	Item Help
ACPI Suspend Type	[S1(POS)]	
Power Management Option	[User Define]	
HDD Power Down	[Disable]	Menu Level ▶
Video Off Option	[Suspend -> Off]	
Video Off Method	[DPMS Support]	
MODEM Use IRQ	[3]	
Soft-Off by PWRBTN	[Instant-Off]	
AC Resume Function	[Always Off]	
▶ IRQ/Event Activity Detect	[Press Enter]	

↑↓→← : Move Enter : Select +/-/PU/PD:Value: F10: Save ESC: Exit F1:General
Help F5:Previous Values F6:Fail-Safe Defaults F7:Optimized Defaults

ACPI Function (Enabled)

This mainboard supports ACPI (Advanced Configuration and Power management Interface). Use this item to enable or disable the ACPI feature.

Note: ACPI is a power management specification that makes hardware status information available to the operating system. ACPI enables a PC to turn its peripherals on and off for improved power management. It also allows the PC to be turned on and off by external devices, so that mouse or keyboard activity wakes up the computer.

ACPI Suspend Type (S1 (POS))

Use this item to define how your system suspends. In the default, S1(POS), the suspend mode is equivalent to a software power down. If you select S3 (STR), the suspend mode is a suspend to RAM - the system shuts down with the exception of a refresh current to the system memory.

Power Management Option (User Define)

This item acts like a master switch for the power-saving modes and hard disk timeouts. If this item is set to Max Saving, power-saving modes occur after a short timeout. If this item is set to Min Saving, power-saving modes occur after a longer timeout. If the item is set to User Define, you can insert your own timeouts for the power-saving modes.

HDD Power Down (Disable)

The IDE hard drive will spin down if it is not accessed within a specified length of time. Options are from 1 Min to 15 Min and Disable.

Suspend Mode (Disable)

The CPU clock will be stopped and the video signal will be suspended if no Power Management events occur for a specified length of time. Full power function will return when a Power Management event is detected. Options are from 1 Min to 1 Hour and Disable.

Video Off Option (Suspend --> Off)

This option defines if the video is powered down when the system is put into suspend mode.

Video Off Method (DPMS Support)

This item defines how the video is powered down to save power. This item is set to DPMS (Display Power Management Software) by default.

MODEM Use IRQ (3)

If you want an incoming call on a modem to automatically resume the system from a power-saving mode, use this item to specify the interrupt request line (IRQ) that is used by the modem. You might have to connect the fax/modem to the mainboard Wake On Modem connector for this feature to work.

Soft-Off by PWRBTN (Instant-Off)

Under ACPI (Advanced Configuration and Power management Interface) you can create a software power down. In a software power down, the system can be resumed by Wake Up Alarms. This item lets you install a software power down that is controlled by the normal power button on your system. If the item is set to Instant-Off, then the power button causes a software power down. If the item is set to Delay 4 Sec. then you have to hold the power button down for four seconds to cause a software power down.

AC Resume Function (Always Off)

This sets the power state after a shutdown due to an unexpected interrupt of AC power.

► IRQ/Event Activity Detect

Scroll to this item and press <Enter> to view the following screen:

CMOS Setup Utility – Copyright (C) 1984 – 2000 Award Software
IRQ/Event Activity Detect

USB Resume from S3/S4/S5	[Disabled]	Item Help
VGA	[OFF]	
LPT & COM	[LPT/COM]	Menu Level ►►
HDD & FDD	[ON]	
PCI Master	[OFF]	
PowerOn by PCI Card	[Enabled]	
Wake Up On LAN/Ring	[Enabled]	
RTC Alarm Resume	[Disabled]	
x Date (of Month)	0	
x Resume Time (hh:mm:ss)	0 0 0	
► IRQs Activity Monitoring	[Press Enter]	

↑↓→← : Move Enter : Select +/-/PU/PD:Value: F10: Save ESC: Exit F1:General Help
F5:Previous Values F6:Fail-Safe Defaults F7:Optimized Defaults

This item opens a submenu that enables you to set events that will resume the system from a power saving mode.

USB Resume from S3/S4/S5 (Disabled)

When enabled, the system power will resume the system from a power saving mode if there is any USB port activity.

VGA (Off)

When set to On, the system power will resume the system from a power saving mode if there is any VGA activity.

LPT & COM (LPT/COM)

When this item is enabled, the system will restart the power-saving timeout counters when any activity is detected on the serial ports, or the parallel port.

HDD & FDD (ON)

When this item is enabled, the system will restart the power-saving timeout counters when any activity is detected on the hard disk drive or the floppy diskette drive.

PCI Master (OFF)

When set to Off, any PCI device set as the Master will not power on the system.

PowerOn by PCI Card (Enabled)

Use this item to enable PCI activity to wakeup the system from a power saving mode.

Wake Up On LAN/Ring (Disabled)

Use this item to enable LAN or modem activity to wakeup the system from a power saving mode.

RTC Alarm Resume (Disabled)

When set to Enabled, the following two fields become available and you can set the date (day of the month), hour, minute and second to turn on your system. When set to 0 (zero) for the day of the month, the alarm will power on your system every day at the specified time.

▶▶ IRQs Activity Monitoring

Scroll to this item and press <Enter> to view the following screen:

CMOS Setup Utility – Copyright (C) 1984 – 2001 Award Software
IRQs Activity Monitoring

		Item Help
Primary INTR	[ON]	
IRQ 3 (COM2)	[Enabled]	
IRQ 4 (COM1)	[Enabled]	
IRQ 5 (LPT2)	[Enabled]	
IRQ 6 (Floppy Disk)	[Enabled]	
IRQ 7 (LPT1)	[Enabled]	
IRQ 8 (RTC Alarm)	[Disabled]	
IRQ 9 (IRQ2 Redir)	[Disabled]	
IRQ 10 (Reserved)	[Disabled]	
IRQ 11 (Reserved)	[Disabled]	
IRQ 12 (PS/2 Mouse)	[Enabled]	
IRQ 13 (Coprocessor)	[Enabled]	
IRQ 14 (Hard Disk)	[Enabled]	
IRQ 15 (Reserved)	[Disabled]	

↑↓→← : Move Enter : Select +/-/PU/PD:Value: F10: Save ESC: Exit F1:General Help
F5:Previous Values F6:Fail-Safe Defaults F7:Optimized Defaults

This screen enables you to set IRQs that will resume the system from a power saving mode.

Set any IRQ to Enabled to allow activity at the IRQ to wake up the system from a power saving mode.

PNP/PCI Configuration Option

This option displays a table of items that configures how PnP (Plug and Play) and PCI expansion cards operate in your system. Both the ISA and PCI buses on the Mainboard use system IRQs (Interrupt ReQuests) and DMAs (Direct Memory Access). You must set up the IRQ and DMA assignments correctly through the PnP/PCI Configurations Setup utility; otherwise, the mainboard will not work properly. Selecting PnP/PCI Configurations on the main program screen displays this menu:

CMOS Setup Utility – Copyright (C) 1984 – 2001 Award Software
PnP/PCI Configurations

		Item Help
PNP OS Installed	[No]	
Reset Configuration Data	[Disabled]	
Resources Controlled by	[Auto(ESCD)]	
x IRQ Resources	Press Enter	
PCI/VGA Palette Snoop	[Disabled]	
Assign IRQ For VGA	[Enabled]	
Assign IRQ For USB	[Enabled]	
		Menu Level ▶ Select Yes if you are using a Plug and Play capable operating system Select No if you need the BIOS to configure non-boot devices

↑↓→←: Move Enter : Select +/-/PU/PD: Value: F10: Save ESC: Exit F1: General Help
F5: Previous Values F6: Fail-Safe Defaults F7: Optimized Defaults

PNP OS Installed (No)

Setting this option to Yes allows the PnP OS (instead of BIOS) to assign the system resources such as IRQ and I/O address to the ISA PnP device. The default setting is No.

Reset Configuration Data (Disabled)

If you enable this item and restart the system, any Plug and Play configuration data stored in the BIOS setup is cleared from memory. New updated data is created.

Resources Controlled By (Auto(ESCD))

You should leave this item at the default Auto(ESCD). Under this setting, the system dynamically allocates resources to plug and play devices as they are required.

If you cannot get a legacy ISA (Industry Standard Architecture) expansion card to work properly, you might be able to solve the problem by changing this item to Manual, and then opening up the IRQ Resources and Memory Resources sub-menus.

In the IRQ Resources sub-menu, if you change any of the IRQ assignments to Legacy ISA, then that Interrupt Request Line is reserved for a legacy ISA expansion card. Press <Esc> to close the IRQ Resources sub-menu.

In the Memory Resources sub menu, use the first item Reserved Memory Base to set the start address of the memory you want to reserve for the ISA expansion card. Use the second item Reserved Memory Length to set the amount of reserved memory. Press <Esc> to close the Memory Resources sub-menu.

PCI/VGA Palette Snoop (Disabled)

This item is designed to overcome some problems that can be caused by some non-standard VGA cards. This board includes a built-in VGA system that does not require palette snooping so you must leave this item disabled.

Assign IRQ for VGA/USB (Enabled)

Names the interrupt request (IRQ) line assigned to the USB/VGA (if any) on your system. Activity of the selected IRQ always awakens the system.

PCI Health Status Option

On mainboards that support hardware monitoring, this item lets you monitor the parameters for critical voltages, critical temperatures, and fan speeds. You cannot make any changes to these fields. They are display only:

CMOS Setup Utility – Copyright (C) 1984 – 2001 Award Software
PC Health Status

Shutdown Temperature	[65°C/149°F]	Item Help
Vcore		
+ 2.5V		
+ 3.3V		
VccIN		
+ 12V		
- 12V		
3.3V Battery		
System Temperature		
CPU Temperature		
CPU FAN speed		
Current FAN2 speed		
System Fan Speed		

↑↓→← : Move Enter : Select +/-/PU/PD:Value: F10: Save ESC: Exit F1:General Help
F5:Previous Values F6:Fail-Safe Defaults F7:Optimized Defaults

Shutdown Temperature

Enables you to set the maximum temperature the system can reach before powering down.

System Component Characteristics

These fields provide you with information about the systems current operating status. You cannot make changes to these fields.

Frequency/Voltage Control

This item enables you to set the clock speed and system bus for your system. The clock speed and system bus are determined by the kind of processor you have installed in your system.

CMOS Setup Utility – Copyright (C) 1984 – 2001 Award Software
Frequency/Voltage Control

Auto Detect DIMM/PCI Clk	[Enabled]	Item Help
Spread Spectrum Modulated	[Enabled]	
CPU Host/PCI Clock	[Default]	Menu Level ▶

↑↓→← : Move Enter : Select +/-/PU/PD:Value: F10: Save ESC: Exit F1:General Help
F5:Previous Values F6:Fail-Safe Defaults F7:Optimized Defaults

Auto Detect DIMM/PCI Clk (Enabled)

When this item is enabled, BIOS will disable the clock signal of free DIMM and PCI slots.

Spread Spectrum (Enabled)

If you enable spread spectrum, it can significantly reduce the EMI (Electro-Magnetic Interference) generated by the system.

CPU Host Clock (CPU/PCI) (Default)

Use the CPU Host Clock to set the frontside bus frequency for the installed processor or processors (usually 133 MHz, 100 MHz or 66 MHz).

Load Fail-Safe Defaults Option

This option opens a dialog box that lets you install fail-safe defaults for all appropriate items in the Setup Utility:

Press <Y> and then <Enter> to install the defaults. Press <N> and then <Enter> to not install the defaults. The fail-safe defaults place no great demands on the system and are generally stable. If your system is not functioning correctly, try installing the fail-safe defaults as a first step in getting your system working properly again. If you only want to install fail-safe defaults for a specific option, select and display that option, and then press <F6>.

Load Optimized Defaults Option

This option opens a dialog box that lets you install optimized defaults for all appropriate items in the Setup Utility. Press <Y> and then <Enter> to install the defaults. Press <N> and then <Enter> to not install the defaults. The optimized defaults place demands on the system that may be greater than the performance level of the components, such as the CPU and the memory. You can cause fatal errors or instability if you install the optimized defaults when your hardware does not support them. If you only want to install setup defaults for a specific option, select and display that option, and then press <F7>.

Set Supervisor and User Passwords Options

These items can be used to install a password. A Supervisor password takes precedence over a User password, and the Supervisor can limit the activities of a User. To install a password, follow these steps:

1. Highlight the item Set Supervisor/User Password on the main menu and press <Enter>.
2. The password dialog box appears.

Enter Password:

3. If you are installing a new password, type in the password. You cannot use more than eight characters or numbers. The Set Supervisor/User Password item differentiates between upper case and lower characters. Press <Enter> after you have typed in the password. If you are deleting a password that is already installed just press <Enter> when the password dialog box appears. You see a message that indicates that the password has been disabled.

PASSWORD DISABLED !!!
Press any key to continue . . .

4. Press any key. You are prompted to confirm the password:

Confirm Password:

5. Type the password again and press <Enter>, or just press <Enter> if you are deleting a password that is already installed.
6. If you typed the password correctly, the password will be installed.

Save & Exit Setup Option

Highlight this item and press <Enter> to save the changes that you have made in the Setup Utility and exit the Setup Utility. When the Save and Exit dialog box appears, press <Y> to save and exit, or press <N> to return to the main menu:

Exit Without Saving

Highlight this item and press <Enter> to discard any changes that you have made in the Setup Utility and exit the Setup Utility. When the Exit Without Saving dialog box appears, press <Y> to discard changes and exit, or press <N> to return to the main menu.

Note: If you have made settings that you do not want to save, use the "Exit Without Saving" item and press Y to discard any changes you have made.

This concludes Chapter 3. Refer to the next chapter for information on the software supplied with the mainboard.

Using the Mainboard Software

About the Software CD-ROM

The support software CD-ROM that is included in the mainboard package contains all the drivers and utility programs needed to properly run the bundled products. Below you can find a brief description of each software program, and the location for your mainboard version. More information on some programs is available in a README file, located in the same directory as the software.

Note: Never try to install software from a folder that is not specified for use with your mainboard.

Before installing any software, always inspect the folder for files named README.TXT, INSTALL.TXT, or something similar. These files may contain important information that is not included in this manual.

Drivers Installation

Audio Drivers and Software

Most of the sub-folders in this folder are empty, with a short README file giving directions to alternate folders for the appropriate software.

Installation for Windows 2000/98/98SE/ME/95

To install the audio drivers, go to the directory \SOUND\VIA8233\; then run SETUP.EXE

Installation for Windows NT4.0

1. Click Start.
2. Click Settings and then click Control Panel.
3. Double-click the Multimedia icon.
4. Select the Device tab.
5. Click Add.
6. Select the item "Unlisted or Updated Driver" in the List of Drivers in the list box and then specify the path to the PCI audio NT drivers (\SOUND\VIA8233\NT4).
7. Select "Avance Logic, Inc. AC'97" and click OK.
8. Choose the proper I/O or click OK for the default setting. Setup installs the drivers and software.
9. Restart the Windows NT system when prompted.

IDE Software

This folder has software and drivers for the IDE that is integrated on this mainboard. Drivers are provided for Windows 2000/98 and Windows NT.

Installation for Windows 2000/98/NT

Browse to the \IDEVIA folder and run SETUP.EXE to install the IDE driver for your operating system.

Utility Folder Installation Notes

All the utility software available from this page is Windows compliant. They are provided only for the convenience of the users. The following software is furnished under license and may only be used or copied in accordance with the terms of the license.

Note: This software is subject to change at anytime without prior notice. Please refer to the support CD for available software.

Award Flash Memory Utility

This utility lets you erase the system BIOS stored on a Flash Memory chip on the mainboard, and lets you copy an updated BIOS to the chip. Take care how you use this program. If you erase the current BIOS and fail to write a new BIOS, or write a new BIOS that is incorrect, your system will malfunction. Refer to Chapter 3, *Using BIOS* for more information.

PC-cillin Software

The PC-cillin software program provides anti-virus protection for your system. This program is available for Windows 2000/ME/ 98SE and Windows NT. Be sure to check the readme.txt and install the appropriate anti-virus software for your operating system.

We strongly recommend users to install this free anti-virus software to protect your system against the various viruses that may occur every day.

CD Ghost

The CD Ghost software enables you to create a virtual cabinet of CD-ROM drives on your system to help you categorize and organize your CD collection. A user-friendly interface assists you in quickly creating images of both CDs and DVDs onto your system. To install the software, run SETUP.EXE from the following directory:

`\UTILITY\CDGHOST\ENG\CDGHOST`

Recovery Genius

The Recovery Genius software program is an innovative windows application system that protects your Hard Disk Drive from virus intrusion, accidental deletions and from system corruption. To install the Recovery Genius software program run SETUP.EXE from the following directory:







```
\UTILITY\RECOVERY GENIUS\ENG\  
RECOVERYGENIUS
```

This concludes Chapter 4.

Appendix A

Setting Jumpers

Jumper Settings

Jumper	Type	Description	Setting (default)
JP1	3 pin	KB/USB power on	1-2: Disable 2-3: <i>Enable</i> JP1 1 
JP3	3 pin	CPU frequency select	1-2: 100 MHz 2-3: 133 MHz JP3 1 
JP4	3 pin	BIOS voltage select	1-2: 5V 2-3: 3.3V JP4 1 
JP5	3 pin	BIOS protection	1-2: Disable 2-3: <i>Enable</i> JP5 1 
JP6	3 pin	USB2/3 power on	1-2: <i>Disable</i> 2-3: Enable JP6 1 
JP7	3 pin	Clear CMOS	1-2: <i>Normal</i> 2-3: Clear JP7 1 

Jumper 1 – enable this jumper if you want keyboard or USB activity to awaken the system from power saving mode.

Jumper 3 – select 100 MHz to force a 66 MHz FSB CPU to run at 100 MHz FSB. Select 133 MHz to force a 100 MHz FSB CPU to run at 133 MHz FSB. We recommend that you leave the jumper at the default setting.

Note: Forcing the CPU to run at a speed higher than it was designed for is called overclocking and is not recommended.

Jumper 4 – selects the BIOS voltage parameters. DO NOT make any adjustments to this jumper.

Jumper 5 – enables you to prevent the BIOS from being updated (flashed). Set the jumper to enabled if you are going to update your BIOS. After updating the BIOS, return it to the default setting (disabled). For instructions on updating the BIOS refer to Chapter 3.

Jumper 6 – enable this jumper if you want device activity on front panel USB ports 2/3 activity to turn on the computer.

Jumper 7 – enables you to clear the BIOS:

1. Turn the system off.
2. Short pins 2 and 3 on jumper 7.
3. Return the jumper to the normal setting.
4. Turn the system on. The BIOS is returned to the default settings.

The Panel Connector

The panel connector provides a standard set of switch and LED connectors usually found on ATX or micro-ATX cases. Refer to the table below for information:

Device	Pins
Empty	10
N/C	9
Power ON/OFF	6, 8
Reset Switch	5, 7
Green LED Indicator	2, 4
HDD LED	+1, -3

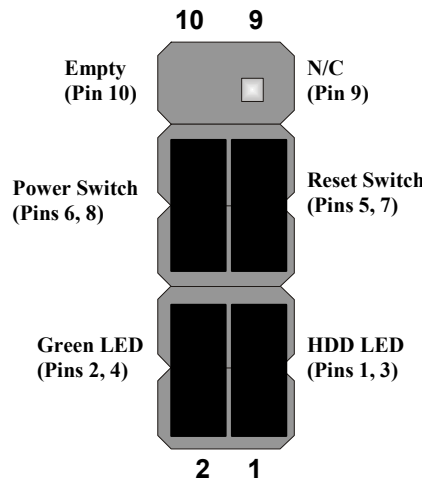

Note: The plus sign (+) indicates a pin which must be connected to a positive voltage.
