

Preface

Copyright

This publication, including all photographs, illustrations and software, is protected under international copyright laws, with all rights reserved. Neither this manual, nor any of the material contained herein, may be reproduced without written consent of the author.

Version 1.1

Disclaimer

The information in this document is subject to change without notice. The manufacturer makes no representations or warranties with respect to the contents hereof and specifically disclaims any implied warranties of merchantability or fitness for any particular purpose. The manufacturer reserves the right to revise this publication and to make changes from time to time in the content hereof without obligation of the manufacturer to notify any person of such revision or changes.

Trademark Recognition

Microsoft, MS-DOS and Windows are registered trademarks of Microsoft Corp.

MMX, Pentium, Pentium-II, Pentium-III, Celeron are registered trademarks of Intel Corporation.

Other product names used in this manual are the properties of their respective owners and are acknowledged.

**Copyright © 2001
All Rights Reserved
KOB 694X FSX**

Federal Communications Commission (FCC)

This equipment has been tested and found to comply with the limits for a Class B digital device, pursuant to Part 15 of the FCC Rules. These limits are designed to provide reasonable protection against harmful interference in a residential installation. This equipment generates, uses, and can radiate radio frequency energy and, if not installed and used in accordance with the instructions, may cause harmful interference to radio communications. However, there is no guarantee that interference will not occur in a particular installation. If this equipment does cause harmful interference to radio or television reception, which can be determined by turning the equipment off and on, the user is encouraged to try to correct the interference by one or more of the following measures:

- Reorient or relocate the receiving antenna.
- Increase the separation between the equipment and the receiver.
- Connect the equipment onto an outlet on a circuit different from that to which the receiver is connected.
- Consult the dealer or an experienced radio/TV technician for help.

Shielded interconnect cables and a shielded AC power cable must be employed with this equipment to ensure compliance with the pertinent RF emission limits governing this device. Changes or modifications not expressly approved by the system's manufacturer could void the user's authority to operate the equipment.

Declaration of Conformity

This device complies with part 15 of the FCC rules. Operation is subject to the following conditions:

- This device may not cause harmful interference, and
- This device must accept any interference received, including interference that may cause undesired operation.

Canadian Department of Communications

This class B digital apparatus meets all requirements of the Canadian Interference-causing Equipment Regulations.

Cet appareil numérique de la classe B respecte toutes les exigences du Règlement sur le matériel brouilleur du Canada.

About the Manual

The manual consists of the following:

<i>Chapter 1</i> Introducing the Mainboard	Describes features of the mainboard, and provides a shipping checklist. Go to ⇒ page 1
<i>Chapter 2</i> Installing the Mainboard	Describes installation of mainboard components. Go to ⇒ page 9
<i>Chapter 3</i> Using BIOS	Provides information on using the BIOS Setup Utility. Go to ⇒ page 35
<i>Chapter 4</i> Using the Mainboard Software	Describes the mainboard software. Go to ⇒ page 68
<i>Appendix A</i> Setting Jumpers	Provides a reference to the jumpers on the mainboard. Go to ⇒ page 72

TABLE OF CONTENTS

Preface	i
CHAPTER 1	1
Introducing the Mainboard	1
<i>Introduction</i>	1
<i>Checklist</i>	2
Standard Items	2
<i>Features</i>	3
<i>Mainboard Components</i>	6
<i>Choosing a Computer Case</i>	8
CHAPTER 2	9
Installing the Mainboard	9
<i>Safety Precautions</i>	9
<i>Quick Guide</i>	10
<i>Checking Jumper Settings</i>	11
Setting Jumpers	11
Checking Jumper Settings	12
Jumper Settings	13
<i>Installing the Mainboard in a Case</i>	15
<i>Connecting Case Components</i>	16
The Panel Connector	17
<i>Installing Hardware</i>	18
Installing the Processor	18
Install Memory Modules	21
Installing a Hard Disk Drive/CD-ROM	23
Installing a Floppy Diskette Drive	26
Installing Add-on Cards	28
Connecting Optional Devices	30
<i>Connecting I/O Devices</i>	33
External Connector Color Coding	34
CHAPTER 3	35
Using BIOS	35
<i>About the Setup Utility</i>	35
The Standard Configuration	36
Entering the Setup Utility	37
Updating the BIOS	38
<i>Using BIOS</i>	39

Standard CMOS Features	39
Advanced BIOS Setup Option.....	42
Advanced Chipset Features Option	46
Integrated Peripherals Option.....	50
Power Management Setup Option.....	53
PNP/PCI Configuration Option	60
Frequency Control Option.....	63
Load Fail-Safe Defaults Option.....	65
Load Optimized Defaults Option	65
Set Supervisor and User Passwords Options	66
Save & Exit Setup Option	67
Exit Without Saving	67
CHAPTER 4	68
Using the Mainboard Software	68
<i>About the Software CD-ROM</i>	68
<i>Folders for this Mainboard</i>	68
IDE Folder.....	68
Audio Folder.....	68
Utility Folder.....	68
<i>IDE Folder Installation Notes</i>	69
<i>Audio Folder Installation Notes</i>	69
Windows Installation	69
DOS Installation	69
Linux Installation	69
<i>Utility Folder Installation Notes</i>	70
Award Flash Memory Utility.....	70
PC-cillin Software	70
CD-Ghost.....	70
Recovery Genius	71
WinDVD (optional).....	71
APPENDIX A	72
Setting Jumpers	72
Jumper Settings	72
The Panel Connector	74

Introducing the Mainboard

Introduction

Congratulations on purchasing this mainboard. This mainboard is an ATX mainboard that uses a 4-layer printed circuit board and measures 304 mm x 190 mm. The mainboard features a Socket 370 that accommodates FC-PGA Pentium III, and Cyrix III processors that support frontside bus (FSB) speeds up to 133 MHz.

This mainboard uses the VIA family chipset and features the AC 97 audio codec. The mainboard delivers high-level performance with a 4xAGP (Accelerated Graphics Port) slot and two PCI Bus Master Ultra DMA (UDMA) ports that support up to four ATAPI (AT Attachment Packet Interface) devices. The PCI IDE also supports PIO Mode 3 and 4, UDMA33/66 IDE, and an ATAPI CD-ROM.

The mainboard accommodates PC 100/133 SDRAM (Synchronous DRAM) up to 1.5 GB using three 3.3V unbuffered DIMM modules. This mainboard also has a full set of I/O ports, such as dual channel IDE interfaces, a floppy controller, two FIFO serial port connectors, an EPP/ECP-capable bidirectional parallel port connector, a dual USB (Universal Serial Bus) connector, and PS/2 keyboard and mouse connectors.

One AGP slot, four PCI local bus slots, two ISA slots and one audio modem riser (AMR) slot provide expandability for add-on peripheral cards.

Checklist

Compare the mainboard's package contents with the following checklists:

Standard Items

- One mainboard
- One diskette drive ribbon cable and bracket
- One IDE drive ribbon cable and bracket
- Software support CD
- This user's manual

Features

Processor	Functioning as a platform for a value PC, this mainboard features a Socket 370 that accommodates PPGA Celeron, Pentium III, and Cyrix III processors. It supports 66/100/133 MHz FSB speeds.
Chipset	<p>VIA VT82C694X Northbridge</p> <p>This board features the VIA VT82C694X NB (North Bridge) chipset, enabling synchronous and asynchronous frequency operation between the processor and the memory over a wide frequency range. The NB chipset is optimized for Pentium III processors at 66/100/133 MHz Front Side Bus (FSB) frequency and supports 32-bit processor bus addressing.</p> <p>The integrated DRAM controller supports up to four double-sided DIMMs consisting of EDO, SDRAM, or VCM SDRAM. The NB chipset provides SDRAM with 64-bit data access.</p> <p>The AGP interface is AGP specification Rev 2.0 compliant, and supports 2x/4x 3.3/1.5V devices. The PCI bus interface complies with PCI Rev. 2.1, and supports 3.3V and power supplies. Four PCI bus masters are supported in addition to the host and PCI-to-ISA I/O bridge.</p> <p>VIA VT82C686B Southbridge</p> <p>The VIA VT82C686B SB (South Bridge) chipset comes in a 352-pin BGA package. The PCI to ISA Bridge has an integrated ISA bus controller with integrated DMA, timer, and interrupt controllers.</p> <p>The Real Time Clock features extended 256 byte CMOS RAM and a day and month alarm for the ACPI (Advanced Configuration and Power Interface). UltraDMA 33/66/100 master mode EIDE controller with enhanced PCI bus commands.</p> <p>There is an integrated USB controller with a built-in root hub and four function ports.</p>

Chipset (continued)	<p>The integrated Ultra DMA-33/66/100 master mode EIDE controller with enhanced PCI bus commands.</p> <p>The UltraDMA-33/66/100 Master Mode PCI EIDE controller features dual channel master mode PCI supporting Enhanced IDE (EIDE) devices and employ transfer rates up to 33 MB/sec to cover PIO mode 4, multi-word DMA mode 2 drives, and UltraDMA-33 interface. The SB chipset also supports ATAPI compliant devices including DVD devices and four USB 1.1 ports for serial transfers at 12 or 1.5 Mbits/sec.</p> <p>The integrated super IO controller supports two serial ports, an IR port, parallel port, and floppy disk controller functions. There is also system monitor support, providing system feedback of voltage, temperature, and fan speed conditions.</p>
Memory	<p>The board has three DIMM sockets for the installation of 168-pin, 3.3V non-buffered DIMM memory modules. The DIMM memory modules can be SDRAM or VCM memory chips.</p>
VGA	<p>This mainboard includes a 4xAGP slot that provides four times the bandwidth of the original AGP specification. AGP technology provides a direct connection between the graphics sub-system and the processor so that the graphics do not have to compete for processor time with other devices on the PCI bus.</p> <p>The AGP design allows the graphics controller to use part of the main memory when it needs it, for example, in handling the very large texture maps required by virtual reality and 3D video games and applications.</p>
AC 97 Audio Codec	<p>The AC 97 Audio codec is compliant with the AC 97 2.1 specification, and supports 18-bit ADC (Analog Digital Converter) and DAC (Digital Analog Converter) resolution as well as 18-bit stereo full-duplex codec with independent and variable sampling rates. Further features include support for four analog line-level stereo inputs.</p>
Expansion Options	<p>Four 32-bit PCI slots, an AGP slot, two ISA slots and an AMR slot provide plenty of expansion po-</p>

	tential. The PCI slots support Ultra DMA33/66/100 bus mastering with transfer rates up to 33/66/100 MB/sec.
Integrated I/O	<p>The mainboard has a full set of I/O ports and connectors:</p> <ul style="list-style-type: none"> • Two PS/2 ports for mouse and keyboard • Two serial ports • One parallel port • One VGA port • One MIDI/game port • Four USB ports (2 backpanel ports, onboard USB header providing 2 extra ports) • Audio jacks for microphone, line-in and line-out
BIOS Firmware	<p>This mainboard uses Award BIOS that enables users to configure many system features including the following:</p> <ul style="list-style-type: none"> • Power management • CPU and memory timing • Modem wake up alarms <p>The firmware can also be used to set parameters for different processor clock speeds.</p>

Mainboard Components

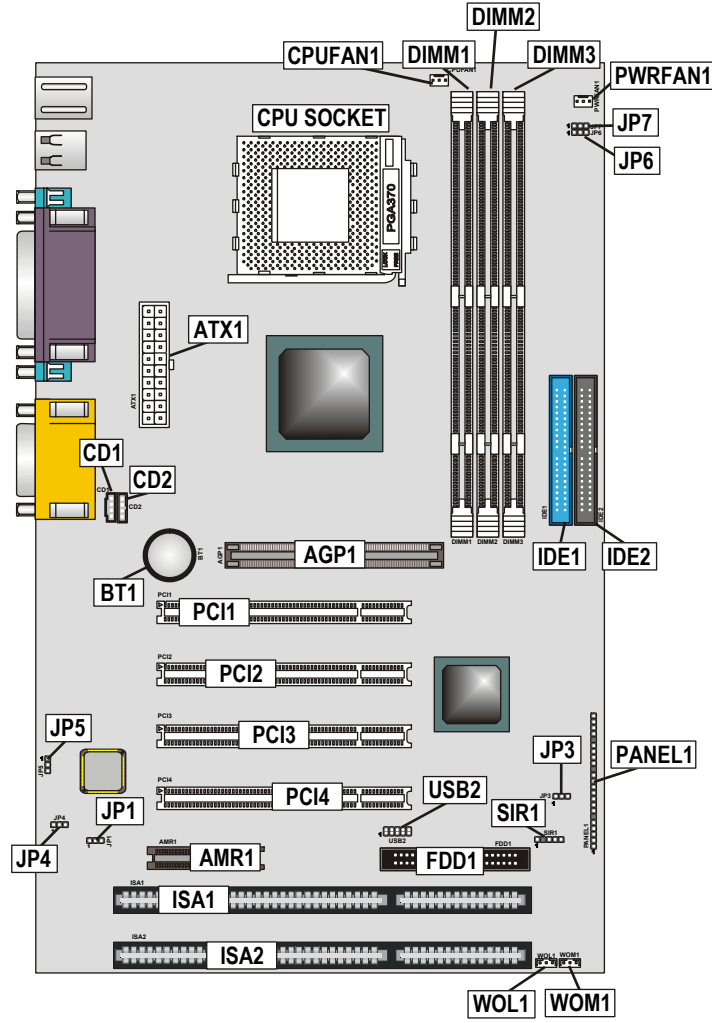

Table of Mainboard Components

Label	Component
AGP1	Accelerated Graphics Port
AMR1	Audio modem riser (AMR) slot
ATX1	Power connector
BT1	Three volt realtime clock battery
CD1	Primary CD-in connector
CD2	Secondary CD-in connector
CPU Socket	PGA370 CPU Socket
CPUFAN1	Cooling fan for CPU
DIMM1 ~ DIMM3	Three 184-pin DIMM sockets
FDD1	Floppy disk drive connector
IDE 1	Primary IDE channel
IDE 2	Secondary IDE channel
ISA1 ~ ISA2	Two ISA slots
JP1	Clear BIOS jumper
JP3	BIOS flash protection jumper
JP4	Onboard codec/AMR slot codec select jumper
JP5	AMR Master/Slave select jumper
JP6	CPU frequency select jumper 1
JP7	CPU frequency select jumper 2
PANEL1	Connector for case front panel switches and LED indicators
PCI1 ~ PCI4	Four 32-bit add-on card slots
PWRFAN1	Auxiliary case cooling fan
SIR1	Serial infrared cable header
USB2	Front panel USB headers
WOL1	Wake On LAN wakeup connector
WOM1	Wake On Modem wakeup connector

Choosing a Computer Case

There are many types of computer cases on the market. The mainboard complies with the specifications for the ATX system case. Some features on the mainboard are implemented by cabling connectors on the mainboard to indicators and switches on the system case. Ensure that your case supports all the features required. The mainboard can support two CD drives, one floppy diskette drive and four enhanced IDE drives. Ensure that your case has sufficient power and space for all the drives that you intend to install.

Most cases have a choice of I/O templates in the rear panel. Make sure that the I/O template in the case matches the I/O ports installed on the rear edge of the mainboard.

This mainboard has an ATX form factor of 190 x 304 mm. Choose a case that accommodates this form factor.

Installing the Mainboard

Safety Precautions

Follow these safety precautions when installing the mainboard:

- Wear a grounding strip attached to a grounded device to avoid damage from static electricity.
- Discharge static electricity by touching the metal case of a safely grounded object before working on the mainboard.
- Leave components in the static-proof bags they came in.
- Hold all circuit boards by the edges. Do not bend circuit boards.

Quick Guide

This Quick Guide suggests the steps you can take to build your system with the mainboards.

The following table describes installing specific components:

Locating Mainboard Components	Go to page 6
Installing Jumpers	Go to page 11
Installing the Mainboard in a Case	Go to page 15
Installing Case Components	Go to page 16
Installing the CPU	Go to page 18
Installing Memory	Go to page 21
Installing an HDD and CD-ROM Drive	Go to page 23
Installing an FDD	Go to page 26
Installing Add-on Cards	Go to page 28
Connecting Options	Go to page 30
Connecting Peripheral (I/O) Devices	Go to page 33

Note: The appendix provides a quick reference for jumper settings.

Checking Jumper Settings

This section explains how to set jumpers for correct configuration of the mainboard.

Setting Jumpers

Use the mainboard jumpers to set system configuration options. Jumpers with more than one pin are numbered. When setting the jumpers, ensure that the jumper caps are placed on the correct pins.

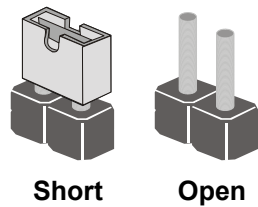

This illustration shows a 2-pin jumper. When the jumper cap is placed on both pins, the jumper is SHORT. If you remove the jumper cap, or place the jumper cap on just one pin, the jumper is OPEN.

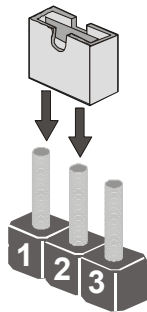





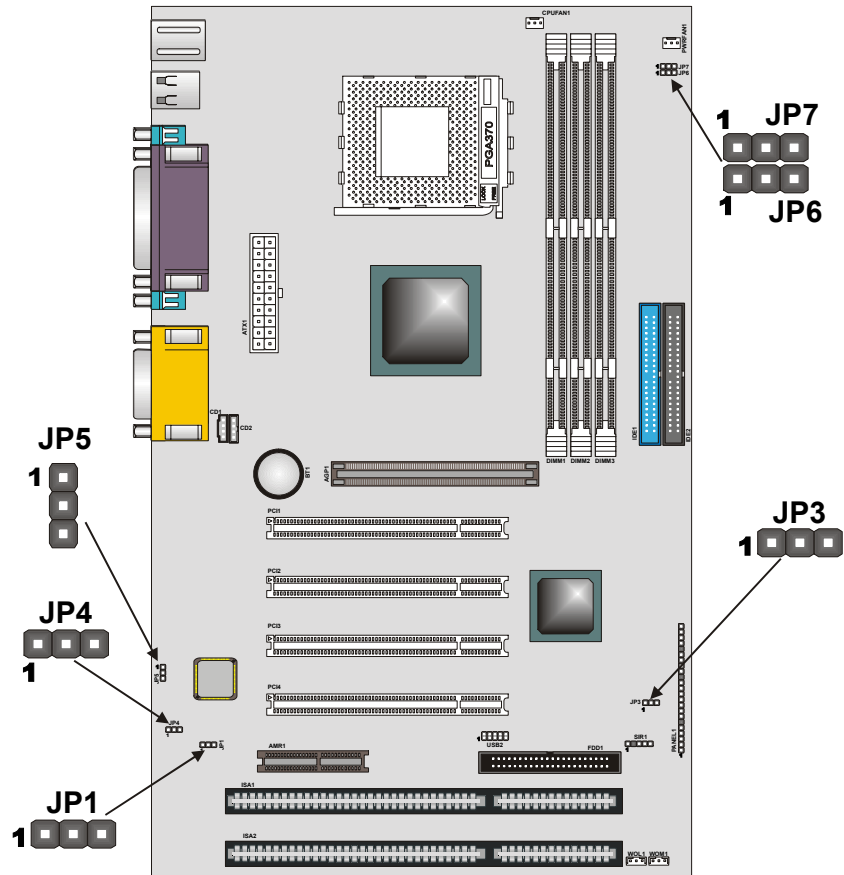

This illustration shows a 3-pin jumper. Pins 1 and 2 are SHORT.

Checking Jumper Settings

In the following illustration, only pin 1 is shown.



Jumper Settings

Jumper	Type	Description	Setting (default)	
JP1	3 pin	Clear CMOS jumper	1-2: <i>Normal</i> 2-3: Clear CMOS	JP1 1 
JP3	3 pin	BIOS flash protection jumper	1-2: <i>Unlock</i> 2-3: Lock	JP3 1 
JP4	3 pin	Onboard co-dec/AMR slot selector	1-2: <i>Onboard codec</i> 2-3: AMR slot	JP4 1 
JP5	3 pin	AMR Master/Slave selector	1-2: <i>Slave AMR</i> 2-3: Master AMR	JP5 1 
JP6	3 pin	CPU frequency jumper	1-2: <i>Normal operation</i> 2-3: Force a 66 MHz FSB to run at 100 MHz FSB	JP6 1 
JP7	3 pin	CPU frequency jumper	1-2: <i>Normal operation</i> 2-3: Force a 100 MHz FSB to run at 133 MHz FSB	JP7 1 

JP1: Clear CMOS Jumper

This jumper enables you to reset BIOS:

1. Turn the system off.
2. Short pins 2 and 3 on jumper 1.
3. Return the jumper to the normal setting.
4. Turn the system on. The BIOS is returned to the default settings.

JP3: BIOS Flash Protection Jumper

Set the jumper to disabled if you are going to update your BIOS. After updating the BIOS, return it to the default setting (enabled). For instructions on updating the BIOS refer to Chapter 3.

JP4: Onboard CODEC/AMR Slot Selection

This jumper is used to enable either the onboard codec or the AMR slot codec (AMR1).

JP5: AMR Master/Slave Select Jumper

This jumper is used to distinguish the AMR codec from the onboard AC 97 codec to avoid conflict.

JP6: CPU Frequency Select Jumper 1

This jumper is used to force a CPU clock running at 66 MHz FSB to run at 100 MHz FSB. It is recommended that you leave the jumper on the normal setting.

JP7: CPU Frequency Select Jumper 2

This jumper is similar to JP6 and is used to force a CPU clock running at 100 MHz FSB to run at 133 MHz FSB. It is recommended that you leave the jumper on the normal setting.

Note: The CPU speed is determined by the CPU Host/PCI Clock speed multiplied by the CPU Clock Ratio. Refer to the Frequency Control Option in Chapter 3 for more information. Also note that Forcing the CPU to run at a higher clock speed than it was rated for is called overlocking and is not recommended.

Installing the Mainboard in a Case

Most system cases have mounting brackets installed in the case, which correspond to the holes in the mainboard. Place the mainboard over the mounting brackets and secure the mainboard into the mounting brackets with screws.

Most cases have a choice of I/O templates in the rear panel. Make sure that the I/O template in the case matches the I/O ports installed on the rear edge of the mainboard.

This illustration shows a mainboard installed in a standard desktop case.

Note: Do not overtighten the screws as this can stress the mainboard.

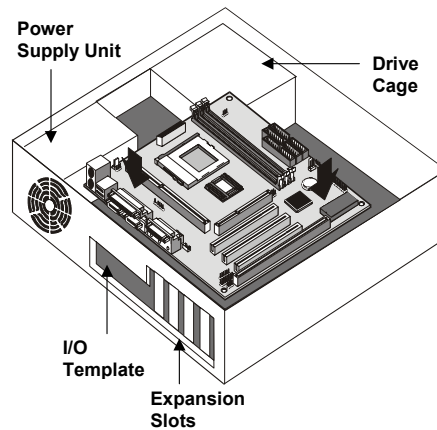

This illustration shows a mainboard installed in a tower-type case.

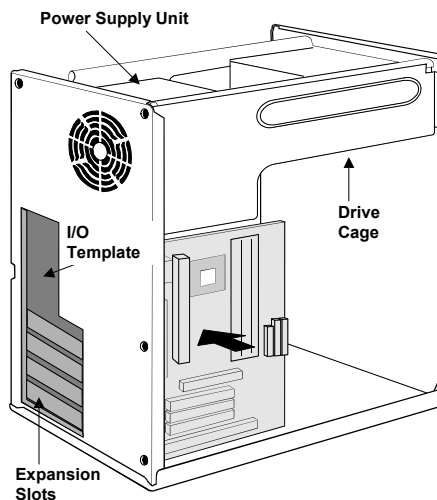

Connecting Case Components

After you have installed the mainboard into a case, you can begin connecting the mainboard components. Refer to the following:

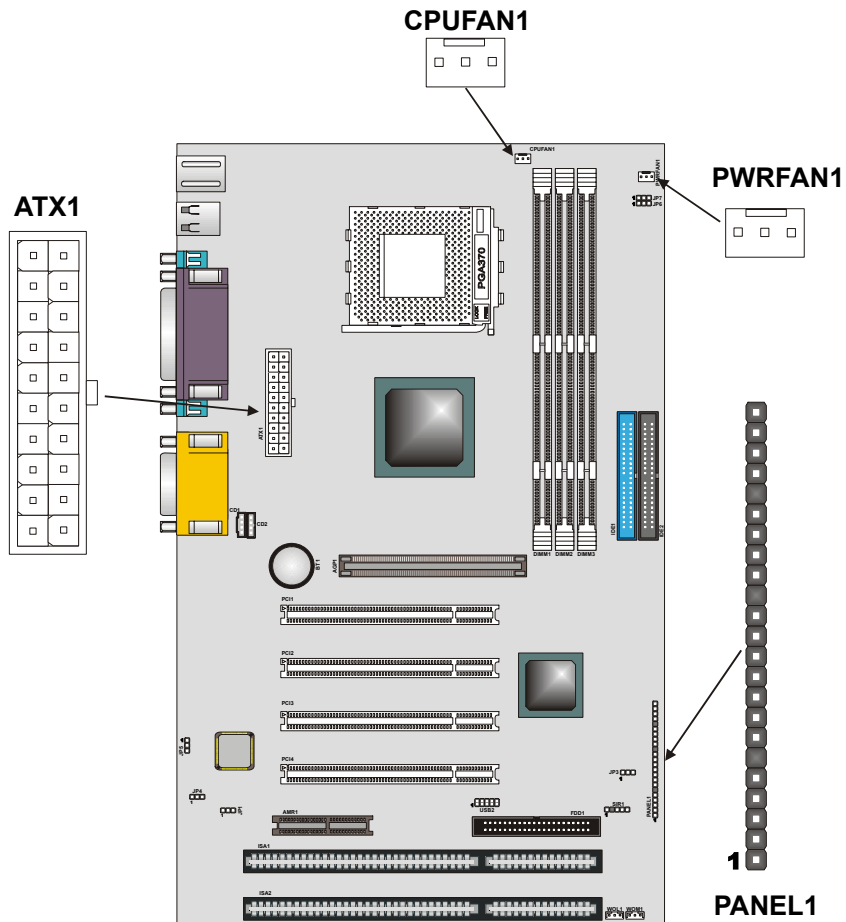















1. Connect the case power supply connector to ATX1.
2. Connect the CPU cooling fan cable to CPUFAN1.
3. Connect the case cooling fan connector to PWRFAN1

The following page explains how to make connections to PANEL1.

The Panel Connector

The panel connector provides a set of switch and LED connectors usually found on ATX or micro-ATX cases. Refer to the table below for information:

Device	Pins	23	
Power switch	22, 23		Power Switch (Pins 22, 23)
Hard disk LED Indicator	+20, -21		
Empty pin	19		HDD LED (Pins 20, 21)
Speaker	+15, -16, 17, 18		
Empty pin	14		Speaker (Pins 15, 16, 17, 18)
Reset switch	12, -13		
Empty pins	10, 11		
Green LED indicator	+7, +8, -9		Reset Switch (Pins 12, 13)
Empty pin	6		
Sleep switch	4, -5		Green LED (Pins 7, 8, 9)
Power LED indicator	+1, +2, -3		
			Sleep Switch (Pins 4, 5)
			
			Power LED (Pins 1, 2, 3)
		1	

Note: The plus sign (+) indicates a pin which must be connected to a positive voltage.

Installing Hardware

Installing the Processor

Caution: When installing a CPU heatsink and cooling fan make sure that you DO NOT scratch the mainboard or any of the surface-mount resistors with the clip of the cooling fan. If the clip of the cooling fan scrapes across the mainboard, you may cause serious damage to both the mainboard and the processor.

On most mainboards, there are small surface-mount resistors near the processor socket, which may be damaged if the cooling fan is carelessly installed.

Avoid using cooling fans with sharp edges on the fan casing and the clips. Also, install the cooling fan in a well-lit work area so that you can clearly see the mainboard and processor socket.

Before installing the Processor

This mainboard automatically determines the CPU clock frequency and system bus frequency for processor. You may be able to change these automatic settings by making changes to jumpers on the mainboard, or changing the settings in the system Setup Utility. We strongly recommend that you do not overclock the mainboard to run processors or other components faster than their rated speed.

Warning: Overclocking components can adversely affect the reliability of the system and introduce errors into your system. Overclocking can permanently damage the mainboard by generating excess heat in components that are run beyond the rated limits.

This mainboard has a Socket 370 processor socket. When choosing a processor, consider the performance requirements of the system. Performance is based on the processor design, the clock speed and system bus frequency of the processor, and the quantity of internal cache memory and external cache memory.

CPU Installation Procedure

The following illustration shows CPU installation components:

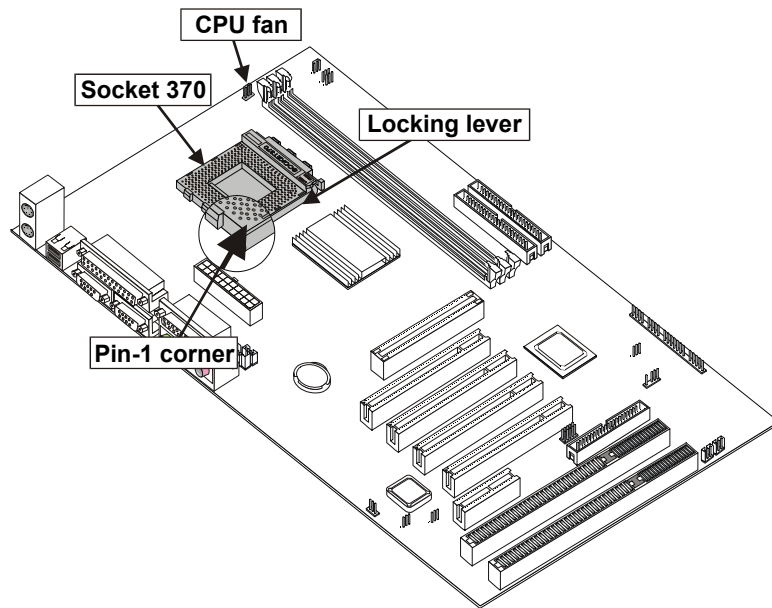

Follow these instructions to install the CPU:

1. Pull the CPU socket locking lever away from the socket to unhook it and raise the locking lever to the upright position.
2. Identify the pin A-1 corner on the CPU socket and the pin A-1 corner on the processor.
3. Match the pin A-1 corners and insert the processor into the socket. Do not use force.
4. Swing the locking lever down and hook it under the latch on the edge of the socket.
5. Plug the CPU fan power cable into the CPU cooling fan power supply on the mainboard (CPUFAN1).

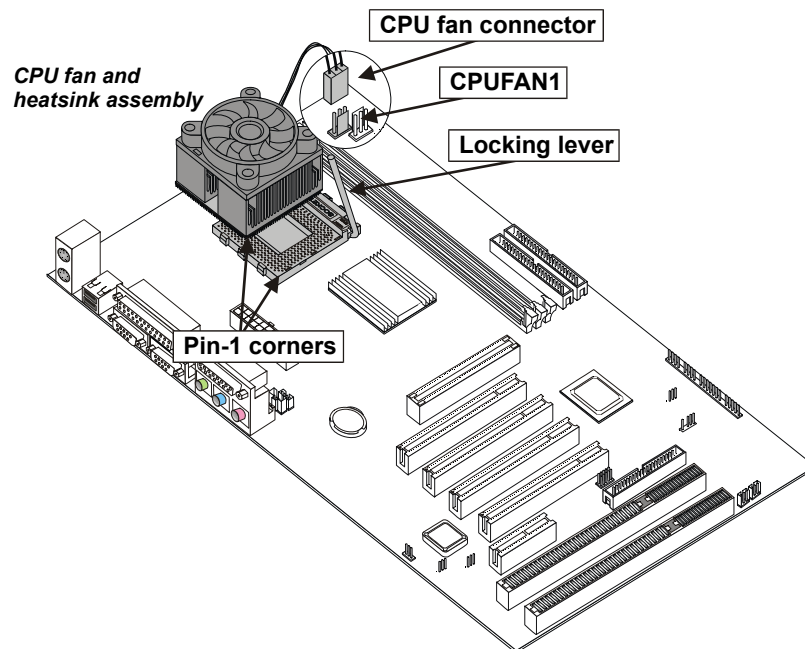

It is necessary now to configure your BIOS to accommodate your CPU. Refer to page 35 (BIOS Setup Utility – CPU & BIOS Features), for information on how to configure your mainboard for the appropriate clock speed and system bus for the CPU you have installed.

Install Memory Modules

For this mainboard, you must use 168-pin 3.3V non-buffered Dual In-line Memory Modules (DIMMs). The memory chips must be standard or registered SDRAM and VCM SDRAM memory chips.

The memory bus can run at 66 MHz, 100 MHz, or 133 MHz. If your processor operates over a 133 MHz system bus, you can install PC133 or PC100 memory that operates over a 133 or 100 MHz bus. If your processor operates over a 100 MHz system bus, you can install memory that operates over a 133MHz, 100 MHz or 66MHz bus. If your processor operates over a 66MHz, you can only install memory chips that operate at 66MHz or 100MHz.

Memory Configurations

The table below are supported memory configurations:

Technology (Mbit)	Configuration	# of Row Addr Bits	# of Col Addr Bits	# of Bank Addr Bits	Page Size (Kb)
64	8M x 8	12	8	2	4
64	4M x 16	12	9	2	2
128	32M x 4	12	11	2	16
128	16M x 8	12	10	2	8

Note: 32M x 4 128 Mbit is for registered DIMMs only, 4M x 16 64 Mbit support is for unbuffered DIMMs only.

The table below shows maximum memory for DIMMs.

DRAM Configurations		1 DIMM		2 DIMMs		3 DIMMs	
		SS (MB)	DS (MB)	SS (MB)	DS (MB)	SS (MB)	DS (MB)
64 Mbit	8M x 8	64	128	128	256	192	384
64 Mbit	4M x 16	32	64	64	128	96	192
128 Mbit	16M x 8	128	256	256	512	384	768
128 Mbit	32M x 4	256	512	512	1024	768	1536

SS = Single Sided

DS = Double Sided

Installation Procedure

The mainboard accommodates three memory modules. You must install at least one module in any of the three slots. Each module can be installed with 32 MB to 512 MB of memory; total memory capacity is 1.5 GB.

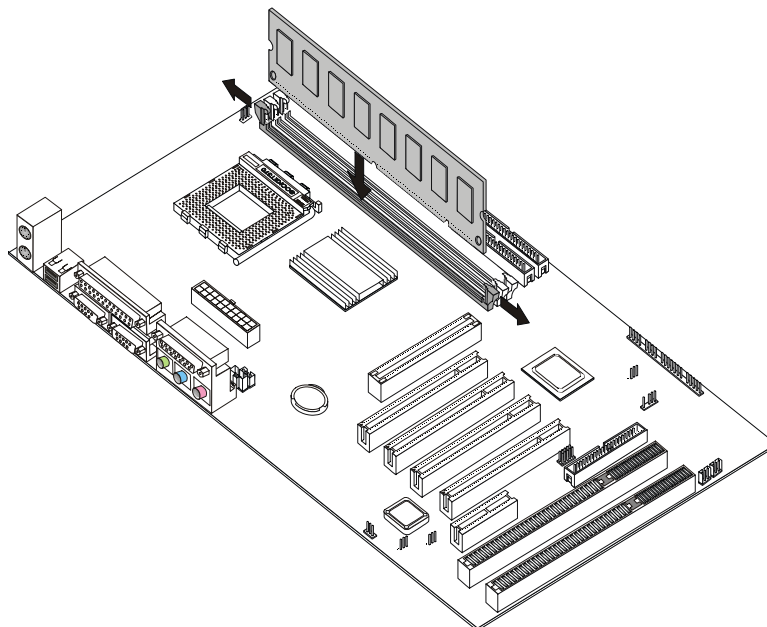

1. Align the memory module with the slot. The DIMM slots are keyed with notches and the DIMMs are keyed with cutouts so that they can only be installed correctly. Check that the cutouts on the DIMM module edge connector match the notches in the DIMM slot:

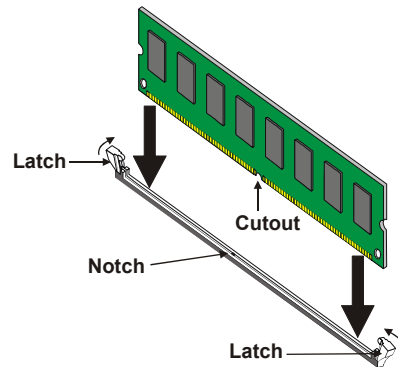

2. Push the latches on each side of the DIMM slot down.
3. Install the DIMM module into the slot and press it firmly down so that it seats correctly. The slot latches are levered upwards and latch on to the edges of the DIMM when it is installed correctly.

Installing a Hard Disk Drive/CD-ROM

This section describes how to install IDE devices such as a hard disk drive and a CD-ROM drive.

About IDE Devices

Your mainboard has a primary and secondary IDE channel interface (IDE1 and IDE2). An IDE ribbon cable supporting two IDE devices is bundled with the mainboard. IDE devices have jumpers or switches that are used to set the IDE device as MASTER or SLAVE. Refer to the IDE device user's manual.

If you want to install more than two IDE devices, get a second IDE cable and you can add two more devices to the secondary IDE channel.

When installing two IDE devices on one cable, ensure that one device is set to MASTER and the other device is set to SLAVE. The documentation of your IDE device explains how

to do this.

About UDMA

This mainboard supports Ultra DMA 66/100. UDMA is a technology that accelerates the performance of devices in the IDE channel. Install IDE devices that support UDMA and use IDE cables that support UDMA for better performance.

Installing a Hard Disk Drive

1. Install the hard disk drive into the drive cage in your ATX system case.
2. Plug the IDE cable into IDE1.

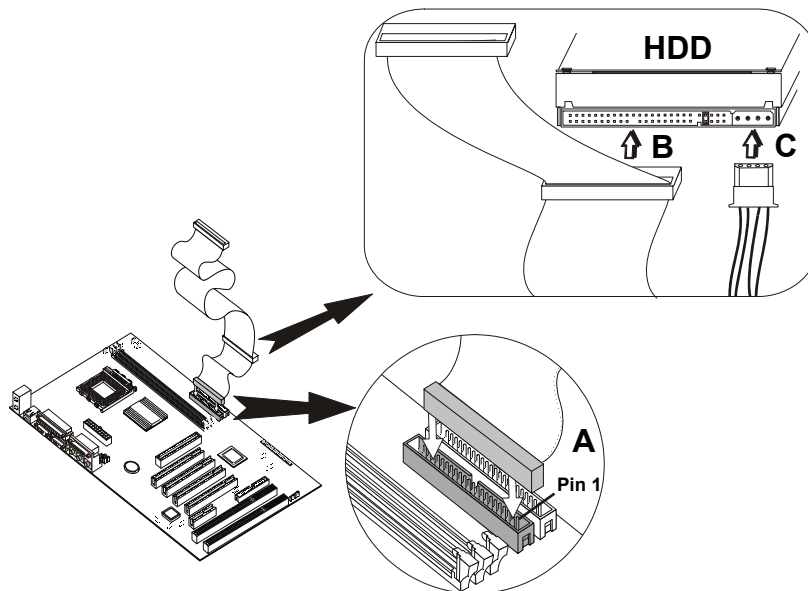

Note: Ribbon cable connectors are usually keyed so that they can only be installed correctly on the device connector. If the connector is not keyed, make sure that you match the pin-1 side of the cable connector with the pin-1 side of the device connector. Each connector has the pin-1 side clearly marked. The pin-1 side of each ribbon cable is always marked with a colored stripe on the cable.

3. Plug an IDE cable connector into the hard disk drive IDE connector. It doesn't matter which connector on the cable you use. Ensure that the pin-1 side of the cable is matched with the pin-1 side of the connector. Refer to the previous note.
4. Plug a power cable from the case power supply into the power connector on the hard disk drive.

When you first start up your system, the BIOS should automatically detect your hard disk drive. If it doesn't, enter the Setup Utility and use the IDE Hard Disk Auto Detect feature to configure the hard disk drive that you have installed. See Chapter 3 for more information.

Installing a CD-ROM/DVD Drive

1. Install the CD-ROM/DVD drive into the drive cage in your ATX system case.
2. Plug the IDE cable into IDE1. If you have already installed an HDD, you can use the free connector on its IDE cable.

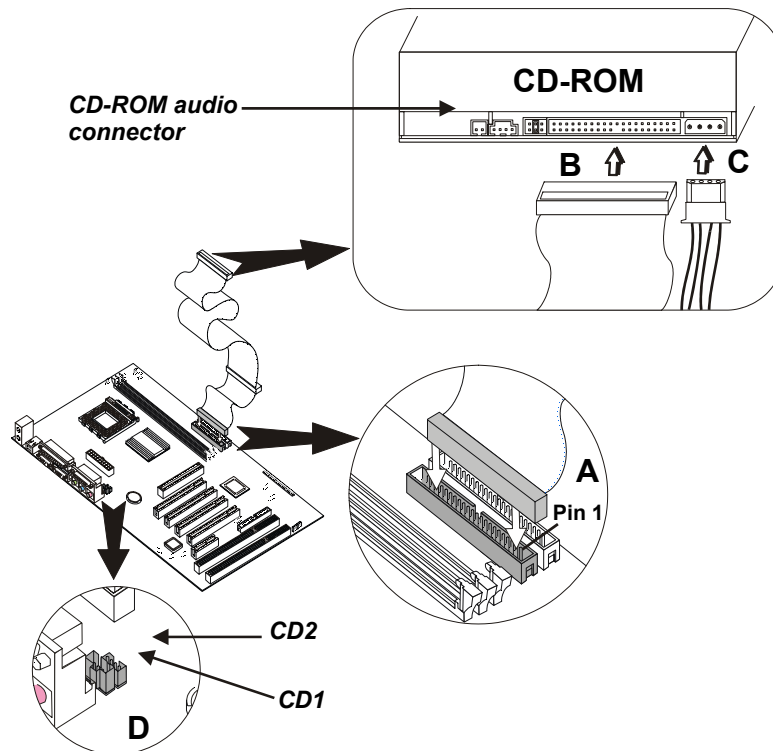

Note: Ribbon cable connectors are usually keyed so that they can only be installed correctly on the device connector. If the connector is not keyed, make sure that you match the pin-1 side of the cable connector with the pin-1 side of the device connector. Each connector has the pin-1 side clearly marked. The pin-1 side of each ribbon cable is always marked with a colored stripe on the cable.

3. Plug an IDE cable connector into the CD-ROM/DVD drive IDE connector. It doesn't matter which connector on the cable you use. Ensure that the pin-1 side of the cable is matched with the pin-1 side of the connector. Refer to the previous note.
4. Use the audio cable provided with the CD-ROM/DVD drive to connect to the mainboard CD-in connector CD1 or CD2.
5. Plug a power cable from the case power supply into the power connector on the CD-ROM/DVD drive.

When you first start up your system, the BIOS should automatically detect your CD-ROM/DVD drive. If it doesn't, enter the Setup Utility and configure the CD-ROM/DVD drive that you have installed. See Chapter 3 for more information.

Installing a Floppy Diskette Drive

The mainboard has a floppy diskette drive (FDD) interface ships with a diskette drive ribbon cable that supports one or two floppy diskette drives. You can install a 5.25-inch drive and a 3.5-inch drive with various capacities. The floppy diskette drive cable has one type of connector for a 5.25-inch drive and another type of connector for a 3.5-inch drive

1. Install the FDD into the drive cage in your ATX system case.
2. Plug the FDD cable into FDD1.

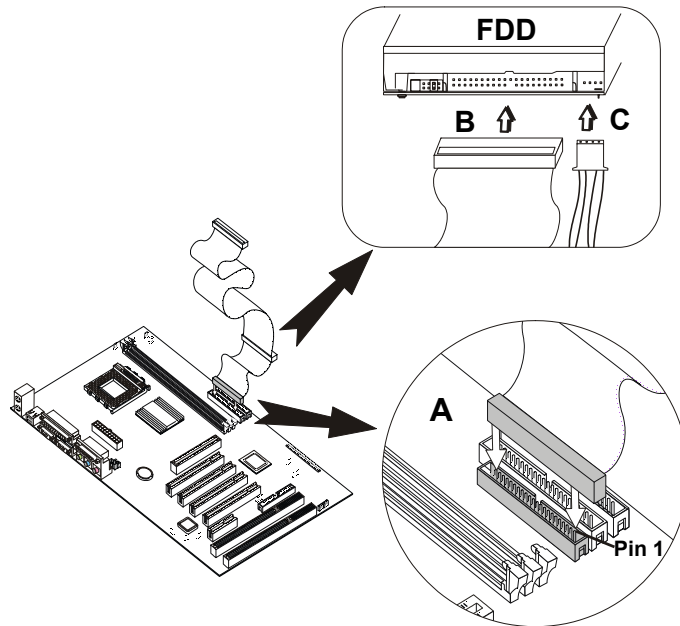

Note: Ribbon cable connectors are usually keyed so that they can only be installed correctly on the device connector. If the connector is not keyed, make sure that you match the pin-1 side of the cable connector with the pin-1 side of the device connector. Each connector has the pin-1 side clearly marked. The pin-1 side of each ribbon cable is always marked with a colored stripe on the cable.

3. Plug one of the connectors on the FDD cable into the FDD connector. It doesn't matter which connector on the cable you use. Ensure that the pin-1 side of the cable is matched with the pin-1 side of the connector. Refer to the previous note.
4. Plug a power cable from the case power supply into the power connector on the FDD.

When you first start up your system, go immediately to the Setup Utility and use the Standard page to configure the floppy diskette drives that you have installed. See Chapter 3 for more information.

Installing Add-on Cards

This mainboard has one 4xAGP slot, four PCI slots, two ISA slots and one AMR slot.

- | | |
|-------------------|--|
| 4xAGP Slot | The 4xAGP slot is used to install a graphics adapter that supports the 4xAGP specification and has a 4xAGP edge connector. |
| PCI Slots | PCI slots are used to install expansion cards that have the 32-bit PCI interface. |
| AMR | The Audio Modem Riser slot can be used to insert an AMR card. |
| ISA Slots | ISA slots are used to install ISA (Industry Standard Architecture) compliant expansion cards. |

Note: Before installing an add-on card, check the documentation for the card carefully. If the card is not Plug and Play, you may have to manually configure the card before installation.

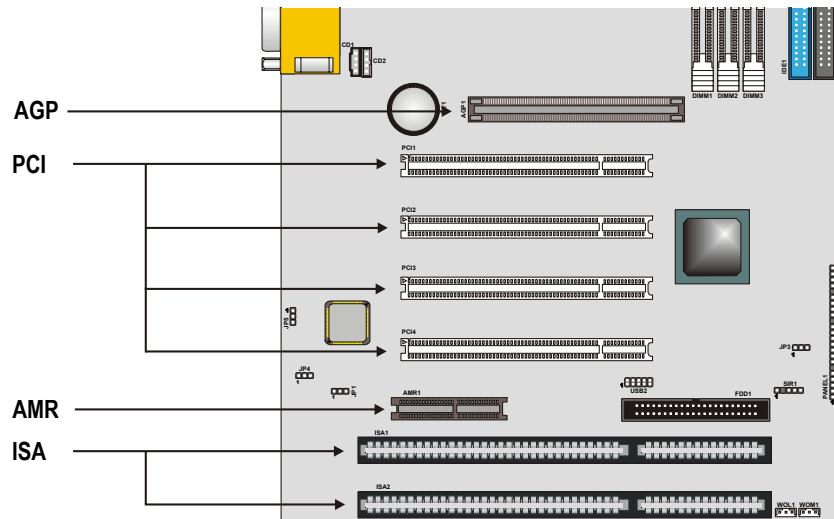

1. Remove a blanking plate from the system case corresponding to the slot you are going to use.
2. Install the edge connector of the add-on card into the expansion slot. Ensure that the edge connector is correctly seated in the slot.

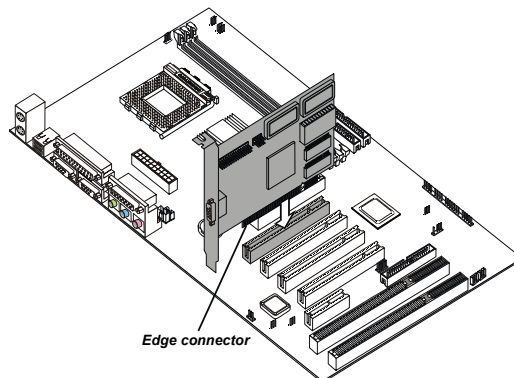

3. Secure the metal bracket of the card to the system case with a screw.

Note: For some add-on cards, for example graphics adapters and network adapters, you have to install drivers and software before you can begin using the add-on card.

Connecting Optional Devices

Refer to the following for information on connecting the main-board's optional devices:

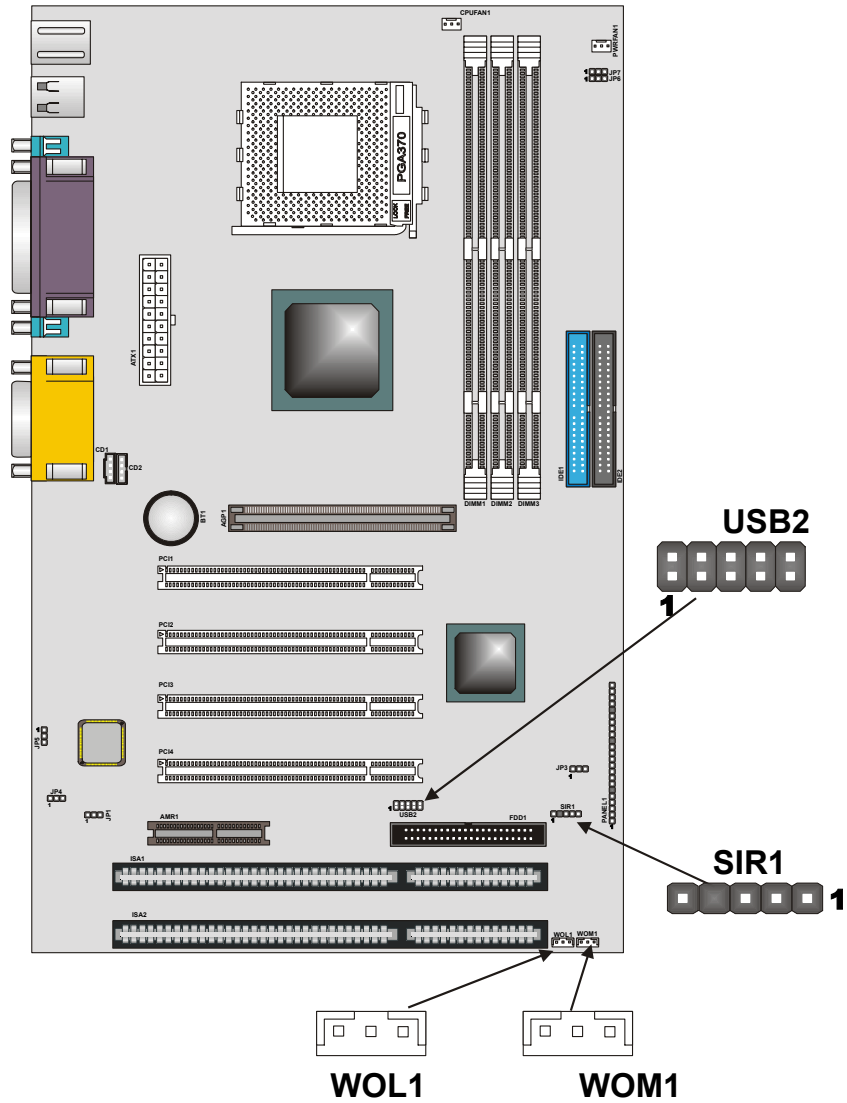

USB2: USB port

The mainboard has one USB port installed on the rear edge I/O port array. However, some computer cases have a special module that mounts USB ports at the front of the case. If you have this kind of case, use auxiliary USB connectors on USB2 to connect the front-mounted ports to the mainboard.

Pin	Signal Name	Pin	Signal Name
1	VREG_FP_USBPWR0	2	Ground
3	USB_FP_OC0	4	USB_FP_P1+
5	USB_FP_P0-	6	USB_FP_P1-
7	USB_FP_P0+	8	USB_FP_OC0
9	Ground	10	VREG_FP_USBPWR0

WOL1/WOM: Wake On LAN/Wake On Modem

If you have installed a LAN card, use the cable provided with the card to plug into the mainboard WOL1 connector. This enables the Wake On LAN (WOL) feature. When your system is in a power-saving mode, any LAN signal automatically resumes the system. You must enable this item using the Power Management page of the Setup Utility.

Pin	Signal Name
1	5VSB
2	Ground
3	SENSE

If you have installed a modem, use the cable provided with the modem to plug into the mainboard WOM1 connector. This enables the Wake On Modem (WOM) feature. When your system is in a power-saving mode, any modem signal automatically resumes the system. You must enable this item using the Power Management page of the Setup Utility. See page 39 (BIOS configurations) for more information.

SIR1: Serial infrared port

The mainboard supports a Serial Infrared (SIR) data port. Infrared ports allow the wireless exchange of information between your computer and similarly equipped devices such as printers, laptops, Personal Digital Assistants (PDAs), and other computers.

Pin	Signal Name
1	+5V
2	Key
3	IRRX
4	Ground
5	IRTX

Connecting I/O Devices

The backplane of the mainboard has a full set of I/O ports:

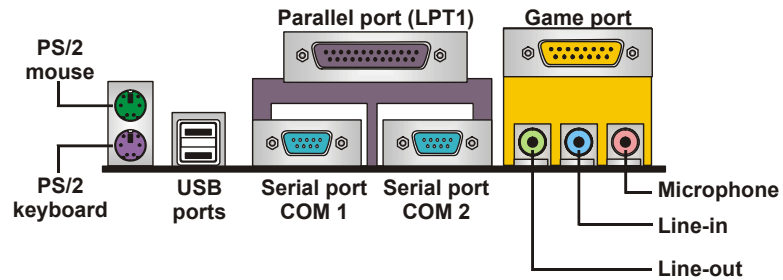

1. Use the upper PS/2 port to connect a PS/2 pointing device. Use the lower PS/2 port to connect a PS/2 keyboard.
2. Use the USB ports to connect USB devices.
3. Use LPT1 to connect printers or other parallel communications devices.
4. Use the COM ports to connect serial devices such as mice or fax/modems. COM1 is identified by the system as COM1/3. COM2 is identified by the system as COM2/4.
5. Use the game port to connect a joystick or a MIDI device.
6. Use the three audio ports to connect audio devices. The left side jack is for a stereo line-out signal. The middle jack is for a stereo line-in signal. The right side jack is for a microphone.

External Connector Color Coding

Many connectors now use standard colors as shown in the table below.

Connector	Color
Analog VGA	Blue
Audio line-in	Light blue
Audio line-out	Lime
Digital monitor / flat panel	White
IEEE 1394	Grey
Microphone	Pink
MIDI/Game	Gold
Parallel	Burgundy
PS/2 compatible keyboard	Purple
PS/2 compatible mouse	Green
Serial	Teal or Turquoise
Speaker out/subwoofer	Orange
Right-to-left speaker	Brown
USB	Black
Video out	Yellow
SCSI, network, telephone, modem	None

This concludes Chapter 2. Chapter 3 covers the BIOS.

Chapter 3

Using BIOS

About the Setup Utility

The computer employs the latest Award BIOS CMOS chip with support for Windows Plug and Play. This CMOS chip contains the ROM setup instructions for configuring the mainboard's BIOS. The BIOS (Basic Input and Output System) Setup Utility is a ROM-based configuration utility that displays the system's configuration status and provides you with a tool to set system parameters. These parameters are stored in non-volatile battery-backed-up CMOS RAM that saves this information even when the power is turned off. When the system is turned back on, the system is configured with the values found in CMOS.

Using easy-to-use pull down menus, you can configure such items as:

- Hard drives, diskette drives, and peripherals
- Video display type and display options
- Password protection from unauthorized use
- Power management features

The settings made in the Setup Utility intimately affect how the computer performs. It is important, therefore, first to try to understand all the Setup Utility's options, and second, to make settings appropriate for the way you use the computer. This chapter guides you through the Setup Utility by providing clear explanations for all Setup Utility options.

The Standard Configuration

A standard configuration has already been set in the Setup Utility. However, we recommend that you read this chapter in case you need to make any changes in the future.

This program should be executed under the following conditions:

- When changing the system configuration
- When a configuration error is detected by the system and you are prompted to make changes to the Setup Utility
- When resetting the system clock
- When redefining the communication ports to prevent any conflicts
- When making changes to the Power Management configuration
- When changing the password or making other changes to the security setup.

Normally, running the Setup Utility is needed when the system hardware is not consistent with the information contained in the CMOS RAM, whenever the CMOS RAM has lost power, or the system features need to be changed.

Updating the BIOS

You can download and install updated BIOS for this mainboard from the manufacturer's web site. New BIOS provides support for new peripherals, improvements in performance, or fixes for known bugs. Install new BIOS as follows:

1. If your mainboard has a BIOS protection jumper, change the setting to allow BIOS flashing. Refer to Appendix A for jumper settings.
2. If your mainboard has an item called Firmware Write Protect in Advanced BIOS features, disable it. Firmware Write Protect prevents BIOS from being overwritten.
3. Create a bootable system disk. Refer to Windows online help for information on creating a bootable system disk.
4. Download the Flash Utility and new BIOS file from the manufacturer's Web site. Copy these files to the system diskette you created in Step 3.
5. Turn off your computer and insert the system diskette in your computer's diskette drive. You might need to run the Setup Utility and change the boot priority items on the Advanced BIOS Features Setup page, to force your computer to boot from the floppy diskette drive first.
6. At the A:\ prompt, type the Flash Utility program name and press <Enter>. You see a screen similar to the following:

FLASH MEMORY WRITER V7.33	
(C) Award Software 1999 All Rights Reserved	
For (MAINBOARD NAME)	DATE: 10/26/2000
Flash Type	
File Name to Program :	<input type="text"/>
Error Message	

7. Type the filename of the new BIOS in the "File Name to Program" text box. Follow the onscreen directions to update the mainboard BIOS.
8. When the installation is complete, remove the floppy diskette from the diskette drive and restart your computer. If your mainboard has a Flash BIOS jumper, reset the jumper to protect the newly installed BIOS from being overwritten.

Using BIOS

When you start the Setup Utility, the main menu appears. The main menu of the Setup Utility displays a list of the options that are available. A highlight indicates which option is currently selected. Use the cursor arrow keys to move the highlight to other options. When an option is highlighted, execute the option by pressing <Enter>.

Some options lead to pop-up dialog boxes that prompt you to verify that you wish to execute that option. Other options lead to dialog boxes that prompt you for further information.

Some options (marked with a triangle ►) lead to submenus that enable you to change the values for the option. Use the cursor arrow keys to scroll through the items in the submenu.

In this manual, default values are enclosed in parenthesis. Submenu items are denoted by a triangle ►.

Standard CMOS Features

This option displays a table of items defining basic information about your system.

CMOS Setup Utility – Copyright (C) 1984 – 2001 Award Software
Standard CMOS Features

Date (mm:dd:yy)	Tue, Feb 15 2000	Item Help
Time (hh:mm:ss)	12 : 8 : 59	
► IDE Primary Master	Press Enter None	Menu Level ►
► IDE Primary Slave	Press Enter None	
► IDE Secondary Master	Press Enter None	Change the day, month, year and century.
► IDE Secondary Slave	Press Enter None	
Drive A	1.44M, 3.5 in.	
Drive B	None	
Floppy 3 mode Support	Disabled	
Video	EGA/VGA	
Halt On	All Errors	
Base Memory	640K	
Extended Memory	63488	
Total Memory	64512K	

↑↓ : Move Enter : Select +/-/PU/PD:Value: F10: Save ESC: Exit F1:General Help
F59:Previous Values F6:Fail-Safe Defaults F7:Optimized Defaults

Date and Time

The Date and Time items show the current date and time held by your computer. If you are running a Windows OS, these items are automatically updated whenever you make changes to the Windows Date and Time Properties utility.

► IDE Devices (None)

Your computer has two IDE channels (Primary and Secondary) and each channel can be installed with one or two devices (Master and Slave). Use these items to configure each device on the IDE channel. Press <Enter> to display the IDE sub-menu:

Press <Enter> to display the IDE submenu:

CMOS Setup Utility – Copyright © 1984 – 2000 Award Software
IDE Primary Master

IDE HDD Auto-Detection	Press Enter	Item Help
IDE Primary Master Access Mode	Auto	Menu Level ►► To auto-detect the HDD's size, head . . . on this channel
Capacity	8448 MB	
Cylinder	16368	
Head	16	
Precomp	0	
Landing Zone	16367	
Sector	63	

↑↓→← : Move Enter : Select +/-/PU/PD:Value: F10: Save ESC: Exit F1:General Help
F5:Previous Values F6:Fail-Safe Defaults F7:Optimized Defaults

IDE HDD Auto-Detection

Press <Enter> while this item is highlighted if you want the Setup Utility to automatically detect and configure a hard disk drive on the IDE channel.

Note: If you are setting up a new hard disk drive that supports LBA mode, more than one line will appear in the parameter box. Choose the line that lists LBA for an LBA drive.

IDE Primary/Secondary Master/Slave (Auto)

If you leave this item at Auto, the system will automatically detect and configure any IDE devices it finds. If it fails to find a hard disk, change the value to Manual and then manually configure the drive by entering the characteristics of the drive in the items below (Capacity, Cylinder, Head, Precomp, etc.) Re-

fer to your drive's documentation or look on the drive if you need to obtain this information. If no device is installed, change the value to None.

Note: Before attempting to configure a hard disk drive, ensure that you have the configuration information supplied by the manufacturer of your hard drive. Incorrect settings can result in your system not recognizing the installed hard disk.

Access Mode

This item defines some special ways that can be used to access IDE hard disks such as LBA (Large Block Addressing). Leave this value at Auto and the system will automatically decide the fastest way to access the hard disk drive.

Press <Esc> to close the IDE device sub-menu and return to the Standard CMOS Features page.

Drive A/Drive B (1.44M, 3.5 in./None)

These items define the characteristics of any diskette drive attached to the system. You can connect one or two diskette drives.

Floppy 3 Mode Support (Disabled)

Floppy 3 mode refers to a 3.5-inch diskette with a capacity of 1.2 MB. Floppy 3 mode is sometimes used in Japan.

Video (EGA/VGA)

This item defines the video mode of the system. This motherboard has a built-in VGA graphics system; you must leave this item at the default value.

Halt On (All, Error)

This item defines the operation of the system POST (Power On Self Test) routine. You can use this item to select which types of errors in the POST are sufficient to halt the system.



















Base Memory, Extended Memory, and Total Memory

These items are automatically detected by the system at start up time. These are display-only fields. You cannot make changes to these fields

Advanced BIOS Setup Option

This option displays a table of items that define advanced information about your system.

CMOS Setup Utility – Copyright (C) 1984 – 2001 Award Software
Advanced BIOS Features

Anti-Virus Protection	Disabled		Item Help																	
Y2K Monitor	Disabled			Menu Level ▶																
CPU Internal Cache	Enabled				Allows you to choose the VIRUS warning feature for IDE Hard Disk boot sector protection. If this function is enabled and someone attempts to write data into this area, BIOS will show a warning message on screen and alarm beep															
External Cache	Enabled																			
CPU L2 Cache ECC Checking	Enabled																			
Processor Number Feature	Enabled																			
Quick Power On Self Test	Enabled																			
First Boot Device	Floppy																			
Second Boot Device	HDD-0																			
Third Boot Device	LS120																			
Boot Other Device	Enabled																			
Swap Floppy Drive	Disabled																			
Boot Up Floppy Seek	Enabled																			
Boot Up NumLock Status	On																			
Gate A20 Option	Normal																			
Typematic Rate Setting	Disabled																			
x Typematic Rate (Chars/Sec)	6																			
x Typematic Delay (Msec)	250																			
																				

↑↓ → ← : Move Enter : Select +/-/PU/PD:Value: F10: Save ESC: Exit F1:General Help
F5:Previous Values F6:Fail-Safe Defaults F7:Optimized Defaults

Anti-Virus Protection (Disabled)

When this item is enabled, it provides some protection against viruses that try to write to the boot sector and partition table of your hard disk drive. This item is Disabled by default. You need to disable it so that you can install an operating system. We recommend that you enable virus warning protection as soon as you have installed your disk with an OS.

Y2K Monitor (Disabled)

If you enable this item, the system will monitor for errors generated by the year 2000 bug.

CPU Internal Cache (Enabled)

All the processors that can be installed in this mainboard use internal level 1 (L1) cache memory to improve performance. Leave this item at the default value for better performance.

External Cache (Enabled)

Most processors that can be installed in this system use external level 2 (L2) cache memory to improve performance.

CPU L2 Cache ECC Checking (Enabled)

This item enables or disables ECC (Error Correction Code) error checking on the CPU cache memory. We recommend that you leave this item at the default value.

Processor Number Feature (Enabled)

Some new processors are installed with a unique processor number. This number may be used for verification in Internet transactions and e-commerce. If you prefer not to use or distribute the unique processor number, set this item to Disabled to suppress the processor number.

Quick Power On Self Test (Enabled)

You can enable this item to shorten the power on testing (POST) and have your system start up a little faster. You might like to enable this item after you are confident that your system hardware is operating smoothly.

1st/2nd/3rd Boot Device (Floppy/HDD-0/LS120)

Use these three items to select the priority and order of the devices that your system searches for an operating system at start-up time.

Boot Other Device (Enabled)

If you enable this item, the system will search all other possible locations for an operating system if it fails to find one in the devices specified under the first, second and third boot devices.

Swap Floppy Drive (Disabled)

If you have two floppy diskette drives in your system, this item allows you to swap the assigned drive letters so that drive A becomes drive B, and drive B becomes drive A.

Boot Up Floppy Seek (Enabled)

If this item is enabled, it checks the geometry of the floppy disk drives at start-up time. You don't need to enable this item unless you have a legacy diskette drive with 360K capacity.

Boot Up NumLock Status (On)

This item defines if the keyboard Num Lock key is active when your system is started.

Gate A20 Option (Normal)

This item defines how the system handles legacy software that was written for an earlier generation of processors. Leave this item at the default value.

Typematic Rate Setting (Disabled)

If this item is enabled, you can use the following two items to set the typematic rate and the typematic delay settings for your keyboard.

Typematic Rate (Chars/Sec) (6)

If Typematic Rate Setting is enabled, you can use this item to define how many characters per second are generated by a held-down key.

Typematic Delay (Msec) (250)

If Typematic Rate Setting is enabled, you can use this item to define how many milliseconds must elapse before a held-down key begins generating repeat characters.

Security Option (Setup)

If you have installed password protection, this item defines if the password is required at system start up, or if it is only required when a user tries to enter the Setup Utility.

OS Select For DRAM > 64 MB (Non-OS2)

This item is only required if you have installed more than 64 MB of memory and you are running the OS/2 operating system. Otherwise, leave this item at the default Non-OS2.

HDD S.M.A.R.T Capability (Disabled)

The S.M.A.R.T. (Self-Monitoring, Analysis, and Reporting

Technology) system is a diagnostics technology that monitors and predicts device performance. S.M.A.R.T. software resides on both the disk drive and the host computer. The disk drive software monitors the internal performance of the motors, media, heads, and electronics of the drive. The host software monitors the overall reliability status of the drive. If a device failure is predicted, the host software, through the Client WORKS S.M.A.R.T applet, warns the user of the impending condition and advises appropriate action to protect the data.

Report No FDD For WIN95 (Yes)

If you are running a system with no floppy drive and using Windows 95, select Yes for this item to ensure compatibility with the Windows 95 logo certification. Otherwise, select No.

Video BIOS Shadow (Enabled)

When enabled, copies the VGA BIOS into system DRAM for better performance.

C8000-CBFFF~DC000-DFFF Shadow (Disabled)

These categories determine whether option ROMs will be copied to RAM. An example of such option ROM would be support of on-board SCSI. The default value for each item is Disabled.

Advanced Chipset Features Option

This option displays a table of items that define critical timing parameters of the mainboard. You should leave the items on this page at their default values unless you are very familiar with the technical specifications of your system hardware. If you change the values incorrectly, you may introduce fatal errors or recurring instability into your system.

CMOS Setup Utility – Copyright (C) 1984 – 2000 Award Software
Advanced Chipset Features

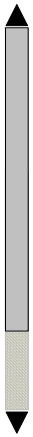
Bank 0/1 DRAM Timing	SDRAM 8/10ns		Item Help
Bank 2/3 DRAM Timing	SDRAM 8/10ns		Menu Level ▶
Bank 4/5 DRAM Timing	SDRAM 8/10ns		
SDRAM Cycle Length	3		
DRAM Clock	Host CLK		
Memory Hole	Disabled		
P2C/C2P Concurrency	Enabled		
Fast R-W Turn Around	Disabled		
System BIOS Cacheable	Enabled		
Video RAM Cacheable	Enabled		
AGP Aperture Size	64M		
AGP-4X Mode	Enabled		
AGP Driving Control	Auto		
x AGP Driving Value	DA		
AGP Fast Write	Disabled		
OnChip USB	Enabled		
USB Keyboard Support	Disabled		
OnChip Sound	Auto		

↑ ↓ → ← : Move Enter : Select +/-/PU/PD:Value: F10: Save ESC: Exit F1:General Help
 F5:Previous Values F6:Fail-Safe Defaults F7:Optimized Defaults

Bank 0/1 2/3 4/5 DRAM Timing (8/10 ns)

The DRAM timing is controlled by the DRAM Timing Registers. The timings programmed into this register are dependent on the system design. Slower rates may be required in certain system designs to support loose layouts or slower memory.

SDRAM Cycle Length (3)

This item sets the timing and wait states for SDRAM memory. We recommend that you leave this item at the default value.

DRAM Clock (Host CLK)

This item sets the DRAM Clock. We recommend that you leave this item at the default value.

Memory Hole (Disabled)

This item can be used to reserve memory space for some ISA expansion cards that require it.

P2C/C2P Concurrency (Enabled)

When disabled, the CPU bus is occupied during the entire PCI operation period.

Fast R-W Turn Around (Disabled)

When this is enabled, the chipset will insert one extra clock to the turn-around of back-to-back DRAM cycles.

System BIOS Cacheable (Enabled) & Video RAM Cacheable (Enabled)

These items allow the video and/or system to be cached in memory for faster execution. We recommend that you leave these items at the default value.

AGP Aperture Size Default (64 MB)

This item defines the size of the aperture if you use an AGP graphics adapter. It refers to a section of the PCI memory address range used for graphics memory. We recommend that you leave this item at the default value.

AGP-4X Mode (Enabled)

This item allows you to enable or disable the caching of display data for the video memory of the processor. Enabling AGP-4X Mode can greatly improve the display speed. If your graphics display card does not support this feature, you need to disable this item.

AGP Driving Control (Auto)

This item can be used to signal driving current on AGP cards to auto or Manual. Some AGP cards need stronger than normal driving current in order to operate. We recommend that you set this item to Auto by default.

AGP Driving Value (DA)

When the previous item AGP Driving Control is set to Manual, you can use this item to set the AGP current driving value.

AGP Fast Write (Disabled)

This item allows you to enable or disable the caching of display data for the video memory of the processor. Enabling can greatly improve the display speed. If your graphics display card does not support this feature, you need to disable this item

OnChip USB (Enabled)

This should be enabled if your system has a USB installed on the system board and you wish to use it.

USB Keyboard Support (Disabled)

Enable this item if you plan to use a keyboard connected through the USB port in a legacy operating system (such as DOS) that does not support Plug and Play.

OnChip Sound (Auto)

When set to Disabled, the onboard audio chip is turned off.

CPU to PCI Write Buffer (Enabled)

When enabled, up to four words of data can be written to the PCI bus without interrupting the CPU. When disabled, a write buffer is not used and the CPU read cycle will not be completed until the PCI bus signals that it is ready to receive the data. The default setting is Enabled.

PCI Dynamic Bursting (Enabled)

When set to Enabled, every write transaction goes to the write buffer. Burstable transactions then “burst” on the PCI bus and nonburstable transaction do not.

PCI Master 0 WS Write (Enabled)

When set to Enabled, writes to the PCI bus are executed with zero wait states.

PCI Delay Transaction (Enabled)

The chipset has an embedded 32-bit posted write buffer to support delay transactions cycles. Select Enabled to support compliance with PCI specification version 2.1.

PCI#2 Access #1 Retry (Enabled)

When set to Enabled, the AGP Bus (PCI#2) access to PCI

Bus (PCI#1) is executed with the error retry feature.

AGP Master 1 WS Write (Disabled)

This implements a single delay when writing to the AGP Bus. By default, two-wait states are used by the system, allowing for greater stability.

AGP Master 1 WS Read (Disabled)

This implements a single delay when reading to the AGP Bus. By default, two-wait states are used by the system, allowing for greater stability.

Memory Parity/ECC Check (Disabled)

Enable this item to allow BIOS to perform a parity check to the POST memory tests. Select Enabled only if the system DRAM supports parity checking.

IDE Primary/Secondary Master/Slave UDMA (Auto)

Each IDE channel supports a master device and a slave device. This mainboard supports UltraDMA. UltraDMA technology provides faster access to IDE devices.

If you install a device that supports UltraDMA, change the appropriate item on this list to Auto. You may have to install the UltraDMA driver supplied with this mainboard in order to use an UltraDMA device.

Init Display First (PCI Slot)

Use this item to define if your graphics adapter is installed in one of the PCI slots or select Onboard if you have a graphics system integrated on the mainboard.

IDE HDD Block Mode (Enabled)

Enable this field if your IDE hard drive supports block mode. Block mode enables BIOS to automatically detect the optimal number of block read and writes per sector that the drive can support and can improve the speed of access to IDE devices.

Onboard FDD Controller (Enabled)

This option enables the onboard floppy disk drive controller.

Onboard Serial Port 1/Serial Port 2 (Auto)

These options are used to assign the I/O addresses for the two onboard serial ports.

UART 2 Mode (Standard)

This field is available if the Onboard Serial Port 2 field is set to any option but Disabled. UART Mode Select enables you to select the infrared communication protocol—Standard (default), HPSIR or ASKIR. HPSIR is Hewlett Packard's infrared communication protocol with a maximum baud rate up to 115.2K bps. ASKIR is Sharp's infrared communication protocol with a maximum baud rate up to 57.6K bps.

The UART mode setting depends on which type of infrared module is used in the system. When set to ASKIR or HPSIR, the UART 2 is used to support the infrared module connected on the mainboard. If this option is not set to Standard, a device connected to the COM2 port will no longer work.

IR Function Duplex (Half)

This field is available when UART 2 Mode is set to either ASKIR or HPSIR. This item enables you to determine the infrared (IR) function of the onboard infrared chip. The options are Full and Half (default).

Full-duplex means that you can transmit and send information simultaneously. Half-duplex is the transmission of data in both directions, but only one direction at a time.

TX,RX inverting enable (No, Yes)

Defines the voltage level for Infrared module RxD (receive) mode and TxD (transmit) mode. This setting has to match the requirements of the infrared module used in the system.

Onboard Parallel Port (378/IRQ7)

This option is used to assign the I/O address for the onboard parallel port.

Onboard Parallel Port Mode (ECP)

Enables you to set the data transfer protocol for your parallel port. There are four options: Normal (Standard Parallel Port), EPP (Enhanced Parallel Port), ECP (Extended Capabilities Port) and ECP+EPP.

Normal allows data output only. Extended Capabilities Port (ECP) and Enhanced Parallel Port (EPP) are bi-directional modes, allowing both data input and output. ECP and EPP modes are only supported with EPP and ECP aware peripherals.

ECP Mode Use DMA (3)

When the onboard parallel port is set to ECP mode, the parallel port has the option to use DMA 3 (default) or DMA 1.

Parallel Port EPP Type (EPP1.7)

Sets the EPP specification. There are two options, EPP1.9 and EPP1.7.

If you make any changes to the onboard FDD controller, serial ports or parallel ports in this setup, save the changes and turn off the system. After powering up the system, ensure that the changes have taken effect.

Onboard Legacy Audio (Enable)

Enables the onboard legacy audio function. If this item is enabled the following items become available.

Sound Blaster (Disabled)

Enables or disables Sound Blaster function.

SB I/O Base Address (220H)

This item lets you set the I/O base address for the Sound Blaster card.

SB IRQ Select (IRQ 5)

This item lets you set the Interrupt Request (IRQ) for the Sound Blaster card.

SB DMA Select (DMA 1)

This item lets you select the DMA for the Sound Blaster card.

MPU-401 (Enabled)

Use this item to enable or disable the MPU-401 (MIDI) function for the game port. The default is Disabled.

MPU-401 I/O Address (330-333H)

Use this item to set the I/O address for the MPU-401 (MIDI) function.

Game Port (200-207H) (Enabled)

This item sets the I/O address for the game port.

Power Management Setup Option

This option displays items that let you control the system power management. Modern operating systems take care of much of the power management. This mainboard supports ACPI (Advanced Configuration and Power Interface). The system has various power saving modes including powering down the hard disk, turning off the video, suspending to RAM, and a software power down that allows the system to be automatically resumed by certain events.

Power Management Timeouts

The power-saving modes can be controlled by timeouts. If the system is inactive for a time, the timeouts begin counting. If the inactivity continues so that the timeout period elapses, the system enters a power-saving mode. If any item in the list of Reload Global Timer Events is Enabled, then any activity on that item will reset the timeout counters to zero.

Wake Up Calls

If the system is suspended, or has been powered down by software, it can be resumed by a wake up call that is generated by incoming traffic to a modem, a LAN card, a PCI card, or a fixed alarm on the system realtime clock.

CMOS Setup Utility – Copyright (C) 1984 – 2000 Award Software
Power Management Setup

ACPI Function	<u>Enabled</u>	Item Help
▶ Power Management	Press Enter	
PM Control by APM	Yes	
Video Off Option	Suspend --> Off	Menu Level ▶
Video Off Method	DPMS Support	
MODEM Use IRQ	3	
Soft-Off by PWRBTN	Instant-Off	
Keyboard Power On	Disabled	
▶ Wake Up Events	Press Enter	

↑ ↓ → ← : Move Enter : Select +/-/PU/PD:Value: F10: Save ESC: Exit F1:General Help
F5:Previous Values F6:Fail-Safe Defaults F7:Optimized Defaults

ACPI Function (Enabled)

This mainboard supports ACPI (Advanced Configuration and Power management Interface). Use this item to enable or disable the ACPI feature.

Note: ACPI is a power management specification that makes hardware status information available to the operating system. ACPI enables a PC to turn its peripherals on and off for improved power management. It also allows the PC to be turned on and off by external devices, so that mouse or keyboard activity wakes up the computer.

Power Management Option (User Define)

This item enables you to choose the type of Power Management you want. Selecting Power Management and pressing Enter displays the following screen:

CMOS Setup Utility – Copyright (C) 1984 – 2001 Award Software
Power Management

Power Management	User Define	Item Help
HDD Power Down	Disabled	Menu Level ▶
Doze Mode	Disabled	
Suspend Mode	Disabled	

↑↓→←: Move Enter : Select +/-/PU/PD:Value: F10: Save ESC: Exit F1:General
Help F5:Previous Values F6:Fail-Safe Defaults F7:Optimized Defaults

This menu enables you to set the following items:

Power Management (User Define)

This item acts like a master switch for the power-saving modes and hard disk timeouts. If this item is set to Max Saving, power-saving modes occur after a short timeout. If this item is set to Min Saving, power-saving modes occur after a longer timeout. If the item is set to User Define, you can insert your own timeouts for the power-saving modes.

HDD Power Down (Disable)

The IDE hard drive will spin down if it is not accessed within a specified length of time. Options are from 1 Min to 15 Min and Disable.

Doze Mode (Disabled)

The system speed will change from turbo to slow if no Power Management events occur for a specified length of time. Full power function will return when a Power Management event is detected.

Suspend Mode (Disable)

The CPU clock will be stopped and the video signal will be suspended if no Power Management events occur for a specified length of time. Full power function will return when a Power Management event is detected. Options are from 1 Min to 1 Hour and Disable.

PM Control by APM (Yes)

This field allows you to control the PC Monitor's power management features via Intel-Microsoft Advanced Power Management software. Once you have enabled the APM interface, some settings made in the BIOS Setup program may be overridden by APM.

Video Off Option (Suspend --> Off)

This option defines if the video is powered down when the system is put into suspend mode.

Video Off Method (DPMS Support)

This item defines how the video is powered down to save power. This item is set to DPMS (Display Power Management Software) by default.

MODEM Use IRQ (3)

If you want an incoming call on a modem to automatically resume the system from a power-saving mode, use this item to specify the interrupt request line (IRQ) that is used by the modem. You might have to connect the fax/modem to the mainboard Wake On Modem connector for this feature to work.

Soft-Off by PWRBTN (Instant-Off)

Under ACPI (Advanced Configuration and Power management Interface) you can create a software power down. In a software power down, the system can be resumed by Wake Up Alarms. This item lets you install a software power down that is controlled by the normal power button on your system. If the item is set to Instant-Off, then the power button causes a software power down. If the item is set to Delay 4 Sec. then you have to hold the power button down for four seconds to cause a software power down.

Keyboard Power On (Disabled)

Enable this item to allow the system to be resumed from a software powerdown or a power-saving mode by a keystroke on the keyboard.

► Wake Up Events

This item opens a submenu that enables you to set events that will resume the system from a power saving mode. Select Wake Up Events and press Enter to display the following menu:

CMOS Setup Utility – Copyright (C) 1984 – 2000 Award Software
Wake Up Events

VGA	OFF	Item Help
LPT & COM	LPT/COM	
HDD & FDD	ON	Menu Level ►►
PCI Master	OFF	
PowerOn by PCI Card	Enabled	
Wake Up On LAN/Ring	Disabled	
RTC Alarm Resume	Disabled	
x Date (of Month)	0	
x Resume Time (hh:mm:ss)	0 0 0	
Primary INTR	ON	
► IRQs Activity Monitoring	Press Enter	

↑↓ →← : Move Enter : Select +/-/PU/PD:Value: F10: Save ESC: Exit F1:General Help
F5:Previous Values F6:Fail-Safe Defaults F7:Optimized Defaults

VGA (Off)

When set to On, the system power will resume the system from a power saving mode if there is any VGA activity. The default value is Off.

LPT & COM (LPT/COM)

When this item is enabled, the system will restart the power-saving timeout counters when any activity is detected on the serial ports, or the parallel port.

HDD & FDD (On)

When this item is enabled, the system will restart the power-saving timeout counters when any activity is detected on the hard disk drive or the floppy diskette drive.

PCI Master (Off)

When set to Off any PCI device with Master function will not power on the system.

PowerOn by PCI Card (Disabled)

Use this item to enable PCI activity to wakeup the system from a power saving mode.

Wake Up On LAN/Ring (Disabled)

Use this item to enable LAN or modem activity to wakeup the system from a power saving mode.

RTC Alarm Resume (Disabled)

When set to Enabled, the following two fields become available and you can set the date (day of the month), hour, minute and second to turn on your system. When set to 0 (zero) for the day of the month, the alarm will power on your system every day at the specified time.

Primary INTR (On)

Set Primary INTR to ON to allow you to enable or disable IRQ 3 through IRQ 15 activity monitoring. Set it to OFF to disable IRQ activity monitoring.

► IRQ/Event Activity Detect

Scroll to this item and press <Enter> to view the following screen:

CMOS Setup Utility – Copyright (C) 1984 – 2000 Award Software
IRQ/ Activity Detect

IRQ 3	(COM2)	Enabled	Item Help
IRQ 4	(COM1)	Enabled	
IRQ 5	(LPT2)	Enabled	
IRQ 6	(Floppy Disk)	Enabled	Menu Level ►►
IRQ 8	(LPT1)	Enabled	
IRQ 7	(RTC Alarm)	Disabled	
IRQ 9	(IRQ2* Redir)	Disabled	
IRQ 10	(Reserved)	Disabled	
IRQ 11	(Reserved)	Disabled	
IRQ 12	(PS/2 Mouse)	Enabled	
IRQ 13	(Coprocessor)	Disabled	
IRQ 14	(Hard Disk)	Enabled	
IRQ 15	(Reserved)	Disabled	

↑↓→← : Move Enter : Select +/-/PU/PD:Value: F10: Save ESC: Exit F1:General Help
F5:Previous Values F6:Fail-Safe Defaults F7:Optimized Defaults

This screen enables you to set IRQs that will reestablish the system from a power saving sleep state.

Set any IRQ to Enabled to allow activity at the IRQ to wake up the system from a power saving mode.

PNP/PCI Configuration Option

This option displays a table of items that configures how PnP (Plug and Play) and PCI expansion cards operate in your system. Both the ISA and PCI buses on the Mainboard use system IRQs (Interrupt ReQuests) and DMAs (Direct Memory Access). You must set up the IRQ and DMA assignments correctly through the PnP/PCI Configurations Setup utility; otherwise, the mainboard will not work properly. Selecting PnP/PCI Configurations on the main program screen displays this menu:

CMOS Setup Utility – Copyright (C) 1984 – 2001 Award Software
PnP/PCI Configurations

PNP OS Installed	No	Item
Reset Configuration Data	Disabled	
Resources Controlled by	Auto(ESCD)	Menu Level ▶
x IRQ Resources	Press Enter	Select Yes if you are using a Plug and Play capable operating system Select No if you need the BIOS to configure non-boot devices
x DMA Resources	Press Enter	
PCI/VGA Palette Snoop	Disabled	
Assign IRQ For VGA	Enabled	
Assign IRQ For USB	Enabled	
INT Pin 1 Assignment	Auto	
INT Pin 2 Assignment	Auto	
INT Pin 3 Assignment	Auto	
INT Pin 4 Assignment	Auto	

↑↓→←: Move Enter : Select +/-/PU/PD: Value: F10: Save ESC: Exit F1: General Help
F5: Previous Values F6: Fail-Safe Defaults F7: Optimized Defaults

PNP OS Installed (No)

Setting this option to Yes allows the PnP OS (instead of BIOS) to assign the system resources such as IRQ and I/O address to the ISA PnP device. The default setting is No.

Reset Configuration Data (Disabled)

If you enable this item and restart the system, any Plug and Play configuration data stored in the BIOS setup is cleared from memory. New updated data is created.

Resources Controlled By (Auto(ESCD))

You should leave this item at the default Auto(ESCD). Under this setting, the system dynamically allocates resources to Plug and Play devices as they are required.

If you cannot get a legacy ISA (Industry Standard Architecture) expansion card to work properly, you might be able to solve the problem by changing this item to Manual, and then opening up the IRQ Resources and Memory Resources submenus.

In the IRQ Resources submenu, if you change any of the IRQ assignments to Legacy ISA, then that Interrupt Request Line is reserved for a legacy ISA expansion card. Press <Esc> to close the IRQ Resources submenu.

In the Memory Resources submenu, use the first item Reserved Memory Base to set the start address of the memory you want to reserve for the ISA expansion card. Use the second item Reserved Memory Length to set the amount of reserved memory. Press <Esc> to close the Memory Resources submenu.

PCI/VGA Palette Snoop (Disabled)

This item is designed to overcome some problems that can be caused by some non-standard VGA cards. This board includes a built-in VGA system that does not require palette snooping so you must leave this item disabled.

Assign IRQ for VGA/USB (Enabled)

Names the interrupt request (IRQ) line assigned to the USB/VGA (if any) on your system. Activity of the selected IRQ always awakens the system.

INT Pin 1 ~ Pin 4 Assignment (Auto)

Names the interrupt request (IRQ) line assigned to PCI 1 through PCI 4 on your system. Activity of the selected PCI slot awakens the system.

PCI Health Status Option

On mainboards that support hardware monitoring, this item lets you monitor the parameters for critical voltages, critical temperatures, and fan speeds. You cannot make any changes to these fields. They are for display only:

CMOS Setup Utility – Copyright (C) 1984 – 2001 Award Software
PC Health Status

Shutdown Temperature	Disabled	Item Help
Current CPU Temp.		Menu Level ▶
Current System Temp.		
CPU Fan Speed		
Power Fan Speed		
Voltage Core		
2.5V		
3.3V		
5.0V		
12.0V		

↑↓→← : Move Enter : Select +/-/PU/PD:Value: F10: Save ESC: Exit F1:General Help
F5:Previous Values F6:Fail-Safe Defaults F7:Optimized Defaults

Shutdown Temperature

Enables you to set the maximum temperature the system can reach before powering down.

System Component Characteristics

These fields provide you with information about the systems current operating status. You cannot make changes to these fields. The following information is displayed:

- CPU temperature in degrees Fahrenheit and Celsius
- System temperature in degrees Fahrenheit and Celsius
- CPU fan speed (in RPMs)
- Power fan speed (in RPMs)
- Vcore (CPU core voltage)
- VCC SRAM (CPU L2 cache voltage)
- Vcc3 (onboard 3.3 volt)
- Power supply's ± 5 volt

- Power supply's ±12 volt

Frequency Control Option

This item enables you to set the clock speed and system bus for your system. The clock speed and system bus are determined by the kind of processor you have installed in your system.

CMOS Setup Utility – Copyright (C) 1984 – 2001 Award Software
Frequency Control

Auto Detect DIMM/PCI Clk	Enabled	Item Help
Spread Spectrum	Disabled	Menu Level ▶
CPU Host/PCI Clock	Default	
CPU Clock Ratio	Auto	
CPU clock failed reset	Disabled	

↑↓→← : Move Enter : Select +/-/PU/PD:Value: F10: Save ESC: Exit F1:General Help
F5:Previous Values F6:Fail-Safe Defaults F7:Optimized Defaults

Auto Detect DIMM/PCI Clk (Enabled)

When this item is enabled, BIOS will disable the clock signal of free DIMM and PCI slots.

Spread Spectrum Modulated (+_0.5%)

If you enable spread spectrum, it can significantly reduce the EMI (Electro-Magnetic Interference) generated by the system.

CPU Host Clock/PCI Clock (Default)

Use the CPU Host Clock to set the frontside bus frequency for the installed processor or processors (usually 133 MHz, 100 MHz or 66 MHz).

CPU Clock Ratio (By Auto)

Use this item to select a multiplier for the system frontside bus (FSB) frequency. The value of the multiplier must be set so that:

Multiplier x Frontside Bus Frequency = CPU Clock Speed

For example, if you have a processor that is rated to run at 450 MHz and the system is running a frontside bus frequency of 100 MHz, you should select a multiplier of 4.5 so that:

4.5 (Multiplier) x 100 MHz (frontside bus) = 450 MHz (CPU clock)

CPU clock failed reset (Disabled)

When this item is enabled and the system crashes three times because the processor has been overclocked, the BIOS will automatically adjust the speed of the processor to the system bus speed multiplied by two.

Load Fail-Safe Defaults Option

This option opens a dialog box that lets you install fail-safe defaults for all appropriate items in the Setup Utility:

Press <Y> and then <Enter> to install the defaults. Press <N> and then <Enter> to not install the defaults. The fail-safe defaults place no great demands on the system and are generally stable. If your system is not functioning correctly, try installing the fail-safe defaults as a first step in getting your system working properly again. If you only want to install fail-safe defaults for a specific option, select and display that option, and then press <F6>.

Load Optimized Defaults Option

This option opens a dialog box that lets you install optimized defaults for all appropriate items in the Setup Utility. Press <Y> and then <Enter> to install the defaults. Press <N> and then <Enter> to not install the defaults. The optimized defaults place demands on the system that may be greater than the performance level of the components, such as the CPU and the memory. You can cause fatal errors or instability if you install the optimized defaults when your hardware does not support them. If you only want to install setup defaults for a specific option, select and display that option, and then press <F7>.

Set Supervisor and User Passwords Options

These items can be used to install a password. A Supervisor password takes precedence over a User password, and the Supervisor can limit the activities of a User. To install a password, follow these steps:

1. Highlight the item Set Supervisor/User Password on the main menu and press <Enter>.
2. The password dialog box appears.

Enter Password:

3. If you are installing a new password, type in the password. You cannot use more than eight characters or numbers. The Set Supervisor/User Password item differentiates between upper case and lower characters. Press <Enter> after you have typed in the password. If you are deleting a password that is already installed just press <Enter> when the password dialog box appears. You see a message that indicates that the password has been disabled.

PASSWORD DISABLED !!!
Press any key to continue . . .

4. Press any key. You are prompted to confirm the password:

Confirm Password:

5. Type the password again and press <Enter>, or just press <Enter> if you are deleting a password that is already installed.
6. If you typed the password correctly, the password will be installed.

Save & Exit Setup Option

Highlight this item and press <Enter> to save the changes that you have made in the Setup Utility and exit the Setup Utility. When the Save and Exit dialog box appears, press <Y> to save and exit, or press <N> to return to the main menu:

Exit Without Saving

Highlight this item and press <Enter> to discard any changes that you have made in the Setup Utility and exit the Setup Utility. When the Exit Without Saving dialog box appears, press <Y> to discard changes and exit, or press <N> to return to the main menu.

Note: If you have made settings that you do not want to save, use the "Exit Without Saving" item and press Y to discard any changes you have made.

This concludes Chapter 3. Refer to the next chapter for information on the software supplied with the mainboard.

Using the Mainboard Software

About the Software CD-ROM

The support software CD-ROM that is included in the mainboard package contains all the drivers and utility programs needed to properly run the bundled products.

Folders for this Mainboard

For this board, you can install software from the following folders:

IDE Folder

You can use the software in this folder to install VIA IDE driver for your operating system.

Audio Folder

You can use the software from the Audio folder to install audio drivers for your operating system.

Utility Folder

You can use the software in the following sub-folders:

- AWDFLASH:** Software to erase and install new revisions of the system BIOS (CMOS)
- PC-CILLIN:** Anti-virus software
- CD-Ghost:** Simulates up to twenty-three 200X CD-ROM drives
- Recovery Genius:** Data recovery software (30 day trial version)
- WinDVD (optional):** Video player software.

IDE Folder Installation Notes

You can use the software in this folder to install VIA IDE driver for your operating system.

Use the SETUP.EXE application in the \VIA\IDE folder.

Audio Folder Installation Notes

This folder has software and drivers for the Realtek codec sound system that is integrated on this mainboard. The Realtek codec allows the system to generate optimal sound effects. Drivers are provided for DOS, Linux, and Windows 2000/98/9x/NT.

Windows Installation

Use the SETUP.EXE application in the \VIA\AC97AUDIO folder.

DOS Installation

Browse to the \VIA\AC97AUDIO\DOS folder and run INSTALL.EXE.

Linux Installation

Refer to your operating system handbook for instructions on installing Linux drivers.

Utility Folder Installation Notes

Award Flash Memory Utility

This utility lets you erase the system BIOS stored on a Flash Memory chip on the mainboard, and lets you copy an updated BIOS to the chip. Take care how you use this program. If you erase the current BIOS and fail to write a new BIOS, or write a new BIOS that is incorrect, your system will malfunction.

There are several flash memory utilities on the support CD. For this mainboard, you can use **AWD7XX.EXE**. To use the utility, you must be in real-mode DOS (not the DOS box that is available in Windows 95/98/NT). If you are using WINDOWS 95/98, shut down your computer and select the option *Restart in DOS* in the shutdown dialog box. If you are running Windows NT, shut down your computer and boot from a DOS diskette temporarily in order to run the flash memory utility.

PC-cillin Software

The PC-CILLIN software program provides anti-virus protection for your system. This program is available for Windows 2000/ME/98SE and Windows NT. Be sure to check the readme.txt and install the appropriate anti-virus software for your operating system.

We strongly recommend users to install this free anti-virus software to help protect your system against viruses.

CD-Ghost

The CD Ghost software enables you to create a virtual cabinet of CD-ROM drives on your system to help you categorize and organize your CD collection. A user-friendly interface assists you in quickly creating images of both CDs and DVDs onto your system. To install the software, run SETUP.EXE from the following directory:

UTILITY\CDGHOST\ENG\CDGHOST

Recovery Genius

The Recovery Genius software program is an innovative windows application system that protects your Hard Disk Drive from virus intrusion, accidental deletions and from system corruption. To install the Recovery Genius software program run SETUP.EXE from the following directory:

`\UTILITY\RECOVERY GENIUS\ENG\RECOVERYGENIUS`

WinDVD (optional)





Go to the directory `\UTILITY\WINDVD`; then run `SETUP.EXE` to install the application software. The WinDVD software is not free. Before you install, you need to register and get the serial number first.

This concludes Chapter 4.

Appendix A

Setting Jumpers

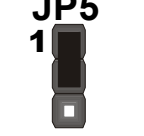
Jumper Settings

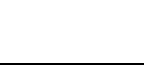
Jumper	Type	Description	Setting (default)	
JP1	3 pin	Clear CMOS jumper	1-2: <i>Normal</i> 2-3: Clear CMOS	
JP3	3 pin	BIOS flash protection jumper	1-2: <i>Unlock</i> 2-3: Lock	
JP4	3 pin	Onboard co-dec/AMR slot selector	1-2: <i>Onboard co-dec</i> 2-3: AMR slot	
JP5	3 pin	AMR Master/Slave selector	1-2: <i>Slave AMR</i> 2-3: Master AMR	
JP6	3 pin	CPU frequency jumper	1-2: <i>Normal operation</i> 2-3: Force a 66 MHz FSB to run at 100 MHz FSB	
JP7	3 pin	CPU frequency jumper	1-2: <i>Normal operation</i> 2-3: Force a 100 MHz FSB to run at 133 MHz FSB	

JP1: Clear CMOS Jumper

This jumper enables you to reset BIOS:

1. Turn the system off.
2. Short pins 2 and 3 on jumper 1.
3. Return the jumper to the normal setting.
4. Turn the system on. The BIOS is returned to the default settings.

JP3: BIOS Flash Protection Jumper

Set the jumper to disabled if you are going to update your BIOS. After updating the BIOS, return it to the default setting (enabled). For instructions on updating the BIOS refer to Chapter 3.

JP4: Onboard CODEC/AMR Slot Selection

This jumper is used to enable either the onboard codec or the AMR slot codec (AMR1).

JP5: AMR Master/Slave Select Jumper

This jumper is used to distinguish the AMR codec from the onboard AC 97 codec to avoid conflict.

JP6: CPU Frequency Select Jumper 1

This jumper is used to force a CPU clock running at 66 MHz FSB to run at 100 MHz FSB. It is recommended that you leave the jumper on the normal setting.















JP7: CPU Frequency Select Jumper 2

This jumper is similar to JP6 and is used to force a CPU clock running at 100 MHz FSB to run at 133 MHz FSB. It is recommended that you leave the jumper on the normal setting.

Note: The CPU speed is determined by the CPU Host/PCI Clock speed multiplied by the CPU Clock Ratio. Refer to the Frequency Control Option in Chapter 3 for more information. Also note that Forcing the CPU to run at a higher clock speed than it was rated for is called overlocking and is not recommended.

The Panel Connector

The panel connector provides a set of switch and LED connectors usually found on ATX or micro-ATX cases. Refer to the table below for information:

Device	Pins	23	
Power switch	22, 23		Power Switch (Pins 22, 23)
Hard disk LED Indicator	+20, -21		
Empty pin	19		HDD LED (Pins 20, 21)
Speaker	+15, -16, 17, 18		Speaker (Pins 15, 16, 17, 18)
Empty pin	14		
Reset switch	12, -13		
Empty pins	10, 11		Reset Switch (Pins 12, 13)
Green LED indicator	+7, +8, -9		
Empty pin	6		Green LED (Pins 7, 8, 9)
Sleep switch	4, -5		
Power LED indicator	+1, +2, -3		
			Sleep Switch (Pins 4, 5)
			Power LED (Pins 1, 2, 3)
			

Note: The plus sign (+) indicates a pin which must be connected to a positive voltage.