

KN-6010

**MAINBOARD
MANUAL**

DOC No. : 15759

Rev. : A0

Date : 5, 1997

Part No. : 25-10740-
00

Table of Contents

Chapter 1 Overview

Package Checklist	2
Main Features	3
Advanced Features	5
1). Enhanced Performance Features	5
2). Intelligent Features	6
PC '97 Compliant	7
ACPI Ready	8
DMI (Desktop Management Interface)	9
Infrared Connections	10
Highly Convenient Integrated I/O Connectors	11

Chapter 2 Installation Procedures

Mainboard Layout	14
1). Set System Jumpers	15
Jumpers	15
Clear Password: CPS	16
Flash EPROM Type Selection: EP1, EP2	16
2). Install RAM Modules	17
DRAM Memory	17
RAM Module Configuration	18
Install SIMMs	19
Remove SIMMs	19
3). Install the CPU	20
Retention Mechanism Kit	20
CPU Module Installation	21
CPU to Bus Frequency Ratio: FREQ1, FREQ2, FREQ3, FREQ4	26
4). Install Expansion Cards	27
5). Connector Cables and Power Supply	29
Serial Port Connectors: COM1, COM2	29
CPU Fan Connector: FAN1	29
System Case Fan Connector: FAN2	30
Floppy Diskette Drive Connector: FLOPPY	30
Front Panel Block Connector: F_PNL	31
Infrared Connector: IR	32

PS/2 Keyboard Connector: PS2_KB	32
PS/2 Mouse Connector: PS2_MS	33
ATX Power Connector: ATX_PWR	33
Standard Power Connector: AT_PWR.....	34
IDE HDD Device Connectors: PRIMARY, SECONDARY	34
Printer Connector: PRINTER.....	35
Remote Power Connector: RPW_CON.....	35
Universal Serial Bus Connectors: USB0, USB1	36

Chapter 3 AMI BIOS Setup

Main Setup	37
Advanced Setup	38
Advanced CMOS Setup.....	39
Advanced Chipset Setup.....	44
Power Management Setup.....	48
Plug and Play Setup	51
Peripheral Setup.....	54
Security Setup.....	57
Exit Setup.....	58

Appendix A DMI Utility

System Requirements.....	59
Edit BIOS DMI Information	59
Installing DMI Wizard	60
Starting DMI Wizard.....	60
Main Screen Actions	60

Appendix B BIOS Update Instruction

Flash Process	63
---------------------	----

Overview

Based on the highly-integrated [Intel 440FX PCIset](#), the KN-6010 combines blistering [Pentium® II](#) processor performance with support for intelligent diagnostic and power management features like [Hardware Monitoring](#), [DMI \(Desktop Management Interface\)](#) and [ACPI \(Advanced Configuration and Power Interface\)](#), to provide a powerful and versatile ATX-size platform for leading-edge PC '97 compliant systems.

With its [switching voltage regulator](#), the KN-6010 runs a range of [Intel Pentium® II processors](#) and can be easily upgraded with its 242-pin slot. For added power and performance, the KN-6010 takes up to [512KB Pipeline Burst Level II cache](#) and up to [768MB DRAM](#) via [six-72 SIMM sockets](#) which accept high-speed EDO memory types.

The KN-6010 comes with a full set of I/O features conveniently integrated on the rear I/O panel, including [two USB connectors](#). The board also has an integrated [PCI Bus Master Enhanced IDE controller](#) with existing PIO Mode 3, PIO Mode 4 and DMA Mode 2 devices.

Compliant with the [Microsoft PC'97](#) standard at both the hardware and BIOS levels, the KN-6010 comes with support for intelligent [Hardware Monitoring](#) and [DMI features](#) which continuously check the thermal status of your system and reduce the cost of ownership through improved manageability.

Chapter 1 of this manual gives you a brief overview of the KN-6010 mainboard, including its main components and features. Chapter 2 contains advice on how to upgrade and install key components on the mainboard, while Chapter 3 provides detailed information about the board's BIOS settings. For the most up-to-date information about your mainboard and the latest FAQs and BIOS updates, visit FIC Online at www.fic.com.tw.

Package Checklist

Please check that your package contains all the items listed below. If you discover any item is damaged or missing, please contact your vendor.

- The KN-6010 mainboard
- This user manual
- Software utility (DMI)
- One IDE device cable
- One floppy disk drive cable

Main Features

The KN-6010 mainboard comes with the following high-performance features:

- **Easy Installation**
AMI BIOS with support for auto-detection of Hard Disk Drives, Plug and Play devices, and PS/2 keyboard and mouse, and to facilitate the installation of HDDs, expansion cards and other peripheral devices.
- **Flexible Processor Support**
Onboard 242-pin Slot1 supports leading-edge processors:
Intel Pentium® II 233/266 MHz with MMX™ technology.
- **Leading Edge Chipset**
Intel 82440FX PCIset includes a CPU interface controller, advanced cache controller, integrated DRAM controller, synchronous ISA bus controller, integrated power management unit, concurrent PCI (PCI 2.1), and USB.
- **Ultra-fast Level II Cache**
Supports 256/512KB L2 synchronous PDSRAM cache memory on Pentium® II card.
- **Versatile Main Memory Support**
Accepts up to 768MB RAM in three banks using 72-pin SIMMs of 4, 8, 16, 32, 64, 128MB with support for FPM and EDO memory.
- **ISA & PCI Expansion Slots**
Three 16-bit ISA and five 32-bit PCI expansion slots provide all the room you need to install a full range of add-on cards.
- **USB Support**
Two USB ports integrated in the rear I/O panel allow convenient, high-speed Plug and Play connections to the growing number of USB compliant external peripheral devices on the market.

■ **Enhanced PCI Bus Master IDE Controller Support**

Integrated Enhanced PCI Bus Master IDE controller features two dual-channel connectors that accept up to four Enhanced IDE devices, including CD-ROM and Tape Backup Drives, as well as Hard Disk Drives.

■ **Super Multi I/O**

Integrated Winbond W83977AF Plug and Play multi-I/O chipset features two high-speed 16550A compatible serial ports, one IR port, one EPP/ECP capable parallel port, and one FDD connector.

■ **IrDA Connector**

An onboard IR connector and FIR connector for wireless infrared connections is available.

Advanced Features

SDRAM support, Hardware Monitoring, DMI and ACPI, that not only optimize the performance of the latest processors but also enhance the manageability, power management capabilities, and user-friendliness of your system. This section provides detailed information on these features, and how they are implemented on the mainboard.

1). Enhanced Performance Features

■ Optimized Intel MMX™ Performance

The mainboard utilizes the advanced features of the Intel 440FX PCIset to optimize the unrivaled performance of the Intel Pentium® II processor with MMX™ technology, allowing you to enjoy a richer video, audio, digital imaging and communications experience from the latest generation of multimedia software.

■ Blistering IDE Performance

With the integrated Enhanced PCI Bus Master IDE controller you can connect up to four Enhanced IDE peripheral devices to your system. All devices are categorized in the same way that IDE hard disks were configured in the past, with one device set as the master device and the other as the slave device. We recommend that Hard Disk Drives use the primary IDE connector and that CD-ROM Drives utilize the secondary IDE connector for optimum system performance.

■ Concurrent PCI Architecture

The mainboard's Concurrent PCI Architecture enables more efficient operation of CPU, PCI and ISA transactions for faster and smoother multimedia performance. It also allows the use of PCI 2.1 and 2.0 compatible add-in cards for long system life, built-in scalability and the flexibility to adapt your system to future applications.

2). Intelligent Features

This mainboard is equipped with highly-sophisticated intelligent Hardware Monitoring features that prevent potential damage to your system by warning you when the system is overheated and automatically slowing down the processor clock speed and activating the system fan to restore the system to its optimum temperature. Other intelligent features include system BIOS virus protection and a switching voltage regulator.

■ CPU Thermal Monitoring Alert

A special heat sensor located under the CPU monitors the CPU temperature to make sure that the system is operating at a safe heat level. If the temperature is too high, the sensor automatically generates an SMI (System Management Interrupt) to turn on the system fan and slow down the CPU clock frequency. At the same time, the system warns you that the CPU is overheating. CPU utilization is restored to normal levels when the temperature returns to a safe level.

■ Switching Voltage Regulator

This mainboard features a switching voltage regulator, which significantly reduces the temperature of the CPU and regulator itself. The switching voltage regulator also ensures full upgradability to the next generation of SLOT1 processors, which will require more electrical current and generate more heat both in the processor and the system.

■ System Over-Voltage Protection

This mainboard features a protection to automatically shut down the system if system voltage proceeds is over 5% of the following four types of voltages: +12V, +5V, +3.3V, and the CPU voltage (+2.8V, in this manual).

PC '97 Compliant

This mainboard is fully compliant with the new PC '97 standard at both the BIOS and hardware levels. PC '97 is a set of hardware, bus and device design requirements set by Microsoft in conjunction with other industry leaders aimed at making PCs easier to use by maximizing cooperation between the operating system and hardware.

The system design requirements under PC '97 support a synergy among PC hardware, Microsoft Windows® Operating Systems, and Windows®-based software. Key elements include support for Plug and Play compatibility and power management for configuring and managing all system components, and 32-bit device drivers and installation procedures for both Windows® 95 and Windows® NT.

ACPI Ready

This mainboard fully implements the new ACPI (Advanced Configuration Power Interface) standard, an open PC hardware, Operating System and peripheral device interface specification that is supported by such industry leaders as Microsoft and Intel. ACPI enables PCs to come on instantly when accessed by a user and remain available to perform certain tasks even after the PC is turned off. Additional benefits of ACPI include improved thermal management, reduced energy consumption, and OS directed Plug and Play capabilities.

ACPI is currently being implemented in forthcoming versions of Microsoft Windows® 95 and Windows® NT code-named “Memphis”. Key ACPI features implemented on this mainboard include:

- **Soft-Off Support**

The mainboard’s Soft-Off feature allows you to turn off your computer using the Operating System (Windows® 95). The feature requires a power supply with a soft-off power controller.

- **Remote Ring-On**

The Remote Ring-On function allows your computer to be turned on remotely via a modem while it is in Sleep Mode. This feature is particularly useful when, for example, you are expecting a fax late at night and leave only your modem on to minimize power consumption. As soon as the phone rings, the modem automatically turns on the system, which answers the phone and downloads the fax. Then the computer shuts off again, thereby minimizing its consumption of power. The Remote Ring-On function requires a power supply with a soft-off power controller.

Please see the AMI BIOS Setup Section for more information on how to use these features.

DMI (Desktop Management Interface)

Enhanced system manageability is becoming an increasingly important factor in reducing the total cost of ownership of systems, particularly in a corporate environment. To provide this capability, this mainboard supports DMI at the BIOS level and includes a DMI Configuration Utility to maintain the Management Information Format Database.

DMI is able to auto-detect and record important information about your system, including the CPU type, CPU speed, internal/external frequencies, and memory size. The BIOS detects this information in 4KB block in the mainboard's Flash EPROM and allows the DMI to retrieve this data from the database. To allow dynamic real-time updating of the DMI information, this mainboard uses the same technology implemented for Plug and Play, which eliminates the need to create a new BIOS image file and for the user to update the whole BIOS.

The board's DMI Configuration Utility also allows the system integrator or end-user to add additional information to the database, such as serial numbers and housing configurations. This information has to be manually entered using the DMI Configuration Utility and updated into the database. For detailed instructions on how to use the DMI Configuration Utility, please refer to page 59 of this manual.

Infrared Connections

This mainboard features support for highly-sophisticated IR technology, which allows bi-directional and cordless data transactions with other IrDA compliant computers and peripheral devices using infrared as a medium. This transmission is carried out in either Full Duplex Mode or Half Duplex Mode. The former allows simultaneous data transmission and reception, while the latter disables the reception when transmission occurs.

The I/O chipset on this mainboard features onboard IR and FIR interfaces that are fully compliant with the IrDA standard. An IrDA device can be installed via a 9-pin D-type connector in the rear panel of the computer which is linked by a cable to the onboard either IR or FIR pinhead, as shown in the illustration below.

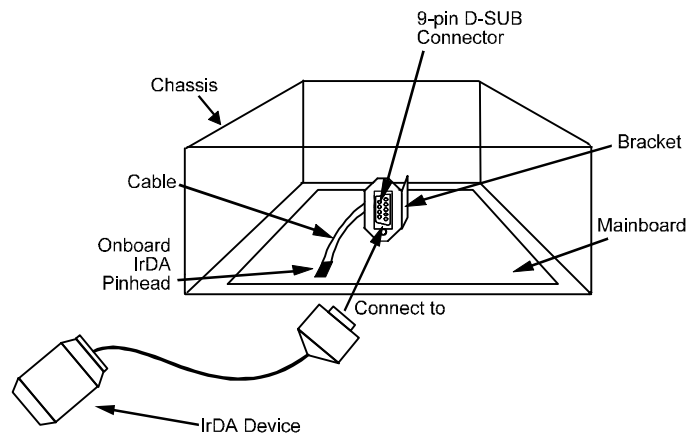

If you want to connect a device that supports FIR, please set the ribbon cable on the FIR pinhead and adjust the BIOS option for higher-speed performance. Please read page 53 of this manual.

Highly Convenient Integrated I/O Connectors

This mainboard features has an integrated rear I/O panel that incorporates a full set of I/O ports to allow simple and convenient connections to a complete selection of external peripheral devices.

In addition to two 16550A UART compatible serial ports and one EPP/ECP capable parallel port, the panel features two USB connectors that provide high speed connections to the new generation of USB peripheral devices. PS/2 keyboard and PS/2 mouse connectors provide additional I/O connectivity.

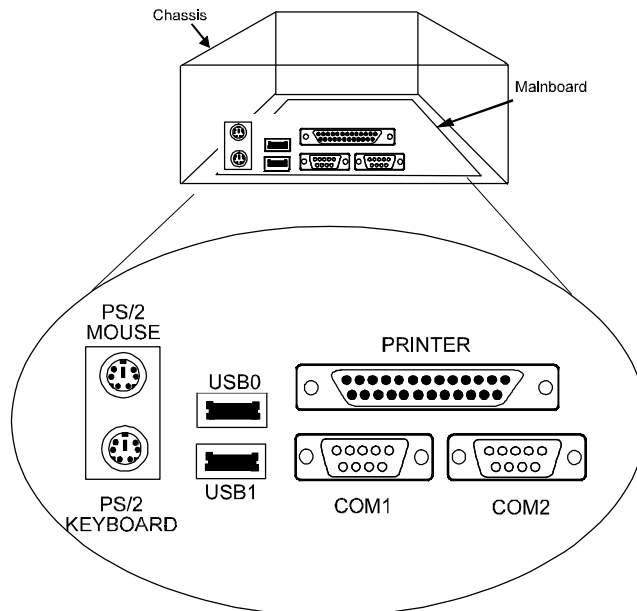

This Page Intentionally Left Blank

Installation Procedures

The KN-6010 has several user-adjustable jumpers on the board that allow you to configure your system to suit your requirements. This chapter contains information on the various jumper settings on your mainboard.

To set up your computer, you should follow these installation steps:

- Step 1 -
Set system jumpers
- Step 2 -
Install System RAM modules
- Step 3 -
Install the CPU
- Step 4 -
Install expansion cards
- Step 5 -
Connect cables and power supply
- Step 6 -
Set up BIOS feature (Please read Chapter 3.)

Mainboard Layout

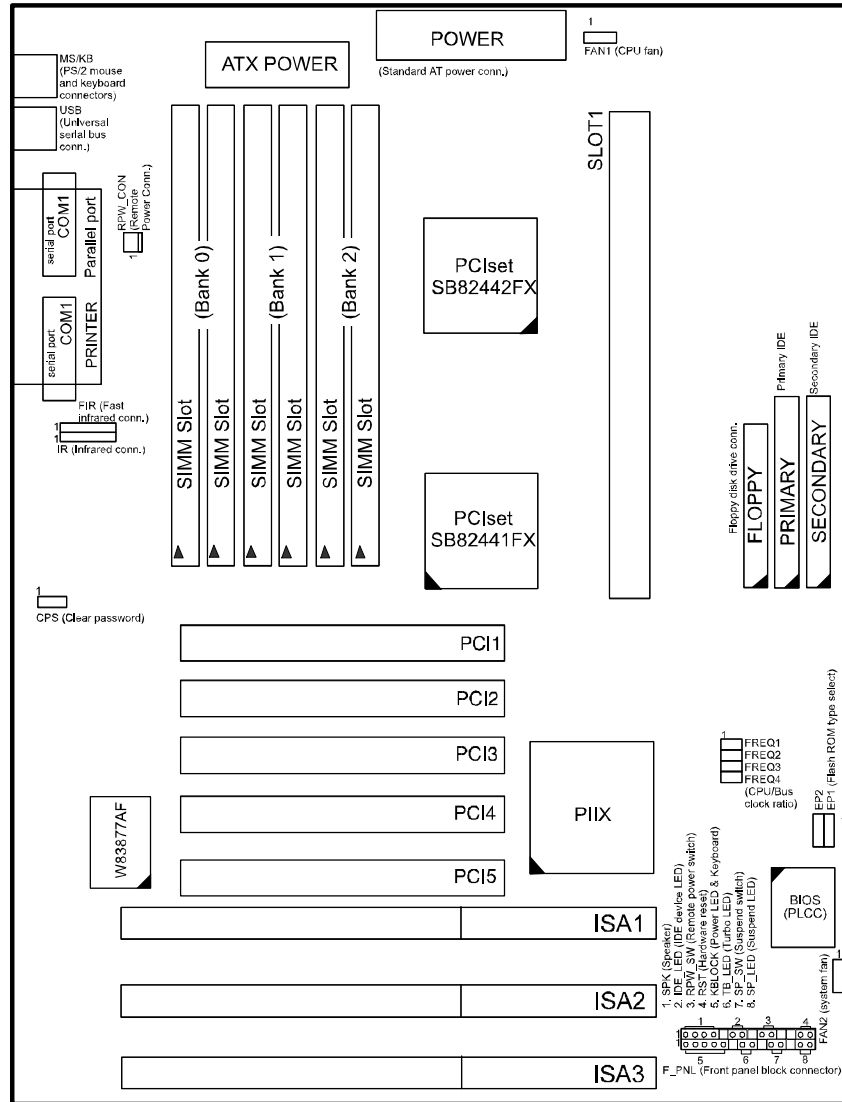

1). Set System Jumpers

Jumpers

Jumpers are used to select the operation modes for your system. Some jumpers on the board have three metal pins with each pin representing a different function. To **set** a jumper, a black cap containing metal contacts is placed over the jumper pin/s according to the required configuration. A jumper is said to be **shorted** when the black cap has been placed on one or two of its pins. The types of jumpers used in this manual are shown below:

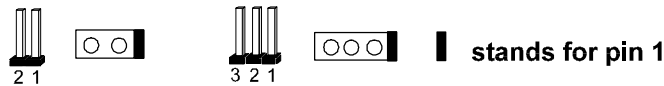
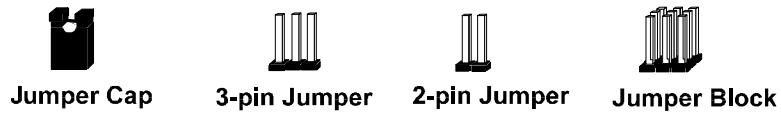

Jumpers are shown as above

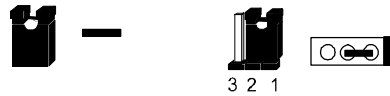

Jumper cap is shown as above



Jumpers in a Block

NOTE : Users are not encouraged to change the jumper settings not listed in this manual. Changing the jumper settings improperly may adversely affect system performance.

Clear Password: CPS

This jumper allows you to set the password configuration to **Enabled** or **Disabled**. You may need to enable this jumper if you forget your password.

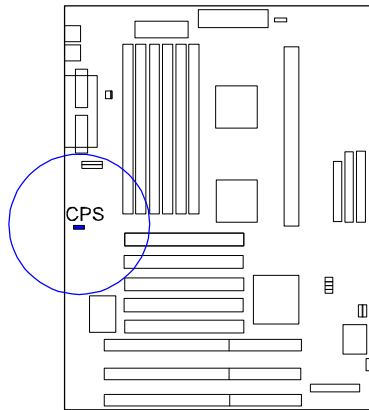

Enable











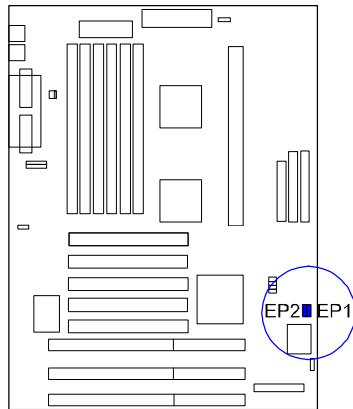



Disable
(Default)

Flash EPROM Type Selection:

EP1, EP2

These two jumpers allow you to configure the Flash EPROM chip



1M	EP1	EP2
Intel	 1	 1
SST 29EE010	 1	 1
2M	EP1	EP2
AMD AM29F002T	 1	 1
SST 29EE020	 1	 1
ATMEL AT29C020	 1	 1
MXIC MX28F2000P	 1	 1

2). Install RAM Modules

DRAM Memory

The working space of the computer is the Random Access Memory (RAM). The system cannot act upon data unless it is loaded into RAM. The system RAM is comprised of industry-standard 72-pin Single In-line Memory Modules (SIMMs).

Occasionally the system must break apart data files because the entire file can not be fitted into the RAM area. Consequently, when the system needs data that is not in RAM, it must access the disk where the balance of the data is stored. Compared with the lightning speed accessing a RAM, accessing a mechanical disk drive is a much slower process.

When more RAM is added, the working area of the computer is larger, thereby increasing total performance. You should verify the type and speed of the RAM currently installed from your dealer. Mixtures of the RAM types, other than those described in this manual, will have unpredictable results.

The KN-6010 is able to support standard **FPM (Fast Page Mode) and EDO (Extended Data Out) DRAM**; and can accommodate onboard memory from **8 to 768MB** using SIMMs. The mainboard has three memory banks, Bank 0, Bank 1, and Bank 2. Each bank has two SIMM sockets which can accept either a pair of **4MB, 8MB, 16MB, 32MB, 64MB, or 128MB** SIMMs in each socket.

RAM Module Configuration

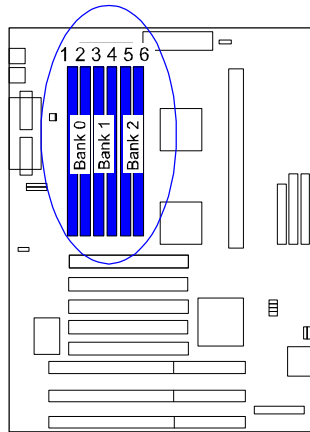

The DRAM module installation must be in pairs of the same size for each bank. The minimum size of SIMM for each SIMM slot is 4MB; the maximum is 128MB*. Both SIMM slots in a bank must be filled, though one whole bank can be left empty.

For instance, to install a total of 24MB DRAM you can use the following configuration; one 4MB DRAM module in SIM1, one 4MB DRAM module in SIM2, one 8MB DRAM modules into SIM3 and SIM4 and leave SIM5 and SIM6 empty.

NOTE : * A RAM module of this size was not available for testing when this manual was printed.

Install SIMMs

Complete the following procedures to install SIMMs:

CAUTION :

1. Always turn the system power off before installing or removing any device.
2. Always observe static electricity precautions.
See "Handling Precautions" at the start of this manual.

1. Locate the SIMM slots on the mainboard.

NOTE : SIMMs in each bank must be of the same type; and the BIOS automatically configures the memory size.

2. Carefully fit a SIMM at a 45 degree angle into each empty socket to be populated. All the SIMMs must face the same direction.

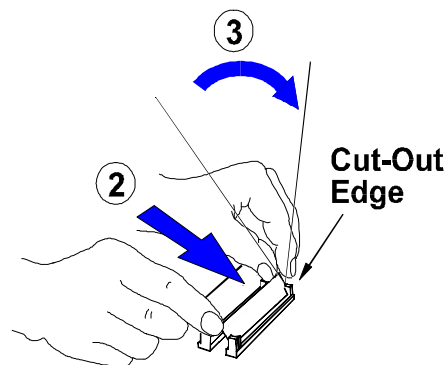

3. Swing each SIMM into its upright, locked position.
When locking a SIMM in place, push on each end of the SIMM - do not push in the middle, as shown above.

Remove SIMMs

To remove the SIMMs, pull the retaining latch on both ends of the socket and reverse the procedure above.

3). Install the CPU

Retention Mechanism Kit

The mainboard comes with a Retention Mechanism Kit as shown below. If any piece is missing, please contact your local mainboard dealer to help you.

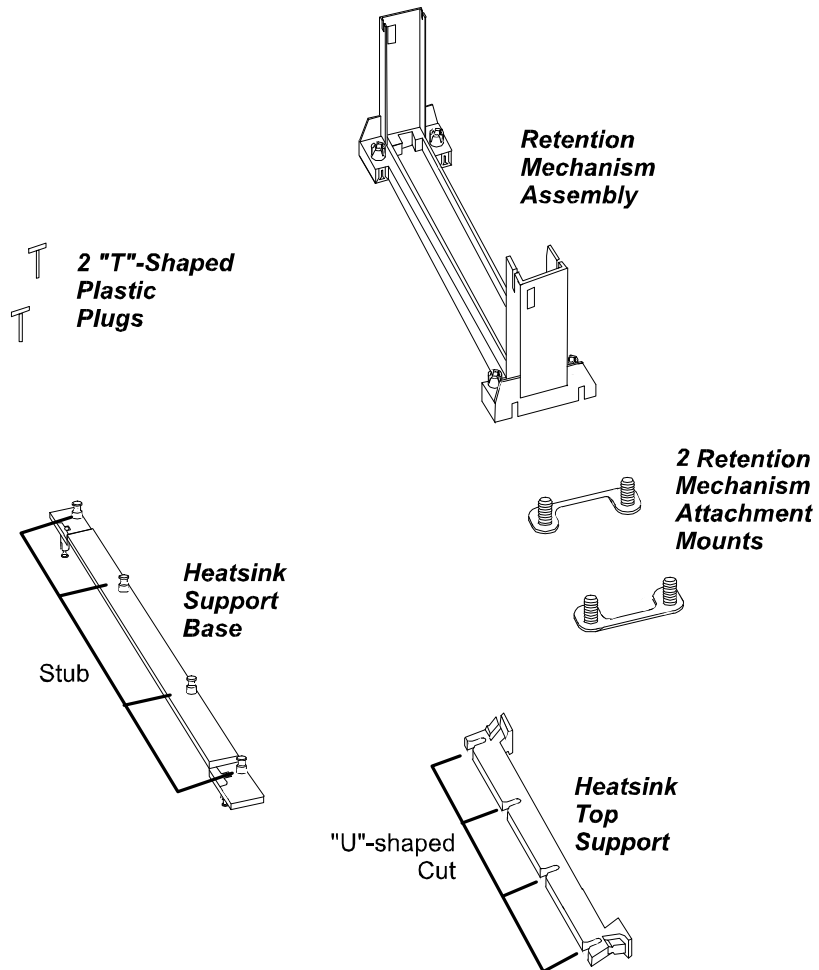

CPU Module Installation

1. Locate Slot1 on the KN-6010 mainboard.

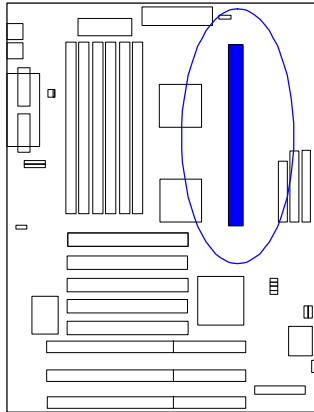

2. Place the Heatsink Support Base on the mainboard as shown.

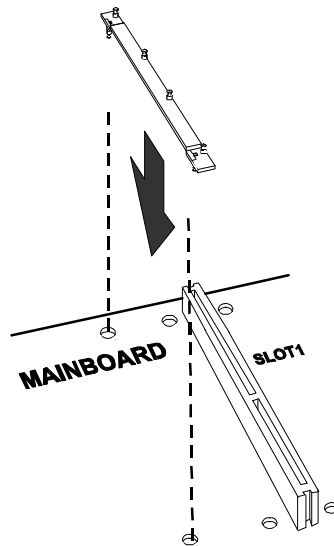

3. Affix it by inserting one "T"-shaped plastic plug into the hole on each end.

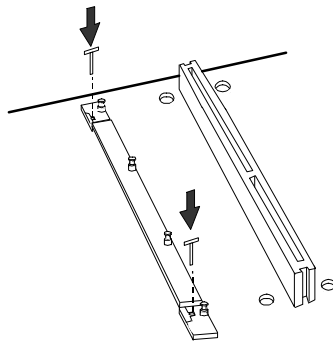

4. Install two Retention Mechanism Attachment Mounts on the board

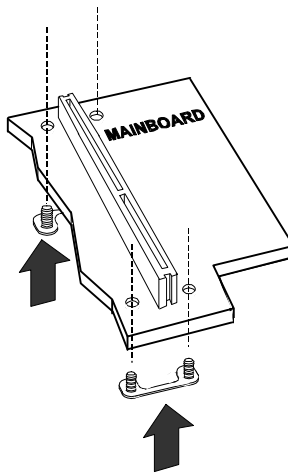

5. Place the Retention Mechanism Assembly on the board, on top of the Retention Mechanism Attachment Mounts.

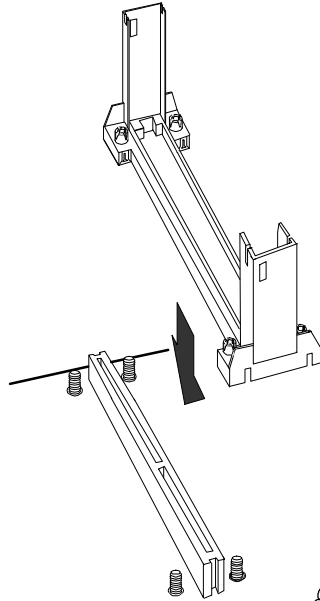

6. Affix the Retention Mechanism Assembly with four screws.

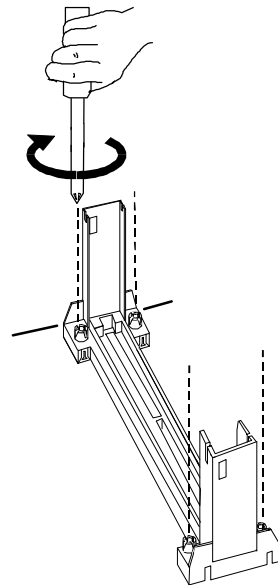

7. Horizontally slide the Heatsink Top Support into the lowest gaps on the CPU module heatsink as shown below.

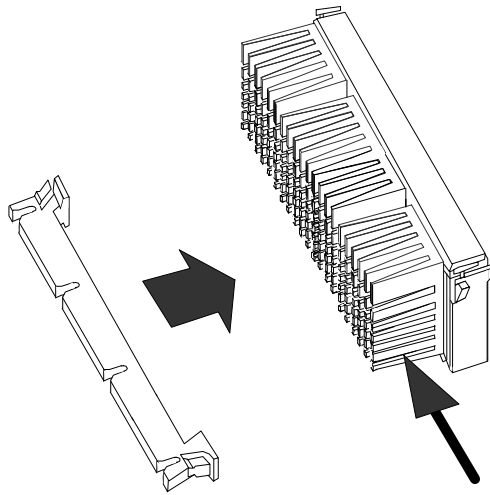

8. Slide the CPU module into the Retention Mechanism Assembly.

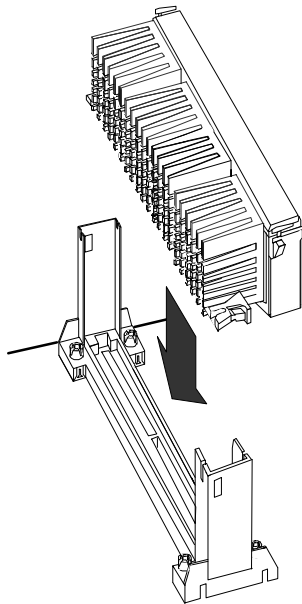

9. Press the buttons on either end of the CPU module.

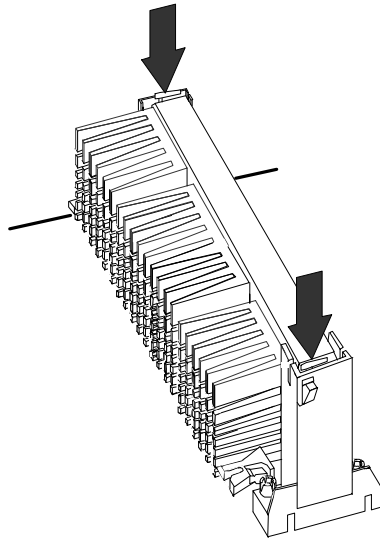

10. Hook the Heatsink Top Support to the Heatsink Support Base to affix the CPU module.

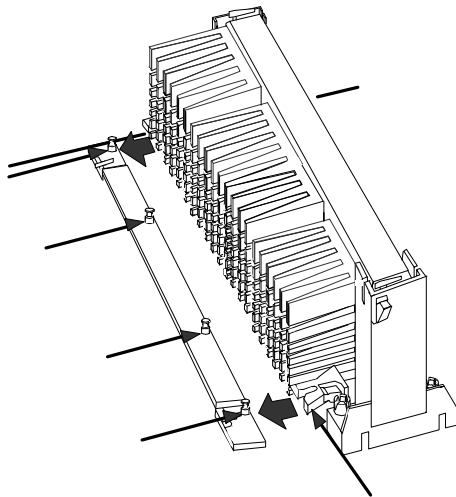

CPU to Bus Frequency Ratio: *FREQ1, FREQ2, FREQ3, FREQ4*

These four jumpers are used in combination to decide the ratio of the internal frequency of the CPU to the bus clock.

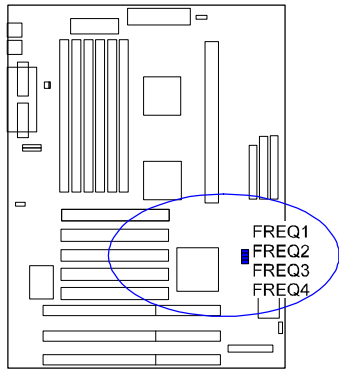

Ratio	FREQ1	FREQ2	FREQ3	FREQ4
3.5 X	 1	 1	 1	 1
4 X	 1	 1	 1	 1
4.5 X	 1	 1	 1	 1
5 X	 1	 1	 1	 1

4). Install Expansion Cards

Your KN-6010 features three 16-bit ISA Bus and five 32-bit PCI Bus expansion slots.

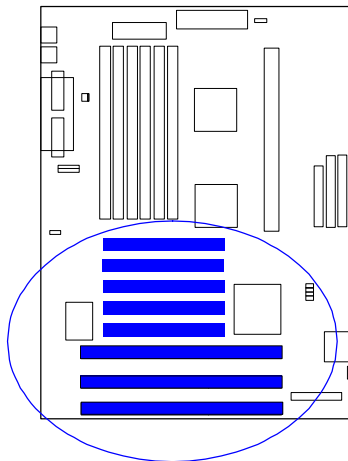

This section describes how to connect an expansion card to one of your system's expansion slots. Expansion cards are printed circuit boards that, when connected to the mainboard, increase the capabilities of your system. For example, expansion cards can provide video and sound capabilities.

CAUTION :

1. Always turn the system power off before installing or removing any device.
2. Always observe static electricity precautions.
See "Handling Precautions" at the start of this manual.

To install an expansion card, do the following:

1. Remove the chassis cover and select an empty expansion slot.
2. Remove the corresponding slot cover from the chassis.
Unscrew the mounting screw that secures the slot cover and pull the slot cover out from the chassis. Keep the slot cover mounting screw nearby.

3. Holding the edge of the peripheral card, carefully align the edge connector with the expansion slot. (See figure below.)

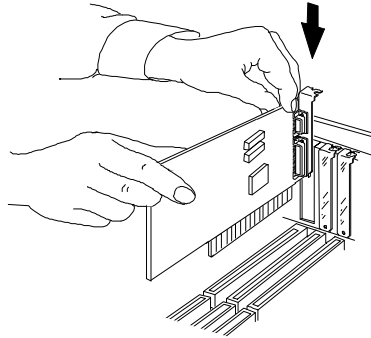

4. Push the card firmly into the slot. Push down on one end of the expansion card, then the other. Use this “rocking” motion until the add-in card is firmly seated inside the slot.
5. Secure the board with the mounting screw removed in Step 2. Make sure that the card has been placed evenly and completely into the expansion slot.

5). Connector Cables and Power Supply

Serial Port Connectors: COM1, COM2

These two 9-pin D-Sub male connectors allow you to connect with your devices that use serial ports, such as a serial mouse or a modem.

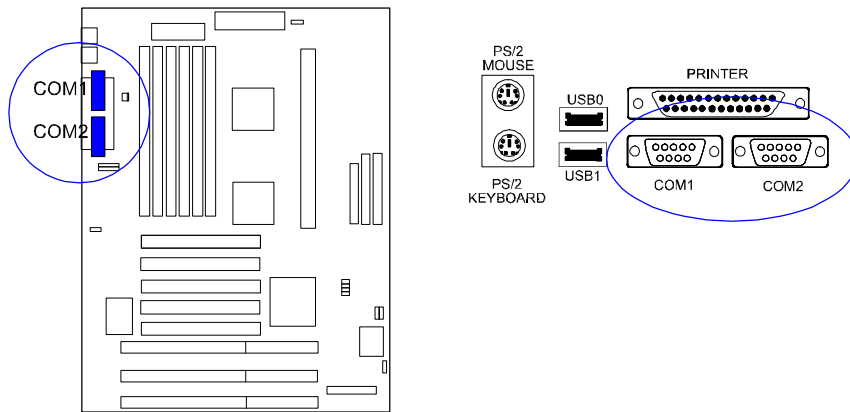

CPU Fan Connector: FANI

This connector is linked to the CPU fan. When the system is in Suspend mode, the CPU fan will turn off; when it returns to full on mode, the fan will turn on.

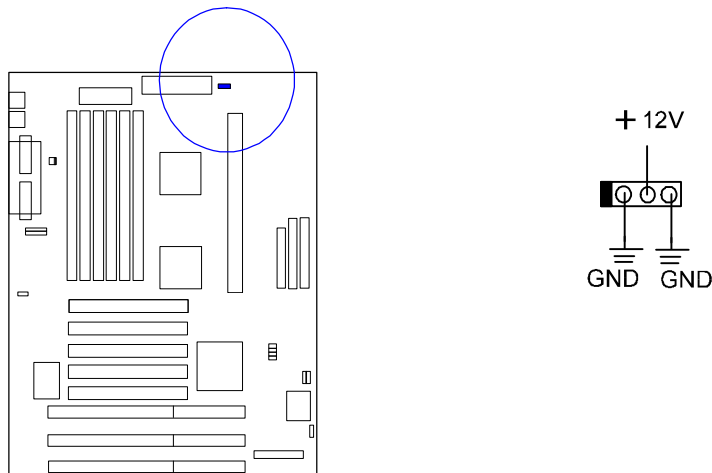

System Case Fan Connector: FAN2

This 3-pin connector links to your cooling fan on the system case to lower the system temperature; please read page 56 for more information.

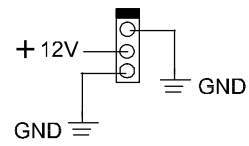
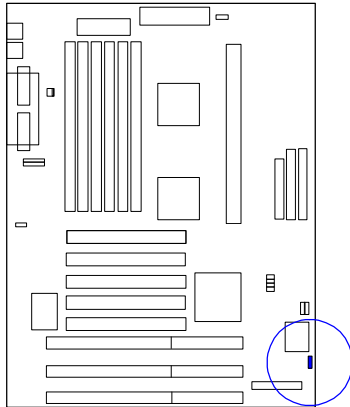

Floppy Diskette Drive Connector: FLOPPY

This 34-pin block connector connects to your floppy disk drive using the cable that is provided with this mainboard.

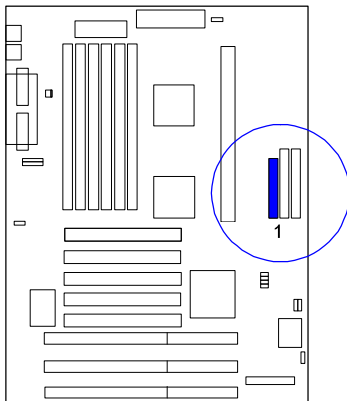

Front Panel Block Connector: F_PNL

This block connector concludes : PW_LED, KB_LOCK, TB_LED, SP_SW, SPK, SP_LED, IDE_LED, RPW_SW, and RST connectors.

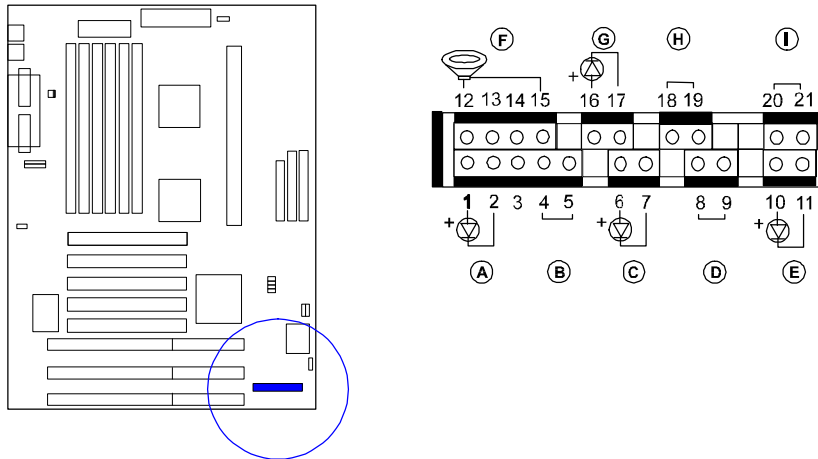

Item	Connector	Pin Type	Feature
A	PW_LED	2-pin male	indicates the system power status
B	KB_LOCK	2-pin male	allows the keyboard to access the system
C	TB_LED	2-pin male	indicates the system speed is in normal or turbo speed
D	SP_SW	2-pin male	Suspend mode switch
E	SP_LED	2-pin male	indicates the system into Suspend mode when LED lit
F	SPK	4-pin male	connects to speaker
G	IDE_LED	2-pin male	indicates the IDE HDD I/O access LED lit
H	RPW_SW	2-pin male	remote power switch
I	RST	2-pin male	allows you to reset the system

Infrared Connector: IR

These two 5-pin male connectors are used for connecting to the infrared (SIR) ports and allow transmission of data to another systems which also support the IR or FIR feature. The BIOS allows you to select either IR or FIR. Please read page 53 of this manual for more information.

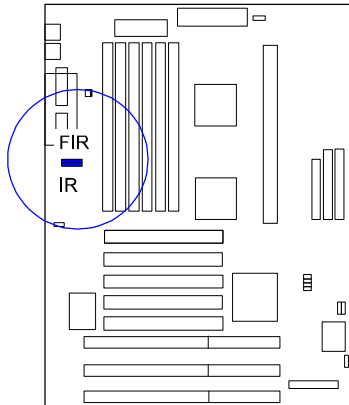

PS/2 Keyboard Connector: PS2_KB

This 5-pin female connector is used for your PS/2 keyboard.

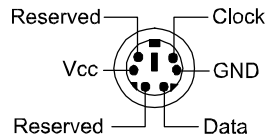
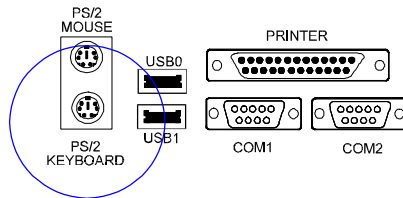
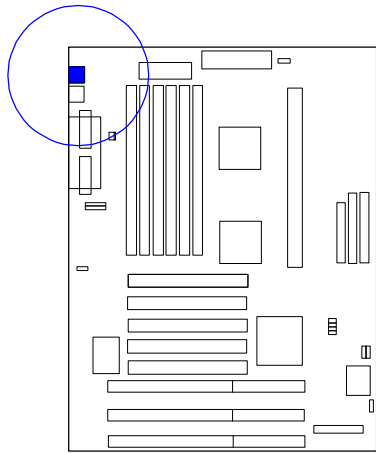

PS/2 Mouse Connector: PS2_MS

This connector is connected to the PS/2 mouse.

Standard Power Connector: AT_PWR

This 12-pin block connector is used for connecting to the standard 5V power supply. In the picture below, notice that, in most cases, there are two marks “P8” and “P9” on the surface of the connector. You have to insert the “P8” plug into the “P8” section of the connector, and so forth for “P9”. Two black wires must be in the middle.

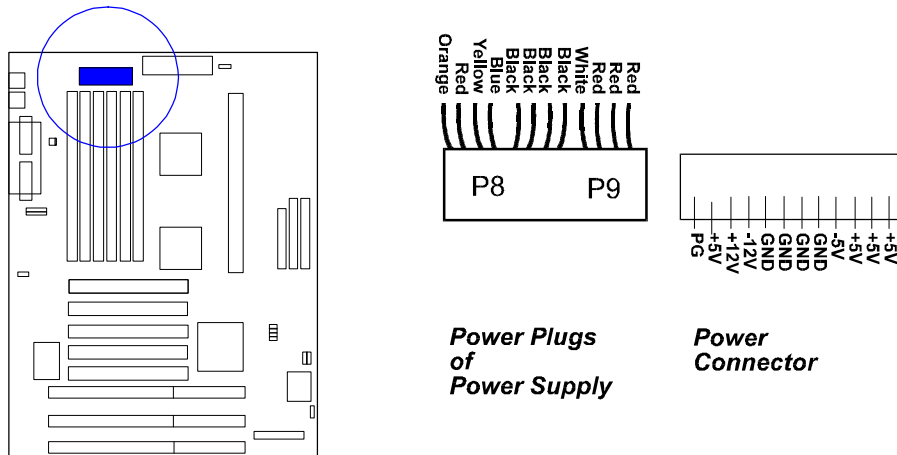

IDE HDD Device Connector: PRIMARY, SECONDARY

These two 40-pin block connectors are used for your IDE hard disks. If you have one IDE hard disk, connect it to the PRIMARY connector using the IDE HDD flat cable provided with the mainboard. If you want to install another IDE hard disk or CD-ROM, please use the SECONDARY connector.

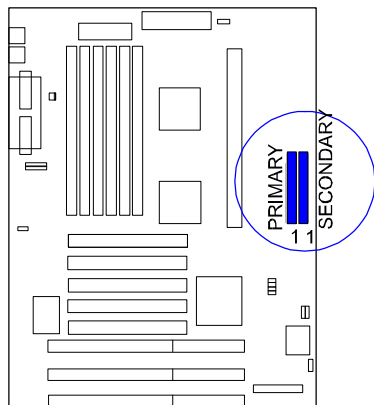

Printer Connector: PRINTER

This 25-pin D-Sub female connector is attached to your printer.

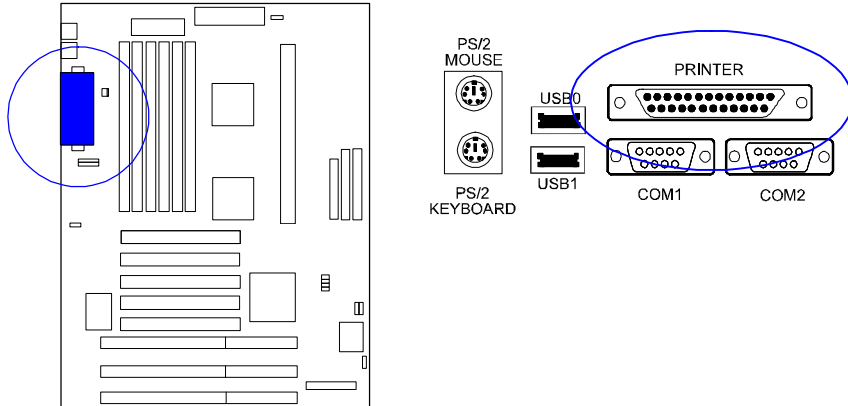

Remote Power Supply Connector: RPW_CON

This 3-pin male connector allows you to enable (or disable) the system power if the RPW_SW is on (or off).

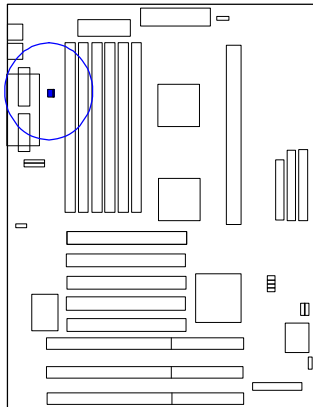

Universal Serial Bus Connectors: USB0, USB1

These two connectors are used for linking with USB peripheral devices.

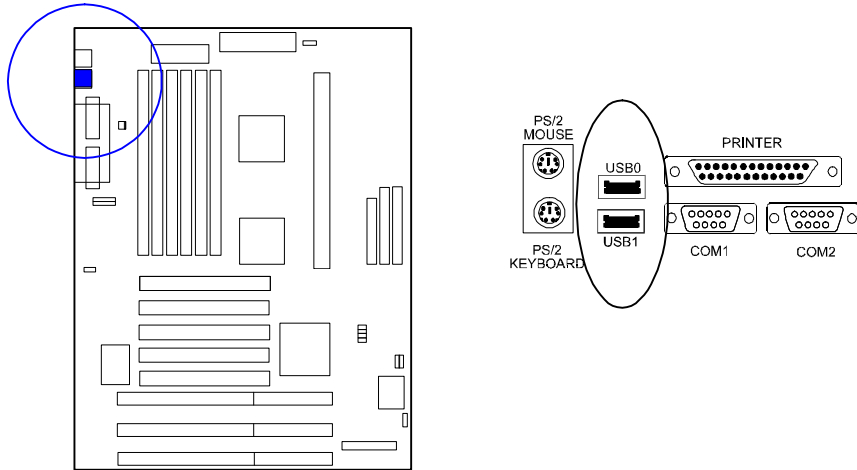

AMI BIOS Setup

The mainboard comes with an AMI BIOS chip that contains the ROM Setup information of your system. This chip serves as an interface between the processor and the rest of the mainboard's components. This chapter explains the information contained in the Setup program and tells you how to modify the settings according to your system configuration.

Main Setup

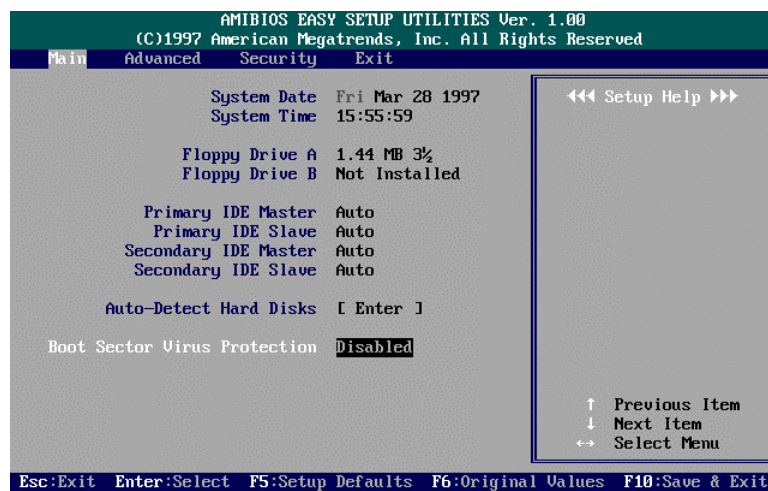

The Main Setup screen is displayed above. Each item may have one or more option settings. It allows you to change the system Date and Time, IDE hard disk, floppy disk drive types for drive A: and B:.

Auto-Detect Hard Disks

Allows the system BIOS to detect all hard disk parameters automatically.

Boot Sector Virus Protection

When Enabled, a warning will be given when any program or virus sends a Disk Format command or tries to write to the boot sector of a hard disk drive.

Advanced Setup

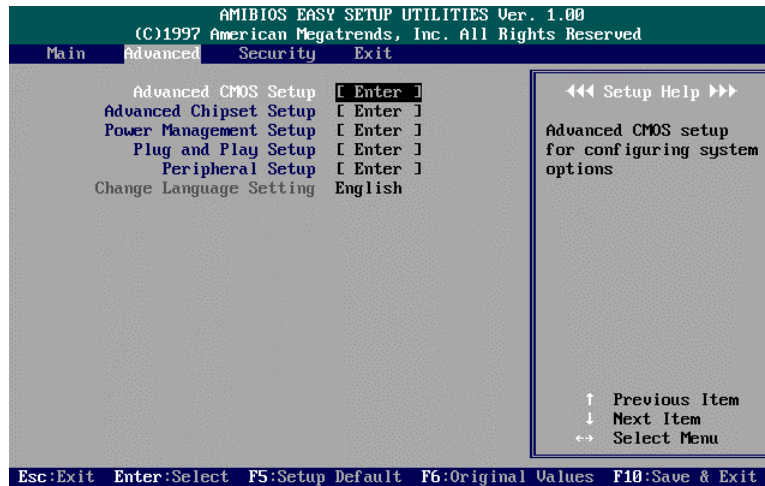

Advanced Setup options are displayed by choosing item from the AMI BIOS Setup main menu. All Advanced Setup options are described in this section.

Advanced CMOS Setup

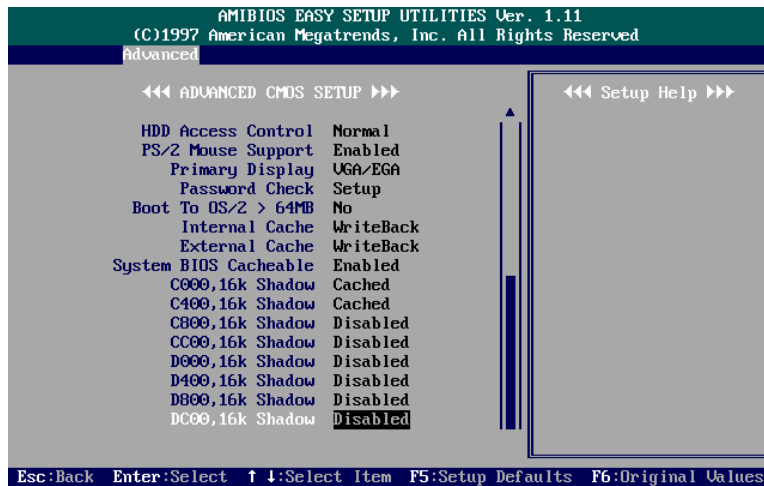
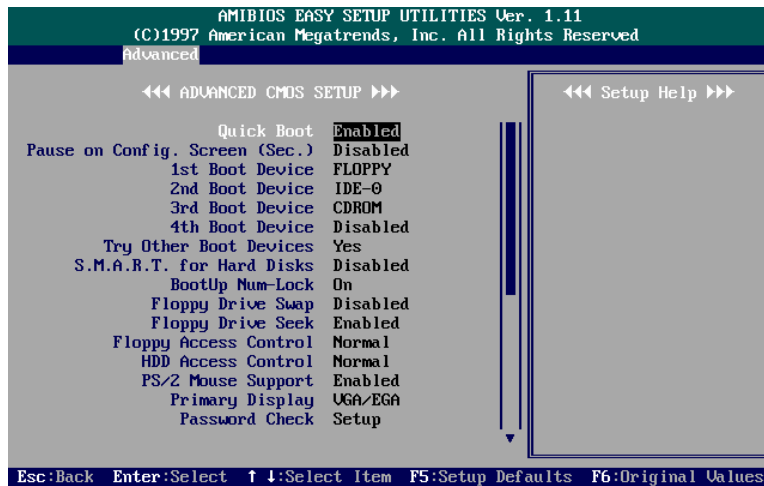

Quick Boot

Set this option to Enabled to instruct AMI BIOS to boot quickly when the computer is powered on. This option replaces the old 1MB Memory Test Advanced Setup option.

The settings are Disabled or Enabled. The default setting is Disabled.

Pause on Config. Screen (Sec.)

This option specifies the length of the period of the configuration screen when the system boots up.

The settings are 2, 3, 4, 5, 6, 7, 8, 9, 10, 11, 12, 13, 14, 15 (seconds), or Disabled. The default setting is Disabled.

1st Boot Device

This item allows you to select the first drive for booting up the system.

The settings are Disabled, IDE-0, IDE-1, IDE-2, IDE-3, IDE-3, FLOPPY, FLOPTICAL, SCSI, or NETWORK. The default setting is FLOPPY.

2nd Boot Device

This item allows you to select the second drive for booting up the system.

The settings are Disabled, IDE-0, or FLOPTICAL. The default setting is IDE-0.

3rd Boot Device

This item allows you to select the third drive for booting up the system.

The settings are Disabled, FLOPTICAL, CDROM. The default setting is CDROM.

4th Boot Device

This item allows you to select the fourth drive for booting up the system.

The settings are Disabled or FLOPTICAL. The default setting is Disabled.

Try Other Boot Devices

If you select Yes, the BIOS will try to boot up the system from other boot devices if all selected boot devices failed to boot. If No selected, the BIOS will try to boot up the system from only the selected devices.

The settings are Yes or No. The default setting is Yes.

S.M.A.R.T. for Hard Disks

“S.M.A.R.T.” stands for “Self-Monitoring, Analysis and Reporting Technology”. To enable it will assist you in preventing some (but not all) system down time due to hard disk drive failure.

The settings are Disabled or Enabled. The default setting is Disabled.

BootUp Num-Lock

Set this option to Off to turn the Num Lock key off when the computer is booted so you can use the arrow keys on both the numeric keypad and the keyboard.

The settings are On or Off. The default setting is On.

Floppy Drive Swap

Set this option to Enabled to permit drives A: and B: to be swapped.

The settings are Disabled or Enabled. The default setting is Disabled.

Floppy Drive Seek

Set this option to Enabled to specify that floppy drive A: will perform a Seek operation at system boot.

The settings are Disabled or Enabled. The default setting is Enabled.

Floppy Access Control

It is effective only if the floppy diskette drive is accessed through BIOS INT40H function.

The settings are Normal or Read Only. The default setting is Normal.

HDD Access Control

It is effective only if the hard disk drive is accessed through BIOS INT40H function.

The settings are Normal or Read Only. The default setting is Normal.

PS/2 Mouse Support

When this option is set to Enabled, AMI BIOS supports a PS/2-type mouse.

The settings are Enabled or Disabled. The default setting is Enabled.

Primary Display

This option specifies the type of display monitor and adapter in the computer.

The settings are Absent, VGA/EGA, CGA40x25, CGA80x25, or Mono. The default setting is VGA/EGA.

Password Check

This option enables password checking every time the computer is powered on or every time AMI BIOS Setup is executed. If Always is chosen, a user password prompt appears every time the computer is turned on.

If Setup is chosen, the password prompt appears if AMI BIOS is executed. The settings are Setup or Always. The default setting is Setup.

Boot To OS/2 > 64MB

This item allows you to enable the system BIOS to run with the IBM OS/2 operating system.

The settings are Yes or No. The default setting is No.

Internal Cache

This option specifies the caching algorithm used for L1 internal cache memory. If Disabled is selected, L1 is disabled. If WriteThru is selected, use the write-through caching algorithm. If WriteBack is selected, use the write-back caching algorithm.

The settings are Disabled, WriteBack, or WriteThru. The default setting is WriteBack.

External Cache

This feature allows you to disable the external cache function.

The settings are Disabled or Write Back. The default setting is Write Back.

System BIOS Cacheable

Enable it to allow the contents of the F0000h system memory segment to be read from or written to the L2 cache memory. The contents of the F0000h memory segment are always copied from the BIOS ROM to system RAM for faster execution.

The settings are Disabled or Enabled. The default setting is Enabled.

C000,16K Shadow; C400,16K Shadow;
C800,16K Shadow; CC00,16K Shadow;
D000,16K Shadow; D400,16K Shadow;
D800,16K Shadow; DC00,16K Shadow

These options control the location of the contents of the ROM beginning at the specified memory location. If no adapter ROM is using the named ROM area, this area is made available to the local bus.

[Disabled] The video ROM is not copied to RAM. The contents of the video ROM cannot be read from or written to cache memory.

[Enabled] The contents of C0000h - DC00h are written to the same address in system memory (RAM) for faster execution.

[Cached] The contents of the named ROM area are written to the same address in system memory (RAM) for faster execution, if an adapter ROM will be using the named ROM area. Also, the contents of the RAM area can be read from and written to cache memory.

The settings are Disabled, Enabled, Cached. The default setting of “C000, 16K Shadow; C400, 16K Shadow” is Cached; the others are Disabled.

Advanced Chipset Setup

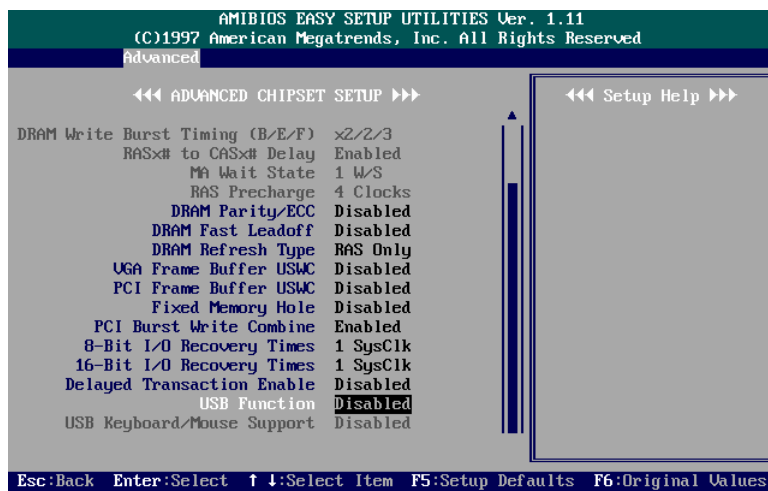
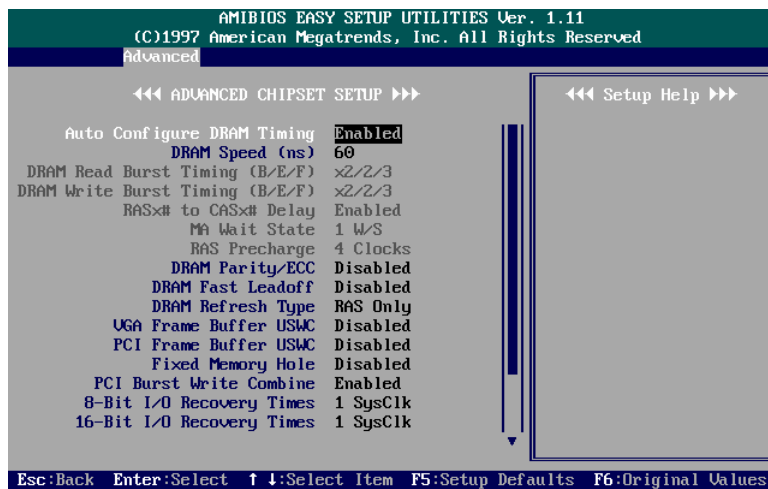

Auto Configure DRAM Timing

When set at Disabled, it allows you to configure the features that from the second one (DRAM Read Burst Timing) to the sixth one (RAS Precharge). The settings are Disabled, Enabled. The default setting is Enabled.

DRAM Speed

This item allows you to select the DRAM speed.
The settings are Manual, 60ns, or 70ns. The default setting is 60ns.

DRAM Read Burst Timing (E/F)

When Auto Configure DRAM Timing set at Disabled, allows you to define the DRAM read burst timing.
The settings are x3/4/4, x2/3/4, x2/2/3. The default setting is x2/2/3, depends on the CPU frequency and DRAM type.

DRAM Write Burst Timing (E/F)

When Auto Configure DRAM Timing set at Disabled, allows you to define the DRAM write burst timing.
The settings are x4/4/4, x3/3/4, x3/3/3, or x2/2/3. The default setting is x2/2/3, depends on the CPU frequency and DRAM type.

RAS# to CAS# Delay

When Auto Configure DRAM Timing set at Disabled, allows you to define the delay time that from the DRAM RAS# active to CAS# active.
The settings are Disabled or Enabled. The default setting is Enabled, depends on the CPU frequency and DRAM type.

MA Wait State

Allows you to select the memory address wait state.
The settings are 0 W/S, or 1W/S. The default setting is 1 W/S.

RAS Precharge

Allows you to select the DRAM RAS# Precharge Time.
The settings are 4 Clocks, or 3 Clocks, . The default setting is 4 Clocks.

DRAM Parity ECC

Allows you to select the DRAM data integrity mode: ECC (Error checking /generation and correction) or Parity (Parity generation and checking).
The settings are Disabled, Parity, or ECC. The default setting is Disabled.

DRAM Fast Lead off

Allows you to define the ratio of the DRAM read/write leadoff timing, RAS# precharge time, and refresh RAS# assertion.

The settings are Disabled or Enabled. The default setting is Disabled.

DRAM Refresh Type

Allows you to select the DRAM refresh type: RAS only or CAS before RAS.

The settings are CAS/RAS or RAS Only. The default setting is RAS Only.

VGA Frame Buffer USWC

Allows you to enable or disable the VGA frame buffer cacheable. When set at Enabled, the VGA frame buffer A000-BFFF will set to USWC cache type and improve VGA performance.

The settings are Enabled or Disabled. The default setting is Disabled.

PCI Frame Buffer USWC

Allows you to enabled or disable PCI VGA frame buffer cacheable. When set at Enabled, the PCI frame buffer address got from PCI configuration space (offset 10h) will set the USWC cache type and improve VGA performance.

The settings are Enabled or Disabled. The default setting is Disabled.

Fixed Memory Hole

When enabled, the memory hole at 15MB address will be relocated to the 15~16MB address range of the ISA cycle when the processor accesses the 15~16MB address area.

When Disabled, the memory hole at the 15MB address will be treated as a DRAM cycle when the processor accesses the 15~16MB address area.

The settings are Disabled, 512KB-640KB, or 15MB-16MB. The default setting is Disabled.

PCI Burst Write Combine

When enabled, allows the PCI cycle to achieve a higher performance.

The settings are Disabled or Enabled. The default setting is Disabled.

8-Bit I/O Recovery Times

This option specifies the length the delay (in SYSCLKs) inserted between consecutive 8-bit I/O operations.

The settings are Disabled, 1, 2, 3, 4, 5, 6, 7, and 8 SYSCLK. The default setting is 1 SYSCLK.

16-Bit I/O Recovery Times

This option specifies the length the delay (in SYSCLKs) inserted between consecutive 16-bit I/O operations.

The settings are Disabled, 1, 2, 3, and 4 SYSCLK. The default setting is 1 SYSCLK.

Delayed Transaction Enabled

Enable this feature to abort the current CPI master cycle and to accept the new PCI master request, it reaccepts the original PCI master and returns the PCI data phase to the original PCI master. It will enhance the system performance.

The options are Disabled or Enabled. The default setting is Disabled.

USB Function

This option allows you to enable the Universal Serial Bus (USB) feature. The settings are Disabled or Enabled. The default setting is Disabled.

USB Keyboard/Mouse Support

If you use a USB keyboard/mouse, set at Enabled. Otherwise, keep it disabled. When enabled, allows the BIOS to detect and initiate the USB keyboard/mouse for making the keyfunctions of POST to work.

The settings are Disabled or Enabled. The default setting is Disabled.

Power Management Setup

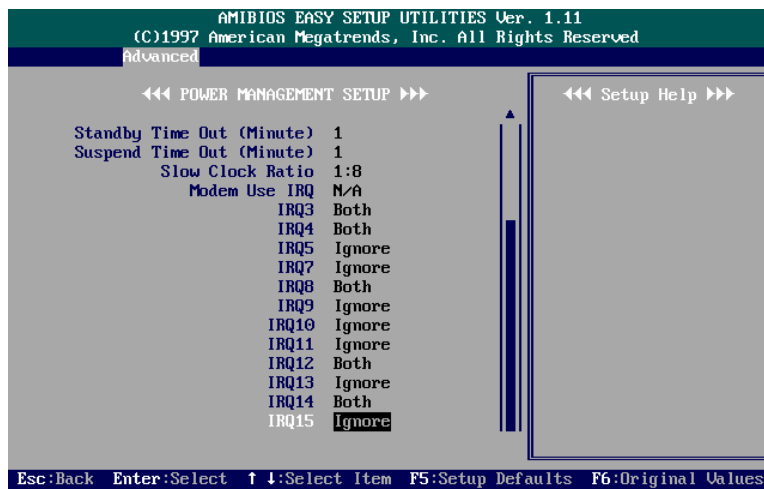
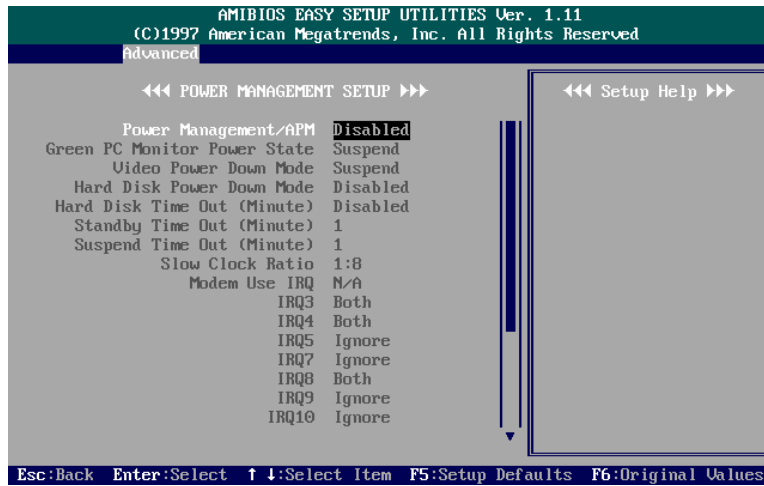

Power Management/APM

Set this option to Enabled to enable the power management and APM (Advanced Power Management) features.

The settings are Enabled or Disabled. The default setting is Disabled.

Green PC Monitor Power State

Specifies the power management state that the Green PC-compliant video monitor enters after the specified period of system inactivity has expired. The settings are Suspend, Off, Blank, or Standby. The default setting is Suspend.

Video Power Down Mode

This option specifies the power management state that the video subsystem enters after the specified period of system inactivity has expired.

The settings are Disabled, Standby, or Suspend. The default setting is Suspend.

Hard Disk Power Down Mode

This option specifies the power management state that the hard disk drive enters after the specified period of system inactivity has expired.

The settings are Disabled, Standby, or Suspend. The default setting is Disabled.

Hard Disk Time Out (Minute)

This option specifies the length of a period of hard disk inactivity. When this period expires, the hard disk drive enters the power-conserving mode specified in the Hard Disk Power Down Mode option described above.

The settings are Disabled, 1 Min (minutes), and all one minute intervals up to and including 15 Min. The default setting is Disabled.

Standby Time Out (Minute)

This option specifies the length of the period of system inactivity when the computer is in Full-On mode before the computer is placed in Standby mode. In Standby mode, some power use is curtailed.

The settings are Disabled, 1 Min, 2 Min, and all one minute intervals up to and including 15 Min. The default setting is 1 Min.

Suspend Time Out (Minute)

This option specifies the length of the period of system inactivity when the computer is already in Standby mode before the computer is placed in Suspend mode. In Suspend mode, nearly all power use is curtailed.

The settings are Disabled, 1 Min, 2 Min, and all one minute intervals up to and including 15 Min. The default setting is 1 Min.

Slow Clock Ratio

This option specifies the speed at which the system clock runs in power saving modes. The settings are expressed as a ratio between the normal clock speed and the power down clock speed.

The settings are 1:1, 1:2 (half as fast as normal), 1:4 (the normal speed), 1:8, 1:16, 1:32, 1:64, or 1:128. The default setting is 1:8.

Modem Use IRQ

This feature allows you to select the IRQ# of the system that is the same IRQ# as the modem use.

The options are: NA (Default), 3, 4, 5, 7, 9, 10, 11.

IRQ 3, 4, 5, 7, 8, 9, 10, 11, 12, 13, 14, 15

These options enable event monitoring. When the computer is in a power saving mode, activity on the named interrupt request line is monitored by AMI BIOS. When any activity occurs, the computer enters Full On mode. Each of these options can be set to Monitor or Ignore.

The settings are Ignore, Monitor, Wakeup, or Both.

The default settings for IRQ 3, 4, 12, 14, 15 is Both.

The default setting for IRQ 5, 7, 8, 9, 10, 11, 13 is Ignore.

Plug and Play Setup

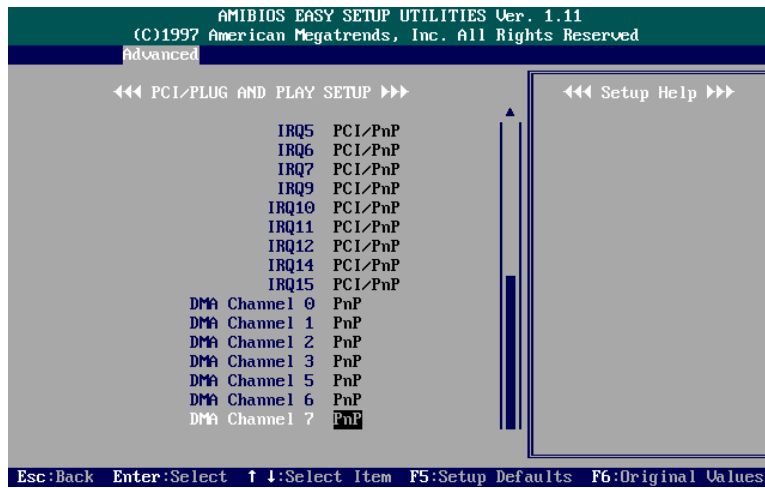
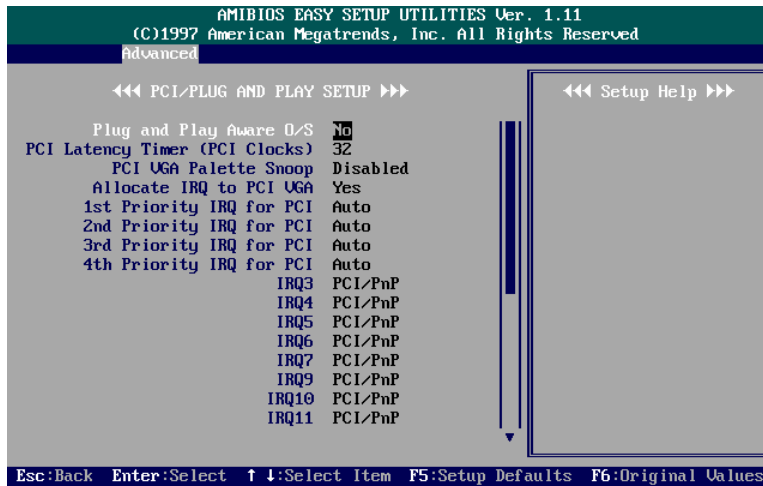

Plug and Play Aware O/S

Set this option to Yes if the operating system installed in the computer is Plug and Play-aware. AMI BIOS only detects and enables PnP ISA adapter cards that are required for system boot. The Windows 95 operating system detects and enables all other PnP-aware adapter cards. Windows 95 is PnP-aware. Set this option to No if the operating system (such as DOS, OS/2, Windows 3.x) does not support PnP. You must set this option correctly or PnP-aware adapter cards installed in your computer will not be configured properly.

The settings are No or Yes. The default setting is No.

PCI Latency Timer (PCI Clocks)

This option sets latency of all PCI devices on the PCI bus. The settings are in units equal to PCI clocks.

The settings are 32, 64, 96, 128, 160, 192, 224, or 248. The default setting is 32.

PCI VGA Palette Snoop

This option must be set to Enabled if any ISA adapter card installed in the computer requires VGA palette snooping.

The settings are Disabled or Enabled. The default setting is Disabled.

Allocate IRQ to PCI VGA

When set at Yes, allows the system to keep the ESCD (Extended System Configuration Data).

The settings are No or Yes. The default setting is No.

[IRQ3, 4, 5, 6, 7, 9, 10, 11, 12, 14, 15](#)

These options specify the bus that the named interrupt request lines (IRQs) are used on. These options allow you to specify IRQs for use by legacy ISA adapter cards. These options determine if AMI BIOS should remove an IRQ from the pool of available IRQs passed to BIOS configurable devices. The available IRQ pool is determined by reading the ESCD NVRAM. If more IRQs must be removed from the pool, the end user can use these PCI/PnP Setup options to remove the IRQ by assigning the option to the ISA/EISA setting. Onboard I/O is configurable by AMI BIOS. The IRQs used by onboard I/O are configured as PCI/PnP.

The settings are PCI/PnP or ISA/EISA. The default setting is PCI/PnP, except that the default setting for IRQ12 is ISA/EISA.

[DMA Channel 0, 1, 2, 3, 5, 6, 7](#)

This option allows you to specify the bus type that the named DMA channels are used on.

The settings are PCI/PnP or ISA/EISA. The default setting is PCI/PnP.

Peripheral Setup

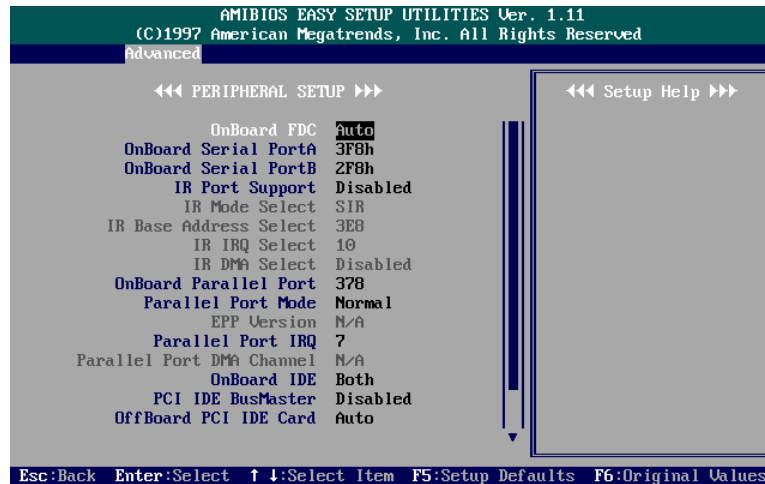

Onboard FDC

This option enables the floppy drive controller on the mainboard.
The settings are Auto, Enabled, or Disabled. The default setting is Auto.

Onboard Serial PortA

This option enables serial port 1 on the mainboard and specifies the base I/O port address for serial port 1.
The settings are 3F8h, 2F8h, 3E8h, 2E8h, Auto, or Disabled. The default setting is 3F8h.

Onboard Serial PortB

This option enables serial port 2 on the mainboard and specifies the base I/O port address for serial port 2.
The settings are 3F8h, 2F8h, 3E8h, 2E8h, Auto, or Disabled. The default setting is 2F8h.

IR Mode Support

This option allows you to set the IR port that the second serial port is working in.
The settings are Disabled or Enabled. The default setting is Disabled.

IR Mode Select

This options allow you to select the IR modes.
The settings are SIR, ASKIR, FIR, or SIR. The default setting is SIR.

IR Base Address Select

This options allow you to select the IR address.
The settings are 3E0, 2E0, 3E8, or 2E8. The default setting is 3E8.

IR IRQ Select

This options allow you to select the IR IRQ.
The settings are 3, 4, 10, 11. The default setting is 10.

IR DMA Select

This options allow you to select the IR DMA.
The settings are Disabled, 0, 1, 3. The default setting is Disabled.

Onboard Parallel Port

This option enables the parallel port on the mainboard and specifies the parallel port base I/O port address.
The settings are 378h, 278h, 3BCh, Auto, or Disabled. The default setting is Auto.

Parallel Port Mode

This option allows you to select the mode of the parallel port. The settings are Normal, Bi-Dir, EPP, or ECP. The default setting is Normal.

EPP Version

This option allows you to select the EPP version.
The settings are 1.9, 1.7. The default setting is 1.9.

Parallel Port IRQ

This option allows you to select the IRQ of the parallel port. The settings are 5 or 7. The default setting is 7.

Parallel Port DMA Channel

This option allows you to select the DMA channel of the parallel port. The settings are 0, 1, or 3. The default setting is 3.

Onboard IDE

Set this option to Enabled to specify that the IDE controller on the PCI local bus has bus mastering capability.

The settings are Disabled or Enabled. The default setting is Disabled.

OffBoard PCI IDE Card

The option specifies if an offboard PCI IDE controller adapter card is used in the computer. You must also specify the PCI slot on the mainboard where the offboard PCI IDE controller card is installed. If an offboard PCI IDE controller is used, the onboard IDE controller on the mainboard is automatically disabled.

The settings are Auto, Slot1, Slot2, Slot3, or Slot4. The default setting is Auto.

If Auto is selected, AMI BIOS automatically determines the correct setting for this option.

OffBoard PCI IDE Primary IRQ

This options allow you to select the IRQ if you use an offboard primary PCI IDE card.

The settings are Disabled, INTA, INTB, INTC, INTD, Hardwired. The default setting is INTA.

OffBoard PCI IDE Secondary IRQ

This options allow you to select the IRQ if you use an offboard secondary PCI IDE card.

The settings are Disabled, INTA, INTB, INTC, INTD, Hardwired. The default setting is INTB.

Security Setup

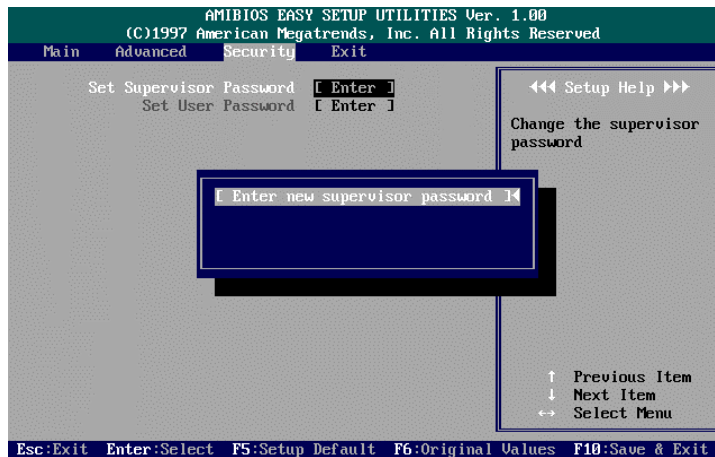

Set Supervisor and User Passwords

You can set either a Supervisor password or a User password. If you do not use a password, Just press **Enter** when the password prompt appears. The password check option is enabled in Advanced Setup by choosing either Always (the password prompt appears every time the system is powered on) or Setup (the password prompt appears only when AMI BIOS is run). You can enter a password by typing the password on the keyboard. When you select Supervisor or User, AMI BIOS prompts for a password. You must set the Supervisor password before you can set the User password. Enter a 1 to 6 character password. The password does not appear on the screen when typed.

Changing a Password

Enter the password and press **Enter**. After the new password is entered, retype the new password as prompted and press **Enter**. If the password confirmation is incorrect, an error message appears. If the new password is entered without error, press to return to the AMI BIOS Main Menu.

Clear Password

If you forget your password, turn off the system power first and remove the system unit cover. Locate Jumper CPW and cap it. Remove Jumper CPW and reset the system. At this point, you will not be asked for the password to enter Setup.

Exit Setup

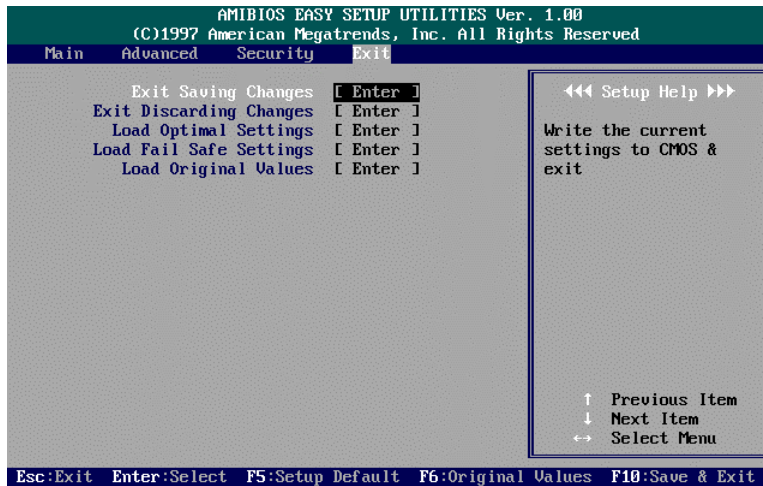

Exit Saving Changes

This item allows you to write the current settings to CMOS and exit.

Exit Discarding Changes

This item allows you to exit without writing the current settings to CMOS.

Load Optimal Settings

This item is selected for settings which provide the best system performance.

Load Fail Safe Settings

This item is for settings that provide a more efficient computer. If the computer will not boot, select this option and try to diagnose the problem after the computer boots. These settings do not give optimal performance.

Load Original Values

This item recalls your last set of previous settings. This option is convenient if you change settings and decide you wish to return to the previous settings.

DMI Utility

DMI (Desktop Management Interface) is a standard for organizing system configuration information. Using DMI, computer configuration can be made much simpler, quicker, and easier. Computer system configuration information can be read and modified from remote locations, permitting remote configuration and boot up.

The American Megatrends DMI Wizard is a DOS utility works with AMIBIOS, and all DMI-enabled versions of system BIOS. It can read the system BIOS file stored on the ROM file in the computer or it can read a user-supplied .ROM file; and can update the system BIOS ROM file (if the system BIOS is installed on a Flash EPROM in the computer) or it can update a user-supplied .ROM file.

NOTE : Duplicate the original diskette and use the backup one.

System Requirements

- at least 4 MB of system memory
- at least 384 KB of available DOS application memory space
- 2 MB of hard disk space
- AMIFlash Version 3.50 or later
- DOS Version 3.3 or later

Editing BIOS DMI Information

DMI Wizard allows anyone to edit DMI information that can be changed by the end user. If you use a mouse, use it in the same manner as you use a mouse with any Windows application. If you use keyboard, it will be similar to keyboard use in Windows applications. Press **Tab** to move between buttons and/or screen areas. Press **Enter** when a button is highlighted to perform the button's function. Press the arrow keys to navigate through lists. As with Windows programs, you cannot choose buttons that have been grayed out.

Installing DMI Wizard

To install DMI Wizard, please run the DMI Wizard INSTALL program, then perform the following steps:

1. Insert the DMI Wizard diskette in drive A: (or B:).
2. At the DOS prompt, type A: (or B:) INSTALL and press **Enter**.
3. Select the type of monitor that this computer has (color or monochrome).

4. Follow the instructions on the screen.

Starting DMI Wizard

After you have successfully installed DMI Wizard, type : **/DMIWIZ/DMIWIZ** to run the DMI Wizard.

The two DOS command line parameters are:

OEM : All DMI structures except BIOS structures can be edited and modified. All DMI information is displayed.

User (Default) : Only user-specific DMI information, such as type of system memory installed in the computer, can be edited. All DMI information can be displayed.

NOTE : Users are not encouraged to flash the BIOS file; since it may adversely affect system performance.

Main Screen Actions



From the DMI Wizard main screen, you can perform the following actions. As with Windows programs, you cannot choose buttons that have been grayed out.

Read BIOS From System ROM

Load the system BIOS from the computer where DMI Wizard is now running.

Password

Type a 1-6 character password to secure the BIOS file.

Flash & Update System BIOS

Update the system BIOS in the computer where DMI Wizard is now running.

Read BIOS ROM From File

Load the BIOS ROM file to be modified from disk.

Write BIOS ROM To File

Update the BIOS ROM file that you loaded from disk. You do not have to use the same filename. You can create a new ROM file.

Edit DMI Information

Choose this button if the DMI file is already loaded.

Exit

Quit DMI Wizard.

This Page Intentionally Left Blank

BIOS Update Instruction

Flash Process

The mainboard provides a Flash BIOS. If you have any question about the BIOS update, please contact your local dealer for more information. The following instructions apply when an upgrade is needed.

1. Create a Bootable Floppy (in DOS) -
with a non-formatted diskette, type **format a:/s**
With a formatted diskette, type **sys a:**
2. Download the BIOS File -
Download the correct BIOS file via FTP from the BIOS update section on the www.fic.com.tw website, by clicking on the file name of the BIOS you wish to download.

Save the BIOS file and the Flash Utility file in the boot disk you have created.

Unzip the BIOS file and the Flash Utility file.

There are two files after extraction: Flash BIOS utility, and BIOS file. Use the standard Flash BIOS utility, unless otherwise specified.

Place the bootable floppy disk containing the BIOS file and the Flash Utility in drive a:, and reboot the system in MS-DOS, preferably Ver. 6.22

At the A: > prompt, type the corresponding Flash BIOS utility and the BIOS file with its extension. For example, A:\>FLASH620 626HB106.ROM.

From **Flash EPROM Programming Utility** menu, press **Y** to **Press "Y" to Continue, "N" to Reboot**. The monitor will show the message **Please Wait....** . After the message **Flash EPROM Processing Successful** appears, press any key to reboot the system by loading the default values.

This Page Intentionally Left Blank