

MAINBOARD

User's Manual

Rev: 1.00

Date: April - 2000

- * All other product names are trademarks or copyrights of their respective owners.
- * Specifications and information contained in this manual are subject to change without notice.

FCC & DoC Compliance Statement

This device complies with Part 15 of the FCC rules, operation is subject to the following two conditions.

1. This device may not cause harmful interference and,
2. This device must accept any interference received, including interference that may cause undesired operation.

This equipment has been tested and found to comply with limits for a Class B digital device, pursuant to Part 15 of the FCC rules. These limits are designed to provide reasonable protection against harmful interference in residential installations. This equipment generates, uses, and can radiate radio frequency energy, and if not installed and used in accordance with the instructions, may cause harmful interface to radio communications. However, there is no guarantee that interference will not occur in a particular installation. If this equipment does cause interference to radio or television equipment reception, which can be determined by turning the equipment off and on, the user is encouraged to try to correct the interference by one or more of the following measures:

- Reorient or relocate the receiving antenna.
- Move the equipment away from the receiver.
- Plug the equipment into an outlet on a circuit different from that to which the receiver is connected.
- Consult the dealer or an experienced radio/television technician for additional suggestions.

The FCC requires the user to be notified that any change or modifications to the equipment by the user not expressly approved by the grantee or manufacturer could void the user's authority to operate such equipment. The use of shielded cables for connection of the monitor to the graphics card is required to assure compliance with FCC regulations.



Package Checklist

Your mainboard package should include the items listed below. Damaged or missing items should be reported to your vendor.

- ☑ The mainboard
- ☑ Floppy disk ribbon cable for 3.5" floppy drive
- ☑ 80 pin IDE ribbon cable for internal ATA66 or ATA33 IDE drive (Note: The 80pin ribbon cable is designed with a 40pin connector.)
- ☑ This User's Manual
- ☑ Support CD-ROM containing the following support software:
(The latest drivers can always be found at their respective web sites.)
 - VIA[®] PCI Bridge driver,
 - VIA VxD driver,
<http://www.via.com.tw/drivers>
 - Support software for updating the FLASH BIOS
 - Trend[®] PC-cillin Anti-Virus software
<http://www.antivirus.com>

Table of Contents

1. INTRODUCTION	6
1.1 Product Description	6
1.2 Features & Specifications	7
1.3 Board Level Feature	8
1.3.1 Board Level Part Definitions	9
1.4 Comprehensive Mainboard View	10
2. HARDWARE INSTALLATION	11
2.1 Jumper Setting	11
2.1.1 Setting the Jumpers	11
2.1.2 Keyboard Power-on Jumper	12
2.1.3 Flash BIOS Write Protect/Enable	12
2.1.4 Clear CMOS	13
2.1.5 SUS Power	13
2.1.6 AC97/MC97 Mode Selection Jumper	14
2.2 Connections	15
2.2.1 Installing the CPU	15
2.2.2 Cooling Fan	16
2.2.3 Installing the Memory Modules (DIMM)	17
2.2.4 Floppy, IDE Hard and CD-ROMs Drives	18
2.2.5 Power LED Connections	19
2.2.6 Power Supply Connector	20
2.2.7 IrDA-Compliant Infrared Module Connector	20
2.2.8 LAN Wake-up Connector	21
2.2.9 Modem Wake-up Function	21
2.2.10 External Connectors	22
2.2.11 Installing an AGP Card	24
2.2.12 Installing an AMR Card	24
3. MAINBOARD BIOS SETUP	25
3.1 About the BIOS	25
3.2 Main Menu	27
3.3 Standard CMOS Features	28
3.4 Advanced BIOS Features	32
3.5 Advanced Chipset Features	35
3.6 Integrated Peripherals	38

3.7	Power Management Setup	38
3.8	PnP/PCI Configurations	47
3.9	PC Health Status	50
3.10	Frequency / Voltage Control	51
3.11	Load Fail-Safe Defaults	52
3.12	Load Optimized Defaults.....	52
3.13	Supervisor Password and User Password Setting	52
3.14	Save & Exit Setup / Exit Without Saving	53
3.15	PCI Device Listing	54
4.	BUILT-IN SYMBIOS SCSI BIOS	55
5.	FLASH BIOS PROGRAMMING UTILITY	62
6.	DMI UTILITY	64
7.	INSTANTLY AVAILABLE PC	65
7.1	What is an Instantly Available PC?	65
7.2	Core Technology Suspend to RAM (S3)	65
7.3	The Key Ingredients	66
7.4	Installation	67
7.5	Using Suspend to RAM	68
7.6	Related Documents	69
8.	SOFTWARE INSTALLATION	70
8.1	Install Via PCI Bridge Driver	72
8.2	Install Via Vxd Driver	73
8.3	Install Sound Chip Driver (for On-Board Audio Only).....	74
8.4	Trend PC-Cillin Anti-Virus Software	75
8.5	Install Via Bus Master IDE Driver	77
8.6	Install Via Mini-port Driver	78
8.7	Hardware Monitoring Utility	79
8.8	Install ADOBE Acrobat Reader V 4.0	80

1. INTRODUCTION

1.1 Product Description

This mainboard represents the highest level of technology available in PC Mainboards today. Designed as a flexible, high-performance and cost-effective solution for System Integrators and End Users alike, this mainboard provides the power and expandability to meet the requirements of the most advanced operating systems and software applications.

This mainboard feature "SLOT A" architecture, a modular design that supports the latest high performance AMD Althon K7 (FSB 100/133MHz) system board that utilizes the VIA Apollo KX133 chipset on ATX Platform. Leading edge AGP 2X/4X graphic capability is provided for the full range of graphic intensive games and programs. The ATX form factore design allows for more efficient system assembly with built-in mouse, serial and parallel port connectors. This providing next generation features and great graphics performance at a lower cost.

Advanced hardware designs include ACPI's **Suspend to RAM** for the implementation of Instantly Available PCs. Also, by incorporating **AMR, 2X/4X AGP, AC97, Super I/O, Ultra DMA/66 Bus Mastering IDE** and **Universal Serial Bus (USB)** onto the mainboard, optimum system performance is assured and system design and implementation is simplified.

Fully **Plug & Play** compatible via an Award BIOS, this mainboard facilitates easy system configuration and peripheral setup. Advanced BIOS features include **Intelligent Hardware Monitoring and Alert functions**. The Award BIOS also supports **ACPI** readiness and is compatible with **Pc98** specification. This mainboard is the ideal foundation for high-end computer systems.

1.2 Specification

Processor	Slot A Athlon processors 500MHz to 1GHz														
Chipset	VIA [®] KX133 North Bridge : VT8371 South Bridge : VT82C686A														
BIOS	2MB Award [®] PCI BIOS, support ACPI, DMI, PnP Boot from CD-ROM, SCSI, LS-120, ZIP devices , Symbios [®] SCSI BIOS Anti-virus BIOS to prevent Boot-Virus														
System Memory	3 ` 168-pin DIMM Sockets up to 768 MB SDRAM Memory Support 32/64/128/256 MB Memory Module Support PC-100/PC-133 SDRAM Module														
On-board I/O Features	<p><i>Rear I/O Panel</i></p> <table> <tr> <td>1 ` PS/2 Mouse Port</td> <td>1 ` PS/2 Keyboard Port</td> </tr> <tr> <td>1 ` Parallel Port (EPP, ECP Port)</td> <td>2 ` USB Ports</td> </tr> <tr> <td>2 ` Serial Port (16550 UART)</td> <td>1 ` MIDI/Game Port</td> </tr> <tr> <td colspan="2">1 ` Audio Jacks: Line Out, Line In, and Mic. In</td> </tr> </table> <p><i>Standard I/O Feature</i></p> <table> <tr> <td>1 ` Floppy Port (Up to 2.88MB)</td> <td>2 ` IDE Hard Disk Port support up to 4 Hard drive</td> </tr> <tr> <td>1 ` IrDA TX/RX Header</td> <td></td> </tr> <tr> <td>2 ` USB Header</td> <td></td> </tr> </table>	1 ` PS/2 Mouse Port	1 ` PS/2 Keyboard Port	1 ` Parallel Port (EPP, ECP Port)	2 ` USB Ports	2 ` Serial Port (16550 UART)	1 ` MIDI/Game Port	1 ` Audio Jacks: Line Out, Line In, and Mic. In		1 ` Floppy Port (Up to 2.88MB)	2 ` IDE Hard Disk Port support up to 4 Hard drive	1 ` IrDA TX/RX Header		2 ` USB Header	
1 ` PS/2 Mouse Port	1 ` PS/2 Keyboard Port														
1 ` Parallel Port (EPP, ECP Port)	2 ` USB Ports														
2 ` Serial Port (16550 UART)	1 ` MIDI/Game Port														
1 ` Audio Jacks: Line Out, Line In, and Mic. In															
1 ` Floppy Port (Up to 2.88MB)	2 ` IDE Hard Disk Port support up to 4 Hard drive														
1 ` IrDA TX/RX Header															
2 ` USB Header															
Advanced Features	<ol style="list-style-type: none"> 4X AGP upgrade AC97 Audio on-board Modem Ring-in / Keyboard / Mouse Power On Wake Up On LAN / Modem Hardware Monitoring function (CPU temperature, CPU Fan, Voltage) PC-Cillin Anti-Virus Software Suspend to RAM (STR) to support "Instantly Available" PC Support AMR for MC97 modem upgrade 														
PCI Bus Master IDE	2 ` ATA33/66 IDE Ports Support up to 66MB/Sec.														
Expansion Slot	5 ` 32-bit PCI Bus Master Slots, 1 ` 16-bit ISA Slots, 1 ` 4X/2X AGP Slot, 1 AMR Slot														
ATX Power Connector	3V, 5V and 12V 20 Pin ATX Powerconnector.														
Switching VR	Switching Voltage Regulator to support 1.3V to 3.5V														
Form Factor	ATX Size (7.5" ` 12" or 190mm ` 305mm)														

Specifications are subject to change without notice. All brands and product names are trademarks of their respective companies.

INTRODUCTION

1.2 Board Level Feature

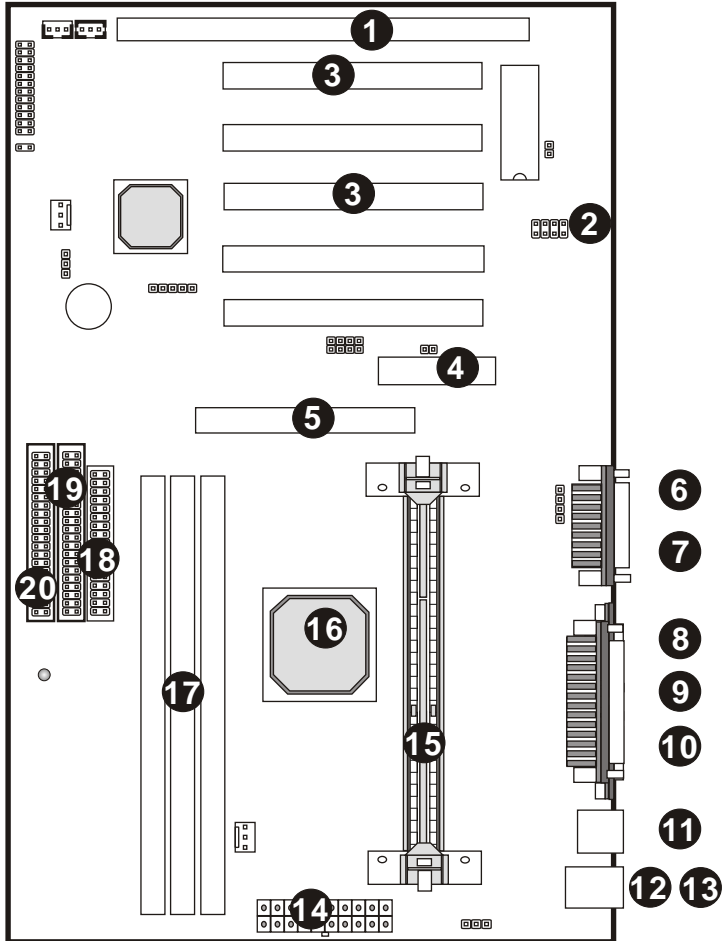

1.3.1 Board Level Part Definitions

- 1 **ISA Slot:** (1) 16-bit ISA slots.
- 2 **USB Header:** Connects to the USB bracket for (2) additional USB ports.
- 3 **PCI Slots:** (5) 32-bit PCI slots are provided.
- 4 **AMR Slot:** Audio Modem Riser (AMR) Connector.
- 5 **AGP Slot:** Accelerated Graphics Port (AGP).
- 6 **MIDI/Game Port:** 15-pin female MIDI/Joystick connector.
- 7 **Audio Port:** Three 1/8 female jacks for Line Out, Line In and MIC.
- 8 **COM2 Port:** COM2 can be directed to the Infrared Module for wireless connection capability.
- 9 **Printer Port:** EPP and ECP compatible 25-pin D-Sub parallel port.
- 10 **COM1 Port:** High-speed UART compatible serial port.
- 11 **USB Ports:** 2 USB Connectors.
- 12 **PS/2 Mouse Connector:** Supports PS/2 style mice.
- 13 **PS/2 Keyboard Connector:** Supports PS/2 style keyboards.
- 14 **Power Connector:** 20-Pin ATX Power Connector.
- 15 **CPU Slot:** Slot A for AMD Athlon processors 500MHz- 1GHz.
- 16 **VIA KX133 AGP set:** Features PC133 SDRAM, and AGP 2X or 4X support.
- 17 **DIMM Sockets:** (3) 168-pin DIMM sockets.
- 18 **Floppy Connector:** Built-in floppy controller supports (2) 5.25" or 3.5" floppy drives.
- 19 **Primary IDE Connector:** Connector for first IDE channel.
- 20 **Secondary IDE Connector:** Connector for second IDE channel.

INTRODUCTION

1.4 Comprehensive Mainboard View

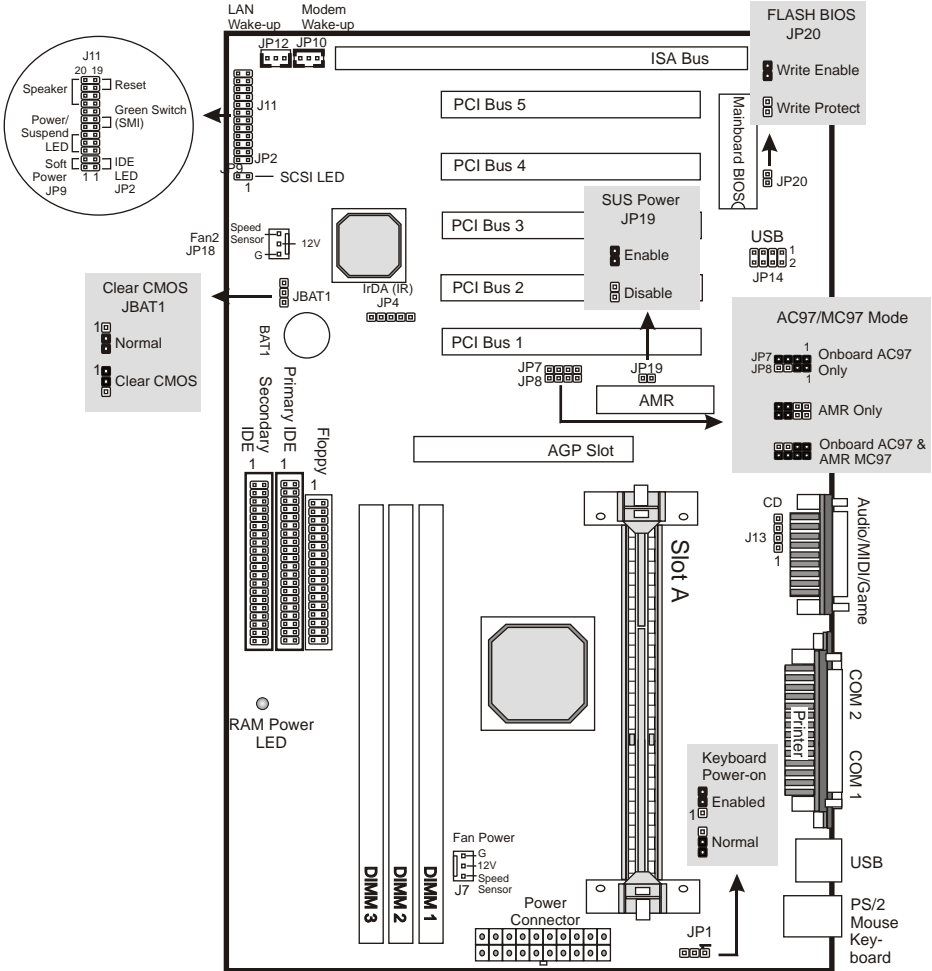

2. Hardware Installation

2.1 Jumpers Setting

Static Precautions

Static electricity can be a serious danger to the electronic components on this mainboard. To avoid damage caused by electrostatic discharge, observe the following precautions:

- ✓ Don't remove the mainboard from its anti-static packaging until you are ready to install it into a computer case. Also, handle add-in cards and modules by the edges or mounting bracket.
- ✓ Before you handle the mainboard in any way, touch a grounded, anti-static surface, such as an unpainted portion of the system chassis, for a few seconds to discharge any built-up static electricity.

2.1.1 Setting the Jumpers

Jumpers are used on this mainboard to select various settings and features. A 2-pin jumper has two settings: Open and Short (or Closed). The jumper is closed by placing the Jumper Cap across the two pins, thereby connecting them. 3-pin jumpers can be set to pins 1-2 or 2-3 connected. Pin-1 is labeled on the circuit board.

3-pin Jumper

Pin 1-2



Pin 2-3



2-pin Jumper

Open



Short





HAREWARE INSTALLATION

2.1.2 Keyboard Power-on Jumper (JP1)

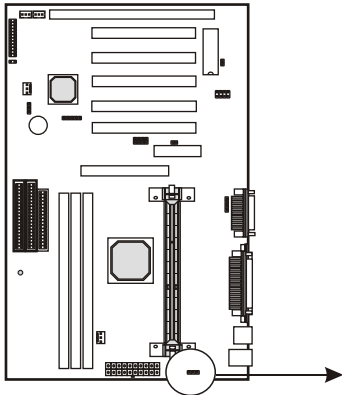
This feature will power on the system from the keyboard. In addition to the jumper setting, the **Wake up Events** in the **Power Management Setup** of the BIOS must be set properly also.



Keyboard Power-on
JP1



- 1
-  Normal
 -  KB Wake-up

2.1.3 Flash BIOS Write Protect/Enable (JP20)

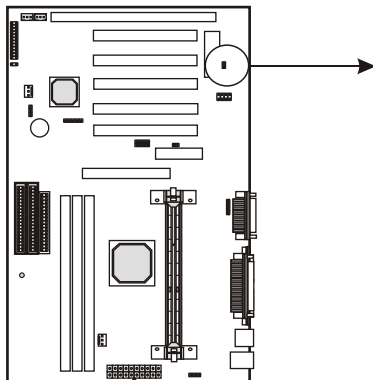
To re-program the mainboard BIOS, short this jumper to enable writing to the flash BIOS. Set to *Write Protect* to prevent writing to the flash BIOS.



Flash BIOS JP20

-  Write Protect
-  Write Enable

HARDWARE INSTALLATION

2.1.4 Clear CMOS (JBAT1)

If you have set the password, either to protect the BIOS configuration or to restrict access to the computer, the password is stored in CMOS RAM. If you forget the password, the CMOS can be cleared by setting this jumper to *Clear CMOS*. Also in case there is a CMOS error or improper CPU setting through the mainboard's BIOS that causes boot failure, the CMOS must be cleared by setting this jumper to *Clear CMOS* to allow the system to boot.

* Clearing the CMOS will clear all user-defined BIOS setup options.

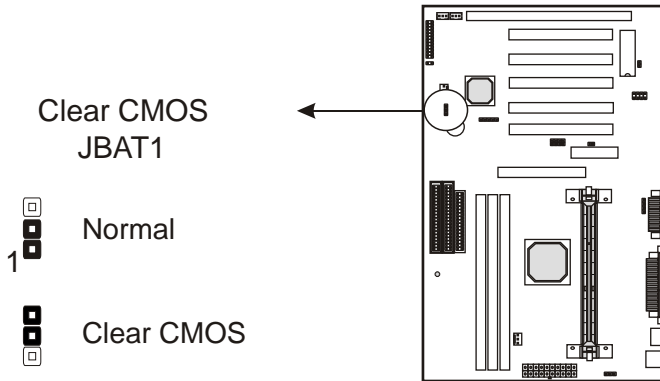

2.1.5 SUS Power (JP19)

Enabled this Jumper is to provided the 3.3V to PCI for STR function.

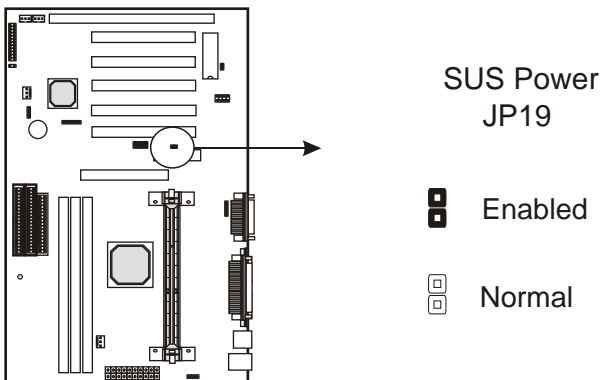

HAREWARE INSTALLATION

2.1.6 AC97/MC97 Mode Selection Jumper (JP7 & JP8)

Set this jumper block according to the audio/modem device(s) used:

- **Onboard AC97 Only:** When using the onboard AC97 audio and no AMR card.
- **AMR Only:** When using an AMR audio/modem add-on card and not the onboard AC97 audio.
- **Onboard AC97 & AMR MC97:** When using both the onboard AC97 audio and AMR modem (MC97) card.

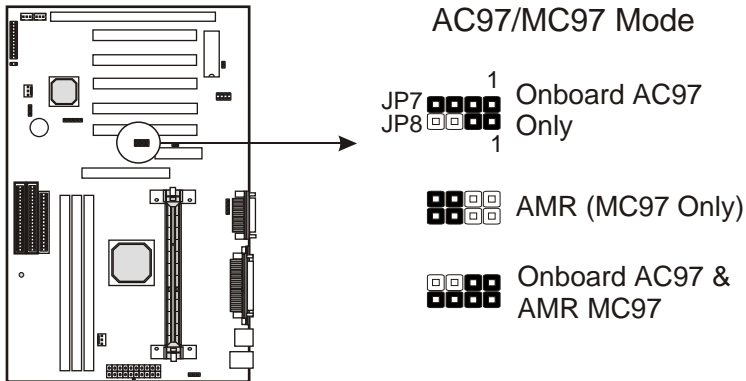

- ✘ To use the onboard AC97/MC97 support, also make sure the *AC97 Audio / AC97 Modem* option in the **Advanced Chipset Feature** of the mainboard BIOS is set to *Auto*.

HARDWARE INSTALLATION

2.2 Connections

Static Precautions

Static electricity can be a serious danger to the electronic components on this mainboard. To avoid damage caused by electrostatic discharge, observe the following precautions:

- ✓ Don't remove the mainboard from its anti-static packaging until you are ready to install it into a computer case. Also, handle add-in cards and modules by the edges or mounting bracket.
- ✓ Before you handle the mainboard in any way, touch a grounded, anti-static surface, such as an unpainted portion of the system chassis, for a few seconds to discharge any built-up static electricity.

2.2.1 Installing the CPU

You Mainboard features "SLOT A" architecture, a modular design that can accommodate the latest AMD K7 processors.

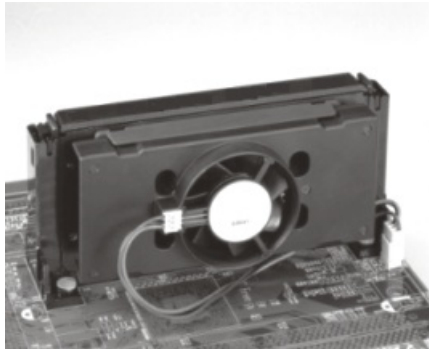

HAREWARE INSTALLATION

✓ **WARNING:** Use of a CPU Cooling Fan is required to prevent CPU from overheating. The Fan should be installed first before inserting the CPU into its Slot.

- 1 The CPU retention mechanism is already attached onboard. Before installing the CPU, simply unfold the retention mechanism to the upright position as shown below.
- 2 Slide the CPU down into the retention mechanism. Make sure the CPU is correctly oriented.
- 3 Seat the CPU firmly into the slot until the two tabs on the CPU click outwards to lock the CPU in place.

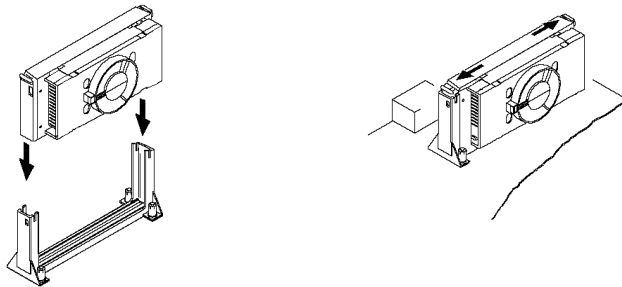

2.2.2 Cooling Fan

These are small 3-pin Header Connectors that provide 12-Volt power for CPU and chassis cooling fans. Plug in the fan cable to the connector. Pin-2 corresponds to the RED power lead as shown:

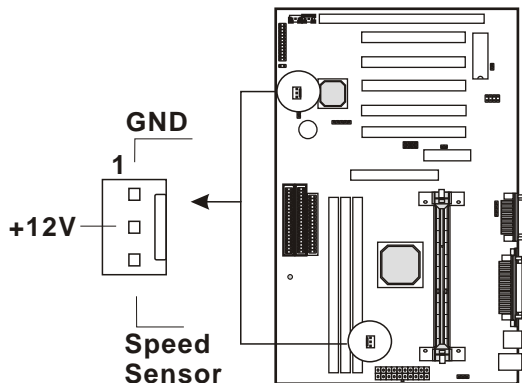

HARDWARE INSTALLATION

2.2.3 Installing the Memory Modules (DIMM)

- ✓ This mainboard has three sockets available for **168-pin DIMMs**. They must be 3.3 volt Unbuffered Synchronous DRAMs (SDRAM).
- ✓ DIMM Sizes supported: **32MB, 64MB, 128MB and 256MB**
- ✓ A total of **(3) DIMMs** can be installed for a maximum RAM capacity of **768MB**.

To insert the DIMMs, the modules must be oriented in the correct way. Notice the notches of the DIMM. Align these notches as shown in the diagram below. Gently push the DIMM until the retainers on both sides of the socket lock the module in place.

To remove a DIMM, push the retainers outwards to release the module then pull the module out of the socket.

Caution:

Before removing a DIMM, make sure the **RAM Power LED Indicator is off**. The blinking of the LED indicates that power is provided for the DRAM, as in normal operation as well as in Suspend to RAM mode. Removing a DIMM in the Suspend to RAM mode will result in loss of system context.

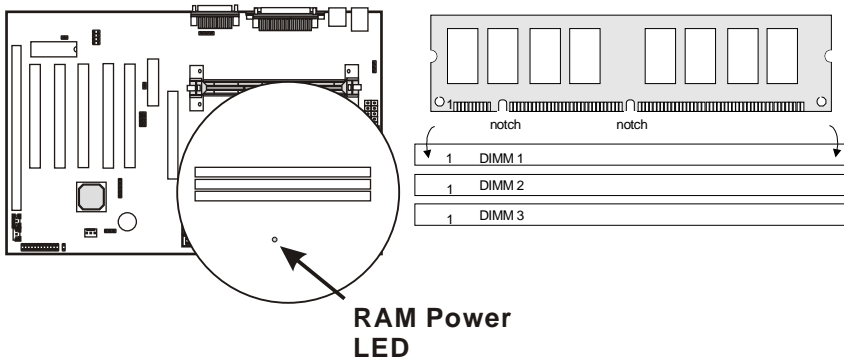

HAREWARE INSTALLATION

2.2.4 Floppy Drives

The on-board floppy controller supports (2) floppy disk drives with the floppy ribbon cable provided.

Note: Make sure the RED stripe on the ribbon cable is oriented towards Pin-1.

2.2.4 IDE Hard Drives and CD-ROMs

The on-board Enhanced IDE controller can support up to (4) IDE hard drives or other ATAPI devices, such as CD-ROMs. This controller, as with all Enhanced IDE controllers, consists of both Primary and Secondary ports. Each port has an associated connector and cable which can support up to (2) ATAPI devices each.

Note: Make sure to align the RED stripe on the ribbon cable with Pin-1 on the mainboard IDE connector. On most hard drives and CD-ROMs, the RED stripe should be oriented towards the power connector of the device

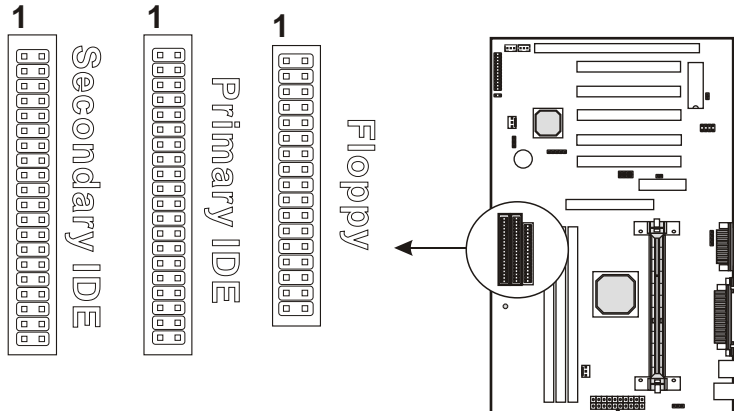

HARDWARE INSTALLATION

2.2.5 Power LED Connections

System Function Connector Block (J11)

Pins [7 & 9] SMI suspend switchlead - If your system's case has a suspend switch, hook the lead from the switch to pins 7 & 9. For this switch to be functional, it must first be enabled in the Power Management Setup in the BIOS Setup utility.

Pins [17 & 19] Reset switch lead - Connects to the Reset Switch lead from the system's case. The reset switch is used to cold-boot the system without actually turning off the power, reducing wear and tear on the power supply.

Pins [2 & 6] Power/Suspend LED lead Pins 2 & 6 connect to the power LED from the system's case. This LED blinks to indicate the system is in suspend mode.

Pins [14 & 20] Speaker connector - Connects to the Speaker lead from the system's case.

IDE Activity LED (JP2)

Hook the IDE LED lead to this connector, with the RED lead corresponding to Pin-1.

Soft Power Switch (JP9)

Connects to the Power Switch featured on ATX case designs. This switch must be hooked up before the system can be powered on.

*Note: Under the following two conditions, you have to press and hold the switch for longer than 4 seconds to power off your system, regardless of the **Soft-Off by PWRBTN** setting in the BIOS.*

- Shortly after the system is powered on, when the BIOS message is not yet appear.
- When CPU hangs.

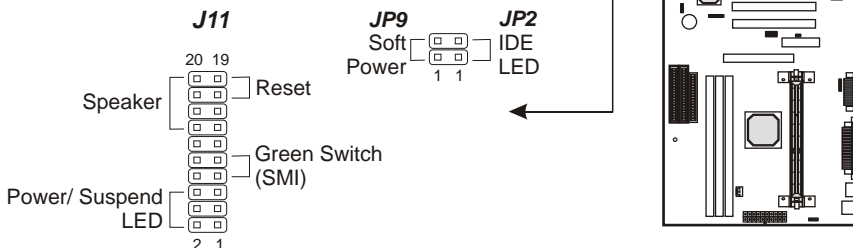

HAREWARE INSTALLATION

2.2.6 Power Supply Connector

The ATX-style Power Supply Connector is keyed to prevent connection in the wrong direction. Line up the locking mechanism on the connector from the Power Supply with the tab on the mainboard connector. Press down until the two connectors are locked.

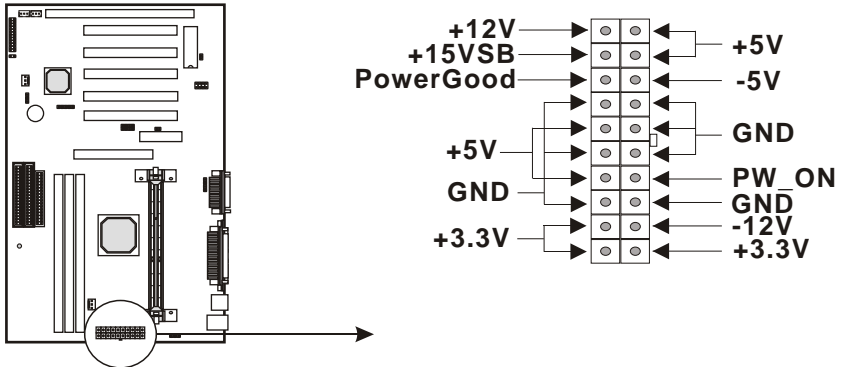

2.2.7 IrDA-Compliant Infrared Module Connector (JP4)

The IrDA connector bracket hooks directly to this connector on the mainboard. This connector provides support for the optional wireless transmitting and receiving infrared module. You must first configure through the BIOS setup where UART2 is directed, COM2 or IrDA.

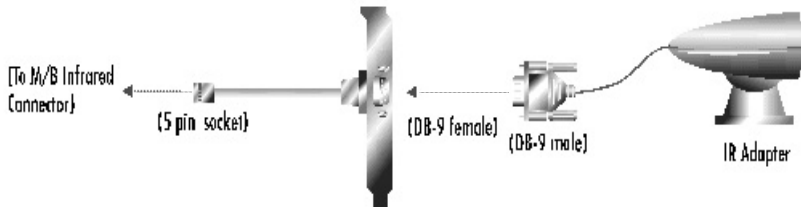
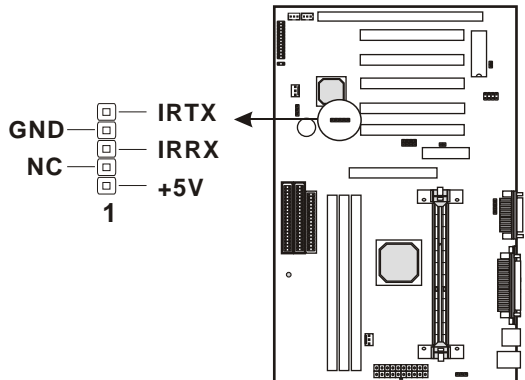

HARDWARE INSTALLATION

2.2.8 LAN Wake-up Connector (JP12)

The LAN Wake-up function will allow the network to wake up a Soft Power Down (Soft-Off) PC. However, if your system is in the Suspend mode, you can wake-up the system only through an IRQ or DMA interrupt. To use the LAN Wake-up function, you must enable the **Wake Up On LAN/Ring** field (under **Wake Up Events**) in the **Power Management Setup** of the Award BIOS. Connect the cable that comes with your LAN card to this connector on the system board. Refer to the add-in card's manual for details.

Note: Your LAN card must support Magic Packet in order to use the LAN Wake-up function.

2.2.9 Modem Wake-up Function (JP11)

The Modem Wake-up function allows the modem to remotely power on the system. Install an external modem (normally to COM2) and enable the **Wake Up On LAN/Ring** field (under **Wake Up Events**) function in the **Power Management Setup** from the BIOS.

For the function to work for an *internal modem card*, you must also connect the Modem Wake-up cable on the modem card to this Modem Wake-up function connector on the mainboard.

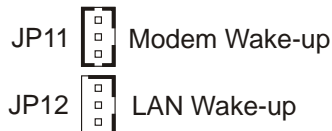
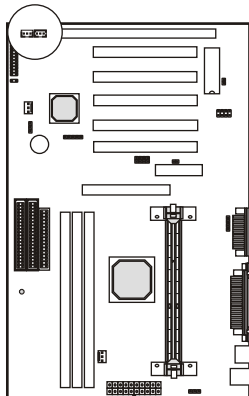

HAREWARE INSTALLATION

2.2.10 External Connectors

MIDI/Game Port (Optional)

You may plug a joystick or game pad to this (Gold color) 15-pin female connector for game playing, or connect a MIDI device for playing or editing audio.

Audio Port (Optional)

You can connect powered speakers or headphones to (Lime color) Line Out jack. Cassette players or other external audio sources can be connected to (Light Blue color) Line In jack. Plug in your microphones to (Pink color) MIC jack.

Note:

To use the on-board direct sound AC97 audio features, the AC97/MC97 Mode jumper block should be properly set (Refer to page 16). Also make sure the **AC97 Audio** option is set to *Auto* (default) in **Advanced Chipset Features** of the BIOS.

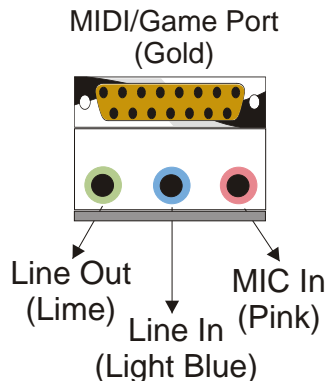

Audio Connectors (J13)

This CD Audio connector is available for connecting the CD-ROM drive using CD audio cable.

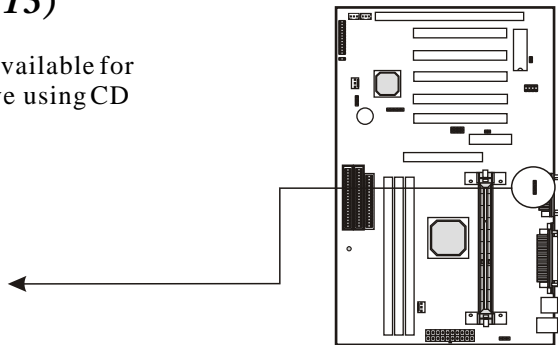

HARDWARE INSTALLATION

Serial and Parallel Ports

A (Burgundy color) 25-pin D-Sub header is provided on the back panel for a multi-mode bi-directional parallel port.

Two (Teal/Turquoise color) 9-pin D-Sub headers are also provided on the back panel for Serial ports.

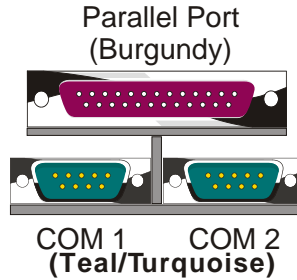

PS/2 Keyboard and Mouse Connectors

These two connectors (Green color) PS/2 Mouse and (Purple color) PS/2 Keyboard are located on the back panel of the mainboard.

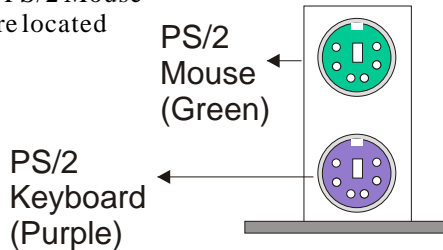

USB Connectors

This mainboard supports (Black color) 4 USB devices.

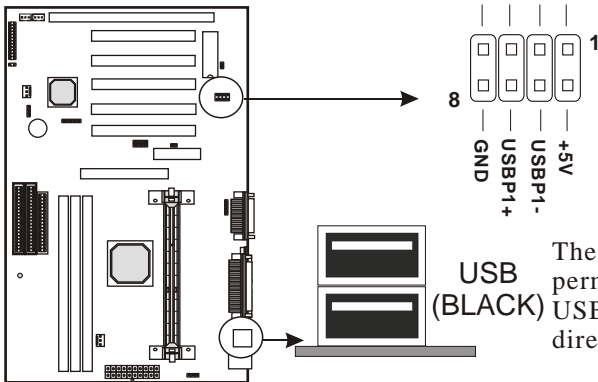

The Cable from the USB connector bracket hooks to the USB header on the mainboard.

These two connectors permit connection of two USB peripheral devices directly to the system.

HAREWARE INSTALLATION

2.2.11 Installing an AGP Card

The mainboard provides an AGP slot to support 2X or 4X AGPset with model shipped with the package.

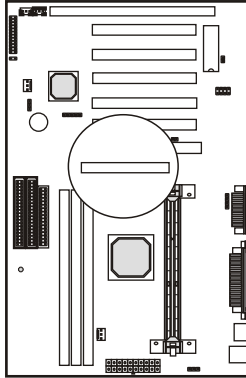

2.2.12 Installing an AMR Card

One AMR (**A**udio/**M**odem **R**iser) standard interface connector is supports Audio Codec 97 (AC97) and/or Modem Codec 97 (MC97) cards. This provides an upgradeable audio and/or modem solution at an incredibly low cost. There are two type of AMR, one defined as primary and another defined as secondary. This mainboard uses as primary channel so, a secondary AMR can coexist without the need to disable the onboard CODEC. The mainboard's onboard CODEC must be disable when using the primary AMR.

Note:

If your audio function is coming from the AMR card instead of the onboard audio feature, set AC97/MC97 Mode jumper block properly (Refer to page 16). Also make sure the **AC97 Audio** option is set to *Auto* (default) in **Advanced Chipset Features** of the BIOS.

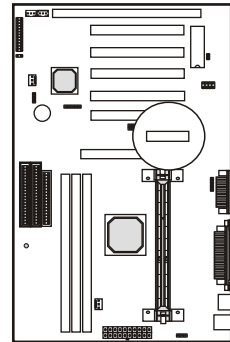

MAINBOARD BIOS SETUP

3. MAINBOARD BIOS SETUP

3.1 About the BIOS

The Mainboard BIOS (Basic Input/Output System) acts as the bridge between your Hardware (CPU, Disk Drives, Video, etc.) and Operating System Software (Windows 95, OS/2 and so on) The BIOS Setup (also called CMOS Setup) is where many hardware configuration options are set and stored. This configuration information will remain in the BIOS until it is changed, or cleared by removing the battery for a while then reinstalling it back or by setting the Clear CMOS jumper if there is one.

CMOS (Complementary Metal Oxide Semiconductor) refers to the chip in which the BIOS information is stored.

This mainboard features Award BIOS, which provides an easy to use Setup program to aid in hardware configuration. In this section we will look at the various menus and options contained in the Award BIOS Setup Program. This mainboard also features a Flash BIOS. A Flash BIOS can be upgraded via software, thereby eliminating the need to actually replace the BIOS Chip on the mainboard. Procedures for updating the BIOS follow this section.

The Award BIOS installed in your computer system's ROM (Read Only Memory) is a custom version of an industry standard BIOS. This means that it supports Intel processor in a standard IBM-AT compatible input/output system.

Using Setup

In general, you use the arrow keys to highlight items, <Enter> to select or display the possible selections, <PageUp> and <PageDown> keys to change entries, <F1> for general help and <Esc> to quit.

An item marked with a *i* indicates that there is a submenu for this item. A gray-out item marked with an *x* indicates that the item is not available. The item may be associated with another item and its availability is dependent on that associated item. Gray-out items are for information display only and contain no selectable fields.

MAINBOARD BIOS SETUP

Getting Help

Pressing <F1> will display a help window that describes the appropriate keys to use. Pressing <Enter> will display a small help window that describes the possible selections for the highlighted item. To exit the Help Window press <Esc>.

A brief description of some highlighted selection may appear at the right frame (titled Item Help) of the setup screen.

A Final Note about Setup

Not all systems have the same Setup. While the basic look and function of the Setup program remains the same for all systems, individual motherboard and chipset combinations require custom configurations. For example, you may find that your Setup main menu has a different number of entries from the main menu displayed in this manual. These are simply features not supported (or not user configurable) on your system.

The final appearance of the Setup program also depends on the Original Equipment Manufacturer (OEM) who built your system. If your OEM has decided that certain items should only be available to their technicians, those items may very well be removed from the Setup program.

MAINBOARD BIOS SETUP

3.2 Main Menu

Shortly after the system is powered on, provided a CPU and sufficient RAM are installed, you will see the message:

Press DEL to enter SETUP

- Press the **DEL** key to enter the Award BIOS Setup program.

Once you enter the Award BIOS CMOS Setup Utility, the Main Menu will appear on the screen. The Main Menu allows you to select from several setup functions and two exit choices. Use the arrow keys to select among the items and press <Enter> to accept and enter the sub-menu.

CMOS Setup Utility – Copyright (C) 1984-2000 Award Software

▶ Standard CMOS Features	▶ Frequency/Voltage Control
▶ Advanced BIOS Features	Load Fail-Safe Defaults
▶ Advanced Chipset Features	Load Optimized Defaults
▶ Integrated Peripherals	Set Supervisor Password
▶ Power Management Setup	Set User Password
▶ PnP / PCI Configurations	Save & Exit Setup
▶ PC Health Status	Exit Without Saving
Esc : Quit	- - ® - : Select Item
F10 : Save & Exit Setup	

Note that a brief description of each highlighted selection appears at the bottom of the screen.

MAINBOARD BIOS SETUP

3.3 Standard CMOS Features

This first menu is where the most basic hardware options are set. Information regarding the system clock, IDE hard disks and floppy drives is stored and configured in this section. To enter the Standard CMOS Features setup screen, press the [ENTER] key with this menu highlighted.

Upon entering the Standard CMOS Setup screen, you will see a screen like that below:

Date (mm:dd:yy)	Mon, Dec 18 2000	Item Help
Time (hh:mm:ss)	00 : 00 : 00	
▶ IDE Primary Master	Press Enter None	Menu Level ▶
▶ IDE Primary Slave	Press Enter None	
▶ IDE Secondary Master	Press Enter None	
▶ IDE Secondary Slave	Press Enter None	
Drive A	1.44M, 3.5 in.	
Drive B	None	
Video	EGA / VGA	
Halt On	All, But Keyboard	
Base Memory	640K	
Extended Memory	65472K	
Total Memory	1024K	

- : Move ® : Select +/-/PU/PD: Value F10: Save ESC: Exit F1: General Help
F5: Previous Values F6: Fail-Safe Defaults F7: Optimized Defaults

Date and Time

Use the arrow keys to move to and highlight the **Date** option. Select the Month by using the PgDn and PgUp keys. This is how most settings will be configured. Then, move to the day, year and time via the arrow keys to finish setting the system date and time.

IDE Primary Master, IDE Primary Slave, IDE Secondary Master, IDE Secondary Slave

These four options relate to the (4) IDE hard drives, CD-ROMs or other ATAPI devices that can be controlled via the on-board IDE controller (review IDE Hard Drives and CD-ROMs in the Installation Guide). The **IDE Primary Master** setting specifies the first device on the primary IDE channel, **IDE Primary Slave** - the second. **IDE Secondary Master** and **IDE Secondary Slave** specify the devices on the secondary channel.

MAINBOARD BIOS SETUP

Pressing <Enter> at each of the four selections brings up a submenu such as one shown below:

IDE HDD Auto-Detection	Press Enter	Item Help
IDE Primary Master	Auto	Menu Level ▶▶
Access Mode	Auto	
Capacity	2113 MB	
Cylinder	4095	
Head	16	
Precomp	65535	
Landing Zone	4094	
Sector	63	

- ® - :Move Enter:Select +/-/PU/PD:Value F10:Save ESC:Exit F1: General Help
F5:Previous Values F6:Fail-Safe Defaults F7:Optimized Defaults

▶ IDE HDD Auto-Detection

Automatically detects and configures hard disk parameters. The Award BIOS includes this ability in the event you are uncertain of your hard disk's parameters.

▶ IDE Primary/Secondary Master/Slave

This is where you will specify the type of device and how it is represented in the BIOS Setup. If the device is a hard disk or CD-ROM, generally the *Auto* option is the best choice for fast and easy setup of the hard disk parameters. Let's take a look at the difference between the *Auto* and *Manual* options:

▶▶ Auto

This option instructs the BIOS to automatically configure the hard disk by reading the parameters (cylinders, sectors, etc.) directly from the hard disk's firmware. Use this option if you are configuring a new hard drive, or one that has already been formatted using the *Auto* option. Keep in mind that a hard drive is configured using a certain set of parameters, those same parameters must be used for the life of the drive, unless the drive is re-FDISKed using a different parameter set. (This procedure deletes the old partition(s) on the drive and creates a new one, using the new parameters).

MAINBOARD BIOS SETUP

» **Manual**

This option allows you to manually enter in the parameters (cylinder, head, precomp, landing zone and sector) of the hard drive. Generally, this option would be used only if the hard drive has already been formatted with a certain set of parameters, and assured consistency between the old and new parameters is desired.

▪ **Access Mode**

One of Enhanced IDE's most important features is **LBA** (Logical Block Addressing) Mode. This feature allows the use of larger hard drives by providing a way to bypass the cylinder limitations imposed by many Operating Systems. LBA Mode is used to extend a hard drive's useable capacity by remapping the cylinders in a way that is acceptable to these operating systems. For instance, a hard drive with the parameters of 2100 Cylinders, 16 Heads and 63 Sectors would be represented by LBA Mode as 525 Cylinders, 64 Heads and 63 Sectors. (Notice that the Cylinders have been divided, and the Heads have been multiplied, by a factor of 4.)

- On hard drives smaller in capacity than 528MB, LBA support is not needed. The option on these devices is ignored, even if enabled. For hard drives greater than 528MB, LBA mode should be enabled. The following rules apply:
- Operating Systems that do not use the FAT file system do not need LBA Mode, and can use the Normal or Large Modes. Examples would be NetWare and Unix.
- When configuring a new hard drive greater than 528MB in capacity, always make sure LBA mode is enabled.
- If you are using a hard drive that is over 528MB in capacity, but was already formatted without using LBA mode, LBA support will be ignored even if it is enabled. This assures correct access to the drive's data.
- **SCSI Hard Drives** are NOT entered into the Mainboard BIOS Setup in any way. The hard drive settings in the Standard CMOS Setup are only for drives connected to the IDE Controller. So, if only SCSI drives were installed, all these settings would be set to **None**. SCSI Devices are configured via the SCSI controller's BIOS.

MAINBOARD BIOS SETUP

Drive A/B

Select the Type for the A: and/or B: floppy drives. Remember, floppy drive A: is the first drive, hooked to the END of the floppy ribbon cable. Floppy drive B: is hooked up after the twist. Available settings are listed below:

None	No floppy drive installed
360K, 5.25 in	5-1/4 inch PC-type standard drive; 360 kilobyte capacity
1.2M, 5.25 in	5-1/4 inch AT-type high-density drive; 1.2 megabyte capacity
720K, 3.5 in	3-1/2 inch double-sided drive; 720 kilobyte capacity
1.44M, 3.5 in	3-1/2 inch double-sided drive; 1.44 megabyte capacity
2.88M, 3.5 in	3-1/2 inch double-sided drive; 2.88 megabyte capacity

Video

This category selects the type of video adapter used for the primary system monitor. Although secondary monitors are supported, you do not have to select their type in Setup.

EGA/VGA	Enhanced Graphics Adapter/Video Graphics Array. For EGA, VGA, SEGA, SVGA or PGA monitor adapters.
CGA 40	Color Graphics Adapter, power up in 40 column mode
CGA 80	Color Graphics Adapter, power up in 80 column mode
MONO	Monochrome adapter, includes high resolution monochrome adapters

Halt On

Determines whether or not the system will stop and prompt you if an error is detected during POST.

Memory

This category is display-only. All memory detected by the POST (Power On Self Test) of the BIOS is shown as the following types:

Base Memory

Is the amount of conventional memory installed in the system. This value is typically 640K for systems with 640K or more memory installed on the motherboard. The **Extended Memory** is the amount of memory located above 1MB in the CPU's memory address map. **Other Memory** refers to the memory located in the region between 640K and 1MB. This region can be used for *shadowing* as well as *expanded memory* in DOS.

MAINBOARD BIOS SETUP

3.4 Advanced BIOS Features

This menu provides access to more advanced BIOS configuration settings that deal with overall performance of the system and peripheral setup. This section allows you to configure your system for advanced operation. You have the opportunity to select the system's default speed, boot-up sequence, keyboard operation and security.

Anti-Virus Protection	Enabled		Item Help
CPU Internal Cache	Enabled		Menu Level ▶
External Cache	Enabled		
CPU L2 Cache ECC Checking	Enabled		
Quick Power On Self Test	Disabled		
First Boot Device	Floppy		
Second Boot Device	HDD-0		
Third Boot Device	LS/ZIP		
Boot Other Device	Enabled		
Swap Floppy Drive	Disabled		
Boot Up Floppy Seek	Enabled		
Boot Up NumLock Status	Off		
Gate A20 Option	Normal		
Typeomatic Rate Setting	Disabled		
x Typeomatic Rate (Chars/Sec)	6		
x Typeomatic Delay (Msec)	250		
Security Option	Setup		
OS Select For DRAM > 64MB	Non-OS2		

- : Move ® : Select +/-:PU/PD:Value F10:Save ESC:Exit F1: General Help
F5:Previous Values F6:Fail-Safe Defaults F7:Optimized Defaults

Anti-Virus Protection

Enables/Disables the built-in anti-virus for protection against **boot virus** infection. This Anti-Virus protection provides more complete virus protection by taking control early in the boot process.

CPU Internal Cache

Enables or Disables the Level-1 Internal Cache memory. Generally, this would only be *Disabled* for troubleshooting purposes.

External Cache

Enables or Disables the Level-2 External Cache memory. Generally, this would only be *Disabled* for troubleshooting purposes.

MAINBOARD BIOS SETUP

CPU L2 CacheECC Checking

Enables or Disables ECC (Error Checking and Correcting) for the CPU's Level 2 built-in cache.

Quick Power on Self Test

Speeds up Power On Self Test (POST) after the computer is powered on. When set to *Enabled*, the BIOS will shorten or skip some checks during POST.

First/Second/Third/Other Boot Device

When your system is powered on, the BIOS performs a variety of operations, then attempts to boot an Operating System from either a hard drive (IDE or SCSI), floppy drive, CD-ROM, LS-120/ZIP or LAN. This setting determines the sequence that the BIOS will follow when searching devices for a bootable disk.

Swap Floppy Drive

The hardware connections determine which floppy is configured as drive A: and drive B: Swapping the floppy drives can be useful if your system has two floppy drives, and you want the ability to boot from both. For example: Since a PC cannot boot from the B: Floppy, you would need to Swap floppy drives A: and B: in order to set the second floppy drive to drive A:, thereby making it bootable.

Boot Up Floppy Seek

When enabled, BIOS will attempt to move the head of the floppy disk drive forth and back once during POST to see if the drive is working properly.

Boot Up NumLock Status

This set to *On*, the NumLock key will be automatically enabled when the system boots.

Gate A20 Option

This entry allows you to select how the gate A20 is handled. The gate A20 is a device used to address memory above 1 Mbytes. Initially, the gate A20 was handled via a pin on the keyboard (Normal). Today, while keyboards still provide this support, it is more common, and much faster, for the system chipset (Fast; default) to provide support for gate A20.

Typematic Rate Setting

Determines if the typematic rate is to be used. When disabled, continually holding down a key on your keyboard will generate only one instance. In other words, the BIOS will only report that the key is down. When the typematic rate is enabled, the BIOS will report as before, but it will then wait a moment, and, if the key is still down, it will begin to report that the key has been depressed repeatedly. This feature is used to accelerate cursor movements with the arrow keys.

MAINBOARD BIOS SETUP

Typematic Rate (Chars/Sec)

When the typematic rate is enabled, this selection allows you to select the rate at which the keys are accelerated: Options are 6 (default), 8, 10, 12, 15, 20, 24 and 30.

Typematic Delay (Msec)

When the typematic rate is enabled, this selection allows you to select the delay (in msec) between when the key was first depressed and when the acceleration begins. Options are 250 (default), 500, 750 and 1000.

Security Option

This option enables password checking every time the computer is powered on or every time BIOS Setup is executed. If *System* is chosen, a user password prompt appears every time the computer is turned on. If *Setup* is chosen, the password prompt appears only when the BIOS Setup program is executed. Refer to the section Supervisor Password for more information.

OS Select For DRAM > 64MB

This should be set to *OS2* if you are running IBM OS/2 with more than 64MB of RAM in the system. Otherwise, the setting should be *Non-OS2*.

Report No FDD For WIN95/98

When no floppy disk drive is installed, set this option to No to release IRQ6 for passing Windows 95/98 logo. This option is irrelevant under normal operation.

Video BIOS Shadow

This option controls the location of the contents of the 32KB of Video ROM beginning at the C0000h memory location. The settings are:

Enabled	The contents of C0000h-C7FFFh are written to the same address in system memory (RAM) for faster execution.
Disabled	The video ROM is not copied to RAM. The contents of the video ROM cannot be read from or written to cache memory.

C8000-DFFFF Shadow

These options control the location of the contents of the 16KB expansion card ROMs beginning at the specified memory location. If no adapter ROM is using the named ROM area, this area is made available to the local bus. Shadowing a ROM reduces the memory available between 640KB and 1024KB by the amount used for this purpose.

MAINBOARD BIOS SETUP

3.5 Advanced Chipset Features

This setup menu contains advanced configuration options relating to the mainboard chipset. These options are rarely changed by the user.

	Bank 0/1 DRAM Timing	SDRAM 10 ns		Item Help
	Bank 2/3 DRAM Timing	SDRAM 10 ns		Menu Level ▶
	Bank 4/5 DRAM Timing	SDRAM 10 ns		3
	SDRAM CAS Latency	3		
	DRAM Clock	Host CLK		
	Memory Hole	Disabled		
	P2C/C2P Concurrency	Enabled		
	Fast R-W Turn Around	Disabled		
	System BIOS Cacheable	Disabled		
	Video RAM Cacheable	Disabled		
	AGP Aperture Size	64M		
*	AGP-4X Mode	Enabled		
	OnChip USB	Enabled		
	USB Keyboard Support	Disabled		
	AC97 Audio	Auto		
	AC97 Modem	Auto		
	CPU to PCI Write Buffer	Enabled		
	PCI Dynamic Bursting	Disabled		
	PCI Master 0 WS Write	Enabled		

	Memory Hole	Disabled		Item Help
	P2C/C2P Concurrency	Enabled		Menu Level ▶
	Fast R-W Turn Around	Disabled		
	System BIOS Cacheable	Disabled		
	Video RAM Cacheable	Disabled		
	AGP Aperture Size	64M		
	AGP-4X Mode	Enabled		
	OnChip USB	Enabled		
	USB Keyboard Support	Disabled		
	AC97 Audio	Auto		
	AC97 Modem	Auto		
	CPU to PCI Write Buffer	Enabled		
	PCI Dynamic Bursting	Disabled		
	PCI Master 0 WS Write	Enabled		
	PCI Delay Transaction	Enabled		
	PCI #2 Access #1 Retry	Disabled		
	AGP Master 1 WS Write	Enabled		
	AGP Master 1 WS Read	Disabled		
	Memory Parity/ECC Check	Disabled		

Bank 0/1, 2/3, 4/5 DRAM Timing

DRAM timing is controlled by the DRAM timing registers. The timings programmed into this register are dependent on the system design.

MAINBOARD BIOS SETUP

SDRAM CAS Latency

This item allows you to set the SDRAM CAS Latency Timer. Options are 2, 3 (default) and Auto. Select *Auto* if you encounter a problem.

DRAM Clock

The *Host CLK* option allows the DRAM clock to synchronize with the CPU clock. The *HCLK-33M* (and *HCLK+33M*) option allows the 66/100 and 100/133 memory/CPU (and CPU/memory) asynchronous system architecture.

Memory Hole

In order to improve compatibility, certain space in memory can be reserved for old style ISA cards that map memory between 15M-16M.

P2C/C2P Concurrency

Determines the PCI bus and CPU bus concurrency. When disabled, CPU bus will be occupied during the entire PCI operation period.

Fast R-W Turn Around

Enabling this fast read-write turn around option can improve performance, however, stability problems may occur.

System BIOS Cacheable

When Enabled, the contents of the F0000h system memory segment can be cached to the Level-2 cache memory.

Video RAM Cacheable

When Enabled, C0000h to C7FFh become cacheable memory.

AGP Aperture Size

Select the size of the AGP aperture. The aperture is a portion of the PCI memory address range dedicated for graphics memory address space.

AGP-4X Mode

Set to *Enabled* if your AGP card supports the 4X mode.

AGP Driving Control

Set to *Manual* for the next selection "AGP Driving Value" to enter the value of AGP Driving Value.

K7 CLK_CTL Select

Set to *Optimal* for K7 clock ramp according to system clock multiplier and the system bus speed.

OnChip USB

Select *Enabled*. The next option will become available:

MAINBOARD BIOS SETUP

USB Keyboard Support

This item allows you to enable or disable the USB keyboard within the onboard BIOS.

AC97 Audio

If you want to use the Sound Blaster compatible mode or an add-on audio card instead, set this option to *Disabled* to avoid possible conflict.

AC97 Modem

If you want to use the legacy modem compatible mode or an add-on modem card instead, set this option to *Disabled* to avoid possible conflict.

CPU to PCI Write Buffer

When *Enabled*, up to four D words of data can be written to the PCI bus without interrupting the CPU. When disabled, a write buffer is not used and the CPU read cycle will not be completed until the PCI bus signals that it is ready to receive the data.

PCI Dynamic Bursting

When *Enabled*, data transfers on the PCI bus, where possible, make use of the high-performance PCI burst protocol, in which greater amounts of data are transferred at a single command.

PCI Master 0 WS Write

When *Enabled*, writes to the PCI bus are command with zero wait states.

PCI Delay Transaction

The chipset has an embedded 32-bit posted write buffer to support delay transactions cycles. Select *Enabled* to support compliance with PCI specification version 2.1.

PCI#2 Access #1 Retry

This item allows you enable/disable the PCI #2 Access #1 Retry.

AGP Master 1 WS Write

This implements a single delay when writing to the PCI Bus. By default, two wait states are used by the system, allowing for greater stability.

AGP Master 1 WS Read

This implements a single delay when reading to the PCI Bus. By default, two wait states are used by the system, allowing for greater stability.

Memory Parity/ECC Check

When *Disabled*, there will be no memory errors shown on the monitor for **Memory parity SERR# (NMI)**. When parity DRAM modules are used, select *Parity* or *ECC* (Error Checking and Correcting) to correct 1 bit memory errors in the memory.

MAINBOARD BIOS SETUP

3.6 Integrated Peripherals

This menu is used to configure the integrated IDE subsystem and other peripherals.

OnChip IDE Channel 0	Enabled		Item Help
OnChip IDE Channel 1	Enabled		Menu Level ▶
IDE Prefetch Mode	Enabled		
Primary Master PIO	Auto		
Primary Slave PIO	Auto		
Secondary Master PIO	Auto		
Secondary Slave PIO	Auto		
Primary Master UDMA	Auto		
Primary Slave UDMA	Auto		
Secondary Master UDMA	Auto		
Secondary Slave UDMA	Auto		
Init Display First	PCI Slot		
IDE HDD Block Mode	Enabled		
Onboard FDD Controller	Enabled		
Onboard Serial Port 1	Auto		
Onboard Serial Port 2	Auto		
UART 2 Mode	Standard		
x IR Function Duplex	Half		
x Tx, Rx inverting enable	No, Yes		

IDE HDD Block Mode	Enabled		Item Help
Onboard FDD Controller	Enabled		Menu Level ▶
Onboard Serial Port 1	Auto		
Onboard Serial Port 2	Auto		
UART 2 Mode	Standard		
x IR Function Duplex	Half		
x Tx, Rx inverting enable	No, Yes		
Onboard Parallel Port	378/IRQ7		
Onboard Parallel Mode	ECP/EPP		
ECP Mode Use DMA	3		
Parallel Port EPP Type	EPP 1.9		
Onboard Legacy Audio	Enabled		
Sound Blaster	Disabled		
SB I/O Base Address	220H		
SB IRQ Select	IRQ 5		
SB DMA Select	DMA 1		
MPU-401	Disabled		
MPU-401 I/O Address	330 -333H		
Game Port (200-207H)	Enabled		

MAINBOARD BIOS SETUP

On-Chip IDE Channel0

Enables or Disables the primary controller. Situations where this controller would be disabled are: a) *You are not using any IDE Drives* or b) *You are using an add-on IDE controller in a PCI Slot.*

On-Chip IDE Channel 1

Enables or Disables the secondary controller. Situations where this controller would be disabled are: a) *You are not using any IDE Drives* or b) *You are using IDE Drives ONLY on the primary controller* or c) *You are using an add-on IDE controller in a PCI Slot.*

IDE Prefetch Mode

Enable prefetching for IDE drive interfaces that support its faster drive accesses. If you are getting disk drive errors, change the setting to omit the drive interface where the errors occur. Depending on the configuration of your IDE subsystem, this field may not appear, and it does not appear when the Internal PCI/IDE field, above, is Disabled.

- **IDE PIO Mode**

IDE Programmed I/O Mode - This setting relates to the speed at which the hard drive is able to transfer data, up to 16.6MB/second for Mode 4 drives. Available settings are *Auto, 0, 1, 2, 3, or 4.* As with the **Type** setting, *Auto* is the preferred choice, in that the supported PIO Mode is read directly from the hard drive. Be sure not to use a PIO Mode higher than what the drive actually supports. This could result in loss of data.

PIO Mode	Timing
0	600 ns
1	383 ns
2	240 ns
3	180 ns
4	120 ns

- **IDE UDMA (Ultra DMA) Mode**

The chipset used for this mainboard improves the IDE performance by implementing UltraDMA/66 Bus Mastering IDE which can handle data transfer up to 66 Mbyte/sec. This UDMA technology is downward compatible with existing ATA-2 IDE. So there is no upgrade required for current hard drives and cabling.

Init Display First

When your system has an AGP card coexisting with other PCI display card, this option tells your system which display card to use initially.

IDE HDD Block Mode

This allows your hard disk controller to use fast block mode to transfer data to and from your hard disk drive (HDD).

Onboard FDD Controller

Set to *Enabled* if you have a floppy disk drive installed on the system board and you wish to use it. Even when so equipped, if you add a higher performance controller, you will need to disable this feature.

MAINBOARD BIOS SETUP

Onboard Serial Port 1

With this option, the on-board Serial Port 1 can be Disabled, or set to Auto, 3F8/IRQ4, 2F8/IRQ3, 3E8/IRQ4 or 2E8/IRQ3.

Onboard Serial Port 2

With this option, the on-board Serial Port 2 can be Disabled, or set to Auto, 3F8/IRQ4, 2F8/IRQ3, 3E8/IRQ4 or 2E8/IRQ3.

UART 2 Mode

By default, this field is set to *Standard*, which directs the second serial port UART to support the COM2 serial port.

Choosing *ASKIR* (SHARP IR) or *HPSIR* (IrDA) will activate the on-board infrared feature and redirect the second serial port UART to support the infrared module connector on the mainboard. The following infrared function related options will become available:

IR Function Duplex

Select the option required by the IR device connected to the IR port. Full-duplex mode permits simultaneous two-direction transmission. Half-duplex mode permits transmission in one direction only at a time.

Tx, Rx inverting enable

Determines the Infrared Transmission and Receiving inverting mode.

Onboard Parallel Port

With this option, the on-board Parallel Port can be Disabled, or set to 378/IRQ7, 3BC/IRQ7 or 278/IRQ5.

Onboard Parallel Mode

Sets the operating mode of the parallel port. Options are: *Normal*, *EPP*, *ECP* and *ECP/EPP*. Normal: Standard Parallel Port, EPP: Enhanced Parallel Port, ECP: Extended Capability Port.

ECP Mode Use DMA

Options are 1 and 3. This field is available only when one of the two following options in

Parallel Port EPP Type

Options are 1.7 and 1.9 (default; IEEE 1284 compliant).

MAINBOARD BIOS SETUP

Onboard Legacy Audio

Enabling this option allows the system to use the on-chip legacy SoundBlaster-compatible audio support.

*** The following fields are available only when the *Onboard Legacy Audio* is *Enabled*.

Sound Blaster

Enables/Disables the Sound Blaster compatible mode.

SB I/O Base Address

This option allows the user to select the audio I/O base address in Sound Blaster compatible mode.

SB IRQ Select

This option allows the user to select the IRQ for audio in Sound Blaster compatible mode.

SB DMA Select

This option allows the user to select the DMA for audio in Sound Blaster compatible mode.

MPU-401

Enables/Disables the MPU-401 MIDI interface standard.

MPU-401 I/O Address

This option allows the user to select the I/O base address for the use of MPU-401 MIDI device.

Game Port (200-207H)

Enable this option to use the game port, which occupies 200-207H address.

MAINBOARD BIOS SETUP

3.7 Power Management Setup

Power Management allows you to configure your system to use energy most efficiently, and still in a manner consistent with your own style of computer use.

ACPI function	Enabled	Item Help
▶ Power Management	Press Enter	Menu Level ▶
ACPI Suspend Type	S1(POS)	
PM Control by APM	Yes	
Video Off Option	Suspend -> Off	
Video Off Method	V/H SYNC+Blank	
MODEM Use IRQ	3	
Soft-Off by PWRBTN	Instant-Off	
State After Power Failure	Off	
▶ Wake Up Events	Press Enter	

- / @ - : Move Enter: Select +/- /PU/PD: Value F10: Save ESC: Exit F1: General Help
 F5: Previous Values F6: Fail-Safe Defaults F7: Optimized Defaults

ACPI function

This option allows you to enable/disable the Advanced Configuration and Power Interface, which makes hardware status information available to the operating system and offers improved power management. To make an ACPI system, you must use an ACPI OS such as Windows 98.

Power Management

Press <Enter> to bring up the submenu. This category allows you to select the type (or degree) of Green PC power saving and is directly related to the **HDD Power Down**, **Doze Mode** and **Suspend Mode** options in the submenu. There are three selections for Power Management, two of which have fixed mode settings:

User Define	Set each mode individually. When Enabled, each range is from 10 sec. to 1 hr., except for HDD Power Down which ranges from 1 min. to 15 min.
Max Saving	Maximum power management – ONLY AVAILABLE FOR SL CPUs . Doze Mode = 10 sec., Suspend Mode = 10 sec.
Min Saving	Minimum power management. Doze Mode = 1 hr., Suspend Mode = 1 hr.

MAINBOARD BIOS SETUP

When *User Define* Power Management has been selected, the following modes become user configurable:

- › **HDD Power Down**
When enabled and after the settime of system inactivity, the hard disk drive will be powered down while all other devices remain active.
- › **Doze Mode**
When enabled and after the set time of system inactivity, the CPU clock will run at slower speed while all other devices still operate at full speed.
- › **Suspend Mode**
When enabled and after the set time of system inactivity, all devices except the CPU will be shut off.
- › **ACPI Suspend Type**
Determines the ACPI defined suspend type.

Suspend Type	Power Consumption
S1 (POS)	State 1 (Power On Suspend) - below 30W CPU stops working through STPCLK#, while the power is still provided for the whole system.
S3 (STR)	State 3 (Suspend to RAM) - Less than 10W Power is provided only to DRAM and wake-up devices circuit, while the rest of the system is powered off. * Available only when ATX style power supply is used.

PM Control by APM

When set to Yes, an Advanced Power Management device will be activated to enhance the Max. Power Saving mode and stop the CPU internal clock. If the Max. Power Saving is not enabled, this will be preset to No.

Video Off Option

When enabled, this feature allows the VGA adapter to operate in a power saving mode.

Always On	Monitor will remain on during power saving modes.
Suspend → Off	Monitor blanked when the systems enters the Suspend mode.
All Modes → Off	Monitor blanked when the system enters any power saving mode.

Video Off Method - This determines the manner in which the monitor is blanked.

MAINBOARD BIOS SETUP

Blank Screen	This option only writes blanks to the video buffer.
V/H SYNC+Blank	This selection will cause the system to turn off the vertical and horizontal synchronization ports, writing blanks to the video buffer.
DPMS Support	Initial display power management signaling.

MODEM Use IRQ

This item tells the Power Management BIOS which IRQ is assigned to the installed MODEM. Options are NA, 3, 4, 5, 7, 9, 10, and 11.

Soft-Off by PWRBTN

Available only when ATX styled power supply is used. With *Instant-Off* selected, the ATX switch functions like a normal system power off button. With *Delay 4 Sec.* selected, you must hold down the ATX switch for more than 4 seconds to power off the system.

State After Power Failure

This feature will power-on the PC when power returns after a power failure. The following table lists the options available and the corresponding System State when power returns.

Options Available	System State When Power Failure Occurred	System State When Power Returns
Auto	On	On
	Off	Off
On	On	On
	Off	On
Off	On	Off
	Off	Off

Wake up Events

Wake up Events are I/O events whose occurrence can prevent the system from entering a power saving mode or can awaken the system from such a mode. In effect, the system remains alert for anything which occurs to a device which is configured as *On/Enabled*, even when the system is in a power down mode.

Press <Enter> to bring up the submenu:

MAINBOARD BIOS SETUP

VGA	OFF	Item Help
LPT & COM	LPT/COM	
HDD & FDD	ON	Menu Level ▶
PCI Master	OFF	
Keyboard Resume	Disabled	
Wake Up On LAN/Ring	Disabled	
RTC Alarm Resume	Disabled	
x Date (of Month)	0	
x Resume Time (hh:mm:ss)	0 : 0 : 0	
▶ IRQs Activity Monitoring	Press Enter	

- / ® - : Move Enter: Select +/- / PU / PD: Value F10: Save ESC: Exit F1: General Help
 F5: Previous Values F6: Fail-Safe Defaults F7: Optimized Defaults

- ▶ **VGA**
When set to On, any event occurring at a VGA port will awaken a system which has been powered down.
- ▶ **LPT & COM**
Determines if any event occurring at a LPT (printer) and/or COM (serial) port will awaken a system which has been powered down.
- ▶ **HDD & FDD**
When set to On, any event occurring at a hard or floppy drive port will awaken a system which has been powered down.
- ▶ **PCI Master**
When set to On, any event occurring to the PCI bus will awaken a system which has been powered down.
- ▶ **Keyboard Resume**
Enabling this option allows pressing any key on the keyboard to wake up a system. In addition to this BIOS setting, you need to also set the Keyboard Power-on Jumper. Refer to page 13.

MAINBOARD BIOS SETUP

- › **Wake Up On LAN/Ring**
An input signal on the serial Ring Indicator (RI) line in other words, an incoming call on the modem (either external modem or internal modem card) power on the system. Refer to Modem Wake-up Function (JP11) on page 21 for more information. With a LAN card installed, the Wake-up On LAN function allows the network to wake up a Soft Power Down (Soft-Off) PC. Refer to LAN Wake-up Connector (J12) on page 21 for more information.

- › **RTC Alarm Resume**
When enabled, the system will automatically power on or returns to full power out of suspend/standby mode at the time and date of the month (0 for daily) specified.

- › **IRQs Activity Monitoring**
Press <Enter> to bring up the submenu.
 - › **Primary INTR**
When set to *On* (default), any primary interrupt request (see below) will awake the system which has been powered down.
 - › On the submenu is a list of IRQs (**I**nterrupt **R**e**Q**uests). You can set each IRQ to be *Primary*, *Secondary* or *Disabled*. When set to *Secondary*, the interrupt request will neither prevent the system from going into a power management mode nor awaken it.

MAINBOARD BIOS SETUP

3.8 PnP/PCI Configurations

The PCI Personal Component Interconnect Bus was developed to address two important issues: a) How to allow peripheral devices to take the fullest advantage of the power of Pentium and Pentium Pro chip technology, and b) Provide a simpler installation process for peripheral devices, such as Network cards, EIDE or SCSI controllers.

PCI accomplishes these goals with its 32-bit Data path Local Bus design, and support for Plug & Play. Unlike older expansion bus architectures, PCI provides peripherals with a direct connection to the CPU and memory. The PCI bus runs at 33Mhz and has a maximum transfer capability of 132MBps. With Plug & Play, the system BIOS automatically determines hardware resources for new peripherals, simplifying installation of multiple interface cards.

This Setup Menu provides configuration options for the PCI Bus and its assigned resources.

PNP OS Installed	No	Item Help
Reset Configuration Data	Disabled	
Resources Controlled By	Auto (ESCD)	Menu Level ▶
x IRQ Resources	Press Enter	
x DMA Resources	Press Enter	
PCI/VGA Palette Snoop	Disabled	
Assign IRQ For VGA	Enabled	
Assign IRQ For USB	Enabled	
Slot 1 Use IRQ No.	Auto	
Slot 2 Use IRQ No.	Auto	
Slot 3, AC97 Use IRQ No.	Auto	
Slot 4,5 USB Use IRQ No.	Auto	
SYMBIOS SCSI BIOS	Auto	

- : Move Enter: Select +/-/PU/PD: Value F10: Save ESC: Exit F1: General Help
F5: Previous Values F6: Fail-Safe Defaults F7: Optimized Defaults

PNP OS Installed

Set to *Yes* if your operating system supports Plug & Play, such as Windows® 95.

MAINBOARD BIOS SETUP

Reset Configuration Data

Reset Configuration Data: When set to Enabled, ESCD (Extended System Configuration Data) is cleared. This setting will automatically be set back to Disabled when the system reboots.

Resources Controlled By

The Award Plug and Play BIOS has the capacity to automatically configure all of the boot and Plug and Play compatible devices. This capability is specifically designed for a Plug and Play operating system such as Windows 95.

When set to *Manual*, you are able to configure the **IRQ** and **DMA Resources**. Pressing <Enter> at the selection field brings up a submenu like the one shown below:

IRQ-3	assigned to	PCI/ISA PnP	Item Help
IRQ-4	assigned to	PCI/ISA PnP	
IRQ-5	assigned to	PCI/ISA PnP	
IRQ-7	assigned to	PCI/ISA PnP	
IRQ-9	assigned to	PCI/ISA PnP	
IRQ-10	assigned to	PCI/ISA PnP	
IRQ-11	assigned to	PCI/ISA PnP	
IRQ-12	assigned to	PCI/ISA PnP	
IRQ-14	assigned to	PCI/ISA PnP	
IRQ-15	assigned to	PCI/ISA PnP	

- : Move Enter: Select +/-/PU/PD: Value F10: Save ESC: Exit F1: General Help
F5: Previous Values F6: Fail-Safe Defaults F7: Optimized Defaults

› **IRQ3/4/5/7/9/10/11/12/14/15 assigned to**

By default, all resources are assigned to the PCI Bus. If an ISA card requires a particular IRQ, those resources should be set to Legacy ISA so that the PCI Bus will not try to use them. Choices are *Legacy ISA* and *PCI/ISA PnP*.

Pressing <Enter> at **DMA Resources** brings up a submenu that gives you the following options:

› **DMA 0/1/3/5/6/7 assigned to**

By default, all resources are assigned to the PCI Bus. If an ISA card requires a particular DMA channel, those resources

MAINBOARD BIOS SETUP

should be set to Legacy ISA so that the PCI Bus will not try to use them. Choices are *Legacy ISA* and *PCI/ISA PnP*.

PCI/VGA Palette Snoop

This option must be set to *Enabled* if any ISA MPEG card installed requires VGA palette snooping.

Assign IRQ For VGA

The *Enabled* option allows the BIOS to auto-route an IRQ for use by a VGA card. While most of the VGA cards do not need the IRQ assignment, certain VGA cards may need it.

Assign IRQ For USB

When *Enabled*, the system automatically assigns an IRQ for the USB device connected to your system. However, if no USB devices are used and an ISA slot requires an IRQ address, set this function to *Disabled*. The IRQ address previously occupied by the USB device will be available for the ISA slot.

Slot 1-5

Auto-routes or specifies an IRQ for the particular device.

SYMBIOS SCSI BIOS

When set to *Auto* (Default), the system will automatically sense the presence of any SCSI adapter that uses a Symbios SYM53C8XX SCSI chip:

If the SCSI adapter installed has its own BIOS on board:	The on-board SCSI BIOS will not be loaded. The adapter's own SCSI BIOS will be used.
If the SCSI adapter installed does not have its own BIOS and the card uses or is compatible with the SYM53C8XX chip:	The on-board SCSI BIOS will load and control the SCSI adapter.

**Disabling* the onboard SCsIBIOS prevents it from being active in any way.

MAINBOARD BIOS SETUP

3.9 PC Health Status

The onboard hardware monitor allows you to observe the current temperatures of the system and CPU, current speeds (in RPM, rotation per minute) of the system and CPU fans, as well as the various operating voltages. (If the fan is not installed, 0 RPM will be shown.)

Current CPU Temp.	35°C/ 95°F	Item Help
Current System Temp.	30°C/ 86°F	
Current CPUFAN1 Speed	5400 RPM	Menu Level ▶
Current CPUFAN2 Speed	0 RPM	
Vcore	2.04 V	
2.5V	2.33 V	
3.3V	3.21 V	
5V	4.97 V	
12V	11.85 V	

- ↑ ® → :Move Enter:Select +/-/PU/PD:Value F10:Save ESC:Exit F1: General Help
F5:Previous Values F6:Fail-Safe Defaults F7:Optimized Defaults

MAINBOARD BIOS SETUP

3.10 Frequency / Voltage Control

Use this menu to specify your settings for frequency/voltage control.

Auto Detect DIMM/PCI Clk	Enabled	Item Help
Spread Spectrum	Disabled	
CPU Host Clock (CPU/PCI)	Default	Menu Level ▶
VIO Voltage	3.3V	

- ~ ® ↵:Move Enter:Select +/-/PU/PD:Value F10:Save ESC:Exit F1: General Help
F5:Previous Values F6:Fail-Safe Defaults F7:Optimized Defaults

Auto Detect DIMM/PCI Clk

When *enabled*, any DIMM/PCIclock not in use will be disabled to reduce EMI radiation.

Spread Spectrum

The default is the optimal value determined by the system designer to reduce EMI radiation peak. Users should not attempt to change it.

CPU Host Clock (CPU/PCI)

This option lets you select the CPU/PCI Bus clock. *Over-clocking may cause serious system damage.*

VIO Voltage

This option allows you select the processor's input and output pins voltage.

MAINBOARD BIOS SETUP

3.11 Load Fail-Safe Defaults

Loads Fail Safe settings into the BIOS Setup program. These options are designed to slow the system down for troubleshooting purposes. To load the default values, highlight this option and press [ENTER]. Enter Y in the confirmation screen and press [ENTER] again. User-defined options in the **Standard CMOS Setup** are not affected.

3.12 Load Optimized Defaults

Loads the default values for best system performance into the BIOS Setup program. To load the default values, highlight this option and press [ENTER]. Enter Y in the confirmation screen and press [ENTER] again. User-defined options in the **Standard CMOS Setup** are not affected.

3.13 Supervisor Password and User Password Setting

Passwords can be set to provide protection for the BIOS configuration options, or to restrict access to the computer itself.

When enabled, UserPassword will require all users to enter a password in order to use the system, and/or enter the BIOS setup (but can't change its contents). A Supervisor Password is used to protect the stored CMOS options from being changed by unauthorized users.

Keep in mind that when set, a password is required only when booting the system. It will not provide protection to a system that is already booted.

The password check option is set in **Advanced BIOS Features** by choosing either System (the password prompt appears every time the system is powered on) or Setup (the password prompt appears only when the user enters the BIOS Setup). The password is stored in CMOSRAM, and can be cleared by the Clear CMOS jumper. (Refer to page 14.)

MAINBOARD BIOS SETUP

To set a password:

1. You must first set the *Supervisor* password by choosing *Supervisor Password* and pressing [ENTER]. Setup prompts for a password.
2. Enter a 1-8 character password using letters, numbers, or a combination of both. The specific characters are not shown as you enter them. Press [ENTER].
3. A confirmation box appears asking you to re-enter the password. Enter the password again. Press [ENTER]. Follow the same procedure to set the *User Password*.

Changing a Password:

Select the appropriate password option (Supervisor or User) from the main menu and press [ENTER]. Enter the current password and press [Enter]. The screen does not display the characters entered. Enter in the new password, then the confirmation. You cannot change the current password unless you know it.

Erasing a Password:

1. If you know the current password, but want to disable password checking, follow the procedure for changing the password. When Setup prompts for the new password, simply press [ENTER]. You will see a message indicating that the password is disabled.
2. If you do not know the current password, the CMOS must be cleared by cleared by the Clear CMOS jumper (Refer to page 14). *This will clear all user-defined BIOS Setup options.

3.14 Save & Exit Setup / Exit Without Saving

Select *Save & Exit Setup* to save into the CMOS memory all modifications specified during the current session. To save the configuration changes, highlight this option in the main menu and press [ENTER]. The system displays a confirmation message on the screen. Press the Y key and then [Enter]. Press the N key and then the [Enter] key to abort. The *Exit Without Saving* option allows the user to exit the BIOS Setup without updating any changes made during the current session.

MAINBOARD BIOS SETUP

3.15 PCI Device Listing

This list of installed PCI devices appears after the **System Configuration** screen:

PCI device listing						
Bus No.	Device No.	Func No.	Vendor ID	Device ID	Device Class	IRQ
0	7	1	1106	0571	IDE Controller	14/15
0	7	2	1106	3038	Serial Bus Controller	5
0	7	3	1106	3038	Serial Bus Controller	5
0	7	5	1106	3038	Multimedia Device	10
0	9	0	5333	8A22	Display controller	11
					ACPI Controller	9

Bus No. Encoded value indicating 1 of 256 possible buses in a system.

Device No. Encoded value indicating 1 of 32 possible devices on a given bus.

Func No. Encoded value indicating 1 of 8 possible functions on a multifunction device.

Vendor ID Identifies the manufacturer of the device. Valid vendor identifiers are allocated by the PCI SIG (Special Interest Group) to ensure uniqueness.

Device ID Identifies the particular device. This identifier is allocated by the vendor.

Device Class Specifies one of the following device classes: Mass storage controller, Network controller, Display controller, Multimedia device, Bridge device, Simple communication controller, Base system peripherals, Input device, Docking station, Processor and Serial bus controller.

The PCI device listing is useful for troubleshooting purposes. More detailed information for each field may be obtained through the PCI specification documentation.

4. BUILT-IN SYMBIOS SCSI BIOS

To provide easy to use and cost effective support for adapters using or compatible with the Symbios Logic 53C8XX SCSI chips, this mainboard features built-in Symbios SCSI BIOS.

In most cases you should not need to change the default configuration of your host adapter. You may decide to alter these default values if there is a conflict between device settings, or if you need to optimize system performance. A message appears on your computer monitor (for about 5 seconds) during boot that looks like this:

Press Ctrl-C to start Symbios Configuration Utility

If you decide to press Ctrl-C during boot, the following message appears:

Please wait, invoking Symbios Configuration Utility

After a brief pause, your computer will display the Main Menu of the utility.

The Symbios SCSI Configuration Utility

This menu driven utility allows you to view and change the default configuration settings for host adapters using Symbios 53C8XX chips.

Note: Pressing **Ctrl-A** after memory count during re-boot allows you to recover the default settings and reconfigure.

The following tables list the configuration settings you can change:

- Global: Affects both the adapter and all SCSI devices
- Device: Affects only the individual SCSI devices

BUILT-IN SYMBIOS SCSI BIOS

Global Default Settings	
Settings	Default
SCAM Support	On
Parity Checking	On
Host Adapter SCSI ID	7
Scan Order	Low to High (0-Max)

Device Default Settings	
Settings	Default
Synchronous Transfer Rate (MB/sec)	20
Data Width	8
Disconnect	On
Read Write I/O Timeout (secs)	10
Scan for Devices at Boot Time	Yes
Scan for SCSI LUNs	Yes
Queue Tags	No

Main Menu

MAIN MENU					
	Port Num	Irq Level	-----Status----- Current Next-Boot		NvRAM Found
SYM53C860	EC00	1	On	On	Yes
Change Adapter Status Adapter Boot Order Additional Adapter Configuration Display Mode = Verbose Mono/Color Language Help Quit					

You can select an adapter only if the current status is **On**. *Changes are only possible with SCSI adapters that support NVRAM (non-volatile memory).* Check the **NvRAM Found** column to see if NVRAM is present on your adapter. If you choose to alter any of these settings, exit via the **Quit** option and the system will reboot.

Change Adapter Status

Allows you to activate or deactivate a host adapter and all SCSI devices attached to it. The change takes place after a reboot, which is automatic upon exit from the utility when this option is changed.

BUILT-IN SYMBIOS SCSI BIOS

Adapter Boot Order

Allows you to set the order in which host adapters will boot when more than one Symbios host adapter is present in the system. To change an adapter's boot order, select it and press <Enter>. You are then prompted to enter the new boot sequence number. When the adapters are ordered properly, press the <Esc> key to exit this menu.

	Port Num	Irq Level	-----Status-----		NvRAM Found
			Current	Next-Boot	
SYM53C860	FC00	9	On	On	Yes
SYM53C820	0	0	Off	Off	?
SYM53C825	FD00	9	On	On	Yes
SYM53C815	FE00	10	On	On	No

Display Mode

Determines how much information about your host adapters and SCSI devices is displayed on your computer monitor during boot:

- *verbose*: for more complete information
- *terse*: for a faster boot

Mono/Color

Allows you to choose between a black and white or color display for the SCSI Configuration utility.

Language

English mode only.

Help

Brings up a help screen with information about the Main menu.

Quit

Exits the SCSI Configuration utility.

Adapter Utilities Menu

When you select a host adapter from the main menu, the following screen is displayed:

SYM53C860
Adapter Setup Device Selections Help Exit this menu

- **Adapter Setup:**
Adapter settings are viewed and changed.

BUILT-IN SYMBIOS SCSI BIOS

SYM53C860

Adapter Setup

SCAM Support	Off
Parity	On
Host SCSI ID	7
Scan Order	Low to High (0..Max)
Removable Media Support	None
CHS Mapping	SCSI Plug and Play Mapping
Secondary Cluster Server	No
Spinup Delay (Secs)	2
Termination	Auto
Help	
Restore Default Setup	
Exit this menu	

SCAM Support

SCAM (SCSI Configured AutoMatically) is the SCSI Plug and Play protocol supported by Symbios BIOS version 4.X.

Parity

The Symbios host adapters always generate parity, but some SCSI devices do not. Therefore, you are offered the option of disabling parity checking.

Note: When disabling parity checking, it is also necessary to disable disconnect for all devices, as parity checking for the reselection phase will not be disabled. If a device does not supporting parity disconnects, the I/O will never complete because the reselection phase will halt.

Host SCSI ID

The host adapter SCSI ID should remain on 7 (default), as this setting gives the adapter the highest priority on the SCSI bus. However, if you have two adapters on the same SCSI bus, you should give one of them an unassigned ID to avoid duplication of SCSI IDs.

Scan Order

This option allows you to tell the host adapter BIOS and your device drivers to scan the SCSI bus from low to high (0 to max) SCSI IDs, or from high to low (max to 0) SCSI IDs. If you have more than one device on the SCSI bus, changing the scan order changes the order in which drive letters are assigned by the system.

Removable Media Support

Determine if the removable media will be used as BIOS device. A BIOS device here is a device that can be controlled via BIOS INT 13H, i.e. it does not need a device driver and can be bootable. However, when used as a BIOS device, the full removability of removable media devices is not preserved. The following constraints apply:

BUILT-IN SYMBIOS SCSI BIOS

- a) The device can only work as a fixed disk, i.e. media change is not allowed.
- b) The media must be inserted before the system boot-up.
- c) Only media with 512 Bytes/sector is supported.

None	The removable media devices will not be used as BIOS devices.
Boot Drive Only	Allows only the removable media installed as Drive C: to work as a BIOS device.
With Media Installed	Enables all removable disk drives to work as BIOS devices.

CHS Mapping

Cylinder, Head, Sector mapping. Options are SCSI Plug and Play Mapping (default) and Alternate CHS Mapping.

Spinup Delay (Secs)

1-10 seconds. The default is a 2-second delay before the BIOS starts to scan for SCSI devices during initialization. This amount of time is enough for most devices to get ready for proper operation. Since some older hard drives may need more time to spin up, you may need to extend the delay for those devices.

- **Device Selections:** Settings for the devices attached to the selected adapter are viewed and changed.

SYM53C860 Devices 0 to 7								
	Sync Rate	Data Width	Disc	Time Out	Scan Bus	LUNS	Queue Tags	Init Boot
Dev0 N/A	20	8	On	10	Yes	Yes	On	No
Dev1 N/A	20	8	On	10	Yes	Yes	On	No
Dev2 N/A	20	8	On	10	Yes	Yes	On	No
Dev3 N/A	20	8	On	10	Yes	Yes	On	No
Dev4 N/A	20	8	On	10	Yes	Yes	On	No
Dev5 N/A	20	8	On	10	Yes	Yes	On	No
Dev6 N/A	20	8	On	10	Yes	Yes	On	No
SYM53C860	20	8	On	10	Yes	Yes	On	No
Devices 8 to 15								
Help								
Exit this menu								

The above menu provides information about individual SCSI devices attached to the selected host adapter, as well as the adapter itself. To make changes to these settings select a device from this display and press <Enter> to bring up the individual **Device Setup** menu.

BUILT-IN SYMBIOS SCSI BIOS

Device Setup Menu

When you select a specific device from the Device Selection menu, your computer displays the following Device Setup menu. The settings in this menu effect individual SCSI devices attached to the selected host adapter. Changes made from this menu will require a system reboot upon exit from the SCSI Configuration utility.

SYM53C860 Setup for All devices on this adapter	
Sync Rate (MBytes/sec)	20
Width (bits)	8
Disconnect	On
Read Write I/O Timeout (secs)	10
Scan for Device at Boot Time	Yes
Scan for SCSI LUNS	Yes
Queue Tags	On
Initial Boot Device	No
Format	
Verify	
Help	
Restore Default Setup	
Exit this menu	

Sync Rate (Mega Bytes/sec)

Defines the maximum transfer rate the host adapter attempts to negotiate. The host adapter and a SCSI device must agree to a rate they can both handle.

Width (bits)

Sets the maximum data width the host adapter will attempt to negotiate. The host adapter and a SCSI device must agree to a width they can both handle. Only those host adapters that support 16bit data transfers will show this option as enabled.

Disconnect

SCSI devices have the ability to disconnect from the bus during an I/O transfer. This option tells the host adapter whether or not to allow a device to disconnect. Some devices run faster with disconnect enabled (mostly newer devices), while some run faster with disconnect disabled (mostly older devices).

Read Write I/O Timeout (secs)

This option sets the time the host adapter waits for a read, write, verify, or seek command to complete before trying the I/O transfer again. Since this provides a safeguard allowing the system to recover if an I/O operation fails, it is recommended that you always set the time-out to a value greater than zero (no time-out).

BUILT-IN SYMBIOS SCSI BIOS

Scan for Device at Boot Time

When there is a device you do not wish to make available to the system, set this option to No for that device. Also, on a bus with only a few devices attached, you can speed up boot time by changing this setting to No for unused SCSI IDs.

Scan for SCSI LUNs

You can set this option to No if you have problems with a device that responds to all LUNs whether they are occupied or not.

Queue Tags

If your device driver can issue queue tags, this option allows you to enable or disable the issuing of queue tags during I/O requests.

Format

Low level format the selected device. All information on the drive will be erased.

Verify

This command is used to detect bad blocks on the chosen disk. With your confirmation, the bad blocks detected can be reassigned for future operations. This command is non-destructive, and therefore won't destroy the data on the drive.

Since some changes only take effect after your system reboots, it is important that you quit this Configuration utility properly. You should return to the Main Menu and exit via the **Quit** option. If you reboot the system without properly exiting the utility, some changes may not be saved.

Device Drivers

To function properly with different SCSI devices under different operating systems you'll need to install **device drivers**. The device driver information should be available in your SCSI adapter's package.

FLASH BIOS PROGRAMMING UTILITY

5. FLASH BIOS PROGRAMMING UTILITY

Updating the Award BIOS Code is made easy with the AWDFLASH Utility found under the Utilities folder of the supplied CD-ROM. Since this mainboard features FLASH BIOS, it is not necessary to change the actual BIOS chip in order to upgrade the System BIOS. The user can simply re-program the old BIOS using the AWDFLASH Utility as follows:

1. First, boot the system with DOS or to Safe mode command prompt only under Windows 95/98. If you are booting DOS from a hard drive or floppy disk, press [F5] when the message Starting MS-DOS appears on the screen. If you are booting Windows 95/98, press the [F8] key, and select the Safe mode command prompt only option. This will assure that the system is running in *real mode* with **no device drivers loaded**. *This is the only correct way to run the AWDFLASH Utility program.*
2. There are (2) important files needed to re-program the BIOS. The first is AWDFLASH.EXE which is the FLASH BIOS Programming Utility. The second file needed is the updated BIN file which contains the actual BIOS code. This file will have the extension [.bin], such as P598GH.BIN. Make sure these files are on the diskette or hard drive in the same directory.
3. Start the AWDFLASH Utility by changing to the directory where the two required files exist, typing: AWDFLASH and pressing [ENTER].

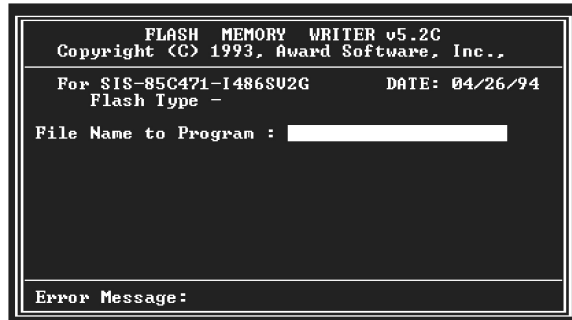

4. The AWDFLASH Utility Screen appears. You will be asked for the file name to program. Type in the name of the new BIOS (.bin) file and hit [ENTER].

FLASH BIOS PROGRAMMING UTILITY

5. The program will then ask if you want to backup the old BIOS. This is recommended in case there are any problems with the new .bin file. Enter the name of the new backup file (such as backup.bin) and press [ENTER].
6. At this time the system will prompt you for final confirmation before beginning programming. The Utility can be aborted at this time by hitting n. To begin programming, hit y
7. When the Flash programming starts, a bar indicator will show the progress of the programming operation. After successful completion, hit the reset button or power off the computer.

Be sure to perform **Load Optimized Defaults** for your new BIOS to synchronize the previous BIOS with the updated BIOS.

DMI UTILITY

6. DMI UTILITY

This mainboard supports the **Desktop Management Interface (DMI)**, which is a new method of providing enterprise management for personal computers. The main component of DMI is the Management Information Format Database (MIF), which contains information about the computer system and its components, such as BIOS version/vendor, CPU speed/type, memory size/type, L1/L2 cache, port connectors (IDE, floppy, 2S/1P, USB, keyboard, mouse,), slots etc. Using DMI, remote PC management software is able to obtain various information about the system, including hardware profiles, capabilities, operational status, installation dates, and other information about the system and its components.

This DMI utility, DMICFG.EXE found under the Utilities folder of the supplied CD-ROM, allows you to add additional information, such as serial numbers, vendor information, and enclosure/chassis configurations, into the MIF.

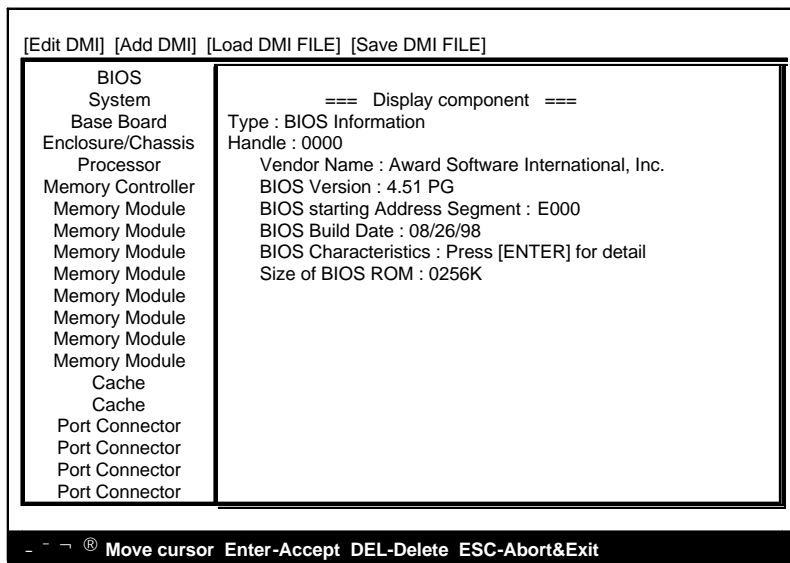

Note: The DMI utility must be run in real mode without the EMM386 memory manager loaded.

7. INSTANTLY AVAILABLE PC

7.1 What is an Instantly Available PC?

Instantly Available Technology Boosts PC Energy Savings and Improves PC's Ease of Use at full system capability

Wouldn't it be nice if your personal computer is ready when you are, just like any home appliance, with just a touch of a button? How about keeping your personal computer available 24 hours a day to answer phones, receive faxes, and connect users to each other, with power consumption no more than a night light?

It's here the Instantly Available PC is here to bring these new capabilities to PC users!

With an Instantly Available PC, users can allow their PCs to power down to a very deep sleep state, consuming very little power, while retaining the capability to respond to various external or user programmed events such as a phone call, network alerts or a backup procedure. And the wakeup is quick, within a few seconds. So no more time-consuming shutdown/restart/reboot process to interrupt and resume operation!

7.2 Core Technology Suspend to RAM (S3)

The ideal sleep state with the lowest power consumption for an Instantly Available PC is **Suspend to RAM (STR)**. In this state over 95% of the PC's power is shut off while the system context is maintained in system memory, enabling a breakthrough in power savings while maintaining full system capability and connectivity.

Suspend To RAM (STR) is defined by the **Advanced Configuration and Power Interface (ACPI)** specification as the **S3** sleep state. ACPI is a power management specification proposed by Intel, Toshiba and Microsoft, which makes hardware status information available to the operating system and is an Operating System Directed Power Management.

INSTANTLY AVAILABLE PC

APM vs. ACPI

The old generation APM (Advanced Power Management) is a BIOS directed power management can be activated to save energy, but at the expense of system performance and/or connectivity due to its unawareness of the system states.

With ACPI and Suspend to RAM technology, the user will not have to make any tradeoffs when it comes to power management. Network and modem connections will still be there and you will enjoy full system capabilities along with aggressive power management.

7.3 The Key Ingredients

- ▶ An ACPI-enabled Operating System such as Microsoft Windows 98 or Windows 2000 family is required to direct the system-wide power management.
- ▶ BIOS on Motherboard must support **ACPI** and **Suspend to RAM (STR)** sleep state.
- ▶ Hardware circuits, especially **Auxiliary Power Source** and **Split Power Planes** must be implemented on motherboard.
- ▶ Add-on adapters must support ACPI capabilities to make whole system **Instantly Available**. Refer to Add-on Device Compatibility List.
- ▶ ATX power must comply with **ATX 2.01** specification (Provide more than **720mA** Stand-By current at 5V)

7.4 Installation

Mainboard BIOS

Enable the ACPI option provided in the BIOS by:

1. Enter **Power Management Setup** of the BIOS.
2. Set **ACPI function** to **Enabled**.
3. Set **ACPI Suspend Type** to **S3 (STR)**.

Operating System

If your existing 98 system is in APM mode, update the system to ACPI mode as follows:

1. Boot-up with Windows 98.
2. Open the **"Control Panel"** and double-click the **"System"** icon.
3. Click the **"Device Manager"** Tab and then the **"System devices"**.
4. Double-click the **"Plug and Play BIOS"**.
5. Click the **"Driver"** Tab and choose **"Update Driver"**.
6. **"Update Device Driver Wizard"** starts. Click on the **"Next"** button.
7. The Wizard provides a choice between having the Wizard search for a better driver than the one in use or displaying a list of drivers from a specific location. Choose **"Display ..."** and click on the **"Next"** button.
8. Select **"Show all hardware"** and then **"Advanced Configuration and Power Interface (ACPI) BIOS"**.
9. Click on the **"Next"** button.
10. An **"Update Driver Warning"** dialog box appears. Click on the **"Yes"** button.
11. **"Update Device Driver Wizard"** will start again. Click on the **"Next"** button.
12. When copying files to the system is completed, click on the **"Finish"** button.
13. Restart the computer. Your windows 98 system is in the ACPI mode.

INSTANTLY AVAILABLE PC

7.5 Using Suspend to RAM

How to put your system into Suspend to RAM (STR) sleep state

There are several ways to initiate Suspend to RAM (STR):

Note: The Message LED should be blinking while system is in standby, Suspend to RAM mode. Depending on the mainboard and the chassis designs, the Message LED may be the Power LED or other LED on the front panel of the chassis.

Using the mouse button:

1. From the "**Start**" menu in Windows 98, select "**Shut Down**".
2. Select "**Stand by**" in the Shut Down Windows dialog box.
3. Press "**OK**" to enter the "**Suspend to RAM(STR)**" sleep state.

Setting the standby time

1. Enter "**Control Panel**".
2. Double-click the "**Power Management**" icon.
3. "Power Management Properties" dialog box appears. Select "**Power Schemes**" tab.
4. Use "**System standby**" option to set the time for the system to automatically enter standby mode when the system is not in use.

Using the system power button:

1. Enter "**Control Panel**".
2. Double-click the "**Power Management**" icon.
3. In the Power Management Properties dialog box, select "**Advanced**" tab.
4. Define the System Power Button to be "**Standby**" or "**Shutdown**":
 - **Standby**
When the power switch of the front bezel or "**Sleep**" key of the Windows 98 keyboard is pressed, Windows 98 will enter "**Suspend to RAM**" mode and later can be waken up by pressing the "**Wakeup**" key or power switch.
Now you can press the Power on button to enter the "**Suspend to RAM (STR)**" sleep state
 - **Shutdown**
System is turned off almost immediately without corrupting the data.

INSTANTLY AVAILABLE PC

Using the Windows 98 keyboard buttons:

Press the "**Sleep**" button to enter the Suspend to RAM mode.

Note:

1. The "**Power Off**" button on the Windows 98 keyboard can also be used to enter the standby mode as described above.
2. You need to set the mainboard BIOS to use the "**Wakeup**" button. Please see the following section.

How to recover your system from "Suspend to RAM (STR)" sleep state

You can set the way to wake up the system from the mainboard BIOS Setup:

At the Integrated Peripherals Setup Screen, under "Wake Up Events":

- › **Keyboard Resume** Enabling this option allows pressing any key on the keyboard to wake up a system which has been powered down.
- › **Wake Up On LAN/Ring** An input signal on the serial Ring Indicator (RI) line in other words, an incoming call on the modem (either external modem or internal modem card) power on the system.

With a LAN card installed, the Wake-up On LAN function allows the network to wake up a Soft Power Down (Soft-Off) PC.

- › **RTC Alarm Resume** - When enabled, the system will automatically power on or returns to full power out of suspend/standby mode at the time and date of the month (0 for daily) specified.

7.6 Related Documents

- › ACPI, Advanced Configuration and Power Interface Revision 1.0b, <http://www.teleport.com/~acpi/spec.htm>
- › ACPI Implementers' Guide, <http://www.teleport.com/~acpi/impguid.htm>
- › Instantly Available PC Technology, <http://developer.intel.com/technology/iapc/>
- › OnNow Whitepapers, <http://www.microsoft.com/hwdev/onnow.htm/>

SOFTWARE INSTALLATION

8. Software Installation

Included in your mainboard package you can find a CD-ROM containing support drivers and utilities. Just insert the CD-ROM, and from the Autorun screen, click the driver/utility that you want to install. Follow the on-screen instructions to complete the installation.

Note: The Support CD contents are subject to change at any time without notice.



Setup Items

Install Via PCI Bridge Driver

Install PCI Bridge Driver for Windows 95/98/NT/2000.

Install Via VxD Driver

Install VxD Driver for Windows 95/98/NT/2000.

Install Sound chip Driver (For On-board Audio Only)

Install the drivers and utilities needed to run the on-board audio AC97 codec chipset.

Trend PC-Cillin Anti-Virus Software

Install the PC-Cillin virus protection software. View the readme for more information.

SOFTWARE INSTALLATION

Install Via IDE Bus Master Driver

Install Bus Masster IDE driver for Windows 95/98/NT/2000.

Install Via Mini-Port Driver

Install Mini-Port Driver for Windows 95/98/NT/2000.

HardWare Monitoring Utility

Installs this utility to monitor yours computer's Fan, temperature and voltages.

Install Adobe Acrobat Reader

Installs this Adobe Acrobat Reader to read "pdf" files format.

Exit

Exits the CD Setup Items Menu.

Operating Systems

This mainboards passed testing on most operating system, the OS shown in these sections will be Microsoft's Windows 98. You should always use the latest OS and updates when using new hardware to ensure full compliancy. For Windows 95, you must use OSR 2.0 or later. For Windows NT 4.0, you must use Service Pack 3.0 or later.

Microsoft Window 98

When Windows 98 is installed for the first time. System will Subsequent restarts with the plug and play initializing the "Add New Hardware Wizard" and may attempt to install the a Windows default driver from its system registry. When prompted to restart, Select **NO** and then follow the normal setup procedure later in this section.

NOTE: Because there are various mainboard settings, options, and expansion cards, the following can only be uses as a guide and general reference and not an exact reflection of your system.

SOFTWARE INSTALLATION

8.1 Install Via PCI Bridge Driver

Insert the Support CD that shipped with the motherboard into your CD-ROM drive or double-click the CD drive icon in **"My computer"** to bring up the setup screen.

Step 1



Step 3

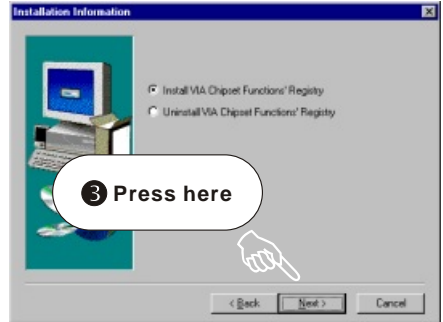

Step 2

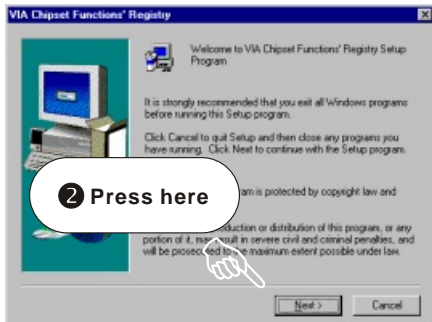

Step 4



SOFTWARE INSTALLATION

8.2 Install Via VxD Driver

Insert the Support CD that shipped with the motherboard into your CD-ROM drive or double-click the CD drive icon in **"My computer"** to bring up the setup screen.

Step 1

1 Press here



Step 3

3 Press here



Step 2

2 Press here



Step 4

4 Press here



SOFTWARE INSTALLATION

8.3 Install Sound chip Driver (For with onboard audio only)

Insert the Support CD that shipped with the motherboard into your CD-ROM drive or double-click the CD drive icon in "My computer" to bring up the setup screen.

Step 1



Step 3



Step 2



Step 4

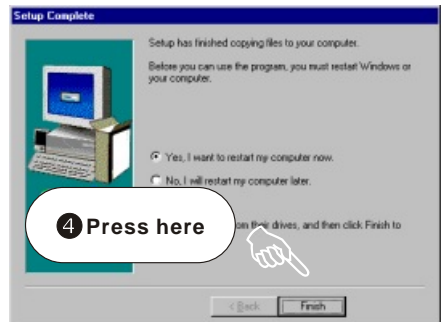

SOFTWARE INSTALLATION

8.4 Trend PC-Cillin Anti-Virus Software

Insert the Support CD that shipped with the motherboard into your CD-ROM drive or double-click the CD drive icon in **"My computer"** to bring up the setup screen.

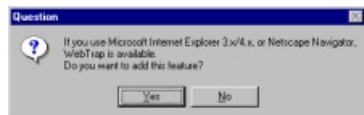
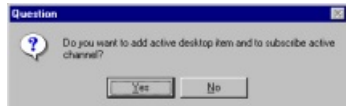

SOFTWARE INSTALLATION

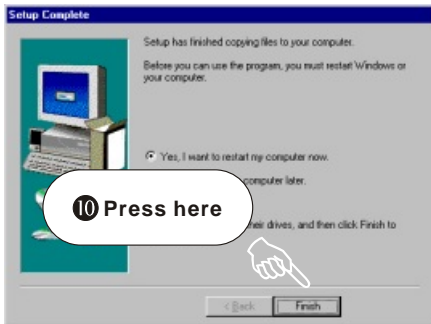
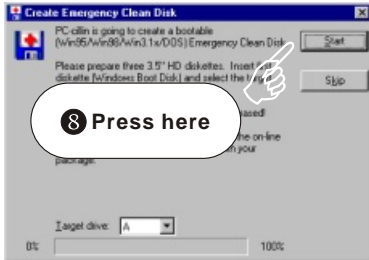

SOFTWARE INSTALLATION

8.5 Install VIA IDE Bus Master Driver

Insert the Support CD that shipped with the motherboard into your CD-ROM drive or double-click the CD drive icon in **"My computer"** to bring up the setup screen.

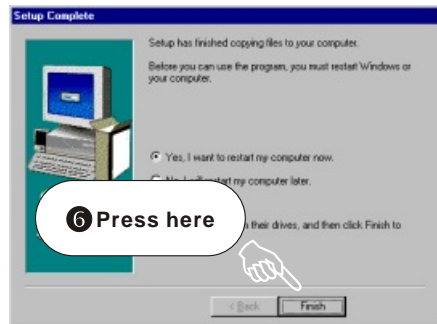
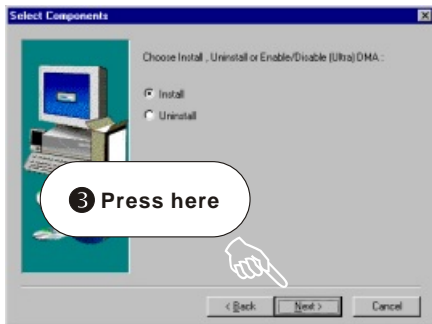
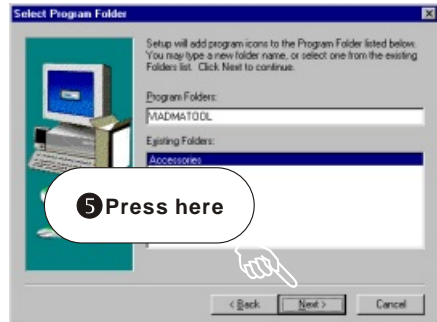

SOFTWARE INSTALLATION

8.6 Install Via Mini-port Driver

Insert the Support CD that shipped with the motherboard into your CD-ROM drive or double-click the CD drive icon in **"My computer"** to bring up the setup screen.

Step 1

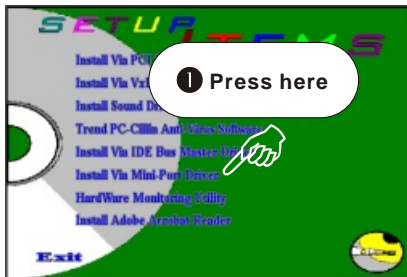

Step 3

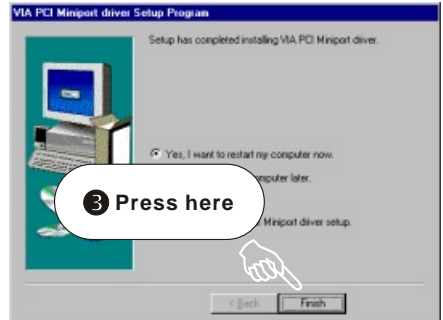

Step 2

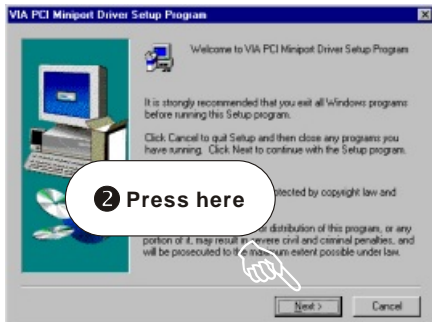

SOFTWARE INSTALLATION

8.7 HardWare Monitoring Utility

Insert the Support CD that shipped with the motherboard into your CD-ROM drive or double-click the CD drive icon in **"My computer"** to bring up the setup screen.

Step 1



Step 3

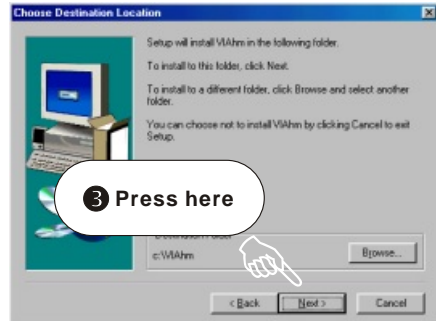

Step 2



Step 4



SOFTWARE INSTALLATION

8.8 Install ADOBE Acrobat Reader V4.0

Insert the Support CD that shipped with the motherboard into your CD-ROM drive or double-click the CD drive icon in **"My computer"** to bring up the setup screen.

