911CF/912CF/913CF
USER'S MANUAL

3D-AGP VGA / 3D- Audio M/B

FOR Pentium[®] II/ III OR SOCKET 370

The author assumes no responsibility for any errors or omissions which may appear in this document nor does it make a commitment to update the information contained herein.

NO. G03-911CFR5A

Release date: OCT 2000

**** Year 2000 compliant ****

Trademark:

- * Pentium is registered trademark and Celeron is a trademark of Intel corporation, the other names and brands are the property of their respective owners.
 - * Specifications and Information contained in this documentation are furnished for information use only, and are subject to change at any time without notice, and should not be construed as a commitment by manufacturer.
-
-

TABLE OF CONTENT

Chapter 1

1-1 Preface.....	1
1-2 Key Feature.....	1

Chapter 2

Hardware Installation.....	3
2-1 Unpacking.....	3
2-2 The Diagram of 911CF/912CF/913CF.....	4
2-3 Quick Reference for Jumpers, Connectors & Expansion Socket.....	5
2-4 Installation Steps.....	6
2-5 Jumper Settings.....	6
2-6 System Memory (DRAM).....	8
2-7 Central Processing Unit (CPU).....	8
2-8 Expansion Cards.....	9
2-9 External Connectors.....	10

Chapter 3

AWARD BIOS SETUP.....	15
3-1 STANDARD CMOS SETUP.....	16
3-2 BIOS FEATURES SETUP.....	19
3-3 Advanced Chipset Features Setup.....	21
3-4 Integrated Peripherals.....	23
3-5 POWER MANAGE MENT SETUP	25
3-6 PnP/PCI CONFIGURATION SETUP.....	27
3-7 PC Health Status.....	29
3-8 Frequency/Voltage Control.....	29
3-9 Defaults Menu.....	30
3-10 Supervisor/User Password Setting.....	30
3-11 EXIT Selecting.....	31
3-12 POST Messages.....	31
3-13 POST Codes.....	35

Chapter 4

911CF/912CF/913CF Driver Installation.....	41
4-1 Software Installation	41
4-2 Suspend To RAM (STR).....	42
4-3 Keyboard Password/Hot-Key/PS/2 Mouse Power On.....	43
4-4 911CF/912CF/913CF QUICK GUIDE.....	44

APPENDIX-A Magic Install

Chapter 1

1-1 Preface

Thank you for chosen [911CF/912CF/913CF](#) mainboard. It is a multifunction motherboard with most flexibility you can find in today's computer market. The motherboard integrate both Intel Pentium®II/Pentium®III * & Celeron™ (Slot 1 & Socket 370) processor interface into a compact PC/AT compatible system along with PCI local bus and the most recent interface AMR (Audio/Modem/ Riser card). Moreover, this motherboard using newest DDM (Dynamic Display Memory) architecture to increase systems display performance and many other new feature that meets future specification.

1-2 Key Feature

The [911CF/912CF/913CF](#) are design for the PC user who wants highest possible quality and value in a small package . This motherboard include:

- **Support Jumperless solution, can setting Front Side Bus Frequency (CPU Host Clock), and CPU ratio in BIOS SETUP “Frequency / Voltage Control“.**
- **Built-In High performance 3D AGP VGA:**
 - * Support 1MB share memory for VGA.
 - * Include 4MB Display Cache (For [912CF/913CF](#) only).
 - * 3D Hyper Pipelined Architecture.
 - * 3D Graphics Visual Enhancements.
 - * 3D Graphics Texturing Enhancements.
 - * Up to 1600x1200 in 8-bit Color at 85Hz refresh.
 - * H/W Motion Compensation Assistance for S/W MPEG2 Decode.
 - * Software DVD at 30fps.
- **Built-In High performance 3D Audio:**
 - * Fully Compliant AC97 Analog I/O Component.
 - * 48-Terminal TQFP package.
 - * Multibit $\Sigma\Delta$ Converter Architecture for improved S/N ratio greater than 90dB.
 - * 16-Bit Stereo Full-Duplex Codec.
 - * 4 Analog Line-Level Stereo Input.
 - * High Quality CD Input with Ground Sense.
 - * Stereo Line Level Output.
- **Multi-Speed Support :** Provide 66/75/83/95/100/112/117/124/133MHz Front Side Bus Frequency to support Intel Pentium®II, Pentium®III .Celeron processor for slot 1 interface or Intel Celeron PPGA on a ZIF socket 370 interface.
- **Chipset:** 810 Chipset for [911CF](#); Intel 810 DC-100 Chipset for [912CF](#); 810E Chipset for [913CF](#).
- **DRAM Memory Support:** support two 168-pin DIMMS(3.3V)from a memory size between 8MB to 256MB using 16Mb/64Mb technology or 512MB using 128Mb technology .
- **AMR and PCI expansion Slots:** Provide one AMR slot, four PCI slot.

-
-
- **Super Multi-I/O:** Provides two high-Speed UART compatible serial ports and one parallel port with EPP and ECP capabilities. Two floppy drives of either 5.25" or 3.5" (1.44MB or 2.88MB) are also supported without an external card.
 - **PCI Bus Master IDE Controller and ULTRA DMA 66 :** On-board PCI Bus Master IDE controller with two connectors that supports four IDE devices in two channels, provides faster data transfer rates, and supports Enhanced IDE devices such as Tape Backup, CD-ROM, ZIP, LS-120 Drives. This controller also supports PIO Modes and Bus Master IDE DMA 33/66 Mbyte/Second.
 - **ACPI supporting for OS Directed Power Management**
 - Keyboard/PS/2 Mouse Power On:** When use ATX power supply and JP3 1-2 closed, choose power on function by password in BIOS , can control power supply on by keyboard instead of power button .
 - Ring-in Wake up:** When Ring-In the system can wake up from SMI Mode.
 - Ring-in Power On:** When Ring-In the system can power on automatic by this function.
 - Wake on LAN:** When Wake on LAN the system can power on automatic by this function.
 - RTC Power On:** Enabled RTC Power On function, you can setting RTC alarm to power on the system at the time length you setting .
 - Power Button:** Press the button will place the system power on/off.
 - Support Software Power OFF Function.**
 - Support Swap PS2 keyboard & PS2 Mouse Function.**
 - **Power Support:** Efficient PWM switching power instead of traditional Linear Voltage Regulator to prevent power component from being burned-out.
 - **Meets PC99 Requirements.**
 - **Optional IRDA and PS/2:** This motherboard supports an dedicated 16C550 standard UART, supporting infrared communication module for wireless interface and PS/2 mouse cable set.
 - **USB Port Connector:** This motherboard supports two USB port connectors for USB devices.
 - **PC Health Monitoring :** To track PC CPU temperature, system voltage and fan speed. When current temperature over warning temperature system will have alarm to warning.
 - **AC recovery ON/OFF control by BIOS**
 - **Support Suspend to RAM in ACPI function (for 912CF/913CF only)**
 - **Micro ATX Form Factor:** Dimensions 19cm x 24.5cm.

Chapter 2

Hardware Installation

2-1 Unpacking

This mainboard package should contain the following:

- The [911CF/912CF/913CF](#) mainboard
- USER'S MANUAL for mainboard
- Cable set for Ultra DMA 66 IDE x1, Floppy x1 ,COM x1
- CD for Drivers PACK

The mainboard contains sensitive electronic components which can be easily damaged by electron-static, so the mainboard should be left in its original packing until it is installed.

Unpacking and installation should be done on a grounded anti-static mat.

The operator should be wearing an anti static wristband, grounded at the same point as the anti-static mat.

Inspect the mainboard carton for obvious damage. Shipping and handling may cause damage to your board. Be sure there are no shipping and handling damages on the board before proceeding.

After opening the mainboard carton, extract the system board and place it only on a grounded anti-static surface component side up. Again inspect the board for damage.

Press down on all of the socket IC's to make sure that they are properly inserted. Do this only on with the board placed on a firm flat surface.

Warning: Do not apply power to the board if it has been damaged.

You are now ready to install your mainboard. The mounting hole pattern on the mainboard matches the Micro ATX system board.

It is assumed that the chassis is designed for a standard Micro ATX [™] main board mounting. Place the chassis on the anti-static mat and remove the cover.

Take the plastic clips, Nylon stand-off and screws for mounting the system board, and keep them separate.

2-2 911CF/912CF/913CF Motherboard Diagram

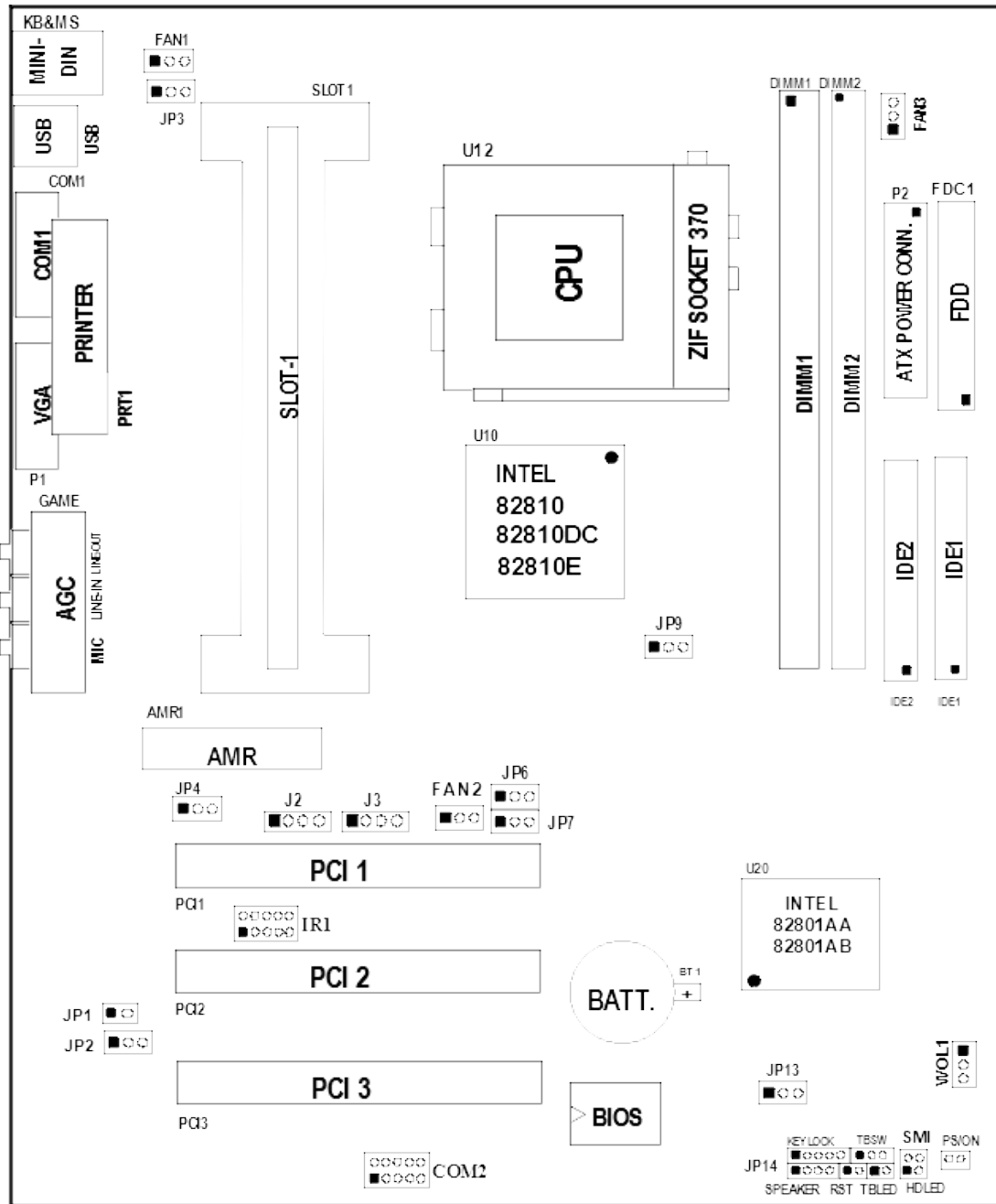

Figure 2-1

911CF **82810+82801AA**
912CF **82810DC+82801AA**
913CF **82810E+82801AA**

2-3 Quick Reference for Jumpers, Connectors & Expansion Socket

Jumpers

Jumper	Name	Description	Page
JP6,JP7,JP9	CPU Bus Frequency Selection	Refer to Page 6	p. 6
JP13	CMOS RAM Clear	1-2 Normal ,2-3 Clear CMOS	p. 6
JP4	Codec Master/Slave Mode Control	1-2 : Slave , 2-3 : Master	p. 7
JP1	Case cover open detection	2-Pin Block	p. 7
JP2	Clear Keyboard Power On Password setting	1-2 Normal , 2-3 Clear setting	p. 7
JP3	Keyboard Power on Function	1-2 : Enabled , 2-3 : Disabled	p. 8

Connectors

Connector	Name	Description	Page
P2	ATX Power Connector	20-Pin Block	p.10
KB&MS	PS/2 Keyboard/PS/2 Mouse	6-Pin Female	p.10
USB	USB Port Connector	5-Pin Connector	p.10
PRINT	Parallel Port Connector	26-Pin Female	p.10
VGA	VGA Connector	15-Pin Female	p.11
AGC	Audio/Game Connector	15-pin Connector + 3phone jack	p.11
COM1	Serial Port COMA	9-Pin Block	p.11
COM2	Serial Port COMB	10-Pin Block	p.12
FDD	Floppy Driver Connector	34-Pin Block	p.12
IDE1	Primary IDE Connector	40-Pin Block	p.12
IDE2	Secondary IDE Connector	40-Pin Block	p.12
HDLED	IDE activity LED	2-Pin Connector	p.13
JP14	Front Panel Connector	16-Pin Block	p.13
IR1	Infrared Module Connector	10-Pin Block	p.13
FAN1,FAN2,FAN3	FAN Connector	Extra fanning system connectors	p.14
PS-ON	ATX power button/soft power button	2-Pin Connector	p.14
J2	CD-Audio/Panasonic	4-pin Block	p.14
J3	CD-Audio/Sony	4-pin Block	p.14
WOL1	Wake On LAN	3-pin Block	P.14

Expansion Sockets

Socket/Slot	Name	Description
DIMM1,DIMM2, Slot1	DIMM Module Socket	168-Pins DIMM SDRAM Module Expansion Socket
Zip Socket370	CPU Socket	Celeron PPGA CPU Socket
AMR1	AMR SLOT	Modem Riser Card Slot
PCI1, PCI2,PCI3	PCI Slot	32-bits PCI Local Bus Expansion slots

2-4 Installation Steps

Before using your computer, you must follow the steps as follows:

1. Set Jumpers on the Motherboard
2. Install the CPU
3. Install DRAM Modules
4. Install Expansion card
5. Connect Cables, Wires, and Power Supply

2-5 Jumper Settings

1. CPU Bus Frequency Selection : JP6,JP7,JP9

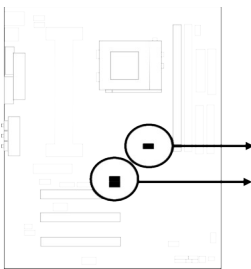

CPU Bus Frequency : JP6,JP7,JP9

JP6	JP7	JP9	CPU/SDRAM	Remark
2-3	2-3	1-2	66MHz/100MHz	
2-3	1-2	2-3	100MHz/100MHz	
1-2	1-2	2-3	133MHz/100MHz	For 913CF only
1-2	2-3	2-3	133MHz*/133MHz*	For 912CF only

❖ *Your Memory must meet PC133 compliant SDRAM chip and specified condition*

Note : SDRAM clock Asynchronous as CPU Bus frequency allows user using slower/faster speed of SDRAM when CPU clock is different with SDRAM clock

※ Users also can setting the CPU Bus frequency and CPU ratio in the “Frequency / Voltage Control “ in BIOS SETUP.

Table for the Pentium II/III and Celeron (Slot 1 and Socket 370) CPU

CPU Type	CPU Clock	Ratio	CPU Frequency
Pentium II 266 , Celeron-266	66 MHz	4.0X	266 MHz
Pentium II 300 , Celeron-300/300A	66 MHz	4.5X	300 MHz
Pentium II 333 , Celeron-333	66 MHz	5.0X	333 MHz
Celeron-366	66 MHz	5.5X	366 MHz
Celeron-400	66 MHz	6.0X	400 MHz
Celeron-433	66 MHz	6.5X	433 MHz
Pentium II 350	100 MHz	3.5X	350 MHz
Pentium II 400	100 MHz	4.0X	400 MHz
Pentium II 450, Pentium III 450	100 MHz	4.5X	450 MHz
Pentium III 500	100 MHz	5.0X	500 MHz
Pentium III 550	100 MHz	5.5X	550 Mhz
Pentium III 600	100 MHz	6.0X	600 Mhz

2. CMOS RAM Clear: JP13 (Yellow color selector)

WARNING: Make sure your computer is POWER OFF when you CLEAR CMOS.

Connect a jumper Cap over this jumper for a few seconds, will clears information stored in the CMOS RAM Chip that input by user, such as hard disk information and passwords. After CLEAR CMOS, you must enter the BIOS setup (by holding down during power-up) to re-enter BIOS information (see BIOS SETUP).

Selections

JP13

Normal	1-2 (Default)
Clear CMOS	2-3 (momentarily)

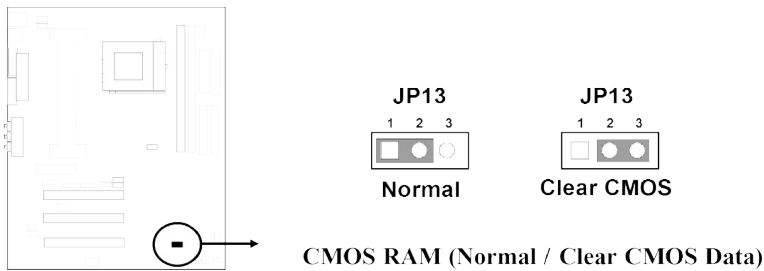

3. Codec Master / Slave Mode Control: JP4

Allow you to change on-board Codec mode from Master to Slave. The default setting for on-board Codec is set to Master. However,if your MR card request Master mode, please change this setting to Slave mode.

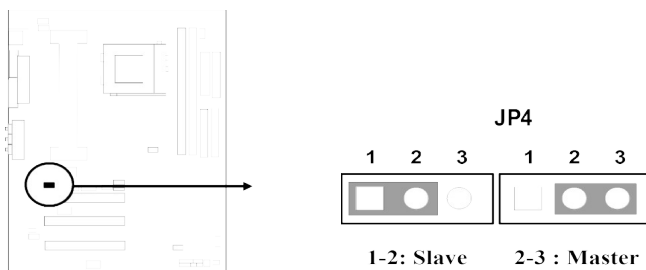

4. Case cover open detection: JP1

This function requires a 2-wire cable supply from case manufacturer. It detects whether your case cover is open or close status

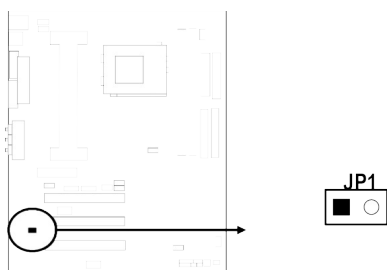

5. Clear Keyboard Power On Password setting: JP2

Connect a jumper Cap over this jumper for a few seconds will clears keyboard power on password that stored in the W83627 chip input by user.

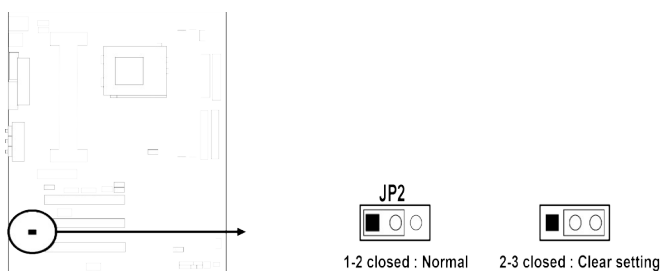

6. Keyboard Power on Function: JP3

This function only support when use ATX power supply . When choose 1-2 closed and use ATX power supply , you can choice power on system by power button or keyboard in “Power On Function” item of “Integrated Peripherals Setup”.

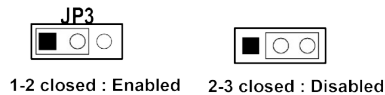
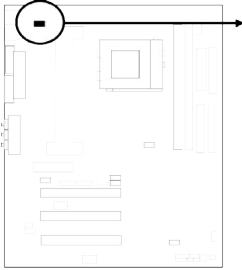

2-6 System Memory (DRAM)

This main board supports two 168-pins DIMM modules to the Max Memory Size of 512MB, using 128MB technology.

DIMM 1	DIMM 2	System can be Accept or Not
168-pin DIMM	×	Accept
168-pin DIMM	168-pin DIMM	Accept
×	168-pin DIMM	Accept

2-7 Central Processing Unit (CPU)

2-7-1 The motherboard provides a Slot-1 for Pentium II processor. The CPU on board must have a fan or heat sink attached to prevent overheating.

WARNING: *Without a fan or heat sink, the CPU will overheat and cause damage to both the CPU and the motherboard.*

To install a CPU, first turn off your system and remove its cover. Locate the Slot- 1 and place RETENTION MODULE as following:

IMPORTANT: *You must set jumper JP6,JP7,JP9 for “Bus Frequency Selection” on [page6](#) depending on the CPU that you install.*

1. Attach heat sink to the CPU.
2. Place Part A on slot-1 and gently screw four corners on top of the mother- board.

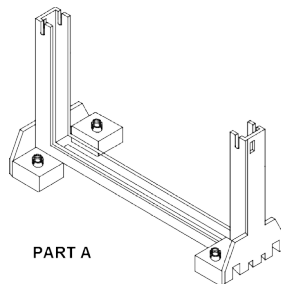
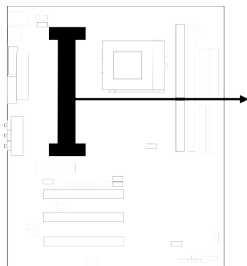

2-7-2 The mainboard provides a 370-pin ZIF Socket 370. The CPU on motherboard must have a fan attached to prevent overheating.

To install a CPU, first turn off your system and remove its cover. Locate the ZIF socket and open it by first pulling the lever sideways away from the socket then upwards to a 90-degree right angle. Insert the CPU with the white dot as your guide. The white dot should point towards the end of the level. The CPU has a corner pin for three of the four corners, the CPU will only fit in the one orientation as shown as follow. With the added weight of the CPU fan, no force is required to insert the CPU. Once completely inserted, hold down on the fan and close the socket's lever.

IMPORTANT: You can setting the CPU ratio and Host Frequency in the BIOS setup on page30

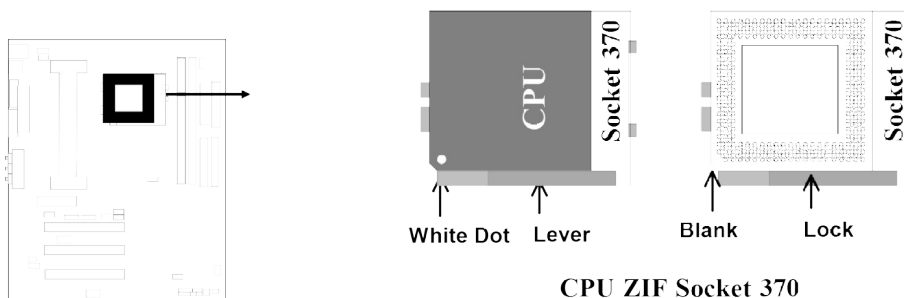

CPU ZIF Socket 370

2-8 Expansion Cards

You must read the documentation come with expansion card for any hardware or software settings that may be required to setup your specific card.

Installation Procedure:

1. Read the documentation from your expansion card.
2. Set any necessary jumpers on your expansion card.
3. Remove your computer's cover.
4. Remove the bracket on the slot you intend to use.
5. Carefully align the card's connectors and press firmly.
6. Secure the card on the slot with the screw you remove in step 4.
7. Replace the computer's cover.
8. Setup the BIOS if necessary.
9. Install the necessary software drivers for your expansion card.

Assigning IRQs for Expansion Cards

Some expansion cards may require an IRQ to operate. Generally an IRQ must be exclusively assigned to only one device. In a standard design there are 16 IRQs available but most of them are occupied by the system and leaves 6 free for expansion cards.

With most recent device, the BIOS automatically assign an IRQ number to PCI expansion cards. Please make sure there are no any of two devices use same IRQs, otherwise your computer may experience some problems when those two devices are in use at the same time.

Assigning DMA Channels for Expansion Cards

Some devices may also need to use a DMA (Direct Memory Access) channel. DMA assignments for this motherboard are handled the same way as the IRQ assignment process described above. You can select a DMA channel in the PCI and PnP configuration section of the BIOS Setup utility.

2-9 External Connectors

1. Power Connector: ATX Power Connector (20-pin block): P2

ATX Power Supply connector. This is a new defined 20-pins connector that usually comes with ATX case. The ATX Power Supply allows to use soft power on momentary switch that connect from the front panel switch to 2-pins Power On jumper pole on the motherboard. When the power switch on the back of the ATX power supply turned on, the full power will not come into the system board until the front panel switch is momentarily pressed. Press this switch again will turn off the power to the system board.

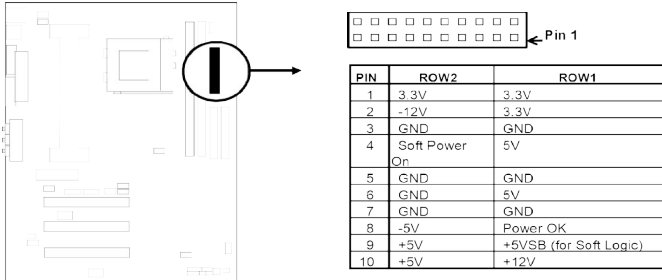

2. PS/2 Mouse & PS/2 Keyboard Connector: KB&MS

If you are using a PS/2 mouse, you must purchase an optional PS/2 mouse set which connects to the 5-pins block and mounts to an open slot on your computer's case.

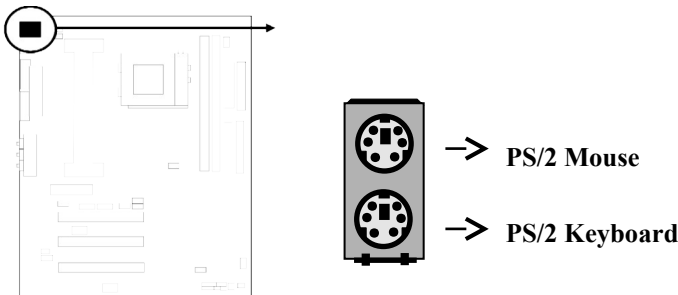

3. USB Port connector: USB

The connectors are 4-pins connector that connect USB devices to the system board.

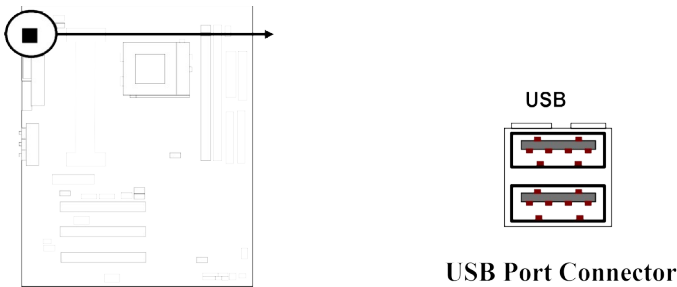

4. Parallel Port Connector (25-pin female): PRINT

Parallel Port connector is a 25-pin D-Subminiature Receptacle connector. The On-board Parallel Port can be disabled through the BIOS SETUP. Please refer to Chapter 3 "INTEGRATED PERIPHERALS SETUP" section for more detail information.

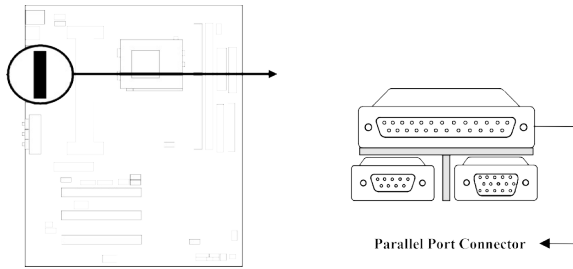

5. VGA Connector: VGA

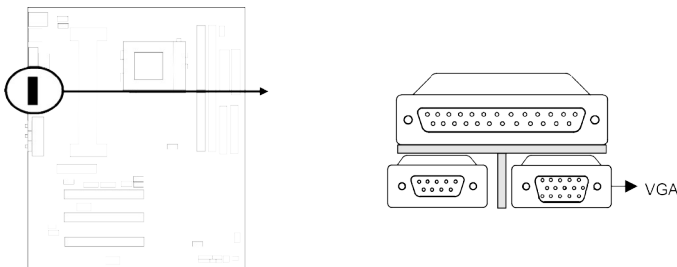

6. Audio and Game Connector : AGC

This Connector are 3 phone Jack for LINE-OUT,LINE-IN,MIC and a 15-pin D-Subminiature Receptacle Connector for joystick/MIDI Device.

Line-out : audio output to speaker

Line-in : audio input to sound chip

MIC : Microphone Connector

Game/MIDI : for joystick or MIDI Device

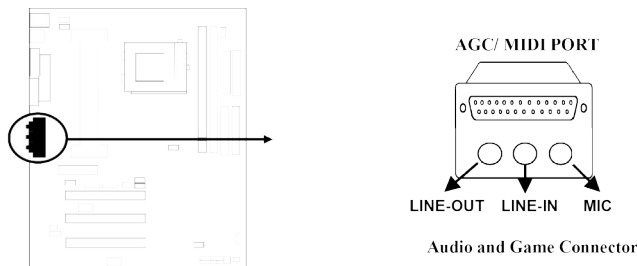

7. Serial Port COMA: COM1

COMA is the 9-pin D-Subminiature mail connector. The On-board serial port can be disabled through BIOS SETUP. Please refer to Chapter 3 "INTEGRATED PERIPHERALS SETUP" section for more detail information.

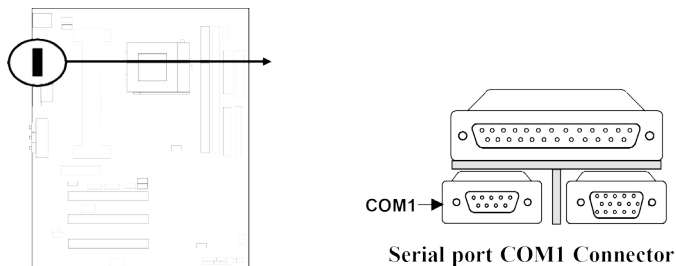

8. Serial Port COMB:COM2

This connector support the provided serial port ribbon cable with mounting bracket. Connect the ribbon cable to this connector and mount the bracket to the case on an open slot.

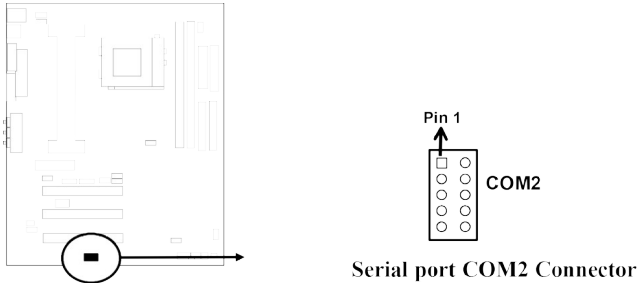

9. Floppy drive Connector (34-pin block): FDD

This connector supports the provided floppy drive ribbon cable. After connecting the single plug end to motherboard, connect the two plugs at other end to the floppy drives.

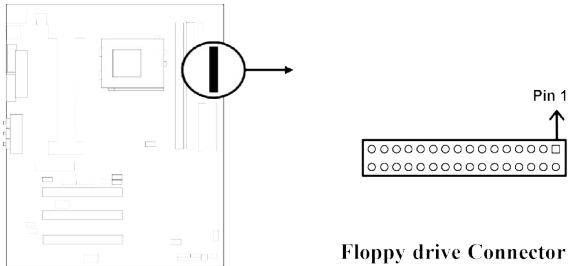

10. Primary IDE Connector (40-pin block): IDE1

This connector supports the provided IDE hard disk ribbon cable. After connecting the single plug end to motherboard, connect the two plugs at other end to your hard disk(s). If you install two hard disks, you must configure the second drive to Slave mode by setting its jumpers accordingly. Please refer to the documentation of your hard disk for the jumper settings.

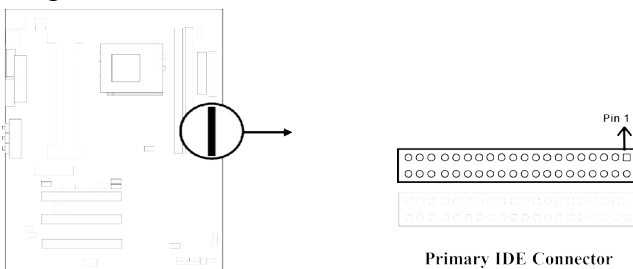

11. Secondary IDE Connector (40-pin block): IDE2

This connector connects to the next set of Master and Slave hard disks. Follow the same procedure described for the primary IDE connector. You may also configure two hard disks to be both Masters using one ribbon cable on the primary IDE connector and another ribbon cable on the secondary IDE connector.

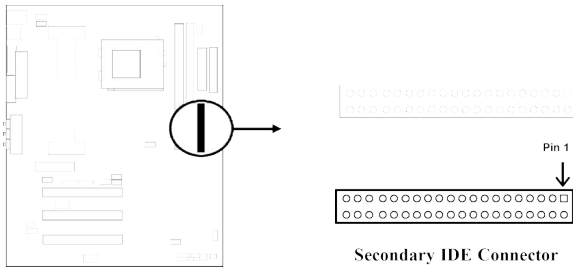

12. IDE activity LED: HDLED

This connector connects to the hard disk activity indicator light on the case.

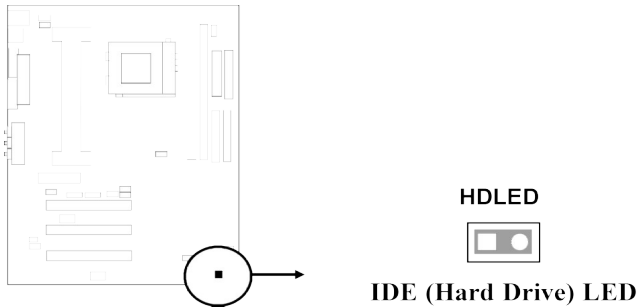

13. Turbo LED switch: TBLED

The motherboard's turbo function is always on. The turbo LED will remain constantly lit while the system power is on. You may wish to connect the Power LED from the system case to this lead. See the figure below.

14. Reset switch lead: RST

This 2-pin connector connects to the case-mounted reset switch for rebooting your computer without having to turn off your power switch. This is a preferred method of rebooting in order to prolong the life of the system's power supply. See the figure below.

15. Keyboard lock switch lead: KEYLOCK

This 5-pin connector connects to the case-mounted key switch for locking the keyboard for security purposes. See the figure below.

16. Speaker connector: SPEAKER

This 4-pins connector connects to the case-mounted speaker. See the figure below.

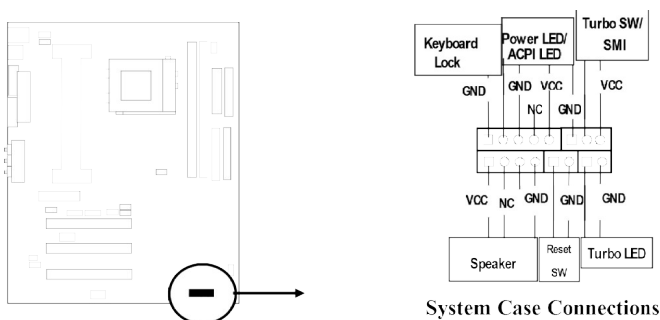

17. IR infrared module connector: IR1

This connector supports the optional wireless transmitting and receiving infrared module. This module mounts to small opening on system cases that support this feature you must also configure the setting through BIOS setup. Use the four pins as shown on the Back View and connect a ribbon cable from the module to the motherboard according to the pin definitions.

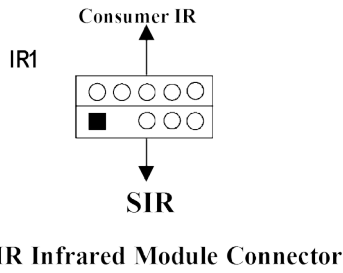
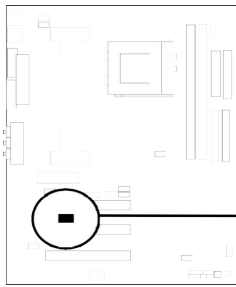

18. FAN connector: FAN1,FAN2 and FAN3

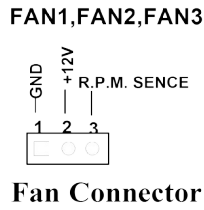
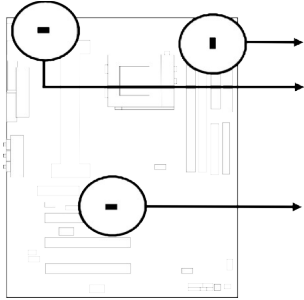

19. Power-On button connector: PS-ON

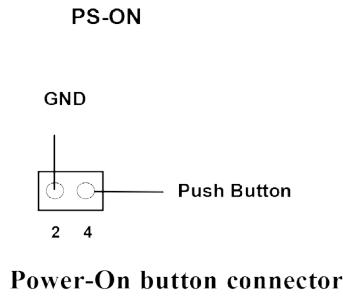
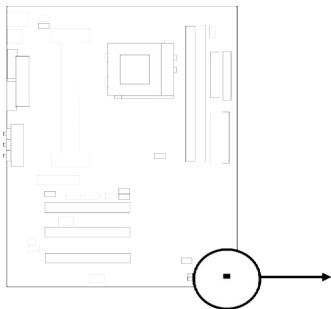

20. CD Audio in connector : J2,J3

J2 and J3 are the connectors for CD-Audio Input signal, please connect it to CD-ROM CD-Audio output connector

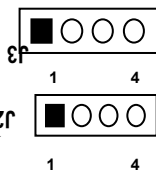
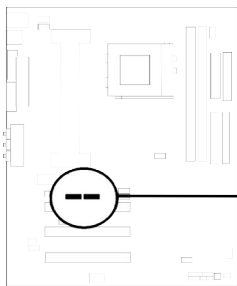

J3 : CD-Audio/Sony

J2 : CD-Audio/Panasonic

21. Wake On LAN connector: WOL1

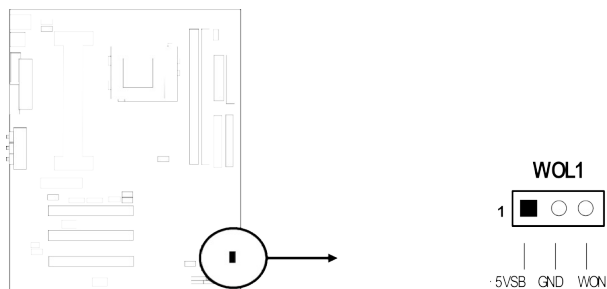

※ **Wake On LAN Function worked only when power supply support 5VSB more than 750mA current.**

Chapter 3

AWARD BIOS SETUP

Once you enter the AwardBIOS™ CMOS Setup Utility, the Main Menu will appear on the screen. The Main Menu allows you to select from several setup functions and two exit choices. Use the arrow keys to select among the items and press <Enter> to accept and enter the sub-menu.

CMOS Setup Utility - Copyright (C) 1984-1998

Standard CMOS Feature Advanced BIOS Feature Advanced Chipset Feature Integrated Peripherals Power Management Setup PnP/PCI Configurations PC Health Status	Frequency/Voltage Control Load Optimal Defaults Load Standard Defaults Set Supervisor Password Set User Password Save & Exit Setup Exit Without Saving
Esc : QUIT F10 : Save & Exit Setup	↑↓←→ : Select Item
Time, Date, Hard Disk Type....	

Figure 3-1

Note that a brief description of each highlighted selection appears at the bottom of the screen.

- ◆ **Setup Items:** The main menu includes the following main setup categories. Recall that some systems may not include all entries.
- ◆ **Standard CMOS Features:** Use this menu for basic system configuration. See Section 2 for the details.
- ◆ **Advanced BIOS Features:** Use this menu to set the Advanced Features available on your

system. See Section 3 for the details.

- ◆ **Advanced Chipset Features:** Use this menu to change the values in the chipset registers and optimize your system's performance. See section 4 for the details.
- ◆ **Integrated Peripherals:** Use this menu to specify your settings for integrated peripherals. See section 4 for the details.
- ◆ **Power Management Setup:** Use this menu to specify your settings for power management. See section 5 for the details.
- ◆ **PnP / PCI Configuration:** This entry appears if your system supports PnP / PCI. See section 6 for the details.
- ◆ **PC Health Status:** Use this menu to show the temperature, FAN Speed, Voltage of the PC Health.
- ◆ **Frequency/Voltage Control:** Use this menu to specify your settings for frequency/voltage control. See section 7 for the details.
- ◆ **Load Standard Defaults:** Use this menu to load the BIOS default values that are factory settings for normal/stable performance system operations. While Award has designed the custom BIOS to normal/stable performance, the factory has the right to change these defaults to meet their needs. See section 8 for the details.
- ◆ **Load Optimal Defaults:** Use this menu to load the Optimal default values for the higher performance for your system to operate. See section 8 for the details.
- ◆ **Supervisor / User Password:** Use this menu to set User and Supervisor Passwords. See section 9 for the details.
- ◆ **Save & Exit Setup:** Save CMOS value changes to CMOS and exit setup. See section 10 for the details.
- ◆ **Exit Without Save:** Abandon all CMOS value changes and exit setup. See section 10 for the details.

3-1 STANDARD CMOS SETUP

The items in Standard CMOS Setup Menu are divided into 10 categories. Each category includes no, one or more than one setup items. Use the arrow keys to highlight the item and then use the <PgUp> or <PgDn> keys to select the value you want in each item.

Standard CMOS Features

Date: Mon, Feb 8 1999 Time: 16:19:20 ➤ IDE Primary Master 2557 MB ➤ IDE Primary Slave None ➤ IDE Secondary Master None ➤ IDE Secondary Slave None Drive A 1.44M, 3.5 in. Drive B None Video EGA/VGA Halt On All Errors Based Memory 640K Extended Memory 64512K Total Memory 65536K	Item Help <hr/> Menu Level ➤ Change the day, month, year and century
↑↓←→Move Enter: Select +/-PU/PD: Value F10:Save ESC: Exit F1:General Help F5:Previous Values F6:Optimal defaults F7:Standard Defaults	

Figure 3-2

Item	Options	Description
Date	Month DD YYYY	Set the system date. Note that the 'Day' automatically changes when you set the date
Time	HH : MM : SS	Set the system time
IDE Primary Master	Options are in its sub menu (described in Table 3)	Press <Enter> to enter the sub menu of detailed options
IDE Primary Slave	Options are in its sub menu (described in Table 3)	Press <Enter> to enter the sub menu of detailed options
IDE Secondary Master	Options are in its sub menu (described in Table 3)	Press <Enter> to enter the sub menu of detailed options
IDE Secondary Master	Options are in its sub menu (described in Table 3)	Press <Enter> to enter the sub menu of detailed options
Drive A Drive B	None 360K, 5.25 in 1.2M, 5.25 in 720K, 3.5 in 1.44M, 3.5 in 2.88M, 3.5 in	Select the type of floppy disk drive installed in your system
Video	EGA/VGA CGA 40 CGA 80	Select the default video device

	MONO	
Halt On	All Errors No Errors All, but Keyboard All, but Diskette All, but Disk/Key	Select the situation in which you want the BIOS to stop the POST process and notify you
Base Memory	N/A	Displays the amount of conventional memory detected during boot up
Extended Memory	N/A	Displays the amount of extended memory detected during boot up
Total Memory	N/A	Displays the total memory available in the system

- ◆ **IDE Adapters:** The IDE adapters control the hard disk drive. Use a separate sub menu to configure each hard disk drive.

Figure3-2-1 shows the IDE primary master sub menu.

CMOS Setup Utility – Copyright © 1984-1998 Award Software
IDE Primary Master

IDE HDD Auto-Detection	Press Enter	Item Help
IDE Primary Master Access Mode	Auto 2557 MB Auto	Menu Level >>
Cylinder	4956	To auto-detect the HDD's size, head... on this channel
Head	16	
Precomp	0	
Landing Zone	4955	
Sector	63	
↑↓←→Move Enter: Select +/-/PU/PD: Value F10:Save ESC: Exit F1:General Help F5:Previous Values F6:Optimal defaults F7:Standard Defaults		

Figure3-1-1 IDE Primary Master sub menu

Use the legend keys to navigate through this menu and exit to the main menu. Use Table 3 to configure the hard disk.

Item	Options	Description
IDE HDD Auto-detection	Press Enter	Press Enter to auto-detect the HDD on this channel. If detection is successful, it fills the remaining fields on this menu.
IDE Primary Master	None Auto Manual	Selecting 'manual' lets you set the remaining fields on this screen. Selects the type of fixed disk. "User Type" will let you select the number of cylinders, heads, etc. Note: RECOMP=65535 means NONE !
Capacity	Auto Display your disk drive size	Disk drive capacity (Approximated). Note that this size is usually slightly greater than the size of a

		formatted disk given by a disk checking program.
Access Mode	Normal LBA Large Auto	Choose the access mode for this hard disk
The following options are selectable only if the 'IDE Primary Master' item is set to 'Manual'		
Cylinder	Min = 0 Max = 65535	Set the number of cylinders for this hard disk.
Head	Min = 0 Max = 255	Set the number of read/write heads
Precomp	Min = 0 Max = 65535	**** Warning: Setting a value of 65535 means no hard disk
Landing zone	Min = 0 Max = 65535	****
Sector	Min = 0 Max = 255	Number of sectors per track

Table 1 Hard disk selections

3-2 BIOS FEATURES SETUP

This section allows you to configure your system for basic operation. You have the opportunity to select the system's default speed, boot-up sequence, keyboard operation, shadowing and security.

CMOS Setup Utility – Copyright © 1984 – 1998 Award Software Advanced BIOS Features

Virus Warning	Enabled	Item Help
CPU Internal Cache	Enabled	
External Cache	Enabled	
CPU L2 Cache ECC Checking	Enabled	Menu Level ➤
Quick Power On Self Test	Disabled	
First Boot device	Floppy	Allows you to choose the
Second Boot device	HDD-0	VIRUS warning feature for
Third Boot device	Floppy	IDE Hard Disk boot sector
Boot other device	Disabled	protection. If this
Swap Floppy Drive	Disabled	function is enabled and
Boot Up Floppy Seek	Disabled	someone attempt to write
Boot Up NumLock Status	Off	data into this area, BIOS
Gate A20 Option	Normal	will show a warning message
Typematic Rate Setting	Disabled	on screen and alarm beep
Typematic Rate (Chars/Sec)	6	
Typematic Delay (Msec)	250	
Security Option	Setup	
OS Select For DRAM > 64MB	Non-OS2	
Report NO FDD For Win 95	No	
↑↓←→Move Enter: Select +/-/PU/PD: Value F10:Save ESC: Exit F1:General Help F5:Previous Values F6:Optimal defaults F7:Standard Defaults		

- ♦ Virus Warning: Allows you to choose the VIRUS Warning feature for IDE Hard

Disk boot sector protection. If this function is enabled and someone attempt to write data into this area, BIOS will show a warning message on screen and alarm beep.

Enabled	Activates automatically when the system boots up causing a warning message to appear when anything attempts to access the boot sector or hard disk partition table.
Disabled	No warning message will appear when anything attempts to access the boot sector or hard disk partition table.

- ◆ **CPU Internal Cache/External Cache:** These two categories speed up memory access. However, it depends on CPU/chipset design.
- ◆ **CPU L2 Cache ECC Checking:** This item allows you to enable/disable CPU L2 Cache ECC checking.

The choice: Enabled, Disabled.

- ◆ **Quick Power On Self Test:** This category speeds up Power On Self Test (POST) after you power up the computer. If it is set to Enable, BIOS will shorten or skip some check items during POST.

Enabled	Enable quick POST
Disabled	Normal POST

- ◆ **First/Second/Third/Other Boot Device:** The BIOS attempts to load the operating system from the devices in the sequence selected in these items.

The Choice: Floppy, LS/ZIP, HDD, SCSI, and CDROM.

Other Boot Device: If this option is enable the Bios will attempt to load operating system from other boot device that is available if the other fails.

- ◆ **Swap Floppy Drive:** If the system has two floppy drives, you can swap the logical drive name assignments.

The choice: Enabled/Disabled.

- ◆ **Boot Up Floppy Seek:** Seeks disk drives during boot up. Disabling speeds boot up.

The choice: Enabled/Disabled.

- ◆ **Boot Up NumLock Status:** Select power on state for NumLock.

The choice: Enabled/Disabled.

- ◆ **Gate A20 Option:** Select if chipset or keyboard controller should control GateA20.

Normal	A pin in the keyboard controller controls GateA20
Fast	Lets chipset control GateA20

- ◆ **Typematic Rate Setting:** Key strokes repeat at a rate determined by the keyboard controller. When enabled, the typematic rate and typematic delay can be selected.

The choice: Enabled/Disabled.

- ◆ **Typematic Rate (Chars/Sec):** Sets the number of times a second to repeat a keystroke when you hold the key down.

The choice: 6, 8, 10, 12, 15, 20, 24, 30.

- ◆ **Typematic Delay (Msec):** Sets the delay time after the key is held down before it begins to repeat the keystroke.

The choice: 250, 500, 750, 1000.

- ◆ **Security Option: Select whether the password is required every time the system boots or only when you enter setup.**

System	The system will not boot and access to Setup will be denied if the correct password is not entered at the prompt.
Setup	The system will boot, but access to Setup will be denied if the correct password is not entered at the prompt.

Note: To disable security, select PASSWORD SETTING at Main Menu and then you will be asked to enter password. Do not type anything and just press <Enter>, it will disable security. Once the security is disabled, the system will boot and you can enter Setup freely.

- ◆ **OS Select For DRAM > 64MB:** Select the operating system that is running with greater than 64MB of RAM on the system.

The choice: Non-OS2, OS2.

- ◆ **Report No FDD For Win 95:** Whether report no FDD for Win 95 or not.

The choice: Yes, No.

3-3 Advanced CHIPSET FEATURES SETUP

CMOS Setup Utility – Copyright © 1984 – 1998 Award Software

Advanced Chipset Features

SDRAM CAS Latency Time	3	Item Help
SDRAM Cycle Time Tras/Trc	6/8	
SDRAM RAS-to-CAS Delay	3	Menu Level ➤
SDRAM RAS Precharge Time	3	
System BIOS Cacheable	Enabled	
Video BIOS Cacheable	Enabled	
Memory Hole At 15M-16M	Disabled	
Delay Transaction	Enabled	
On-Chip Video Window Size	64MB	
* Onboard Display Cache Setting *		
CAS# Latency	3	
Paging Mode Control	Closed	
RAS-to-CAS Override	Closed	
RAS# Timing	Slow	
RAS# Precharge Timing	Slow	
↑↓←→Move Enter: Select +/-/PU/PD: Value F10:Save ESC: Exit F1:General Help F5:Previous Values F6:Optimal defaults F7:Standard Defaults		

This section allows you to configure the system based on the specific features of the installed chipset. This chipset manages bus speeds and access to system memory resources, such as

DRAM and the external cache. It also coordinates communications between the conventional ISA bus and the PCI bus. It must be stated that these items should never need to be altered. The default settings have been chosen because they provide the best operating conditions for your system. The only time you might consider making any changes would be if you discovered that data was being lost while using your system.

- ♦ **DRAM Settings:** The first chipset settings deal with CPU access to dynamic random access memory (DRAM). The default timings have been carefully chosen and should only be altered if data is being lost. Such a scenario might well occur if your system had mixed speed DRAM chips installed so that greater delays may be required to preserve the integrity of the data held in the slower memory chips.
- ♦ **SDRAM CAS Latency Time:** When synchronous DRAM is installed, the number of clock cycles of CAS latency depends on the DRAM timing. You can select SDRAM CAS (Column Address Strobe) latency according to your SDRAM specification

The Choice: 2, 3

- ♦ **SDRAM Cycle Time *Tras/Trc*:** Select the number of SCLKs for an access cycle. *5/7* gives faster performance; and *6/8* gives more stable performance.

The Choice: *5/7, 6/8*.

- ♦ **SDRAM RAS-to-CAS Delay:** This field lets you insert a timing delay between the CAS and RAS strobe signals, used when DRAM is written to, read from, or refreshed. *Fast* gives faster performance; and *Slow* gives more stable performance. This field applies only when synchronous DRAM is installed in the system.

The Choice: 2, 3.

- ♦ **SDRAM RAS Precharge Time:** If an insufficient number of cycles is allowed for the RAS to accumulate its charge before DRAM refresh, the refresh may be incomplete and the DRAM may fail to retain data. *Fast* gives faster performance; and *Slow* gives more stable performance. This field applies only when synchronous DRAM is installed in the system.

The Choice: 2, 3.

- ♦ **System BIOS Cacheable:** Selecting *Enabled* allows caching of the system BIOS ROM at F0000h-FFFFFh, resulting in better system performance. However, if any program writes to this memory area, a system error may result.

The choice: Enabled, Disabled.

- ♦ **Video BIOS Cacheable:** Select Enabled allows caching of the video BIOS, resulting in better system performance. However, if any program writes to this memory area, a system error may result.

The Choice: Enabled, Disabled.

- ♦ **Memory Hole At 15M-16M:** You can reserve this area of system memory for ISA adapter ROM. When this area is reserved, it cannot be cached. The user information of peripherals that need to use this area of system memory usually discusses their memory requirements.

The Choice: Enabled, Disabled.

-
-
- ♦ **Delay Transaction:** The chipset has an embedded 32-bit posted write buffer to support delay transactions cycles. Select *Enabled* to support compliance with PCI specification version 2.1.
The Choice: Enabled, Disabled.
 - ♦ **On-Chip Video Window Size:** Select the on-chip video window size for VGA drive use.
The Choice: 32MB, 64MB, Disabled.
 - ♦ **Onboard Display Cache Setting:** Setting the onboard display cache timing.
 - ♦ **CAS # Latency (for 912CF/913CF):** Select the display cache memory clock cycles of CAS latency depends on the Display Cache DRAM timing , you can choose 2 cycle to get higher performance, and 3 cycle get more stable performance.
The Choice: 2, 3
 - ♦ **Paging Mode Control (for 912CF/913CF):** Select the paging mode control in Display cache memory.
The Choice: Close, Open.
 - ♦ **RAS-to-CAS Override (for 912CF/913CF):** Select the display cache clock periods control by CAS # LT depend on CAS # Latency value , Override(2) gives faster performance.
The Choice: by CAS # LT , Override(2)
 - ♦ **RAS # Timing (for 912CF/913CF):** This item controls RAS# active to Protegra, and refresh to RAS# active delay (in local memory clocks) , *Fast* gives faster performance and *Slow* gives more stable performance.
The Choice: Fast, Slow.
 - ♦ **RAS# Precharge Timing (for 912CF/913CF):** This item controls RAS# precharge (in local memory clocks) , this function is same “ **SDRAM RAS Precharge Time** “.
The choice: Fast, Slow.

3-4 Integrated Peripherals

CMOS Setup Utility – Copyright © 1984 – 1998 Award Software
Integrated Peripherals

OnChip Primary PCI IDE	Enabled	Item Help
OnChip Secondary PCI IDE	Enabled	
IDE Primary Master PIO	Auto	Menu Level 
IDE Primary Slave PIO	Auto	If your IDE hard drive supports block mode select Enabled for automatic detection of the optimal number of block read/write per sector the drive can support
IDE Secondary Master PIO	Auto	
IDE Secondary Slave PIO	Auto	
IDE Primary Master UDMA	Auto	
IDE Primary Slave UDMA	Auto	
IDE Secondary Master UDMA	Auto	
IDE Secondary Slave UDMA	Auto	
USB Controller	Enabled	
USB Keyboard Support	Disabled	
Init Display First	PCI Slot	
AC97 Audio	Enabled	
AC97 Modem	Enabled	
IDE HDD Block Mode	Enabled	
Power on Funtion	BUTTON ONLY	
Onboard FDC Controller	Enabled	
Onboard Serial Port 1	3F8/IRQ4	
Onboard Serial Port 2	2F8/IRQ3	
↑↓←→ Move Enter: Select +/-/PU/PD: Value F10:Save ESC: Exit F1:General Help F5:Previous Values F6:Optimal defaults F7:Standard Defaults		

- ◆ **OnChip Primary/Secondary PCI IDE:** The integrated peripheral controller contains an IDE interface with support for two IDE channels. Select *Enabled* to activate each channel separately.

The choice: Enabled, Disabled.

- ◆ **IDE Primary/Secondary Master/Slave PIO:** The four IDE PIO (Programmed Input/Output) fields let you set a PIO mode (0-4) for each of the four IDE devices that the onboard IDE interface supports. Modes 0 through 4 provide successively increased performance. In Auto mode, the system automatically determines the best mode for each device.

The choice: Auto, Mode 0, Mode 1, Mode 2, Mode 3, Mode 4.

- ◆ **IDE Primary/Secondary Master/Slave UDMA:** Ultra DMA/33 implementation is possible only if your IDE hard drive supports it and the operating environment includes a DMA driver (Windows 95 OSR2 or a third-party IDE bus master driver). If your hard drive and your system software both support Ultra DMA/33, select Auto to enable BIOS support.

The Choice: Auto, Disabled.

- ◆ **USB Controller:** Select *Enabled* if your system contains a Universal Serial Bus (USB) controller and you have USB peripherals.

The choice: Enabled, Disabled.

- ◆ **USB Keyboard Support:** Select *Enabled* if your system contains a Universal Serial Bus (USB) controller and you have a USB keyboard.

The choice: Enabled, Disabled.

- ◆ **Init Display First:** This item allows you to decide to active whether PCI Slot or on-chip VGA first

The choice: PCI Slot, Onboard .

- ◆ **AC97 Audio/Modem:** This item allows you to decide to enable/disable the 810 chipset family to support AC97 Audio/Modem.(* If you don't have Modem/Riser card, you will find a

PCI card with a “!” mark in “OTHER DEVICE “ under” Device Manager”. You can solve this problem by disable “AC97 Modem” under “Integrated Peripherals” option of the BIOS.)

The choice: Enabled, Disabled.

- ◆ **IDE HDD Block Mode:** Block mode is also called block transfer, multiple commands, or multiple sector read/write. If your IDE hard drive supports block mode (most new drives do), select Enabled for automatic detection of the optimal number of block read/writes per sector the drive can support.

The choice: Enabled, Disabled

- ◆ **Power on Function :** Select Keyboard (Hot Key / Pass word) / PS/2 Mouse Power on Function.

The choice: BUTTON ONLY, Keyboard 98, Password, Hot Key, Mouse Left, Mouse Right, Any Key.

Keyboard password: Please refer to page 43 setting hardware for this function .

HotKey Power: This is an option to select the combination of keys to turn on your computer . Please refer to page 43 setting hardware for this function .

The choice: Ctrl+F1 to Ctrl+F12

- ◆ **Onboard FDC Controller:** Select Enabled if your system has a floppy disk controller (FDC) installed on the system board and you wish to use it. If you install and-in FDC or the system has no floppy drive, select Disabled in this field.

The choice: Enabled, Disabled.

- ◆ **Onboard Serial Port 1/Port 2:** Select an address and corresponding interrupt for the first and second serial ports.

The choice: 3F8/IRQ4, 2E8/IRQ3, 3E8/IRQ4, 2F8/IRQ3, Disabled, Auto.

3-5 POWER MANAGEMENT SETUP

The Power Management Setup allows you to configure you system to most effectively save energy while operating in a manner consistent with your own style of computer use.

CMOS Setup Utility – Copyright © 1984 – 1998 Award Software
Power Management Setup

ACPI function	Enabled	Item Help
ACPI Suspend Type	S1(POS)	
Power Management	User Define	Menu Level ➤
Video Off Method	V/H SYNC_Blink	
Video Off In Suspend	Suspend -> Off	
Suspend Type	Stop Grant	
MODEM Use IRQ	3	
Suspend Mode	Disable	
HDD Power Down	Disable	
Soft-Off by PWRBTN	Delay 4 Sec	
Power On by Ring	Disable	
CPU THRM-Throttling	25.0%	
Resume by alarm	Disable	
x Date(of Month) Alarm	0	
x Tme(hh:mm:ss) Alarm	0 0 0	
** Reload Global Timer Events **		
Primary IDE 0	Disabled	
Primary IDE 1	Disabled	
Secondary IDE 0	Disabled	
Secondary IDE 1	Disabled	
FDD, COM, LPT Port	Disabled	
PCI PIRQ [A-D]#	Disabled	
↑↓←→Move Enter: Select +/-/PU/PD: Value F10:Save ESC: Exit F1:General Help F5:Previous Values F6:Optimal defaults F7:Standard Defaults		

Figure 3-5

- ◆ **ACPI Function:** This item allows you to enable/disable the Advanced Configuration and Power Management (ACPI). (Please refer to page 42 for installation procedure)
The choice: Enabled, Disabled.
- ◆ **ACPI Suspend TYPE:** This item allow you to select the system Wake Up method in ACPI Type when choice SI(POS)(power ON Suspend), the System Suspend in Normal way without shut down the power when choice S3(S.T.R.) Suspend To RAM, the system Will Suspend in special way shut down the power supply, and Wake Up by push power Button the system will recovery faster than normal power on function.
This function only in J-912CF/913CF Main board.
- ◆ **Power Management:** This category allows you to select the type (or degree) of power saving and is directly related to the following modes:
 1. HDD Power Down
 2. Doze Mode
 3. Suspend Mode

There are four selections for Power Management, three of which have fixed mode settings.

Disable (default)	No power management. Disables all four modes
Min. Power Saving	Minimum power management. Doze Mode = 1 hr. Standby Mode = 1 hr., Suspend Mode = 1 hr., and HDD Power Down = 15 min.
Max. Power Saving	Maximum power management -- ONLY AVAILABLE FOR SL CPU's. Doze Mode = 1 min., Standby Mode = 1 min., Suspend Mode = 1 min., and HDD Power Down = 1 min.

User Defined	Allows you to set each mode individually. When not disabled, each of the ranges are from 1 min. to 1 hr. except for HDD Power Down which ranges from 1 min. to 15 min. and disable.
--------------	---

- ◆ **Video Off Method:** **This determines the manner in which the monitor is blanked.**

V/H SYNC+Blank	This selection will cause the system to turn off the vertical and horizontal synchronization ports and write blanks to the video buffer.
Blank Screen	This option only writes blanks to the video buffer.
DPMS	Initial display power management signaling.

- ◆ **Video Off In Suspend:** This determines the manner in which the monitor is blanked.
The choice: Yes, No.
- ◆ **Suspend Type:** Select the Suspend Type.
The choice: PWRON Suspend, Stop Grant.
- ◆ **MODEM Use IRQ:** This determines the IRQ in which the MODEM can use.
The choice: 3, 4, 5, 7, 9, 10, 11, NA.
- ◆ **Suspend Mode:** When enabled and after the set time of system inactivity, all devices except the CPU will be shut off.
The choice: Enabled, Disabled.
- ◆ **HDD Power Down:** When enabled and after the set time of system inactivity, the hard disk drive will be powered down while all other devices remain active.
The choice: Enabled, Disabled.
- ◆ **Soft-Off by PWRBTN:** Pressing the power button for more than 4 seconds forces the system to enter the Soft-Off state when the system has "hung."
The choice: Delay 4 Sec, Instant-Off.
- ◆ **CPU THRM-Throttling:** Select the CPU THRM-Throttling rate , this function work when select the temperature value in "CPU Warning Temperature" under " PC Health Status" ,when the rate choose 50% the CPU only work 50% of excute instruction and 50% of idle in a periode of time it will decrease the temperature of CPU .
The choice: 25.0%, 37.5%, 50.0%, 62.5%, 75.0%, 87.5%.
- ◆ **Power on by ring :** When you select *Enabled*, a signal from ring returns the system to Full On state.
- ◆ **Resume on by alarm :** When you select *Enabled*, the following fields appear. They let you set the alarm that returns the system to Full On state.
The choice: Enabled, Disabled.
- ◆ **Reload Global Timer Events:** Timer events are I/O events whose occurrence can prevent the system from entering a power saving mode or can awaken the system from such a mode. In effect, the system remains alert for anything which occurs to a device which is configured as *Enabled* , even when the system is in a power down mode.
Primary IDE 0
Primary IDE 1
Secondary IDE 0
Secondary IDE 1
FDD, COM, LPT Port

PCI IRQ[A-D] #

3-6 PnP/PCI CONFIGURATION SETUP

This section describes configuring the PCI bus system. PCI, or **Personal Computer Interconnect**, is a system which allows I/O devices to operate at speeds nearing the speed the CPU itself uses when communicating with its own special components. This section covers some very technical items and it is strongly recommended that only experienced users should make any changes to the default settings.

CMOS Setup Utility – Copyright © 1984-1998 Award Software
PnP/PCI Configurations

Reset Configuration Data Disabled	<u>Item Help</u>
Resources Controlled By Manual	Menu Level ➤
➤ IRQ Resources Press Enter	Default is Disabled.
➤ Memory Resources Press Enter	Select Enabled to
PCI/VGA Palette Snoop Disabled	reset Extended System
	Configuration
	Data (ESCD) when you
	exit Setup if you
	have installed a new
	add-on and the system
	reconfiguration has
	caused such a serious
	conflict that the OS
	cannot boot
↑↓←→Move Enter: Select +/-/PU/PD: Value F10:Save ESC: Exit F1:General Help F5:Previous Values F6:Optimal defaults F7:Standard Defaults	

Figure 3-6

- ◆ **PnP OS Installed:** This item allows you to determine installed PnP OS or not.
The choice: Yes, No.
- ◆ **Reset Configuration Data:** Normally, you leave this field Disabled. Select Enabled to reset Extended System Configuration Data (ESCD) when you exit Setup if you have installed a new add-on and the system reconfiguration has caused such a serious conflict that the operating system can not boot.
The choice: Enabled, Disabled .
- ◆ **Resource controlled by:** Auto will allow the Award Plug and Play BIOS to automatically configure all of the boot and Plug and Play compatible devices. If you have trouble in assigning the interrupt resource automatically you can select “manual”, it will allow you to choose specific resources by going into each of the sub menu that follows this field (a sub menu is preceded by a “➤”).
The choice: Auto(ESCD), Manual .

-
-
- ◆ **IRQ Resources:** When resources are controlled manually, assign each system interrupt a type, depending on the type of device using the interrupt.
 - ◆ **IRQ3/4/5/7/9/10/11/12/14/15 assigned to:** This item allows you to determine the IRQ assigned to the ISA bus and is not available to any PCI slot. Legacy ISA for devices compliant with the original PC AT bus specification, PCI/ISA PnP for devices compliant with the Plug and Play standard whether designed for PCI or ISA bus architecture.
The Choice: *Legacy ISA* and *PCI/ISA PnP*.
 - ◆ **DMA Resources:** When resources are controlled manually, assign each system DMA channel a type, depending on the type of device using the DM channel.
 - ◆ **DMA 0/1/3/5/6/7 assigned to:** Legacy ISA for devices compliant with the original PC AT bus specification, PCI/ISA PnP for devices compliant with the Plug and Play standard whether designed for PCI or ISA bus architecture.
Choices are *Legacy ISA* and *PCI/ISA PnP*.
 - ◆ **Memory Resources:** This sub menu can let you control the memory resource.
 - ◆ **Reserved Memory Base:** Reserved a low memory for the legacy device(non-PnP device).
Choices are C800, CC00, D000, D800, DC00, D400, N/A.
 - ◆ **Reserved Memory Length:** Reserved a low memory length for the legacy device(non-PnP device).
Choices are 8K, 16K, 32K, 64K.
 - ◆ **PCI/VGA Palette Snoop:** Leave this field at *Disabled*.
Choices are Enabled, Disabled.

3-7 PC Health Status

CMOS Setup Utility – Copyright © 1984 – 1998 Award Software
Power Management Setup

CPU Warning Temperature	Disabled	Item Help
Current System Temp.	25 ° C/ 77 ° F	
Current CPU Temp.	49 ° C/120 ° F	Menu Level ➤
Current FAN1 Speed.	4172 RPM	
Current FAN2 Speed.	4358 RPM	
Current FAN3 Speed.	4041 RPM	
Vcore	2.0 V	
Vtt(V)	1.55 V	
Vcc3.3	3.36 V	
+5V	4.94 V	
+12V	11.97 V	
-12V	- 12.11 V	
-5V	- 4.94 V	
VBAT(V)	3.31 V	
5VSB(V)	5.34 V	
Shutdown Temperature	75 ° C/ 167 ° F	
↑↓←→ Move Enter: Select +/-/PU/PD: Value F10:Save ESC: Exit F1:General Help F5:Previous Values F6:Optimal defaults F7:Standard Defaults		

Figure 3-7

CPU Warning Temperature: this item is to setting the Max. Temperature of CPU before it will have warning alarm.

Shutdown Temperature: this item is to setting the temperature for system shutdown , the choice: from 60 ° C to 75 ° C

3-8 Frequency/Voltage Control

CMOS Setup Utility – Copyright © 1984-1998 Award Software
 Frequency/Voltage Control

Auto Detect DIMM/PCI CLK	Enabled	Item Help
CPU Clock/Spread Spectrum	Default	
CPU Ratio	X3	Menu Level ➤
↑↓←→ Move Enter: Select +/-/PU/PD: Value F10:Save ESC: Exit F1:General Help F5:Previous Values F6:Optimal defaults F7:Standard Defaults		

Figure 3-8

- ◆ **DIMM/PCI CLK:** This item allows you to enable/disable auto detect DIMM/PCI Clock.
 The choice: Enabled, Disabled.
- ◆ **CPU Clock/Spread Spectrum:** This item allows you to choice CPU clock/Spread Spectrum (ON,OFF) (66MHz,75MHz.....) enable/disable the spread spectrum modulate.
 The choice: Default (the CPU clock Depend on Jumper),66MHz/off , 66MHz/on , 75MHz/off , 83MHz/off , 95MHz/off, 100MHz/off , 100MHz/on , 112MHz/on , 117MHz/on , 124MHz/off, 133MHz/off, 133MHz/on, 138/off, 140/on, 150/off.

-
-
- ◆ **CPU Ratio:** This item allows you to select the CPU ratio.
From X3 to X8

3-9 Defaults Menu

Selecting “Defaults” from the main menu shows you two options which are described below

- ◆ **Load Optimal Defaults:**

When you press <Enter> on this item you get a confirmation dialog box with a message similar to:

Load Optimal Defaults (Y/N) ? **N**

Pressing ‘Y’ loads the Optimal default values for the most stable, optimal performance system operations.

- ◆ **Load Standard Defaults:**

When you press <Enter> on this item you get a confirmation dialog box with a message similar to:

Load Standard Defaults (Y/N) ? **N**

Pressing ‘Y’ loads the Standard default values that are factory settings for normal performance system operations.

3-10 Supervisor/User Password Setting

You can set either supervisor or user password, or both of them. The differences between are:

supervisor password : can enter and change the options of the setup menus.

user password : just can only enter but do not have the right to change the options of the setup menus. When you select this function, the following message will appear at the center of the screen to assist you in creating a password.

ENTER PASSWORD:

Type the password, up to eight characters in length, and press <Enter>. The password typed now will clear any previously entered password from CMOS memory. You will be asked to confirm the password. Type the password again and press <Enter>. You may also press <Esc> to abort the selection and not enter a password.

To disable a password, just press <Enter> when you are prompted to enter the password. A message will confirm the password will be disabled. Once the password is disabled, the system will boot and you can enter Setup freely.

PASSWORD DISABLED.

When a password has been enabled, you will be prompted to enter it every time you try to enter Setup. This prevents an unauthorized person from changing any part of your system configuration.

Additionally, when a password is enabled, you can also require the BIOS to request a password every time your system is rebooted. This would prevent unauthorized use of your computer.

You determine when the password is required within the BIOS Features Setup Menu and its Security option (see Section 3). If the Security option is set to “System”, the password will be required both at boot and at entry to Setup. If set to “Setup”, prompting only occurs when trying to enter Setup.

3-11 Exit Selecting

Save & Exit Setup

Pressing <Enter> on this item asks for confirmation:

Save to CMOS and EXIT (Y/N)? Y

Pressing “Y” stores the selections made in the menus in CMOS – a special section of memory that stays on after you turn your system off. The next time you boot your computer, the BIOS configures your system according to the Setup selections stored in CMOS. After saving the values the system is restarted again.

Exit Without Saving

Pressing <Enter> on this item asks for confirmation:

Quit without saving (Y/N)? Y

This allows you to exit Setup without storing in CMOS any change. The previous selections remain in effect. This exits the Setup utility and restarts your computer.

3-12 POST Messages

During the Power On Self-Test (POST), if the BIOS detects an error requiring you to do something to fix, it will either sound a beep code or display a message.

If a message is displayed, it will be accompanied by:

PRESS F1 TO CONTINUE, CTRL-ALT-ESC OR DEL TO ENTER SETUP

◆ POST Beep

Currently there are two kinds of beep codes in BIOS. This code indicates that a video error has occurred and the BIOS cannot initialize the video screen to display any additional information. This beep code consists of a single long beep followed by two short beeps. The other code indicates that your DRAM error has occurred. This beep code consists of a single long beep repeatedly.

◆ Error Messages

One or more of the following messages may be displayed if the BIOS detects an error during the POST. This list includes messages for both the ISA and the EISA BIOS.

◆ CMOS BATTERY HAS FAILED

CMOS battery is no longer functional. It should be replaced.

◆ CMOS CHECKSUM ERROR

Checksum of CMOS is incorrect. This can indicate that CMOS has become corrupt. This error may have been caused by a weak battery. Check the battery and replace if necessary.

- ◆ **DISK BOOT FAILURE, INSERT SYSTEM DISK AND PRESS ENTER**

No boot device was found. This could mean that either a boot drive was not detected or the drive does not contain proper system boot files. Insert a system disk into Drive A: and press <Enter>. If you assumed the system would boot from the hard drive, make sure the controller is inserted correctly and all cables are properly attached. Also be sure the disk is formatted as a boot device. Then reboot the system.

- ◆ **DISKETTE DRIVES OR TYPES MISMATCH ERROR - RUN SETUP**

Type of diskette drive installed in the system is different from the CMOS definition. Run Setup to reconfigure the drive type correctly.

- ◆ **DISPLAY SWITCH IS SET INCORRECTLY**

Display switch on the motherboard can be set to either monochrome or color. This indicates the switch is set to a different setting than indicated in Setup. Determine which setting is correct, and then either turn off the system and change the jumper, or enter Setup and change the VIDEO selection.

- ◆ **DISPLAY TYPE HAS CHANGED SINCE LAST BOOT**

Since last powering off the system, the display adapter has been changed. You must configure the system for the new display type.

EISA Configuration Checksum Error
PLEASE RUN EISA CONFIGURATION UTILITY

The EISA non-volatile RAM checksum is incorrect or cannot correctly read the EISA slot. This can indicate either the EISA non-volatile memory has become corrupt or the slot has been configured incorrectly. Also be sure the card is installed firmly in the slot.

EISA Configuration Is Not Complete
PLEASE RUN EISA CONFIGURATION UTILITY

The slot configuration information stored in the EISA non-volatile memory is incomplete.

Note: When either of these errors appear, the system will boot in ISA mode, which allows you to run the EISA Configuration Utility.

ERROR ENCOUNTERED INITIALIZING HARD DRIVE

Hard drive cannot be initialized. Be sure the adapter is installed correctly and all cables are correctly and firmly attached. Also be sure the correct hard drive type is selected in Setup.

ERROR INITIALIZING HARD DISK CONTROLLER

Cannot initialize controller. Make sure the cord is correctly and firmly installed in the bus. Be sure the correct hard drive type is selected in Setup. Also check to see if any jumper needs to be set correctly on the hard drive.

FLOPPY DISK CNTRLR ERROR OR NO CNTRLR PRESENT

Cannot find or initialize the floppy drive controller. make sure the controller is installed correctly and firmly. If there are no floppy drives installed, be sure the Diskette Drive selection in Setup is set to NONE.

Invalid EISA Configuration

PLEASE RUN EISA CONFIGURATION UTILITY

The non-volatile memory containing EISA configuration information was programmed incorrectly or has become corrupt. Re-run EISA configuration utility to correctly program the memory.

NOTE: When this error appears, the system will boot in ISA mode, which allows you to run the EISA Configuration Utility.
--

KEYBOARD ERROR OR NO KEYBOARD PRESENT

Cannot initialize the keyboard. Make sure the keyboard is attached correctly and no keys are being pressed during the boot.

If you are purposely configuring the system without a keyboard, set the error halt condition in Setup to HALT ON ALL, BUT KEYBOARD. This will cause the BIOS to ignore the missing keyboard and continue the boot.

Memory Address Error at ...

Indicates a memory address error at a specific location. You can use this location along with the memory map for your system to find and replace the bad memory chips.

Memory parity Error at ...

Indicates a memory parity error at a specific location. You can use this location along with the memory map for your system to find and replace the bad memory chips.

MEMORY SIZE HAS CHANGED SINCE LAST BOOT

Memory has been added or removed since the last boot. In EISA mode use Configuration Utility to reconfigure the memory configuration. In ISA mode enter Setup and enter the new memory size in the memory fields.

Memory Verify Error at ...

Indicates an error verifying a value already written to memory. Use the location along with your system's memory map to locate the bad chip.

OFFENDING ADDRESS NOT FOUND

This message is used in conjunction with the I/O CHANNEL CHECK and RAM PARITY ERROR messages when the segment that has caused the problem cannot be isolated.

OFFENDING SEGMENT:

This message is used in conjunction with the I/O CHANNEL CHECK and RAM PARITY ERROR messages when the segment that has caused the problem has been isolated.

PRESS A KEY TO REBOOT

This will be displayed at the bottom screen when an error occurs that requires you to reboot. Press any key and the system will reboot.

PRESS F1 TO DISABLE NMI, F2 TO REBOOT

When BIOS detects a Non-maskable Interrupt condition during boot, this will allow you to disable the NMI and continue to boot, or you can reboot the system with the NMI enabled.

RAM PARITY ERROR - CHECKING FOR SEGMENT ...

Indicates a parity error in Random Access Memory.

**Should Be Empty But EISA Board Found
PLEASE RUN EISA CONFIGURATION UTILITY**

A valid board ID was found in a slot that was configured as having no board ID.

NOTE: When this error appears, the system will boot in ISA mode, which allows you to run the EISA Configuration Utility.

**Should Have EISA Board But Not Found
PLEASE RUN EISA CONFIGURATION UTILITY**

The board installed is not responding to the ID request, or no board ID has been found in the indicated slot.

NOTE: When this error appears, the system will boot in ISA mode, which allows you to run the EISA Configuration Utility.

Slot Not Empty

Indicates that a slot designated as empty by the EISA Configuration Utility actually contains a board.

NOTE: When this error appears, the system will boot in ISA mode, which allows you to run the EISA Configuration Utility.

SYSTEM HALTED, (CTRL-ALT-DEL) TO REBOOT ...

Indicates the present boot attempt has been aborted and the system must be rebooted. Press and hold down the CTRL and ALT keys and press DEL.

**Wrong Board In Slot
PLEASE RUN EISA CONFIGURATION UTILITY**

The board ID does not match the ID stored in the EISA non-volatile memory.

NOTE: When this error appears, the system will boot in ISA mode, which allows you to run the EISA Configuration Utility.

FLOPPY DISK(S) fail (80) → Unable to reset floppy subsystem.

FLOPPY DISK(S) fail (40) → Floppy Type mismatch.

Hard Disk(s) fail (80) → HDD reset failed

Hard Disk(s) fail (40) → HDD controller diagnostics failed.

Hard Disk(s) fail (20) → HDD initialization error.

Hard Disk(s) fail (10) → Unable to recalibrate fixed disk.

Hard Disk(s) fail (08) → Sector Verify failed.

Keyboard is locked out - Unlock the key.

BIOS detect the keyboard is locked. P17 of keyboard controller is pulled low.

Keyboard error or no keyboard present.

Cannot initialize the keyboard. Make sure the keyboard is attached correctly and no keys are being pressed during the boot.

Manufacturing POST loop.

System will repeat POST procedure infinitely while the P15 of keyboard controller is pull low. This is also used for M/B burn in test.

BIOS ROM checksum error - System halted.

The checksum of ROM address F0000H-FFFFFFH is bad.

Memory test fail.

BIOS reports the memory test fail if the onboard memory is tested error.

3-13 POST Codes

POST (hex)	Description
CFh	Test CMOS R/W functionality.
C0h	Early chipset initialization: -Disable shadow RAM -Disable L2 cache (socket 7 or below) -Program basic chipset registers
C1h	Detect memory -Auto-detection of DRAM size, type and ECC. -Auto-detection of L2 cache (socket 7 or below)
C3h	Expand compressed BIOS code to DRAM
C5h	Call chipset hook to copy BIOS back to E000 & F000 shadow RAM.
0h1	Expand the Xgroup codes locating in physical address 1000:0
02h	Reserved
03h	Initial Superio_Early_Init switch.
04h	Reserved
05h	1. Blank out screen 2. Clear CMOS error flag
06h	Reserved
07h	1. Clear 8042 interface 2. Initialize 8042 self-test
08h	1. Test special keyboard controller for Winbond 977 series Super I/O chips. 2. Enable keyboard interface.
09h	Reserved
0Ah	1. Disable PS/2 mouse interface (optional). 2. Auto detect ports for keyboard & mouse followed by a port & interface swap (optional). 3. Reset keyboard for Winbond 977 series Super I/O chips.
0Bh	Reserved
0Ch	Reserved
0Dh	Reserved
0Eh	Test F000h segment shadow to see whether it is R/W-able or not. If test fails, keep beeping the speaker.
0Fh	Reserved
10h	Auto detect flash type to load appropriate flash R/W codes into the run time area in F000 for ESCD & DMI support.
11h	Reserved

POST (hex)	Description
12h	Use walking 1's algorithm to check out interface in CMOS circuitry. Also set real-time clock power status, and then check for override.
13h	Reserved
14h	Program chipset default values into chipset. Chipset default values are MODBINable by OEM customers.
15h	Reserved
16h	Initial Early_Init_Onboard_Generator switch.
17h	Reserved
18h	Detect CPU information including brand, SMI type (Cyrix or Intel) and CPU level (586 or 686).
19h	Reserved
1Ah	Reserved
1Bh	Initial interrupts vector table. If no special specified, all H/W interrupts are directed to SPURIOUS_INT_HDLR & S/W interrupts to SPURIOUS_soft_HDLR.
1Ch	Reserved
1Dh	Initial EARLY_PM_INIT switch.
1Eh	Reserved
1Fh	Load keyboard matrix (notebook platform)
20h	Reserved
21h	HPM initialization (notebook platform)
22h	Reserved
23h	<ol style="list-style-type: none"> 1. Check validity of RTC value: e.g. a value of 5Ah is an invalid value for RTC minute. 2. Load CMOS settings into BIOS stack. If CMOS checksum fails, use default value instead. 3. Prepare BIOS resource map for PCI & PnP use. If ESCD is valid, take into consideration of the ESCD's legacy information. 4. Onboard clock generator initialization. Disable respective clock resource to empty PCI & DIMM slots. 5. Early PCI initialization: <ul style="list-style-type: none"> -Enumerate PCI bus number -Assign memory & I/O resource -Search for a valid VGA device & VGA BIOS, and put it into C000:0.
24h	Reserved
25h	Reserved
26h	Reserved
27h	Initialize INT 09 buffer
28h	Reserved
29h	<ol style="list-style-type: none"> 1. Program CPU internal MTRR (P6 & PII) for 0-640K memory address. 2. Initialize the APIC for Pentium class CPU. 3. Program early chipset according to CMOS setup. Example: onboard IDE controller. 4. Measure CPU speed. 5. Invoke video BIOS.
2Ah	Reserved
2Bh	Reserved
2Ch	Reserved
2Dh	<ol style="list-style-type: none"> 1. Initialize multi-language 2. Put information on screen display, including Award title, CPU type, CPU

POST (hex)	Description
	speed
2Eh	Reserved
2Fh	Reserved
30h	Reserved
31h	Reserved
32h	Reserved
33h	Reset keyboard except Winbond 977 series Super I/O chips.
34h	Reserved
35h	Reserved
36h	Reserved
37h	Reserved
38h	Reserved
39h	Reserved
3Ah	Reserved
3Bh	Reserved
3Ch	Test 8254
3Dh	Reserved
3Eh	Test 8259 interrupt mask bits for channel 1.
3Fh	Reserved
40h	Test 8259 interrupt mask bits for channel 2.
41h	Reserved
42h	Reserved
43h	Test 8259 functionality.
44h	Reserved
45h	Reserved
46h	Reserved
47h	Initialize EISA slot
48h	Reserved
49h	1. Calculate total memory by testing the last double word of each 64K page 2. Program writes allocation for AMD K5 CPU.
4Ah	Reserved
4Bh	Reserved
4Ch	Reserved
4Dh	Reserved
4Eh	1. Program MTRR of M1 CPU 2. Initialize L2 cache for P6 class CPU & program CPU with proper cacheable range. 3. Initialize the APIC for P6 class CPU. 4. On MP platform, adjust the cacheable range to smaller one in case the cacheable ranges between each CPU are not identical.
4Fh	Reserved
50h	Initialize USB
51h	Reserved
52h	Test all memory (clear all extended memory to 0)
53h	Reserved
54h	Reserved
55h	Display number of processors (multi-processor platform)
56h	Reserved
57h	1. Display PnP logo

POST (hex)	Description
	2. Early ISA PnP initialization -Assign CSN to every ISA PnP device.
58h	Reserved
59h	Initialize the combined Trend Anti-Virus code.
5Ah	Reserved
5Bh	(Optional Feature) Show message for entering AWDFLASH.EXE from FDD (optional)
5Ch	Reserved
5Dh	1. Initialize Init_Onboard_Super_IO switch. 2. Initialize Init_Onboard_AUDIO switch.
5Eh	Reserved
5Fh	Reserved
60h	Okay to enter Setup utility; i.e. not until this POST stage can users enter the CMOS setup utility.
61h	Reserved
62h	Reserved
63h	Reserved
64h	Reserved
65h	Initialize PS/2 Mouse
66h	Reserved
67h	Prepare memory size information for function call: INT 15h ax=E820h
68h	Reserved
69h	Turn on L2 cache
6Ah	Reserved
6Bh	Program chipset registers according to items described in Setup & Auto-configuration table.
6Ch	Reserved
6Dh	1. Assign resources to all ISA PnP devices. 2. Auto assign ports to onboard COM ports if the corresponding item in Setup is set to "AUTO".
6Eh	Reserved
6Fh	1. Initialize floppy controller 2. Set up floppy related fields in 40:hardware.
70h	Reserved
71h	Reserved
72h	Reserved
73h	(Optional Feature) Enter AWDFLASH.EXE if : -AWDFLASH is found in floppy drive. -ALT+F2 is pressed
74h	Reserved
75h	Detect & install all IDE devices: HDD, LS120, ZIP, CDROM.....
76h	Reserved
77h	Detect serial ports & parallel ports.
78h	Reserved
79h	Reserved
7Ah	Detect & install co-processor
7Bh	Reserved
7Ch	Reserved

POST (hex)	Description
7Dh	Reserved
7Eh	Reserved
7Fh	<ol style="list-style-type: none"> 1. Switch back to text mode if full screen logo is supported. -If errors occur, report errors & wait for keys -If no errors occur or F1 key is pressed to continue: <ul style="list-style-type: none"> ◆Clear EPA or customization logo.
80h	Reserved
81h	Reserved
82h	<ol style="list-style-type: none"> 1. Call chipset power management hook. 2. Recover the text font used by EPA logo (not for full screen logo) 3. If password is set, ask for password.
83h	Save all data in stack back to CMOS
84h	Initialize ISA PnP boot devices
85h	<ol style="list-style-type: none"> 1. USB final Initialization 2. NET PC: Build SYSID structure 3. Switch screen back to text mode 4. Set up ACPI table at top of memory. 5. Invoke ISA adapter ROMs 6. Assign IRQs to PCI devices 7. Initialize APM 8. Clear noise of IRQs.
86h	Reserved
87h	Reserved
88h	Reserved
89h	Reserved
90h	Reserved
91h	Reserved
92h	Reserved
93h	Read HDD boot sector information for Trend Anti-Virus code
94h	<ol style="list-style-type: none"> 1. Enable L2 cache 2. Program boot up speed 3. Chipset final initialization. 4. Power management final initialization 5. Clear screen & display summary table 6. Program K6 write allocation 7. Program P6 class write combining
95h	<ol style="list-style-type: none"> 1. Program daylight saving 2. Update keyboard LED & typematic rate
96h	<ol style="list-style-type: none"> 1. Build MP table 2. Build & update ESCD 3. Set CMOS century to 20h or 19h 4. Load CMOS time into DOS timer tick 5. Build MSIRQ routing table.
FFh	Boot attempt (INT 19h)



Chapter 4

911CF/912CF/913CF Driver Installation

Preparation

1. You must have more than 33MB memory on your system in order to install VGA driver.
2. If you are using Windows 95, you must update to Windows 95 OSR2.1 or later version.
3. If you are using Windows NT, you must update to Server Pack 4 or later version.
4. We are assuming your CD-ROM is X drive.
5. If you don't have Modem/Riser card, you will find a PCI card with a "!" mark in "OTHER DEVICE "under" Device Manager". You can solve this problem by disable "AC97 Modem" under "Integrated Peripherals" option of the BIOS.
6. Multi language supported for both VGA and Sound drivers installation.

4-1 Software Installation

.INF

Windows 95 :

1. Install X : \INTEL810\INF\INFINST\SETUP.EXE and follow on screen instruction.
2. After re-start your computer; just simply click NEXT to choose Windows default driver.

Windows 98 :

1. Install X : \INTEL810\INF\INFINST\SETUP.EXE and follow on screen instruction.
2. After re-start your computer; at prompt of asking for ICHxIDE.CAT, please points to C:\WINDOWS\CATROOT, otherwise just simply click NEXT to choose Windows default driver.

VGA Driver

Windows95/Windows98 : Run X : \INTEL810\VGA\WIN9X\GRAPHICS\SETUP.EXE

Windows NT 4.0 : Run X : \INTEL810\VGA\NT4\GRAPHICS\SETUP.EXE

Please follow on screen instruction to complete your installation.

Sound Driver (For Avance Audio Codec only)

1. Windows 95 : Run X : \CODEC\ALC200\WIN95\SETUP.EXE
2. Windows 98/98SE : Run X : \CODEC\ALC200\WIN98\SETUP.EXE
3. Windows NT 4.0 : Run X : \CODEC\ALC200\WINNT\SETUP.EXE
4. Windows 2000 : Run X : \CODEC\ALC200\WIN2000\SETUP.EXE

Sound Driver (For Crystal Audio Codec only)

1. Windows 95 : Run X : \CODEC\CRYSTAL\WIN95\SETUP.EXE
2. Windows 98/98SE : Run X : \CODEC\CRYSTAL\WIN98\SETUP.EXE
3. Windows NT 4.0 : Run X : \CODEC\CRYSTAL\WINNT\SETUP.EXE
4. Windows 2000 : Run X : \CODEC\CRYSTAL\WIN2000\SETUP.EXE

Sound Driver (For AD1881 Audio Codec only)

1. Windows 95 : Run X : \CODEC\AD1881\WIN95\SETUP.EXE
2. Windows 98/98SE : Run X : \CODEC\AD1881\WIN98\SETUP.EXE
3. Windows NT 4.0 : Run X : \CODEC\AD1881\WINNT\SETUP.EXE
4. Windows 2000 : Run X : \CODEC\AD1881\WIN2000\SETUP.EXE

PC Health Software

Windows 95 : Run X : \INTEL810\HEALTH4\SETUP.EXE

Windows 98 : Run X : \INTEL810\HEALTH4\SETUP.EXE

NOTES	<ol style="list-style-type: none">1. For Windows 95 user : You must run SETUP.EXE twice in order to complete this installation. The computer will install device identification at first time when you run SETUP.EXE. When you finish, you need re-start your computer manually and run SETUP.EXE once again to install correspond driver.2. <i>Please follow on screen instruction to complete your installation.</i>3. Please refer to HELP for Windows 95/98 related questions.
-------	--

4-2 Suspend To RAM (STR) (Only for 912CF/913CF)

1. Please set “ACPI Suspend Type” at “Power Management Setup” from BIOS to S3(STR) mode, and save the setting.
2. Since default setting of Power Management within Windows 98 is APM (Advanced Power Management) mode, you must change it to ACPI (Advanced Configuration and Power Interface) mode at **installation procedure** in order to have STR function.
3. When you installing Windows 98, please use following command to add ACPI function in to Windows 98.

SETUP /P J

Note : You can find ACPI mode under “System Device” of “Device Manager” after you installed Windows 98.

4. After you have successfully installed Windows 98, please install your VGA, INF, and SOUND driver.
5. You can then choose “STAND BY” from the “SHUT DOWN” option under “START” to get into STR mode.
6. To wake up your system, please press Power Button to power on and wait 9~12 seconds to return back original Windows 98 screen.

4-3 Keyboard Password/Hot-key / PS/2 Mouse Power On

This Mother board has two ways to Power On System, one is use power button the other is use keyboard. This

document description how to use keyboard to control Power On function.

Function 1:

Use Power Button Power On.

Please setting both JP3 2-3 closed (see Figure A). In this condition the system will ignore the BIOS SETUP "Power On Function" under "INTEGRATED PERIPHERALS", system only can power on by Power Button.

Function 2:

Use Keyboard Password/ Hot-key /PS/2 Mouse Power On (Default setting).

You have to setting both JP3 1-2 closed (see Figure A). In this setting you can change BIOS SETUP to "Password" or "Hot-key" "PS/2 Mouse" in "Power On Function" item under "INTEGRATED PERIPHERAL SETUP".

A: When choose "Password", then user can setting your password in "KB Power On Password" item. After save CMOS SETUP, the next time want to power on, you have to key in your password to power on, otherwise the system will not power on.

B: When choose "Hot-key" or "PS/2 Mouse", then user can choose by key in Hot-key or Push Mouse button, or use Power button to power on system.

Question and Answer:

Q1: When you forget password or the system can not power on by power button?

Answer: There has two solution of this problem:

sol 1: 1st : Turn off the Power Supply by ON/OFF switch.

2nd: Clear CMOS by JP13 2-3 closed about 10 sec and remove the Jumper to 1-2 closed for Normal use.

3rd: Switch ON the Power Supply by ON/OFF switch.

4th: Follow Function 1 or Function 2 to setting to setting your Power On Function.

sol 2: Change the Jumper setting both JP3 2-3 closed . Let you can use power button to Power On your system, and you can setting BIOS again. In this condition you can choose use Function 1 (use Power Button Power On) or use Function 2 (Use Keyboard Password/ Hot-key Power On) to setting your system.

Q2: When use Function 2 use keyboard Password/Hot-key Power On, there has keyboard error problem?

Answer: This is the Power Supply 5V stand by current too small can not drive the keyboard.

sol: If your Power Supply 5V Stand By current is not enough to driver keyboard. You can not use keyboard password/Hot-key power on Function, Please change the Jumper setting JP3 2-3 closed only can use Function 1: Power Button Power On.

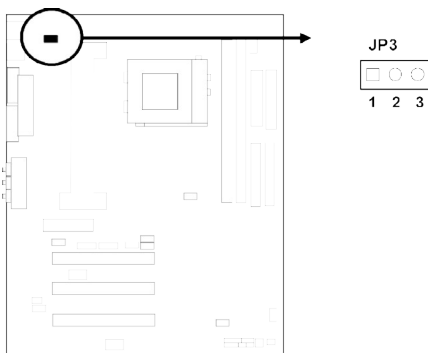

Figure A

4-4 911CF/912CF/913CF QUICK GUIDE

Mother Board Configuration

Set Front Side Bus (FSB) 66 or 100 according to your CPU.

CPU BUS

Pg.6
JP6

CPU	=	FSB	x	Ratio
Intel Pentium II 350	=	100	x	3.5
Intel Celeron 366	=	66.6	x	5.5

CPU Installation

Pg.8-9

Dram Installation

Pg. 8-9

Install Expansion Card

Pg.9

Please follow manufacturer instruction for any expansion card installed.

Connect cable, wires & power supplies

Pg.
10-15

Refer to page 4 Fig. 2-1 to identify Pin No.1 connector on the motherboard. (Black dot indicates Pin No.1).
Red line on the ribbon cable indicates Pin No.1.

Bios Configuration

Clear CMOS

Pg. 6

Short Pin 2-3 for 3 to 5 seconds on JP10 to clear CMOS.

Bios Setup

Pg. 6

1. Turn on the computer.
2. Hold Down key immediately after turning on the computer.
3. Main Menu on Display (Pg. 15 Fig 3-1)
4. Select 'Standard CMOS Feature' and press
5. Check and adjust date, time and Drive A/B configuration.

*We suggest you do not change the default setting unless you are very well informed about all detail of the BIOS.

Quick Installation Guide

Driver Installation

After you have successfully loaded Windows 95/98 in to your hard drive, enter into Windows 95/98.

Intel810 inf files

1. From Windows 95/98.

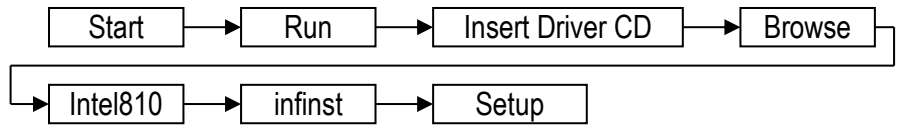

2. Restart your computer.

3. Now windows will automatically load the following drivers for Intel810.

- Intel® firmware 82802 firmware hub device.
--Windows will automatically find driver if not specify.
- Intel® 82801AA LPC Controller.
--Driver is in Windows95/98 CD.
- Intel® 82801AA Ultra ATA Controller.
--Driver is under "C:\Windows\catroot."(only Windows98)
- USB Root Hub.
--Driver is in Windows95/98 CD.
- System will restart.

VGA Driver

1. From Windows 95/98.

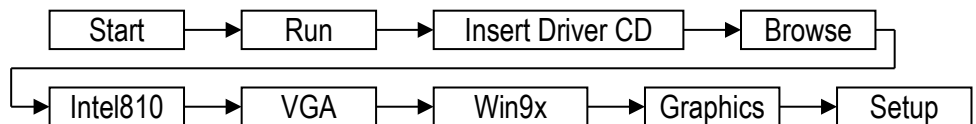

2. Restart your computer

Sound

1. From Windows 95/98.

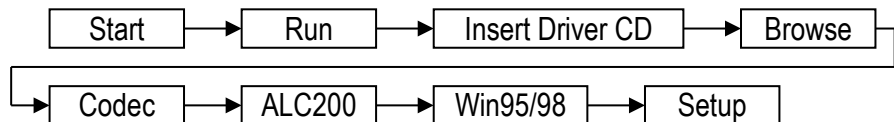

Refer to your instruction manual for more detail information