

TABLE OF CONTENT

Chapter 1

Features of This Motherboard.....	1
-----------------------------------	---

Chapter 2

Installation.....	3
2-1 Map of the Motherboard J-7ZXAS.....	3
2-2 Map of the Motherboard J-7ZXAN.....	4
2-3 Installation Steps.....	6
2-3-1 Jumper Settings.....	6
2-3-2 System Memory (DRAM).....	8
2-4 Central Processing Unit (CPU).....	9
2-5 Expansion Cards.....	10
2-6 External Connectors.....	11

Chapter 3

AWARD BIOS SETUP.....	18
3-1 STANDARD CMOS SETUP.....	19
3-2 BIOS FEATURES SETUP.....	20
3-3 CHIPSET FEATURES SETUP.....	23
Only for J-7ZXAS/L,J-7ZXAN/L.....	24
3-4 POWER MANAGEMENT SETUP.....	26
3-4-1 The Description of the Power Management.....	26
3-4-2 Description of the Green Functions.....	27
3-5 PNP/PCI CONFIGURATION SETUP.....	28
3-6 LOAD BIOS DEFAULTS.....	29
3-7 LOAD SETUP DEFAULTS.....	29
3-8 INTEGRATED PERIPHERALS SETUP.....	30
3-9 SUPERVISOR/USER PASSWORD.....	32
3-10 IDE HDD AUTO DETECTION.....	33
3-11 SAVE & EXIT SETUP.....	35
3-12 EXIT WITHOUT SAVING.....	35
3-13 I/O & MEMORY MAP.....	35
3-14 TIME & DMA CHANNELS MAP.....	36
3-15 INTERRUPT MAP.....	37
3-16 RTC & CMOS RAM MAP.....	37
3-17 BIOS REFERENCE-POST CODES.....	38
3-18 PC HEALTH MONITOR-II SOFTWARE FOR J-7ZXAS/L,J-7ZXAN/L...42	42

Chapter 4

Sound Card Driver Quick Installstuin(Only for J-7ZXAS).....45

Chapter 1

Features of This Motherboard

The [J-7ZXAS](#) or [J-7ZXAN](#) is designed for the PC user who wants a great many features in a small package. This motherboard including **PCI 3D sound chip** and support **Keyboard password/hot-key power on function**.

- **Support Password/Hot-key keyboard Power On function:** User can select Power On method by using button, password or hot-key or PS/2 mouse Left/Right button in the BIOS SETUP.
- **PCI 3D high-performance,mixed-signal,16bit stereo VLSI chip on board (Only for [J-7ZXAS](#)).**
 - PCI bus specification revision 2.1
 - Full native DOS games compatibility via three technologies: TDMA (Transparent DMA),DDMA (Distributed DMA),PC/PCI.
 - High-Quality ESFM music synthesizer.
 - Integrated 3-D audio effect processor.
 - Full-duplex operation for simultaneous record and playback.
 - Meets PC 97/PC 98 and WHQL Specifications.
- **CPU Bus Frequency selectable by BIOS can select 66MHz to 112MHz let users have more choice to get more performance.**
- **Easy Installation:** Is equipped with BIOS supports auto detection of hard drives and plug and play to make setup of hard drives and expansion cards virtually automatic.
- **Intel chipset:** Intel's [440ZX 100MHz](#) PCI/AGPset with I/O subsystems.
- **Multi-Speed Support:** Supports Intel Pentium® II processor [optimized Deshutimized at bus frequency, from 233MHz to 450MHz on a Slot-1.](#)
- **DRAM Memory Support:** Support 3x168-pin DIMMs (3.3V either EDO or SDRAM) of 16MB, 32MB, 64MB, 128MB, 256MB from a memory size between [16MB to768MB](#).
- **AGP, ISA and PCI Expansion Slots:** Provides an AGP slot, three 16-bit ISA slots, and three 32-bit PCI slots Master mode & one 32-bit PCI slots slave mode.
- **Super Multi-I/O:** Provides two high-Speed UART compatible serial ports and one parallel port with EPP and ECP capabilities. Two floppy drives of either 5.25" or 3.5" (1.44MB or 2.88MB) are also supported without an external card.
- **PCI Bus Master IDE Controller and ULTRA DMA 33:** On-board PCI Bus Master IDE controller with two connectors that supports four IDE devices in two channels, provides faster data transfer rates, and supports Enhanced IDE devices such as Tape Backup, CD-ROM drives and LS-120. This controller also supports PIO Modes 3 and 4 and Bus Master IDE DMA 33Mbyte/Sec.
- **Bundle with "TRIONES" ULTRA DMA 33 Driver to improve IDE transfer rate for up to 33Mbyte/sec.**

-
-
- **ACPI supporting for OS Directed Power Management.**
Ring-In Wake up: When Ring-In the system can wake up from SMI Mode.
Ring-In Power On: When Ring-In the system can power on automatic by this function.
RTC Power On: Enabled RTC Power On function, you can setting RTC alarm to power on the system at the time length you setting.
Power Button: Press the button will place the system power on/off.
CPU fan auto-stopping when in suspend mode.
Support Software Power Off function.
 - **Power Support:** Efficient PWM switching power instead of traditional Linear Voltage Regulator to prevent power component from being burned-out.
 - **PC 97 ready**
 - **PS/2 Mouse:** This motherboard support PS/2 mouse set.
 - **USB Port Connector:** This motherboard supports two USB port connectors for USB devices.
 - **ATX Form Factor:** Dimensions 30.5cm x 19cm.
 - **Optional IrDA:** This motherboard supports an optional infrared port module for wireless interface, with independent 3rd UART (32-byte FIFO).
 - **AGP:** Accelerated Graphics Port, for to 533MB/sec data transfer rate and 66MHz Bus clock to improve graphic functions.
 - **PC Health Monitoring: (Only in [J-7ZXAS/L](#),[J-7ZXAN/L](#))**
To track PC CPU temperature, system temperature, system voltage and fan speed. When CPU current temperature is over CPU warning temperature, system will slow down automatically to reduce the CPU's temperature.

Chapter 2

Installation

2-1 Map of the Motherboard J-7ZXAS

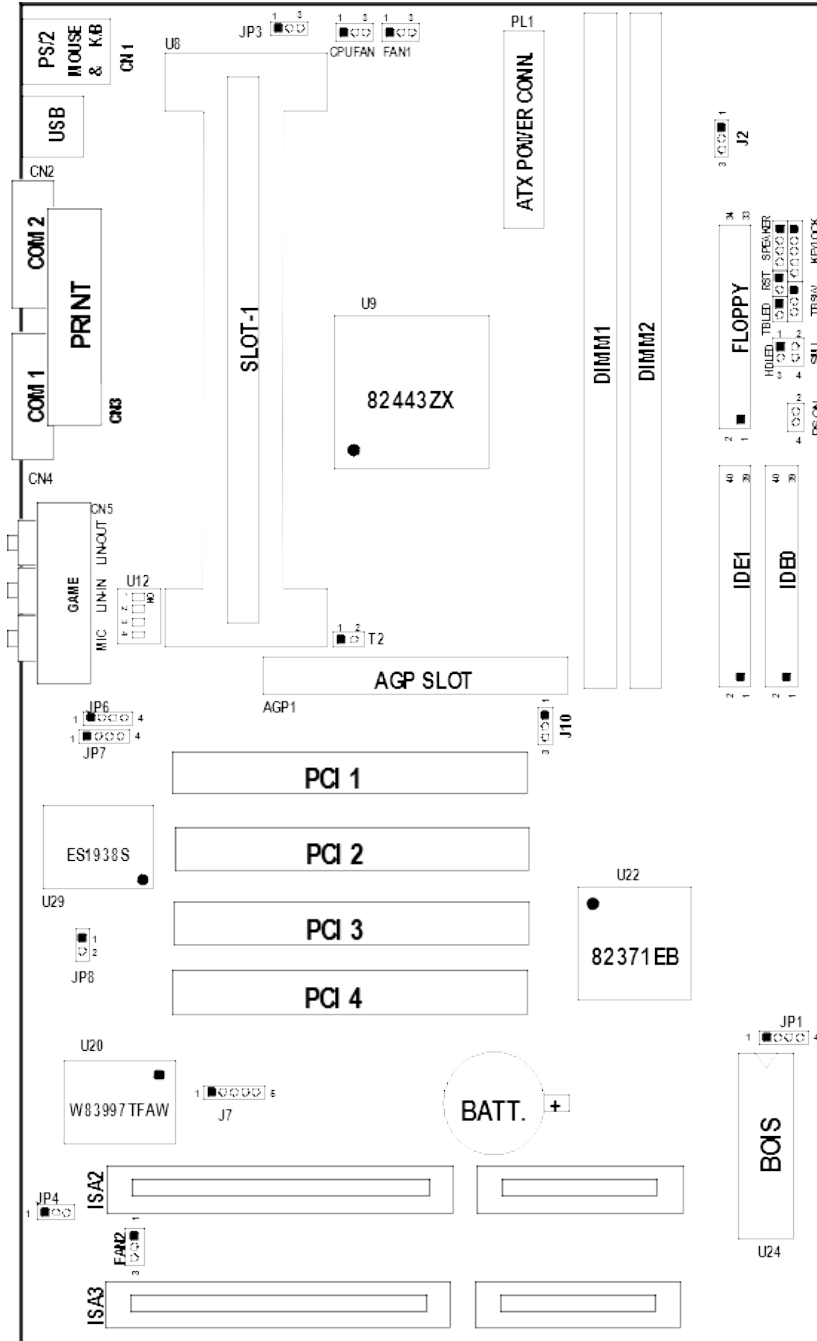

Figure 2-1

Note: PCI 1/PCI 2/PCI 4 is Master mode PCI slots
 PCI 3 is slave mode PCI slot(only for VGA CARD)

2-2 Map of the Motherboard J-7ZXAN

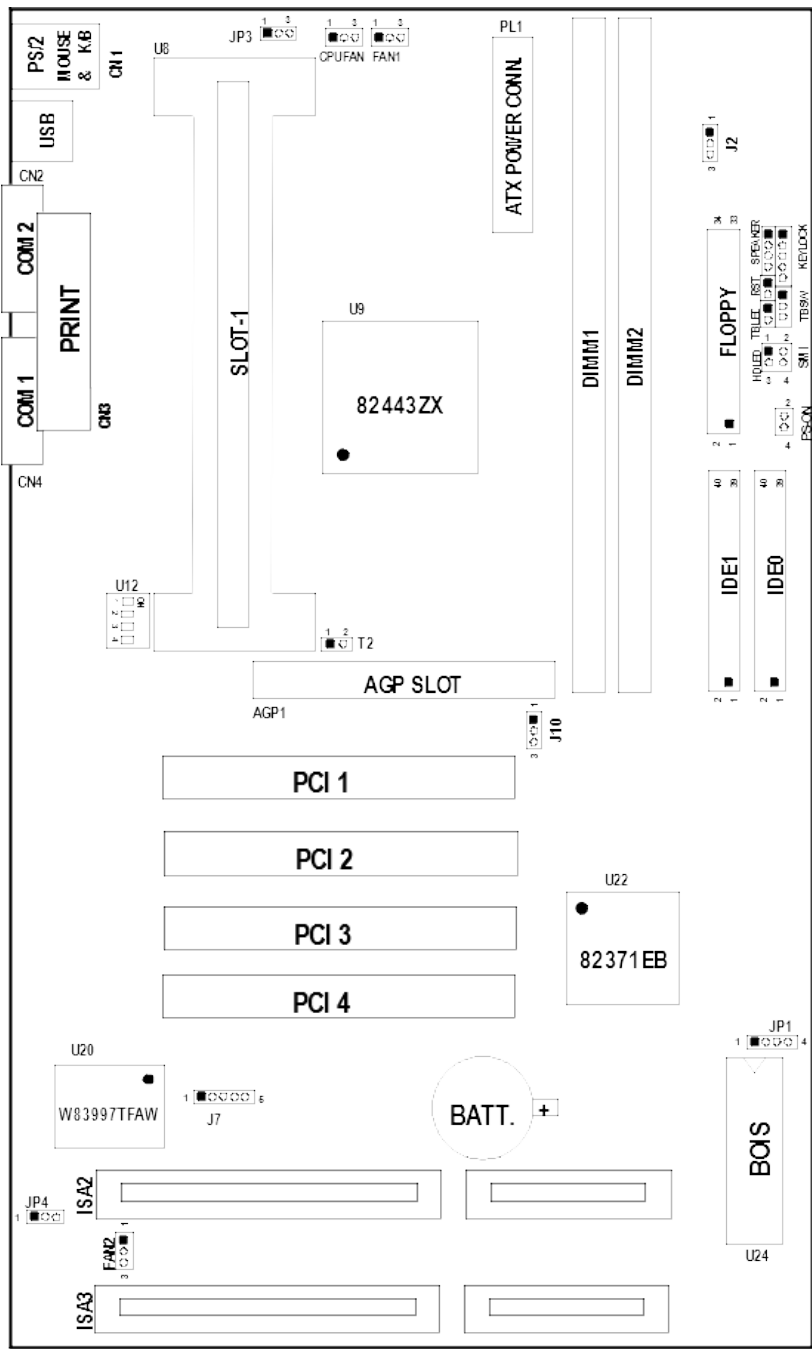

Figure 2-2

Note:PCI 1/PCI 2/PCI 4 is Master mode PCI slots
PCI 3 is slave mode PCI slot(only for VGA CARD)

Jumpers

- 1) U12 p. 5 DIP Switch for CPU Type Selection
- 2) J10 p. 5 CPU clk 66MHZ/100MHZ Selector

-
-
- 3) JP1 p. 7 CMOS RAM (Normal/Clear CMOS Data) (**Yellow color selector**)
 - 4) JP3,J2 p. 44 Keyboard password/hot-key power on Selector

Connectors

- 1) PL1 p. 11 ATX Power connector (20-pin Block)
- 2) CN1 p. 11 PS/2 Mouse & PS/2 Keyboard connector(6-pin Female)
- 3) CN3 p. 12 Parallel Port connector (25-pin Female)
- 4) CN2, CN4 p. 12 Serial Port COMA & COMB (9-pin Male)
- 5) CN5 p. 12 Audio/GAME Connector (Only for J-7ZXAS)
- 6) FDD p. 13 Floppy Driver connector (34-pin Block)
- 7) IDE0 p. 13 Primary IDE connector (40-pin Block)
- 8) IDE1 p. 13 Secondary IDE connector (40-pin Block)
- 9) SMI (J5 2&4) p. 14 SMI suspend Switch lead (2-pin)
- 10) HDLED (J5 1&3) p. 14 IDE activity LED connector (2-pin)
- 11) TBLED p. 14 Turbo LED switch (3-pin)
- 12) RST p. 15 Reset Switch lead (2-pin)
- 13) KEYLOCK p. 15 Keyboard Lock Switch (5-pin)
- 14) SPEAKER p. 15 Speaker connector (4-pin)
- 15) J7 p. 15 Infrared Module connector (5-pin)
- 16) USB p. 16 USB Port connector
- 17) CPUFAN p. 16 CPU Fan connector
- 18) FAN1, FAN2 p. 16 Extra fanning system connectors
- 19) PS-ON (J6 2&4) p. 16 Power-On Button connector
- 20) T2 p. 17 CPU Thermal Sensor connector
(Only for J-7ZXAS/L,J-7ZXAN/L)
- 21) JP6 p. 17 CD-ROM audio Panasonie connector
(Only for J-7ZXAS)
- 22) JP7 p. 17 CD-ROM audio Sony connector(Only for J-7ZXAS)
- 23) JP8 p. 17 On-board Sound Enabled/Disabled connector
(Only for J-7ZXAS)

Expansion Slots

- 1) DIMM Slots p. 8 DRAM Memory Expansion slots
- 2) Slot 1 p. 9 Slot for Central Processing Unit (CPU)
- 3) AGP Slot p. 10 AGP Expansion slot
- 4) ISA 1,2,3 p. 10 16-bit ISA Bus Expansion slots
- 5) PCI 1,2,3,4 p. 10 three 32-bit PCI slots Master mode & one 32-bit PCI slots
slave mode Expansion slots

2-3 Installation Steps

Before using your computer, you must follow the steps as follows:

1. Set Jumpers on the Motherboard

2. Install the CPU
3. Install DRAM Modules
4. Install Expansion card
5. Connect Cables, Wires, and Power Supply
6. Setup the BIOS Software

2-3-1 Jumper Settings

1. DIP Switch for CPU Type Selection: U12

<u>U12</u>	<u>1</u>	<u>2</u>	<u>3</u>	<u>4</u>
2.0X	ON	ON	ON	ON
2.5X	OFF	ON	ON	ON
3.0X	ON	OFF	ON	ON
3.5X	OFF	OFF	ON	ON
4.0X	ON	ON	OFF	ON
4.5X	OFF	ON	OFF	ON
5.0X	ON	OFF	OFF	ON

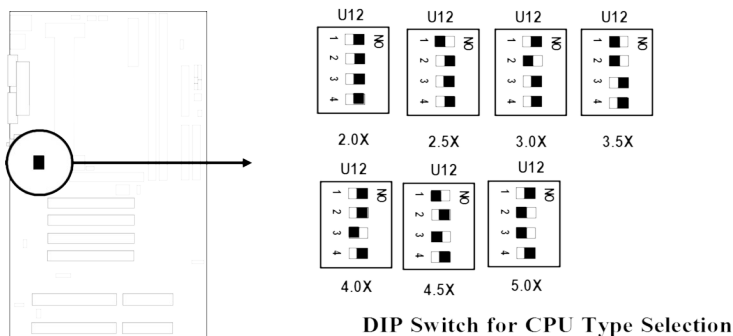

2. CPU Bus Frequency selection : J10

- 100MHZ : 1 - 2 closed (Default)
- 66MHZ : 2 - 3 closed

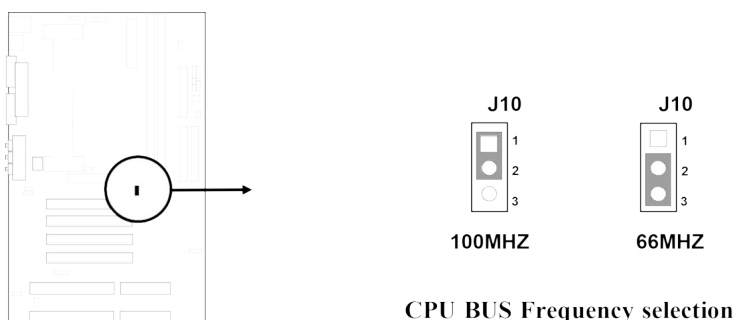

3. CMOS RAM: JP1 (Yellow color selector)

WARNING: Make sure your computer is POWER OFF when you are CLEAR CMOS.

Connect a jumper Cap over this jumper for a few seconds, will clears information stored in the CMOS RAM Chip that input by user, such as hard disk information and

passwords. After CLEAR CMOS, you must enter the BIOS setup (by holding down during power-up) to re-enter BIOS information (see BIOS SETUP).

Selections	JP1
Normal	2-3 (Default)
Clear CMOS	3-4 (momentarily)
External Battery	1-4

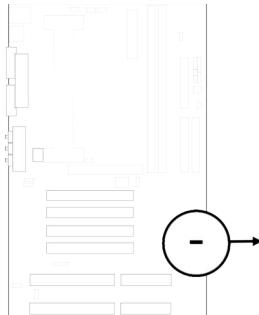

CMOS RAM (Normal / Clear CMOS Data / External Battery)

§ Jumper Setting For Pentium II CPU

CPU TYPE	BUS Frequency	Ratio	CPU Frequency	J10	U12			
					1	2	3	4
Pentium II 233	66MHz	×3.5	233MHz	2-3	OFF	OFF	ON	ON
Celeron 266 Pentium II 266	66MHz	×4.0	266MHz	2-3	ON	ON	OFF	ON
Celeron 300 Pentium II 300	66MHz	×4.5	300MHz	2-3	OFF	ON	OFF	ON
Celeron 333 Pentium II 333	66MHz	×5.0	333MHz	2-3	ON	OFF	OFF	ON
Pentium II 350	100MHz	×3.5	350MHz	1-2	OFF	OFF	ON	ON
Pentium II 400	100MHz	×4.0	400MHz	1-2	ON	ON	OFF	ON
Pentium II 450	100MHz	×4.5	450MHz	1-2	OFF	ON	OFF	ON

* Before install CPU please check the CPU Specification , and setting the correct CPU Bus Frequency and ratio in the jumper setting.

2-3-2 System Memory (DRAM)

This motherboard support four 168-pin DIMM Module, using +3V unbuffer synchronous DRAM in either EDO (66MHZ only) or SDRAM (66MHZ/100MHZ) with Max. memory size of 768MB.

DIM1	DIM2	DIM3	Total Memory Combination
16MB	none	none	16MB
16MB	16MB	none	32MB
16MB	16MB	16MB	48MB
32MB	none	none	32MB
32MB	32MB	none	64MB
32MB	32MB	32MB	96MB
64MB	none	none	64MB
64MB	64MB	none	128MB
64MB	64MB	64MB	192MB
128MB	none	none	128MB
128MB	128MB	none	256MB
128MB	128MB	128MB	384MB
256MB	none	none	256MB
256MB	256MB	none	512MB
256MB	256MB	256MB	768MB

2-4 Central Processing Unit (CPU)

The motherboard provides a Slot-1 for Pentium II processor. The CPU on board must have a fan or heat sink attached to prevent overheating.

WARNING: *Without a fan or heat sink, the CPU will overheat and cause damage to both the CPU and the motherboard.*

To install a CPU, first turn off your system and remove its cover. Locate the Slot- 1 and place RETENTION MODULE as following:

IMPORTANT: *You must set jumper U12 for both “CPU to Bus frequency Ratio” on [page6](#) and J10 for “Bus Frequency Selection” on [page5](#) depending on the CPU that you install.*

- ① Attach heat sink to the CPU.
- ② Place Part A on slot-1 and gently screw four corners on top of the mother-board.

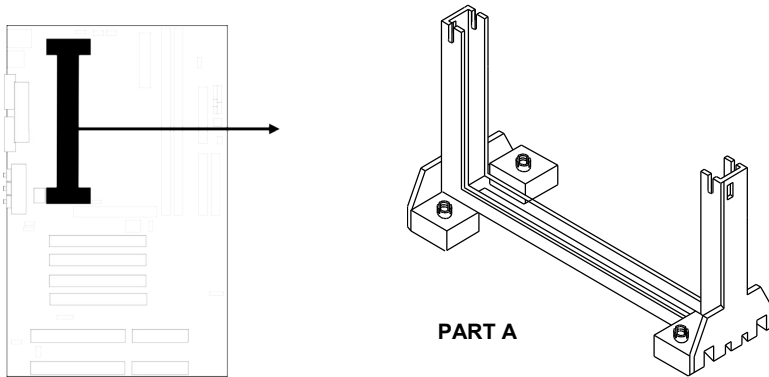

2-5 Expansion Cards

You must read the documentation come with expansion card for any hardware or software settings that may be required to setup your specific card.

Installation Procedure:

1. Read the documentation from your expansion card.
2. Set any necessary jumpers on your expansion card.
3. Remove your computer's cover.

-
-
4. Remove the bracket on the slot you intend to use.
 5. Carefully align the card's connectors and press firmly.
 6. Secure the card on the slot with the screw you remove in step 4.
 7. Replace the computer's cover.
 8. Setup the BIOS if necessary.
 9. Install the necessary software drivers for your expansion card.

Assigning IRQs for Expansion Cards

Some expansion cards may require an IRQ to operate. Generally an IRQ must be exclusively assigned to only one device. In a standard design there are 16 IRQs available but most of them are occupied by the system and leaves 6 free for expansion cards.

Either AGP, ISA or PCI expansion cards may require an IRQs. System IRQs are available to cards installed in the ISA expansion first, and any remaining IRQs can be used by PCI cards. Currently, there are two types of ISA cards. An original ISA expansion card design, know as "Legacy" ISA cards, they request configure the card's jumpers manually and then install it in any available slot on the ISA bus, and other know as Plug and Play. You may use Microsoft's Diagnostic (MSD.EXE) utility included in the DOS directory to see a map of your used and any free IRQs. For Windows 95 users, the "Control Panel" icon in "My Computer", contains a "System" icon which gives you "Device Manager" tab. Double clicking on a specific device give you "Resources" tab which shows the Interrupt number and address. Make sure that no any two of devices use the same IRQs, or your computer will experience problems when those two devices are in use at the same time.

To simplify this process the motherboard has complied with the Plug and Play (PNP) specification which was developed to allow automatic system configuration whenever a PNP-compliant card is added to the system. For PNP cards, IRQs are assigned automatically from those available.

If the system has both Legacy and PNP ISA cards installed, IRQs are assigned to PNP cards from those not used by Legacy cards. The PCI and PNP configuration of the BIOS setup utility can be used to indicate which IRQs are being used by Legacy cards. For older Legacy cards that does not work with the BIOS, you can contact your vendor for an ISA Configuration Utility.

An IRQ number is automatically assigned to PCI expansion cards after those used by Legacy and PNP ISA cards. In the PCI bus design, the BIOS automatically assigns an IRQ to a PCI. To install a PCI card, you need to set something called the INT (interrupt) assignment. Since all the PCI slots on this motherboard use an INTA #, be sure that the jumpers on your PCI cards are set to INT A.

Assigning DMA Channels for ISA Cards

Some ISA cards, both Legacy and PNP may also need to use a DMA (Direct Memory Access) channel. DMA assignments for this motherboard are handled the same way as the IRQ assignment process described above. You can select a DMA channel in the PCI

and PNP configuration section of the BIOS Setup utility. In the BIOS setup, you should choose “Yes” for those IRQ’s and DMA’s you wish to reserve for Legacy cards.

2-6 External Connectors

1. ATX Power Connector (20-pin block): PL1

ATX Power Supply connector. This is a new defined 20-pin connector that usually comes with ATX case. The ATX Power Supply allows to use soft power on momentary switch that connect from the front panel switch to 2-pin Power On jumper pole on the motherboard. When the power switch on the back of the ATX power supply turned on, the full power will not come into the system board until the front panel switch is momentarily pressed. Press this switch again will turn off the power to the system board.

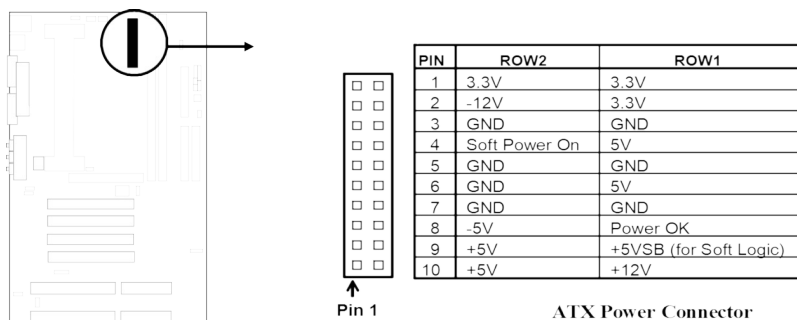

2. PS/2 Mouse & PS/2 Keyboard Connector: CN1

The PS/2 Keyboard is a 6-pin miniature DIN connector. It is for a standard PS/2 style keyboard. May also be known as a 101 enhanced keyboard. The PS/2 Mouse connector is a similar 6-pin, miniature DIN connector.

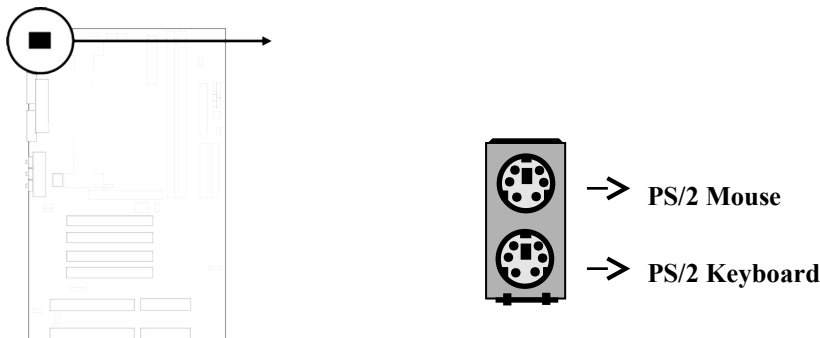

3. Parallel Port Connector (25-pin female): CN3

Parallel Port connector is a 25-pin D-Subminiature Receptacle connector. The On-board Parallel Port can be disabled through the BIOS SETUP. Please refer to Chapter 3 “INTEGRATED PERIPHERALS SETUP” section for more detail information.

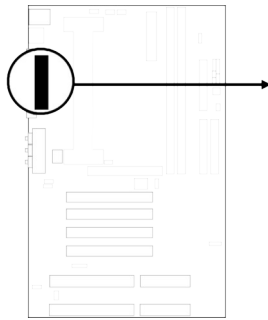

Parallel Port Connector

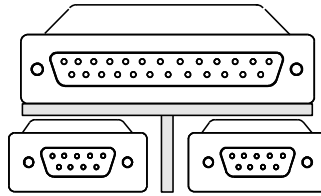

4. Serial Port COMA and COMB Connector: CN2, CN4

COMA and COMB are the 9-pin D-Subminiature mail connector. The On-board serial port can be disabled through BIOS SETUP. Please refer to Chapter 3 “INTEGRATED PERIPHERALS SETUP“ section for more detail information.

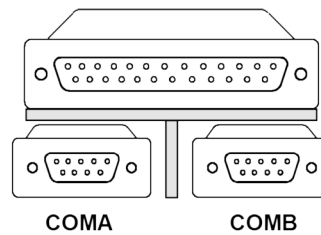
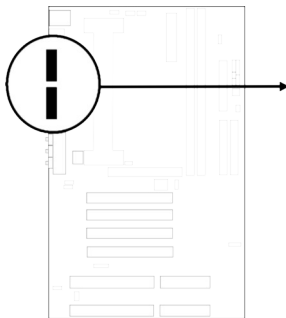

Serial Port COMA & COMB Connector

5. Audio and Game Connector : CN5(Only in J-7ZXAS,J-7ZXAS/L)

This Connector are 3 phone Jack for LINE-OUT,LINE-IN,MIC and a 15-pin D-Subminiature Receptacle Connector for joystick/MIDI Device.

Line-out : audio output to speaker

Line-in : audio input to sound chip

MIC : Microphone Connector

Game/MIDI : for joystick or MIDI Device

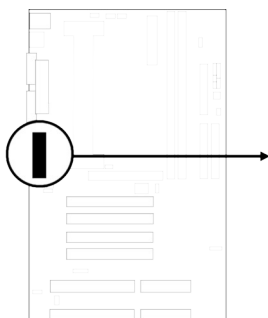

Game / MIDI PORT

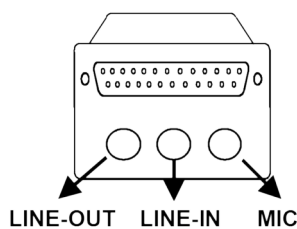

Audio and Game Connector

6. Floppy drive Connector (34-pin block): FDD

This connector supports the provided floppy drive ribbon cable. After connecting the single plug end to motherboard, connect the two plugs at other end to the floppy drives.

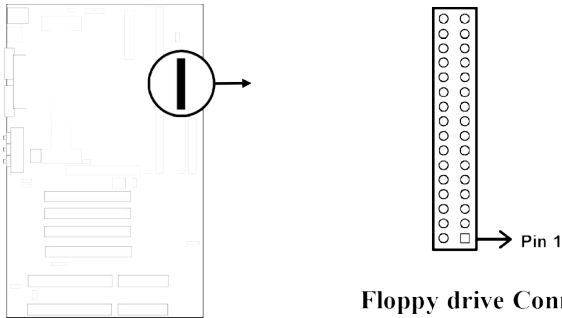

Floppy drive Connector

7. Primary IDE Connector (40-pin block): IDE0

This connector supports the provided IDE hard disk ribbon cable. After connecting the single plug end to motherboard, connect the two plugs at other end to your hard disk(s). If you install two hard disks, you must configure the second drive to Slave mode by setting its jumpers accordingly. Please refer to the documentation of your hard disk for the jumper settings.

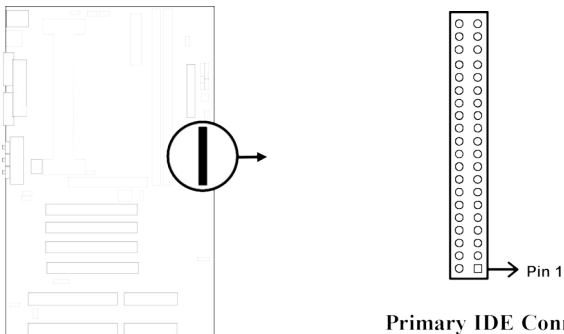

Primary IDE Connector

8. Secondary IDE Connector (40-pin block): IDE1

This connector connects to the next set of Master and Slave hard disks. Follow the same procedure described for the primary IDE connector. You may also configure two hard disks to be both Masters using one ribbon cable on the primary IDE connector and another ribbon cable on the secondary IDE connector.

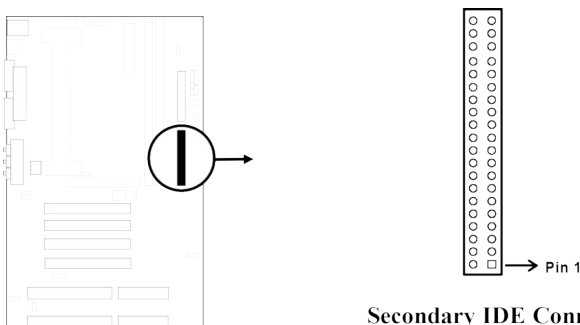

Secondary IDE Connector

9. SMI suspend switch lead: SMI (J5 2&4)

This allows the user to manually place the system into a suspend mode or “Green” mode where system activity will be instantly decreased to save electricity and expand the life of certain components when the system is not in use. This 4-pins connector (see the figure below) connects to the case-mounted suspend switch. If you do not have a switch for the connector, you may use the “Turbo Switch” since it does not have a function. SMI is activated when it detects a **short to open** moment and therefore leaving it shorted will not cause any problems. May require one or two pushes depending on the position of the switch. Wake-up can be controlled by settings in the BIOS but the keyboard will always allow wake-up (the SMI lead cannot wake-up the system). If you want to use this connector, “Suspend Switch” in the POWER MANAGEMENT SETUP of the BIOS software should be on the default setting of **Enable** (see [page 25](#)).

<u>Selections</u>	<u>SMI</u>
Enter suspend mode	2-4
Normal	open

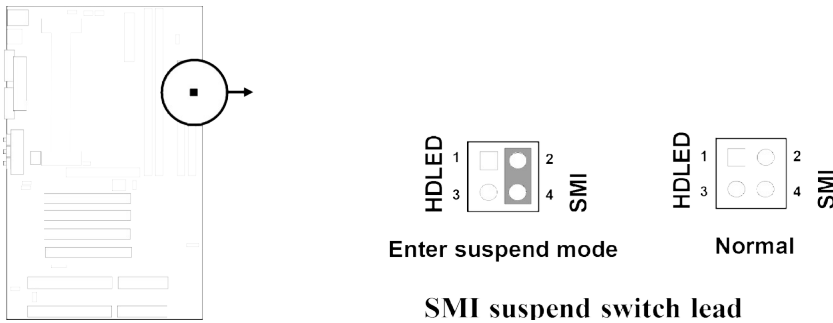

10. IDE activity LED: HDLED (J5 1&3)

This connector connects to the hard disk activity indicator light on the case.

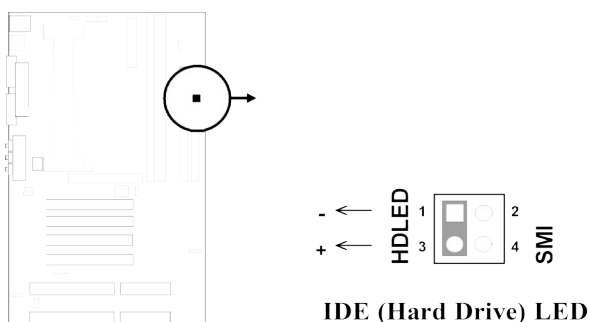

11. Turbo LED switch: TBLED

The motherboard's turbo function is always on. The turbo LED will remain constantly lit while the system power is on. You may wish to connect the Power LED from the system case to this lead. See the figure below.

12. Reset switch lead: RST

This 2-pin connector connects to the case-mounted reset switch for rebooting your computer without having to turn off your power switch. This is a preferred method of rebooting in order to prolong the life of the system's power supply. See the figure below.

13. Keyboard lock switch lead: KEYLOCK

This 5-pin connector connects to the case-mounted key switch for locking the keyboard for security purposes. See the figure below.

14. Speaker connector: SPEAKER

This 4-pins connector connects to the case-mounted speaker. See the figure below.

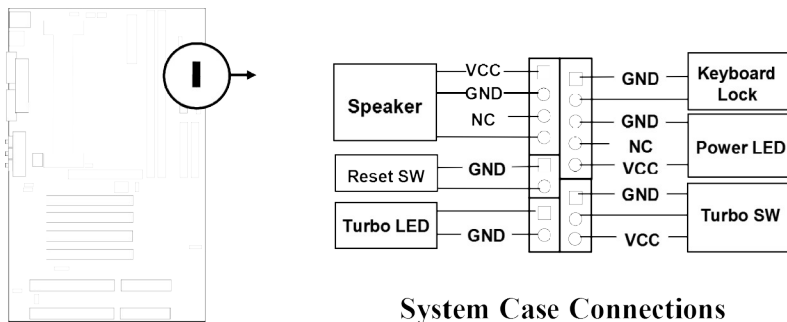

15. IR infrared module connector: J7

This connector supports the optional wireless transmitting and receiving infrared module. This module mounts to small opening on system cases that support this feature you must also configure the setting through BIOS setup. Use the four pins as shown on the Back View and connect a ribbon cable from the module to the motherboard according to the pin definitions.

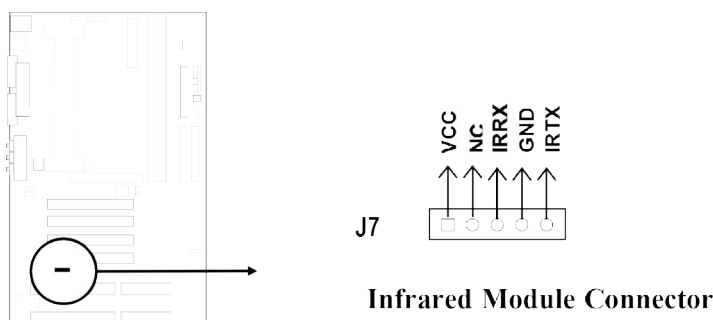

16. USB Port connector: USB

The connectors are 4-pins connector that connect USB devices to the system board.

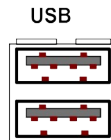
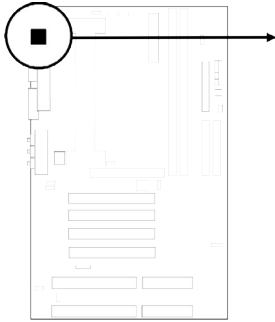

USB Port Connector

17. CPU FAN connector: CPUFAN

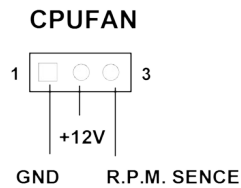
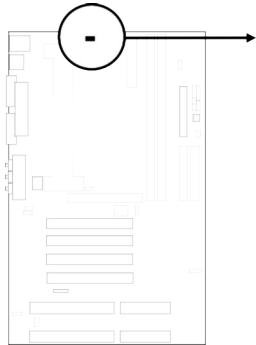

CPU Fan Connector

18. Extra fanning system connectors: FAN1, FAN2

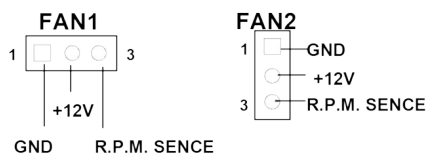
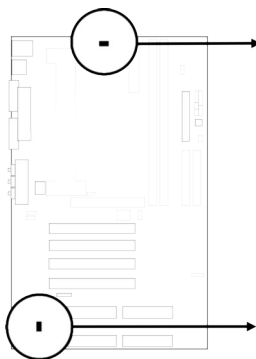

Extra fanning system Connector

19. Power-On button connector: PS-ON (J6 2&4)

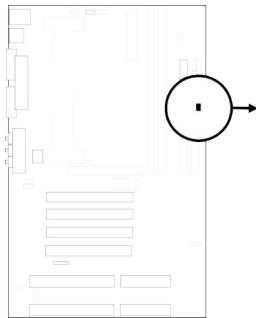

Power-On button connector

20. CPU Thermal Sensor connector: T2 (only for J-7ZXAS/L,J-7ZXAN/L)

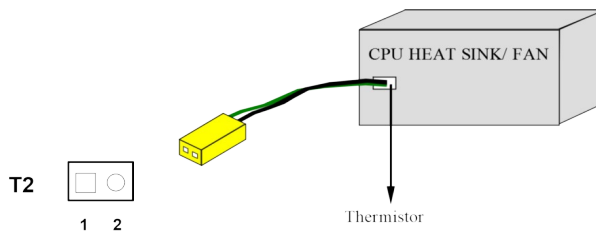
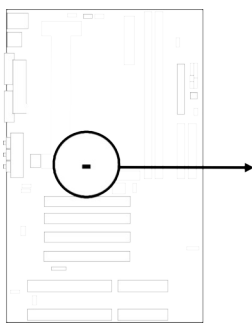

21. CD Audio in connector : JP6,JP7(Only for J-7ZXAS)

J6 and JP7 are the connectors for CD-Audio Input signal, Please connect it to CD-ROM

CD-Audio output connector

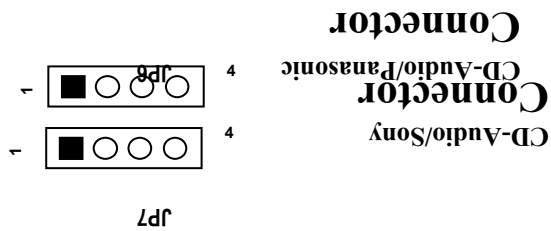
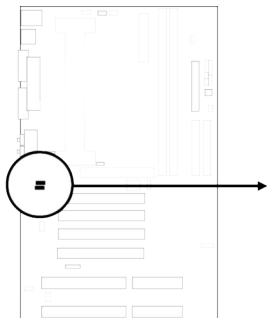

22. On-board Sound card Enabled/Disabled connector : JP8(Only for J-7ZXAS)

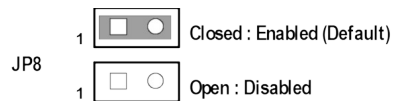
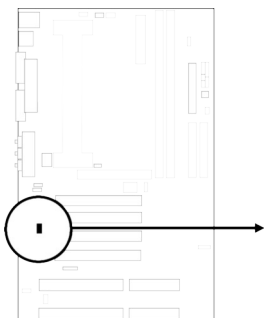

On-board Sound Enabled/Disabled connector

Chapter 3

AWARD BIOS SETUP

Award's ROM BIOS provides a built-in Setup program which allows user modify the basic system configuration and hardware parameters. The modified data will be stored in a battery-backed CMOS RAM so data will be retained even when the power is turned off. In general, the information saved in the CMOS RAM stay unchanged unless here is configuration change in the system, such as hard drive replacement or new equipment is installed.

It is possible that CMOS had a battery failure which cause data lose in CMOS_RAM. If so, re_enter system configuration parameters become necessary.

To enter Setup Program

Power on the computer and press **** key immediately will bring you into BIOS **CMOS SETUP UTILITY**.

ROM PCI/ISA BIOS (2A69KJ1C)

CMOS SETUP UTILITY
AWARD SOFTWARE, INC.

STANDARD CMOS SETUP	INTEGRATED PERIPHERALS
BIOS FEATURES SETUP	SUPERVISOR PASSWORD
CHIPSET FEATURES SETUP	USER PASSWORD
POWER MANAGEMENT SETUP	IDE HDD AUTO DETECTION
PNP/PCI CONFIGURATION	HDD LOW LEVEL FORMAT
LOAD BIOS DEFAULTS	SAVE & EXIT SETUP
LOAD SETUP DEFAULTS	EXIT WITHOUT SAVING
Esc : QUIT ↑↓ → ← : Select Item	

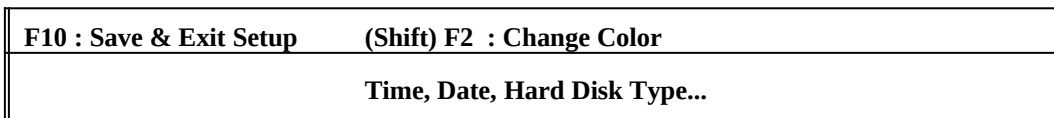

Figure 3-1

The menu displays all the major selection items and allow user to select any one of shown item. The selection is made by moving cursor (press any direction key) to the item and press <Enter> key. An on_line help message is displayed at the bottom of the screen as cursor is moving to various items which provides user better understanding of each function. When a selection is made, the menu of selected item will appear so the user can modify associated configuration parameters.

3-1 STANDARD CMOS SETUP

Choose "**STANDARD CMOS SETUP**" in the CMOS SETUP UTILITY Menu (Figure 3-1). The STANDARD CMOS SETUP allows user to configure system setting such as current date and time, type of hard disk drive installed in the system, floppy drive type, and the type of display monitor. Memory size is auto-detected by the BIOS and displayed for your reference. When a field is highlighted (direction keys to move cursor and <Enter> key to select), the entries in the field will be changed by pressing <PgDn> or <PgUp> keys or user can enter new data directly from the keyboard.

ROM PCI/ISA BIOS (2A69KJ1C)

STANDARD CMOS SETUP AWARD SOFTWARE, INC.

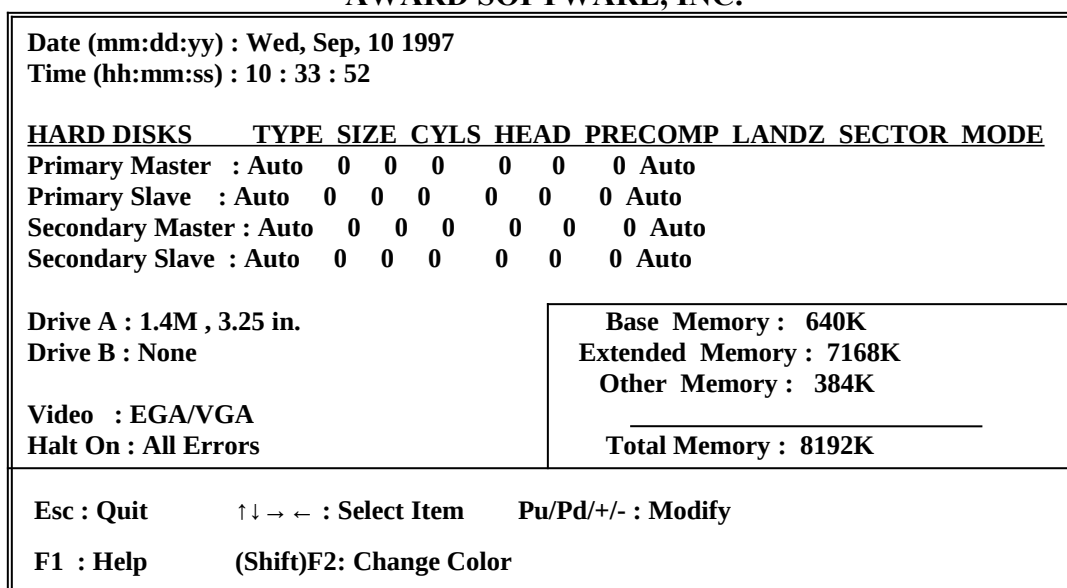

Figure 3-2

NOTE: *If hard disk Primary Master/Slave and Secondary Master/Slave were used Auto, than the hard disk size and model will be auto-detect on display during POST.*

NOTE: *The "Halt On:" field is to determine when to halt the system by the BIOS is error occurred during POST.*

3-2 BIOS FEATURES SETUP

Select the "BIOS FEATURES SETUP" option in the CMOS SETUP UTILITY menu allows user to change system related parameters in the displayed menu. This menu shows all of the manufacturer's default values of this motherboard. Again, user can move the cursor by pressing direction keys and <PgDn> of <PgUp> keys to modify the parameters. Pressing [F1] key to display help message of the selected item.

This setup program also provide 2 convinent ways to load the default parameter data from BIOS [F6] or CMOS [F7] area if shown data is corrupted. This provides the system a capability to recover from any possible error.

ROM PCI/ISA BIOS (2A69KJ1C)

BIOS FEATURES SETUP
AWARD SOFTWARE, INC.

Virus Warning : Disabled CPU Internal Cache : Enabled External Cache : Enabled Quick Power On Self Test : Disabled Boot Sequence : A,C,SCSI Swap Floppy Drive : Disabled Boot Up Floppy Seek : Enabled Boot Up Numlock Status : On Boot Up System Speed : High Gate A20 Option : Fast Typematic Rate Setting : Disabled Typematic Rate (Chars/Sec) : 6 Typematic Delay (Msec) : 250 Security Option : Setup Assign IRQ for VGA : Enabled PCI/VGA Palette Snoop : Disabled OS Select For DRAM > 64MB : Non-OS2 HDD S.M.A.R.T Capability : Disabled Report NO FDD WIN 95 : Disabled	Video BIOS Shadow : Enabled C8000-CBFFF Shadow : Disabled CC000-CFFFF Shadow : Disabled D0000-D3FFF Shadow : Disabled D4000-D7FFF Shadow : Disabled D8000-DBFFF Shadow : Disabled DC000-DFFFF Shadow : Disabled Esc: Quit ↑↓→← : Select Item F1 : Help Pu/Pd/+/-:Modify F5 : Old Values (Shift)F2 : Color F6 : Load BIOS Defaults F7 : Load Setup Defaults
---	---

Figure 3-3

NOTE: The Security Option contains "setup" and "system". The "setup" indicates that the password setting is for CMOS only while the "system" indicates the password setting is for both CMOS and system boot up procedure.

- **Virus Warning:** This category flashes on the screen. During and after the system boots up, any attempt to write to the boot sector or partition table of the hard disk drive will halt the system and the following error message will appear, in the mean time, you can run an anti-virus program to locate the problem. Default value is Disabled

Enabled: Activates automatically when the system boots up causing a warning message to appear when anything attempts to access the boot sector or hard disk partition table.

Disabled: No warning message to appear when anything attempts to access the boot sector or hard disk partition table.

- **CPU Internal Cache / External Cache:** These two categories speed up memory access. However, it depends on CPU/chipset design. The default value is Enable. If your CPU without Internal Cache then this item "CPU Internal Cache" will not be show.

Enabled: Enable cachehis category speeds up Power On Self Test. (POST) after you power on the computer.

Disabled: Disable cache

- **Quick Power On Self Test:** If it is set to Enable, BIOS will shorten or skip some check items during POST.

Enabled: Enable quick POST

Disabled: Normal POST

- **Boot Sequence:** This category determines which drive computer searches first for the DOS (Disk Operating System). Default value is A,C,SCSI. System will first search for floppy disk drive, then hard disk drive and then SCSI device. The options are: C, A, SCSI; C, CDROM, A; CDROM, C, A; D, A, SCSI; E, A, SCSI; F, A, SCSI; SCSI, A, C; SCSI, C, A; C only; LS/ZIP, C.

- **Swap Floppy Drive:** The swap floppy drive. Default value is Disabled.

Enabled: Floppy A & B will be swapped under the DOS

Disabled: Floppy A & B will be not swap

- **Boot Up Floppy Seek:** During POST, BIOS will determine if the floppy disk drive installed is 40 or 80 tracks. 360K type is 40 tracks while 760K, 1.2M and 1.44M are all 80 tracks. The default value is Enabled.

Enabled: BIOS searches for floppy disk drive to determine if it is 40 or 80 tracks. Note that BIOS can not tell from 720K, 1.2M or 1.44M drive type as they are all 80 tracks.

Disabled: BIOS will not search for the type of floppy disk drive by track number. Note that there will not be any warning message if the drive installed is 360K.

- **Boot Up NumLock Status:** The default value is On.
On: Keypad is number keys.
Off: Keypad is arrow keys.
- **Boot UP System Speed:** It selects the default system speed-the speed that the system will run at immediately after power up.
High: Set the speed to high.
Low: Set the speed to low.

NOTE: *The board default value is LOW in the field. Boot the system to controller turbo or De-turbo by Onboard (Turbo Switch).*

- **Gate A20 Option:** The default value is Fast.
Normal: The A20 signal is controlled by keyboard controller or chipset hardware.
Fast: Default: Fast. The A20 signal is controlled by Port 92 or chipset specific method.
- **Typematic Rate Setting:** This determines the typematic rate.
Enabled: Enable typematic rate and typematic delay programming.
Disabled: Disable typematic rate and typematic delay programming. The system BIOS will use default value of this 2 items and the default is controlled by keyboard.
- **Typematic Rate (Chars/Sec):**

6 : 6 characters per second	8 : 8 characters per second
10 : 10 characters per second	12 : 12 characters per second
15 : 15 characters per second	20 : 20 characters per second
24 : 24 characters per second	30 : 30 characters per second
- **Typematic Delay (Msec):** When holding a key, the time between the first and second character displayed.

250 : 250 msec
500 : 500 msec
750 : 750 msec
1000 : 1000 msec
- **Security Option:** This category allows you to limit access to the system and Setup, or just to Setup. The default value is Setup.
System: The system will not boot and access to Setup will be denied if the correct password is not entered at the prompt.
Setup: The system will boot, but access to Setup will be denied if the incorrect password is entered at the prompt.

NOTE: *To disable security, select PASSWORD SETTING at Main Menu and then you will be asked to enter password. Do not type anything and just press <Enter>, it will disable security. Once the security is disabled, the system will boot and you can enter Setup freely.*

- **Video BIOS Shadow:** It determines whether video BIOS will be copied to RAM, however, it is optional from chipset design. Video Shadow will increase the video speed.

Enabled: Video shadow is enabled

Disabled: Video shadow is disabled

- C8000 - CBFFF Shadow:
- CC000 - CFFFF Shadow:
- D0000 - D3FFF Shadow:
- D4000 - D7FFF Shadow:
- D8000 - DBFFF Shadow:
- DC000 - DFFFF Shadow:

These categories determine whether optional ROM will be copied to RAM by 16K byte or 32K byte per/unit and the size depends on chipset.

Enabled: Optional shadow is enabled.

Disabled: Optional shadow is disabled.

3-3 CHIPSET FEATURES SETUP

Choose the "CHIPSET FEATURES SETUP" in the CMOS SETUP UTILITY menu to display following menu.

ROM PCI/ISA BIOS (2A69KJ1C)

CHIPSET FEATURES SETUP

AWARD SOFTWARE, INC.

Auto Configuration : Enabled EDO DRAM Speed Selection : 60 ns EDO CASx# MA Wait State : 2 EDO RASx# Wait State : 1 SDRAM RAS-to-CAS Delay : 3 SDRAM RAS Precharge Time : 3 SDRAM CAS latency Time : 3 SDRAM Precharge Control : Disabled DRAM Data Integrity Mode : Non-ECC System BIOS Cacheable : Enabled Video BIOS Cacheable : Enabled Video RAM Cacheable : Disabled 8 Bit I/O Recovery Time : 1 16 Bit I/O Recovery Time : 1 Memory Hole At 15M-16M : Disabled Passive Release : Enabled Delayed Transaction : Disabled AGP Aperture Size : 64	Auto Detect DIMM/PCI Clk : Enabled Spread Spectrum Modulated: Disabled CPU Host/PCI Clock : Default Esc: Quit ↑↓ → ← : Select Item F1 : Help Pu/Pd/+/-:Modify F5 : Old Values (Shift)F2 : Color F6 : Load BIOS Defaults F7 : Load Setup Defaults
---	---

Figure 3-4

- **DRAM Timing:** The default value is 60ns.
60ns : 2 (faster) Burst Wait State, for 60~70ns Fast Page Mode/EDO DRAM.
70ns : 3 (slower) Burst Wait State, for 70ns Fast Page Mode/EDO DRAM.

- **Video BIOS Cacheable:** The default value is Enabled.
Enabled: This field Enabled the Video BIOS Cacheable to speed up to VGA Performance.
Disabled: Disabled the Video BIOS Cacheable function.
 - **8/16 Bit I/O Recovery Time:** The default value is 1.
8 Bit I/O Recovery Time: This field defines the recovery time from 1 to 8 for 8-bit I/O.
- 16 Bit I/O Recovery Time:** To define the recovery time from 1 to 4 for 16-bit I/O.
- **Memory Hole At 15M~16M:**The default value is Disabled.
Disabled: Normal Setting.
Enabled: This field enabled the main memory (15~16MB) remap to ISA BUS.
 - **CPU Host/PCI Clock :** This field can select the CPU Host/PCI Clock 66/33MHz,68/34MHz,75/37MHz,83/41MHz,103/34MHz,112/33MHz,100/33MHz.

Only for J-7ZXAS/L,J-7ZXAN/L

Choose the "CHIPSET FEATURES SETUP" in the CMOS SETUP UTILITY menu to display following menu.

ROM PCI/ISA BIOS (2A69KJ1C)

CHIPSET FEATURES SETUP

AWARD SOFTWARE, INC.

Auto Configuration : Enabled EDO DRAM Speed Selection : 60 ns EDO CASx# MA Wait Srate : 2 EDO RASx# Wait State : 1 SDRAM RAS-to-CAS Delay : 3 SDRAM RAS Precharge Time : 3 SDRAM CAS latency Time : 3 SDRAM Precharge Control : Disabled DRAM Data Integrity Mode : Non-ECC System BIOS Cacheable : Enabled Video BIOS Cacheable : Enabled Video RAM Cacheable : Disabled 8 Bit I/O Recovery Time : 1 16 Bit I/O Recovery Time : 1 Memory Hole At 15M-16M : Disabled Passive Release : Enabled Delayed Transaction : Disabled AGP Aperture Size : 64	Auto Detect DIMM/PCI Clk : Enabled Spread Spectrum Modulated: Disabled CPU Host/PCI Clock : Default CPU Warnung Temperature : Disabled Current System Temp. : 44°C/111°F Current CPU1 Temperature : 34°C/93°F Current CPUFAN1 Speed : 0 RPM Current FAN1 Speed : 0 RPM Current FAN2 Speed : 5232 RPM Core(V) : 2.80V Vtt(V) : 1.50V V I/O(V): 3.3V 5 Volt : 5.10V +12Volt : 12 V -12Volt: -12.0V -5Volt : -5.10V
Esc: Quit ↑↓←→ : Select Item F1 : Help Pu/Pd/+/-:Modify F5 : Old Values (Shift)F2 : Color F6 : Load BIOS Defaults F7 : Load Setup Defaults	

Figure 3-5

- **DRAM Timing:** The default value is 60ns.

-
-
- 60ns** : 2 (faster) Burst Wait State, for 60~70ns Fast Page Mode/EDO DRAM.
70ns : 3 (slower) Burst Wait State, for 70ns Fast Page Mode/EDO DRAM.
 - **Video BIOS Cacheable:** The default value is Enabled.
Enabled: This field Enabled the Video BIOS Cacheable to speed up to VGA Performance.
Disabled: Disabled the Video BIOS Cacheable function.
 - **8/16 Bit I/O Recovery Time:** The default value is 1.
8 Bit I/O Recovery Time: This field defines the recovery time from 1 to 8 for 8-bit I/O.
16 Bit I/O Recovery Time: To define the recovery time from 1 to 4 for 16-bit I/O.
 - **Memory Hole At 15M~16M:**The default value is Disabled.
Disabled: Normal Setting.
Enabled: This field enables the main memory (15~16MB) remap to ISA BUS.
 - **CPU Warning Temperature:** If CPU's temperature approach to setting temperature, system will slow down automatically to reduce the CPU's temperature. The settings are 70°, 66°, 63°, 60°, 56°, 53°, 50° and Disabled.
 - **Current CPU Temperature:** Indicate the temperature of the CPU at present time.
 - **Current System Temperature:** Indicate the temperature of entire system of present time.
 - **Core (V), I/O (V):** Indicate the CPU's Core Voltage and I/O Voltage.
 - **12Volt, -12Volt, -5Volt, 5Volt:** Indicate the voltage incoming for power supply.
 - **CPU Host/PCI Clock :** This field can select the CPU Host/PCI Clock
66/33MHz,68/34MHz,75/37MHz,83/41MHz,103/34MHz,112/33MHz,100/33MHz.

3-4 POWER MANAGEMENT SETUP

Choose the "POWER MANAGEMENT SETUP" in the CMOS SETUP UTILITY to display the following screen. This menu allows user to modify the power management parameters and IRQ signals. In general, these parameters should not be changed unless it's absolutely necessary.

ROM PCI/ISA BIOS (2A69KJ1C)

POWER MANAGEMENT SETUP

AWARD SOFTWARE, INC.

Power Management : Disabled PM Control by APM : Yes Video Off Method : V/H SYNC+Blank Video Off After : Stand by MODEM Use IRQ : 3 Doze Mode : Disabled Standby Mode : Disabled Suspend Mode : Disabled HDD Power Down : Disabled Throttle Duty Cycle : 62.5% ZZ Active in Suspend : Disabled VGA Active Monitor : Enabled Soft-Off by PWR-BTTN : Instant-Off CPUFAN Off In Suspend : Enabled Resume by Ring : Enabled IRQ 8 Break Suspend : Disabled	** Reload Global Timer Events ** IRQ [3-7, 9-15], NMI : Enabled Primary IDE 0 : Disabled Primary IDE 1 : Disabled Secondary IDE 0 : Disabled Secondary IDE 1 : Disabled Floppy Disk : Disabled Serial Port : Enabled Parallel Port : Disabled
	Esc: Quit ↑↓ → ← : Select Item F1: Help Pu/Pd/+/-: Modify F5: Old Values (Shift)F2: Color F6: Load BIOS Defaults F7: Load Setup Defaults

Figure 3-6

Again, user can move the cursor by pressing direction keys to the field need to be modified and press <PgDn> or <PgUp> to alter item selection. You can only change the content of Doze Mode, Standby Mode, and Suspend Mode when the Power Management is set to 'User Define'.

3-4-1 The Description of the Power Management

- **Power Management mode selection:**

Disabled: The system operates in NORMAL conditions (Non-GREEN), and the Power Management function is disabled.

Max.saving: This mode will maximize the power saving capability.

Min.saving: This mode will minimize the power saving capability.
User define: Allow user to define timeout parameters to control power saving timing.
Refer item shown below:

- **Timeout parameters:**

HDD Standby

HDD Standby timer can be set from 1 to 15 minute(s).

System Doze

The "System Doze" mode timer starts to count when there is no "PM events" occurred. The valid timeout setting is from 1 minute up to 1 hour.

System Standby

The "Standby" mode timer starts to count when "System Doze" mode timer timed out and no "PM events" occurred. Valid range is from 1 minute up to 1 hour.

System Suspend

This function works only when the Pentium CPU is installed. The timer starts to count when "System Standby" mode timer timed out and no "PM Events" occurred. Valid range is from 1 minute up to 1 hour.

3-4-2 Description of the Green Functions

This motherboard supports HDD Power Down, Doze and standby power saving functions when Intel Pentium Processor CPU is installed. The suspend function is also supported when the SMI switch is short (ref. [page 12](#)). The detail description of these functions are provided as following:

HDD Standby Mode

When system stop reading or writing HDD, the timer starts to count. The system will cut off the HDD power when timer ran out of time. The system will not resume operation until either a read from or a write to HDD command is executed again.

Doze Mode

The system hardware will drop down CPU clock from normal working speed when Doze mode timeout occurred.

Standby Mode

When the system standby mode timer ran out, it will enter the standby mode and retain CPU at slow working speed. The screen will be blanked out.

Suspend Mode

When the system suspend timer time out, the system will enter the suspend mode and the chipset will stop CPU clock immediately. The power consumption in Suspend Mode is lower than in standby mode. The screen is also blanked out.

PM Events:

AWARD BIOS defines 15 PM Events in the power management mode (Doze, standby & suspend). The user can initial any PM Events to be "Enable" or "Disable". When the system detects all of the enabled events do not have any activity, it will start the system Doze timer first if the "Power Management" isn't "Disabled". Once the system Doze timer timed out, it will process doze power saving procedure by starting the system standby timer. When the standby timer ran out and all of the "Enabled" events remains silent, the

system will enter the standby mode. By now, the system will not only process the standby power saving procedures but also start the system suspend timer. When the suspend timer time out, all of the CPU clock will be stopped by dropping system clock down to zero and remains this way until any one of the "Enabled" event occurred.

3-5 PNP/PCI CONFIGURATION SETUP

This "PNP and PCI configuration Setup" option configures the PCI bus slots. All PCI bus slots on the system use INTA#, thus all installed PCI cards must be set to this value.

ROM PCI/ISA BIOS (2A69KJ1C)

PNP/PCI CONFIGURATION SETUP
AWARD SOFTWARE, INC.

<p>PNP OS Installed : No Resources Controlled By : Manual Reset Configuration Data: Disabled</p> <p>IRQ-3 assigned to : Legacy ISA IRQ-4 assigned to : Legacy ISA IRQ-5 assigned to : PCI/ISA PnP IRQ-7 assigned to : PCI/ISA PnP IRQ-9 assigned to : PCI/ISA PnP IRQ-10 assigned to : PCI/ISA PnP IRQ-11 assigned to : PCI/ISA PnP IRQ-12 assigned to : PCI/ISA PnP IRQ-14 assigned to : PCI/ISA PnP IRQ-15 assigned to : PCI/ISA PnP DMA-0 assigned to : PCI/ISA PnP DMA-1 assigned to : PCI/ISA PnP DMA-3 assigned to : PCI/ISA PnP DMA-5 assigned to : PCI/ISA PnP DMA-6 assigned to : PCI/ISA PnP DMA-7 assigned to : PCI/ISA PnP</p>	<p>Slot 1 Use IRQ NO : AUTO Slot 2 Use IRQ NO : AUTO Assign Sound IRQ NO : 5 (Only in J-7ZXAS) Slot 3 Use IRQ NO : AUTO</p> <p>Used MEM base addr : N/A</p> <p>Assign IRQ For USB : Enabled</p> <hr/> <p>Esc: Quit ↑↓ → ← : Select Item F1 : Help Pu/Pd/+/-:Modify F5 : Old Values (Shift)F2 : Color F6 : Load BIOS Defaults F7 : Load Setup Defaults</p>
--	---

Figure 3-7

IRQxx assigned to

These fields indicate whether or not the displayed IRQ for each field is being used by a Legacy (non-PnP) ISA card. Two options are available: "PCI/ISA PnP" and "Legacy ISA". The first option the default value, indicates either that the displayed IRQ is not used or an PCI/ISA PnP is being used to determine if an ISA card is using that IRQ. Second option is for Legacy ISA card that requires a unique IRQ, and you are not using an PCI/ISA PnP, you must set the field for that IRQ to Legacy ISA.

For example: If you install a Legacy ISA card that requires IRQ10 lets say, then set "IRQ10 assigned to Legacy ISA".

DMAxx assigned to

These fields indicate whether or not the displayed DMA channel for each field is being used by a Legacy (non-PnP) ISA card. Available options include: "PCI/ISA PnP" and "Legacy ISA". When is option "PCI/ISA PnP" indicates either that the displayed DMA

channel is not used or an PCI/ISA PnP being used to determine if an ISA card is using that channel. If you install a Legacy ISA card that requires a unique DMA channel, and you are not using an PCI/ISA PnP, you must set the field for that channel to "Legacy ISA".

3-6 LOAD BIOS DEFAULTS

The "LOAD BIOS DEFAULTS" function loads the system default data directly from ROM and initialize associated hardware properly. This function will be necessary only when the system CMOS data is corrupted.

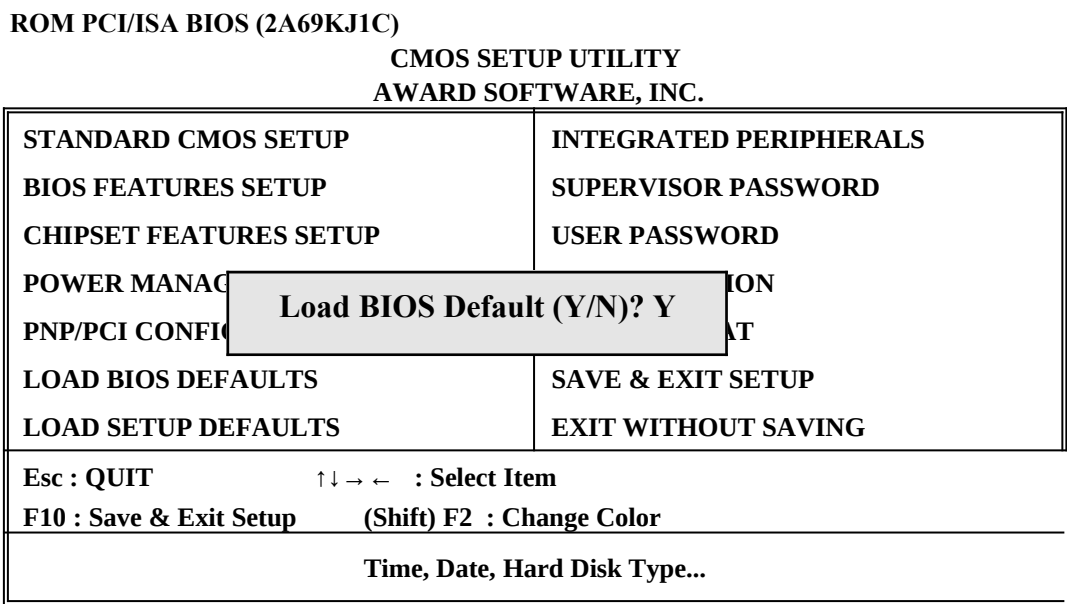
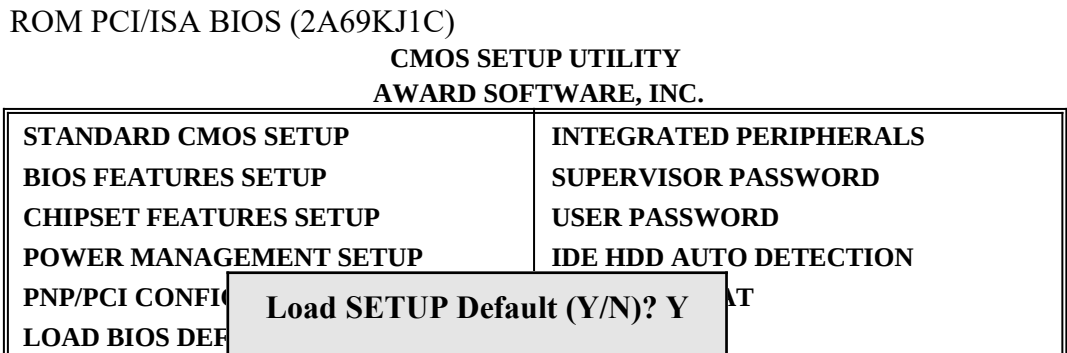

Figure 3-8

3-7 LOAD SETUP DEFAULTS

The "LOAD SETUP DEFAULTS" function loads the system default data directly from ROM and initialize associated hardware properly. This function will be necessary only when the system CMOS data is corrupted.



LOAD SETUP DEFAULTS	EXIT WITHOUT SAVING
Esc : QUIT ↑↓ → ← : Select Item	
F10 : Save & Exit Setup (Shift) F2 : Change Color	
Time, Date, Hard Disk Type...	

Figure 3-9

3-8 INTEGRATED PERIPHERALS SETUP

ROM PCI/ISA BIOS (2A69KJ1C)

INTEGRATED PERIPHERALS

AWARD SOFTWARE, INC.

IDE HDD Block Mode : Enabled IDE Primary Master PIO : Auto IDE Primary Slave PIO : Auto IDE Secondary Master PIO : Auto IDE Secondary Slave PIO : Auto IDE Primary Master UDMA : Auto IDE Primary Slave UDMA : Auto IDE Secondary Master UDMA : Auto IDE Secondary Slave UDMA : Auto On-Chip Primary PCI IDE: Enabled On-Chip Secondary PCI IDE: Enabled USB Keyboard Support : Enabled Init Display First : PCI SLOT Power On Function : Button KB Power On Password : Hot key Power On : Ctrl-F1 KBC Input Clock : 8MHz Onboard FDC Controller : Enabled Onboard SERIAL PORT 1 : 3F8/IRQ4 Onboard SERIAL PORT 2 : 2F8/IRQ3 UR2 Mode : Normal	Onboard Parallel Port : 378/IRQ7 Parallel Port Mode : SPP
	Esc: Quit ↑↓ → ← : Select Item F1 : Help Pu/Pd/+/-:Modify F5 : Old Values (Shift)F2 : Color F6 : Load BIOS Defaults F7 : Load Setup Defaults

Figure 3-10

NOTE: *If you don't use the Onboard IDE connector, than use On-card (PCI or ISA card) IDE connector. You will set Onboard Primary IDE: Disabled an Onboard Secondary IDE: Disabled from CHIPSET FEATURES SETUP UTILITY.*

The Onboard PCI IDE cable should be equal to or less than 18 inches (45 cm).

- **IDE HDD Block Mode:** The default value is Enabled.
Enabled: Enabled IDE HDD Block Mode. The HDD transfer rate is better than Disable.
Disabled: Disable IDE HDD Block Mode.
- **IDE Primary Master PIO:** The default value is Auto.
Auto: BIOS will automatically detect the Onboard Primary Master PCI IDE HDD Accessing mode.
Mode0~4: Manually set the IDE Accessing mode.
- **IDE Primary Slave PIO:** The default value is Auto.

-
-
- Auto:** BIOS will automatically detect the Onboard Primary Slave PCI IDE HDD Accessing mode.

Mode0~4: Manually set the IDE Accessing mode.
 - **IDE Secondary Master PIO:** The default value is Auto.

Auto: BIOS will automatically detect the Onboard Secondary Master PCI IDE HDD Accessing mode.

Mode0~4: Manually set the IDE Accessing mode.
 - **IDE Secondary Slave PIO:** The default value is

Auto: BIOS will automatically detect the Onboard Secondary Slave PCI IDE HDD Accessing mode.

Mode0~4: Manually set the IDE Accessing mode.
 - **Onboard Primary PCI IDE:** The default value is Enabled.

Enabled: Enable Onboard 1 st channel IDE port.

Disabled: Disable Onboard 1 st channel IDE port. When use On-card (PCI or ISA card) IDE connector.
 - **Onboard Secondary PCI IDE:** The default value is Enabled.

Enabled: Enable Onboard 2 nd channel IDE port.

Disabled: Disable Onboard 2 nd channel IDE port. When use On-card (PCI or ISA card) IDE connector.
 - **PCI Slot IDE 2nd Channel:** The default value is Enabled.

Enabled: Enable secondary IDE port and BIOS will assign IRQ15 for this port.

Disabled: Disable secondary IDE port and IRQ15 is available for other device.
 - **Onboard FDC Controller:** The default value Enabled.

Enabled: Enable the Onboard floppy drive interface controller.

Disabled: Disable the Onboard floppy drive interface controller. When use On-card ISA FDC's controller.
 - **Onboard Serial Port 1:** This field allows the user to select the serial port. The default value is COM1.

COM1: Enable Onboard Serial port 1 and address is 3F8H.

COM2: Enable Onboard Serial port 1 and address is 2F8H.

COM3: Enable Onboard Serial port 1 and address is 3E8H.

COM4: Enable Onboard Serial port 1 and address is 2E8H.

Disabled: Disable Onboard CHIP's Serial port 1.
 - **Onboard Serial port 2:** This field allows the user to select the serial port. The default value is COM2.

COM1: Enable Onboard Serial port 2 and address is 3F8H.

COM2: Enable Onboard Serial port 2 and address is 2F8H.

COM3: Enable Onboard Serial port 2 and address is 3E8H.

COM4: Enable Onboard Serial port 2 and address is 2E8H.

Disabled: Disable Onboard CHIP's Serial port 2.
 - **Onboard Parallel port:** This field allows the user to select the LPT port. The default value is 378H.
-

-
-
- 378H:** Enable Onboard LPT port and address is 378H.
 - 278H:** Enable Onboard LPT port and address is 278H.
 - 3BCH:** Enable Onboard LPT port and address is 3BCH.
 - Disabled:** Disable Onboard CHIP's LPT port.

NOTE: *Parallel Port address is 378H/3BCH that selects the routing of IRQ7 for LPT1.
Parallel Port address is 278H that selects the routing of IRQ5 LPT1.*

- **Onboard Parallel port Mode:** This field allows the user to select the parallel port mode. The default value is ECP + EPP.
 - Normal:** Standard mode. IBM PC/AT Compatible bidirectional parallel port.
 - EPP:** Enhanced Parallel Port mode.
 - ECP:** Extended Capabilities Port mode.
 - EPP+ECP:** ECP Mode & EPP Mode.
- **Power On Function:** This field allow the user to select Power On method by button, password or hot-key.
 - Button Only:** Power On by press the button only.
 - Password:** Allow Power On by enter password correct by only.
 - Hot-Key:** Allow Power On by enter special defined hot-key only.

3-9 SUPERVISOR/USER PASSWORD

This item lets you configure the system so that a password is required each time the system boots or an attempt is made to enter the Setup program (Refer to Figure 3-3 for the details). Supervisor Password allows you to change all CMOS settings but the User Password setting doesn't have this function. The way to set up the passwords for both Supervisor and User are as follow:

1. Choose either Supervisor Password or User Password in the Main Menu and press <Enter>. The following message appears:
 "Enter Password:"
2. The first time you run this option, enter your password up to only 8 characters and press <Enter>. The screen does not display the entered characters. For no password just press <Enter>.
3. After you enter the password, the following message appears prompting you to confirm the password:
 "Confirm Password:"
4. Enter exact the same password you just typed again to confirm the password and press <Enter>.
5. Move the cursor to Save & Exit Setup to save the password.
6. If you need to delete the password you entered before, choose the Supervisor Password and Press <Enter>. It will delete the password that you had before.

-
-
7. Move the cursor to Save & Exit Setup to save the option you did, otherwise the old password will still be there when you turn on your machine next time.

3-10 IDE HDD AUTO DETECTION

The "IDE HDD AUTO DETECTION" utility is a very useful tool especially when you do not know which kind of hard disk type you are using. You can use this utility to detect the correct disk type and install in the system automatically. Also you can set HARD DISK TYPE to "Auto" in the STANDARD CMOS SETUP to have same result. The BIOS will Auto-detect the hard disk size and model on display during POST.

ROM PCI/ISA BIOS (2A69KJ1C)
 STANDARD CMOS SETUP
 AWARD SOFTWARE, INC.

Date (mm:dd:yy) : Wed, Sep, 10 1997	
Time (hh:mm:ss) : 10 : 33 : 52	
<u>HARD DISKS TYPE SIZE CYLS HEAD PRECOMP LANDZ SECTOR MODE</u>	
Primary Master :	
Primary Slave :	
Secondary Master :	
Sec	
Select Secondary Slave Option (N=Skip):N	
<u>OPTIONS SIZE CYLS HEAD PRECOMP LANDZ SECTOR MODE</u>	
1 (Y) 0 0 0 0 0 0 NORMAL	
Esc : Quit ↑↓ → ← : Select Item Pu/Pd/+- : Modify	
F1 : Help (Shift)F2: Change Color	

Figure 3-11

NOTE: HDD Modes

The Award BIOS supports 3 HDD modes : NORMAL, LBA & LARGE

NORMAL mode

Generic access mode in which neither the BIOS nor the IDE controller will make any transformations during accessing.

The maximum number of cylinders, head & sectors for NORMAL mode are 1024, 16 & 63.

	no. Cylinder	(1024)
x	no. Head	(16)
x	no. Sector	(63)
x	no. per sector	(512)
	528 Megabytes	

If user set this HDD to NORMAL mode, the maximum accessible HDD size will be 528 Megabytes even though its physical size may be greater than that!

LBA (Logical Block Addressing) mode

A new HDD accessing method to overcome the 528 Megabyte bottleneck. The number of cylinders, heads & sectors shown in setup may not be the number physically contained in the HDD.

During HDD accessing, the IDE controller will transform the logical address described by sector, head & cylinder into its own physical address inside the HDD.

The maximum HDD size supported by LBA mode is 8.4 Gigabytes which is obtained by the following formula:

$$\begin{array}{r} \text{no. Cylinder (1024)} \\ \times \text{ no. Head (255)} \\ \times \text{ no. Sector (63)} \\ \hline \times \text{ bytes per sector (512)} \\ \hline \text{8.4 Gigabytes} \end{array}$$

LARGE mode

Extended HDD access mode supported by Award Software.

Some IDE HDDs contain more than 1024 cylinder without LBA support (in some cases, user do not want LBA). The Award BIOS provides another alternative to support these kinds of LARGE mode:

<u>CYLS.</u>	<u>HEAD</u>	<u>SECTOR</u>	<u>MODE</u>
1120	16	59	NORMAL
560	32	59	LARGE

BIOS tricks DOS (or other OS) that the number of cylinders is less than 1024 by dividing it by 2. At the same time, the number of heads is multiplied by 2. Reverse transformation process will be made inside INT 12h in order to access the right HDD address the right HDD address!

Maximum HDD size:

$$\begin{array}{r} \text{no. Cylinder (1024)} \\ \times \text{ no. Head (32)} \\ \times \text{ no. Sector (63)} \\ \hline \times \text{ bytes per sector (512)} \\ \hline \text{1 Gigabytes} \end{array}$$

NOTE:

To support LBA or LARGE mode of HDDs, there must be some softwares involved. All these softwares are located in the Award HDD Service Routine (INT 13h). It may be failed to access a HDD with LBA (LARGE) mode selected if you are running under a Operating System which replaces the whole INT 13h.

UNIX operating systems do not support either LBA or LARGE and must set to the Standard mode. UNIX can support drives larger than 528MB.

3-11 SAVE & EXIT SETUP

The "SAVE & EXIT SETUP" option will bring you back to boot up procedure with all the changes you just made which are recorded in the CMOS RAM.

3-12 EXIT WITHOUT SAVING

The "EXIT WITHOUT SAVING" option will bring you back to normal boot up procedure without saving any data into CMOS RAM. All of the old data in the CMOS will not be destroyed.

3-13 I/O & MEMORY MAP

MEMORY MAP

Address Range	Size	Description
00000-7FFFF	512K	Conventional memory
80000-9FBFF	127K	Extended Conventional memory
9FC00-9FFFF	1K	Extended BIOS data area if PS/2 mouse is installed
A0000-C7FFF	160K	Available for Hi DOS memory
C8000-DFFFF	96K	Available for Hi DOS memory and adapter ROMs
E0000-EEFFF	60K	Available for UMB
EF000-EFFFF	4K	Video service routine for Monochrome & CGA adapter
F0000-F7FFF	32K	BIOS CMOS setup utility
F8000-FCFFF	20K	BIOS runtime service routine (2)
FD000-FDFFF	4K	Plug and Play ESCD data area
FE000-FFFFF	8K	BIOS runtime service routine (1)

I/O MAP

000-01F	DMA controller (Master)
020-021	INTERRUPT CONTROLLER (Master)
022-023	CHIPSET control registers. I/O ports
040-05F	TIMER control registers
060-06F	KEYBOARD interface controller (8042)
070-07F	RTC ports & CMOS I/O ports
080-09F	DMA register
0A0-0BF	INTERRUPT controller (Slave)
0C0-0DF	DMA controller (Slave)
0F0-0FF	MATH COPROCESSOR
1F0-1F8	HARD DISK controller
278-27F	PARALLEL port 2
2B0-2DF	GRAPHICS adapter controller
2F8-2FF	SERIAL port 2
360-36F	NETWORK ports
378-37F	PARALLEL port 1
3B0-3BF	MONOCHROME & PARALLEL port adapter
3C0-3CF	EGA adapter
3D0-CDF	CGA adapter
3F0-3F7	FLOPPY DISK controller
3F8-3FF	SERIAL port-1

3-14 TIME & DMA CHANNELS MAP

TIME MAP: TIMER Channel 0 System timer interrupt
 TIMER Channel 1 DRAM REFRESH request
 TIMER Channel 2 SPEAKER tone generator

DMA CHANNELS: DMA Channel 0 Available
 DMA Channel 1 Onboard ECP (Option)

DMA Channel 2 FLOPPY DISK (SMC CHIP)
DMA Channel 3 Onboard ECP (Default)
DMA Channel 4 Cascade for DMA controller 1
DMA Channel 5 Available
DMA Channel 6 Available
DMA Channel 7 Available

3-15 INTERRUPT MAP

NMI: Parity check error

IRQ (H/W):

- 0 System TIMER interrupt from TIMER 0
- 1 KEYBOARD output buffer full
- 2 Cascade for IRQ 8-15
- 3 SERIAL port 2
- 4 SERIAL port 1
- 5 PARALLEL port 2
- 6 FLOPPY DISK (SMC CHIP)
- 7 PARALLEL port 1
- 8 RTC clock
- 9 Available
- 10 Available
- 11 Available
- 12 PS/2 Mouse
- 13 MATH coprocessor
- 14 Onboard HARD DISK (IDE1) channel
- 15 Onboard HARD DISK (IDE2) channel

3-16 RTC & CMOS RAM MAP

RTC & CMOS:

- 00 Seconds
- 01 Second alarm
- 02 Minutes
- 03 Minutes alarm
- 04 Hours
- 05 Hours alarm
- 06 Day of week
- 07 Day of month
- 08 Month
- 09 Year
- 0A Status register A
- 0B Status register B
- 0C Status register C
- 0D Status register D
- 0E Diagnostic status byte
- 0F Shutdown byte
- 10 FLOPPY DISK drive type byte
- 11 Reserve
- 12 HARD DISK type byte
- 13 Reserve

- 14 Equipment type
- 15 Base memory low byte
- 16 Base memory high byte
- 17 Extension memory low byte
- 18 Extension memory high byte
- 19-2d 2E-2F
- 30 Reserved for extension memory low byte
- 31 Reserved for extension memory high byte
- 32 DATE CENTURY byte
- 33 INFORMATION FLAG
- 34-3F Reserve
- 40-7F Reserved for CHIPSET SETTING DATA

3-17 BIOS REFERENCE-POST CODES

ISA PORT codes are typically output to port address 80h.

Post	Name	Description
CO	Turn Off Chipset Cache	OEM Specific-Cache controller.
1	Processor Test 1	Processor Status (1 FLAGS) Verification. Tests the following processor status flags carry, zero, sign, overflow. The BIOS will set each of these flags, verify they are set, then turn each flag off and verify it is off.
2	Processor Test 2	Read/ Write/ Verify all CPU registers except SS, SP, and BP with data pattern FF and 00.
3	Initialize Chips	Disable NMI, PIE, AIE, UEI, SOWV. Disable video, parity checking, DMA. Reset math coprocessor. Clear all page registers, CMOS shutdown byte. Initialize timer 0, 1, and 2, including set EISA timer to a known state. Initialize DMA Controllers 0 and 1. Initialize interrupt controllers 0 and 1. Initialize EISA extended registers.
4	Test Memory Refresh Toggle	RAM must be periodically refreshed in order to keep the memory from decaying. This function assures that the memory refresh function is working properly.
5	Blank video, Initialize keyboard	Keyboard controller initialization.
6	Reserved	
7	Test CMOS Interface and Battery Status	Verifies CMOS is working correctly, detects bad battery.
BE	Chipset Default Initialization	Program chipset registers with power on BIOS defaults.

C1	Memory presence test	OEM Specific-Test to size on-board memory.
C5	Early Shadow	OEM Specific-Early Shadow enable for fast boot.
C6	Cache presence test	External cache size detection.
8	Setup low memory	Early chip set initialization. Memory presence test. OEM chip set routines. Clear low 64K of memory. Test first 64K memory.
9	Early Cache Initialization	Cyrix CPU initialization. Cache initialization.
A	Setup Interrupt Vector Table	Initialization first 120 interrupt vectors with SPURIOUS_INT_HDLR and initialize INT 00h-1Fh according to INT_TBL
B	Test CMOS RAM Checksum	Test CMOS RAM Checksum, if bad, or insert key pressed, load defaults.
C	Initialize keyboard	Detect type of keyboard controller (optional) Set NUM_LOCK status.
D	Initialize Video Interface	Detect CPU clock. Read CMOS location 14h to find out type of video in use. Detect and Initialize Video Adapter.
E	Test Video Memory	Test video memory, write sign-on message to screen. Setup shadow RAM.Enable shadow according to Setup.
F	Test DMA Controller 0	BIOS checksum test. Keyboard detect and initialization.
10	Test DMA Controller 1	
11	Test DMA Page Registers	Test DMA Page Registers.
12-13	Reserved	
14	Test Timer Counter 2	Test 8254 Timer 0 Counter 2.
15	Test 8259-1 Mask Bits	Verify 8259 Channel 1 masked interrupts by alternately turning off and on the interrupt lines.
16	Test 8259-2 Mask Bits	Verify 8259 Channel 2 masked interrupts by alternately turning off and on the interrupt lines.

17	Test Stuck 8259's Interrupt Bits	Turn off interrupts then verify no interrupt mask register is on.
18	Test 8259 Interrupt Functionality	Force an interrupt and verify the interrupt occurred.
19	Test Stuck NMI Bits (Parity I/O Check)	Verify NMI can be cleared.
1A		Display CPU clock.
1B-1E	Reserved	
1F	Set EISA Mode	If EISA non-volatile memory checksum is good, execute EISA initialization. If not, execute ISA tests and clear EISA mode flag. Test EISA Configuration Memory Integrity (checksum & communication interface).
20	Enable Slot 0	Initialization slot 0 (System Board).
21-2F	Enable Slot 1-15	Initialize slot 1 through 15.
30	Size Base and Extended Memory	Size base memory from 256K to 640K and extended memory above 1MB.
31	Test Base and Extended Memory	Test base memory from 256K to 640K and extended memory above 1MB using various patterns. NOTE: This will be skipped in EISA mode and can be "skipped" with ESC key in ISA mode.
32	Test EISA Extended Memory	If EISA Mode flag is set then test EISA memory found in slots initialization. NOTE: This will be skipped in ISA mode and can be "skipped" with ESC key in EISA mode.
33-3B	Reserved	
3C	Setup Enabled	
3D	Initialize & install Mouse	Detect if mouse is present, initialize mouse, install interrupt vectors.
3E	Setup Cache Controller	Initialize cache controller.
3F	Reserved	
BF	Chipset Initialization	Program chipset registers with Setup values
40		Display virus protest disable or enable.
41	Initialize Floppy Drive & Controller	Initialize floppy disk drive controller and drives.
42	Initialize Hard Drive & controller	Initialize hard drive controller and any drives.

43	Detect & Initialize Serial/Parallel Ports	Initialize any serial and parallel ports (also game port).
44	Reserved	
45	Detect & Initialize Math Coprocessor	Initialize math coprocessor.
46	Reserved	
47	Reserved	
48-4D	Reserved	
4E	Manufacturing POST Loop or Display Messages	Reboot if Manufacturing POST Loop pin is set. Otherwise display any messages (i.e., any non-fatal errors that were detected during POST) and enter Setup.
4F	Security Check	Ask password security (optional).
50	Write CMOS	Write all CMOS values back to RAM and clear screen.
51	Pre-boot Enable	Enable parity checker. Enable NMI, Enable cache before boot.
52	Initialize Option ROMs	Initialize any option ROMs present from C8000h to EFFFFh. NOTE: When FSCAN option is enabled, will initialize from C8000h to F7FFFh.
53	Initialize Time Value	Initialize time value in 40h:BIOS area.
60	Setup Virus Protect	Setup virus protect according to Setup.
61	Set Boot Speed	Set system speed for boot.
62	Setup Num Lock	Setup Num Lock status according to Setup.
63	Boot Attempt	Set low stack. Boot via INT 19h.
B0	Spurious	If interrupt occurs in protected mode.
B1	Unclaimed NMI	If unmasked NMI occurs, display. Press F1 to disable NMI, F2 reboot.
E1-EF	Setup Pages	E1-Page 1, E2-Page 2, etc.
FF	Boot	

3.18 PC HEALTH MONITOR-II SOFTWARE FOR J-7ZXAS/L, J-7ZXAN/L

General Description

The PC HEALTH MONITOR-II Software, an application software based on Microsoft Windows 95, is used to control the PC HEALTH MONITOR CHIP. It can monitor the temperatures, power supply voltages and fan speeds via PC HEALTH MONITOR CHIP and show the information on screen periodically. User can use it to specify temperature, voltage and fan speed configurations used by monitor chip. By the way, the alarm warning events and polling interval could also be set by this software. If there is an abnormal event happens, it will pop up a window on screen to inform the user the abnormal situation.

Using the Software

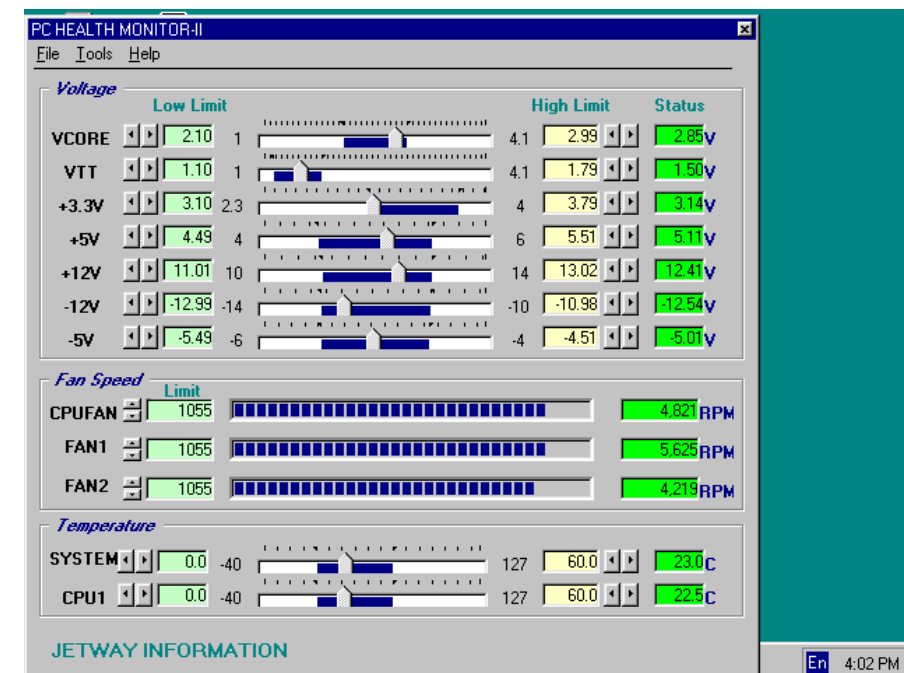

General Function

1. Power Supply Voltage :

- VCORE Low Limit/High Limit
- VTT Low Limit/High Limit
- 3.3V Low Limit/High Limit
- +5V Low Limit/High Limit
- 5V Low Limit/High Limit
- +12V Low Limit/High Limit
- 12V Low Limit/High Limit

These values are used to specify the threshold values of detecting the abnormal condition of VTT, 3.3V, +5V, -5V, +12V, -12V.

2. FAN Speed

CPUFAN/ FAN1/ FAN2

If the fan RPM is lower than this value and “CPUFAN/FAN1/FAN2” is enabled in Monitoring Config. the PC Speaker will alarm and the monitor software will pop up a window to inform user.

3. Temperature

System/ CPU1 Low Limit/ High Limit

These values are used to specify the Temp-Over register/ Temp-under register of PC HEALTH MONITOR CHIP, If the temperature of the external thermistor is higher than this value and “System/CPU” is enabled in Monitoring Config. the monitor software will pop up a window to inform user.

Monitoring Config.

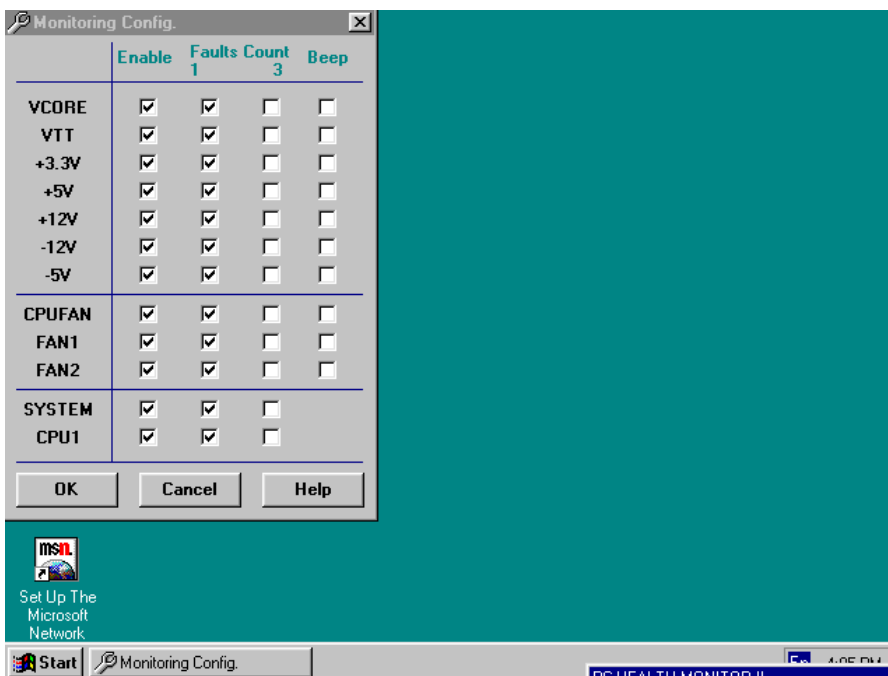

Enabled or Disabled: User can decide which item should be monitored or not by choosing the item in the configuration page.

Faults Count (1 or 3): User can decide the system to pop up the warning message when there is 1 fault detected or there are 3 consecutive faults detected.

Beep: In addition to pop up warning message user can choose to activate Beep tone if there is error detected. Beep tone will until the error is treated.

New Function for J-7ZXAS ,J-7ZXAN,J-7ZXAS/L,J-7ZXAN/L Keyboard Password/ Hot-key Power On

The J-7ZXAS,J-7ZXAS/L has two ways to Power On System, one is use power button the other is use keyboard. This document description how to use keyboard to control Power On function.

Function 1:

Use Power Button Power On (Default setting)

Please setting both JP3 1-2 closed and J2 1-2 closed (see Figure A). In this condition the system will ignore the BIOS SETUP "Power On Function" under "INTEGRATED PERIPHERALS", system only can power on by Power Button.

Function 2:

Use Keyboard Password/ Hot-key Power On

You have to setting both JP3 2-3 closed and J2 2-3 closed (see Figure A). In this setting you can change BIOS SETUP to "Password" or "Hot-key" in "Power On Function" item under "INTEGRATED PERIPHERAL SETUP".

A: When choose "Password", then user can setting your password in "KB Power On Password" item. After save CMOS SETUP, the next time want to power on, you have to key in your password to power on, otherwise the system will not power on.

B: When choose "Hot-key", then user can choose by key in Hot-key or use Power button to power on system.

Question and Answer:

Q1: When you forget password or the system can not power on by power button?

Answer: There has two solution of this problem:

- sol 1:**
- 1st : Turn off the Power Supply by ON/OFF switch.
 - 2nd: Clear CMOS by JP1 3-4 closed about 10 sec and remove the Jumper to 2-3 closed for Normal use.
 - 3rd: Switch ON the Power Supply by ON/OFF switch.
 - 4th: Follow Function 1 or Function 2 to setting to setting your Power On Function.

sol 2: Change the Jumper setting both J50 1-2 closed and JP2 1-2 closed (Default setting) Let you can use power button to Power On your system, and you can setting BIOS again. In this condition you can choose use Function 1 (use Power Button Power On) or use Function 2 (Use Keyboard Password/ Hot-key Power On) to setting your system.

Q2: When use Function 2 use keyboard Password/Hot-key Power On, there has keyboard error problem?

Answer: This is the Power Supply 5V stand by current too small can not drive the keyboard.

sol: If your Power Supply 5V Stand By current is not enough to driver keyboard. You can not use keyboard password/Hot-key power on Function, Please change the Jumper setting JP3 1-2 closed and J2 1-2 closed only can use Function 1: Power Button Power On.

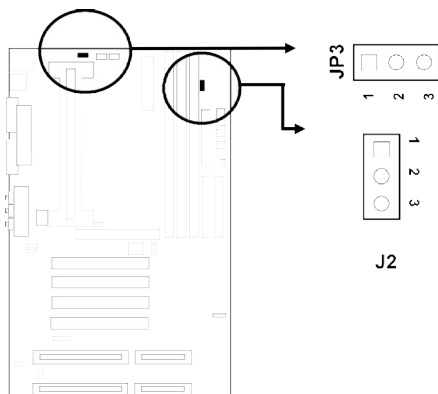

Figure A

Chapter 4

Sound Card Driver Quick Installation:(Only for J-7ZXAS)

Windows 95 OSR2 Driver Installation

- step1: Before install sound driver please double-click "My Computer" icon, "Control Panel" icon, "System" icon, "Device Manager" icon
- step2: check "Other device" item, if there have "PCI Multimedia Audio Device", please remove it first.
- step3: In "Control Panel" icon choose "Add new hardware" to add hardware in Win95.
- step4: Choose "No" don't let Windows to search for new hardware, and select hardware type "Sound, Video and game controllers".
- step5: Follow the step choose "Have Disk", "Browse", to change the Folders to X:\ESSOLO-1\95-98DRV.
- step6: Select "OK" to finish install procedure.
- step7: Restart system.

Windows NT4.0 Installation

- step1: Double click "My Computer", "Control Panel", "Multimedia"
- step2: Choose "Review" item and "Add" item, double – click "Unlisted or Update Driver" item.
- step3: Double- click "Browse" to change the Folders to X:\ESSOLO-1\WNT4.0
- step4: Choose "OK" to finish install procedure.
- step5: Restart System.

Audio Rack Quick Installation

In Windows95 OSR2, Windows98, WindowsNT4.0 excute "setup" in X:\ESSOLO-1\ESSRACK\SETUP

Windows98 Driver Installation

- step1: Before install sound card driver please double-click "My Computer" icon, "Control Panel" icon, "System" icon, and Choose "Device Manager" item.
- step2: Check "Other Device" item, if there have " PCI Multimedia Audio Device " please remove it first.
- step3: In "Control Panel" icon, choose "Add New Hardware" icon, and choose "Next", the windows will show " PCI Multimedia Audio Device", click "Next" and choose "Display a list of all Drivers", select "Sound, Video and game controllers" item.
- step4: Choose "Have Disk", "Browse" and change the Folders to "X:\ESSOLO-1\95-98DRV.
- step5: Select "OK" to Finish install.
- step6: When Windows98 ask "Are all your drivers installed now" Please select "Yes" and click "Next", "Finish" .
- step7: Restart System.

JOYSTICK Installation

In Windows95 OSR2, Windows98, double-click "My Computer", "Game

controllers",select "Properties" item, "Calibrate" to adjust your joystick before using it.