

PERSONAL COMPUTER PERSONAL COMPUTER PERSONAL COMPUTER PERSONAL COMPUTER PERSONAL COMPUTER PERSONAL COMPUTER PERSONAL COMPUTER PERSONAL COMPUTER

# J446 486DX MAIN BOARD

## WITH ENHANCED IDE, I/O

PERSONAL COMPUTER (SiS chipset)

### J446 使用手冊



PERSONAL COMPUTER

PERSONAL COMPUTER

PERSONAL COMPUTER

PERSONAL COMPUTER

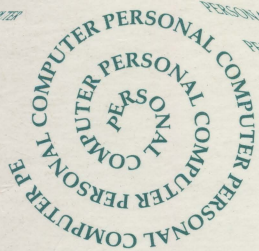

PERSONAL COMPUTER  
PERSONAL COMPUTER  
PERSONAL COMPUTER  
PERSONAL COMPUTER  
PERSONAL COMPUTER

## PERSONAL COMPUTER MAIN BOARD

PERSONAL COMPUTER PERSONAL COMPUTER PERSONAL COMPUTER PERSONAL C

PERSONAL COMPUTER  
PERSONAL COMPUTER  
PERSONAL COMPUTER  
PERSONAL COMPUTER  
PERSONAL COMPUTER

## PERSONAL COMPUTER MAIN BOARD



---

---

# Contents

## Chapter 1

<b>Introduction .....</b>	<b>1</b>
<b>1-1 Features .....</b>	<b>2</b>
<b>1-2 Unpacking .....</b>	<b>3</b>
<b>1-3 Electrostatic Discharge Precautions .....</b>	<b>4</b>
<b>1-4 Mainboard Layout.....</b>	<b>5</b>

## Chapter 2

<b>Setting Up the Main Board.....</b>	<b>7</b>
<b>2-1 Quick Setup.....</b>	<b>8</b>
<b>2-2 Installing a CPU Upgrade.....</b>	<b>9</b>
Installing a CPU: Overview.....	10
Installing a CPU in the ZIF Socket .....	11
<b>2-3 Installing Memory.....</b>	<b>11</b>
Installing DRAM .....	12
Installing SRAM Cache Memory.....	13
<b>2-4 Making Connections.....</b>	<b>14</b>
CN2: Secondary IDE Connector .....	14
CN3: Primary IDE Connector .....	14
JP1: External Battery Connector .....	14
JP4: The Keyboard Connector.....	14
JP5: The Power Supply Connector.....	14
JP27: Speaker Connector .....	15
JP33: IDE Active LED Connector .....	15
JP35: Standby Mode Switch Connector .....	15
JP36: Power-Saving Output Signal Connector.....	15
JP37: Turbo LED Connector .....	16

---



---

JP38: Reset Connector .....	16
JP40: Keylock & Power LED Connector .....	16
LED1: Power-Saving LED Connector .....	16
<b>2-5 Replacing the Lithium Battery .....</b>	<b>16</b>

## **Chapter 3**

<b>Setting Jumper Switches .....</b>	<b>17</b>
<b>JP2 &amp; JP3: Clear BIOS Setup Data .....</b>	<b>18</b>
<b>JP6: Monochrome/Color Monitor .....</b>	<b>18</b>
<b>JP7 &amp; JP8: Cache Memory Configuration .....</b>	<b>18</b>
<b>JP11 &amp; JP12: CPU Clock Speed .....</b>	<b>20</b>
<b>JP13: Factory Preset .....</b>	<b>20</b>
<b>JP18: DREQ Signal Select for ECP/EPP Function .....</b>	<b>21</b>
<b>JP19: BIOS Type .....</b>	<b>21</b>
<b>JP22: DACK Signal Select for ECP/EPP Function .....</b>	<b>22</b>
<b>JP31, JP32, &amp; JP34: CPU Voltage .....</b>	<b>22</b>
<b>JP9-JP10, JP14-JP17, JP20-JP21, JP23-JP26, &amp; JP28-JP30:</b>	
<b>CPU Type .....</b>	<b>23</b>
Intel 486 SX .....	23
Intel/AMD DX/DX2/DX4 .....	24
Intel SL DX/DX2/DX4 .....	25
Intel SL SX .....	25
Intel P24D .....	26
Intel P24T .....	27
Cyrix M9 .....	28
Cyrix M7 .....	29
UMC 486 .....	29
AMD Enhanced SX Write-Back .....	30
AMD Enhanced DX/DX2/DX4 Write-Back .....	31

---

---

<b>JP39: Turbo Switch .....</b>	<b>32</b>
---------------------------------	-----------

## **Chapter 4**

<b>Award BIOS Setup .....</b>	<b>33</b>
-------------------------------	-----------

<b>4-1 Entering the CMOS Setup Program.....</b>	<b>33</b>
-------------------------------------------------	-----------

Quick Setup.....	35
------------------	----

<b>4-2 Menu Options .....</b>	<b>36</b>
-------------------------------	-----------

Standard CMOS Setup .....	37
---------------------------	----

BIOS Features Setup .....	39
---------------------------	----

Chipset Features Setup.....	42
-----------------------------	----

Power Management Setup.....	43
-----------------------------	----

PCI Configuration Setup.....	45
------------------------------	----

Load BIOS Defaults .....	46
--------------------------	----

Load Setup Defaults .....	47
---------------------------	----

Password Setting.....	47
-----------------------	----

IDE HDD Auto Detection .....	48
------------------------------	----

<b>4-3 The Flash Memory Utility.....</b>	<b>50</b>
------------------------------------------	-----------

<b>Appendix: Connector Pin Signals.....</b>	<b>51</b>
---------------------------------------------	-----------

CN1: Printer Connector .....	51
------------------------------	----

CN2: Secondary IDE and CN3: Primary IDE .....	52
-----------------------------------------------	----

CN4: Floppy Disk Drive Connector .....	53
----------------------------------------	----

CN5: COMA Port and CN6: COMB Port .....	53
-----------------------------------------	----

JP4: The Keyboard Connector.....	54
----------------------------------	----

JP5: The Power Supply Connector.....	54
--------------------------------------	----

JP27: Speaker Connector.....	54
------------------------------	----

JP33: IDE Active LED .....	55
----------------------------	----

JP37: Turbo LED Connector .....	55
---------------------------------	----

JP40: Keylock & Power LED Connector .....	55
-------------------------------------------	----

LED1: Power-Saving LED Connector .....	55
----------------------------------------	----

<b>How to installing the M/B in the case.....</b>	<b>56</b>
---------------------------------------------------	-----------

<b>Jumper Switches and Functions List.....</b>	<b>57</b>
------------------------------------------------	-----------



---

---

# Chapter 1

## Introduction

Your 80486 PCI main board is a full-featured IBM PC/AT™-compatible board offering a unique modular architecture that lets you upgrade the system by simply replacing the CPU. The board supports the PCI local bus and the following high-performance CPUs:

- Intel/AMD 486DX/DX2/DX4
- Intel 486SX
- Intel SL SX and Intel SL DX/DX2/DX4
- Intel P24T and P24D
- Cyrix 486 M9 and M7
- UMC 486
- AMD Enhanced DX2/DX4 Writeback
- AMD Enhanced SX Writeback

The main board is fully compatible with the thousands of software applications developed for IBM PC/AT™-compatible computers. The control logic provides high-speed performance for the most advanced multi-user, multitasking applications available today.

The board's high-performance 32- or 64-bit Peripheral Component Interconnect (PCI) local bus lets you add highly integrated peripheral controller components, peripheral add-in boards, and processor/memory systems. The Industry Standard Architecture (ISA) bus slots allow you to choose from thousands of 8- and 16-bit industry-standard add-on boards. A floppy disk drive controller, IDE hard disk drive controller, serial ports (16550), and parallel port (with EPP and ECP modes) are included so that you can easily connect peripheral devices without using expansion slots. In addition, an IDE hard disk drive controller is included so that you can connect up to four IDE hard disk drives.

---

---

The board supports up to 128MB of on-board DRAM memory. Best of all, it automatically detects installed memory modules, so *it is not necessary to configure memory with jumper switches*. It also offers optional SRAM cache memory (128KB, 256KB, or 512KB) to reduce the number of wait states caused by low-speed I/O devices.

## 1-1 Features

- High-speed upgradeable CPU
- Selectable CPU voltage: 3.3V, 3.45V, 4.0V, and 5.0V
- On-board clock generator lets you change CPU speed by jumper switch (you don't have to change the oscillator)
- ZIF (Zero-Insertion Force) CPU socket
- Three master PCI local bus slots (rev. 2.0)
- Three 16-bit input/output (I/O) expansion slots
- Auto-detection of installed DRAM memory: no configuration is necessary
- Optional 128KB, 256KB, or 512KB SRAM cache memory
- On-board Intelligent Drive Electronics (IDE) hard disk drive controller: supports Mode 3 and Mode 4 hard disk drives
- On-board peripheral ports:
  - Two on-board serial ports (16550)
  - Parallel port with bi-directional lines: supports Enhanced Parallel Port (EPP) and Extended Capabilities Port (ECP)
- On-board floppy disk drive controller
- Licensed Award BIOS
- Selectable BIOS type: EPROM, 5V flash memory, or 12V flash memory
- Lithium coin battery



- 
- 
- Shadow RAM for ROM BIOS and video ROM to improve system performance
  - Hardware "green" function
  - CPU stop clock mode for Intel/Cyrix CPUs

## 1-2 Unpacking

The main board comes securely packaged in a sturdy cardboard shipping carton. In addition to this *User's Guide*, the shipping carton contains:

- The main board
- Cables: IDE, FDD, serial, and parallel port
- IDE Drivers distribution floppy disk: includes drivers for Windows 3.1, Windows NT 3.x, OS/2 2.x, and Novell Netware.

If any of these items is missing or damaged, contact the dealer from whom you purchased the main board. Save the shipping materials and carton in case you want to ship or store the board in the future.

***NOTE:*** *Leave the main board in its original packing until you are ready to install it.*

Inside the carton, the main board is sandwiched between sheets of sponge and packed in an anti-static bag. After you unpack the board, inspect it for damage. Press down all the integrated circuits to make sure they are properly seated in their sockets. Do not apply power to the board if it appears to have been damaged.

---

---

## 1-3 Electrostatic Discharge Precautions

Make sure you ground yourself before handling the mainboard or other system components. Electrostatic discharge can easily damage the components. Note that you must take special precaution when handling the mainboard in dry or air-conditioned environments.

Abide by the precautions below to protect your equipment from electrostatic discharge:

- Do not remove the anti-static packaging until you are ready to install the mainboard and other system components.
- Ground yourself before removing any system component from its protective anti-static packaging.
- You can ground yourself by grasping the expansion slot covers or other unpainted portions of the computer chassis.
- Frequently ground yourself while working, or use a grounding strap.
- Handle the mainboard by the edges and avoid touching its components.

# 1-4 Mainboard Layout

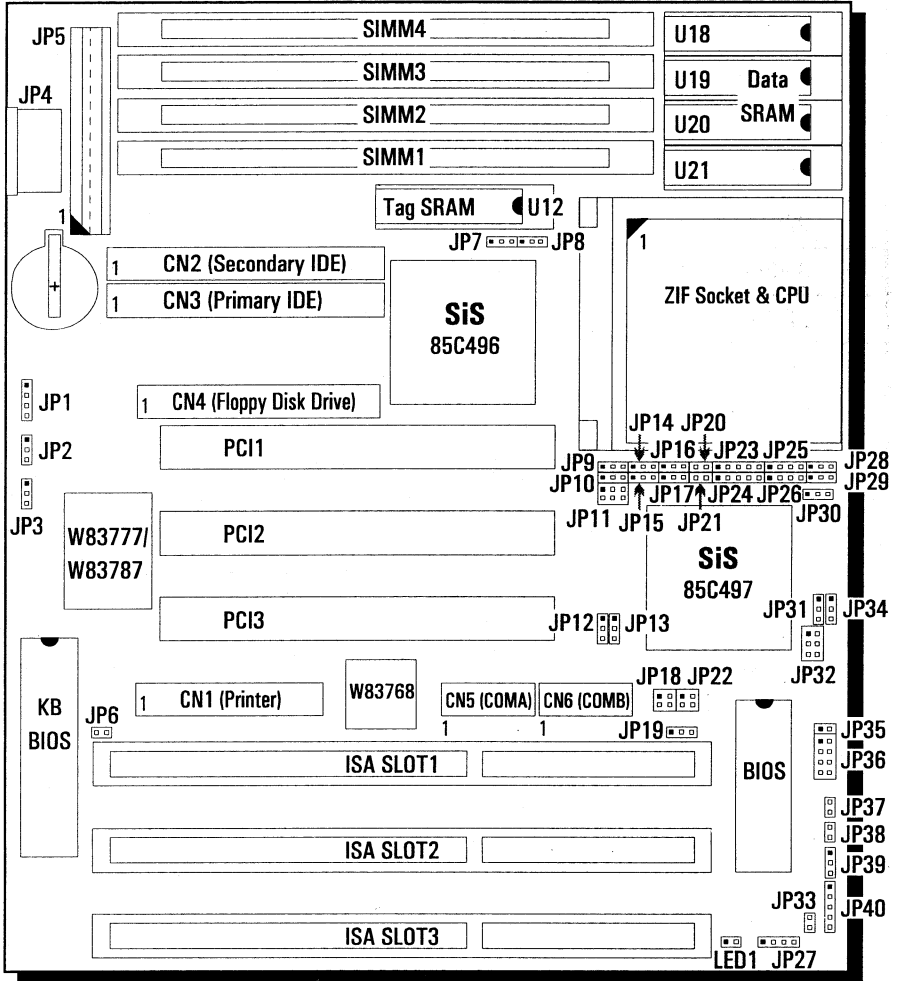

Figure 1. The main board layout

---

---

The jumper switches and their functions are listed in the table below.

<b>Jumper</b>	<b>Function</b>
JP2 & JP3	Clear BIOS Setup Data
JP6	Monochrome/Color Selection
JP7 & JP8	Cache Size Selection
JP9 & JP10	CPU Type Selection
JP14-JP17	
JP20-JP21	
JP23-JP26	
JP28-JP30	
JP11 & JP12	Clock Speed Selection
JP13	[Factory Preset: Testing Purposes Only]
JP18	DREQ Signal Select for ECP/EPP Function
JP19	BIOS Type Selection
JP22	DACK Signal Select for ECP/EPP Function
JP31, JP32, & JP34	CPU Voltage Selection

---

---

## Chapter 2

# Setting Up the Main Board

This chapter describes getting your main board ready for operation. It includes instructions for:

- Installing a CPU upgrade
- Installing DRAM memory and SRAM cache memory

It also provides descriptions of making board connections and replacing the lithium battery.

---

---

## 2-1 Quick Setup

The flowchart below is a summary of the procedures that you will follow to install and set up the main board in your computer system.

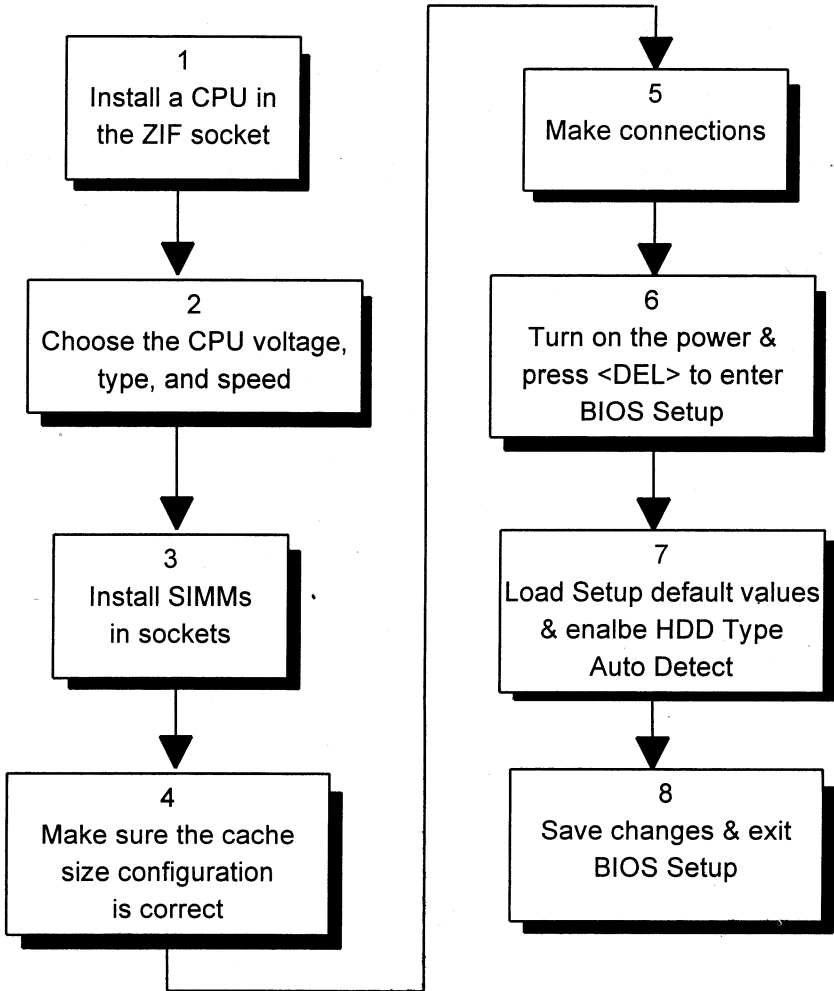

---

---

## 2-2 Installing a CPU Upgrade

You can upgrade your main board by simply replacing the CPU and changing the settings of jumper switches on the board. The board supports the following high-performance CPUs:

- Intel/AMD 486DX/DX2/DX4
- Intel 486SX
- Intel SL SX and Intel SL DX/DX2/DX4
- Intel P24T and P24D
- Cyrix 486 M9 and M7
- UMC 486
- AMD Enhanced DX2/DX4 Writeback
- AMD Enhanced X Writeback

---

---

## *Installing A CPU: Overview*

---

The flowchart below illustrates the procedures that you will follow to install a CPU.

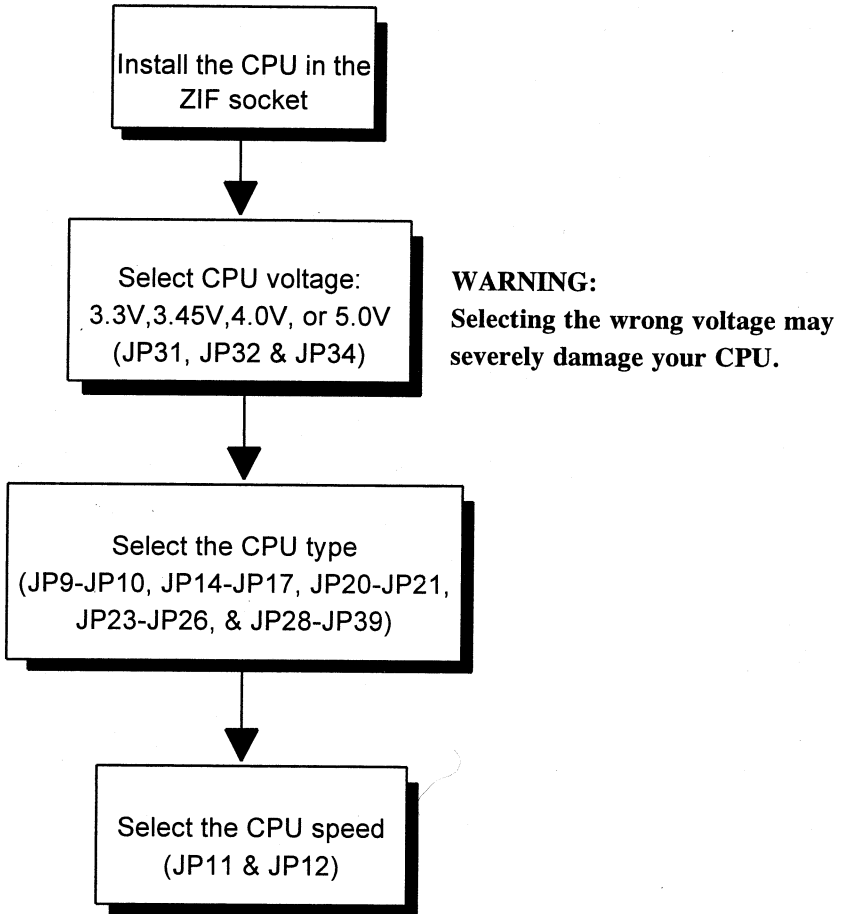



---

---

## ***Installing A CPU in the ZIF Socket***

---

If there is already a CPU in the ZIF socket, remove it by pulling the ZIF socket lever out to the side and then raising it. Then lift out the CPU.

**CAUTION:** *Static electricity can cause serious damage to integrated circuit chips. Avoid building up a static electricity charge in your body by touching a grounded object before you touch the chips and at frequent intervals as you handle the chips.*

 **Install a CPU in the ZIF socket as follows:**

1. Turn off the system.
2. Find the ZIF socket. Refer to Figure 1, "The main board layout," for the location of ZIF socket on the board.
3. Raise the ZIF socket lever by pulling it out to the side and then pulling up.
4. Align the pin 1 corners of the CPU and the ZIF socket and place the CPU in the socket.
5. Press the ZIF socket lever down. The socket plate will slide forward. When the CPU is installed fully, the ZIF socket lever should snap into place.

## **2-3 Installing Memory**

The main board uses two types of Random-Access memory:

- Dynamic Random-Access Memory (DRAM) packaged in Single In-Line Memory Modules (SIMMs). These modules occupy sockets on the main board and provide a total of from 1MB to 128MB of on-board system memory.
- Static Random-Access Memory (SRAM). These optional memory chips occupy sockets on the main board and provide 128KB, 256KB, or 512KB of cache memory.

---

---

## ***Installing DRAM***

---

The main board provides a variety of possible DRAM configurations. The board has four SIMM sockets; each socket can accept a 1MB, 5MB, 8MB, 16MB or 32MB SIMM. Depending on the desired memory capacity and the SIMM size, you can install one, two, or four SIMMs on the board.

The board accepts combinations of SIMMs with different sizes; furthermore, you can install SIMM in any socket. The main board automatically detects installed SIMMs; no configuration via jumper switches or BIOS setup is necessary.

☞ **Install a SIMM into an on-board socket as follows:**

1. Turn off the system.
2. Align the SIMM so that the pin 1 marking corresponds to the SIMM socket pin 1 marking. The SIMM can fit in the socket in one way only; you cannot insert the SIMM incorrectly.
3. Holding the SIMM at about a 15-degree angle to the board, insert the SIMM's "golden finger" connectors into the socket.
4. Firmly press down on both sides of the SIMM so that it snaps into the locking tabs at either end of the SIMM socket. You will hear a click when the SIMM snaps into place. A retaining peg at each end of the socket fits into a hole on the SIMM.

To remove a SIMM from a socket, carefully pry the tab away from each end of the SIMM. The SIMM should fall back to an angle; you can then pull the SIMM from the socket.

---

---

## ***Installing SRAM Cache Memory***

---

The main board has sockets for 128KB, 256KB, or 512KB of SRAM cache memory.

***CAUTION:*** *Static electricity can cause serious damage to integrated circuit chips. Avoid building up a static electricity charge in your body by touching a grounded object before you touch the chips and at frequent intervals as you handle the chips.*

☞ **Install SRAM cache memory chips in on-board sockets as follows:**

1. Turn off the system.
2. Find the on-board sockets in which you will install the Sram chips and determine which type of chips to install.

Refer to Figure1, "The main board layout," for the location of SRAM sockets on the board. The description of jumper switches JP7-JP8 later in this chapter lists the type of chips to install for each memory configuration.

3. Align the chip so that the pin 1 notch on the chip corresponds to the notch on the appropriate board socket.

***NOTE:*** *The 32Kx8 SRAM chips have fewer pins than the board sockets. When installing these chips, make sure that the four pins at the pin 1 end of the socket are exposed.*

4. Carefully but firmly press the chip into the socket, applying even pressure to both ends of the chip.
5. Repeat steps 3 and 4 for each SRAM chip.
6. Set jumpers JP7-JP8 to choose 128KB, 256KB, or 512KB of installed SRAM cache memory.

---

---

## 2-4 Making Connections

This section describes some of the connectors on the main board. See Figure 1 for the location of the connectors on the board. Refer to the appendix for a listing of the connectors' pin signals.

**CAUTION:** *Before making connections on the board, make sure that the power to the system is turned off.*

### ***CN2: Secondary IDE Connector***

---

Attach the cable for the primary IDE hard disk drive to this connector. Make sure that the red stripe on the cable corresponds to pin 1 of the connector.

### ***CN3: Primary IDE Connector***

---

Attach the cable for the secondary IDE hard disk drive to this connector. Make sure that the red stripe on the cable corresponds to pin 1 of the connector.

### ***JP1: External Battery Connector***

---

Attach an external battery to this connector. Using an external battery helps conserve the on-board battery.

### ***JP4: The Keyboard Connector***

---

Attach a keyboard to this five-pin female DIN keyboard connector.

### ***JP5: The Power Supply Connector***

---

The power supply connector consists of two six-pin male components. Plug the dual connectors from the power supply to this connector.

---

---

## ***JP27: Speaker Connector***

---

Attach an external system speaker to this connector.

## ***JP33: IDE Active LED Connector***

---

This connector is usually attached to the LED indicator on the front of an IDE hard disk drive. The IDE LED lights when the disk drive is active.

## ***JP35: Standby Mode Switch Connector***

---

This connector is usually connected by a lead to a push button on the front of the system case. Press the button to enter the power-saving standby mode.

## ***JP36: Power-Saving Output Signal Connector***

---

This connector specifies that, for the selected power-saving mode, the voltage level will go from high to low when the system enters the selected mode. When the system wakes up, the voltage level goes from low to high.

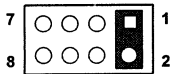
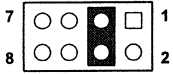
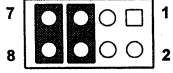
<b>Signal</b>	<b>JP36</b>	<b>Voltage Level</b>
Enter Doze Mode		High --> Low
Enter Suspend Mode		High --> Low
Enter Standby Mode		High --> low

---

---

### ***JP37: Turbo LED Connector***

---

This connector is usually connected by a lead to a Turbo LED indicator on the front of the system case. The indicator lights during high-speed operation.

### ***JP38: Reset Connector***

---

This connector is usually connected by a lead to a system reset button on the front of the system case. Press this button to restart the computer without turning the power off.

### ***JP40: Keylock & Power LED Connector***

---

These connectors are usually connected by leads to a keyboard lock and power LED indicator on the front of the system case. A key provided with the case lets you electronically disconnect the keyboard from the main board. The power LED lights when the system is turned on.

### ***LED1: Power-Saving LED Connector***

---

This connector is usually connected by a lead to an LED on the front of the system case. When the system enters power-saving mode, the LED will light.

## **2-5 Replacing the Lithium Battery**

The main board's Lithium 2032 "coin" battery provides long-lasting, leakproof power for CMOS memory. Unlike other types of batteries, the Lithium battery will not release chemicals that may damage the board. The Lithium battery is not rechargeable, but replacements are readily available at convenience stores, supermarkets, and camera shops. In addition, replacements are easily installed.

---

---

## Chapter 3

# Setting Jumper Switches

You can configure the operating characteristics of the main board by setting jumper switches on the board. This chapter presents a detailed description of the jumper switches. Refer to Figure 1 in Chapter 1 for the positions of the jumpers on the board.

A jumper switch is closed (sometimes referred to as 'shorted') with the plastic cap inserted over two pins of the jumper. A jumper is open with the plastic cap inserted over one or no pin(s) of the jumper.

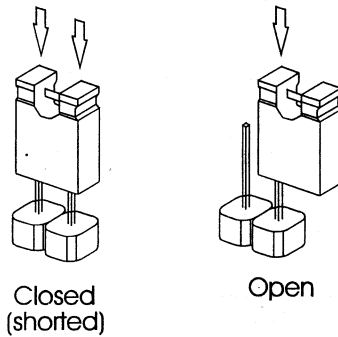





**NOTE:** *When a jumper is open, keep the plastic cap inserted over one pin of the jumper so that you don't lose it.*

- **JP2 & JP3: Clear BIOS Setup Data**  
(BLACK color selector)



These jumpers let you clear the BIOS setup data stored in CMOS memory.

*NOTE: We recommend that only experienced technicians attempt to use these jumpers to clear BIOS setup data.*

BIOS Setup Data	JP3	JP2
Maintain BIOS setup data in CMOS memory		
Clear BIOS setup data		

- **JP6: Monochrome/Color Monitor**  
(BLACK color selector)

This jumper lets you choose between a color or monochrome monitor. The default setting is Color (closed).

Monitor	JP6
Color monitor	
Monochrome monitor	

- **JP7 & JP8: Cache Memory Configuration**  
(BLACK color selector)

Use these jumpers to configure SRAM cache memory. The main board has sockets for 128KB, 256KB, or 512KB of SRAM cache memory (for a description of installing SRAM chips, see "Installing Memory" in the previous chapter). The figure below shows the installed SRAM chips and cache size configuration settings.



---

---

## 128KB Cache

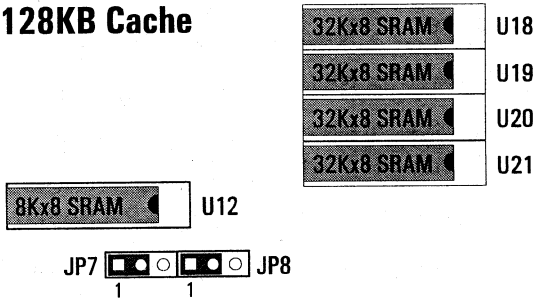

---

## 256KB Cache

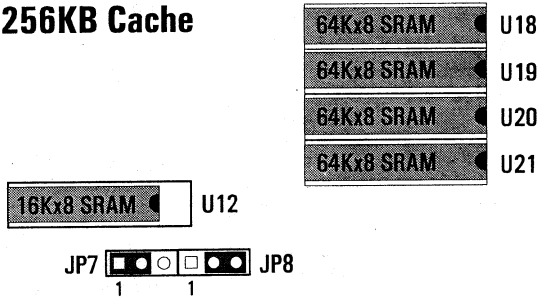

---

## 512KB Cache

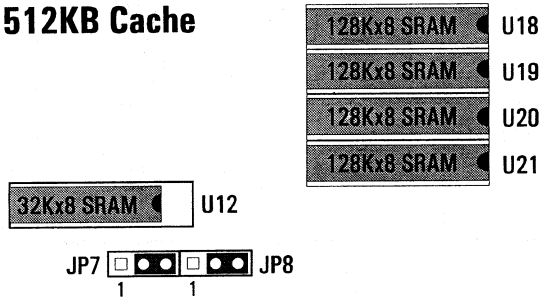









- ## JP11 & JP12: CPU Clock Speed

(WHITE color selector)

Use JP11 and JP12 to select the external clock speed of the CPU. Calculate the clock speed according to the following formula:

**Ext. Clock Speed x CPU Clock Multiplier = CPU Speed**

Example: If you have an Intel 486 DX2-66 CPU and the CPU clock multiplier is set to 2, set the external clock speed to 33Mhz.

Clock Speed	JP12	JP11	CPU Type
25MHz			SX-25, DX-25, DX2-50
33MHz			SX-33, DX-33, DX2-66, DX4-100 <del>DX4-133</del>
40MHz			SX-40, DX-40, DX2-80, DX4-120
50MHz			DX-50

**NOTE:** Depending on the installed CPU, you will use either JP16 or JP30 to set the CPU clock multiplier (see the CPU jumper settings later in this chapter).

- **JP13: Factory Preset (BLACK color selector)**

This jumper is used for testing purposes only. Its setting is factory preset.

- **JP18: DREQ Signal Select for ECP/EPP Function: (GREEN color selector)**

Use this jumper to select a DREQ signal for the ECP/EPP function.

Signal	JP18
DREQ1 (default)	
DREQ3	



- **JP19: BIOS Type (BLACK color selector)**

Use this jumper to select the BIOS type: EPROM (the default), 5V flash memory, or 12V flash memory.

BIOS Type	JP19
EPROM (default)	
12V Flash Memory	
5V Flash Memory	









- JP22: DACK Signal Select for ECP/EPP Function**  
**(GREEN color selector)**

Use this jumper to select a DACK signal for the ECP/EPP function.

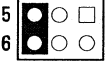
Signal	JP22
DACK1 (default)	
DACK3	

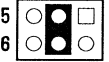
- JP31, JP32, & JP34: CPU Voltage**  
**(YELLOW color selector)**

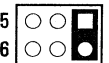
Use JP31, JP32, and JP34 to select the CPU voltage.

Voltage	JP31	JP34	JP32
3.3V			
3.45V			
4.0V			
5V			[Any setting]

**WARNING!** *Selecting the wrong voltage may severely damage your CPU. For voltage information, refer to the documentation provided with the CPU.*

---

- **JP9-JP10, JP14-JP17, JP20-JP21, JP23-JP26, & JP28-JP30: CPU Type (BLUE color selector)**

The main board supports a wide variety of high-performance CPUs:

- Intel 486SX
- Intel/AMD 486DX/DX2/DX4
- Intel SL SX and Intel SL DX/DX2/DX4
- Intel P24T and P42D
- Cyrix 486 M9 and 486 M7
- UMC 486
- AMD Enhanced DX2/DX4 Writeback
- AMD Enhanced SX Writeback

The settings for each supported CPU type are shown below.

**NOTE:** *To use a CPU not listed in this manual, please contact your dealer to determine the correct CPU settings.*

## Intel 486 SX

---

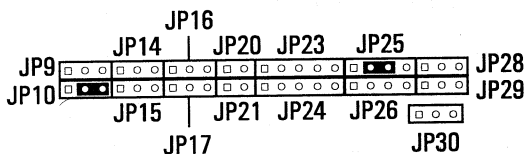
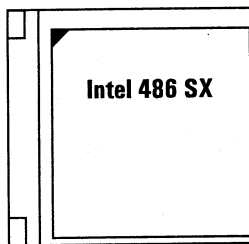

## Intel/AMD DX/DX2/DX4

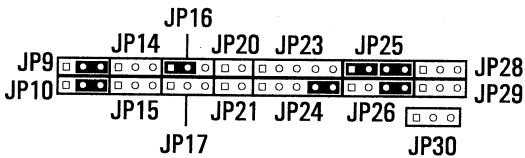
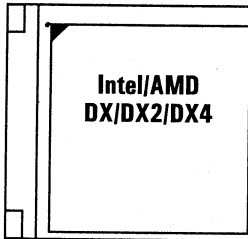

For the Intel 486 DX4, you can use JP30 to choose the clock multiplier: 2X, 2.5, or 3X (the default) clock.

Intel 486 DX4 CPU: Clock Multiplier	JP30
2X Clock	1 <input type="checkbox"/> <input checked="" type="checkbox"/> <input checked="" type="checkbox"/>
2.5X Clock	1 <input checked="" type="checkbox"/> <input checked="" type="checkbox"/> <input type="checkbox"/>
3X Clock	1 <input type="checkbox"/> <input type="checkbox"/> <input type="checkbox"/>

For the AMD 486 DX2/DX4, you can use JP16 to choose the clock multiplier:

AMD 486 DX2/DX4 CPU: Clock Multiplier	JP16
2X Clock (486 DX2)	1 <input type="checkbox"/> <input checked="" type="checkbox"/> <input checked="" type="checkbox"/>
3X Clock (486 DX4)	1 <input checked="" type="checkbox"/> <input checked="" type="checkbox"/> <input type="checkbox"/>

---

## Intel SL DX/DX2/DX4

---

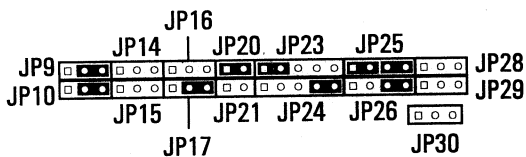
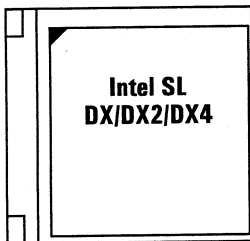

---

## Intel SL SX

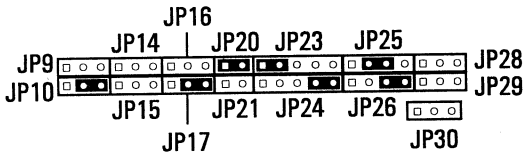
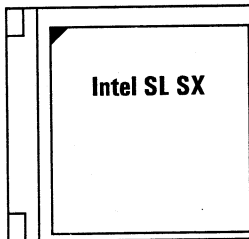

---

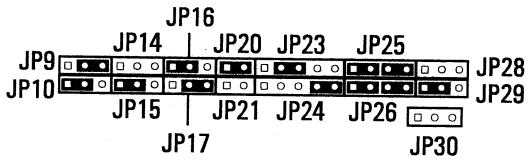
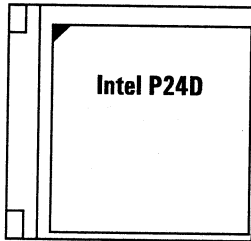

# Intel P24D



For the Intel P24D CPU, you can use JP16 to select write-back (the default) or write-through.

Intel P24D CPU: Write-Back/Write-Through Select	JP16
Write-Back	1 
Write-Through	1 



# Intel P24T

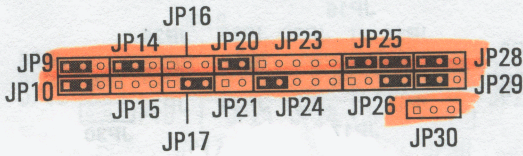
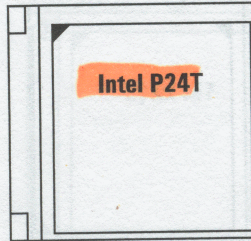



For the P24T, you can use JP14 to select write-back or write-through.

P24T Write-Back/Write-Through	JP14
Write-Through	1 <input type="checkbox"/> <input checked="" type="checkbox"/>
<b>Write-Back</b>	<b>1 <input checked="" type="checkbox"/> <input type="checkbox"/></b>

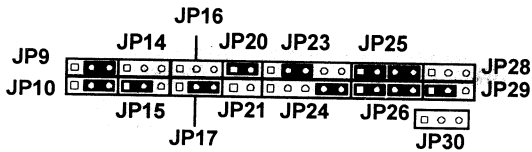
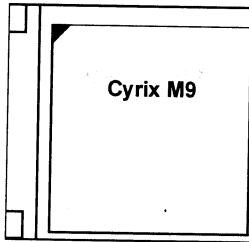
# Cyrix M9, M1SC, 5X86



For the M9, you can use JP30 to choose the clock multiplier: 2X or 3X (the default) clock.

M9 CPU: Clock Multiplier	JP30
2X Clock	1 
3X Clock	1 

---

---

## Cyrix M7

---

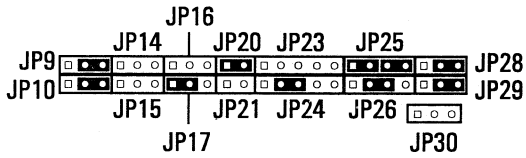
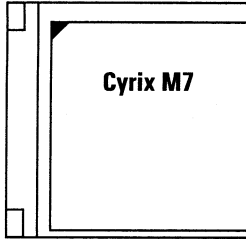

---

## UMC 486

---

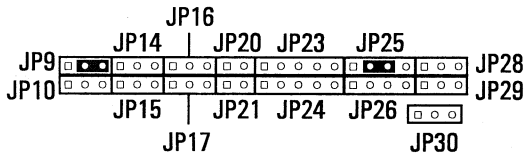
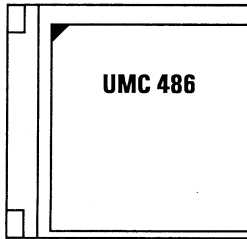

## AMD Enhanced SX Write-Back

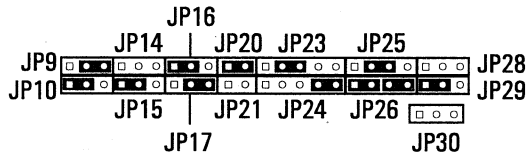
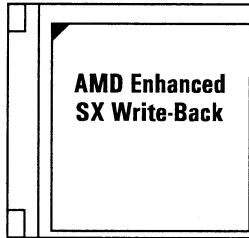

For the AMD Enhanced SX Write-Back CPU, you can use JP16 to select write-back (the default) or write-through.

AMD Enhanced Write-Back CPU: Write-Back/Write-Through Select	JP16
Write-Back	1
Write-Through	1

You can also use JP30 to choose the clock multiplier: 2X or 3X (the default) clock.

AMD Enhanced Write-Back CPU: Clock Multiplier	JP30
2X Clock	1
3X Clock	1

## AMD Enhanced DX/DX2/DX4 Write-Back

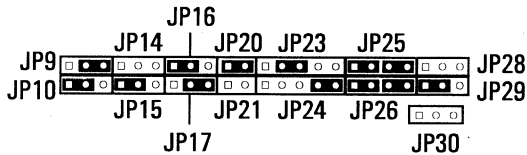
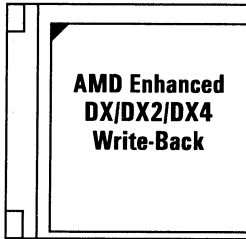

For the AMD Enhanced DX/DX2/DX4 Write-Back CPU, you can use JP16 to select write-back (the default) or write-through.

AMD Enhanced Write-Back CPU: Write-Back/Write-Through Select	JP16
Write-Back	1 <input checked="" type="checkbox"/> <input type="checkbox"/> <input type="checkbox"/>
Write-Through	1 <input type="checkbox"/> <input checked="" type="checkbox"/> <input checked="" type="checkbox"/>

You can also use JP30 to choose the clock multiplier: 2X or 3X (the default) clock.

AMD Enhanced Write-Back CPU: Clock Multiplier	JP30
DX4-100 for 2X Clock	1 <input type="checkbox"/> <input checked="" type="checkbox"/> <input checked="" type="checkbox"/>
DX4-133 for 4X Clock	1 <input type="checkbox"/> <input checked="" type="checkbox"/> <input type="checkbox"/>
3X Clock	1 <input type="checkbox"/> <input type="checkbox"/> <input type="checkbox"/>



*133 MHz*

---

---

- **JP39: Turbo Switch**

This connector sets the default speed of the CPU clock. This connector is usually connected by a lead to a Turbo/Normal switch on the front of the system case.

Default Clock Speed	JP39
High-speed (turbo) operation	 1
Normal (low-speed) operation	 1

You can change between high-speed and low-speed operation by pressing the Turbo/Normal switch on the front of the system case or by pressing the following key combinations simultaneously:

**CTRL, ALT, and “-”:** Switches the CPU to low speed.

**CTRL, ALT, and “+”:** Switches the CPU to high speed.

---

---

# Chapter 4

## Award BIOS Setup

The ROM chips of your main board are configured with a customized Basic Input/Output System (BIOS) from Award Software Inc. The BIOS is a set of permanently recorded program routines that give the system its fundamental operational characteristics. It also tests the computer and determines how the computer reacts to specific instructions that are part of programs.

The BIOS is made up of code and programs that provide the device-level control for the major I/O devices in the system. It contains a set of routines (called POST, for Power-On Self Test) that check out the system when you turn it on. The BIOS also includes CMOS Setup programs, so no disk-based setup program is required. CMOS RAM stores information for:

- the date and time
- the memory capacity of the main board
- the type of display adapter installed
- the number and type of disk drives installed

The CMOS memory is maintained by a battery installed on the main board. By using the battery, all memory in CMOS can be retained when the system power switch is turned off.

### 4-1 Entering the CMOS Setup Program

Use the CMOS Setup program to modify the system parameters to reflect the options installed in your system and to customize your system as desired. For example, you should run the Setup program after you:

- Replace the battery
- Install another disk drive
- Receive an error code at startup
- Use your system after not having used it for a long time
- Find the original setup missing

---

---

Run the CMOS Setup program after you turn on the system. On-screen instructions explain how to use the program.

☞ **Enter the CMOS Setup program's main menu as follows:**

1. Turn on or reboot the system. After the BIOS performs a series of diagnostic checks, the following message appears:

"Press DEL to enter SETUP"

2. Press the <DEL> key to enter the CMOS Setup program. The main menu appears:

ROM PCI/ISA BIOS  
CMOS SETUP UTILITY  
AWARD SOFTWARE, INC.

STANDARD CMOS SETUP	PASSWORD SETTING
BIOS FEATURES SETUP	IDE HDD AUTO DETECTION
CHIPSET FEATURES SETUP	SAVE & EXIT SETUP
POWER MANAGEMENT SETUP	EXIT WITHOUT SAVING
PCI CONFIGURATION SETUP	
LOAD BIOS DEFAULTS	
LOAD SETUP DEFAULTS	
ESC : QUIT	←→ ↑ ↓ : Select Item
F10 : Save & Exit Setup	(Shift)F2 : Change Color
Time, Date, Hard Disk Type.....	

3. Choose a setup option with the arrow keys and press <Enter>. See the following sections for a brief description of each setup option.

In the main menu, press F10 ("Save & Exit Setup") to save your changes and reboot the system. Choosing "EXIT WITHOUT SAVING" ignores your changes and exits the program. Pressing <ESC> anywhere in the program returns you to the main menu.



---

---

## Quick Setup

In most cases, you can quickly configure the system by choosing the following main menu options:

1. Choose "STANDARD CMOS SETUP" from the main menu. This option lets you configure the date and time, hard disk drive type, floppy disk drive type, primary display, and more.
2. Choose "LOAD-SETUP DEFAULTS" from the main menu. This loads the setup default values from the BIOS Features Setup and Chipset Features Setup screens.
3. In the main menu, press F10 ("Save & Exit Setup") to save your changes and reboot the system.

---

---

## 4-2 Menu Options

The main menu options of the CMOS Setup program are described in the table below and in the following sections of this chapter.

Option	Function
STANDARD CMOS SETUP	Configure the date & time, hard disk drive type, floppy disk drive type, primary display type, and more.
BIOS FEATURES SETUP	Configure advanced system options such as enabling/disabling cache memory and shadow RAM.
CHIPSET FEATURES SETUP	Configure advanced chipset options such as DRAM and cache speed.
POWER MANAGEMENT SETUP	Configure power management features such as timer selects.
PCI CONFIGURATION SETUP	Configure PCI slots and onboard I/O functions.
LOAD BIOS DEFAULTS	Loads BIOS default values. Use this option as a diagnostic aid if your system behaves erratically.
LOAD SETUP DEFAULTS	Loads optimized BIOS settings.
PASSWORD SETTING	Configures the system so that a password is required when the system boots or you attempt to enter the CMOS setup program.
IDE HDD AUTO DETECTION	Automatically detects IDE hard disk drives and enters parameters into the Standard CMOS Setup. All IDE hard disk drives are detected as type 47 drives.
HDD LOW LEVEL FORMAT	Lets you search for bad tracks and format a hard disk drive.

---

---

## Standard CMOS Setup

---

☞ Use the Standard CMOS Setup option as follows:

1. Choose "STANDARD CMOS SETUP" from the main menu. The following screen appears:

```
ROM PCI/ISA BIOS
STANDARD CMOS SETUP
AWARD SOFTWARE, INC.
```

Date (mm:dd:yy) : Sun, Sep 11 1994								
Time (hh:mm:ss) : 5 : 4 : 23								
HARD DISKS	TYPE	SIZE	CYLS	HEAD	PRECOMP	LANDZ	SECTOR	MODE
Primary Master	: Auto	0	0	0	0	0	0	0 -----
Primary Slave	: Auto	0	0	0	0	0	0	0 -----
Secondary Master	: Auto	0	0	0	0	0	0	0 -----
Secondary Slave	: Auto	0	0	0	0	0	0	0 -----
Drive A : 1.44M, 3.5 in.								
Drive B : None								
Video : EGA/VGA								
Halt On : All Errors								
		Base Memory:		640K				
		Extended Memory:		7168K				
		Other Memory:		384K				
		Total Memory:		8192K				
ESC : Quit		↑↓→← : Select Item		PU/PD/+/- : Modify				
F1 : Help		(Shift)F2 : Change Color						

2. Use the arrow keys to move between fields. Modify the selected field using the PgUp/PgDn/+/- keys. Some fields let you enter numeric values directly.

Date (mn/date/year)	Type the current date.
Time (hour:min:sec)	Type the current time (24-hour clock).
Hard disk C & D	Choose from the standard hard disk types 1 to 46, "User", and "None". If your drive is not one of the 46 predefined types, choose "User" and enter the following drive specifications: cylinders, heads, WPcom, L-Zone, and capacity. Consult the documentation received with the drive for the values that will give you optimum performance.  If no hard disk is installed, choose "None."
Floppy drive A & B	Choose: 360KB / 5.25" 1.2MB / 5.25" 720KB / 3.5" 1.4M / 3.5" 2.88M/3.5" or Not Installed  <b>Note:</b> The W83787 chip doesn't support the 2.88M/3.5" drive.
Video	Choose: Monochrome, CGA40, CGA80, or EGA/VGA
Halt On	Controls whether the system stops in case of an error.  Choose: All Errors (the default) No Errors All, But Keyboard All, But Diskette All, But Disk/Key

- After you have finished with the Standard CMOS Setup program, press the <ESC> key to return to the main menu.

---

---

## BIOS Features Setup

---

 Use the Advanced CMOS Setup option as follows:

1. Choose "BIOS FEATURES SETUP" from the main menu. The following screen appears:

ROM PCI/ISA BIOS  
BIOS FEATURES SETUP  
AWARD SOFTWARE, INC.

Virus Warning	: Disabled	Video BIOS Shadow	: Enabled
CPU Internal Cache	: Enabled	C8000-CBFFF Shadow	: Disabled
External Cache	: Enabled	CC000-CFFFF Shadow	: Disabled
Quick Power On Self Test	: Disabled	D0000-D3FFF Shadow	: Disabled
Boot Sequence	: A,C	D4000-D7FFF Shadow	: Disabled
Swap Floppy Drive	: Disabled	D8000-DBFFF Shadow	: Disabled
Boot Up Floppy Seek	: Enabled	DC000-DFFFF Shadow	: Disabled
Boot Up Numlock Status	: On		
Boot Up System Speed	: High		
Memory Parity Check	: Disabled		
Typematic Rate Setting	: Disabled		
Typematic Rate (Chars/Sec)	: 6		
Typematic Delay (Msec)	: 250		
Security Option	: Setup		
		Esc: Quit	←→↑↓:Select Item
		F1 : Help	Pu/Pd/+/- :Modify
		F5 : Old Values (Shift)	F2 : Color
		F6 : Load BIOS Defaults	
		F7 : Load BIOS Defaults	

2. Use the arrow keys to move between items and to select values. Modify the selected fields using the PgUp/PgDn keys. Press the <F1> "Help" key for information on the available options:

Virus Warning	When enabled, any attempt to write to the boot sector and partition table will halt the system and cause a warning message to appear. If this happens, you can use an anti-virus utility on a virus-free, bootable floppy disk to reboot and clean your system. The default setting is Enabled.
CPU Internal Cache	This setting enables the CPU internal cache. The default setting is Enabled.
External Cache	This setting enables the external cache. The default setting is Enabled.
Quick Power On Self Test	Speeds up POST after turning on the computer. When enabled, this setting will shorten or skip some check items during POST.
Boot Sequence	By default, the BIOS attempts to first boot from drive C: and then, if unsuccessful, from drive A:. You can reverse this sequence with this option.
Swap Floppy Drive	Swaps the drive designation for A: and B: floppy disk drives.
Boot Up Floppy Seek	When enabled, the BIOS will check whether there is a floppy disk drive installed. The default setting is Enabled.
Boot Up Num Lock Status	Choose On or Off. On puts the numeric keypad in Num Lock mode at boot-up. Off puts the numeric keypad in arrow key mode at boot-up.
Boot Up System Speed	Choose High or Low. This option lets you choose system boot-up speed.

Memory Parity Check	When enabled, allows the normal memory parity check. When disabled, ignores the parity check (the default setting). You should disable this option if installed SIMMs have no parity chip.
Typematic Rate Setting	Choose Enabled or Disabled. Enable this option to adjust the keystroke repeat rate. Adjust the rate via Typematic Rate Delay and Typematic Rate.
Typematic Rate (Chars/Sec)	Choose the rate at which a character keeps repeating.
Typematic Rate Delay	Choose the delay between holding down a key and when the character begins repeating.
Security Option	Choose Setup or System. This option lets you specify whether a password is required every time the system boots or only when an attempt is made to enter the CMOS Setup program. "Setup" – The password prompt only appears if you attempt to enter the CMOS Setup program. "System" – The password prompt appears each time the system is booted. <b>Note:</b> The password function is disabled by default. For a description of enabling the password function, refer to the section "Change Password" later in this chapter.
Video BIOS Shadow	When enabled, the ROM BIOS on the video display card is copied into system DRAM to enhance performance. The default setting is Enabled.
Shadow Option Group	When enabled, the ROM on the expansion card with the specific addresses is copied into system DRAM. It will also reduce the memory available by between 640KB and 1024KB. The default setting for this feature is Disabled.

- After you have finished with the BIOS Features Setup, press the <ESC> key to return to the main menu.

## Chipset Features Setup

Use this setup to enable/disable features of the main board's chipset.

 Use the Chipset Features Setup option as follows:

- Choose "CHIPSET FEATURES SETUP" from the main menu. The following screen appears:

ROM PCI/ISA BIOS  
CHIPSET FEATURES SETUP  
AWARD SOFTWARE, INC.

Auto Configuration	: Enabled	Onboard 496B IDE Port	: Both
ISA Bus Clock	: 1/4 PCLK	IDE 0 Master Mode	: Auto
LED # Sample Point	: End of T3	IDE 0 Slave Mode	: Auto
Cache Write Cycle	: 2 CCLK	IDE 1 Master Mode	: Auto
Cache Burst Read Cycle	: 1 CCLK	IDE 1 Master Mode	: Auto
L2 Cache/DRAM Cycle WS	: 2 CCLK	IDE HDD Block Mode	: Enabled
DRAM RAS To CAS Delay	: 3 CCLK	Onboard FDD Controller	: Enabled
DRAM Write Cycle	: 1 WS	Onboard Serial Port 1	: COM1 (3F8h)
DRAM Write CAS Pulse	: 2CCLK	Onboard Serial Port 2	: COM2 (2F8h)
DRAM CAS Precharge Time	: 1 CCLK	Onboard Parallel Port	: 378H
DRAM RAS To MA Relay	: 2 CCLK	Onboard Parallel Mode	: EPP/SPP
DRAM Speed	: Faster	Serial Port 1 MIDI	: Disabled
CPU Burst Write	: Enable	Serial Port 2 MIDI	: Disabled
L2 Cache Policy	: Write Back	Esc: Quit	←→↑↓: Select Item
L2 Cache Tag Bits	: 7 bits	F1 : Help	Pu/Pd/+/-: Modify
		F5 : Old Values (Shift)F2 : Color	
		F6 : Load BIOS Defaults	
		F7 : Load BIOS Defaults	

- Move between items and select values by using the arrow keys. Modify the selected fields using the PgUp/PgDn keys. For information on the various options, press the <F1> key.
- After you have finished with the Chipset Features Setup, press the <ESC> key to return to the main menu.



---

---

## Power Management Setup

---

The Power Management Setup controls the main board's "green" features. The video features work with a "green" monitor.

☞ Use the Power Management Setup option as follows:

1. Choose "Power Management Setup" from the main menu. The following screen appears:

```
ROM PCI/ISA BIOS
POWER MANAGEMENT SETUP
AWARD SOFTWARE, INC.
```

Power Management	: Disable	IRQ4 (COM 1)	: Enable
PM Control By APM	: Yes	IRQ5 (LPT 2)	: Enable
Video Off Option	: Susp,Stby -> Off	IRQ6 (Floppy Disk)	: Enable
Video Off Method	: V/H SYNC+Blank	IRQ7 (LPT 1)	: Enable
Suspend Switch	: Enable	IRQ8 (RTC Alarm)	: Disable
		IRQ9 (IRQ2 Redir)	: Enable
** PM Timers **			
HDD Off After	: Disable	IRQ10 (Reserved)	: Enable
Doze Mode	: Disable	IRQ11 (Reserved)	: Enable
Standby Mode	: Disable	IRQ12 (PS/2 Mouse)	: Enable
Suspend Mode	: Disable	IRQ13 (Coprocessor)	: Disable
		IRQ14 (Hard Disk)	: Disable
		IRQ15 (Reserved)	: Enable
** PM Events **			
PCI Master Activity	: Enable	ESC : Quit	↑↓→←: Select Item
COM Ports Activity	: Enable	F1 : Help	PU/PD/+/- : Modify
LPT Ports Activity	: Enable	F5 : Old Values (Shift)	F2 : Color
HDD Ports Activity	: Enable	F6 : Load BIOS Defaults	
DMA Ports Activity	: Enable	F7 : Load Setup Defaults	
VGA Activity	: Disable		
IRQ3 (COM 2)	: Enable		

2. Move between items and select values by using the arrow keys. Modify the selected fields using the PgUp/PgDn keys. For information on the various options, press the <F1> key.

Power Management	<p>Controls the system Doze, System Standby, and System Suspend Timer features. There are three options:</p> <p>User Define: Lets you customize all power-saving timer features.</p> <p>Optimize: This is the recommended setting for general use.</p> <p>Disable: Disables the system power management feature.</p>
HDD Off After	Settings range from 1 min. to 15 mins. and Disabled. The IDE hard drive will spin down if it is not accessed within a specified length of time.
Doze Mode	Settings range from 1 min. to 30 mins. and Disabled. The system speed will change from turbo to slow by throttling the CPU clock if no Power Management events occur for a specified length of time. The system will return to full power when a Power Management event is detected.
Standby Mode	Settings range from 1 min. to 30 mins. and Disabled. The system speed will change from turbo to slow by throttling the CPU clock and the video signal is suspended if no Power Management events occur for a specified length of time. The system will return to full power when a Power Management event is detected.
Suspend Mode	Settings range from 1 min. to 30 mins. and Disabled. The CPU clock is stopped and the video signal is suspended if no Power Management events occur for a specified length of time. The system will return to full power when a Power Management event is detected.

- After you have finished with the Power Management Setup, press the <ESC> key to return to the main menu.

## PCI Configuration Setup

This setup is used to route PCI interrupts to designated ISA interrupts.

☞ Use the **PCI Configuration Setup** option as follows:

- Choose "PCI Configuration Setup" from the main menu. The following screen appears:

ROM PCI/ISA BIOS  
 PCI & ONBOARD I/O SETUP  
 AWARD SOFTWARE, INC.

PnP BIOS Auto-Config	: Disabled	PCI Master Burst Read/Write: Disabled
Slot 1 Using INT#	: AUTO	
Slot 2 Using INT#	: AUTO	
Slot 3 Using INT#	: AUTO	
1st Available IRQ	: 9	
2nd Available IRQ	: 10	
3rd Available IRQ	: 11	
4th Available IRQ	: 12	
PCI IRQ Activated by	: Edge	
PCI IDE 2nd Channel	: Enable	
PCI IDE IRQ Map to	: PCI-AUTO	
Primary IDE INT#	: A	
Secondary IDE INT#	: B	
Master Arbitration Protocol	: Weak	
CPU→PCI Mem Post Write Buf	: Disabled	Esc: Quit           ↔↑↓: Select Item
PCI→CPU Memory Burst Write	: Disabled	F1 : Help           Pu/Pd/+/-:Modify
		F5 : Old Values (Shift)F2 : Color
		F6 : Load BIOS Defaults
		F7 : Load BIOS Defaults

- Move between items and select values by using the arrow keys. Modify the selected fields using the PgUp/PgDn keys. For information on the various options, press the <F1> key.
- After you have finished with the PCI Configuration Setup, press the <ESC> key to return to the main menu.

---

---

## Load BIOS Defaults

---

This is useful if you are having problems with the main board and need to debug or troubleshoot the system. The defaults loaded affect only the BIOS Features Setup and Chipset Features Setup screens. There is no effect on the Standard CMOS Setup.

To use this feature, highlight it on the main screen and press <Enter>. A line will appear on the screen asking if you want to load the BIOS default values.

ROM PCI/ISA BIOS  
CMOS SETUP UTILITY  
AWARD SOFTWARE, INC.

STANDARD CMOS SETUP	PASSWORD SETTING
BIOS FEATURES SETUP	IDE HDD AUTO DETECTION
CHIPSET FEATURES SETUP	SAVE & EXIT SETUP
POWER MANAGEMENT	VIEWING
PCI CONFIGURATION	Load SETUP Defaults (Y/N)? N
LOAD BIOS DEFAULTS	
LOAD SETUP DEFAULTS	
ESC : QUIT                                  ← → ↑ ↓ : Select Item	
F10 : Save & Exit Setup                  (Shift)F2 : Change Color	
Time, Date, Hard Disk Type.....	

Press the <Y> key and then press <Enter> if you want to load the BIOS defaults.

---

## **Load Setup Defaults**

This loads optimized settings that are stored in the BIOS ROM. The auto-configured settings affect only the BIOS Features Setup and Chipset Features Setup screens. There is no effect on the Standard CMOS Setup. To use this feature, highlight it on the main screen and press <Enter>. A line will appear on the screen asking if you want to load the Setup default values.

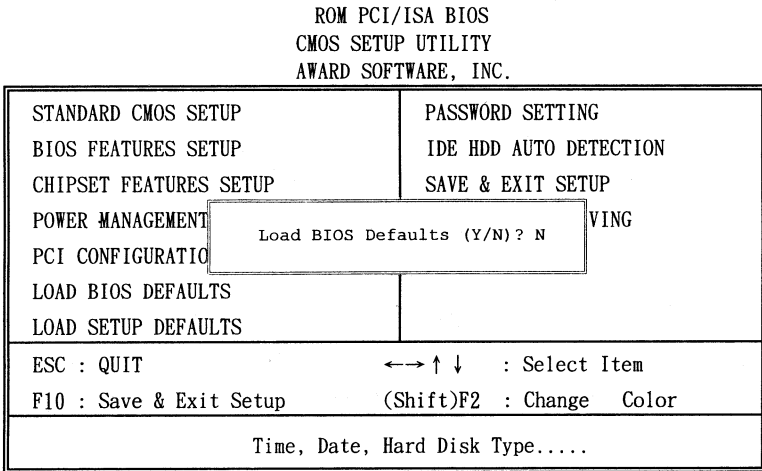

Press the <Y> key and then press <Enter> if you want to load the Setup defaults.

---

## **Password Setting**

The Password Setting option lets you prevent unauthorized system boot-up or unauthorized use of CMOS Setup. The password function is disabled by default. You can use this option to enable the password function or, if the password function is already enabled, change the password.

To change the password, you must first enter the current password. Then type your new password at the prompt. The password is case sensitive and you can use up to 8 alphanumeric characters. Press <Enter> after entering

---

---

the password. At the next prompt, confirm the new password by typing it and pressing <Enter> again.

```
ROM PCI/ISA BIOS
CMOS SETUP UTILITY
AWARD SOFTWARE, INC.
```

STANDARD CMOS SETUP	PASSWORD SETTING
BIOS FEATURES SETUP	IDE HDD AUTO DETECTION
CHIPSET FEATURES SETUP	HDD LOW LEVEL FORMAT
POWER MANAGEMENT SETUP	SAVE & EXIT SETUP
PCI CONFIGURATION SETUP	EXIT WITHOUT SAVING
LOAD BIOS DEFAULTS	Enter Password: <input type="text"/>
LOAD SETUP DEFAULTS	

---

```
Esc : Quit                ↑↓→← : Select Item
F10 : Save & Exit Setup   (Shift)F2 : Change Color
```

---

Change/Set/Disable Password

After you use this option to enable the password function, use the "Security Option" in "BIOS Features Setup" to specify whether a password is required every time the system boots or only when an attempt is made to enter the CMOS Setup program.

## ***IDE HDD Auto Detection***

---

If your system has an IDE hard disk drive, you can use this utility to detect its parameters and enter them into the Standard CMOS Setup automatically.

If the auto-detected parameters displayed do not match the ones that should be used for your drive, do not accept them. Press the <N> key to reject the values and enter the correct values manually from the Standard CMOS Setup screen.

☞ Enable the Auto Detect Hard Disk function as follows:

1. Choose "IDE HDD AUTO DETECTION" in the main menu and press <Enter>. The following screen appears:

ROM PCI/ISA BIOS  
CMOS SETUP UTILITY  
AWARD SOFTWARE, INC.

HARD DISKS	TYPE	SIZE	CYLS	HEAD	PRECOMP	LANDZ	SECTOR	MODE
Primary Master	:	540	524	32	0	1048	63	LBA
Primary Slave	:							
Secondary Master	:							
Secondary Slave	:							

Select Secondary Slave Option (N=Skip) : N

OPTIONS	SIZE	CYLS	HEAD	PRECOMP	LANDZ	SECTOR	MODE
1(Y)	0	0	0	0	0	0	NORMAL

ESC : Skip

2. Press <ESC> to exit to the main menu.

---

---

## 4-3 The Flash Memory Utility

If your main board has flash memory, you can use the Flash Memory Utility to update the system BIOS from a disk file. Contact your dealer to obtain the Flash Memory Utility and the latest version of the system BIOS disk file.

**CAUTION:** *Improperly changing the system BIOS will cause the system to malfunction.*

☞ Use the Flash Memory Utility as follows:

1. Insert the Flash Memory Utility distribution floppy disk in drive A:.
2. At the DOS prompt, type `A:>AWDFLASH` and press <Enter>. The following screen appears:

Flash Memory Writer V5.0 Copy (C) 1993, Award Software, Inc.	
For SiS-496-497/A/B-2A42BJ	Date: 11/24/1995
Flash Type -	
File Name to Program :	<input type="text"/>
Error Message:	

3. Enter the name of the system BIOS disk file in the File Name to Program field. The following message appears in the Error Message field:  
Do you want to save bios (Y/N)?
4. To save the system BIOS type Y, don't save the system BIOS type N, the following message appears in the error message field:  
Are you sure to program (Y/N)?
5. To update the flash memory from the system BIOS disk file, type Y. After updating, turn off power and restart the computer again.



---

---

# Appendix: Connector Pin Signals

This appendix lists the pin signals for the board's external connectors.

## *CN1: Printer Connector*

---

Pin	Description	Pin	Description
1	STB#	10	ACK#
2	PD0	11	BUSY
3	PD1	12	PE
4	PD2	13	SLCT
5	PD3	14	AFD#
6	PD4	15	ERR#
7	PD5	16	INIT#
8	PD6	17	SLIN#
9	PD7	18-25	GND
		26	N.C.

---

---

## ***CN2: Secondary IDE and CN3: Primary IDE***

---

<b>Pin</b>	<b>Description</b>	<b>Pin</b>	<b>Description</b>
1	IDE reset signal	15	IDE data bit 1
2	GND	16	IDE data bit 14
3	IDE data bit 7	17	IDE data bit 0
4	IDE data bit 8	18	IDE data bit 15
5	IDE data bit 6	19, 22, 24, 26, 30, 40	GND
6	IDE data bit 9	23	IDE write signal
7	IDE data,bit 5	25	IDE read signal
8	IDE data bit 10	27	IDE ready signal
9	IDE data bit 4	20, 21, 28, 29, 32, 34	N.C.
10	IDE data bit 11	31	IDE IRQ
11	IDE data bit 3	33	IDE address bit 1
12	IDE data bit 12	35	IDE address bit 0
13	IDE data bit 2	36	IDE address bit 2
14	IDE data bit 13	37, 38	IDE chips select signal
		39	IDE active signal

---

---

### ***CN4: Floppy Disk Drive Connector***

---

<b>Pin</b>	<b>Description</b>	<b>Pin</b>	<b>Description</b>
1, 3, 5, 7, 9, 11, 13, 15, 17, 19, 21, 23, 25, 27, 29, 31, 33	GND	18	DIR#
2	RWC#	20	STEP#
4,6	N.C.	22	WD#
8	INDEX#	24	WE#
10	MOA#	26	TRAK0
12	DSB#	28	WP#
14	DSA#	30	RDATA#
16	MOB#	32	HEAD#
		34	DSKCHG#

### ***CN5: COMA Port and CN6: COMB Port***

---

<b>Pin</b>	<b>Description</b>	<b>Pin</b>	<b>Description</b>
1	DCD	6	DSR
2	SIN	7	RTS
3	SOUT	8	CTS
4	DTR	9	RI
5	GND	10	N.C.

---

---

### ***JP4: The Keyboard Connector***

---

<b>Pin</b>	<b>Description</b>
1	Keyboard data
2	Keyboard clock
3	N.C.
4	Ground
5	+5V DC

### ***JP5: The Power Supply Connector***

---

<b>Pin</b>	<b>Description</b>	<b>Pin</b>	<b>Description</b>
1	Power Good	7	Ground
2	+5v DC	8	Ground
3	+12V DC	9	-5V DC
4	-12V DC	10	+5V DC
5	Ground	11	+5V DC
6	Ground	12	+5V DC

### ***JP27: Speaker Connector***

---

<b>Pin</b>	<b>Description</b>
1	DATA out
2	Ground
3	Ground
4	Vcc

---

---

### ***JP33: IDE Active LED***

---

<b>Pin</b>	<b>Description</b>
1	IDE Active Signal
2	+5V DC

### ***JP37: Turbo LED Connector***

---

<b>Pin</b>	<b>Description</b>
1	+5V DC
2	Turbo Signal

### ***JP40: Keylock & Power LED Connector***

---

<b>Pin</b>	<b>Description</b>
1	Power LED
2	N.C.
3	Ground
4	Keylock
5	Ground

### ***LED1: Power-Saving LED Connector***

---

<b>Pin</b>	<b>Description</b>
1	+5V DC
2	Standby Signal

---

---

## How to installing the M/B in the case

Before installing the M/B to the case, please make sure your spacer supports lower than the CPU socket, Because there is a hole inside the CPU socket, if the spacer supports too high, CPU can't place into socket; please cut the top of spacer supports let spacer supports lower, and let you can place your CPU into the socket. Or use our black spacer supports instead of yours.

### 如何安裝主機板

在安裝主機板之前，請先確定裝機塑膠柱子是否會高出 CPU 座的高度，因為塑膠柱過高會造成 CPU 無法完全插入腳座，因此建議剪去塑膠柱頂端一些，或是採用所附之黑色塑膠柱子固定主機板。

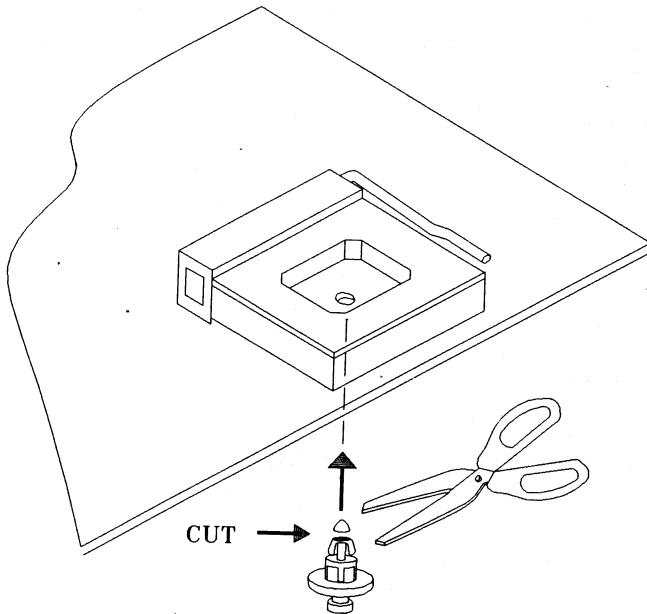

## Jumper Switches and Functions List

Jumper	Function
JP1	External Battery Connector
JP2 & JP3	Clear BIOS Setup Data
JP4	Keyboard Connector
JP5	Power Supply Connector
JP6	Monochrome/Color Selection
JP7 & JP8	Cache Size Selection
JP9 & JP10	CPU Type Selection
JP14-JP17	
JP20-JP21	
JP23-JP26	
JP28-JP30	
JP11 & JP12	Clock Speed Selection
JP13	[Factory Preset: Testing Purposes Only]
JP18	DREQ Signal Select for ECP/EPP Function
JP19	BIOS Type Selection
JP22	DACK Signal Select for ECP/EPP Function
JP27	Speaker Connector
JP31, JP32, & JP34	CPU Voltage Selection
JP33	IDE Active LED Connector
JP35	Standby Mde Switch Connector
JP36	Power-Saving Output Signal Connector
JP37	Turbo LED Connector
JP38	Reset Connector
JP39	Turbo Switch Connector
JP40	Keylock & Power LED Connector
LED1	Power Saving LED Connector
CN1	Printer Connector
CN2	Secondary IDE Connector
CN3	Primary IDE Connector
CN4	Floppy Disk Drive Connector
CN5	Serial Port 1 Connector
CN6	Serial Port 2 Connector

Jumper	功 能
JP1	外接電池
JP2 & JP3	清除 BIOS 中設定
JP4	鍵盤插座
JP5	電源插座
JP6	單色/彩色設定
JP7 & JP8	快捷記憶體大小設定
JP9 & JP10	CPU 類型選擇
JP14-JP17	
JP20-JP21	
JP23-JP26	
JP28-JP30	
JP11 & JP12	
JP13	出廠設定
JP18	ECP/EPP DREQ 信號選擇
JP19	BIOS 種類選擇
JP22	ECP/EPP DACK 信號選擇
JP27	喇叭接頭
JP31, JP32, & JP34	CPU 電壓選擇
JP33	硬碟動作燈接頭
JP35	預備狀態模式開關接頭
JP36	省電輸出信號接頭
JP37	Turbo 燈接頭
JP38	Reset 接頭
JP39	Turbo 開關接頭
JP40	鍵盤鎖定和電源 LED 燈接頭
LED1	省電指示 LED 接頭
CN1	列表機接頭
CN2	第2組硬碟接頭
CN3	第1組硬碟接頭
CN4	軟碟接頭
CN5	通訊第1組接頭
CN6	通訊第2組接頭





