

# IMISR-VM

## Motherboard layout reference

### Contents

- Specifications summary
- Motherboard layout
- Rear panel connectors
- Function selectors
- Internal connectors

## Specifications summary

<b>CPU</b>	Intel Core 2 Dual Mobile processors/Intel Core solo FSB 533/800 MHz
<b>Chipset</b>	GM965 + ICH8M
<b>Memory</b>	DDR2 533/667 dual channel 2 slots, max. up to 4GB
<b>Expansion slots</b>	1x PCI Express Graphic slot (x16) 2x PCI slots 1x PCI Express slot (x1)
<b>Audio</b>	Azalia ALC883 (8-channel)
<b>LAN</b>	Geb LAN PHY 82566MC
<b>Alarm device</b>	Buzzer
<b>Storage connector</b>	Intel ICH8M integrated solution: 1x PATA UltraDMA 100 3x SATA ports
<b>Rear panel I/O ports</b>	1x PS/2 Keyboard port 1x PS/2 Mouse port 1x Parallel port 1x Serial port (COM) 1x VGA port 1x 1394a port + 2x USB ports 1x RJ-45 LAN port + 2x USB ports 1x Audio I/O (6 ports, 8-channel)
<b>Internal connectors</b>	1x Chassis Intrusion 1x Chassis FAN 1x CPU FAN 1x System FAN (SYS FAN) 1x Intel Front panel connector 1x ROM Recovery connector 1x Azalia Analog front panel audio connector 1x S/PDIF connector 1x CD audio in connector 3x USB 2.0 connectors, 6 ports 1x 1394a connector 1x Extended ATX power connector 1x ATX 12V connector 1x Floppy disk drive connector 1x IDE connector 1x Trusted Platform Module (TPM) connector

(Specifications are subject to change without notice.)

## Specifications summary

<b>Function selectors</b>	1x Clear CMOS selector 1x Keyboard power selector
<b>Frequency control</b>	Auto mode
<b>BIOS features</b>	4Mb SPI (AMI)
<b>Form factor</b>	uATX form factor 9.6 in. x 7.4 in.
<b>Support OS</b>	Windows XP/Vista
<b>WHQL</b>	Windows XP/Vista

(Specifications are subject to change without notice.)

# Motherboard layout

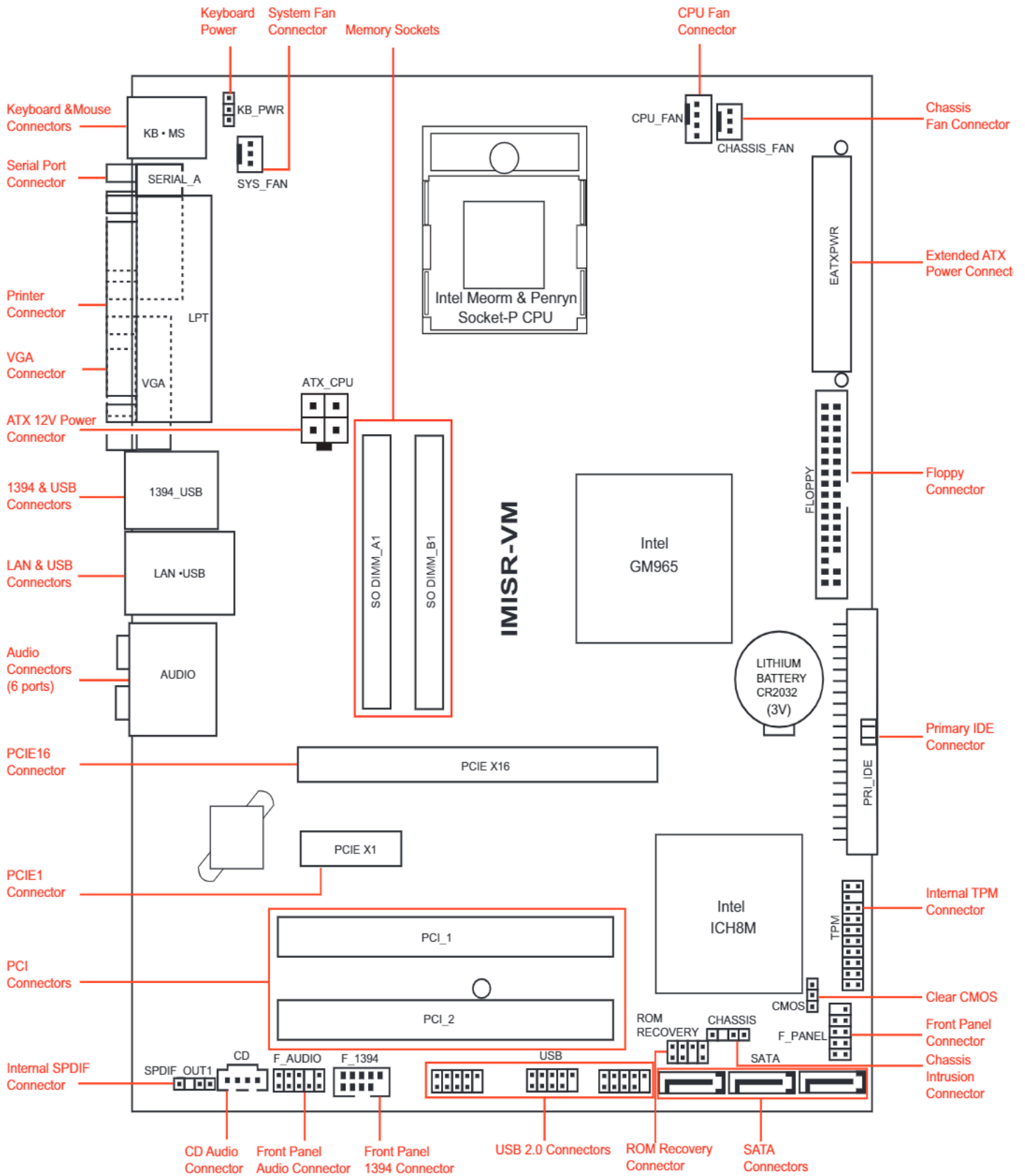

## Rear panel connectors

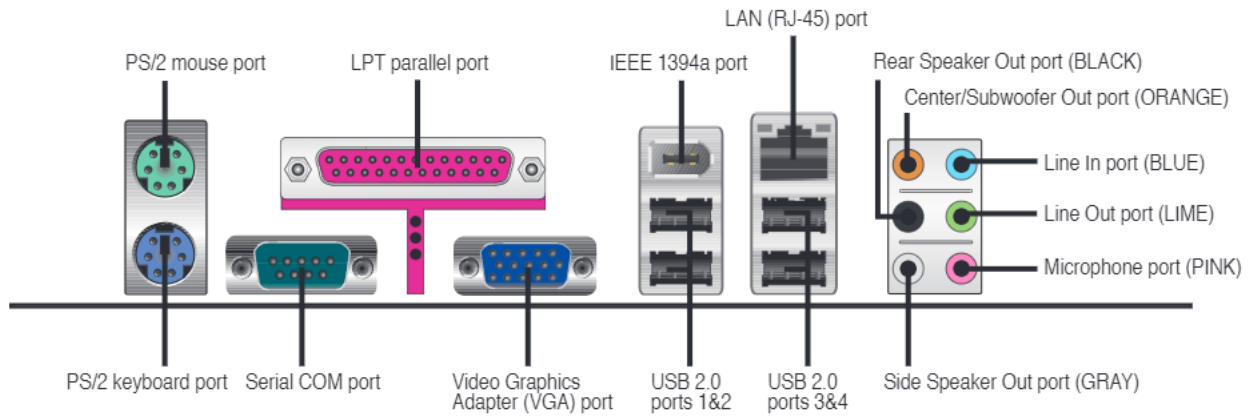

## LAN port LED indications

Left (SPEED)	
Off	: 10/100
Orange	: 1Gbit

Right (ACTIVITY)	
Green	: 1Gbit Link
Green	: Activity

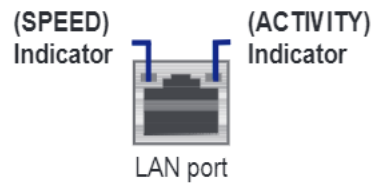

LAN port

## Function Selectors

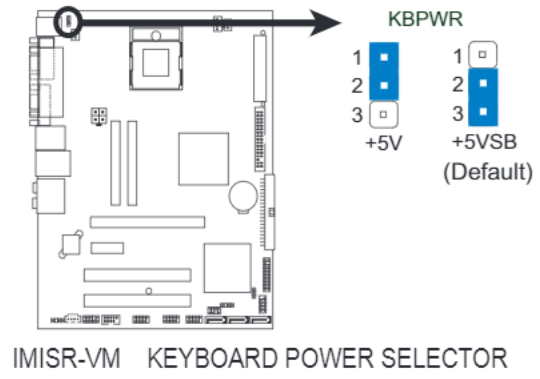
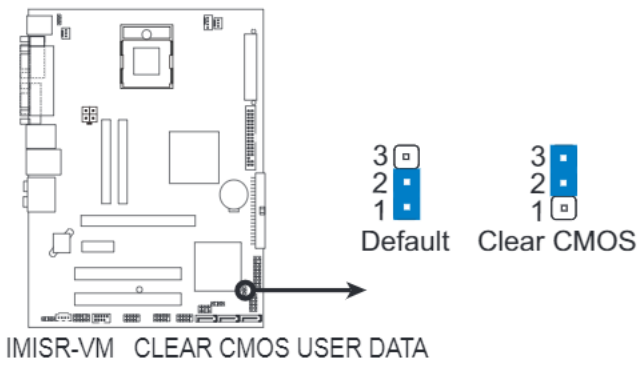

# Internal connectors

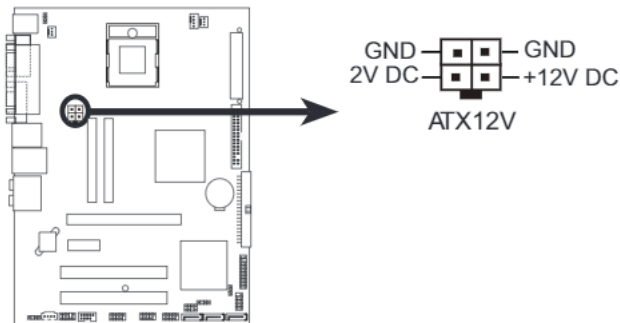

IMISR-VM ATX 12V POWER CONNECTOR

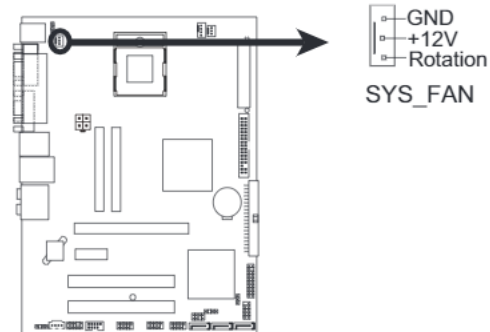

IMISR-VM SYSTEM FAN CONNECTOR

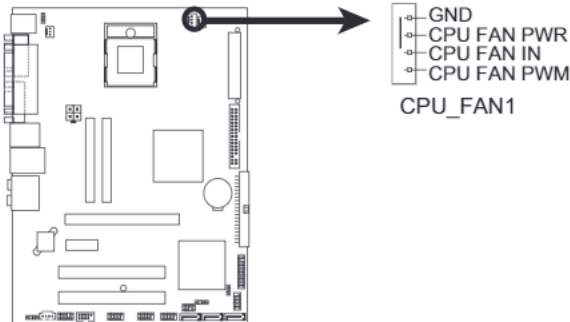

IMISR-VM CPU FAN CONNECTOR

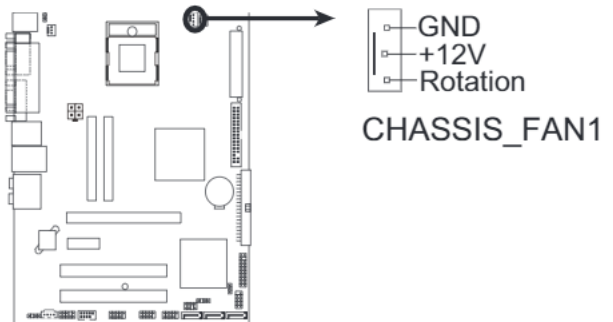

IMISR-VM CHASSIS FAN CONNECTOR

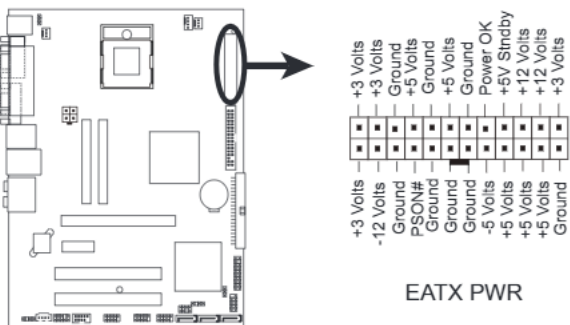

IMISR-VM EXTENDED ATX POWER CONNECTOR

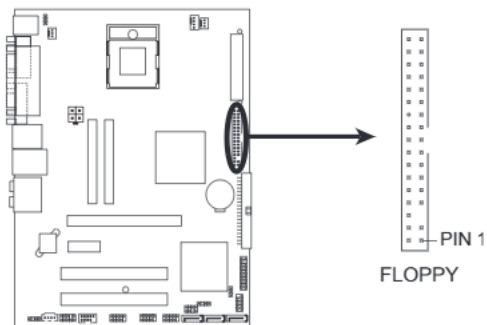

IMISR-VM FLOPPY DISK DRIVE CONNECTOR

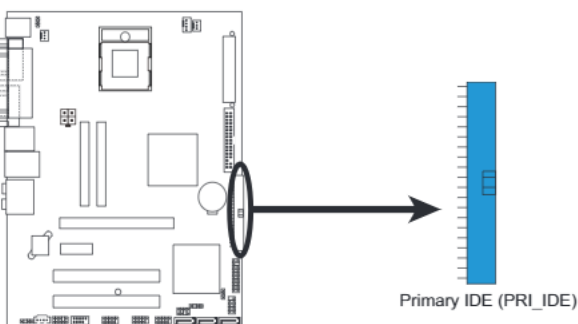

IMISR-VM PRIMARY IDE CONNECTOR

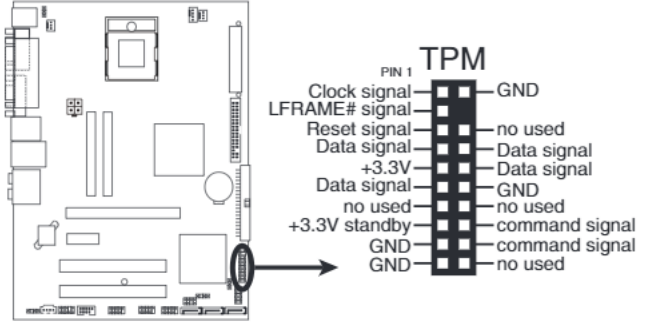

IMISR-VM INTERNAL TPM CONNECTOR

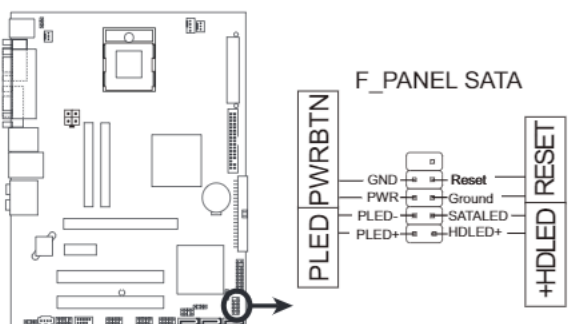

IMISR-VM FRONT PANEL CONNECTOR

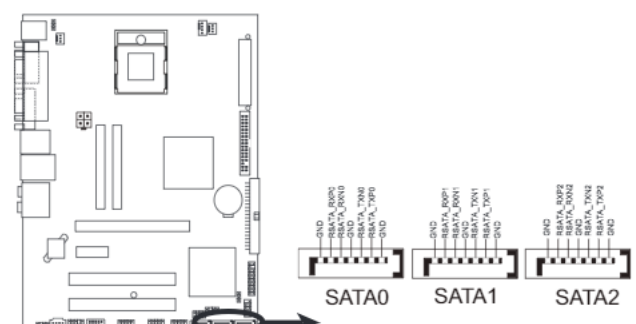

IMISR-VM SATA CONNECTORS

# Internal connectors (cont'd)

