



Your Reliable Partner

IC7-MAX3

Socket 478 System Board User's Manual

Copyright and Warranty Notice

The information in this document is subject to change without notice and does not represent a commitment on part of the vendor, who assumes no liability or responsibility for any errors that may appear in this manual.

No warranty or representation, either expressed or implied, is made with respect to the quality, accuracy or fitness for any particular part of this document. In no event shall the manufacturer be liable for direct, indirect, special, incidental or consequential damages arising from any defect or error in this manual or product.

Product names appearing in this manual are for identification purpose only and trademarks and product names or brand names appearing in this document are the property of their respective owners.

This document contains materials protected under International Copyright Laws. All rights reserved. No part of this manual may be reproduced, transmitted or transcribed without the expressed written permission of the manufacturer and authors of this manual.

If you do not properly set the motherboard settings, causing the motherboard to malfunction or fail, we cannot guarantee any responsibility.

Table Of Contents

IC7-MAX3 快速安裝指引	2
IC7-MAX3 のクイックインストールガイド	4
IC7-MAX3 Schnellinstallationsanleitung	6
IC7-MAX3 Guide d'Installation Rapide	8
Краткое руководство по установке IC7-MAX3	10
Guida all'installazione veloce Scheda madre IC7-MAX3	12
Chapter 1. Introduction	1-1
1-1. Features & Specifications	1-1
1-2. Layout Diagram	1-3
Chapter 2. Hardware Setup	2-1
2-1. Install The Motherboard.....	2-1
2-2. Install Pentium® 4 CPU and Heatsink Supporting-Base.....	2-2
2-3. Install System Memory	2-3
2-4. Connectors, Headers and Switches	2-5
(1). ATX Power Input Connectors	2-5
(2). FAN Connectors.....	2-6
(3). CMOS Memory Clearing Header	2-7
(4). Wake-up Header.....	2-8
(5). Front Panel Switches & Indicators Headers	2-9
(6). Additional USB Port Headers.....	2-10
(7). Additional IEEE1394 Port Header.....	2-11
(8). Front Panel Audio Connection Header	2-12
(9). System Management Bus Headers.....	2-13
(10). Internal Audio Connectors	2-13
(11). Accelerated Graphics Port Slot.....	2-14
(12). Floppy Disk Drive Connector	2-15
(13). IDE Connectors.....	2-16
(14). Serial ATA Connectors	2-17
(15). Status Indicators.....	2-18
(16). Back Panel Connectors	2-19

Chapter 3. BIOS Setup	3-1
3-1. SoftMenu Setup.....	3-2
3-2. Standard CMOS Features.....	3-4
3-3. Advanced BIOS Features.....	3-7
3-4. Advanced Chipset Features.....	3-10
3-5. Integrated Peripherals	3-12
3-6. Power Management Setup	3-17
3-7. PnP/PCI Configurations.....	3-20
3-8. PC Health Status	3-22
3-9. Load Fail-Safe Defaults	3-23
3-10. Load Optimized Defaults	3-23
3-11. Set Password	3-23
3-12. Save & Exit Setup.....	3-23
3-13. Exit Without Saving.....	3-23
<i>Appendix A. Install Intel Chipset Software Utility</i>	<i>A-1</i>
<i>Appendix B. Install Intel Application Accelerator RAID</i>	<i>B-1</i>
<i>Appendix C. Install Audio Driver</i>	<i>C-1</i>
<i>Appendix D. Install LAN Driver</i>	<i>D-1</i>
<i>Appendix E. Install Silicon Serial ATA RAID Driver</i>	<i>E-1</i>
<i>Appendix F. Install USB 2.0 Driver</i>	<i>F-1</i>
<i>Appendix G. BIOS Update Guide</i>	<i>G-1</i>
<i>Appendix H. Hardware Monitoring (The Winbond Hardware Doctor Utility)</i> ..	<i>H-1</i>
<i>Appendix I. Installation Guide for Suspend to RAM</i>	<i>I-1</i>
<i>Appendix J. Troubleshooting (Need Assistance?)</i>	<i>J-1</i>
<i>Appendix K. How to Get Technical Support</i>	<i>K-1</i>



IC7-MAX3 快速安裝指引

如您要瞭解此主機板更詳細的資訊，請參閱我們的完整版使用手冊，裡面會有詳盡的說明。此快速安裝手冊是給有經驗的系統組裝者使用，如果這是您第一次嘗試來組裝您的電腦系統，我們建議您先去閱讀完整版的使用手冊，或是詢問技術人員來幫助您組裝您的電腦系統。（完整版的使用手冊已包覆在隨本主機板所附的驅動程式與應用光碟之中。）

安裝處理器的散熱片以及風扇組件

本主機板提供零出力 (Zero Insertion Force, ZIF) 式 Socket 478，以方便安裝 Intel® Pentium® 4 CPU。您所購買的 CPU 應已配備一組散熱套件及散熱片，如果沒有，請購買專為 Pentium® 4 Socket 478 設計的散熱套件及散熱片。

1. 請在主機板上面找出 Socket 478 插座的位置，然後將固定模組基座固定在主機板上。

注意：如果您使用專門為英特爾 Pentium® 4 處理器所設計的機殼，請注意已經安裝在機箱上的金屬螺栓或是間隔卡榫。請小心不要讓金屬螺栓或是間隔卡榫接觸到印刷電路板上的線路或是零件。

2. 請將處理器插座的釋放拉桿向插座的外側拉出，然後將釋放拉桿以 90 度角的角度向上拉起，然後請您以正確的方向將處理器插入處理器插座。切勿太過施力地將處理器置入插座，因為您只能以一個固定的方向來將處理器插入。當處理器置入到處理器插座之後，請將插座釋放拉桿再下推到底即可。
3. 請將散熱片面朝下地置放到處理器的上面，直到散熱片完全地蓋住處理器為止。
4. 將風扇及其固定架機構組件覆蓋至散熱片上面。請確認風扇及其固定架機構組件四個邊角的鎖扣都已經卡入固定架的鎖孔位置。
5. 將風扇以及其固定架機構組件兩側的固定架鎖夾一起向下壓，以將其與固定模組基座上的鎖孔扣上。
6. 現在風扇及其固定架機構組件、固定模組基座和當中的散熱片都應該已經牢固地互相緊扣著。

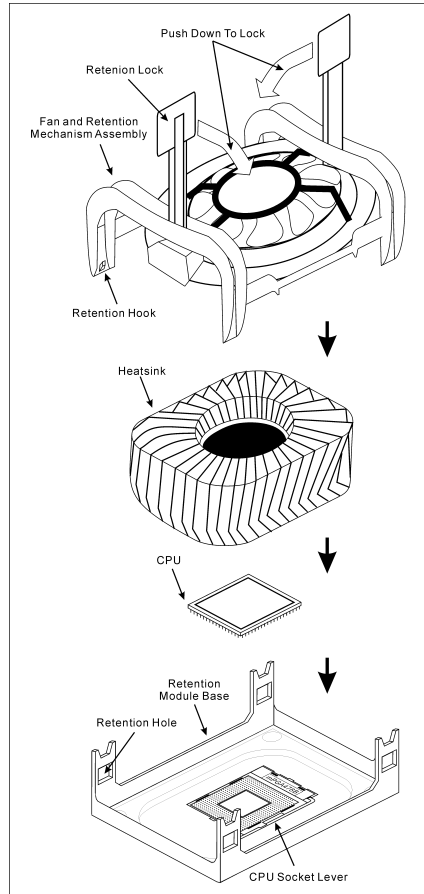

注意：請不要忘記去設定處理器正確的匯流排頻率和倍頻的數值。

將主機板安裝到機殼上

當您將處理器安裝到主機板上之後，您便可以開始將主機板固定到電腦機殼裡去。首先；請您先將主機板固定到電腦機殼。大多數的電腦機殼底座都有許多的固定孔位，請將主機板上的固定孔位與機殼底座上的固定孔位對準。如果孔能對準並且有螺絲孔，就表示可使用銅柱來固定主機板。另外；您可以使用塑膠墊片來讓螺絲與主機板的 PCB 表層隔離（絕緣）。

安裝記憶體模組

1. 找出您主機板上 DIMM 插槽的位置。
2. 請您小心地抓住 DIMM 模組的兩側，請勿碰觸其接點。
3. 請將記憶體模組上的榫子與 DIMM 插槽上的卡榫對準。
4. 穩固地施壓來將記憶體模組向下插入 DIMM 插槽，直到 DIMM 插槽兩側的模組固定夾自動地扣入記憶體模組的固定夾缺口為止。切勿太過施力地來將 DIMM 模組插入插槽，因為您只能以一個固定的方向來插入 DIMM 模組。
5. 要取出 DIMM 模組，請您向外側同時地壓下 DIMM 插槽兩側的模組固定夾，即可將 DIMM 模組抽取出來。

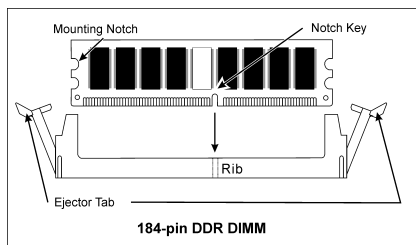

注意：靜電會造成電腦或是附加卡上電子元件的損壞，在您要進行這些程序之前，請確認您已經藉由暫時地接觸已接地的金屬物體來放掉您身上所帶有的靜電。

連接器、連接頭以及附加卡的安裝

在任何一部電腦機殼的裡面，都必需連接一些纜線與插頭。這些纜線與插頭通常都是一對一的連接至主機板的連接埠上，您必需注意任何一條纜線的連接方向。如果可能的話，請一併注意連接埠第一根針腳的位置。您將會安裝一些特殊功能的附加卡到主機板上，像是 SCSI 卡或是 AGP 顯示卡等等。當您將它們安裝到主機板上適當的插槽之後，請以螺絲將這些附加卡與機殼背板牢牢地固定好，避免有鬆動的情況發生。

如您想要瞭解相關且更為詳細的資訊，請參閱我們的完整版使用手冊，裡面會有詳盡的說明。

將電源供應器的電源線連接頭與主機板上的 ATX12V 電源接頭連接起來

請將電源供應器的 ATX 電源接頭確實地壓入主機板上的 ATX12V 電源接頭，並確定連接妥當。

BIOS 的設定

當您將所有的硬體安裝完畢以後，就可以開啓電腦的電源並進入 BIOS 的選項。如您想要瞭解相關且更為詳細的資訊，請參閱我們的完整版使用手冊，裡面會有詳盡的說明。

IC7-MAX3 のクイックインストールガイド

このマザーボードの詳細については、ユーザーズマニュアルの完全版を参照してください。このクイックインストールガイドは、経験あるシステム構築者向けに書かれました。今回始めてコンピュータシステムをセットアップする方は、まず完全版のマニュアルをお読みになるか、専門技術者に連絡してコンピュータシステムのセットアップを行うようお勧めします。(完全なユーザーズマニュアルはこのマザーボードに付属するドライブとユーティリティ CD を検索して入手できます。)

CPU ヒートシンクとファンアセンブリの取り付け

このマザーボードは ZIF (ゼロインサージョンフォース) Socket 478 を提供して Intel® Pentium® 4 CPU をインストールします。お買い上げになった CPU には、ヒートシンクと冷却ファンのキットが付属しています。付属していない場合、Pentium® 4 Socket 478 向けに特別に設計されたキットをお求めください。

1. マザーボードに 478 ピン ZIF ソケットが見つかったら、リテンションモジュールをマザーボードに固定します。

注意: Pentium® 4 マザーボードの用に特別に設計されたシャーシをご使用の場合、金属製スタッドやスペーサーがすでにシャーシに取り付けられていれば、その場所に注意してください。金属製スタッドやスペーサーが PCB の印刷回路線や部品に接触しないように用心してください。

2. ソケットから CPU のソケットレバーを横に、それから 90 度上に引っ張ります。CPU を正しい方向に差し込みます。CPU は一方向にしかフィットしないため、CPU を差し込む際に余分な力をかけないでください。CPU を押さえながらソケットレバーを閉めます。
3. ヒートシンクを CPU にすっぽりかぶせます。
4. ファンとリテンションメカニズムアセンブリをヒートシンクの上に置きます。ファンとリテンションメカニズムアセンブリの各サイドのリテンションロックが、4 つともリテンションホールにはめ込まれていることを確認してください。
5. ファンとリテンションメカニズムアセンブリの両側にあるリテンションロックを押下げて、リテンションモジュール台にしっかり固定します。
6. これでファンとリテンションメカニズムアセンブリとリテンションモジュール台の各サイドが、内部のヒートシンクにしっかり固定されました。

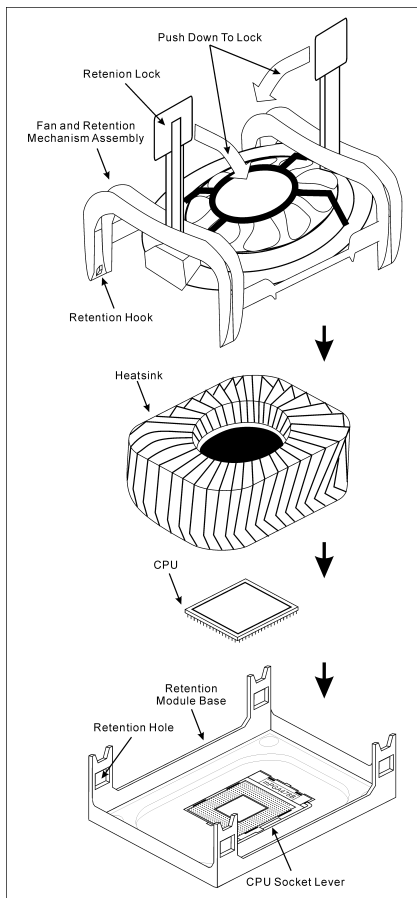

注意：正しいバス周波数と倍数をプロセッサ用に設定するのを忘れないでください。

マザーボードをシャーシに取り付ける

マザーボードにプロセッサを取り付けた後、シャーシにマザーボードを固定することができるようになります。まず、シャーシにマザーボードを固定する必要があります。ほとんどのコンピュータシャーシには、多くの取り付け穴の付いた台が付属しており、それを使用することでマザーボードをしっかりと取り付けたり、同時にショートを避けることができます。シャーシに付属する飾りボタンかスペーサーを使用してマザーボードを固定します。

RAM モジュールの取り付け

1. ボードの DIMM スロットを探します。
2. DIMM モジュールの 2 つのエッジがそのコネクタに触れないように、注意して持ちます。
3. モジュールのノッチキーをスロットのリップに合わせます。
4. モジュールをスロットにしっかりと押し込むと、スロットの両側にあるイジェクトタブが取り付けノッチにかちと音を立てて自動的にはめ込まれます。DIMM モジュールに余分な力をかけないでください。DIMM モジュールは一方方向にしかフィットしません。
5. DIMM モジュールは、スロットの 2 つのイジェクトタブを外側に同時に引っ張ると外れます。

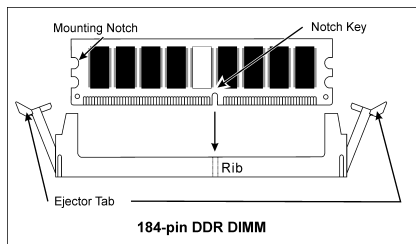

注意：静電気はコンピュータやオプションのボードの電気コンポーネントを損傷させることがあります。これらの手順を開始する前に、アースされた金属物体に軽く触れて静電気を必ず放電してください。

コネクタ、ヘッダ、スイッチおよびアダプタ

コンピュータのケース内部には、複数のケーブルやプラグを接続できます。これらのケーブルやプラグは、通常マザーボードにあるコネクタに 1 つずつ接続されます。ケーブルの接続方向には十分な注意を払い、また必要に応じて、コネクタの第 1 ピンの位置にも注目する必要があります。SCSI アダプタ、AGP アダプタのような特殊なニーズ向けには、それに対応したアダプタを取り付けてください。アダプタをマザーボードのスロットに取り付けたら、ネジでシャーシの背面パネルに固定してください。

詳細については、ユーザーズマニュアルの完全版を参照してください。

電源コネクタを ATX12V 電源コネクタに差し込む

電源装置から出ている電源ブロックコネクタをこの ATX12V 電源に接続します。コネクタが十分奥まで装着されていることをご確認ください。

BIOS のセットアップ

ハードウェアの取り付けが完了したら、コンピュータの電源をオンにし、BIOS Setup アイテムに移動して、プロセッサのパラメータをセットアップします。詳細については、ユーザーズマニュアルの完全版を参照してください。

IC7-MAX3 Schnellinstallationsanleitung

Beziehen Sie sich bitte für detaillierte Informationen über diese Hauptplatine auf die vollständige Version des Benutzerbuchs. Diese Schnellinstallationsanleitung ist für erfahrene Systemaufbauer gedacht. Ist es Ihr erster Versuch ein Computersystem aufzubauen, dann empfehlen wir Ihnen zuerst das vollständige Benutzerhandbuch zu lesen oder einen Techniker zum Aufbauen des Systems zu Hilfe zu holen. (Ein komplettes Handbuch finden Sie auf der CD mit den Treibern und Hilfsprogrammen, die diesem Motherboard beiliegt.)

Installation von CPU-Kühlblech & Lüftereinheit

Dieses Motherboard verfügt über einen ZIF (Zero Insertion Force) Sockel 478 zur Installation eines Intel® Pentium® 4 CPU. Ihre CPU sollte über ein Kühlblech und einen Lüfter verfügen. Wenn dies nicht der Fall ist, kaufen Sie bitte diese Teile speziell für den Pentium® 4 Sockel 478.

1. Finden Sie den 478-polige ZIF-Sockel auf dem Motherboard. Befestigen Sie die Basis des Haltemoduls auf dem Motherboard.

Achtung: Wenn Sie ein speziell für den Pentium® 4 konstruiertes Gehäuse verwenden, achten Sie bitte auf die Lage der Metallbolzen bzw. Abstandhalter, wenn sie schon im Gehäuse installiert sind. Achten Sie darauf, dass kein Kontakt zwischen Metallbolzen bzw. Abstandhalter und den gedruckten Schaltkreisen bzw. leitfähigen Teilen auf dem PCB entsteht.

2. Ziehen Sie den Hebel des Prozessorsockels seitwärts vom Sockel und dann im 90 Grad-Winkel nach oben. Setzen Sie den Prozessor mit der korrekten Ausrichtung hinein. Wenden Sie keine Gewalt beim Einsetzen des Prozessors ein; er passt nur in eine Ausrichtung hinein. Drücken Sie den Sockelhebel wieder herunter, während Sie den Prozessor heruntergedrückt halten.
3. Setzen Sie das Kühlblech mit der Oberseite nach unten auf den Prozessor, bis es den Prozessor völlig abdeckt.
4. Setzen Sie die Kühlblechabdeckung und die Haltemechanismus-Einheit auf das Kühlblech. Vergewissern Sie sich, dass alle vier Halteklammern zu jeder Seite der Abdeckung in die Haltelöcher greifen.
5. Drücken Sie den Halteclip auf beiden Seiten von Lüfter und Haltemechanismuseinheit nieder, bis er in die Basis des Haltemoduls einschnappt.
6. Lüfter und Haltemechanismus-Einheit und die Basis des Haltemoduls sollten nun fest miteinander verriegelt sein und das Kühlblech sich in ihrem Innern befinden..

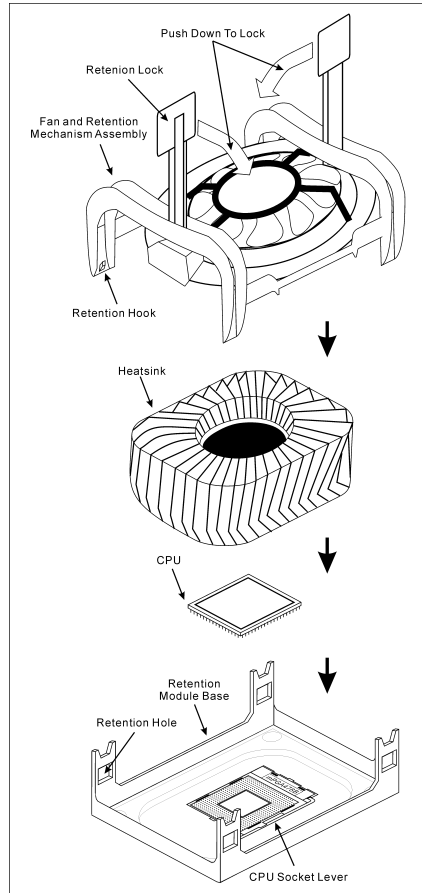

Achtung: Vergessen Sie nicht, die korrekte Busfrequenz und -Multiplikator für Ihren Prozessor einzustellen.

Installieren der Hauptplatine im Gehäuse

Nach der Installation des Prozessors können Sie anfangen die Hauptplatine im Computergehäuse zu befestigen. Die meisten Gehäuse haben eine Bodenplatte, auf der sich eine Reihe von Befestigungslöcher befinden, mit deren Hilfe Sie die Hauptplatine sicher verankern können und zugleich Kurzschlüsse verhindern. Verwenden Sie entweder die Dübeln oder die Abstandhalter, um die Hauptplatine auf der Bodenplatte des Gehäuses zu befestigen.

Installation der RAM-Module

1. Finden Sie den DIMM-Steckplatz auf dem Board.
2. Halten Sie ie beiden Ränder des DIMM-Moduls vorsichtig fest, wobei Sie darauf achten, nicht die Anschlüsse zu berühren.
3. Richten Sie die Nut am Modul mit der Erhöhung am Steckplatz aus.
4. Drücken Sie das Modul fest in die Steckplätze, bis die Auswurf flaschen zu beiden Seiten des Steckplatzes automatisch in die Befestigungs kerbe einschnappen. Wenden Sie keine Gewalt beim Einsetzen des DIMM-Moduls an; es paßt nur in eine Richtung hinein.
5. Zum Ausbau der Module drücken Sie die beiden Auswurf flaschen auf dem Steckplatz nach außen zusammen und ziehen das Modul heraus.

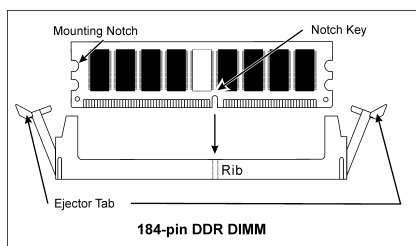

Anschlüsse, Sockel, Schalter und Adapter

Im Inneren des Gehäuses findet man in jedem Computer viele Kabel und Stecker, die angeschlossen werden müssen. Diese Kabel und Stecker werden normalerweise einzeln mit den Anschlüssen auf der Hauptplatine verbunden. Sie müssen genau auf die Anschlussorientierung der Kabel achten und, wenn vorhanden, sich die Position des ersten Pols des Anschlusses merken. Wenn Sie Adapter wie z.B. SCSI-Adapter, AGP-Adapter usw. installieren, befestigen Sie bitte die Adapter immer mit Hilfe der Schrauben auf die Rückseite des Computergehäuses.

Für detaillierte Informationen beziehen Sie sich bitte auf das vollständige Benutzerhandbuch.

Verbinden der Netzstecker mit dem ATX12V-Anschluss

Denken Sie daran, den Anschluss des ATX-Netzteils fest in das Ende mit dem ATX12V-Anschluss zu drücken, um eine feste Verbindung zu garantieren.

BIOS-Setup

Schalten Sie nach der vervollständigten Hardwareinstallation den Computer ein und gehen zur Option im BIOS, um die Prozessorparameter einzustellen. Für detaillierte Informationen beziehen Sie sich bitte auf das vollständige Benutzerhandbuch.

IC7-MAX3 Guide d'Installation Rapide

Pour des informations relatives à cette carte mère plus détaillées, veuillez vous référer à notre version complète du manuel utilisateur. Ce guide d'installation rapide est créé pour les assembleurs système expérimentés. S'il s'agit de votre premier essai pour installer un ordinateur, nous vous suggérons de lire d'abord le manuel en version complète ou de demander l'aide d'un technicien pour vous aider à configurer le système ordinateur. (Un manuel de l'utilisateur complet est disponible en naviguant dans le CD des pilotes et utilitaires fournis avec la carte mère.)

Installer le Dissipateur de Chaleur du CPU et l'Assemblage du Ventilateur

Cette carte mère fournit un support ZIF (Zero Insertion Force) Socket 478 permettant d'installer le Microprocesseur Intel® Pentium® 4. Le microprocesseur que vous achetez doit être muni d'un système de refroidissement avec dissipateur thermique et ventilateur. Dans le cas contraire, veuillez en acheter un, conçu spécialement pour les microprocesseurs Pentium® 4 Socket 478.

1. Localisez le socle ZIF 478-broches sur la carte-mère. Serrez la Base du Module de Rétention sur la carte.

Attention: Si vous utilisez un châssis spécialement conçu pour Pentium® 4, veuillez faire attention à l'emplacement des Clous en Métal ou des Espaces installés sur le châssis. Ne laissez jamais les Clous en Métal ou les Espaces entrer en contact des circuits imprimés ou des composants sur le PCB.

2. Tirez le levier du socle CPU sur les côtés jusque sur un angle d'environ 90. Insérez le CPU avec l'orientation correcte. N'utilisez pas trop de force pour insérer le CPU; il n'ira que selon une seule orientation. Refermez ensuite le levier du socle tout en maintenant le CPU.
3. Placez le dissipateur de chaleur face vers le bas dans le CPU jusqu'à ce qu'il recouvre celui-ci complètement.
4. Placez le Ventilateur et l'Assemblage du Mécanisme de Retient dans le dissipateur de chaleur. Assurez-vous que les quatre Verrous de Retient sur chaque côté du Ventilateur et du Mécanisme de Retient dans les Trous de Retient.
5. Pressez le Verrou de Retient sur les deux côtés du Ventilateur et du Mécanisme de Retient pour verrouiller ensemble avec la Base du Module de Retient.
6. Le Ventilateur, le Mécanisme de Retient et la Base du Module de Retient doivent maintenant être verrouillés l'un sur l'autre avec le dissipateur de chaleur à l'intérieur.

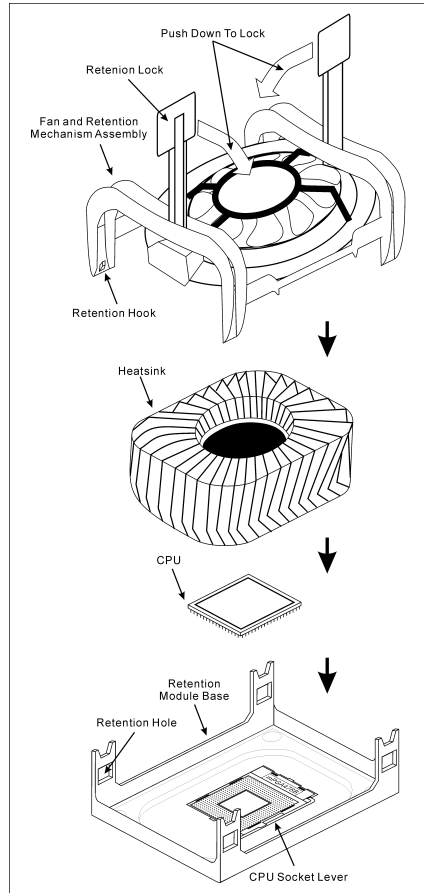

Attention: N'oubliez pas de programmer la fréquence de bus correcte et le multiple pour votre processeur.

Installer la Carte Mre dans le Châssis

Une fois que vous aurez installé le processeur sur la carte mère, vous pourrez commencer à fixer la carte mère sur le châssis. Tout d'abord, vous avez besoin de fixer la carte mère sur le châssis. La plupart des châssis d'ordinateur possèdent une base sur laquelle il y a nombreux trous de montage permettant à la carte mère d'être fixée fermement, et en même temps d'éviter les court-circuits. Utilisez les talons ou les entretoises fixés sur le châssis pour fixer la carte mère.

Installer des Modules RAM

1. Localisez le socle DIMM sur la carte.
2. Maintenez les deux bords du module DIMM avec précaution, en évitant de toucher ses connecteurs.
3. Alignez la touche du cran avec la ligne sur le socle.
4. Pressez fermement le module dans les socles jusqu'à ce que les languettes d'éjection sur les deux côtés du socle aillent automatiquement dans le cran de montage. Ne forcez pas à l'excès sur le module DIMM car celui-ci ne peut aller que selon une seule orientation.
5. Pour enlever des modules DIMM, pressez simultanément les deux languettes d'éjection sur le socle, puis sortez le module DIMM.

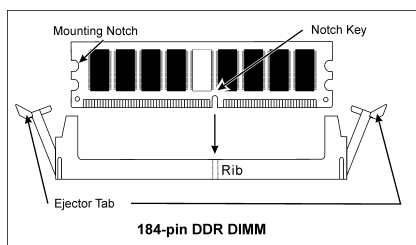

Attention: L'électricité statique risque d'endommager les composants électroniques de l'ordinateur ou des cartes optionnelles. Avant de commencer ces procédures, assurez-vous de bien décharger toute l'électricité statique en touchant rapidement un objet métallique relié au sol.

Connecteurs, Socles de connexion, Interrupteurs et Adaptateurs

A l'intérieur du boîtier de n'importe quel ordinateur il y a plusieurs câbles et prises qui doivent être connectés. Ces câbles et prises sont habituellement connectés les uns après les autres aux connecteurs situés sur la carte mère. Vous avez besoin de faire attention au sens de connexion des câbles et, s'il y a lieu, remarquez la position de la première broche du connecteur. Vous installerez certains adaptateurs pour des besoins spéciaux, tels adaptateurs SCSI, adaptateurs AGP, etc. Lorsque vous les installez dans les emplacements situés sur la carte mère, veuillez les fixer sur le panneau arrière du châssis à l'aide des vis.

Pour les informations détaillées, veuillez vous référer au manuel utilisateur en version complète.

Brancher les connecteurs d'alimentation dans les connecteurs ATX12V

Souvenez-vous que vous devez pousser le connecteur de votre alimentation fermement dans le connecteur ATX12V pour assurer une bonne connexion.

Configuration du BIOS

Une fois le matériel installé complètement, démarrez l'ordinateur et allez sur l'item dans le BIOS pour configurer les paramètres du processeur. Pour les informations détaillées, veuillez vous référer à la version complète du manuel utilisateur.

Краткое руководство по установке IC7-MAX3

Более подробные сведения о материнской плате приведены в руководстве пользователя. Краткое руководство по установке предназначено для опытных специалистов. Если вы собираете компьютер впервые, ознакомьтесь сперва с руководством пользователя или попросите техника помочь в настройке компьютерной системы.

Установка радиатора и вентилятора охлаждения процессора

На этой системной плате используется гнездо ZIP (с нулевым усилием установки) типа 'Socket 478' для процессора Intel® Pentium® 4. В комплект приобретаемого процессора должны входить радиатор и вентилятор. В противном случае следует приобрести радиатор и вентилятор, предназначенные для процессора Pentium® 4 с разъемом 'Socket 478'.

1. Найдите на системной плате 478-выводной разъем типа ZIF. Закрепите основание радиатора на системной плате.

Внимание: Устанавливая плату в корпус, разработанный специально для Pentium® 4, обратите внимание на уже установленный крепеж (металлические стойки, зажимы). Убедитесь, что установленный крепеж не касается системной платы или ее выводов.

2. Оттяните рычаг фиксации процессора в сторону и поднимите его на 90 градусов вверх. Расположив процессор соответствующим образом, вставьте его в разъем. Не прилагайте излишних усилий, чтобы вставить процессор. Процессор легко устанавливается, если вы правильно совместили его с разъемом. Установив процессор, опустите рычаг фиксации процессора на место.
3. Положите на процессор радиатор так, чтобы он полностью накрывал процессор.
4. Положите на радиатор вентилятор и фиксирующий механизм. Убедитесь, что все четыре фиксатора вентилятора и фиксирующего механизма вошли в предназначенные отверстия и защелкнулись.
5. Зафиксируйте вентилятор на основании радиатора, опустив рычажки, расположенные с обеих сторон фиксирующего механизма.
6. Вентилятор, фиксирующий механизм и основание радиатора должны быть надежно закреплены вместе с вентилятором.

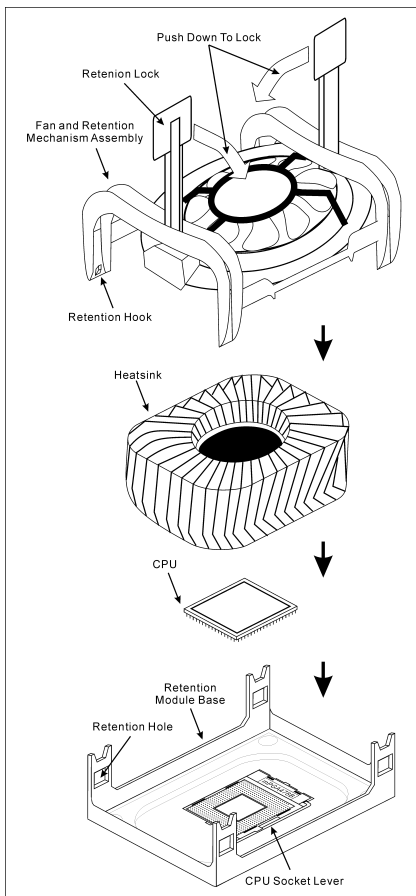

Внимание: Установите соответствующие частоту и кратность шины процессора.

Установка материнской платы в корпус

После установки процессора на материнскую плату можно начинать установку материнской платы в корпус. Большая часть корпусов оборудована основанием, в котором проделаны монтажные отверстия, которые позволяют надежно закрепить материнскую плату и предотвратить короткие замыкания. Для крепления материнской платы к основанию используются винты и прокладки.

Установка модулей памяти

1. Найдите на системной плате разъем для модулей памяти DIMM.
2. Аккуратно, за два конца, возьмите модуль памяти, не касаясь контактов.
3. Совместите выемку в модуле памяти с выступом в разьеме.
4. Нажмите на модуль так, чтобы лепестки выталкивателя с обеих сторон разъема автоматически защелкнулись и вошли в пазы. Не применяйте при установке излишнюю силу. Модуль входит в разъем только в одном положении.
5. Для извлечения модулей памяти DIMM одновременно нажмите на лепестки выталкивателя и вытащите модуль.

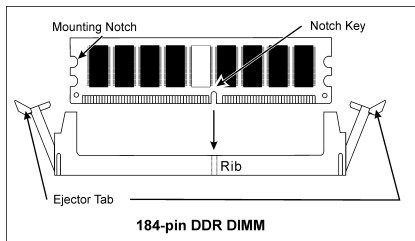

Внимание: Статическое электричество может стать причиной выхода из строя электронных компонентов компьютера. Перед началом данной процедуры снимите с себя статический заряд, коснувшись заземленного металлического предмета.

Разъемы, переключатели и адаптеры

Внутри корпуса компьютера необходимо расположены несколько кабелей и вилок, которые необходимо подключить. Обычно эти кабели подключаются к разъемам, расположенным на материнской плате. При подключении любого кабеля необходимо обращать внимание на расположение первого контакта разъема. Для особых целей могут потребоваться специальные адаптеры, например, адаптер SCSI, адаптер AGP и т.п.. При установке адаптеров в гнезда материнской платы закрепите их на задней панели с помощью винтов.

За более подробной информацией обращайтесь к полному руководству пользователя.

Подключение кабелей питания к разъемам ATX12V

Обратите внимание, разъем блока питания ATX необходимо вставить в разъем ATX12V до упора, чтобы обеспечить надежное соединение.

Настройка BIOS

По окончании установки аппаратуры включите питание и перейдите в меню BIOS Setup, чтобы настроить параметры процессора. За более подробной информацией обращайтесь к руководству пользователя.

Guida all'installazione veloce Scheda madre IC7-MAX3

Per maggiori e dettagliate informazioni su questa scheda madre si prega di fare riferimento alla versione integrale del Manuale utente. Questa guida all'installazione veloce è intesa per costruttori esperti di sistemi. Se questa è la prima volta che si cerca di installare un sistema, si consiglia di leggere, innanzi tutto, la versione integrale del manuale oppure di chiedere aiuto ad un tecnico per l'installazione.

Installare il dissipatore di calore CPU ed il gruppo della ventolina

Questa scheda madre fornisce una presa "Socket 478" ZIF (Zero Insertion Force – forza d'inserimento zero) per installare il processore Intel® Pentium® 4. Il processore acquistato dovrebbe essere fornito di dissipatore di calore e ventolina per il raffreddamento. In caso contrario acquistare un dissipatore di calore specifico per la presa Socket 478 Pentium®.

1. Ubicare la presa ZIF a 478 pin sulla scheda madre. Stringere la base del modulo di trattenimento sulla scheda madre.

Attenzione: Se si impiega un telaio progettato specificatamente per il processore Pentium® 4, si prega prestare attenzione all'ubicazione delle guarnizioni metalliche o degli spaziatori, nel caso in cui siano già installati sul telaio. Assicurarsi di non permettere alle guarnizioni metalliche od agli spaziatori di entrare in contatto con il cavo o con le parti del circuito sul PCB.

2. Tirare di lato la leva della presa CPU, allontanandola dalla presa; poi sollevarla di 90 gradi. Inserire la CPU con l'orientamento corretto. Non sforzare per inserire la CPU poiché si adatta solamente in un dato orientamento. Chiudere la leva della presa trattenendo la CPU.
3. Mettere il dissipatore di calore a faccia in giù sulla CPU finché la copre completamente.
4. Mettere la ventolina ed il gruppo del meccanismo di trattenimento sul dissipatore di calore. Assicurarsi che tutti i quattro fermi di trattenimento, su ciascun lato della ventolina e del gruppo del meccanismo di trattenimento, scattino in posizione nei fori di trattenimento.
5. Spingere verso il basso i fermi di trattenimento su entrambi i lati della ventolina e del gruppo del meccanismo di trattenimento per fissarli con la base del modulo di trattenimento.
6. La ventolina, il gruppo del meccanismo di trattenimento e la base del modulo di trattenimento ora dovrebbero essere fissati gli uni agli altri trattenendo al loro interno il dissipatore di calore.

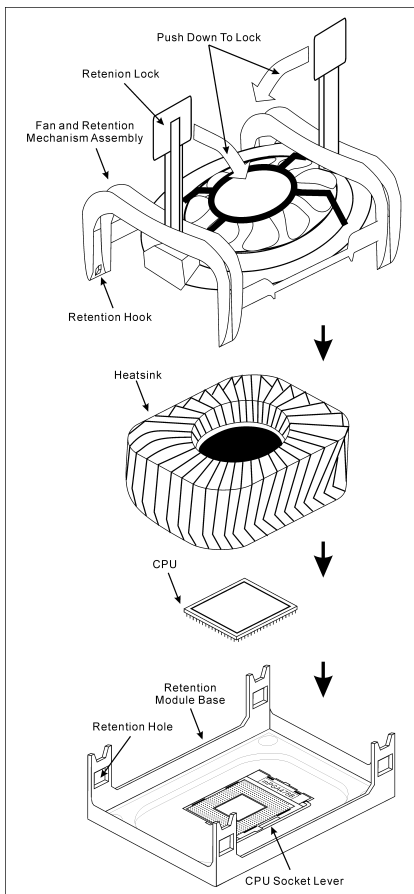

Attenzione: Non dimenticare di impostare la corretta frequenza multipla e BUS per il processore.

Installazione della scheda madre sul telaio

Dopo avere installato il processore sulla scheda madre si può iniziare a fissare la scheda madre sul telaio. Innanzi tutto è necessario fissare la scheda madre al telaio. La maggior parte dei telai ha una base sulla quale sono presenti diversi fori di montaggio che permettono di fissare in modo accurato la scheda madre e, allo stesso tempo, di prevenire corto circuiti. Impiegare le borchie o gli spaziatori attaccati al telaio per fissare la scheda madre.

Installare i moduli RAM

1. Ubicare gli alloggiamenti DIMM sulla scheda.
2. Tenere con delicatezza i lati del modulo DIMM senza toccare i connettori.
3. Allineare la tacca sul modulo con la nervatura dell'alloggiamento.
4. Premere con fermezza il modulo nell'alloggiamento finché le linguette d'espulsione su entrambi i lati dell'alloggiamento scattano sulla tacca di montaggio. Non forzare eccessivamente il modulo DIMM perché quest'ultimo si adatta solamente in una direzione.
5. Per rimuovere i moduli DIMM spingere contemporaneamente le due linguette d'espulsione sull'alloggiamento, poi estrarre il modulo DIMM.

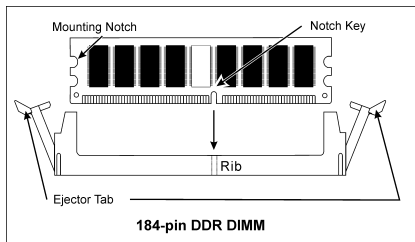

Attenzione: L'elettricità statica può danneggiare i componenti elettronici del computer o delle schede. Prima di iniziare queste procedure, assicurarsi di avere scaricato completamente l'elettricità statica toccando brevemente un oggetto metallico con massa a terra.

Connettori, collettori, interruttori ed adattatori

All'interno della copertura di ogni computer ci sono diversi cavi e prese che devono essere collegati. Questi cavi e prese sono solitamente collegati uno ad uno ai connettori situati sulla scheda madre. E' necessario prestare particolare attenzione a qualunque orientamento del collegamento che possono avere i cavi e, se necessario, notare la posizione del primo pin del connettore. Si installeranno alcuni adattatori per particolari necessità quali l'adattatore SCSI, AGP, eccetera. Quando si installano gli adattatori sugli slot della scheda madre, si ricorda di fissarli con le viti anche sul pannello posteriore del telaio.

Per informazioni dettagliate si prega di fare riferimento alla versione integrale del Manuale utente.

Collegamento dei connettori d'alimentazione ai connettori ATX12V

Ricordarsi che è necessario spingere con fermezza fino in fondo il connettore della sorgente d'alimentazione ATX al connettore ATX12V, assicurando così un buon collegamento.

Impostazione BIOS

Quando l'hardware è stato installato completamente, accendere il computer ed andare alla voce BIOS per impostare i parametri del processore. Per informazioni dettagliate si prega di fare riferimento alla versione integrale del Manuale utente.



Chapter 1. Introduction

1-1. Features & Specifications

1. CPU

- Supports Intel Pentium 4 Socket 478 processor with 800MHz, 533MHz (for Northwood & Prescott), and 400MHz (for Northwood only) System Data Bus
- Supports Intel Hyper-Threading Technology

2. Chipset

- Intel 82875P (MCH) + 82801ER (ICH5R)
- Supports dual channel DDR 400/333/266 with ECC function and “Performance Acceleration Technology (PAT)”
- Supports Hi-Speed Universal Serial Bus (USB 2.0)
- Supports Ultra ATA/100/66/33 mode

3. Memory

- 4x 184-pin DIMM sockets
- Supports 4 DIMM Single/Dual Channel DDR 400/333/266 (Max. 4GB)
- Supports configurable ECC function

4. AGP

- Accelerated Graphics Port connector supports AGP PRO 8X/4X Interface (0.8V/1.5V)

5. LAN

- Onboard Intel CSA Gigabit LAN

6. Dual Serial ATA RAID

- 2 channels of Serial ATA 150MB/s data transfer rate with RAID function (RAID 0/RAID 1) via ICH5R South Bridge
- 4 channels of Serial ATA 150MB/s data transfer rate with RAID function (RAID 0/ RAID 1/ RAID 0+1) via Silicon Image PCI Chip

7. Media XP (Optional)

- Supports card reader function for Memory Stick, Secure Digital and Type I/II CompactFlash
- Supports Wireless Remote Control and S/PDIF Out / Mic In / Headphone Out / USB 2.0 / IEEE 1394

8. USB 2.0

- 8x USB 2.0 ports support 480 Mb/s data transfer rate

9. IEEE 1394

- Supports IEEE 1394a at 400/200/100 Mb/s data transfer rate

10. Audio

- Onboard RealTek ALC650 6-Channel AC 97 CODEC

- Professional digital audio interface supports 24-bit S/PDIF Input/Output

11. System BIOS

- SoftMenu™ Technology to set CPU parameters
- Supports Plug-and-Play (PNP)
- Supports Advanced Configuration Power Interface (ACPI)
- Supports Desktop Management Interface (DMI)
- Write-Protect Anti-Virus function by AWARD BIOS

12. Internal I/O Connectors

- 1x AGP PRO slot
- 5x PCI slots
- 1x Floppy port supports up to 2.88MB
- 2x Ultra ATA/100/66/33 connectors
- 6x Serial ATA 150 connectors
- 2x USB 2.0 headers
- 2x IEEE 1394a headers
- 1x CD-IN, 1x AUX-IN header

13. Back Panel I/O

- 1x PS/2 Keyboard, 1x PS/2 mouse
- 1x S/PDIF In connector
- 1x S/PDIF Out connector
- AUDIO1 connector (Rear-Left / Rear-Right, Center/Subwoofer)
- AUDIO2 connector (Mic-In, Line-In, Front-Left/Front-Right)
- 2x USB 2.0, 1x IEEE 1394 Connector
- 2x USB 2.0, 1x RJ-45 LAN Connector

14. Miscellaneous

- ATX form factor
 - Hardware Monitoring – including Fan Speed, Voltages, CPU and system temperature
 - Supports Wake Up by LAN, Modem Ring, RTC Alarm, Keyboard and Mouse Power On
 - Supports STR (Suspend to RAM)
- * **Supports Wake On LAN, Modem, but your ATX power supply 5V standby power must be able to provide at least a 720mA current capacity. Otherwise, the functions may not work normally.**
- * **Specifications and information contained herein are subject to change without notice.**

1-2. Layout Diagram

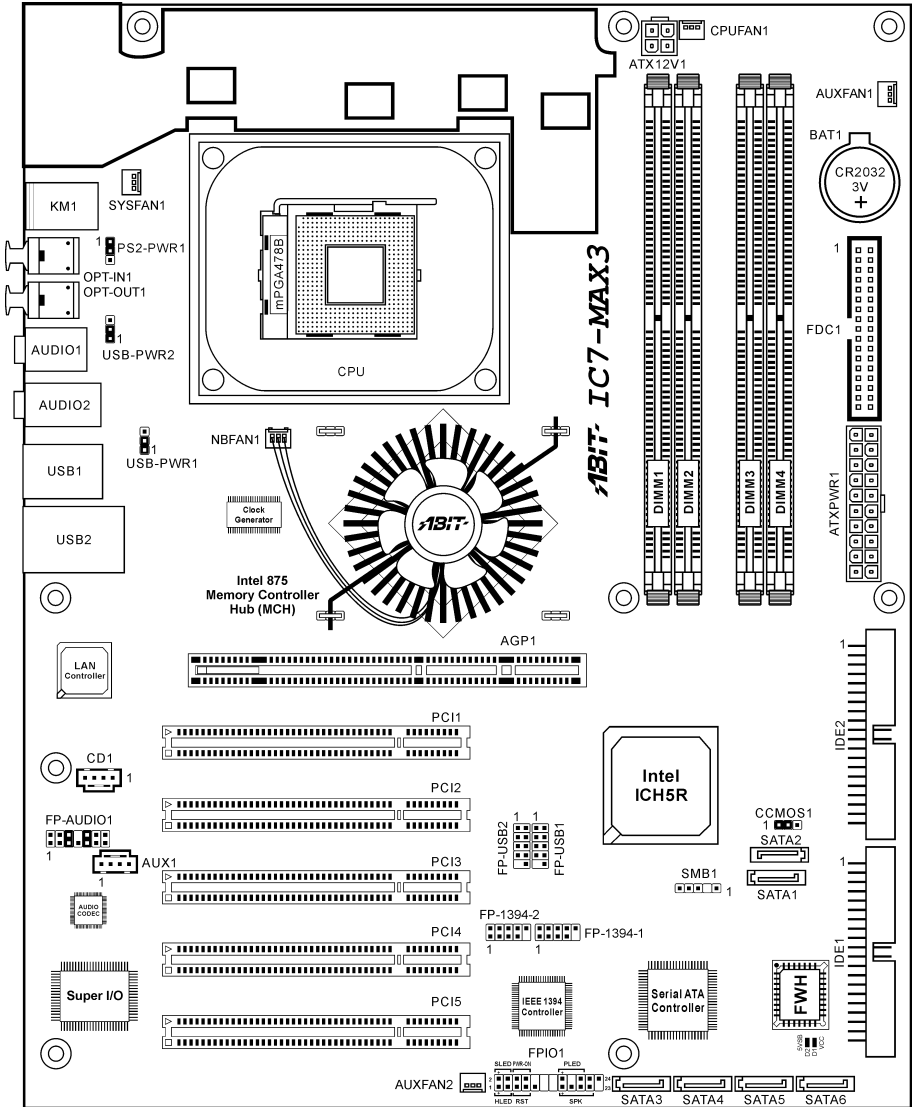



Chapter 2. Hardware Setup

Before the Installation: Turn off the power supply switch (fully turn off the +5V standby power), or disconnect the power cord before installing or unplugging any connectors or add-on cards. Failing to do so may cause the motherboard components or add-on cards to malfunction or damaged.

2-1. Install The Motherboard

Most computer chassis have a base with many mounting holes to allow motherboard to be securely attached on and at the same time, prevented from short circuits. There are two ways to attach the motherboard to the chassis base:

- 1. use with studs
- 2. or use with spacers

In principle, the best way to attach the board is to use with studs. Only if you are unable to do this should you attach the board with spacers. Line up the holes on the board with the mounting holes on the chassis. If the holes line up and there are only slots, you can attach the board with studs. If the holes line up and there are only slots, you can only attach with spacers. Take the tip of the spacers and insert them into the slots. After doing this to all the slots, you can slide the board into position aligned with slots. After the board has been positioned, check to make sure everything is OK before putting the chassis back on.

ATTENTION: To prevent shorting the PCB circuit, please REMOVE the metal studs or spacers if they are already fastened on the chassis base and are without mounting-holes on the motherboard to align with.

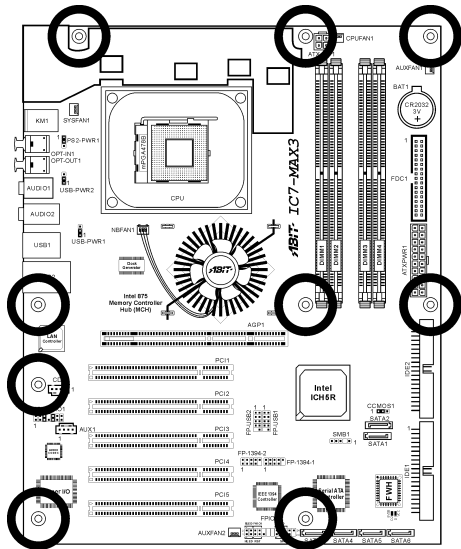
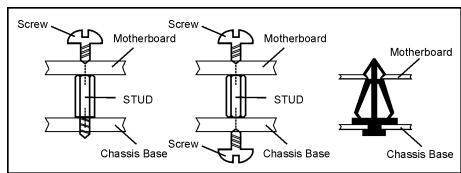

2-2. Install Pentium® 4 CPU and Heatsink Supporting-Base

This motherboard provides a ZIF (Zero Insertion Force) Socket 478 to install Intel® Pentium® 4 CPU. The CPU you bought should have a kit of heatsink and cooling fan along with. If that's not the case, buy one specially designed for Pentium® 4 Socket 478.

1. Locate the 478-pin ZIF socket on the motherboard. Fasten the Retention Module Base onto the motherboard.

ATTENTION: If you are using chassis specially designed for Pentium® 4, please pay attention to the location of metal studs or spacers if they are already installed on the chassis. Be careful not let the metal studs or spacers contact the printed circuit wire or parts on the PCB.

2. Pull the CPU socket lever sideways away from the socket and then upwards to 90 degree. Insert the CPU with the correct orientation. Do not use extra force to insert CPU; it only fits in one orientation. Close down the socket lever while holding down the CPU.
3. Put the heatsink faces down onto the CPU until it completely covers the CPU.
4. Put the Fan and Retention Mechanism Assembly onto the heatsink. Make sure all the four Retention Locks at each side of the Fan and Retention Mechanism Assembly snap into the Retention Holes.
5. Push down the Retention Lock at both sides of the Fan and Retention Mechanism Assembly to lock up together with the Retention Module Base.
6. The Fan and Retention Mechanism Assembly and Retention Module Base should now firmly lock up with each other with the heatsink inside.

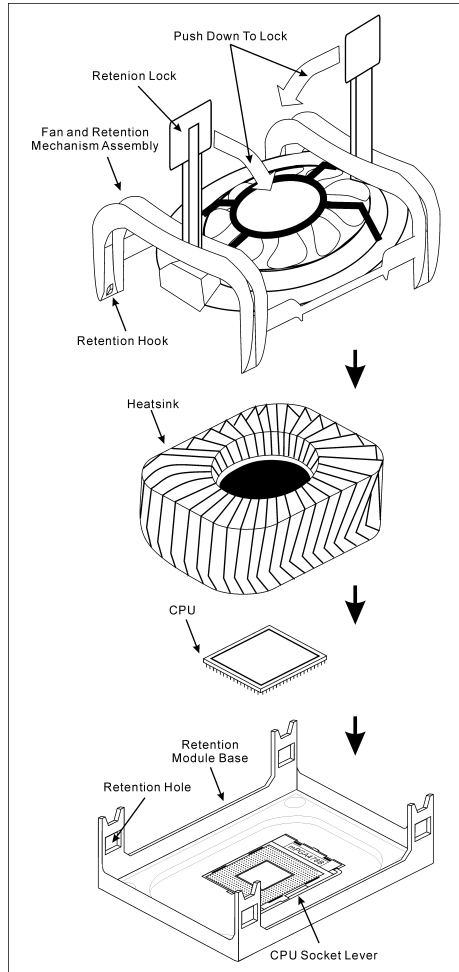

ATTENTION: Do not forget to set the correct bus frequency and multiple for your processor.

2-3. Install System Memory

This motherboard provides four 184-pin DDR DIMM slots for Single/Dual Channel DDR 400/333/266 memory modules with memory expansion size up to 4GB.

To reach the performance of Dual Channel DDR, the following rules must be obeyed:

- **When installing TWO DIMM modules:** Install DIMM modules of the same type and size for slots [DIMM1]+[DIMM3] or slots [DIMM2]+[DIMM4].
- **When installing FOUR DIMM modules:** Install DIMM modules of the same type and size for slots [DIMM1]+[DIMM3], and slots [DIMM2]+[DIMM4].

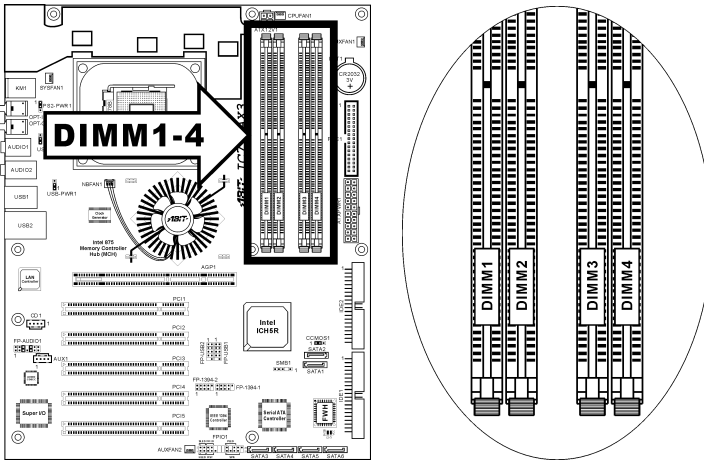

Table 2-1. Valid Memory Configurations

Bank	Memory Module	Total Memory
Bank 0, 1 (DIMM1)	128, 256, 512MB, 1GB	128MB ~ 1GB
Bank 2, 3 (DIMM2)	128, 256, 512MB, 1GB	128MB ~ 1GB
Bank 4, 5 (DIMM3)	128, 256, 512MB, 1GB	128MB ~ 1GB
Bank 6, 7 (DIMM4)	128, 256, 512MB, 1GB	128MB ~ 1GB
Total System Memory		128MB ~ 4GB

NOTE: No hardware or BIOS setup required after adding or removing memory modules.

Power off the computer and unplug the AC power cord before installing or removing memory modules.

1. Locate the DIMM slot on the board.
2. Hold two edges of the DIMM module carefully, keep away of touching its connectors.
3. Align the notch key on the module with the rib on the slot.
4. Firmly press the module into the slots until the ejector tabs at both sides of the slot automatically snaps into the mounting notch. Do not force the DIMM module in with extra force as the DIMM module only fit in one direction.

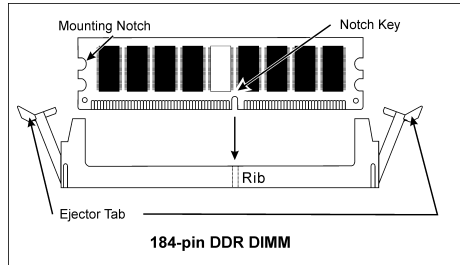

5. To remove the DIMM modules, push the two ejector tabs on the slot outward simultaneously, and then pull out the DIMM module.

ATTENTION: Static electricity can damage the electronic components of the computer or optional boards. Before starting these procedures, ensure that you are discharged of static electricity by touching a grounded metal object briefly.

2-4. Connectors, Headers and Switches

Here we will show you all of the connectors, headers and switches, and how to connect them. Please read the entire section for necessary information before attempting to finish all the hardware installation inside the computer chassis. A complete enlarged layout diagram is shown in Chapter 1 for all the position of connectors and headers on the board that you may refer to.

WARNING: Always power off the computer and unplug the AC power cord before adding or removing any peripheral or component. Failing to do so may cause severe damage to your motherboard and/or peripherals. Plug in the AC power cord only after you have carefully checked everything.

(1). ATX Power Input Connectors

The Pentium 4 requires a power supplier different from the regular one. It's a newly designed ATX12V power with 300W, 20A +5VDC capacity at least for heavily loaded system, and 720mA +5VSB at least for supporting Wake-On-LAN feature.

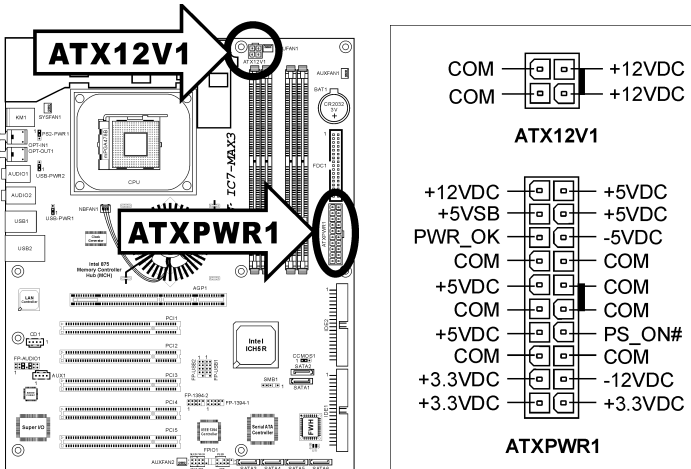

(2). **FAN Connectors**

These 3-pin connectors each provide power to the cooling fans installed in your system.

The CPU must be kept cool by using a powerful fan with heatsink. The system is capable of monitoring the speed of the CPU fan.

- **CPUFAN1:** CPU Fan
- **NBFAN1:** Chipset Fan
- **SYSFAN1:** OTES Fan
- **AUXFAN1, AUXFAN2:** Auxiliary Fan (No monitoring support in BIOS menu)

WARNING: These fan connectors are not jumpers. DO NOT place jumper caps on these connectors.

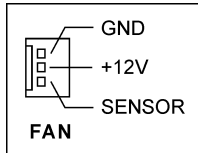
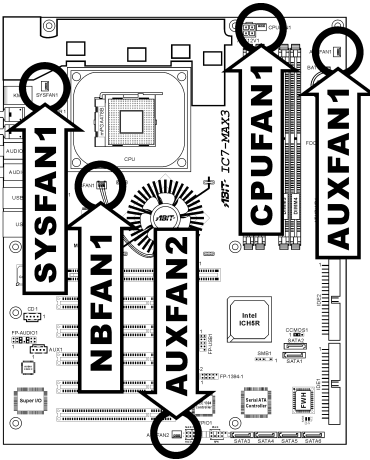

(3). CMOS Memory Clearing Header

This header uses a jumper cap to clear the CMOS memory.

- **Pin 1-2 shorted (default):** Normal operation.
- **Pin 2-3 shorted:** Clear CMOS memory.

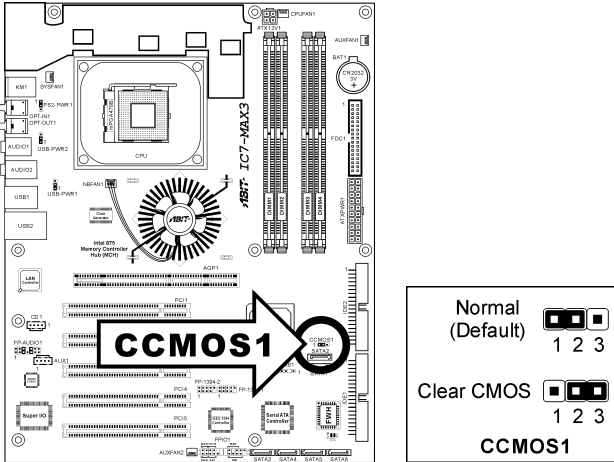

WARNING: Turn the power off first (including the +5V standby power) before clearing the CMOS memory. Failing to do so may cause your system to work abnormally or malfunction.

(4). Wake-up Header

These headers use a jumper cap to enable/disable the wake-up function.

- **PS2-PWR1:**
 Pin 1-2 shorted (default): Disable wake-up function support at Keyboard/Mouse port.
 Pin 2-3 shorted: Enable wake-up function support at Keyboard/Mouse port
- **USB-PWR1:**
 Pin 1-2 shorted (default): Disable wake-up function support at USB1 port.
 Pin 2-3 shorted: Enable wake-up function support at USB1 port.
- **USB-PWR2:**
 Pin 1-2 shorted (default): Disable wake-up function support at USB2 port.
 Pin 2-3 shorted: Enable wake-up function support at USB2 port

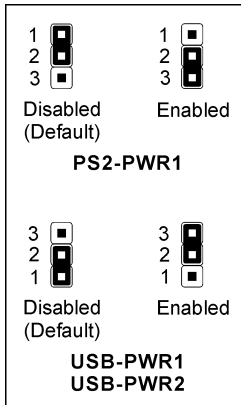
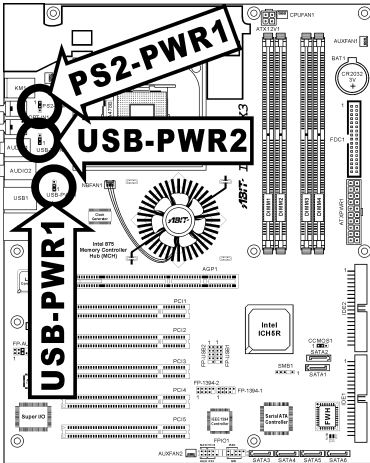

(5). Front Panel Switches & Indicators Headers

This header is used for connecting switches and LED indicators on the chassis front panel.

Watch the power LED pin position and orientation. The mark “+” align to the pin in the figure below stands for positive polarity for the LED connection. Please pay attention to connect these headers. A wrong orientation will only cause the LED not lighting, but a wrong connection of the switches could cause system malfunction.

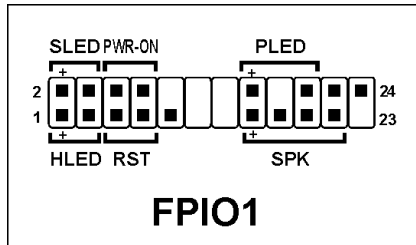
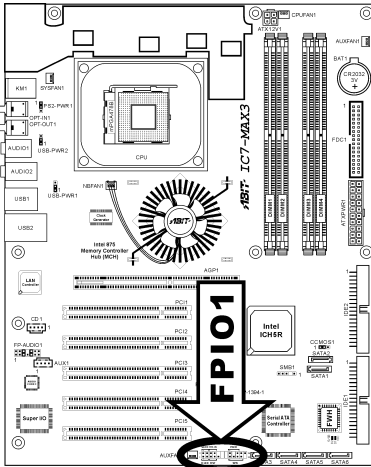

- **HLED (Pin 1, 3):**
Connects to the HDD LED cable of chassis front panel.
- **RST (Pin 5, 7):**
Connects to the Reset Switch cable of chassis front panel.
- **SPK (Pin 15, 17, 19, 21):**
Connects to the System Speaker cable of chassis.
- **SLED (Pin 2, 4):**
Connects to the Suspend LED cable (if there is one) of chassis front panel.
- **PWR-ON (Pin 6, 8):**
Connects to the Power Switch cable of chassis front panel.
- **PLED (Pin 16, 18, 20):**
Connects to the Power LED cable of chassis front panel.

(6). Additional USB Port Headers

These headers each provide 2 additional USB 2.0 ports connection through an USB cable designed for USB 2.0 specifications.

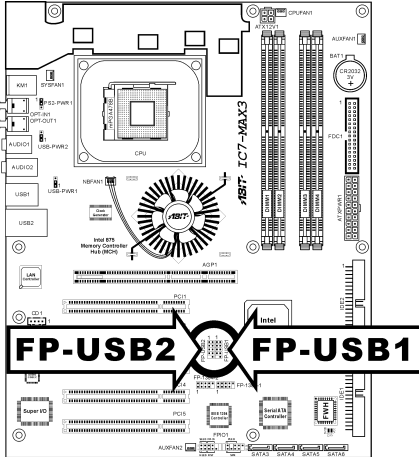

		Pin	Pin Assignment	Pin	Pin Assignment
1	2	1	VCC	2	VCC
3	4	3	Data0 -	4	Data1 -
5	6	5	Data0 +	6	Data1 +
7	8	7	Ground	8	Ground
9	10	9	NC	10	NC

(7). Additional IEEE1394 Port Header

These headers each provide one additional IEEE1394 port connection through an extension cable and bracket.

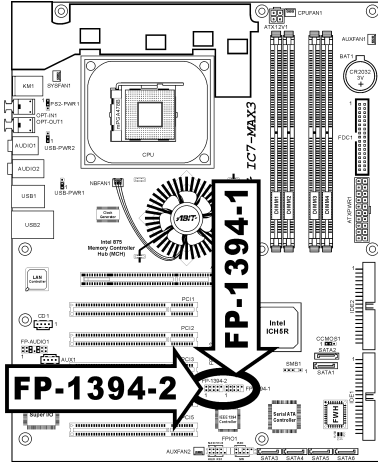

Pin	Pin Assignment	Pin	Pin Assignment
1	TPA0 +	2	TPA0 -
3	GND	4	GND
5	TPB0 +	6	TPB0 -
7	+12V	8	+12V
9	NC	10	GND

(8). Front Panel Audio Connection Header

This header provides the connection to audio connector at front panel.

- To use the audio connector at front panel, remove all the jumpers on this header, and then connect to front panel by the extension cable provided with the chassis.
- To use the audio connector at rear panel, disconnect the extension cable, attach the jumpers back at pin 5-6, and pin 9-10 (default setting).

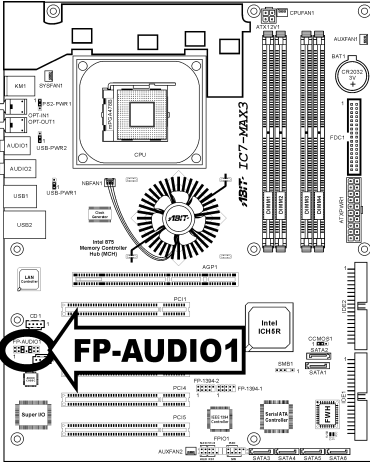

	Pin	Pin Assignment	Pin	Pin Assignment
	1	Audio Mic.	2	Ground
	3	Audio Mic. Bias	4	VCC
	5	Speaker Out Right Channel	6	Speaker Out Right Channel Return
	7	X	8	NC
	9	Speaker Out Left Channel	10	Speaker Out Left Channel Return
	11	Ground	12	S/PDIF In
	13	VCC	14	S/PDIF Out

(9). System Management Bus Headers

This header is reserved for system management bus (SM bus). The SM bus is a specific implementation of an I²C bus. I²C is a multi-master bus, which means that multiple chips can be connected to the same bus and each one can act as a master by initiating a data transfer. If more than one master simultaneously tries to control the bus, an arbitration procedure decides which master gets priority.

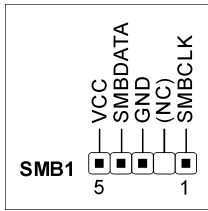
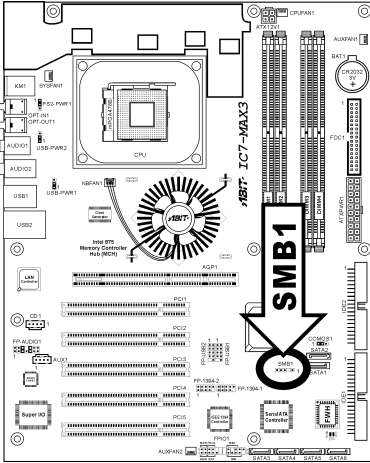

(10). Internal Audio Connectors

These connectors connect to the audio output of internal CD-ROM drive or add-on card.

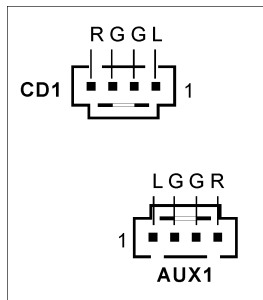
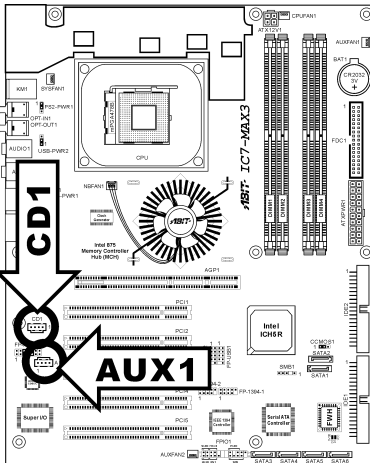

(11). Accelerated Graphics Port Slot

This motherboard provides an “AGP Pro 50” slot with up to AGP8X support.

To install an “AGP Pro 50” compliant card, the small plastic retention piece located in the AGP1 slot must be removed first (simply by your fingertips, and keep it for future use).

NOTE: Remove this plastic retention piece only when installing the “AGP Pro 50” compliant card. To install a regular VGA card will require this retention piece back in its original position to keep the VGA card from sliding back and forth, or even damage the VGA card and/or motherboard.

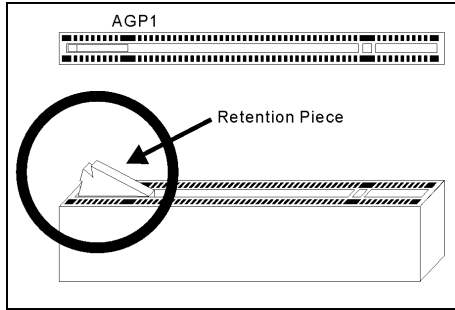
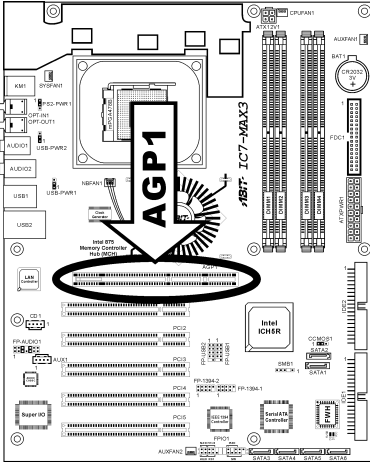

ATTENTION: This motherboard does not support 3.3V AGP cards. Use only 1.5V or 0.8V AGP cards.

(12). Floppy Disk Drive Connector

This connector supports two standard floppy disk drives via a 34-pin 34-conductor ribbon cable.

Connecting the Floppy Disk Drive Cable:

1. Install one end of the ribbon cable into the FDC1 connector. The colored edge of the ribbon cable should be aligned with pin-1 of FDC1 connector.
2. Install the other end(s) of ribbon cable into the disk drive connector(s). The colored edge of the ribbon cable should be also aligned with pin-1 of disk drive connector. The endmost connector should be attached to the drive designated as Drive A.

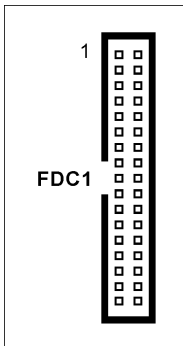
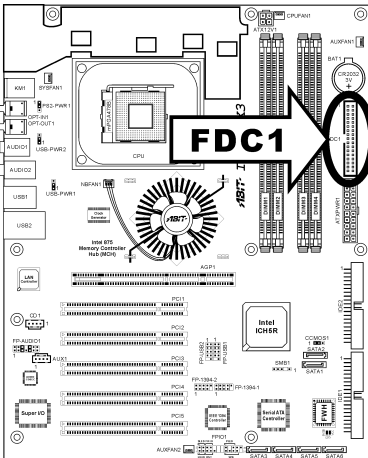

(13). IDE Connectors

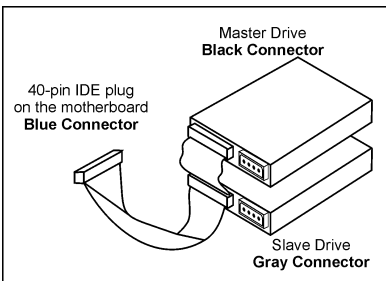
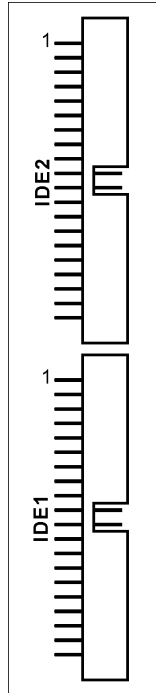
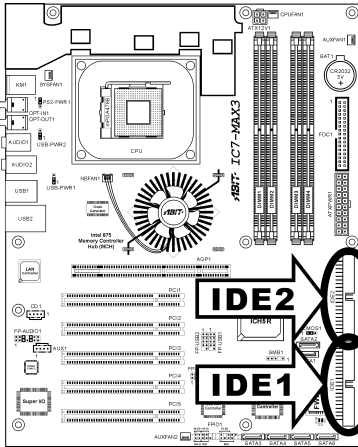

This motherboard provides two IDE ports to connect up to four IDE drives at Ultra ATA/100 mode by Ultra ATA/66 ribbon cables. Each cable has 40-pin 80-conductor and three connectors, providing two hard drives connection with motherboard. Connect the single end (blue connector) at the longer length of ribbon cable to the IDE port on motherboard, and the other two ends (gray and black connector) at the shorter length of the ribbon cable to the connectors on hard drives.

If you want to connect two hard drives together through one IDE channel, you must configure the second drive to Slave mode after the first Master drive. Please refer to the drives' documentation for jumper settings. The first drive connected to IDE1 is usually referred to as "Primary Master", and the second drive as "Primary Slave". The first drive connected to IDE2 is referred to as "Secondary Master" and the second drive as "Secondary Slave".

Keep away from connecting one legacy slow speed drive, like CD-ROM, together with another hard drive on the same IDE channel; this will drop your integral system performance.

(14). Serial ATA Connectors

These connectors are provided to attach one Serial ATA device at each channel via Serial ATA cable.

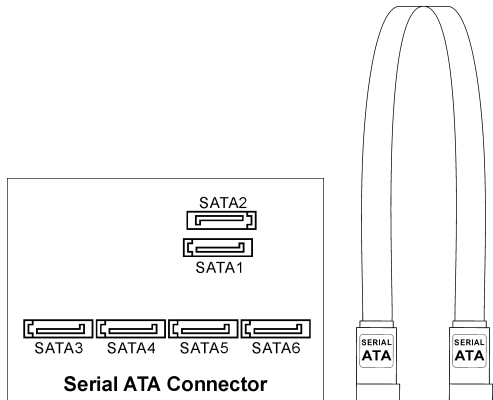
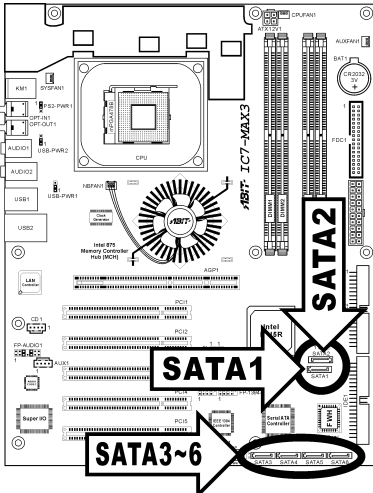

SATA1 and SATA2 are controlled by South Bridge. To enable the SATA1 and SATA2 controller, you have to enable the item “OnChip Serial ATA” first in the BIOS menu of “OnChip IDE Device”.

The following table displays the quantity of devices at IDE1, IDE2, SATA1 and SATA2 channel under different “OnChip Serial ATA” configuration:

WinXP / Windows .NET Server:

OnChip Serial ATA / OnChip Serial ATA Mode	IDE1	IDE2	SATA1	SATA2
Enhanced Mode / IDE	2	2	1	1

DOS / Win2K / Win98 / WinME:

OnChip Serial ATA / OnChip Serial ATA Mode	IDE1	IDE2	SATA1	SATA2
Combined Mode / IDE	0	2	1	1
	2	0	1	1
SATA Only / IDE	0	0	1	1
Disabled	2	2	0	0

SATA3~6 are controlled by Silicon Image PCI Chip. To enable the SATA3~6 controller, you have to enable the item “Serial ATA Controller” first in the BIOS menu of “Onboard PCI Device”.

For more information on how to configure the function mode for SATA1 and SATA2, please refer to the item “Serial ATA 1 Mode” and “Serial ATA 2 Mode” in the BIOS menu of “OnChip IDE Device”.

NOTE: The Serial ATA controller only supports Ultra DMA/ATA100 or higher hard drive. Do not use hard drives under this specification, or it won't work.

(15). Status Indicators

- **D1 (VCC):** This LED lights up when the system power is on.
- **D2 (5VSB):** This LED lights up when the power supply is connected with power source.

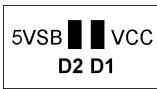
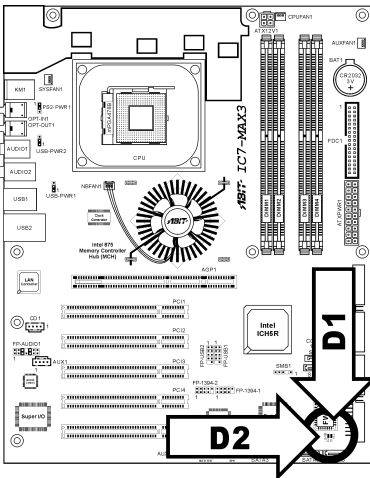

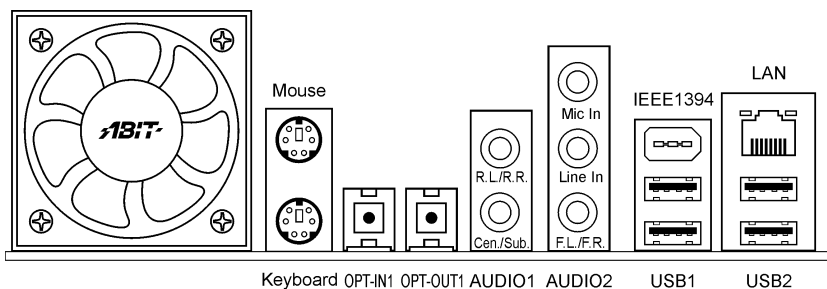
(16). Back Panel Connectors

- **Mouse:** Connects to PS/2 mouse.
- **Keyboard:** Connects to PS/2 keyboard.
- **OPT-IN1:** This connector provides an S/PDIF in connection through optical fiber to digital multimedia devices.
- **OPT-OUT1:** This connector provides an S/PDIF out connection through optical fiber to digital multimedia devices.
- **AUDIO1:**
R.L./R.R. (Rear Left / Rear Right): Connects to the rear left and rear right channel in the 5.1 channel audio system.
Cen./Sub. (Center / Subwoofer): Connects to the center and subwoofer channel in the 5.1 channel audio system.
- **AUDIO2:**
Mic In: Connects to the plug from external microphone.
Line In: Connects to the line out from external audio sources.
F.L./F.R. (Front Left / Front Right): Connects to the front left and front right channel in the 5.1-channel or regular 2-channel audio system.
- **IEEE1394:** Connects to devices of IEEE1394 protocol.
- **LAN:** Connects to Local Area Network.
- **USB1/USB2:** Connects to USB devices such as scanner, digital speakers, monitor, mouse, keyboard, hub, digital camera, joystick etc.



Chapter 3. BIOS Setup

This motherboard provides a programmable EEPROM that you can update the BIOS utility. The BIOS (Basic Input/Output System) is a program that deals with the basic level of communication between processor and peripherals. Use the BIOS Setup program only when installing motherboard, reconfiguring system, or prompted to “Run Setup”. This chapter explains the Setup Utility of BIOS utility.

After powering up the system, the BIOS message appears on the screen, the memory count begins, and then the following message appears on the screen:

PRESS DEL TO ENTER SETUP

If this message disappears before you respond, restart the system by pressing <Ctrl> + <Alt> + keys, or by pressing the Reset button on computer chassis. Only when it failed by these two methods can you restart the system by powering it off and then back on.

After pressing key, the main menu screen appears.

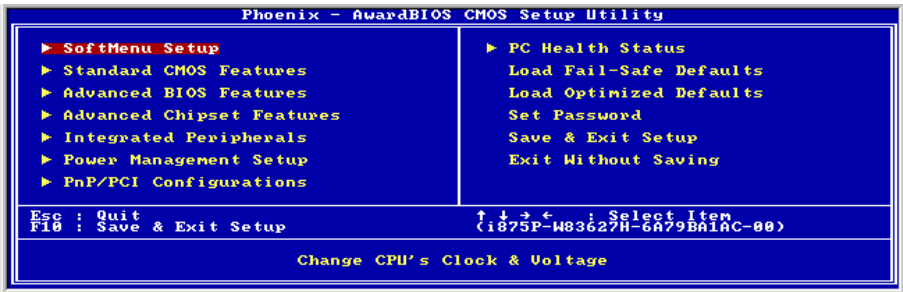

NOTE: In order to increase system stability and performance, our engineering staffs are constantly improving the BIOS menu. The BIOS setup screens and descriptions illustrated in this manual are for your reference only, may not completely match what you see on your screen.

3-1. SoftMenu Setup

The SoftMenu utility is ABIT's exclusive and ultimate solution in programming the CPU operating speed. All the parameters regarding CPU FSB speed, multiplier factor, the AGP & PCI clock, and even the CPU core voltage are all available at your fingertips.



Brand Name:

This item displays the CPU model name, for example: Intel Pentium (R) 4.

Frequency:

This item displays the processor speed.

Cache Size:

This item displays the L2 cache size of your CPU.

CPU Operating Speed:

This item displays the CPU operating speed according to the type and speed of your CPU. You can also select the [User Define] option to enter the manual option.

User Define:

WARNING: The wrong settings of the multiplier and external clock in certain circumstances may cause CPU damage. Setting the working frequency higher than the PCI chipset or processor specs, may cause abnormal memory module functioning, system hangs, hard disk drive data lose, abnormal functioning of the VGA card, or abnormal functioning with other add-on cards. Using non-specification settings for your CPU is not the intention of this explanation. These should be used for engineering testing, not for normal applications.

There will be no guaranty for the settings beyond specification, any damage of any component on this motherboard or peripherals result therein is not our responsibility.

* Ext. Clock (CPU/AGP/PCI):

This item selects the external clock frequency.

*** Multiplier Factor:**

This item selects the multiplier factors for your CPU if it is not locked.

*** Estimated new CPU clock:**

This item displays the frequency sum up from the previous item [Ext. Clock] and [Multiplier Factor].

*** N/B Strap CPU As:**

This item sets the external hardware reset strap assigned to MCH (Memory Controller Hub). The options are: [PSB400], [PSB533], [PSB800], and [By CPU]. The default setting is **By CPU**.

To set this option manually:

- Select [PSB400] for CPU of 100MHz FSB frequency.
- Select [PSB533] for CPU of 133MHz FSB frequency.
- Select [PSB800] for CPU of 200MHz FSB frequency.

*** DRAM Ratio (CPU:DRAM):**

This item determines the frequency ratio between CPU and DRAM.

*** AGP Ratio (CPU:AGP:PCI):**

This item determines the ratio among CPU, AGP, and PCI.

*** Fixed AGP/PCI Frequency:**

This item determines the AGP/PCI bus frequency. This option allows you to keep your AGP/PCI clock at some fixed frequency to improve system stability.

CPU Power Supply:

This option allows you to switch between CPU default and user-defined voltages. Leave this setting to default unless the current CPU type and voltage setting cannot be detected or is not correct. The option “**User Define**” enables you to select the Core Voltage manually.

*** CPU Core Voltage:**

This item selects the CPU core voltage.

ATTENTION: A wrong voltage setting may cause the system unstable or even damage the CPU. Please leave it to default settings unless you are fully aware of its consequences.

DDR SDRAM Voltage:

This item selects the voltage for DRAM slot.

AGP Voltage:

This item selects the voltage for AGP slot.

3-2. Standard CMOS Features

This section contains the basic configuration parameters of the BIOS. These parameters include date, hour, VGA card, FDD and HDD settings.



Date (mm:dd:yy):

This item sets the date you specify (usually the current date) in the format of [Month], [Date], and [Year].

Time (hh:mm:ss):

This item sets the time you specify (usually the current time) in the format of [Hour], [Minute], and [Second].

☛ IDE Channel 1 Master/Slave, IDE Channel 2 Master/Slave, IDE Channel 3 Master, IDE Channel 4 Master:

Click <Enter> key to enter its submenu:



NOTE: Item “IDE Channel 3 Master” and “IDE Channel 4 Master” appears only when the item “OnChip Serial ATA” in the “OnChip IDE Device” menu is set as [Enhanced Mode], and the item “OnChip Serial ATA Mode” in the “OnChip IDE Device” menu is set as [IDE].

IDE HDD Auto-Detection:

This item allows you to detect the parameters of IDE drives by pressing <Enter> key. The parameters will be shown on the screen automatically.

IDE Channel 1 Master/Slave, IDE Channel 2 Master/Slave, Extended IDE Drive:

When set to [Auto], the BIOS will automatically check what kind of IDE drive you are using. If you want to define your own drive by yourself, set it to [Manual] and make sure you fully understand the meaning of the parameters. Please refer to the instruction manual provided by the device's manufacturer to get the setting right.

Access Mode:

This item selects the mode to access your IDE devices. Leave this item to its default [Auto] setting to detect the access mode of your HDD automatically.

Capacity:

This item displays the approximate capacity of the disk drive. Usually the size is slightly greater than the size of a formatted disk given by a disk-checking program.

Cylinder:

This item configures the numbers of cylinders.

Head:

This item configures the numbers of read/write heads.

Precomp:

This item displays the number of cylinders at which to change the write timing.

Landing Zone:

This item displays the number of cylinders specified as the landing zone for the read/write heads.

Sector:

This item configures the numbers of sectors per track.

 **Back to Standard CMOS Features Setup Menu:**

Drive A & Drive B:

This item sets the type of floppy drives (usually only Drive A) installed.

Floppy 3 Mode Support:

This item allows you to use "3 Mode Floppy Drive" in Japanese computer system by selecting drive A, B, or both. Leave this item to its default [Disabled] setting if you are not using this Japanese standard floppy drive.

Video:

This item selects the type of video adapter used for the primary system monitor.

[EGA/VGA]: (Enhanced Graphics Adapter/Video Graphics Array) For EGA, VGA, SVGA and PGA monitor adapters.

[CGA 40]: (Color Graphics Adapter) Power up in 40-column mode.

[CGA 80]: (Color Graphics Adapter) Power up in 80-column mode.

[Mono]: (Monochrome adapter) Includes high-resolution monochrome adapters.

Halt On:

This item determines whether the system stops if an error is detected during system boot-up.

[All Errors]: The system-boot will stop whenever the BIOS detect a non-fatal error.

[No Errors]: The system-boot will not stop for any error detected.

[All, But Keyboard]: The system-boot will stop for all errors except a keyboard error.

[All, But Diskette]: The system-boot will stop for all errors except a diskette error.

[All, But Disk/Key]: The system-boot will stop for all errors except a diskette or keyboard error.

Base Memory:

This item displays the amount of base memory installed in the system. The value of the base memory is typically 640K for system with 640K or more memory size installed on the motherboard.

Extended Memory:

This item displays the amount of extended memory detected during system boot-up.

Total Memory:

This item displays the total memory available in the system.

3-3. Advanced BIOS Features



Hyper-Threading Technology:

This option enables or disables the processor's Hyper-Threading Technology

Leave this item to its default setting to enable the simultaneous multi-threaded (SMT) processor so as to make one physical processor look like two logical processors to the OS and applications.

This option is for CPU with Hyper-Threading Technology only. For more information on

"Hyper-Threading Technology", please visit Intel Web site at

<http://www.intel.com/homepage/land/hyperthreading.htm> , <http://www.intel.com/design/chipsets/ht/>.

Quick Power On Self Test:

When set to [Enabled], this item speeds up the Power On Self Test (POST) after powering on the system. The BIOS shorten or skip some check during the POST.

Hard Disk Boot Priority:

This item selects the hard disks booting priority. By pressing <Enter> key, you can enter its submenu where the hard disks detected can be selected for the booting sequence to boot up system.

This item functions only when there is the option of [Hard Disk] in any one of the First/Second/Third Boot Device items.

* Bootable Add-in Device:

This item allows you to select the add-in device among the [PCI Slot Device], [OnChip SATA RAID], and [Onboard SATA] channel to serve as the bootable device listed in the item "Hard Disk Boot Priority".

* HDD Change Message:

When set to [Enabled], a pop-up message will be displayed on the screen during the POST process if the hard drives installed in your system had been changed.

First Boot Device / Second Boot Device / Third Boot Device / Boot Other Device:

Select the drive to boot first, second and third in the [First Boot Device], [Second Boot Device], and [Third Boot Device] items respectively. The BIOS will boot the operating system according to the sequence of the drive selected. Set [Boot Other Device] to [Enabled] if you wish to boot from another device other than these three items.

Swap Floppy Drive:

When set to [Enabled], and the system is booting from the floppy drive, the system will boot from drive B instead of the regular drive A. There must be two floppy drives connected in the system to use this function.

Boot Up Floppy Seek:

When set to [Enabled], the BIOS will check whether the floppy disk drive is installed or not.

Boot Up NumLock Status:

This item determines the default state of the numeric keypad at system booting up.

[On]: The numeric keypad functions as number keys.

[Off]: The numeric keypad functions as arrow keys.

Security Option:

This item determines when the system will prompt for password - every time the system boots or only when enters the BIOS setup.

[Setup]: The password is required only when accessing the BIOS Setup.

[System]: The password is required each time the computer boots up.

NOTE: Don't forget your password. If you forget the password, you will have to open the computer case and clear all information in the CMOS before you can start up the system. But by doing this, you will have to reset all previously set options.

APIC Mode:

Leave this item to its default setting.

MPS Version Ctrl For OS:

This item specifies which version of MPS (Multi-Processor Specification) this motherboard will use. Leave this item to its default setting.

OS Select For DRAM > 64MB:

This item allows you to access the memory that is over 64MB in OS/2. Leave this item to its default [Non-OS2] setting for operating system other than OS/2.

Report No FDD For OS:

When set to [Yes], this item allows you to run some older operating system without floppy disk drive. Leave this item to its default setting.

Delay IDE Initial (Secs):

This item allows the BIOS to support some old or special IDE devices by prolonging this delay time. A larger value will give more delay time to the device for which to initialize and to prepare for activation.

PCI Card Support for SMBus:

This option enables or disables the SMBus function on PCI slots for PCI 2.3 specification.

Intel OnScreen Branding:

This item determines whether to display the “Intel Inside” logo or not at system boots up.

Disable Unused PCI Clock:

This option disables the clock of PCI slot that is not in use.

[Yes]: The system automatically detect the unused DIMM and PCI slots, and stop sending clock signal to these unused PCI slots.

[No]: The system always send clock signal to all PCI slots.

NOTE: Set this option to [No] setting if there are adapters that cannot be automatically detected by the system and will cause malfunction.

3-4. Advanced Chipset Features



DRAM Timing Selectable:

This item sets the optimal timings for the following four items, depending on the memory module you are using. The default setting “By SPD” configures these four items by reading the contents in the SPD (Serial Presence Detect) device. The EEPROM on the memory module stores critical parameter information about the module, such as memory type, size, speed, voltage interface, and module banks.

* CAS Latency Time:

This item controls the latency between the DRAM read command and the time that the data becomes actually available.

* Act to Precharge Delay:

This item controls the number of DRAM clocks used for the DRAM parameters.

* DRAM RAS# to CAS# Delay

This item controls the latency between the DRAM active command and the read/write command.

* DRAM RAS# Precharge:

This item controls the idle clocks after issuing a precharge command to the DRAM.

System BIOS Cacheable:

When set to [Enabled], accesses to the system BIOS ROM addressed at F0000H-FFFFFH are cached, provided that the cache controller is enabled. The larger the range of the Cache RAM, the higher the efficiency of the system will be.

Video BIOS Cacheable:

As with caching the system BIOS, enabling the Video BIOS cache will allow access to video BIOS addressed at C0000H to C7FFFH to be cached, if the cache controller is also enabled. The larger the range of the Cache RAM, the faster the video performance will be.

Memory Hole At 15M-16M:

When set to [Enabled], the memory address space at 15M-16M will be reserved for ISA expansion cards that specifically requires this setting. This makes the memory from 15MB and up unavailable to the system. Leave this item to its default setting.

Delay Prior to Thermal:

This item selects the delay time before thermal activation.

AGP Aperture Size:

This option specifies the amount of system memory that can be used by the AGP device. The aperture is a portion of the PCI memory address range dedicated for graphics memory address space.

Init Display First:

This item selects to initialize AGP or PCI Slot first when the system boots.

[AGP]: When the system boots, it will first initialize AGP.

[PCI Slot]: When the system boots, it will first initialize PCI.

DRAM Data Integrity Mode:

This item selects the type of DRAM in your system. ECC is "Error Checking and Correction". Choose the ECC option only when your memory is ECC type.

AGP Data Rate Capability:

This item selects the data transfer rate of AGP device. A higher rate delivers faster and better graphics to your system. Make sure your graphics card supports the mode you select.

Game Accelerator:

This item selects the mode for Game Accelerator among the options of [Auto], [Turbo], [Street Racer], and [F1].

NOTE: The option [Street Racer] and [F1] mode will stress the DDR memory critically; not every kind of DDR memories could be stable with these two options. [Turbo] mode is okay for most of DDR memories.

*** Refresh Cycle Time:**

This item determines the DRAM Refresh Cycle among [Auto], [Normal], [Enhanced], [Strengthened], and [Aggressive].

*** Read Delay (tRD):**

This item determines the timing of DRAM Read Delay.

*** Read delay Adjust(tRDA):**

This item determines to adjust the timing of DRAM Read Delay.

*** Command Per Clock(CPC):**

This item determines the address command timing according to the DRAM strobe clock.

3-5. Integrated Peripherals



↳ OnChip IDE Device:

Click <Enter> key to enter its submenu:



IDE Bus Master:

This option enables or disables the IDE bus mastering capability under the DOS environment.

OnChip IDE-1 Controller:

This item allows you to enable or disable the primary and secondary IDE controller. Select [Disabled] if you want to add a different hard drive controller.

* Master/Slave Drive PIO Mode

The PIO (Programmed Input/Output) mode allows the BIOS to tell the controller what it wants and then let the controller and the CPU perform the complete task, rather than having the BIOS issue a series of commands to affect a transfer to or from the disk drive.

[Auto]: The BIOS will select the best available mode after checking your disk drive.

[Mode 0-4]: You can select a mode that matches your disk drive's timing. Do not use the wrong setting or you will have drive errors.

*** Master/Slave Drive Ultra DMA**

This item allows you to set the Ultra DMA in use.

[Auto]: The BIOS will select the best available option after checking your hard drive or CD-ROM.

[Disabled]: The BIOS will not detect these categories. If problem arises in using Ultra DMA devices, try disabling this item.

OnChip IDE-2 Controller:

The description is same as the *OnChip IDE-1 Controller*.

OnChip Serial ATA Mode:

This item determines the mode for on-chip Serial ATA.

[IDE]: The on-chip Serial ATA served as IDE Mode.

[RAID]: The on-chip Serial ATA served as RAID Mode.

[NOTE]: The [RAID] option is only available when the item “OnChip Serial ATA” is set as [Enhanced Mode].

*** SATA RAID ROM:**

This item allows you to use the boot ROM of on-chip Serial ATA RAID to boot-up system.

OnChip Serial ATA:

This item determines the function for on-chip Serial ATA.

[Disabled]: Disable the Serial ATA controller.

[Auto]: Allows the Serial ATA controller to be arranged by BIOS automatically.

[Combined Mode]: Parallel ATA and Serial ATA are combined together. Supports up to 4 IDE drives.

[Enhanced Mode]: Enable both Parallel ATA and Serial ATA. Supports up to 6 IDE drives.

[SATA Only]: The SATA is operating in legacy mode.

✱ **Serial ATA 1 Mode / Serial ATA 2 Mode:**

This item determines the function mode for Serial ATA Port 1 (i.e. The SATA1 connector in this model) and Serial ATA Port 2 (i.e. The SATA2 connector in this model). Both SATA1 and SATA2 will be served each as one single IDE connector after selected as the following modes:

Mode	Serial ATA Port 1 (SATA1)	Serial ATA Port 2 (SATA2)	Description
Enhanced	IDE-3 Master	IDE-4 Master	<ul style="list-style-type: none"> • SATA1 serves as IDE-3 Master • SATA2 serves as IDE-4 Master • OnChip IDE-1 and IDE-2 controller enabled
	IDE-4 Master	IDE-3 Master	<ul style="list-style-type: none"> • SATA1 serves as IDE-4 Master • SATA2 serves as IDE-3 Master • OnChip IDE-1 and IDE-2 controller enabled
Combined	IDE-1 Master	IDE-1 Slave	<ul style="list-style-type: none"> • SATA1 serves as IDE-1 Master • SATA2 serves as IDE-1 Slave • OnChip IDE-1 controller disabled
	IDE-1 Slave	IDE-1 Master	<ul style="list-style-type: none"> • SATA1 serves as IDE-1 Slave • SATA2 serves as IDE-1 Master • OnChip IDE-1 controller disabled
	IDE-2 Master	IDE-2 Slave	<ul style="list-style-type: none"> • SATA1 serves as IDE-2 Master • SATA2 serves as IDE-2 Slave • OnChip IDE-2 controller disabled
	IDE-2 Slave	IDE-2 Master	<ul style="list-style-type: none"> • SATA1 serves as IDE-2 Slave • SATA2 serves as IDE-2 Master • OnChip IDE-2 controller disabled
SATA Only	IDE-1 Master	IDE-2 Master	<ul style="list-style-type: none"> • SATA1 serves as IDE-1 Master • SATA2 serves as IDE-2 Master • OnChip IDE-1 and IDE-2 controller disabled
	IDE-2 Master	IDE-1 Master	<ul style="list-style-type: none"> • SATA1 serves as IDE-2 Master • SATA2 serves as IDE-1 Master • OnChip IDE-1 and IDE-2 controller disabled

↳ OnChip PCI Device:

Click <Enter> key to enter its submenu:



OnChip USB Controller:

This option enables or disables the USB controller.

* USB 2.0 Controller:

This option enables or disables the USB 2.0 controller.

* USB Keyboard Support Via:

This item allows you to select **[BIOS]** for using USB keyboard in DOS environment, or **[OS]** in OS environment.

* USB Mouse Support Via:

This item allows you to select **[BIOS]** for using USB mouse in DOS environment, or **[OS]** in OS environment.

OnChip Audio Controller:

This option enables or disables the audio controller.

OnChip LAN Controller:

This option enables or disables the LAN controller.

* LAN Boot ROM:

This item allows you to use the boot ROM (instead of a disk drive) to boot-up the system and access the local area network directly.

↳ SuperIO Device:

Click <Enter> key to enter its submenu:

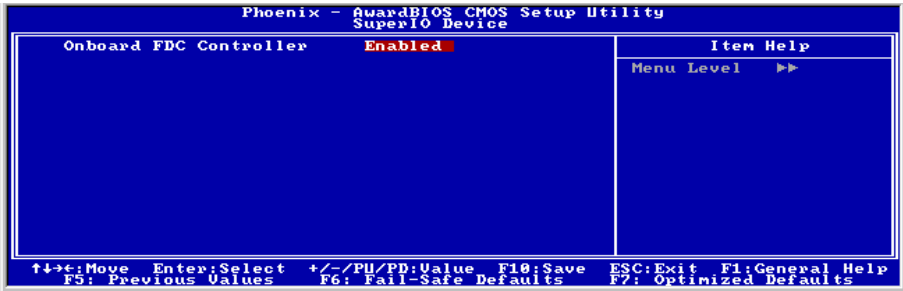

Onboard FDC Controller:

This option enables or disables the onboard FDC controller.

↳ Onboard PCI Device:

Click <Enter> key to enter its submenu:



IEEE 1394 Controller:

This option enables or disables the IEEE 1394 controller.

Serial ATA Controller:

This option enables or disables the Serial ATA controller of Silicon Image PCI Chip

* SATA RAID ROM:

This item allows you to use the boot ROM of on-chip Serial ATA RAID to boot-up system.

3-6. Power Management Setup

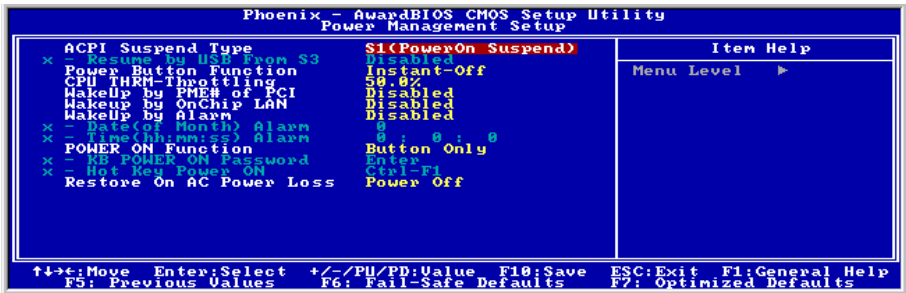

ACPI Suspend Type:

This item selects the type of Suspend mode.

[S1(PowerOn Suspend)]: Enables the Power On Suspend function.

[S3(Suspend To RAM)]: Enables the Suspend to RAM function.

Resume by USB From S3:

When set to [Enabled], this item allows you to use a USB device to wake up a system that is in the S3 (STR - Suspend To RAM) state. This item can be configured only if the item “ACPI Suspend Type” is set to [S3(STR)].

Power Button Function:

This item selects the method of powering off your system:

[Delay 4 Sec.]: Pushing the power button for more than 4 seconds will power off the system. This will prevent the system from powering off in case you accidentally hit or pushed the power button.

[Instant-Off]: Pressing and then releasing the power button at once will immediately power off the system.

CPU THRM-Throttling

This item controls the CPU speed by cutting down its regular power to a percentage during the STR (Suspend To RAM) state.

WakeUp by PME# of PCI:

When set to [Enabled], access to the onboard LAN or a PCI card such as a modem or LAN card will cause the system to wake up. The PCI card must support the wake up function.

WakeUp by OnChip Lan:

When set to [Enabled], you can remotely wake up a PC in Soft-Off condition via a LAN card that support the wake up function.

WakeUp by Alarm:

When set to [Enabled], you can set the date and time you would like the Soft-Off PC to power-on in the “Date (of Month) Alarm” and “Time (hh:mm:ss) Alarm” items. However, if the system is being accessed by incoming calls or the network (Resume On Ring/LAN) prior to the date and time set in these items, the system will give priority to the incoming calls or network instead.

* **Date (of Month) Alarm**

[0]: This option power-on the system everyday according to the time set in the “Time (hh:mm:ss) Alarm” item.

[1-31]: This option selects a date you would like the system to power-on. The system will power-on on the date set, and the time set in the “Time (hh:mm:ss) Alarm” item.

* **Time (hh:mm:ss) Alarm**

This item sets the time you would like the system to power-on.

POWER ON Function:

This item selects the way you want your system to power on.

[Password]: Use a password to power on the system, select this option then press <Enter>. Enter your password. You can enter up to 5 characters. Type in exactly the same password to confirm, and then press <Enter>.

[Hot KEY]: Use any of the function keys between <F1> to <F12> to power on the system.

[Mouse Left]: Double click the mouse left button to power on the system.

[Mouse Right]: Double click the mouse right button to power on the system.

[Any KEY]: Use any keyboard keys to power on the system.

[Button Only]: Use only the power button to power on the system.

[Keyboard 98]: Use the power-on button on the “Keyboard 98” compatible keyboard to power on the system.

NOTE: To enable this “Power On” function, the wake-up header of [PS2-PWR1], [USB-PWR1], [USB-PWR2] must be set to [Enabled] position. Please refer to the configuration of “Wake-up Header” [PS2-PWR1], [USB-PWR1], and [USB-PWR2] in section 2-4, chapter 2.

The mouse wake up function can only be used with the PS/2 mouse, not with the COM port or USB type. Some PS/2 mice cannot wake up the system because of compatible problems. If the specs of your keyboard are too old, it may fail to power on.

* **KB Power ON Password:**

This item sets the password required in order to power on your computer.

NOTE: Do not forget your password, or you will have to clear the CMOS and reset all parameters in order to utilize this function again.

* **Hot Key Power ON:**

This item powers on the system by pressing <Ctrl> key plus one of each function key (<F1> ~ <F12>) simultaneously.

Restore On AC Power Loss:

This item selects the system action after an AC power failure.

[Power Off]: When power returns after an AC power failure, the system's power remains off. You must press the Power button to power-on the system.

[Power On]: When power returns after an AC power failure, the system's power will be powered on automatically.

[Last State]: When power returns after an AC power failure, the system will return to the state where you left off before power failure occurs. If the system's power is off when AC power failure occurs, it will remain off when power returns. If the system's power is on when AC power failure occurs, the system will power-on when power returns.

3-7. PnP/PCI Configurations



Resources Controlled By:

This item configures all of the boot and Plug-and-Play compatible devices.

[Auto]: The system will automatically detect the settings.

[Manual]: Choose the specific IRQ resources in the “IRQ Resources” menu.

* IRQ Resources:

Click <Enter> key to enter its submenu:

This item sets each system interrupt to either [PCI Device] or [Reserved].

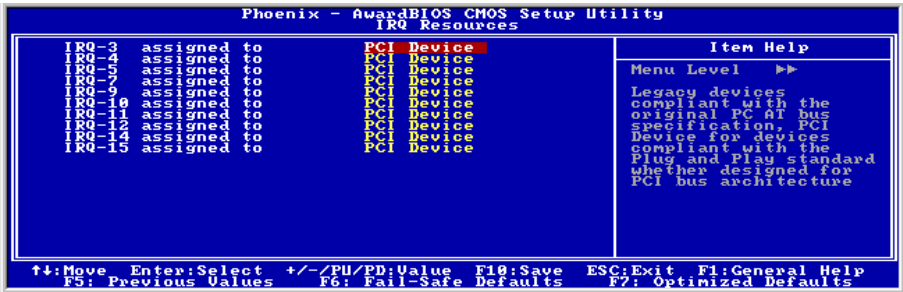

PCI/VGA Palette Snoop:

This item determines whether the MPEG ISA/VESA VGA cards can work with PCI/VGA or not.

[Enabled]: MPEG ISA/VESA VGA cards work with PCI/VGA.

[Disabled]: MPEG ISA/VESA VGA cards do not work with PCI/VGA.

Allocate IRQ To Video:

This item assigns an IRQ for the VGA card installed.

[Enabled]: Automatically assign an IRQ for the VGA card installed.

[Disabled]: The IRQ that was previously occupied by the VGA card will be available for new device.

Allocate IRQ To USB:

This item assigns an IRQ for the USB device connected.

[Enabled]: Automatically assign an IRQ for the USB device connected.

[Disabled]: The IRQ that was previously occupied by the USB device connected will be available for new device.

PCI Latency Timer(CLK):

This item controls how long each PCI device can hold the bus before another takes over. When set to higher values, every PCI device can conduct transactions for a longer time and thus improve the effective PCI bandwidth. For better PCI performance, you should set the item to higher values.

PIRQ_0 Use IRQ No. ~ PIRQ_7 Use IRQ No.:

This item specifies the IRQ number manually or automatically for the devices installed on PCI slots.

For the relations between the hardware layout of PIRQ (the signals from the ICH chipset), INT# (means PCI slot IRQ signals) and devices, please refer to the table below:

Signals	AGP	LAN	PCI-1	PCI-2	PCI-3	PCI-4	PCI-5	IEEE-1394	SATA
PIRQ_0 Assignment	INT A		INT D						
PIRQ_1 Assignment	INT B		INT A						
PIRQ_2 Assignment		INT A	INT B					INT A	
PIRQ_3 Assignment			INT C						INT A
PIRQ_4 Assignment				INT A	INT D	INT C	INT B		
PIRQ_5 Assignment				INT B	INT A	INT D	INT C		
PIRQ_6 Assignment				INT C	INT B	INT A	INT D		
PIRQ_7 Assignment				INT D	INT C	INT B	INT A		

3-8. PC Health Status



FAN Fail Alarm Selectable:

This item selects the fan that will be monitored for malfunction.

Shutdown When FAN Fail:

When set to [Enabled], the system will be shut down if the CPU fan is not running.

CPU FanEQ Speed Control:

This item allows you to control the CPU fan speed down to a specific percentage.

When set to a specific percentage, the CPU fan speed will run at the percentage you set in this item if the temperature limit set in the item "Active Temperature" is not exceeded.

The CPU fan speed will run at 100% regardless of what the percentage you set in this item if the temperature limit set in the item "Active Temperature" is exceeded.

* Active Temperature:

This item sets the temperature limit that would activate the function of "CPU FanEQ Speed Control" option.

CPU Shutdown Temperature:

This item sets the temperature that would shutdown the system automatically in order to prevent system overheats.

CPU Warning Temperature:

This item selects the CPU's warning temperature limit. Once the system has detected that the CPU's temperature exceeded the limit, warning beeps will sound.

NOTE: The onboard hardware monitor function is capable of detecting these system health conditions. If you want a warning message to pop-up or a warning alarm to sound when an abnormal condition occurs, you must install the "Hardware Doctor" utility. This utility is included in the "Driver & Utility CD" that came packed with this motherboard.

All Voltages, Fans Speed and Thermal Monitoring:

These unchangeable items list the current status of the CPU and environment temperatures, fan speeds, and system power voltage.

NOTE: The hardware monitoring features for temperatures, fans and voltages will occupy the I/O address from 294H to 297H. If you have a network adapter, sound card or other add-on cards that might use those I/O addresses, please adjust your add-on card I/O address to avoid using these addresses.

3-9. Load Fail-Safe Defaults

This option loads the BIOS default values for the most stable, minimal-performance system operations.

3-10. Load Optimized Defaults

This option loads the BIOS default values that are factory settings for optimal-performance system operations.

3-11. Set Password

This option protects the BIOS configuration or restricts access to the computer itself.

3-12. Save & Exit Setup

This option saves your selections and exits the BIOS setup menu.

3-13. Exit Without Saving

This option exits the BIOS setup menu without saving any change.



Appendix A. Install Intel Chipset Software Utility

NOTE: Please install this Intel Chipset driver first after having installed the Windows operating system.

The installation procedures and screen shots in this section are based on Windows XP operating system. For those of other OS, please follow its on-screen instruction.

Insert the Driver & Utility CD into CD-ROM drive, it should execute the installation program automatically. If not, double-click the execution file at the main directory of this CD to enter the installation menu.

After entering the installation menu, move your cursor to [Drivers] tab. Click [Intel Chipset Software Utility]. The following screen appears.

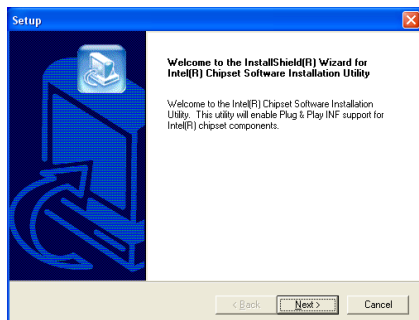

1. Click [Next].

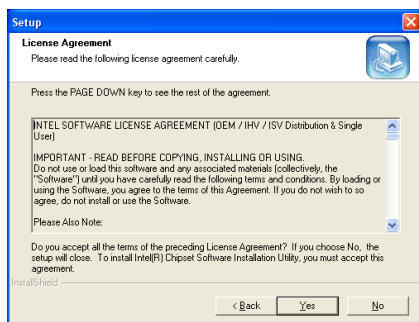

2. Click [Yes].

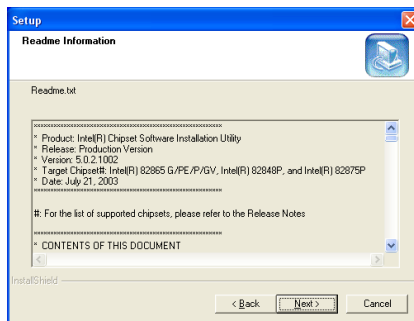

3. Click [Next].

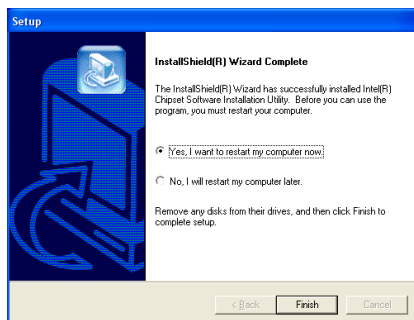

4. Choose [Yes, I want to restart my computer now.], and click [Finish] to complete setup.



Appendix B. Install Intel Application Accelerator RAID

The installation procedures and screen shots in this section are based on Windows XP operating system. For those of other OS, please follow its on-screen instruction.

Insert the Driver & Utility CD into CD-ROM drive, it should execute the installation program automatically. If not, double-click the execution file at the main directory of this CD to enter the installation menu.

After entering the installation menu, move your cursor to [Drivers] tab. Click [Intel Application Accelerator RAID]. The following screen appears.

NOTE: This “Intel Application Accelerator RAID” program edition is available for Windows XP only. To install this program, you have to enable the item “RAID Function” first in the BIOS menu of “OnChip Serial ATA”.

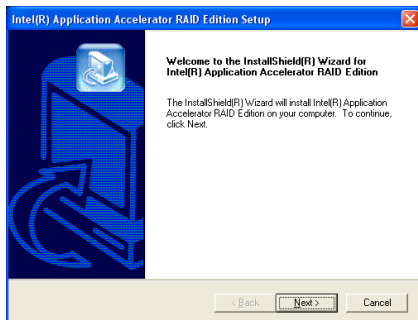

1. Click [Next].

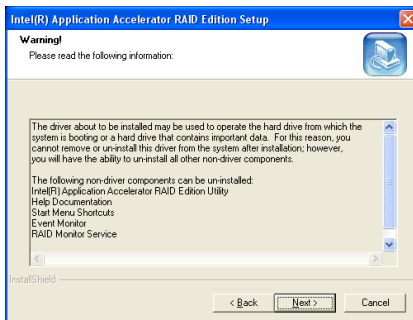

2. Click [Next].

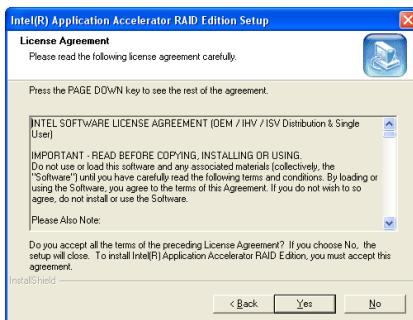

3. Click [Yes].

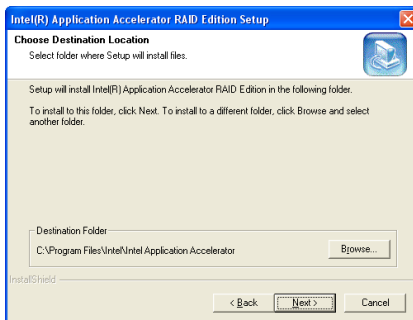

4. Click [Next].

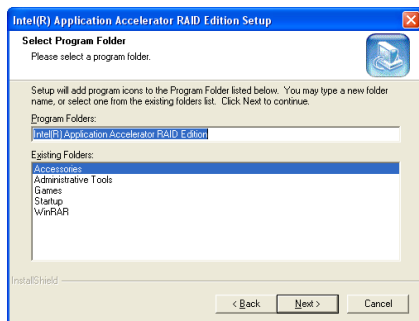

5. Click [Next].

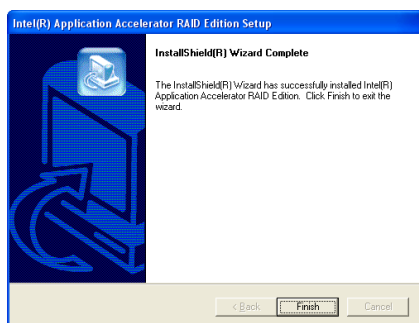

6. Click [Finish] to complete setup.

Intel Serial ATA RAID Configuration Utility

The on-chip Serial ATA RAID supports the Stripe (RAID 0) and Mirror (RAID 1) RAID set. For the striped RAID set, the identical drives can read and write data in parallel to increase performance. The Mirrored RAID set creates a complete backup of your files. Striped and Mirrored RAID set requires 2 hard disks to do so.

Main Menu

Reboot your system. Press <CTRL> + <I> key while booting up the system to enter the main menu of RAID Configuration Utility:

```

Intel(R) RAID for Serial ATA - RAID Configuration Utility
Copyright(C) 2003 Intel Corporation. All Rights Reserved. v3.5.0.2568

[ MAIN MENU ]

1. Create RAID Volume
2. Delete RAID Volume
3. Reset Disks to Non-RAID
4. Exit

[ DISK/VOLUME INFORMATION ]

RAID Volumes:
None defined.

Non-RAID Disks:
Port Drive Model      Serial #      Size      Status      Bootable
0 Maxtor 6Y06080      Y220865P     57.2GB    Normal      Yes
1 Maxtor 6Y06080      Y220865P     57.2GB    Normal      Yes

[ F1]-Select      [ESC]-Exit      [ENTER]-Select Menu

```

To select the option in this menu, you may:

- Press <↑> <↓> (up, down arrow) to choose the option you want to confirm or to modify.
- Press <Enter> to confirm the selection.
- Press <Esc> to return to previous menu.

NOTE: If you want to create a RAID 0 (striping) array, all the data stored in the hard disks will first be erased! Please backup the hard disk data before starting to create the RAID array.

If you want to create a RAID 1 (mirroring) array, please make sure which hard disk is the source disk and which one is the destination disk. If you make a mistake, you may copy the blank data to the source disk, which will result in both hard disks becoming blank!

Create RAID Volume

This item allows you to create a RAID array.

```

Intel(R) RAID for Serial ATA - RAID Configuration Utility
Copyright(C) 2003 Intel Corporation. All Rights Reserved. v3.5.0.2568

[ CREATE ARRAY MENU ]

Name: [RAID Volume]
RAID Level: RAID0 (Stripe)
Strip Size: 128KB
Capacity: 57.2GB

Create Volume

[ HELP ]

Enter a string between 1 and 16 characters in length that can be used
to uniquely identify the RAID volume. This name is case sensitive and
can not contain special characters.

[ F1]-Change  [TAB]-Next  [ESC]-Previous Menu  [ENTER]-Select

```

Name: This item displays the name of the RAID array. You can enter up to 16 characters in length. This name is case sensitive and cannot contain special characters.

Strip Size: This item displays the strip value.

RAID Level: This item displays the RAID type.

Capacity: This item displays the capacity of RAID array.

NOTE: It is highly recommended to attach hard disks with the same model in reaching the RAID performance.

Delete RAID Volume

This item allows you to remove a RAID Array.

```

Intel(R) RAID for Serial ATA - RAID Configuration Utility
Copyright(C) 2003 Intel Corporation. All Rights Reserved. v3.5.0.2568

[ DELETE ARRAY MENU ]

Name      Level      Drives  Capacity  Status  Bootable
RAID Volume1  RAID0(Stripe)  2       57.2GB   Normal  Yes

[ HELP ]

Deleting a volume will destroy the volume data on the drive(s) and
cause any member disks to become available as non-RAID disks.

WARNING: EXISTING DATA WITHIN THIS VOLUME WILL BE LOST AND NON-RECOVERABLE

[F1]-Select [ESC]-Previous Menu [DEL]-Delete Volume
    
```

- Press <↑ ↓> (up, down arrow) to select the RAID array you want to delete.
- Press to delete the volume.
- Press <Esc> to return to previous menu.

NOTE: After you have made and confirmed this selection, all the data stored in the hard disk will be lost. (The entire partition configuration will be deleted too.)

Reset Disks to Non-RAID

This item allows you to reset all RAID data. Type <Y> if you want to reset all RAID data.

```

Intel(R) RAID for Serial ATA - RAID Configuration Utility
Copyright(C) 2003 Intel Corporation. All Rights Reserved. v3.5.0.2568

[ MAIN MENU ]

[ RESET ALL RAID DATA ]

Resetting all RAID data will remove any internal RAID structures
from all RAID disks, including disks with working volumes. These
structures are used to maintain the RAID volumes. By removing
these structures, the drive will revert back to a Non-RAID disk
that can be used or reallocated to a new RAID volume.

WARNING: Selecting "Yes" will cause all data on any RAID disk
(RAID Volume or other RAID Disk) to be lost.

Are you sure you want to reset all RAID data (Y/N):

Port Drive Model      Serial #          Size  Status  Bootable
0 Maxtor 6Y060MD      Y2Z0865P         57.2GB Normal  Yes
1 Maxtor 6Y060MD      Y2Z0865P         57.2GB Normal  Yes

[F1]-Select [ESC]-Exit [ENTER]-Select Menu
    
```

Exit

This item allows you to exit the Intel Serial ATA RAID Configuration Utility. Type <Y> if you want to exit.

```

Intel(R) RAID for Serial ATA - RAID Configuration Utility
Copyright(C) 2003 Intel Corporation. All Rights Reserved. v3.5.0.2568

[ MAIN MENU ]

1. Create RAID Volume
2. Delete RAID Volume
3. Reset Disks to Non-RAID
4. Exit

[ CONFIRM EXIT ]

Are you sure you want to exit? (Y/N):

RAID Volumes:
None defined.

Non-RAID Disks:
Port Drive Model      Serial #          Size  Status  Bootable
0 Maxtor 6Y060MD      Y2Z0865P         57.2GB Normal  Yes
1 Maxtor 6Y060MD      Y2Z0865P         57.2GB Normal  Yes

[F1]-Select [ESC]-Exit [ENTER]-Select Menu
    
```

Appendix C. Install Audio Driver

The installation procedures and screen shots in this section are based on Windows XP operating system. For those of other OS, please follow its on-screen instruction.

Insert the Driver & Utility CD into CD-ROM drive, it should execute the installation program automatically. If not, double-click the execution file at the main directory of this CD to enter the installation menu.

After entering the installation menu, move your cursor to [Drivers] tab. Click [RealTek ALC650 Audio]. The following screen appears.

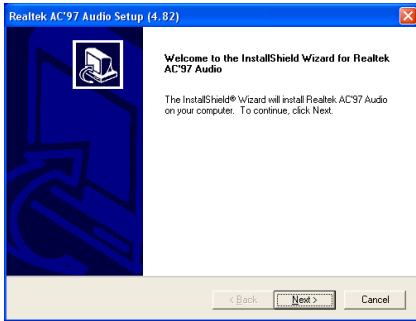

1. Click [Next].

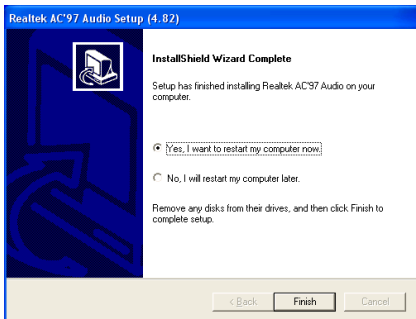

2. Choose [Yes, I want to restart my computer now.], and click [Finish] to complete setup.

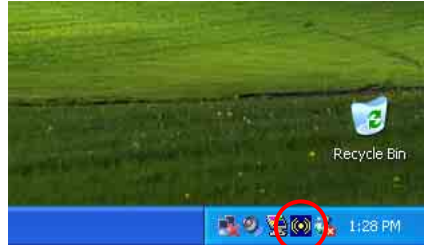

3. After the system restarted, a shortcut icon appears at the right corner of Windows task bar.

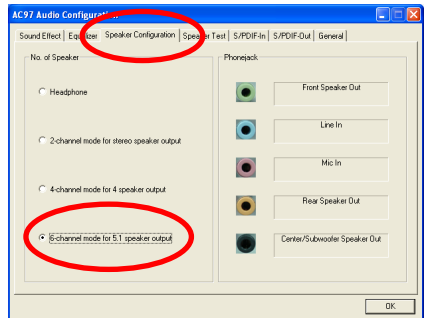

4. In this Speaker Configuration tab, select [6 channels mode for 5.1 speakers output] to enable 6-channel audio system.



Appendix D. Install LAN Driver

The installation procedures and screen shots in this section are based on Windows XP operating system. For those of other OS, please follow its on-screen instruction.

Insert the Driver & Utility CD into CD-ROM drive, it should execute the installation program automatically. If not, double-click the execution file at the main directory of this CD to enter the installation menu.

After entering the installation menu, move your cursor to [Drivers] tab. Click [Intel Gigabit Lan]. The following screen appears.



1. Click [Wired LAN Adapters].

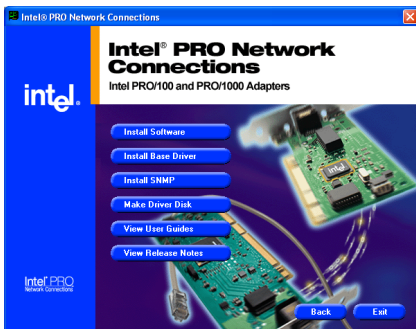

2. Click [Install Base Driver].

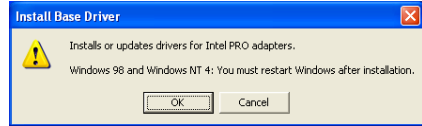

3. Click [OK] to start installing the LAN driver. (For Windows 98 and Windows NT4.0, you must restart Windows after installation.)

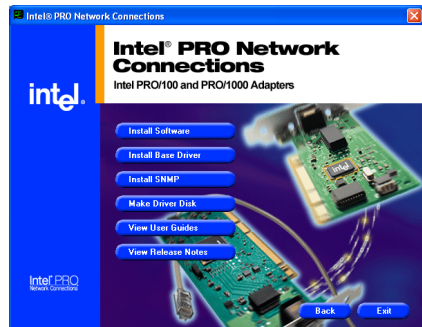

4. Click [Exit] to exit the installation.



Appendix E. Install Silicon Serial ATA RAID Driver

The installation procedures and screen shots in this section are based on Windows XP operating system. For those of other OS, please follow its on-screen instruction.

Insert the Driver & Utility CD into CD-ROM drive, it should execute the installation program automatically. If not, double-click the execution file at the main directory of this CD to enter the installation menu.

After entering the installation menu, move your cursor to [Drivers] tab. Click [Silicon Serial ATA RAID]. The following screen appears.

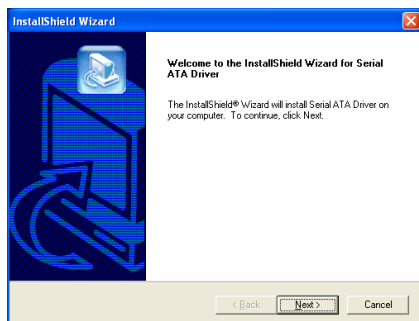

1. Click [Next].



2. Click [Continue Anyway].

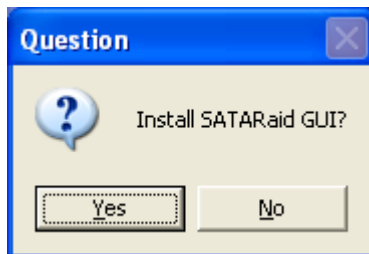

3. Click [Yes].

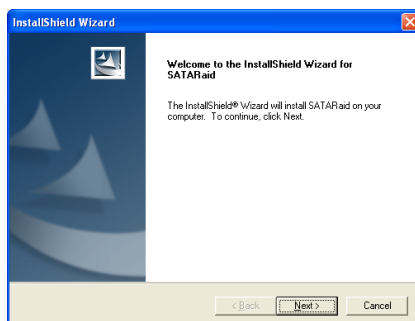

4. Click [Next].

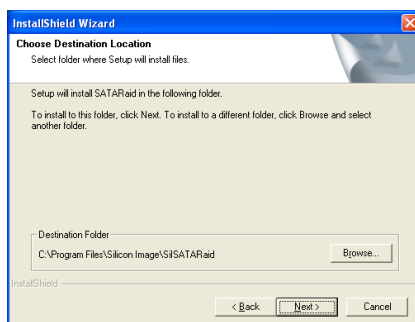

5. Click [Next].

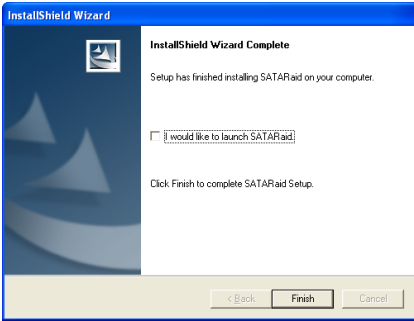

6. Click [Finish].

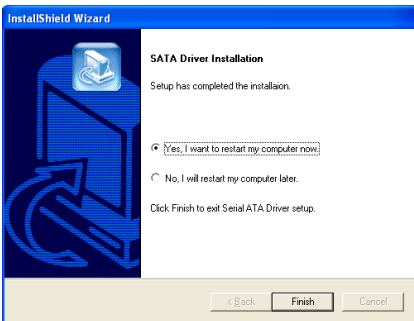

7. Choose [Yes, I want to restart my computer now.], and click [Finish] to complete setup.

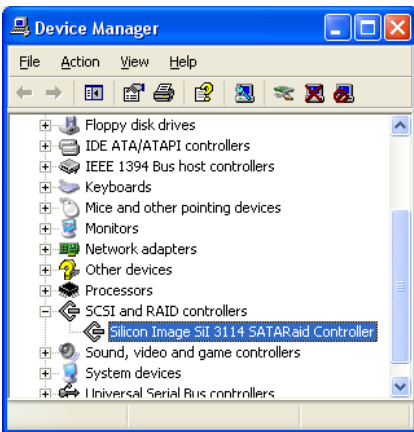

8. Check [Device Manager]. [Silicon Image SiI 3114 SATARaid Controller] is successfully installed.

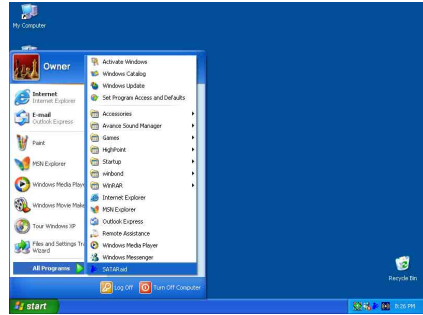

9. To run the [SATARaid] application, click [Start] → [All Programs] → [SATARaid].

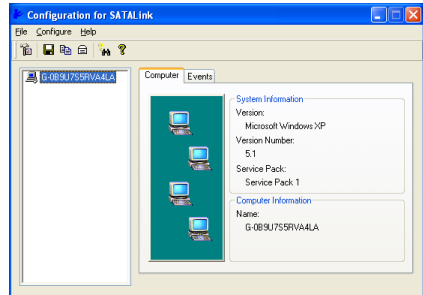

10. This is the SATALink configuration menu. For more information on how to operate, please refer to the “Help” menu.

BIOS Setup for Silicon Serial ATA RAID

This motherboard supports the RAID operation of “**Striping (RAID 0)**”, “**Mirroring (RAID 1)**”, or “**Striping/Mirroring (RAID 0+1)**” via Silicon Serial ATA controller. For the striping operation, the identical drives can read and write data in parallel to increase system performance. The Mirroring operation creates a complete backup of your files. Striping with Mirroring operation offers both read/write performance and fault tolerance.

RAID Configuration Utility Menu

Main Menu

Reboot your system. Press <CTRL> + <S> or <F4> key while booting up the system to enter the BIOS setting menu. The main menu of the BIOS Setting Utility appears as shown below:

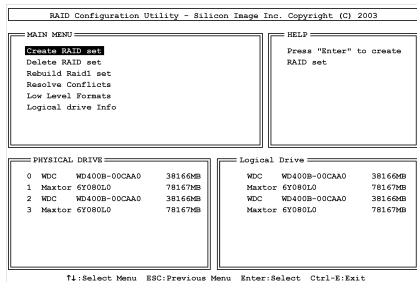

To select the option in this menu, you may:

- Press <↑ ↓> (up, down arrow) to choose the option you want to confirm or to modify.
- Press <Enter> to confirm the selection.
- Press <Esc> to return to previous menu.
- Press <Ctrl-E> to exit the RAID configuration utility.

NOTE: If you want to create a RAID 0 (striping) array or RAID 0+1 array, all the data stored in the hard disks will first be erased! Please backup the hard disk data before starting to create these RAID arrays.

If you want to create a RAID 1 (mirroring) array, please make sure which hard disk is the source disk and which one is the destination disk. If you make a mistake, you may copy the blank data to the source disk, which will result in both hard disks becoming blank!

Option 1 Create RAID set

This item allows you to create a RAID array.

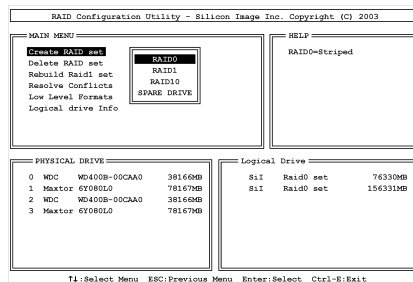

NOTE: It is highly recommended to attach hard disks with the same model in reaching the RAID performance.

RAID0: This item is recommended for **high performance** usage. Requires at least 2 disks.

RAID1: This item is recommended for **data security** usage. Requires at least 2 disks.

RAID10: This item is recommended for **data security and high performance** usage. Allows Mirroring with a Strip Array. Require 4 disks.

Option 2 Delete RAID set

This item allows you to remove a RAID Array on this onboard Serial ATA RAID controller.

NOTE: After you have made and confirmed this selection, all the data stored in the hard disk will be lost. (The entire partition configuration will be deleted too.)

Option 3 Rebuild Raid1 set

This item allows you to rebuild only “Mirrored” RAID set.

You need to check which hard disk is the source disk and which one is the destination disk when you decide to rebuild mirrored RAID set.

Option 4 Resolve Conflicts

When a RAID set is created, the metadata written to the disk includes drive connection information (Primary Channel, Secondary Channel).

If, after a disk failure, the replacement disk was previously part of a RAID set (or used in another system), it may have conflicting metadata, specifically in reference to the drive connection information. If so, this will prohibit the RAID set from being either created or rebuilt.

In order for the RAID set to function properly, this old metadata must be first overwritten with the new metadata. To resolve this, select “Resolve Conflict”. The correct metadata, including the correct drive connection information, will then be written to the replacement disk.

NOTE: For more information on RAID function, please refer to the RAID Management Software enclosed in the CD that came packed with this motherboard.

Option 5 Low Level Format

This item allows you to do the “Low Level Format” for each single HDD one at a time.

Option 6 Logical Drive Info

This item displays the drive information of the RAID type you had built.

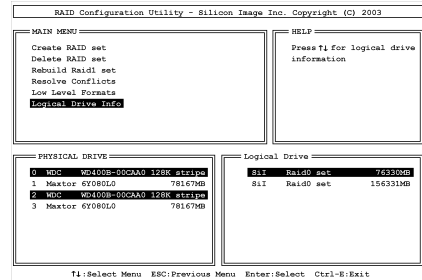

Appendix F. Install USB 2.0 Driver

NOTE: The “USB 2.0 Driver” packed in the “Driver & Utility CD” is currently available for Windows 9x and ME only. To install this driver for Windows XP or Windows 2000, you have to download their latest service pack first from Microsoft’s web site.

To install the driver for Windows 9x and ME, please insert the Driver & Utility CD into CD-ROM drive; it should execute the installation program automatically. If not, double-click the execution file at the main directory of this CD to enter the installation menu.

After entering the installation menu, move your cursor to [Drivers] tab. The following screen appears.



Click [USB 2.0 Driver]. Follow its on-screen instruction to complete the installation.



Appendix G. BIOS Update Guide

The procedure illustrated here is based on the model SE6 as an example; all other models follow the same process.

1. First, find out the model name and version number of this motherboard. You can find a bar-code sticker typed with model name and version number on motherboard PCB.
2. Find out the current BIOS ID. For example, in this case, the current BIOS ID is [00]. If you already have the latest BIOS, no any update action is necessary. If your BIOS is not the latest BIOS, go on to the next step.

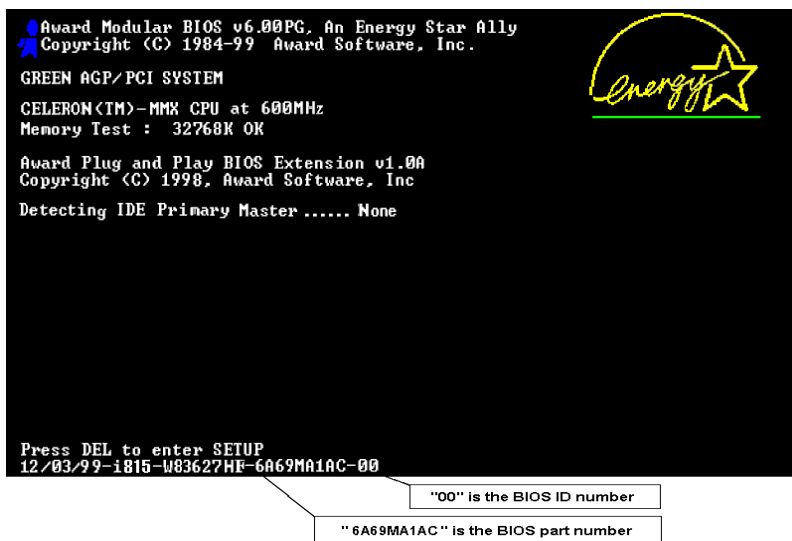

3. Download the correct BIOS file from our Web site.
4. Double click the downloaded file, it will self-extract to [awdf flash.exe] and [* .bin] files.
5. Make a bootable floppy disk and copy the necessary files onto it. You may make a floppy disk bootable either in Explorer or in the DOS prompt mode.

```
[c:\>]format a: /s
```

After formatting and transferring the system to the floppy disk, copy two files into it. One is the BIOS flash utility [awdf flash.exe] and the other is the decompressed BIOS binary [* .bin] file.

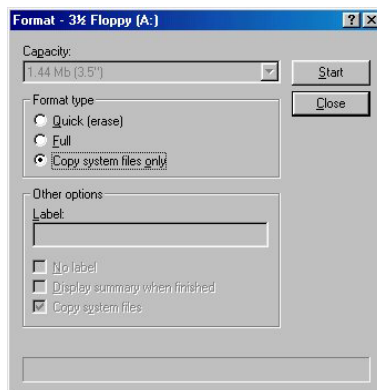

6. Please set the first boot sequence as “**Floppy**” in BIOS and boot off the floppy disk.

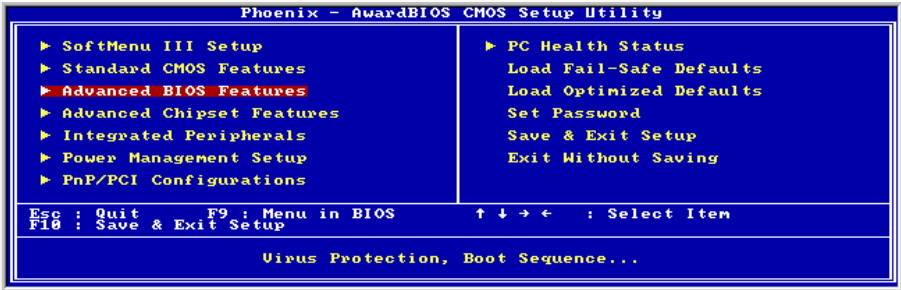

7. Flash the BIOS in pure DOS mode.

```
A: \>awdf flash se6_sw.bin /cc /cd /cp /py /sn /cks /r_
```

Note

- We strongly recommend you use the above parameters following 'awdf flash' to flash your BIOS. **DO NOT** just type “awdf flash se6_sw.bin” without the above parameters following the “.bin” file.
- The Award flash utility cannot be completed under the Windows environment. It must be done in a pure DOS environment.
- You should check which BIOS file is to be used with your motherboard, don't flash with the wrong BIOS file. Otherwise, it may cause system malfunctions.
- Please do not use the Award flash memory writer version earlier than Version 7.52C to flash the BIOS. Otherwise, it may cause flash fail or un-anticipated problems.
- During the updating, the progress will be measured by white blocks. The last four *blue* blocks of the flash update process represent the “BIOS boot block”. The BIOS boot block is used to prevent the BIOS from becoming corrupt during programming. It should not be programmed every time. If this “BIOS boot block” remains intact when the BIOS becomes corrupt during programming, then you can boot from a bootable floppy next time you boot your computer. This allows you to flash your BIOS again without the need for technical support from the dealer.

Appendix H. Hardware Monitoring (The Winbond Hardware Doctor Utility)

The Winbond Hardware Doctor is a self-diagnostic system for PCs used with Winbond W83627HF chipset. It protects PC hardware by monitoring several critical items including power supply voltages, CPU & system fan speeds and CPU and system temperatures. These items are important for the system operation. Errors may result in permanent damage to the PC. Once any item is out of its normal range, a warning message pops up reminding you to take proper measures.

The installation procedures and screen shots in this section are based on Windows XP operating system. For those of other OS, please follow its on-screen instruction.

Insert the Driver & Utility CD into CD-ROM drive, it should execute the installation program automatically. If not, double-click the execution file at the main directory of this CD to enter the installation menu.

After entering the installation menu, move your cursor to [Hardware Doctor] tab. Click [Install Hardware Doctor]. The following screen appears.

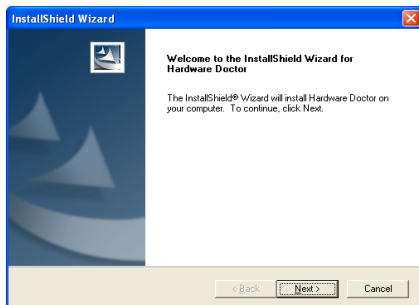

1. Click [Next].

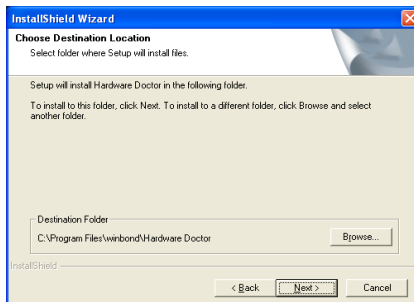

2. Click [Next].

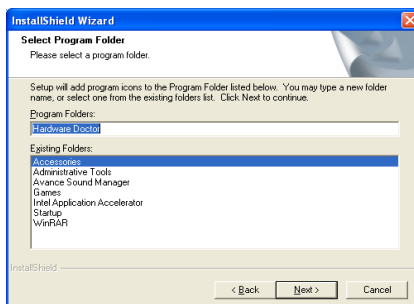

3. Click [Next].

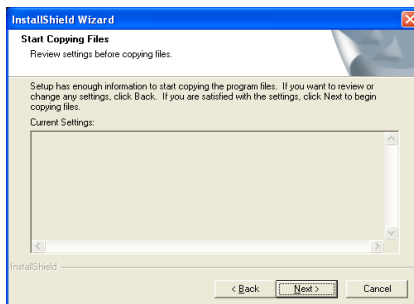

4. Click [Next].

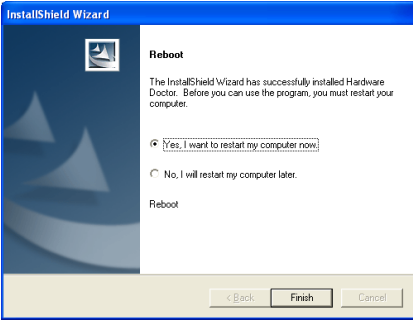

5. Choose [Yes, I want to restart my computer now.] and click [Finish] to complete setup.

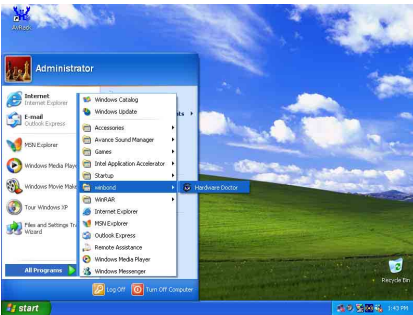

6. Execute the Hardware Doctor by entering the Windows Menu [Start] → [Programs] → [Winbond] → [Hardware Doctor].

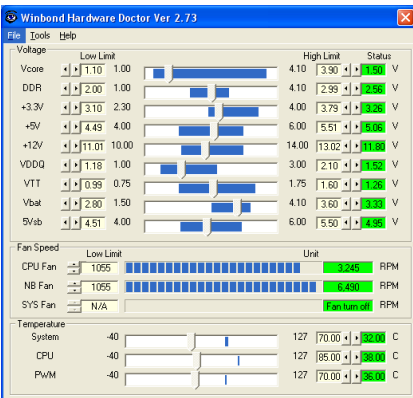

7. This screen appears. Hardware Doctor shows you the status of Voltage, Fan Speed, and Temperature readings as well. If any reading is

critical or over its limitation, the reading turns red. Also, a pop-up window appears warning you the system has a problem!



8. This is the warning message window:

Ignore: You can ignore the warning message of the item, but it will pop up again when an error of the same item reoccurs.

Disable: The chosen item will be no longer monitored thereafter, unless you activate it in the “**Configuration**” page.

Shutdown: Choosing this button will shutdown the computer.

Help: You can read more information and self-diagnose simple problems.

If the warning message pops up due to the wrong warning limit, you can adjust it in the “**Configuration**” option. For example, if you set the temperature high limit to 40°C, you will easily exceed the “proper” temperature.

Pay attention to two things when you want to make any change to the “**Configuration**” option. Firstly, you have to make sure your new setting is in the proper range. Secondly, after you finished the configuration, you have to save it. Otherwise, the program will start with the default value next time.

If you encounter any problem or have any question about the software settings and adjustments, please use the Winbond hardware doctor on-line help. It should give you enough information to answer your questions.

Appendix I. Installation Guide for Suspend to RAM

Suspend To RAM (STR) is a cost-effective, optimal implementation of the ACPI 1.0 specification. The ACPI specification defines the S3 sleep state, in which all system context is lost except system memory. CPU, cache, and chip set context are lost in this state. Hardware maintains memory context and restores some CPU and L2 configuration context.

The STR function enables a PC to achieve the S3 state during idle periods, then quick “wake up” and retrieve the last “state” of the system before it went to sleep. When idle, STR-enabled systems consume only a small fraction of the power used for full operation. Instead of shutting down the system to save power when not in use and then having to reboot later, users can let the STR function take over and not have to worry about using power to run all the electronics, fans and disks. When needed, a PC with STR function can restore all applications and features to an operational state within a few seconds.

The following description will tell you how to install the STR function and to use it.

After the operating system had been installed successfully, reboot your computer, you can see these ACPI items show up in the “Device Manager” menu by entering *Start* → *Settings* → *Control Panel* → *System* → *System Properties* → *Hardware*:

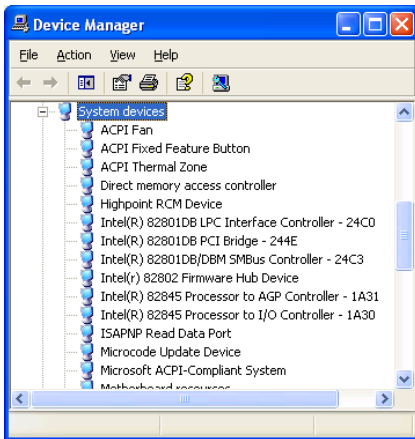

How to use the STR function:

There are two ways to put your system into STR mode:

Method 1: Select [Stand by] in the [Turn Off Computer...] area.



1. Click [Start] in the Windows Tools Bar, and then select [Turn Off Computer...]

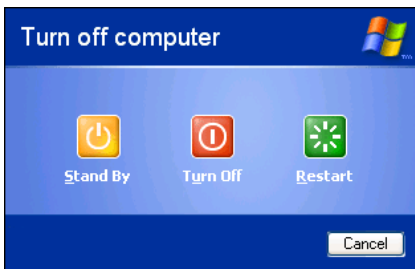

2. Click [Stand by].

Method 2: Define the chassis's [Power] button to initiate STR sleep Mode

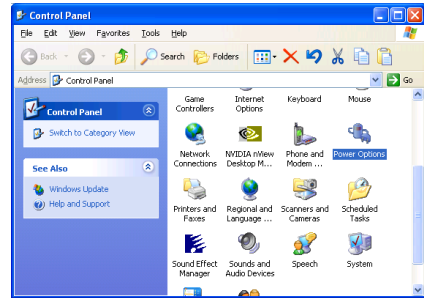

1. Open [Control Panel], and then enter [Power Options].

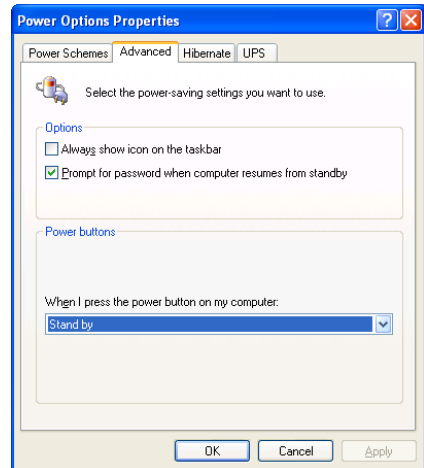

2. Select [Advanced] tab. Set the [Power Buttons] option to [Stand by].

Restart your computer to put these settings into effect. Now you will only need to press the [Power] button on the front panel of the chassis when you want to put your computer into STR sleep mode.

Appendix J. Troubleshooting (Need Assistance?)

Q & A:

Q: Do I need to clear the CMOS before I use a new motherboard to assemble my new computer system?

A: Yes, we highly recommend that you clear the CMOS before installing a new motherboard. Please move the CMOS jumper from its default 1-2 position to 2-3 for a few seconds, and then back. When you boot up your system for the first time, follow the instructions in the user's manual to load the optimized defaults.

Q: If my systems hang when I update the BIOS or set the wrong CPU parameters, what should I do?

A: Whenever you update the BIOS or if the system hangs due to wrong CPU parameters setting, always clear CMOS jumper before booting up again.

Q: Why the system failed to boot up and nothing was displayed on the screen after I did some over-clocking or non-standard settings inside the BIOS? Is the motherboard dead? Do I need to return it to where I bought from or go through an RMA process?

A: It should not cause hardware or permanent damage to motherboard when BIOS settings were changed from default to over-clocking or non-standard status.

We suggest the following three troubleshooting methods to discharge CMOS data, recover the hardware default status, and then make the motherboard working again. No need to bother returning the motherboard to where you bought from or go through an RMA process.

Step 1. Switch off the power supply unit and then switch it on again after one minute. If there is no power switch on the power supply unit, disconnect its power cord for one minute and then connect it back.

Press and hold the <Insert> key on the keyboard, press the power-on button to boot up system. If it works, loose the <Insert> key and hit key to enter the BIOS setup page to do the correct settings.

If the situation remains the same, repeat the procedures in Step 1 for three times, or try Step 2.

Step 2. Switch off the power supply unit or disconnect the power cord. Open the chassis cover. Locate the CCMOS jumper near the button battery. Change the jumper position from default 1-2 to 2-3 for one minute to discharge the CMOS data, and then put it back to default 1-2 position.

Close the chassis and switch on the power supply unit or plug in the power cord. Press the power-on button to boot up system. If it works, hit key to enter the BIOS setup page to do the correct settings.

If the situation remains the same, try Step 3.

Step 3. The same procedure as Step 2, but in the meantime of discharging the CMOS data, pull out ATX power connectors from motherboard and remove the button battery during CMOS discharging.

Q: How can I get a quick response to my request for technical support?

A: Be sure to follow the guidelines as stated in the “Technical Support Form” section of this manual.

If you have a problem during operation, in order to help our technical support personnel quickly determine the problem with your motherboard and give you the answers you need, before filling in the technical support form, eliminate any peripheral that is not related to the problem, and indicate it on the form. Fax this form to your dealer or to the company where you bought the hardware in order to benefit from our technical support. (You can refer to the examples given below)

Example 1:

With a system including: motherboard (with CPU, DRAM, COAST...) HDD, CD-ROM, FDD, VGA CARD, MPEG CARD, SCSI CARD, SOUND CARD, etc. After the system is assembled, if you cannot boot up, check the key components of the system using the procedure described below. First remove all interface cards except the VGA card and try to reboot.

If you still cannot boot up: Try installing another brand/model VGA card and see if the system will start. If it still does not start, note the VGA card model, motherboard model, Bios identification number, CPU on the technical support form (refer to main instructions), and describe the problem in the problem description space provided.

If you can boot up: Insert the interface cards you have removed back into the system, one by one and try to start the system each time you insert a card, until the system will not start. Keep the VGA card and the interface card that caused the problem inserted on the motherboard, remove any other cards or peripheral, and start again. If you still cannot start, note the information related to both cards in the add-on Card space provided, and don't forget to indicate the motherboard model, version, BIOS identification number, CPU (refer to main instructions), and give a description of the problem.

Example 2:

With a system including the motherboard (with CPU, DRAM, COAST...) HDD, CD-ROM, FDD, VGA CARD, LAN CARD, MPEG CARD, SCSI CARD, SOUND CARD, after assembly and after having installed the Sound Card Driver, when you restart the system, when it runs the Sound Card Driver, it resets automatically. This problem may be due to the Sound Card Driver. During the Starting DOS... procedure, press SHIFT (BY-PASS) key, to skip CONFIG.SYS and AUTOEXEC.BAT; edit CONFIG.SYS with a text editor, and in function the line that loads the Sound Card Driver, add a remark REM, in order to disable the Sound Card Driver. See the example below.

```
CONFIG.SYS:
DEVICE=C:\DOS\HIMEM.SYS
DEVICE=C:\DOS\EMM386.EXE HIGHSCAN
DOS=HIGH, UMB
FILES=40
BUFFERS=36
REM DEVICEHIGH=C:\PLUGPLAY\DWCFMG.MSYS
LASTDRIVE=Z
```

Restart the system. If the system starts and does not reset, you can be sure that the problem is due to the Sound Card Driver. Write down the Sound Card model, motherboard model, BIOS identification number on the technical support file (refer to main instructions), and describe the problem in the space provided.

We will show you how to fill the “Technical Support Form”.

Main instructions:

To fill in this “**Technical Support Form**”, refer to the step-by-step instructions given below:

- 1*. **MODEL:** Note the model number given in your user’s manual.
Example: IC7-MAX3
- 2*. **Motherboard model number (REV):** Note the motherboard model number labeled on the motherboard as “REV:*.**”.
Example: REV: 1.01
- 3*. **BIOS ID and Part Number:** See the on screen message.
4. **DRIVER REV:** Note the driver version number indicated on the DEVICE DRIVER disk (if any) as “Release *.*”. For example:



- 5*. **OS/APPLICATION:** Indicate the operating system and applications you are running on the system.
Example: MS-DOS® 6.22, Windows® 98 SE, Windows® 2000, etc....
- 6*. **CPU:** Indicate the brand and the speed (MHz) of your CPU.
Example:(A) In the “Brand” space, write “Intel”; in the “Specifications” space, write “Pentium® 4 1.9GHz”.
7. **HDD:** Indicate the brand and specifications of your HDD(s); specify if the HDD is using IDE1 or IDE2. If you know the disk capacity, indicate it and check (“✓”) “”; in case you give no indication, we will consider that your HDD is “IDE1” Master.
Example: In the “HDD” space, check the box; in the Brand space, write “Seagate”; in the Specifications space, write “ST31621A (1.6GB)”.
8. **CD-ROM Drive:** Indicate the brand and specifications of your CD-ROM drive. Specify if it uses IDE1 or IDE2 , and check (“✓”) “”; in case you give no indication, we will consider that your CD-ROM is “IDE2” Master.
Example: In the “CD-ROM drive” space, check the box, in the Brand space, write “Mitsumi”, in the Specifications space, write “FX-400D”.
9. **System Memory (DDR SDRAM):** Indicate the brand and specifications (DDR DIMM) of your system memory. Such as Density, Description, Module Components, Module Part Number, CAS Latency, and Speed (MHz).
For example: In the Brand space, write “**Micron**”; in the Specifications space, write: **Density:** 128MB, **Description:** SS 16 Megx72 2.5V ECC Gold, **Module Components:** (9) 16 Megx 8, **Module Part Number:** MT9VDDT1672AG, **CAS Latency:** 2, **Speed (MHz):** 200 MHz.
Please give us the detailed information of your DDR SDRAM module; it will help us to simulate the problems you met.
10. **ADD-ON CARD:** Indicate which add-on cards you are *absolutely sure* are related to the problem. If you cannot identify the problem’s origin, indicate all the add-on cards inserted into your system.

NOTE: Items between the “*” are absolutely necessary.

Appendix K. How to Get Technical Support

(From our website) <http://www.abit.com.tw>

(In North America) <http://www.abit-usa.com>

(In Europe) <http://www.abit.nl>

Thank you for choosing ABIT products. ABIT sells all our products through distributors, resellers and system integrators; we have no direct sales to end-users. Before sending email for tech support please check with your resellers or integrators if you need any services, they are the ones who sold you your system and they should know best as to what can be done, how they serve you is a good reference for future purchases.

We appreciate every customer and would like to provide the best service to you. Providing fast service to our customers is our top priority. However we receive many phone calls and a huge amount of email from all over the world. At the present time it is impossible for us to respond to every single inquiry. Therefore it is quite possible that if you send an email to us that you may not receive a response.

We have done many compatibility tests and reliability tests to make sure our products have the best quality and compatibility. In case you need service or technical support, please understand the constraint we have and **always check with the reseller who sold the product to you first.**

To expedite service, we recommend that you follow the procedures outlined below before contacting us. With your help, we can meet our commitment to provide the best service to the **greatest number of ABIT customers:**

- 1. Check the Manual.** It sounds simple but we have taken a lot of care in making a well-written and thorough manual. It is full of information that doesn't only pertain to motherboards. The CD-ROM included with your board will have the manual as well as drivers. If you don't have either one, go to our Program Download Area of the Website or FTP server.
- 2. Download latest BIOS, software or drivers.** Please go to our Program Download area on our Website to check to see if you have the latest BIOS. They are developed over periods of time to fix bugs or incompatibilities. **Also please make sure you have the latest drivers from your peripheral cards makers!**
- 3. Check the ABIT Technical Terms Guide and FAQ on our Website.** We are trying to expand and make the FAQs more helpful and information rich. Let us know if you have any suggestions. For hot topics, check out our HOT FAQ!

4. **Internet Newsgroups.** They are a great source of information and many people there can offer help. ABIT's Internet News group, alt.comp.periphs.mainboard.abit, is an ideal forum for the public to exchange information and discuss experiences they have had with ABIT products. Many times you will see that your question has already been asked before. This is a public Internet news group and it is reserved for free discussions. Here is a list of some of the more popular ones:

alt.comp.periphs.mainboard.abit

comp.sys.ibm.pc.hardware.chips

alt.comp.hardware.overclocking

alt.comp.hardware.homebuilt

alt.comp.hardware.pc-homebuilt

5. **Ask your reseller.** Your ABIT authorized distributor should be able to provide the fastest solution to your technical problem. We sell our products through distributors who sell to resellers and stores. Your reseller should be very familiar with your system configuration and should be able to solve your problem much more efficiently than we could. After all, your reseller regards you as an important customer who may purchase more products and who can urge your friends to buy from him or her as well. They integrated and sold the system to you. They should know best what your system configuration is and your problem. They should have reasonable return or refund policies. How they serve you is also a good reference for your next purchase.
6. **Contacting ABIT.** If you feel that you need to contact ABIT directly you can send email to the ABIT technical support department. First, please contact the support team for the branch office closest to you. They will be more familiar with local conditions and problems and will have better insight as to which resellers offer what products and services. Due to the huge number of emails coming in every day and other reasons, such as the time required for problem reproduction, we will not be able to reply to every email. Please understand that we are selling through distribution channels and don't have the resources to serve every end-user. However, we will try to do our best to help every customer. Please also remember that for many of our technical support team English is a second language, you will have a better chance of getting a helpful answer if your question can be understood in the first place. Be sure to use very, simple, concise language that clearly states the problem, avoid rambling or flowery language and always list your system components. Here is the contact information for our branch offices:

North America and South America:

ABIT Computer (U.S.A.) Corporation
45531 Northport Loop West,
Fremont, California 94538, U.S.A.
Tel: 1-510-623-0500
Fax: 1-510-623-1092
sales@abit-usa.com
technical@abit-usa.com
<http://www.abit-usa.com>

U.K. and Ireland:

ABIT Computer (U.K.) Corporation Ltd.
Unit 3, 24-26 Boulton Road,
Stevenage, Herts SG1 4QX, U.K.
Tel: 44-1438-228888
Fax: 44-1438-226333
sales@abitcomputer.co.uk
technical@abitcomputer.co.uk

Germany, Benelux (Belgium, Netherlands, Luxembourg), Denmark, Norway, Sweden, Finland, and Switzerland:

AMOR Computer B.V. (ABIT's European Office)
Van Coehoornstraat 7,
5916 PH Venlo, The Netherlands
Tel: 31-77-3204428
Fax: 31-77-3204420
sales@abit.nl
technical@abit.nl
<http://www.abit.nl>

Austria, Czech, Romania, Bulgaria, Yugoslavia, Slovakia, Slovenia, Croatia, Bosnia, Serbia, and Macedonia:

Asguard Computer Ges.m.b.H
Schmalbachstrasse 5,
A-2201 Gerasdorf/Wien, Austria
Tel: 43-1-7346709
Fax: 43-1-7346713
asguard@asguard.at

Japan:

ABIT Computer (Japan) Co. Ltd.
Fax: 81-3-5396-5110
<http://www.abit4u.jp>

Shanghai:

ABIT Computer (Shanghai) Co. Ltd.
Tel: 86-21-6235-1829
Fax: 86-21-6235-1832
<http://www.abit.com.cn>

Russia:

ABIT Computer (Russia) Co. Ltd.
Fax: 7-095-937-2837
techrussia@abit.com.tw
<http://www.abit.ru>

France, Italy, Spain, Portugal, and Greece:

ABIT Computer France SARL
Tel: 33-1-5858-0043
Fax: 33-1-5858-0047
<http://www.abit.fr>

All other territories not covered above please contact Taiwan Head Office:

When contacting our headquarters please Note we are located in Taiwan and we are 8+ GMT time. In addition, we have holidays that may be different from those in your country.

ABIT Computer Corporation
No.323, Yang Guang St., Neihu, Taipei, 114, Taiwan
Tel: 886-2-8751-8888
Fax: 886-2-8751-3382
sales@abit.com.tw
market@abit.com.tw
technical@abit.com.tw
<http://www.abit.com.tw>

7. **RMA Service.** If your system has been working but it just stopped, but you have not installed any new software or hardware recently, it is likely that you have a defective component. Please contact the reseller from whom you bought the product. You should be able to get RMA service there.
8. **Reporting Compatibility Problems to ABIT.** Because of tremendous number of email messages we receive every day, we are forced to give greater weight to certain types of messages than to others. For this reason, any compatibility problem that is reported to us, giving detailed system configuration information and error symptoms will receive the highest priority. For the other questions, we regret that we may not be able to reply directly. But your questions may be posted to the Internet news group in order that a larger number of users can have the benefit of the information. Please check the news group from time to time.
9. The information listed below are some **chipset vendors' WEB site addresses** for your reference:

HighPoint Technology Inc.'s WEB site: <http://www.highpoint-tech.com/>

Intel's WEB site: <http://www.intel.com/>

Silicon Image's WEB site: <http://www.siimage.com/>

SiS' WEB site: <http://www.sis.com.tw/>

VIA's WEB site: <http://www.via.com.tw/>

Thank You

ABIT Computer Corporation

<http://www.abit.com.tw>