

FCC Information and Copyright

This equipment has been tested and found to comply with the limits of a Class B digital device, pursuant to Part 15 of the FCC Rules. These limits are designed to provide reasonable protection against harmful interference in a residential installation. This equipment generates, uses and can radiate radio frequency energy and, if not installed and used in accordance with the instructions, may cause harmful interference to radio communications. There is no guarantee that interference will not occur in a particular installation.

The vendor makes no representations or warranties with respect to the contents here and specially disclaims any implied warranties of merchantability or fitness for any purpose. Further the vendor reserves the right to revise this publication and to make changes to the contents here without obligation to notify any party beforehand.

Duplication of this publication, in part or in whole, is not allowed without first obtaining the vendor's approval in writing.

The content of this user's manual is subject to be changed without notice and we will not be responsible for any mistakes found in this user's manual. All the brand and product names are trademarks of their respective companies.

Table of Contents

Chapter 1: Introduction	1
1.1 Motherboard Features	1
1.2 Package Checklist	5
1.3 Layout and Components	6
Chapter 2: Hardware Installation	7
2.1 Installing Central Processing Unit (CPU)	7
2.2 FAN Headers	9
2.3 Installing System Memory	10
2.4 Connectors and Slots	11
Chapter 3: Headers & Jumpers Setup	14
3.1 How to Setup Jumpers	14
3.2 Detail Settings	14
Chapter 4: Useful Help	21
4.1 Award BIOS Beep Code	21
4.2 Extra Information	21
4.3 Troubleshooting	23
Chapter 5: Dual Video Function	24
5.1 Requirements	24
5.2 Installing Graphics Cards	24
5.3 Things to Notice	24
Chapter 6: WarpSpeeder™	25
6.1 Introduction	25
6.2 System Requirement	25
6.3 Installation	26
6.4 [WarpSpeeder™] includes 1 tray icon and 5 panels	27

CHAPTER 1: INTRODUCTION

1.1 MOTHERBOARD FEATURES

CPU

- Supports LGA775.
- Supports Intel Pentium 4 processor up to 3.8GHz.
- Supports Intel Pentium D processor.
- Front Side Bus at the following frequency ranges:
 - 533MT/s (133MHz Core Clock)
 - 800MT/s (200MHz Core Clock)
 - 1066MT/s (266MHz Core Clock)
- Supports Hyper-Threading Technology. (HT)
- Supports Execute Disable Bit Technology (XD).
- Supports Enhanced Intel SpeedStep® Technology (EIST).
- Supports Intel Extended Memory 64 Technology (Intel EM64T).

WARNING!

Warranty will be void if the pin protection cap is not in place to protect the socket pin when sending this motherboard for service.

Chipset

- North Bridge: Intel 945P.
- South Bridge: Intel ICH7/ ICH7R(optional).

Dimensions

- ATX Form Factor: 24.4cm (W) x 29.7cm (L)

Operating System Supporting

- Supports Windows 2000, and Windows XP.

Super I/O

- Chip: ITE IT8712F.
- Low Pin Count Interface.
- Provides the most commonly used legacy Super I/O functionality.
- Environment Control initiatives,
 - H/W Monitor
 - Fan Speed Controller
 - ITE's "Smart Guardian" function

945P-A7

System Memory

- Supports dual channel DDR2 up to 8 banks.
- Supports DDR2 533 (266MHz) / 667 (333MHz) for a theoretical maximum bandwidth of 10.7 GB/s.
- Supports 256-Mb, 512-Mb, or 1G-Mb DDR technologies for x8 and x16 devices.
- Supports non-ECC DIMMs.
- Maximum DRAM space is up to 4GB.

DIMM Socket Location	DDR Module	Total Memory Size
DDR2_A1	128MB/256MB/512MB/1GB *1	Max is 4GB.
DDR2_A2	128MB/256MB/512MB/1GB *1	
DDR2_B1	128MB/256MB/512MB/1GB *1	
DDR2_B2	128MB/256MB/512MB/1GB *1	

On Board IDE (IDE1)

- One on-board connector supports 2 devices.
- Supports PIO Mode 0~4.
- Supports Ultra DMA 33/66/100 Bus Master Mode.

Extended IDE Controller (optional)

- Chip: ITE8211 (without RAID function)
 - Supports two extra slots for 4 IDE devices.
- ITE8212 (with RAID function)
 - Supports two extra slots for 4 IDE devices.
 - Integrated RAID 0, RAID 1 and RAID 0+1 for IDE2/IDE3 slot.
- IDE2/IDE3 (optional)
 - Supports up to 4 extra IDE devices.
 - Supports PIO Mode 0~4.
 - Supports Ultra DMA 33/66/100/133 Bus Master Mode.

10/100 LAN

- Chip: RTL8100C.
- Supports 10 Mb/s and 100 Mb/s auto-negotiation.
- Half/Full duplex capability.
- Supports ACPI power management.

Serial ATA

- Controller integrated in ICH7.
- Supports Serial ATA 2.0 specification.
- Data transfer rate up to 3GB/s.
- Supports 4 Serial ATA (SATA) devices.
 - Intel Advanced Host Controller (AHCI).

On Board High Definition Audio Codec

- Chip: REALTEK ALC882.
- Supports 8+2 channels.
- Supports S/PDIF-Out and S/PDIF-In (optional) functions.

Expansion Slots

- Three 32bit PCI bus master slots.
- One PCI-Express x16 slot.
- One PCI-Extreme (PCI-EX) slot.
- Two PCI-Express x1 slots (optional).

Special PCI-Express Dual Feature

This special function supports Dual Video (two graphic cards).

Note:

Please read Chapter 5 for detail information.

IEEE 1394 Chip (optional)

- Chip: VIA VT6307.
- Supports two 1394 Firewire ports with transfer rate up to 400Mb/s.

Internal On-board I/O Connectors and Headers

- 1 IDE connector supports 2 hard disk devices.
- 1 front panel header supports front panel facilities.
- 1 CD-in connector supports 1 CD-ROM audio-in device.
- 1 front audio header supports front panel audio-out function.
- 1 S/PDIF-out connector supports digital audio-out function.
- 1 S/PDIF-in connector supports digital audio-in function.
(optional)
- 1 1394A header supports 1 front panel 1394A Firewire port.
(optional)

945P-A7

- 1 chassis open header supports PC case-opened warning function.
- 1 Floppy port supports 2 FDD with 360K, 720K, 1.2M, 1.44M and 2.88Mbytes.
- 2 USB headers support 4 USB 2.0 ports.
- 4 Serial ATA connectors support 4 SATA devices.

Back Panel I/O Connectors

- 1 Serial port.
- 1 Printer port.
- 1 PS/2 Mouse port.
- 1 PS/2 Keyboard port.
- 1 1394A Firewire port. (optional)
- 1 RJ-45 LAN jack.
- 4 USB 2.0 ports.
- 6 audio ports support 8+2 channels audio-out facilities.

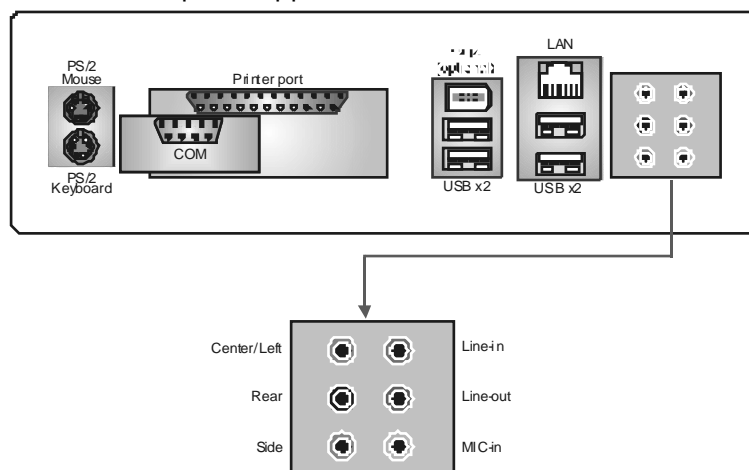

Notice for ALC882 Codec:

1. When connecting audio devices into audio ports, the audio driver will auto-detect and pop-up the port function selection window. User can choose different functions for each port according to personal preference.
2. Please make sure the audio driver is successful installed in the system, or all audio ports will be no function.
3. When rebooting the PC, each port function will return to default setting.

1.2 PACKAGE CHECKLIST

- FDD Cable X 1
- HDD Cable X 1
- User's Manual X 1
- Serial ATA Cable X 1
- Fully Setup Driver CD X 1
- Rear I/O Panel for ATX Case X 1
- USB 2.0 Cable X1 (optional)
- S/PDIF Cable X 1 (optional)
- IEEE 1394 Cable X 1 (optional)
- Retention Bracket X 1 (optional)
- Serial ATA Power Switch Cable X 1 (optional)
- Dual Video Bridge (BRI-2) Connector X 1 (optional)

945P-A7

1.3 LAYOUT AND COMPONENTS

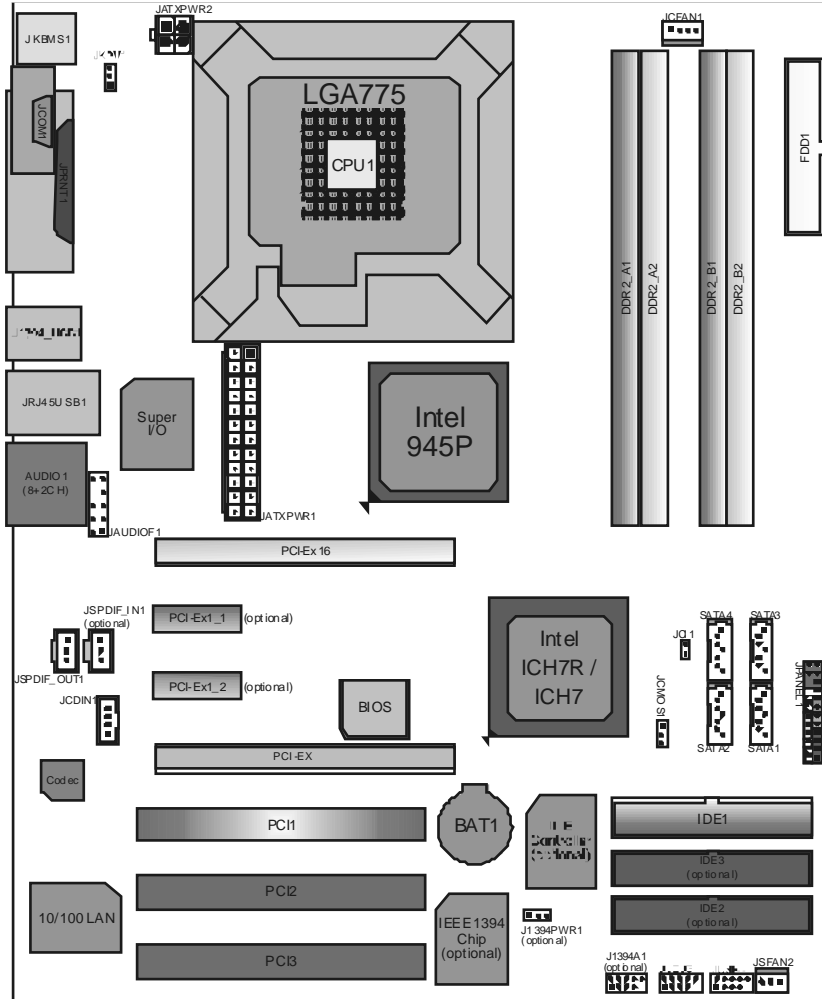

Note: ■ represents the 1st pin.

CHAPTER 2: HARDWARE INSTALLATION

2.1 INSTALLING CENTRAL PROCESSING UNIT (CPU)

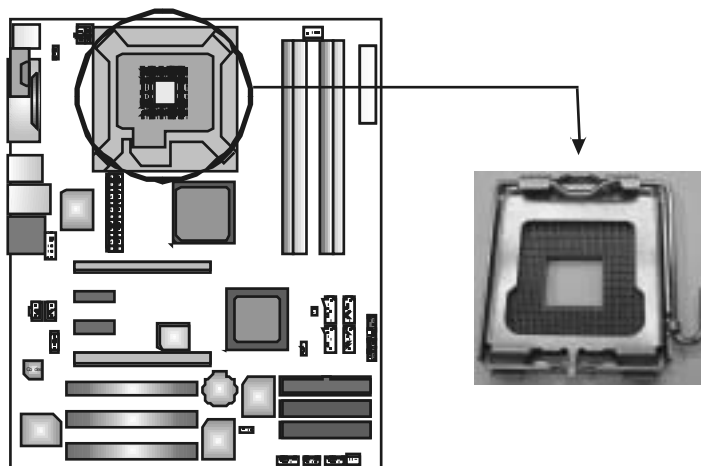

Special Notice

Remove Pin Cap before installation, and make good preservation for future use. When the CPU is removed, cover the Pin Cap on the empty socket to ensure pin legs won't be damaged.

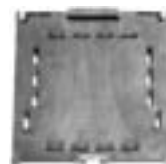

Pin Cap

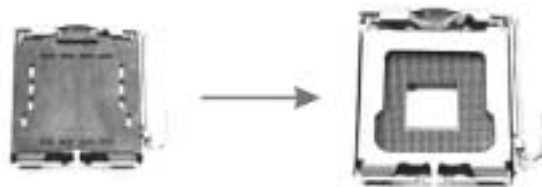

Step 1: Pull the socket locking lever out from the socket and then raise the lever up to a 90-degree angle.

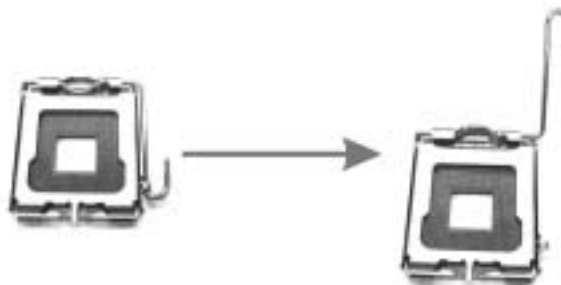

945P-A7

Step 2: Look for the triangular cut edge on socket, and the golden dot on CPU should point forwards this triangular cut edge. The CPU will fit only in the correct orientation.

Step 2-1:

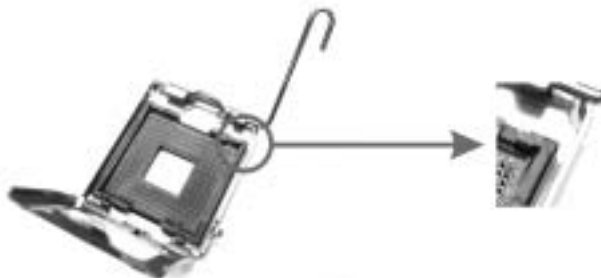

Step 2-2:

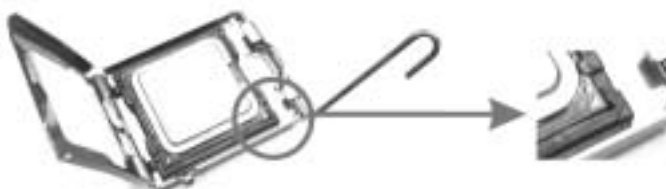

Step 3: Hold the CPU down firmly, and then lower the lever to locked position to complete the installation.



Step 4: Put the CPU Fan and heatsink assembly on the CPU and buckle it on the retention frame. Connect the CPU FAN power cable into the JCFAN1. This completes the installation.

2.2 FAN HEADERS

These fan headers support cooling-fans built in the computer. The fan cable and connector may be different according to the fan manufacturer. Connect the fan cable to the connector while matching the black wire to pin#1.

JCFAN1: CPU Fan Header

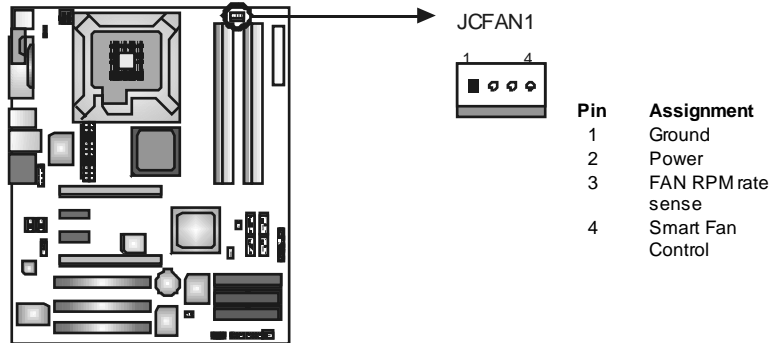

JSFAN2: System Fan Header

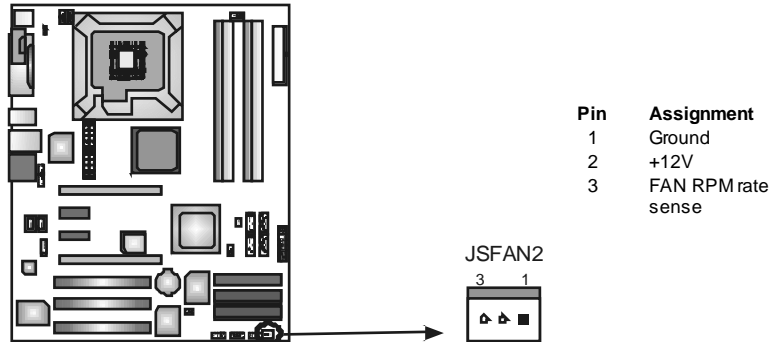

Note:

The JCFAN1 and JSFAN2 reserve system cooling fan with Smart Fan Control utility. It supports 4-pin and 3-pin header connector. When connecting with wires onto connectors, please note that the red wire is the positive and should be connected to pin#2, and the black wire is Ground and should be connected to GND.

2.3 INSTALLING SYSTEM MEMORY

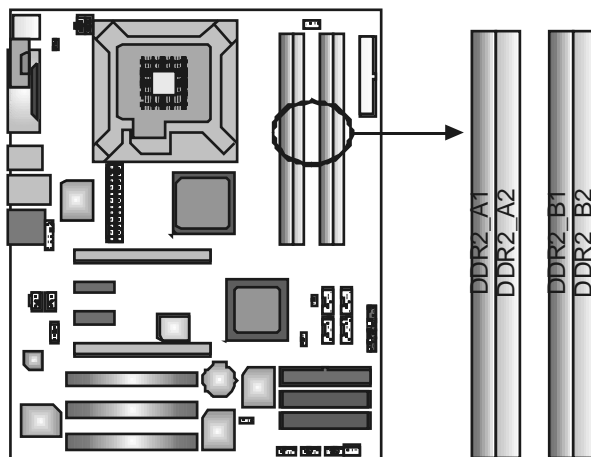

1. Unlock a DIMM slot by pressing the retaining dips outward. Align a DIMM on the slot such that the notch on the DIMM matches the break on the Slot.

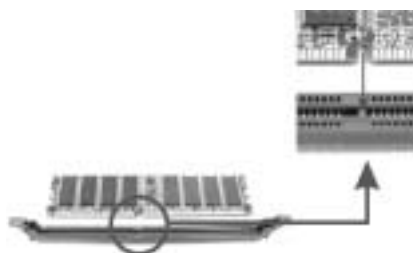

2. Insert the DIMM vertically and firmly into the slot until the retaining chip snap back in place and the DIMM is properly seated.

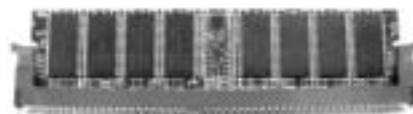

2.4 CONNECTORS AND SLOTS

FDD1: Floppy Disk Connector

The motherboard provides a standard floppy disk connector that supports 360K, 720K, 1.2M, 1.44M and 2.88M floppy disk types. This connector supports the provided floppy drive ribbon cables.

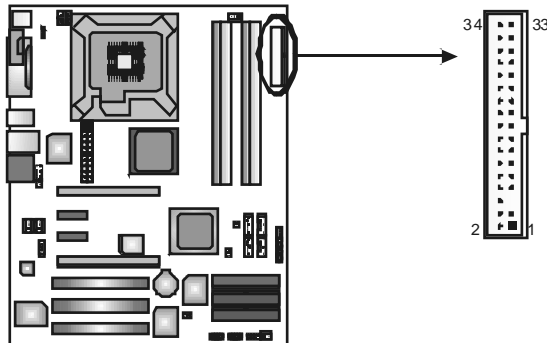

IDE1: Hard Disk Connector (IDE2 and IDE3 are optional.)

The motherboard has a 32-bit Enhanced PCI IDE Controller that provides PIO Mode 0-4, Bus Master, and Ultra DMA 33/66/100 functionality.

The IDE connectors can connect a master and a slave drive, so you can connect up to two hard disk drives. The first hard drive should always be connected to IDE1.

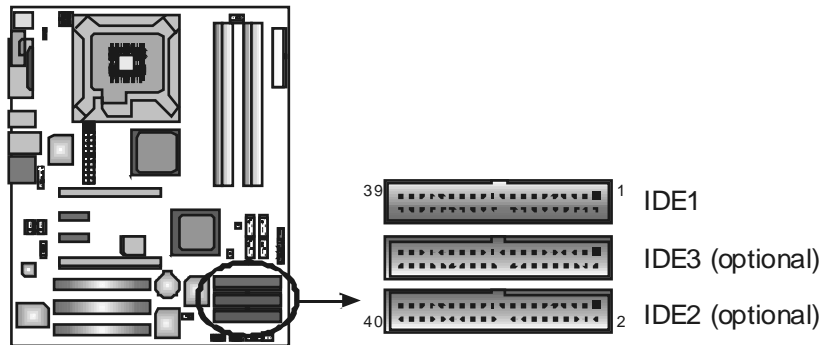

Note: IDE2/IDE3 support Ultra DMA 133.

PCI-Ex16: PCI-Express x16 Slot

- PCI-Express 1.0a compliant.
- Maximum theoretical realized bandwidth of 4GB/s simultaneously per direction, for an aggregate of 8GB/s totally.

PCI-Ex1_1/PCI-Ex1_2: PCI-Express x1 slots (optional)

- PCI-Express 1.0a compliant.
- Data transfer bandwidth up to 250MB/s per direction; 500MB/s in total.
- PCI-Express supports a raw bit-rate of 2.5Gb/s on the data pins.
- 2X bandwidth over the traditional PCI architecture.

PCI-EX: PCI-Extreme Slot

- PCI-Extreme slot is a special design for PCI-Express interface graphic cards.
- PCI-Extreme slot is compliant with PCI-Express 1.0a specification.
- PCI-Extreme slot is compatible with PCI-E x4 and PCI-E x1 expansion card.
- The bandwidth of data transfer is up to 1GB/s per direction, and for an aggregate of 2GB/s in total.

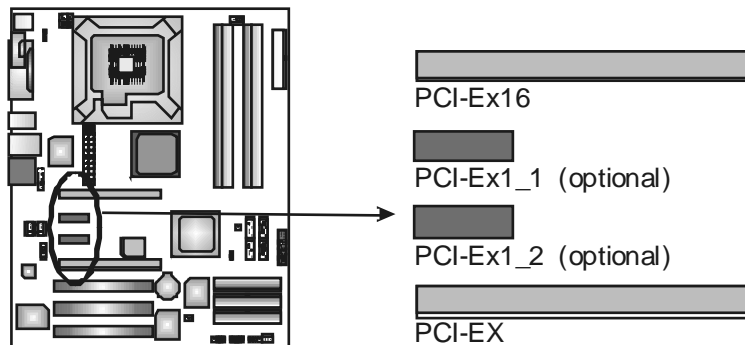

PCI1~PCI3: Peripheral Component Interconnect Slots

This motherboard is equipped with 3 standard PCI slots. PCI stands for Peripheral Component Interconnect, and it is a bus standard for expansion cards. This PCI slot is designated as 32 bits.

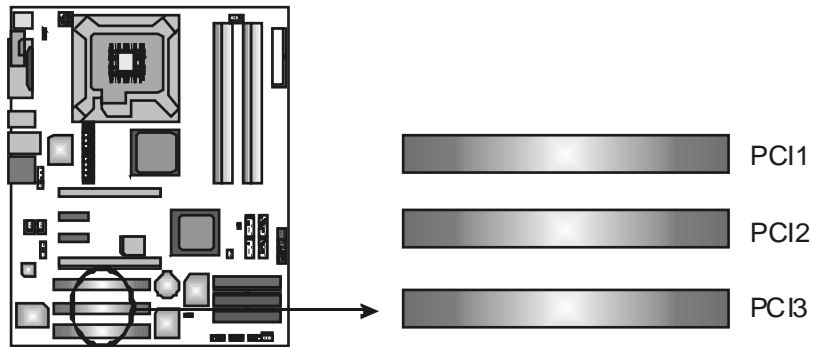

CHAPTER 3: HEADERS & JUMPERS SETUP

3.1 HOW TO SETUP JUMPERS

The illustration shows how to set up jumpers. When the jumper cap is placed on pins, the jumper is "close", if not, that means the jumper is "open".



Pin opened



Pin dosed



Pin1-2 dosed

3.2 DETAIL SETTINGS

JATXPWR1: ATX Power Connector

This connector allows user to connect 24-pin power connector on the ATX power supply.

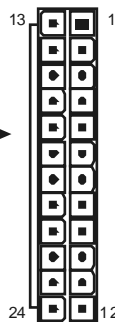
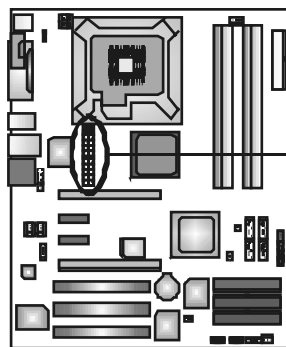

Pin	Assignment
1	+3.3V
2	+3.3V
3	Ground
4	+5V
5	Ground
6	+5V
7	Ground
8	PW_OK
9	StandbyVoltage +5V
10	+12V
11	+12V
12	2 x 12 Detect
13	+3.3V
14	-12V
15	Ground
16	PS_ON
17	Ground
18	Ground
19	Ground
20	-5V
21	+5V
22	+5V
23	+5V
24	Ground

945P-A7

JATXPWR2: ATX Power Connector

By connecting this connector, it will provide +12V to CPU power circuit.

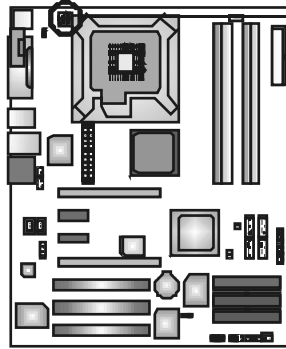

Pin	Assignment
1	+12V
2	+12V
3	Ground
4	Ground

JSPDIF_OUT1: Digital Audio-out Connector

This connector allows user to connect the PCI bracket SPDIF output header.

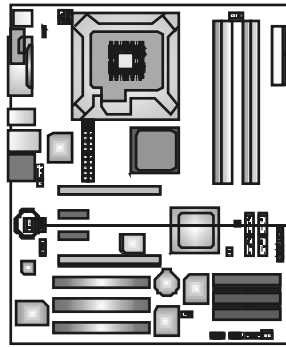

Pin	Assignment
1	+5V
2	SPDIF_OUT
3	Ground

JSPDIF_IN1 (optional): Digital Audio-in Connector

This connector allows user to connect the PCI bracket SPDIF input header.

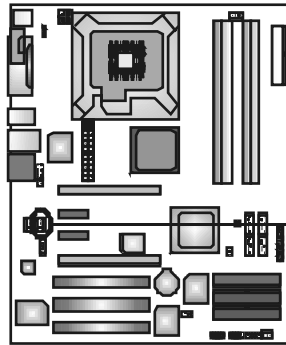

Pin	Assignment
1	+5V
2	SPDIF_IN
3	Ground

J1394A1 (optional): Header for 1394 Firewire Port at Front Panel

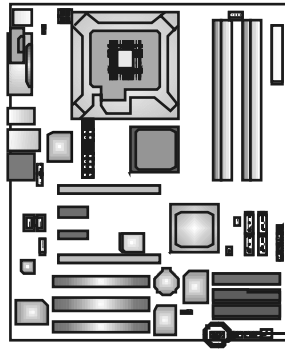

Pin	Assignment
1	A+
2	A-
3	Ground
4	Ground
5	B+
6	B-
7	+12V
8	+12V
9	Key
10	Ground

J1394PWR1 (optional): Power Source for 1394 Firewire Port

This header allows user to connect the digital image device, like DV, D8, or V8, etc.

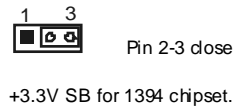
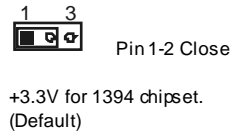
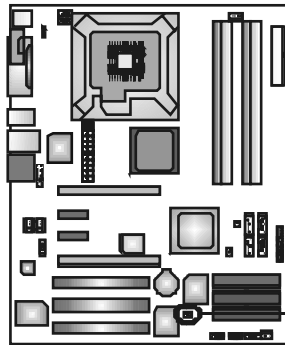

JCDIN1: CD-ROM Audio-in Connector

This connector allows user to connect the audio source from the variety devices, like CD-ROM, DVD-ROM, PCI sound card, PCI TV turner card etc..

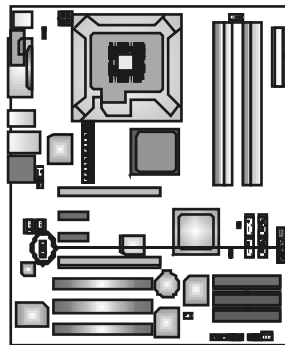

Pin	Assignment
1	Left channel input
2	Ground
3	Ground
4	Right channel input

AUDIO1: Front Panel Audio Header

This header allows users to connect the front audio output cable with the PC front panel. It will disable the output on back panel audio connectors.

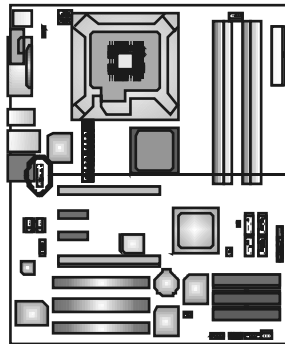

Pin	Assignment
1	Mic (L)
2	Ground
3	Mic (R)
4	PRESENCE
5	Headphone (R)
6	Jack 1 SENSE
7	Jack Detection
8	Connector Key
9	Headphone (L)
10	Jack 2 SENSE

JPANEL1: Front Panel Header

This 24-pin connector includes Power-on, Reset, HDD LED, Power LED, Sleep button, speaker and IrDA Connection. It allows users to connect the PC case's front panel switch functions.

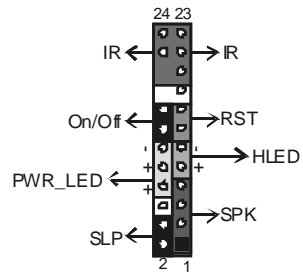
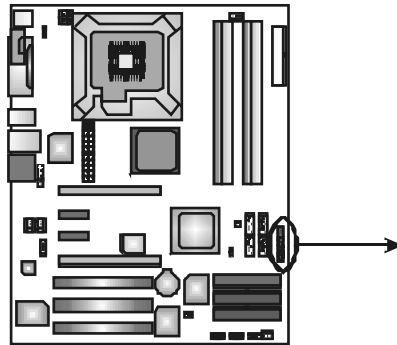

Pin	Assignment	Function	Pin	Assignment	Function
1	+5V	Speaker Connector	2	Sleep control	Sleep button
3	N/A		4	Ground	N/A
5	N/A		6	N/A	N/A
7	Speaker	Hard drive LED	8	Power LED (+)	Power LED
9	HDD LED (+)		10	Power LED (+)	
11	HDD LED (-)		12	Power LED (-)	
13	Ground	Reset button	14	Power button	Power-on button
15	Reset control		16	Ground	
17	N/A	IrDA Connector	18	Key	IrDA Connector
19	N/A		20	Key	
21	+5V		22	Ground	
23	IRTX		24	IRRX	

JKBV1: Power Source Header for PS/2 Keyboard and Mouse

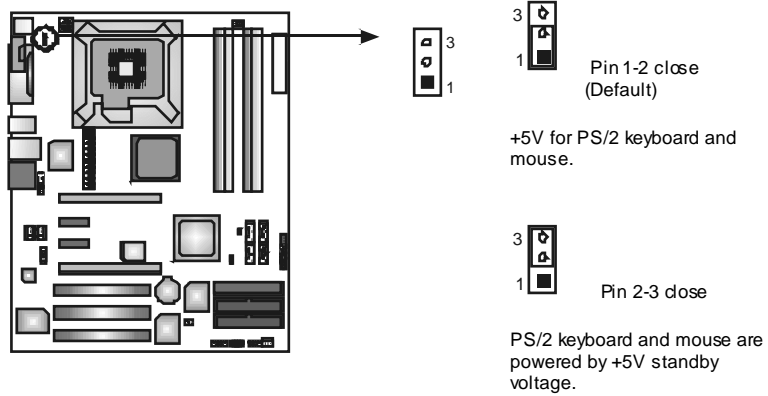

Note:

In order to support this function “Power-on system via keyboard and mouse”, “JKBV1” jumper cap should be placed on Pin 2-3.

JUSB3/JUSB4: Front USB Headers

This motherboard provides 2 USB 2.0 headers, which allows user to connect additional USB cable on the PC front panel, and also can be connected with internal USB devices, like USB card reader.

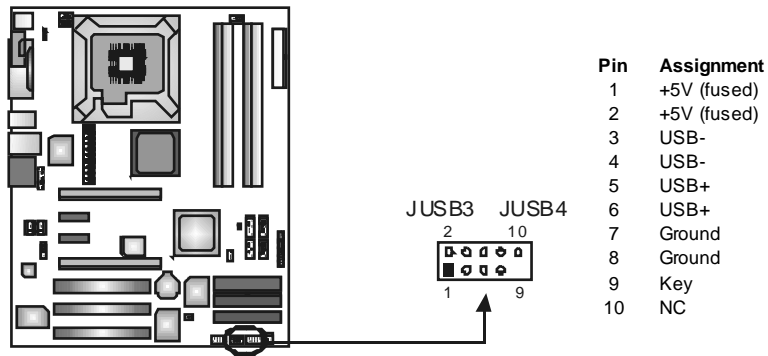

SATA1~SATA4: Serial ATA Connectors

The motherboard has a PCI to SATA Controller with 4 channels SATA interface, it satisfies the SATA 2.0 spec and with transfer rate of 3Gb/s.

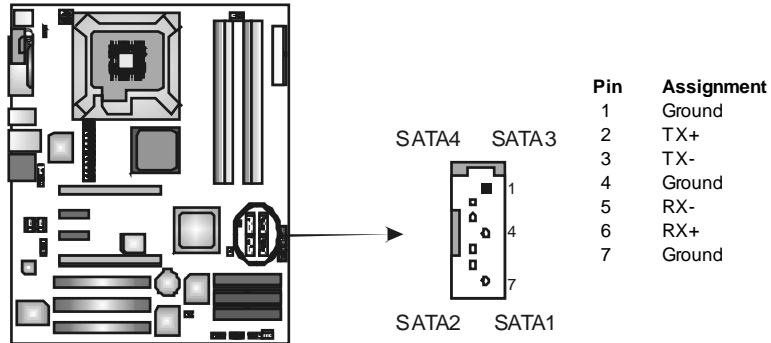

JCMOS1: Clear CMOS Header

By placing the jumper on pin2-3, it allows user to restore the BIOS safe setting and the CMOS data, please carefully follow the procedures to avoid damaging the motherboard.

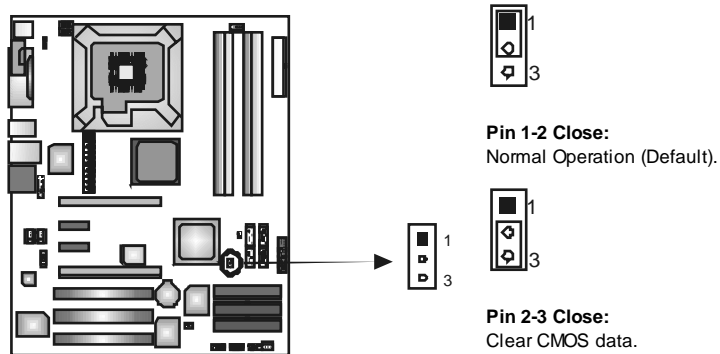

※ Clear CMOS Procedures:

1. Remove AC power line.
2. Set the jumper to "Pin 2-3 close".
3. Wait for five seconds.
4. Set the jumper to "Pin 1-2 close".
5. Power on the AC.
6. Reset your desired password or clear the CMOS data.

JCI1: Chassis Open Header

This connector allows system to monitor PC case open status. If the signal has been triggered, it will record to the CMOS and show the message on next boot-up.

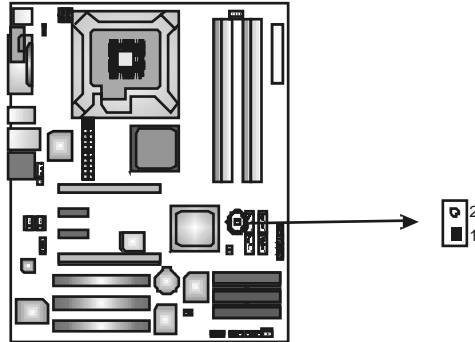

Pin	Assignment
1	Case open signal
2	Ground

CHAPTER 4: USEFUL HELP

4.1 AWARD BIOS BEEP CODE

Beep Sound	Meaning
One long beep followed by two short beeps	Video card not found or video card memory bad
High-low siren sound	CPU overheated System will shut down automatically
One Short beep when system boot-up	No error found during POST
Long beeps every other second	No DRAM detected or install

4.2 EXTRA INFORMATION

A. BIOS Update

After you fail to update BIOS or BIOS is invaded by virus, the Boot-Block function will help to restore BIOS. If the following message is shown after boot-up the system, it means the BIOS contents are corrupted.

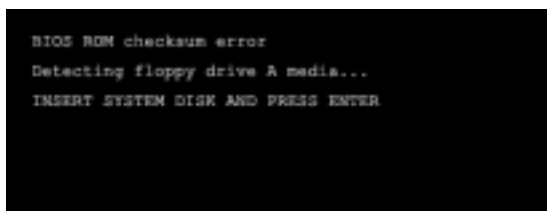

```

BIOS ROM checksum error
Detecting floppy drive A media...
INSERT SYSTEM DISK AND PRESS ENTER

```

In this Case, please follow the procedure below to restore the BIOS:

1. Make a bootable floppy disk
2. Download the Flash Utility "AWDFLASH.exe" from the Biostar website: www.biostar.com.tw
3. Confirm motherboard model and download the respectively BIOS from Biostar website.
4. Copy "AWDFLASH.exe" and respectively BIOS into floppy disk.
5. Insert the bootable disk into floppy drive and press Enter.
6. System will boot-up to DOS prompt.
7. Type "Awdflash xxxx.bf/sn/py/r" in DOS prompt.
8. System will update BIOS automatically and restart.
9. The BIOS has been recovered and will work properly.

B. CPU Overheated

If the system shutdown automatically after power on system for seconds, that means the CPU protection function has been activated.

When the CPU is over heated, the motherboard will shutdown automatically to avoid a damage of the CPU, and the system may not power on again.

In this case, please double check:

1. The CPU cooler surface is placed evenly with the CPU surface.
2. CPU fan is rotated normally.
3. CPU fan speed is fulfilling with the CPU speed.

After confirmed, please follow steps below to relief the CPU protection function.

1. Remove the power cord from power supply for seconds.
2. Wait for seconds.
3. Plug in the power cord and boot up the system.

Or you can:

1. Clear the CMOS data.
(See "Close CMOS Header: JCMOS1" section)
2. Wait for seconds.
3. Power on the system again.

4.3 TROUBLESHOOTING

Problem	Solution
1. No power to the system at all. Power light don't illuminate, fan inside power supply does not turn on. 2. Indicator light on key board does not turn on.	1. Make sure power cable is securely plugged in. 2. Replace cable. 3. Contact technical support.
System inoperative. Keyboard lights are on, power indicator lights are lit, and hard drive is spinning.	Using even pressure on both ends of the DIMM, press down firmly until the module snaps into place.
System does not boot from hard disk drive, can be booted from optical drive.	1. Check cable running from disk to disk controller board. Make sure both ends are securely plugged in; check the drive type in the standard CMOS setup. 2. Backing up the hard drive is extremely important. All hard disks are capable of breaking down at any time.
System only boots from optical drive. Hard disk can be read and applications can be used but booting from hard disk is impossible.	1. Back up data and applications files. 2. Reformat the hard drive. Re-install applications and data using backup disks.
Screen message says "Invalid Configuration" or "CMOS Failure."	Review system's equipment. Make sure correct information is in setup.
Cannot boot system after installing second hard drive.	1. Set master/slave jumpers correctly. 2. Run SETUP program and select correct drive types. Call the drive manufacturer for compatibility with other drives.

CHAPTER 5: DUAL VIDEO FUNCTION

5.1 REQUIREMENTS

- Only Windows XP supports Dual Video function.
- Two identical graphics cards that are NVIDIA certified.
- The graphics card driver should support NVIDIA SLI technology.
- The power supply unit must provide at least the minimum power required by the system, or the system will be unstable.

5.2 INSTALLING GRAPHICS CARDS

- Step 1: Prepare two graphics cards with PCI-E x16 interface.
- Step 2: Insert the first one graphics card into the yellow slot (PCI-Ex16).
- Step 3: Insert the second graphics card into the white slot (PCI-EX).

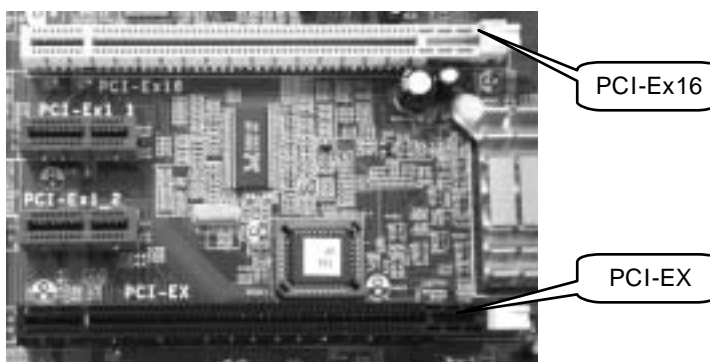

Notice:
Make sure both the graphics cards are seated into slots completely.

5.3 THINGS TO NOTICE

- Normal Mode:
 - Only PCI-Ex16 slot supports PCI-Express x16 interface graphics card function.
 - PCI-EX slot supports PCI-Express x4 interface expansion card function.
- Dual Video Mode:
 - Use Dual Video Bridge (BRI-2) connector to link two identical PCI-E x16 interface graphics cards that are NVIDIA certified.
 - Coordinate with graphics card driver to set Dual Video function.

CHAPTER 6: WARPSPEEDER™



6.1 INTRODUCTION

[WarpSpeeder™], a new powerful control utility, features three user-friendly functions including Overclock Manager, Overvoltage Manager, and Hardware Monitor.

With the Overclock Manager, users can easily adjust the frequency they prefer or they can get the best CPU performance with just one click. The Overvoltage Manager, on the other hand, helps to power up CPU core voltage and Memory voltage. The cool Hardware Monitor smartly indicates the temperatures, voltage and CPU fan speed as well as the chipset information. Also, in the About panel, you can get detail descriptions about BIOS model and chipsets. In addition, the frequency status of CPU, memory, AGP and PCI along with the CPU speed are synchronically shown on our main panel.

Moreover, to protect users' computer systems if the setting is not appropriate when testing and results in system fail or hang, [WarpSpeeder™] technology assures the system stability by automatically rebooting the computer and then restart to a speed that is either the original system speed or a suitable one.

6.2 SYSTEM REQUIREMENT

OS Support: Windows 98 SE, Windows Me, Windows 2000, Windows XP
DirectX: DirectX 8.1 or above. (The Windows XP operating system includes DirectX 8.1. If you use Windows XP, you do not need to install DirectX 8.1.)

6.3 INSTALLATION

1. Execute the setup execution file, and then the following dialog will pop up. Please click “Next” button and follow the default procedure to install.



2. When you see the following dialog in setup procedure, it means setup is completed. If the “Launch the WarpSpeeder Tray Utility” checkbox is checked, the Tray Icon utility and [WarpSpeeder™] utility will be automatically and immediately launched after you click “Finish” button.



Usage:

The following figures are just only for reference, the screen printed in this user manual will change according to your motherboard on hand.

6.4 [WARPSPEEDER™] INCLUDES 1 TRAY ICON AND 5 PANELS

1. Tray Icon:

Whenever the Tray Icon utility is launched, it will display a little tray icon on the right side of Windows Taskbar.

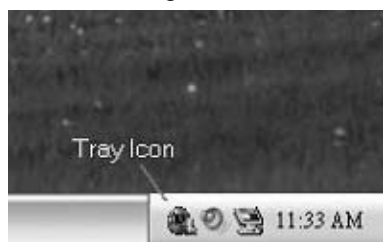

This utility is responsible for conveniently invoking [WarpSpeeder™] Utility. You can use the mouse by clicking the left button in order to invoke [WarpSpeeder™] directly from the little tray icon or you can right-click the little tray icon to pop up a popup menu as following figure. The "Launch Utility" item in the popup menu has the same function as mouse left-click on tray icon and "Exit" item will close Tray Icon utility if selected.

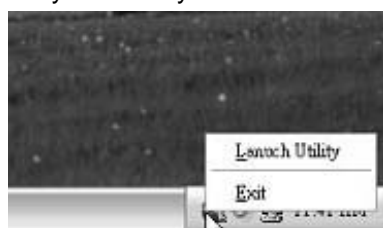

2. Main Panel

If you click the tray icon, [WarpSpeeder™] utility will be invoked. Please refer to the following figure; the utility's first window you will see is Main Panel.

Main Panel contains features as follows:

- a. Display the CPU Speed, CPU external dock, Memory dock, AGP dock, and PCI dock information.
- b. Contains About, Voltage, Overclock, and Hardware Monitor Buttons for invoking respective panels.
- c. With a user-friendly Status Animation, it can represent 3 overclock percentage stages:
 - Man walking → overclock percentage from 100% ~ 110 %
 - Panther running → overclock percentage from 110% ~ 120%
 - Car racing → overclock percentage from 120% ~ above

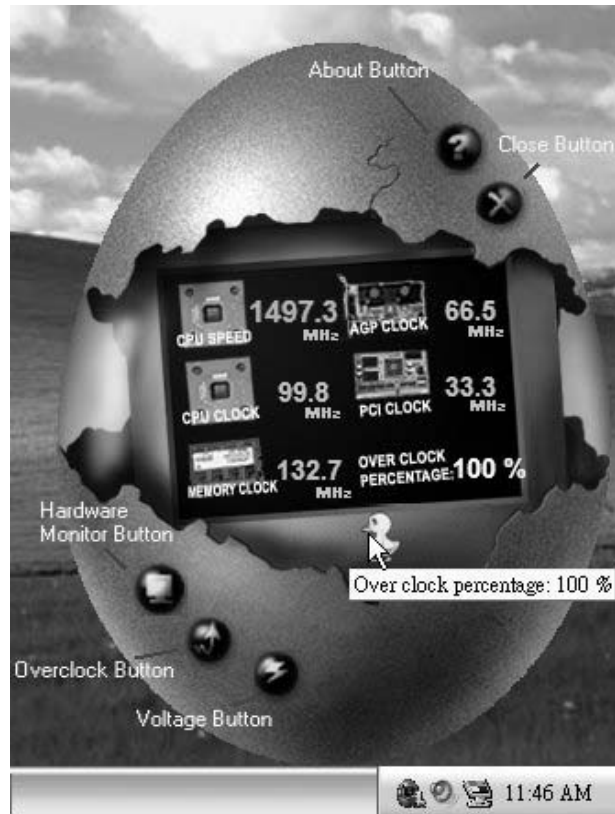

3. Voltage Panel

Click the Voltage button in Main Panel, the button will be highlighted and the Voltage Panel will slide out to up as the following figure.

In this panel, you can decide to increase CPU core voltage and Memory voltage or not. The default setting is "No". If you want to get the best performance of overlocking, we recommend you click the option "Yes".



4. Overclock Panel

Click the Overclock button in Main Panel, the button will be highlighted and the Overclock Panel will slide out to left as the following figure.



Overclock Panel contains the these features:

- a. “-3MHz button”, “-1MHz button”, “+1MHz button”, and “+3MHz button”: provide user the ability to do real-time overclock adjustment.

Warning:

Manually overclock is potentially dangerous, especially when the overlocking percentage is over 110 %. We strongly recommend you verify every speed you overclock by click the Verify button. Or, you can just click Auto overlock button and let [WarpSpeeder™] automatically gets the best result for you.

- b. “Recovery Dialog button”: Pop up the following dialog. Let user select a restoring way if system need to do a fail-safe reboot.

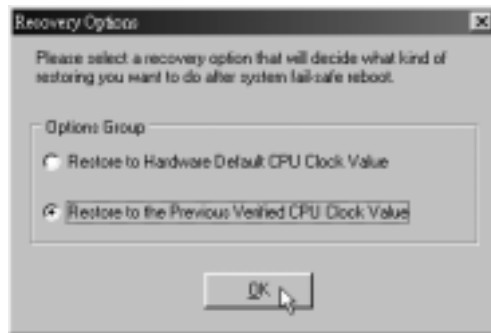

945P-A7

- c. "Auto-overclock button": User can click this button and [WarpSpeeder™] will set the best and stable performance and frequency automatically. [WarpSpeeder™] utility will execute a series of testing until system fail. Then system will do fail-safe reboot by using Watchdog function. After reboot, the [WarpSpeeder™] utility will restore to the hardware default setting or load the verified best and stable frequency according to the Recovery Dialog's setting.
- d. "Verify button": User can click this button and [WarpSpeeder™] will proceed a testing for current frequency. If the testing is ok, then the current frequency will be saved into system registry. If the testing fail, system will do a fail-safe rebooting. After reboot, the [WarpSpeeder™] utility will restore to the hardware default setting or load the verified best and stable frequency according to the Recovery Dialog's setting.

Note:

Because the testing programs, invoked in Auto-overclock and Verify, include DirectDraw, Direct3D and DirectShow tests, the DirectX 8.1 or newer runtime library is required. And please make sure your display card's color depth is High color (16 bit) or True color (24/32 bit) that is required for Direct3D rendering.

5. **Hardware Monitor Panel**

Click the Hardware Monitor button in Main Panel, the button will be highlighted and the Hardware Monitor panel will slide out to left as the following figure.

In this panel, you can get the real-time status information of your system. The information will be refreshed every 1 second.



6. About Panel

Click the “about” button in Main Panel, the button will be highlighted and the About Panel will slide out to up as the following figure.

In this panel, you can get model name and detail information in hints of all the chipset that are related to overclocking. You can also get the mainboard’s BIOS model and the Version number of [WarpSpeeder™] utility.

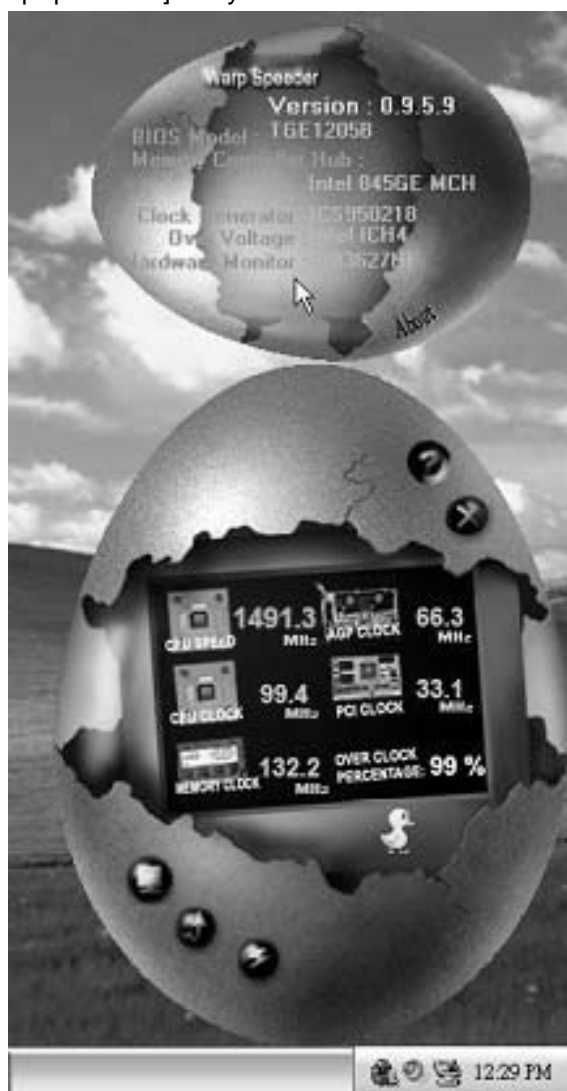

945P-A7

Note:

Because the overclock, overvoltage, and hardware monitor features are controlled by several separate chipset, [WarpSpeeder™] divide these features to separate panels. If one chipset is not on board, the correlative button in Main panel will be disabled, but will not interfere other panels' functions. This property can make [WarpSpeeder™] utility more robust.

945P-A7 BIOS SETUP

BIOS Setup	1
1 Main Menu.....	3
2 Standard CMOS Features	6
3 Advanced BIOS Features.....	9
4 Advanced Chipset Features.....	15
5 Integrated Peripherals	18
6 Power Management Setup	25
7 PnP/PCI Configurations	31
8 PC Health Status	33
9 Frequency Control	34

945P-A7 BIOS Manual

BIOS Setup

Introduction

This manual discussed Award™ Setup program built into the ROM BIOS. The Setup program allows users to modify the basic system configuration. This special information is then stored in battery-backed RAM so that it retains the Setup information when the power is turned off.

The Award BIOS™ installed in your computer system's ROM (Read Only Memory) is a custom version of an industry standard BIOS. This means that it supports Intel Pentium® 4 processor input/output system. The BIOS provides critical low-level support for standard devices such as disk drives and serial and parallel ports.

Adding important has customized the Award BIOS™, but nonstandard, features such as virus and password protection as well as special support for detailed fine-tuning of the chipset controlling the entire system.

The rest of this manual is intended to guide you through the process of configuring your system using Setup.

Plug and Play Support

These AWARD BIOS supports the Plug and Play Version 1.0A specification. ESCD (Extended System Configuration Data) write is supported.

EPA Green PC Support

This AWARD BIOS supports Version 1.03 of the EPA Green PC specification.

APM Support

These AWARD BIOS supports Version 1.1&1.2 of the Advanced Power Management (APM) specification. Power management features are implemented via the System Management Interrupt (SMI). Sleep and Suspend power management modes are supported. Power to the hard disk drives and video monitors can be managed by this AWARD BIOS.

ACPI Support

Award ACPI BIOS support Version 1.0 of Advanced Configuration and Power interface specification (ACPI). It provides ASL code for power management and device configuration capabilities as defined in the ACPI specification, developed by Microsoft, Intel and Toshiba.

945P-A7 BIOS Manual

PCI Bus Support

This AWARD BIOS also supports Version 2.1 of the Intel PCI (Peripheral Component Interconnect) local bus specification.

DRAM Support

DDR SDRAM (Double Data Rate Synchronous DRAM) are supported.

Supported CPUs

This AWARD BIOS supports the Intel CPU.

Using Setup

In general, you use the arrow keys to highlight items, press <Enter> to select, use the <PgUp> and <PgDn> keys to change entries, press <F1> for help and press <Esc> to quit. The following table provides more detail about how to navigate in the Setup program by using the keyboard.

Keystroke	Function
Up arrow	Move to previous item
Down arrow	Move to next item
Left arrow	Move to the item on the left (menu bar)
Right arrow	Move to the item on the right (menu bar)
Move Enter	Move to the item you desired
PgUp key	Increase the numeric value or make changes
PgDn key	Decrease the numeric value or make changes
+ Key	Increase the numeric value or make changes
- Key	Decrease the numeric value or make changes
Esc key	Main Menu – Quit and not save changes into CMOS Status Page Setup Menu and Option Page Setup Menu – Exit Current page and return to Main Menu
F1 key	General help on Setup navigation keys
F5 key	Load previous values from CMOS
F7 key	Load the optimized defaults
F10 key	Save all the CMOS changes and exit

945P-A7 BIOS Manual

1 Main Menu

Once you enter Award BIOS™ CMOS Setup Utility, the Main Menu will appear on the screen. The Main Menu allows you to select from several setup functions. Use the arrow keys to select among the items and press <Enter> to accept and enter the sub-menu.

!! WARNING !!

The information about BIOS defaults on manual (**Figure 1,2,3,4,5,6,7,8,9**) is just for reference, please refer to the BIOS installed on board, for update information.

■ **Figure 1. Main Menu**

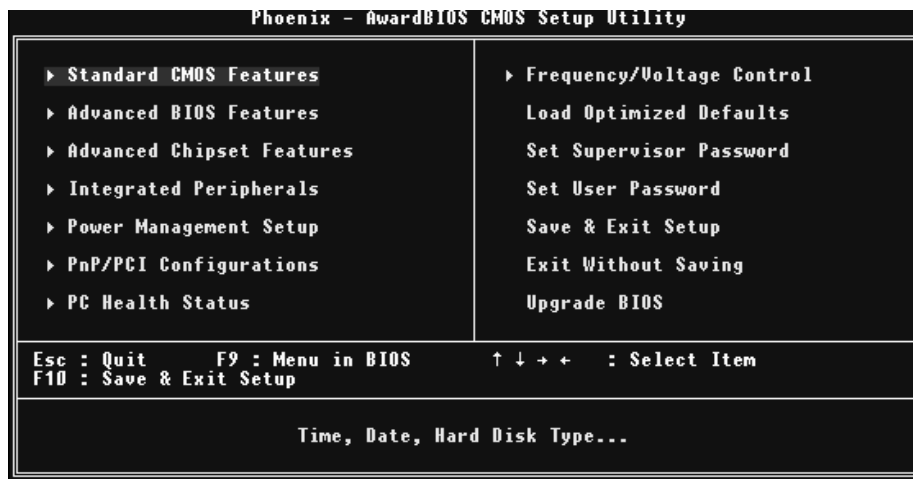

Standard CMOS Features

This submenu contains industry standard configurable options.

Advanced BIOS Features

This submenu allows you to configure enhanced features of the BIOS.

Advanced Chipset Features

This submenu allows you to configure special chipset features.

945P-A7 BIOS Manual

Integrated Peripherals

This submenu allows you to configure certain IDE hard drive options and Programmed Input/ Output features.

Power Management Setup

This submenu allows you to configure the power management features.

PnP/PCI Configurations

This submenu allows you to configure certain "Plug and Play" and PCI options.

PC Health Status

This submenu allows you to monitor the hardware of your system.

Frequency/ Voltage Control

This submenu allows you to change CPU Vcore Voltage and CPU/PCI clock. **(However, this function is strongly recommended not to use. Not properly change the voltage and clock may cause the CPU or M/B damage!)**

Load Optimized Defaults

This selection allows you to reload the BIOS when the system is having problems particularly with the boot sequence. These configurations are factory settings optimized for this system. A confirmation message will be displayed before defaults are set.

```
Load Optimized Defaults <Y/N>? N
```

Set Supervisor Password

Setting the supervisor password will prohibit everyone except the supervisor from making changes using the CMOS Setup Utility. You will be prompted with to enter a password.

```
Enter Password:
```

945P-A7 BIOS Manual

Set User Password

If the Supervisor Password is not set, then the User Password will function in the same way as the Supervisor Password. If the Supervisor Password is set and the User Password is set, the "User" will only be able to view configurations but will not be able to change them.

```
Enter Password:
```

Save & Exit Setup

Save all configuration changes to CMOS(memory) and exit setup. Confirmation message will be displayed before proceeding

```
SAUE to CMOS and EXIT <Y/N>? Y
```

Exit Without Saving

Abandon all changes made during the current session and exit setup. confirmation message will be displayed before proceeding

```
Quit Without Saving <Y/N>? N
```

Upgrade BIOS

This submenu allows you to upgrade bios.

```
BIOS UPDATE UTILITY <Y/N>? Y
```

945P-A7 BIOS Manual

2 Standard CMOS Features

The items in Standard CMOS Setup Menu are divided into 10 categories. Each category includes no, one or more than one setup items. Use the arrow keys to highlight the item and then use the <PgUp> or <PgDn> keys to select the value you want in each item.

■ Figure 2. Standard CMOS Setup

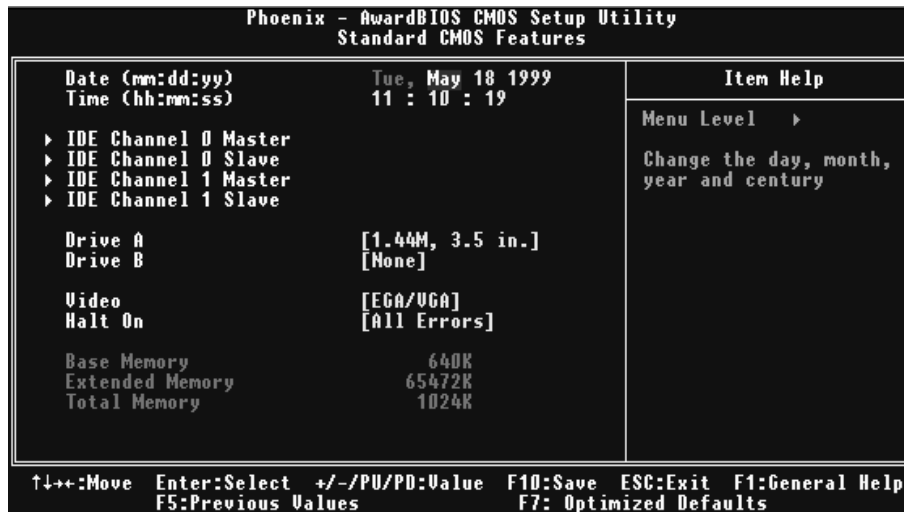

945P-A7 BIOS Manual

Main Menu Selections

This table shows the selections that you can make on the Main Menu.

Item	Options	Description
Date	mm : dd : yy	Set the system date. Note that the 'Day' automatically changes when you set the date.
Time	hh : mm : ss	Set the system internal clock.
IDE Primary Master	Options are in its sub menu.	Press <Enter> to enter the sub menu of detailed options
IDE Primary Slave	Options are in its sub menu.	Press <Enter> to enter the sub menu of detailed options.
IDE Secondary Master	Options are in its sub menu.	Press <Enter> to enter the sub menu of detailed options.
IDE Secondary Slave	Options are in its sub menu.	Press <Enter> to enter the sub menu of detailed options.
Drive A Drive B	360K, 5.25 in 1.2M, 5.25 in 720K, 3.5 in 1.44M, 3.5 in 2.88M, 3.5 in None	Select the type of floppy disk drive installed in your system.
Video	EGA/VGA CGA 40 CGA 80 MONO	Select the default video device.

945P-A7 BIOS Manual

Item	Options	Description
Halt On	All Errors No Errors All, but Keyboard All, but Diskette All, but Disk/ Key	Select the situation in which you want the BIOS to stop the POST process and notify you.
Base Memory	N/A	Displays the amount of conventional memory detected during boot up.
Extended Memory	N/A	Displays the amount of extended memory detected during boot up.
Total Memory	N/A	Displays the total memory available in the system.

945P-A7 BIOS Manual

3 Advanced BIOS Features

■ Figure 3. Advanced BIOS Setup

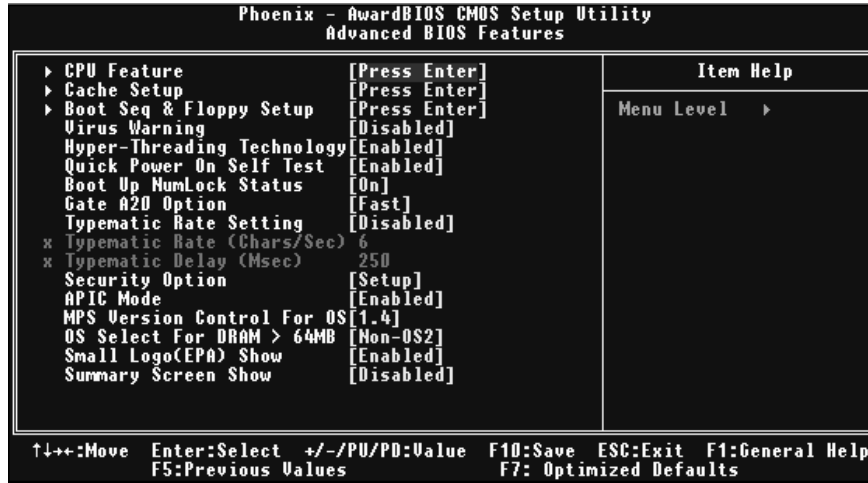

945P-A7 BIOS Manual

CPU FEATURE

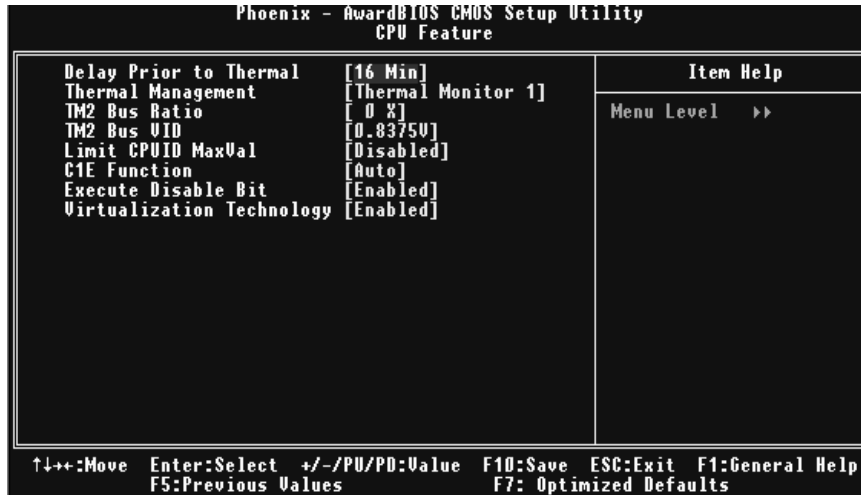

Delay Prior to Thermal

Set this item to enable the CPU Thermal function to engage after the specified time.
The Choices: 4Min, 8Min, 16Min (default), 32Min.

Thermal Management

Allow you to choose the thermal management method of your monitor.

The Choices: Thermal Monitor 1 (default), Thermal Monitor2.

Notes: The choices will be different according to your CPU features.

TM2 Bus Ratio

Represents the frequency. Bus ratio of the throttled performance state that will be initiated when the on-die sensor goes from not hot to hot.

The Choices: 0X (default).

TM2 Bus VID

Represents the voltage of the throttled performance state that will be initiated when the on-die sensor goes from not hot to hot.

The Choices: 0.8375V (default).

Limit CPU ID MaxVal

Set limit CPU ID maximum vale to 3, it should be disabled for Win XP.

The Choices: Disabled (default), Enabled.

945P-A7 BIOS Manual

C1E Function

CPU C1E Function select.

The Choices: Auto (default)

Execute Disable Bit

When disabled, forces the XD feature flag to always return 0.

The Choices: Enabled (default), Disabled.

Virtualization Technology

When enabled, a VMM can utilize the additional hardware

Capabilities provided by vanderpool Technology.

The Choices: Enabled (default), Disabled

CACHE SETUP

CPU L3 Cache

Depending on the CPU/chipset in use, you may be able to increase memory access time with this option.

Enabled (default)	Enable cache.
Disabled	Disable cache.

BOOT SEQ & FLOPPY SETUP

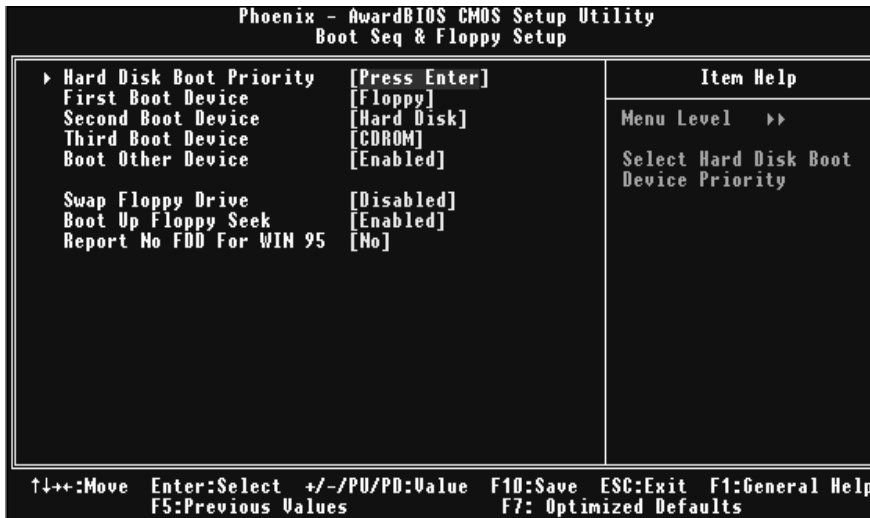

945P-A7 BIOS Manual

Hard Disk Boot Priority

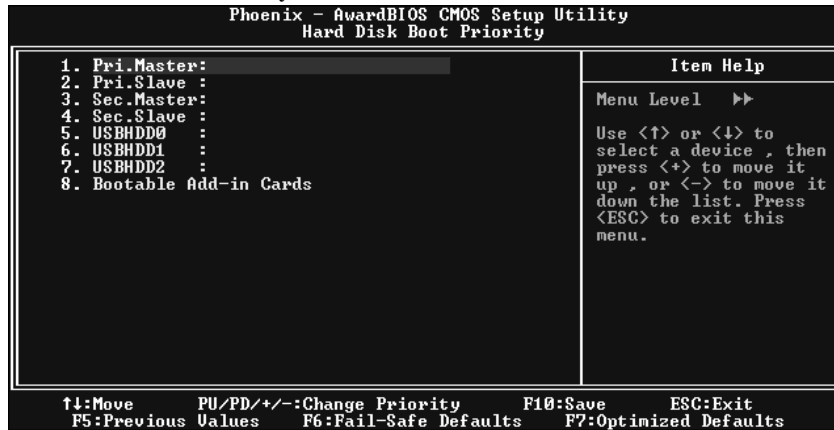

These BIOS attempt to load the operating system from the device in the sequence selected in these items.

The Choices: Pri. Master, Pri.Slave, Sec.Master, Sec. Slave, USBHDD0, USBHDD1, USBHDD2 and Bootable Add-in Carde.

First/Second/Third/Boot Other Device

These BIOS attempt to load the operating system from the device in the sequence selected in these items.

The Choices: Floppy, LS120, HDD-0, SCSI, CDROM, HDD-1, HDD-2,HDD-3, ZIP100, LAN, HPT370, Disabled, Enabled.

Swap Floppy Drive

For systems with two floppy drives, this option allows you to swap logical drive assignments.

The Choices: Disabled (default), Enabled.

Boot Up Floppy Seek

Enabling this option will test the floppy drives to determine if they have 40 or 80 tracks. Disabling this option reduces the time it takes to boot-up.

The Choices: Disabled, Enabled (default).

Report NO FDD for Win95

This item allows you to select YES/NO to Report NO FDD for Win95.

The Choices: NO (default), YES.

945P-A7 BIOS Manual

VIRUS WARNING

This option allows you to choose the Virus Warning feature that is used to protect the IDE Hard Disk boot sector. If this function is enabled and an attempt is made to write to the boot sector, BIOS will display a warning message on the screen and sound an alarm beep.

Disabled (default) Virus protection is disabled.
Enabled Virus protection is activated.

HYPER-THREADING TECHNOLOGY

This option allows you to enable or disabled CPU Hyper-Threading. Enabled for Windows XP and Linux 2.4.x (OS optimized for Hyper Threading Technology. Disabled for other OS (OS not optimized for Hyper Threading Technology.

The Choices: Enabled (default), Disabled.

QUICK POWER ON SELF TEST

Enabling this option will cause an abridged version of the Power On Self-Test (POST) to execute after you power up the computer.

Disabled Normal POST.
Enabled (default) Enable quick POST.

BOOT UP NUMLOCK STATUS

Selects the NumLock. State after power on.

On (default) Numpad is number keys.
Off Numpad is arrow keys.

GATE A20 OPTION

Select if chipset or keyboard controller should control Gate A20.

Normal A pin in the keyboard controller controls GateA20.
Fast (default) Lets chipset control Gate A20.

TYPEMATIC RATE SETTING

When a key is held down, the keystroke will repeat at a rate determined by the keyboard controller. When enabled, the typematic rate and typematic delay can be configured.

The Choices: Disabled (default), Enabled.

TYPEMATIC RATE (CHARS/SEC)

Sets the rate at which a keystroke is repeated when you hold the keydown.

The Choices: 6 (default), 8,10,12,15,20,24,30

TYPEMATIC DELAY (MSEC)

Sets the delay time after the key is held down before it begins to repeat the keystroke.

The Choices: 250 (default), 500, 750, and 1000.

945P-A7 BIOS Manual

SECURITY OPTION

This option will enable only individuals with passwords to bring the system online and/or to use the CMOS Setup Utility.

System A password is required for the system to boot and is also required to access the Setup Utility.

Setup (default) A password is required to access the Setup Utility only. This will only apply if passwords are set from the Setup main menu.

APIC MODE

Selecting Enabled enables APIC device mode reporting from the BIOS to the operating system.

The Choices: Enabled (default), Disabled.

MPS VERSION CONTROL FOR OS

The BIOS supports version 1.1 and 1.4 of the Intel multiprocessor specification.

Select version supported by the operation system running on this computer.

The Choices: 1.4 (default), 1.1.

OS SELECT FOR DRAM > 64MB

A choice other than Non-OS2 is only used for OS2 systems with memory exceeding 64MB.

The Choices: Non-OS2 (default), OS2.

SMALL LOGO (EPA) SHOW

This item allows you to select whether the "Small Logo" shows.

Enabled (default) "Small Logo" shows when system boot up.

Disabled No "Small Logo" shows when system boots up.

SUMMARY SCREEN SHOW

This item allows you to enable/disable the summary screen. Summary screen means system configuration and PCI device listing.

The choices: Enabled, Disabled (default).

945P-A7 BIOS Manual

4 Advanced Chipset Features

This submenu allows you to configure the specific features of the chipset installed on your system. This chipset manage bus speeds and access to system memory resources, such as DRAM. It also coordinates communications with the PCI bus. The default settings that came with your system have been optimized and therefore should not be changed unless you are suspicious that the settings have been changed incorrectly.

■ Figure 4. Advanced Chipset Setup

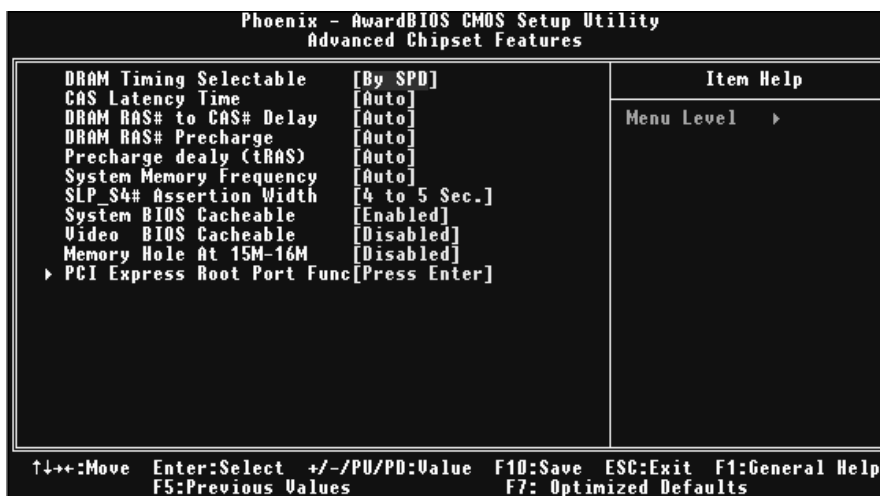

DRAM TIMING SELECTABLE

When synchronous DRAM is installed, the number of clock cycles of CAS latency depends on the DRAM timing.

The Choices: By SPD (default), Manual.

CAS LATENCY TIME

When synchronous DRAM is installed, the number of clock cycles of CAS latency depends on the DRAM timing.

The Choices: Auto (default).

DRAM RAS# TO CAS# DELAY

This field let you insert a timing delay between the CAS and RAS strobe signals, used when DRAM is written to, read from, or refreshed. Fast gives faster performance; and slow gives more stable performance. This field applies only when synchronous DRAM is installed in the system.

The Choices: Auto (default).

945P-A7 BIOS Manual

DRAM RAS# PRECHARGE

If an insufficient number of cycles is allowed for RAS to accumulate its charge before DRAM refresh, the refresh may be incomplete, and the DRAM may fail to retain data. Fast gives faster performance; and Slow gives more stable performance. This field applies only when synchronous DRAM is installed in the system.

The Choices: Auto (default).

PRECHARGE DELAY (TRAS)

This item controls the number of DRAM clocks to activate the precharge delay.

The Choices: Auto (default).

SYSTEM MEMORY FREQUENCY

This item allows you to select the Memory Frequency.

The Choices: Auto (default), DDR266, DDR300, and DDR400.

SLP S4# ASSERTION WIDTH

This item sets the minimum assertion width of the SLP-S4# signal to guarantee the DRAM has been safely power-cycled.

The Choices: 4 to 5 Sec (default).

SYSTEM BIOS CACHEABLE

Selecting Enabled allows you caching of the system BIOS ROM at F0000h~FFFFFh, resulting a better system performance. However, if any program writes to this memory area, a system error may result.

The Choices: Enabled (default), Disabled.

VIDEO BIOS CACHEABLE

Select Enabled allows caching of the video BIOS, resulting a better system performance. However, if any program writes to this memory area, a system error may result.

The Choices: Disabled (default), Enabled.

MEMORY HOLE AT 15M-16M

You can reserve this area of system memory for ISA adapter ROM. When this area is reserved it cannot be cached. The user information of peripherals that need to use this area of system memory usually discussed their memory requirements.

The Choices: Disabled (default), Enabled.

945P-A7 BIOS Manual

PCI EXPRESS ROOT PORT FUNC

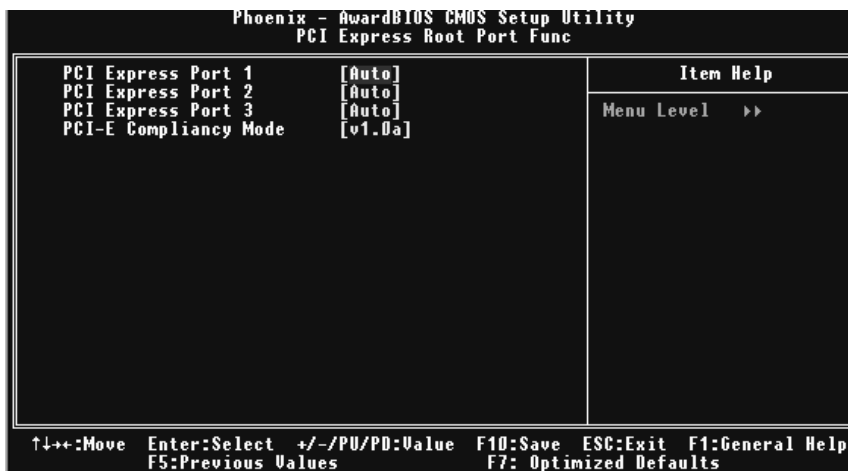

PCI Express Port 1/ 2/3

This item allows you to select the PCI Express Port.

The Choices: Auto (default), Enabled, Disabled.

PCI-E Compliancy Mode

This item allows you to select the PCI-E Compliancy Mode.

The Choices: v1.0a (default), v1.0.

945P-A7 BIOS Manual

5 Integrated Peripherals

■ Figure 5. Integrated Peripherals

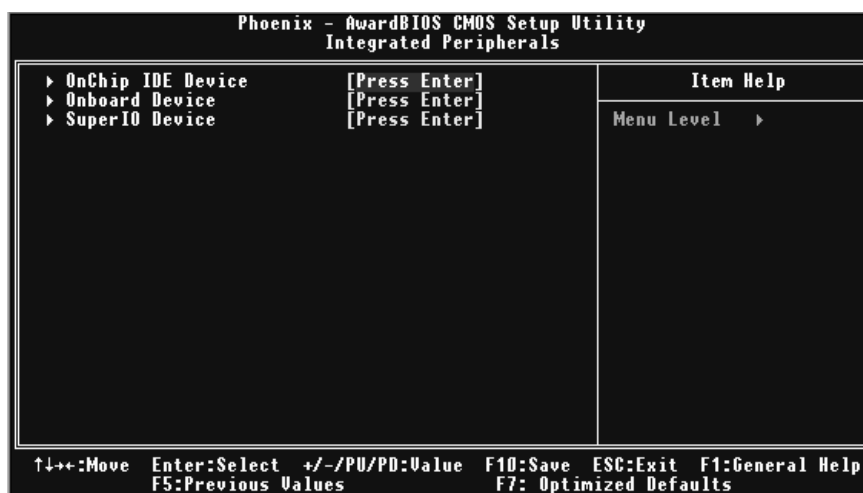

945P-A7 BIOS Manual

ONCHIP IDE DEVICE

Phoenix - AwardBIOS CMOS Setup Utility		Item Help
OnChip IDE Device		Menu Level >>
IDE HDD Block Mode	[Enabled]	If your IDE hard drive supports block mode select Enabled for automatic detection of the optimal number of block read/writes per sector the drive can support
IDE DMA transfer access	[Enabled]	
On-Chip Primary PCI IDE	[Enabled]	
IDE Primary Master PIO	[Auto]	
IDE Primary Slave PIO	[Auto]	
IDE Primary Master UDMA	[Auto]	
IDE Primary Slave UDMA	[Auto]	
On-Chip Secondary PCI IDE	[Enabled]	
IDE Secondary Master PIO	[Auto]	
IDE Secondary Slave PIO	[Auto]	
IDE Secondary Master UDMA	[Auto]	
IDE Secondary Slave UDMA	[Auto]	
*** On-Chip Serial ATA Setting ***		
SATA Mode	[IDE]	
On-Chip Serial ATA	[Enhanced Mode]	
SATA PORT Speed Settings	[Disabled]	
PATA IDE Mode	[Primary]	
SATA Port	P1,P3 is Secondary	

↑↓←→:Move Enter:Select +/-/PU/PD:Value F10:Save ESC:Exit F1:General Help
 F5:Previous Values F7: Optimized Defaults

IDE HDD Block Mode

Block mode is also called block transfer, multiple commands, or multiple sector read / write. If your IDE hard drive supports block mode (most new drives do), select Enabled for automatic detection of the optimal number of block mode (most new drives do), select Enabled for automatic detection of the optimal number of block read / write per sector where the drive can support.

The Choices: Enabled (default), Disabled.

IDE DMA Transfer Access

This item allows you to enable or disable the IDE transfer access.

The Choices: Enabled (default), Disabled.

On-chip Primary PCI IDE

This item allows you to enable or disable the primary/ secondary IDE Channel.

The Choices: Enabled (default), Disabled.

IDE Primary/Secondary/Master/Slave PIO

The IDE PIO (Programmed Input / Output) fields let you set a PIO mode (0-4) for each of the IDE devices that the onboard IDE interface supports. Modes 0 to 4 will increase performance progressively. In Auto mode, the system automatically determines the best mode for each device.

The Choices: Auto (default), Mode0, Mode1, Mode2, Mode3, and Mode4.

945P-A7 BIOS Manual

On-chip Secondary PCI IDE

This item allows you to enable or disable the primary/ secondary IDE Channel.

The Choices: **Enabled** (default), Disabled.

IDE Primary/Secondary/Master/Slave UDMA

Ultra DMA/100 functionality can be implemented if it is supported by the IDE hard drives in your system. As well, your operating environment requires a DMA driver (Windows 95 OSR2 or a third party IDE bus master driver). If your hard drive and your system software both support Ultra DMA/100, select Auto to enable BIOS support.

The Choices: **Auto** (default), Disabled.

On-Chip Serial ATA Setting

This item allows you to choose:

Disabled: disabled SATA Controller

Combined Mode: PATA and SATA are combined max of 2 IDE drivers in each channel.

Enhanced Mode: enabled both SATA and PATA max of 6 IDE drivers are supported.

SATA Only: SATA is operating in legacy mode.

The Choices: **Default** (default), Auto, Combined Mode, Enhanced Mode, and SATA only.

945P-A7 BIOS Manual

ON BOARD DEVICE

The screenshot shows the BIOS setup utility for Phoenix - AwardBIOS. The title is "Phoenix - AwardBIOS CMOS Setup Utility" and the subtitle is "Onboard Device". The main menu lists several options with their current status in brackets:

Item	Status	Item Help
USB Controller	[Enabled]	
USB 2.0 Controller	[Enabled]	
USB Keyboard Support	[Disabled]	Menu Level >>
USB Mouse Support	[Disabled]	
Onboard Azalia Audio	[Auto]	
Onboard RAID (ITE8211)	[Enabled]	
Onboard RAID BIOS	[Enabled]	
Onboard 1394	[Enabled]	
Onboard LAN	[Enabled]	
Onboard Lan Boot ROM	[Disabled]	

At the bottom of the screen, there is a legend for navigation keys:

↑↓←→:Move	Enter:Select	+/-/PU/PD:Value	F10:Save	ESC:Exit	F1:General Help
	F5:Previous Values		F7: Optimized Defaults		

USB Controller

Select Enabled if your system contains a Universal Serial Bus (USB) controller and you have USB peripherals.

The Choices: Enabled (default), Disabled

USB 2.0 Controller

This entry is to enable/ disabled EHCI controller only. This BIOS itself may/ may not have high speed USB support. If the BIOS has high speed USB support built in, the support will automatically turn on, when high speed device were attached.

The Choices: Enabled (default), Disabled.

USB Keyboard Support

This item allows you to enable or disable the USB Keyboard Legacy Support.

Enabled Enable USB Keyboard Support.

Disabled (default) Disable USB Keyboard Support.

USB Mouse Support

This item allows you to enable or disable the USB Mouse Legacy Support.

Enabled Enable USB Mouse Support.

Disabled (default) Disable USB Mouse Support.

Onboard Azalia Audio

This item allows you to enable or disable to support Onboard Azalia Audio.

The Choices: Auto (default).

945P-A7 BIOS Manual

Onboard RAID <ITE8211>

This item allows you to enable or disable to support Onboard RAID (ITE8211).

The Choices: Enabled (default), Disabled.

Onboard RAID BIOS

This item allows you to enable or disable to Onboard RAID BIOS.

The Choices: Enabled (default), Disabled.

Onboard 1394

This item allows you to enable or disable to support Onboard 1394 controller.

The Choices: Enabled (default), Disabled.

Onboard LAN

This item allows you to enable or disable the Onboard LAN.

The Choices: Enabled (default), Disabled.

Onboard LAN Boot ROM

Decide whether to invoke the boot ROM of the onboard LAN chip.

The Choices: Disabled (default), Enabled.

945P-A7 BIOS Manual

SUPER IO DEVICE

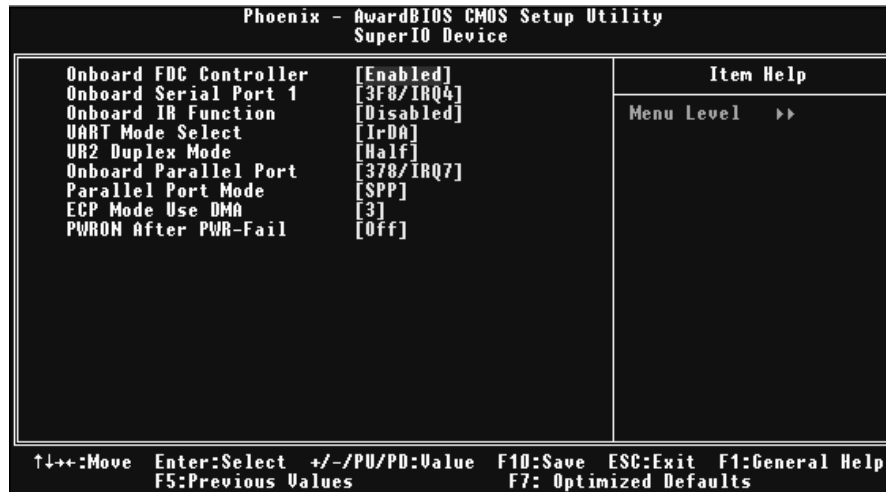

If you highlight the literal "Press Enter" next to the "Super IO Device" label and then press the enter key, it will take you a submenu with the following options:

Onboard FDC Controller

Select Enabled if your system has a floppy disk controller (FDC) installed on the system board and you wish to use it. If install and FDC or the system has no floppy drive, select Disabled in this field.

The Choices: Enabled (default), Disabled.

Onboard Serial Port 1

Select an address and corresponding interrupt for the first and second serial ports.

The Choices: Disabled, 3F8/IRQ4 (default), 2F8/IRQ3, 3E8/IRQ4, 2E8/IRQ3, Auto.

Onboard IR Function

This item allows you to disabled or enabled Onboard IR Function.

The Choices: Disabled (default), Enabled.

UART Mode Select

This item allows you to determine which Infra Red (IR) function of onboard I/O chip.

The Choices: IrDA (default), AS KIR, Normal.

UR2 Duplex Mode

Select the value required by the IR device connected to the IR port. Full-duplex mode permits simultaneous two-direction transmission. Half-duplex mode permits transmission in one direction only at a time.

The Choices: Half (default), Full.

945P-A7 BIOS Manual

Onboard Parallel Port

This item allows you to determine access onboard parallel port controller with which I/O Address.

The Choices: 378/IRQ7 (default), 278/IRQ5, 3BC/IRQ7, Disabled.

Parallel Port Mode

The default value is SPP.

The Choices:

SPP (default)	Using Parallel port as Standard Printer Port.
EPP	Using Parallel Port as Enhanced Parallel Port.
ECP+EPP	Using Parallel port as ECP & EPP mode.
ECP	Using Parallel port as Extended Capabilities Port.

ECP Mode Use DMA

Select a DMA Channel for the port.

The Choices: 3 (default), 1.

POWER After PWR-Fail

This setting specifies whether your system will reboot after a power fail or interrupts occurs.

Off	Leaves the computer in the power off state.
On	Reboots the computer.
Former-Sts	Restores the system to the status before power failure or interrupt occurs.

The Choices: Off (default), On, Former-Sts.

945P-A7 BIOS Manual

6 Power Management Setup

The Power Management Setup Menu allows you to configure your system to utilize energy conservation and power up/power down features.

■ **Figure 6. Power Management Setup**

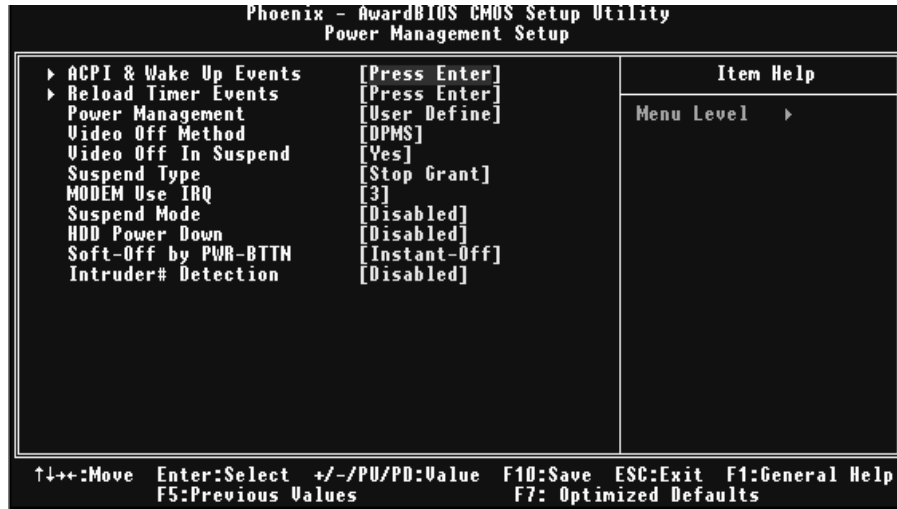

945P-A7 BIOS Manual

ACPI & WAKE UP EVENTS

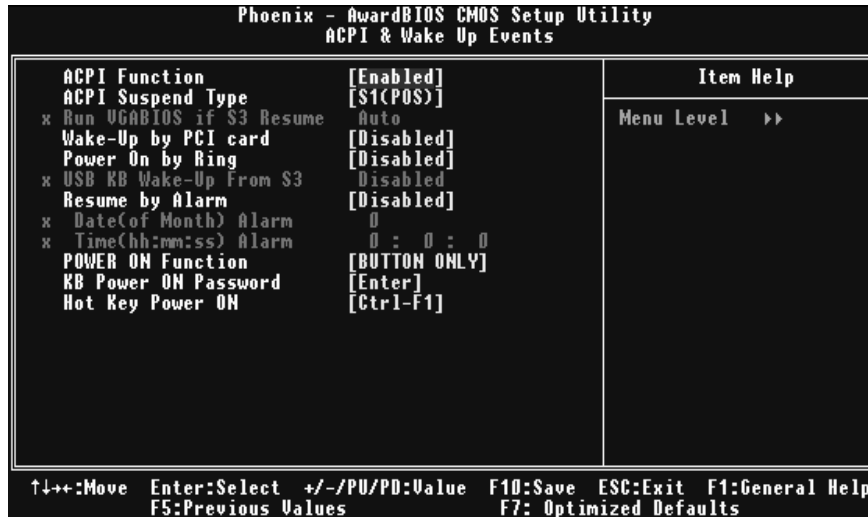

ACPI Function

This item displays the status of the Advanced Configuration and Power Management (ACPI).

The Choices: Enabled (default), Disabled.

ACPI Suspend Type

The item allows you to select the suspend type under the ACPI operating system.

The Choices: S1 (POS) (default) Power on Suspend
 S3 (STR) Suspend to RAM
 S1 & S3 POS+STR

Run VGABIOS if S3 Resume

Choosing Enabled will make BIOS run VGA BIOS to initialize the VGA card when system wakes up from S3 state. The system time is shortened if you disable the function, but system will need AGP driver to initialize the card. So, if the AGP driver of the VGA card does not support the initialization feature, the display may work abnormally or not function after S3.

The Choices: Auto (default), Yes, No.

945P-A7 BIOS Manual

Wake-Up by PCI card

When you select "Enable", a PME signal from PCI card returns the system to Full On state.

The Choices: Enabled, **Disabled** (default).

Power On by Ring

An input signal on the serial Ring Indicator (RI) line (in other words, an incoming call on the modem) awakens the system from a soft off state.

The Choices: Enabled, **Disabled** (default).

USB KB Wake-Up From S3

This item allows you to enable or disabled USB keyboard wake up from S3.

The Choices: **Disabled** (default), Enabled.

Resume by Alarm

This function is for setting date and time for your computer to boot up.

During Disabled, you cannot use this function. During Enabled,

Choose the Date and Time.

Date (of Month) Alarm

You can choose which month the system will boot up.

Time (hh:mm:ss) Alarm

You can choose what hour, minute and second the system will boot up.

Note: If you have change the setting, you must let the system boot up until it goes to the operating system, before this function will work.

POWER ON Function

This item allows you to choose the power on function.

The Choices: **Button Only** (default), Password, Hot Key, Mouse Left, Mouse Right, Any Key, Keyboard 98.

KB POWER ON Password

Input password and press Enter to set the Keyboard power on password.

Hot Key Power ON

Input password and press Enter to set the Keyboard power on password.

The Choices: **Ctrl-F1** (default), Ctrl-F2, Ctrl-F3, Ctrl-F4, Ctrl-F5, Ctrl-F6, Ctrl-F7, Ctrl-F8, Ctrl-F9, Ctrl-F10, Ctrl-F11, and Ctrl-F12.

945P-A7 BIOS Manual

RELOAD TIMER EVENTS

Phoenix - AwardBIOS CMOS Setup Utility	
Reload Timer Events	
Primary IDE 0	[Disabled]
Primary IDE 1	[Disabled]
Secondary IDE 0	[Disabled]
Secondary IDE 1	[Disabled]
FDD, COM, LPT Port	[Disabled]
PCI PIRQ[A-D]#	[Disabled]
	Item Help
	Menu Level >>

↑↓←→:Move Enter:Select +/-/PU/PD:Value F10:Save ESC:Exit F1:General Help
F5:Previous Values F7: Optimized Defaults

Primary/Secondary IDE 0/1

You can select to enable or disable Primary or Secondary RAID 0 or RAID 1 function under this item.

The Choices: Disabled (default), Enabled.

FDD, COM, LPT Port

You can select to enable or disable FDD, COM, and LPT port under this item.

The Choices: Disabled (default), Enabled.

PCI PIRQ [A-D]#

You can select to enable or disable PCI PIRQ [A-D]# under this item.

The Choices: Disabled (default), Enabled.

945P-A7 BIOS Manual

POWER MANAGEMENT

This category allows you to select the type (or degree) of power saving and is directly related to the following modes:

- 1.HDD Power Down.
- 2.Suspend Mode.

There are four options of Power Management, three of which have fixed mode settings

Min. Power Saving

Minimum power management.

Suspend Mode = 1 hr.

HDD Power Down = 15 min

Max. Power Saving

Maximum power management only available for sl CPU's.

Suspend Mode = 1 min.

HDD Power Down = 1 min.

User Define (default)

Allows you to set each mode individually.

When not disabled, each of the ranges is from 1 min. to 1 hr. except for HDD Power Down which ranges from 1 min. to 15 min. and disable.

VIDEO OFF METHOD

This option determines the manner in which the monitor is goes blank.

The Choices: DPMS (default).

VIDEO OFF IN SUSPEND

This determines the manner in which the monitor is blanked.

The Choices: Yes (default), No.

SUSPEND TYPE

Select the Suspend Type.

The Choices: Stop Grant (default), PwrOn Suspend.

MODEM USE IRQ

This determines the IRQ, which can be applied in MODEM use.

The Choices: 3 (default), 4 / 5 / 7 / 9 / 10 / 11 / NA.

945P-A7 BIOS Manual

SUSPEND MODE

The item allows you to select the suspend type under ACPI operating system.

The Choices: Disabled (default), 1 Min, 2 Min, 4 Min, 6 Min, 8 Min, 10 Min, 20 Min, 30 Min, 40 Min, 1 Hour.

HDD POWER DOWN

When enabled, the hard disk drive will power down and after a set time of system inactivity. All other devices remain active.

The Choices: Disabled (default), 1 Min, 2 Min, 3 Min, 4 Min, 5 Min, 6 Min, 7 Min, 8 Min, 9 Min, 10 Min, 11 Min, 12 Min, 13 Min, 14 Min, 15Min.

SOFT-OFF BY PWR-BTN

Pressing the power button for more than 4 seconds forces the system to enter the Soft-Off state when the system has “hung.”

The Choices: Delay 4 Sec, Instant-Off (default).

INTRUDER# DETECTION

This item allows you to enable or disable intruder# detection.

The Choices: Disabled (default), Enabled.

945P-A7 BIOS Manual

7 PnP/PCI Configurations

This section describes configuring the PCI bus system. PCI, or Personal Computer Interconnect, is a system which allows I/O devices to operate at speeds nearing the speed of the CPU itself uses when communicating with its own special components. This section covers some very technical items and it is strongly recommended that only experienced users should make any changes to the default settings.

■ Figure 7. PnP/PCI Configurations

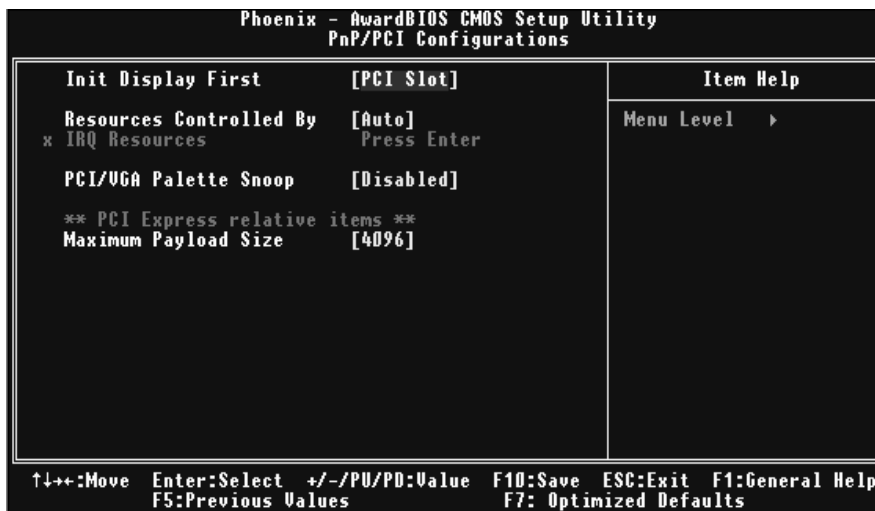

INIT DISPLAY FIRST

This item allows you to decide to active whether PCI Slot or on-chip VGA first.
The Choices: PCI Slot (default), Onboard/ AGP.

RESOURCES CONTROLLED BY

By Choosing "Auto (ESCD)" (default), the system BIOS will detect the system resources and automatically assign the relative IRQ and DMA channel for each peripheral. By Choosing "Manual", the user will need to assign IRQ & DMA for add-on cards. Be sure that there are no IRQ/DMA and I/O port conflicts.

The Choices: Auto (default).

945P-A7 BIOS Manual

IRQ RESOURCES

This submenu will allow you to assign each system interrupt a type, depending on the type of device using the interrupt. When you press the “Press Enter” tag, you will be directed to a submenu that will allow you to configure the system interrupts. This is only configurable when “Resources Controlled By” is set to “Manual”.

IRQ-3	assigned to	PCI Device
IRQ-4	assigned to	PCI Device
IRQ-5	assigned to	PCI Device
IRQ-7	assigned to	PCI Device
IRQ-9	assigned to	PCI Device
IRQ-10	assigned to	PCI Device
IRQ-11	assigned to	PCI Device
IRQ-12	assigned to	PCI Device
IRQ-14	assigned to	PCI Device
IRQ-15	assigned to	PCI Device

PCI / VGA PALETTE SNOOP

Choose Disabled or Enabled. Some graphic controllers that are not VGA compatible take the output from a VGA controller and map it to their display as a way to provide boot information and VGA compatibility. However, the color information coming from the VGA controller is drawn from the palette table inside the VGA controller to generate the proper colors, and the graphic controller needs to know what is in the palette of the VGA controller. To do this, the non-VGA graphic controller watch for the Write access to the VGA palette and registers the snoop data. In PCI based systems, where the VGA controller is on the PCI bus and a non-VGA graphic controller is on an ISA bus, the Write Access to the palette will not show up on the ISA bus if the PCI VGA controller responds to the Write.

In this case, the PCI VGA controller should not respond to the Write, it should only snoop the data and permit the access to be forwarded to the ISA bus. The non-VGA ISA graphic controller can then snoop the data on the ISA bus. Unless you have the above situation, you should disable this option.

Disabled (default) disable the function.
Enabled enable the function.

MAXIMUM PAYLOAD SIZE

Set the maximum payload size for Transaction packets (TLP).

The Choice: 4096 (default).

945P-A7 BIOS Manual

8 PC Health Status

■ Figure 8. PC Health Status

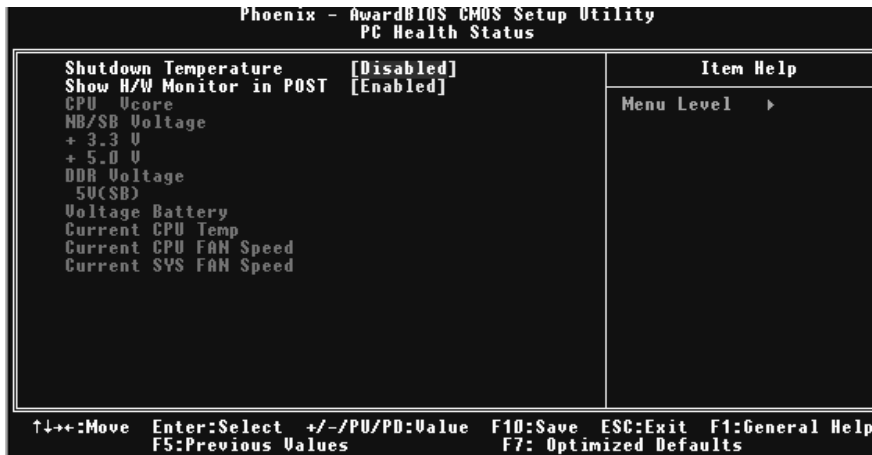

SHUTDOWN TEMPERATURE

This item allows you to set up the CPU shutdown Temperature. This item only effective under Windows 98 ACPI mode

The Choices: 60oC/140oF, 65oC/149oF, 70oC/158oF, **Disabled** (default).

SHOW H/W MONITOR IN POST

If you computer contain a monitoring system, it will show PC health status during POST stage. The item offers several delay time to select you want.

The Choices: Enabled (default), Disabled.

CPU VCORE,NB/SB VOLTAGE +3.3V,+5.0V, DDR VOLTAGE,

5V(SB),VOLTAGE BATTERY

Detect the system's voltage status automatically.

CURRENT CPU TEMP

This field displays the current temperature of CPU.

CURRENT CPU FAN SPEED

This field displays the current speed of CPU fan.

CURRENT SYS FAN SPEED

This field displays the current speed SYSTEM fan.

945P-A7 BIOS Manual

9 Frequency Control

■ Figure 9. Frequency Control

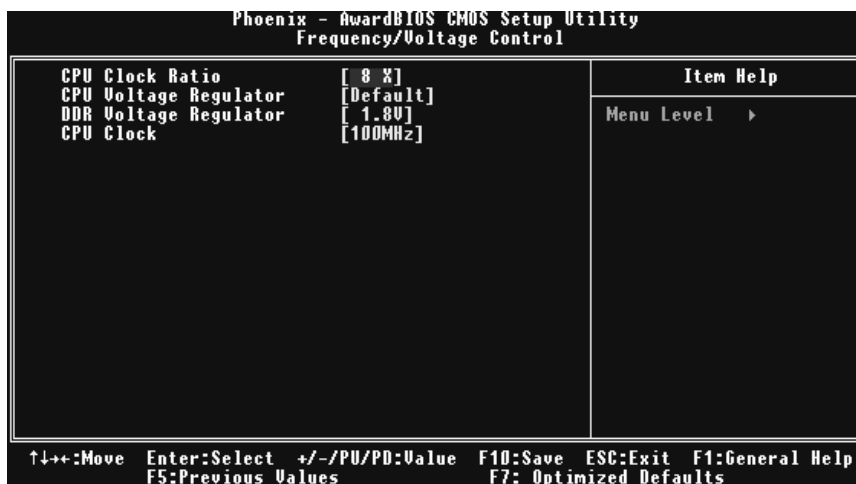

CPU CLOCK RATIO

This item allows you to select the CPU Ratio.

The Choices: 8X (default), 9X, 10X, 11X, 12X, 13X, 14 X, 15X, 16X, 17X, 18X, 19X, 20 X, 21 X, 22 X, and 23X.

CPU VOLTAGE REGULATOR

This item allows you to select CPU Voltage Regulator.

The Choices: Default (default).

DDR VOLTAGE REGULATOR

This item allows you to select DDR Voltage Regulator.

The Choices: 1.8V (default).

945P-A7 BIOS Manual

CPU CLOCK

This item allows you to select CPU Clock, and CPU over clocking.

The Choices: 100MHZ (default).

Special Notice:

If unfortunately, the system's frequency that you are selected is not functioning, there are two methods of booting-up the system.

Method 1:

Clear the COMS data by setting the JCOMS1 ((2-3) closed)) as "ON" status. All the CMOS data will be loaded as defaults setting.

Method 2:

Press the <Insert> key and Power button simultaneously, after that keep-on pressing the <Insert> key until the power-on screen showed. This action will boot-up the system according to FSB of the processor.

It's strongly recommended to set CPU Vcore and clock in default setting. If the CPU Vcore and clock are not in default setting, it may cause CPU or M/B damage.