

i945GTm-VHL i945GMm-HL

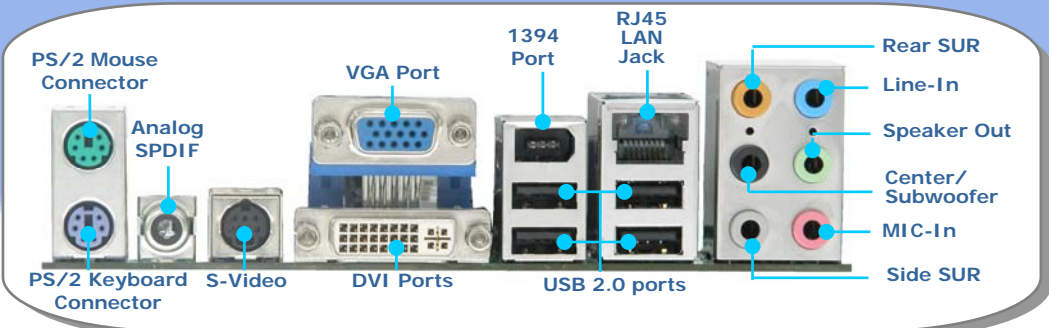

Cool Stuff is Not Stuff, ModT is the Right Stuff



Easy Installation Guide

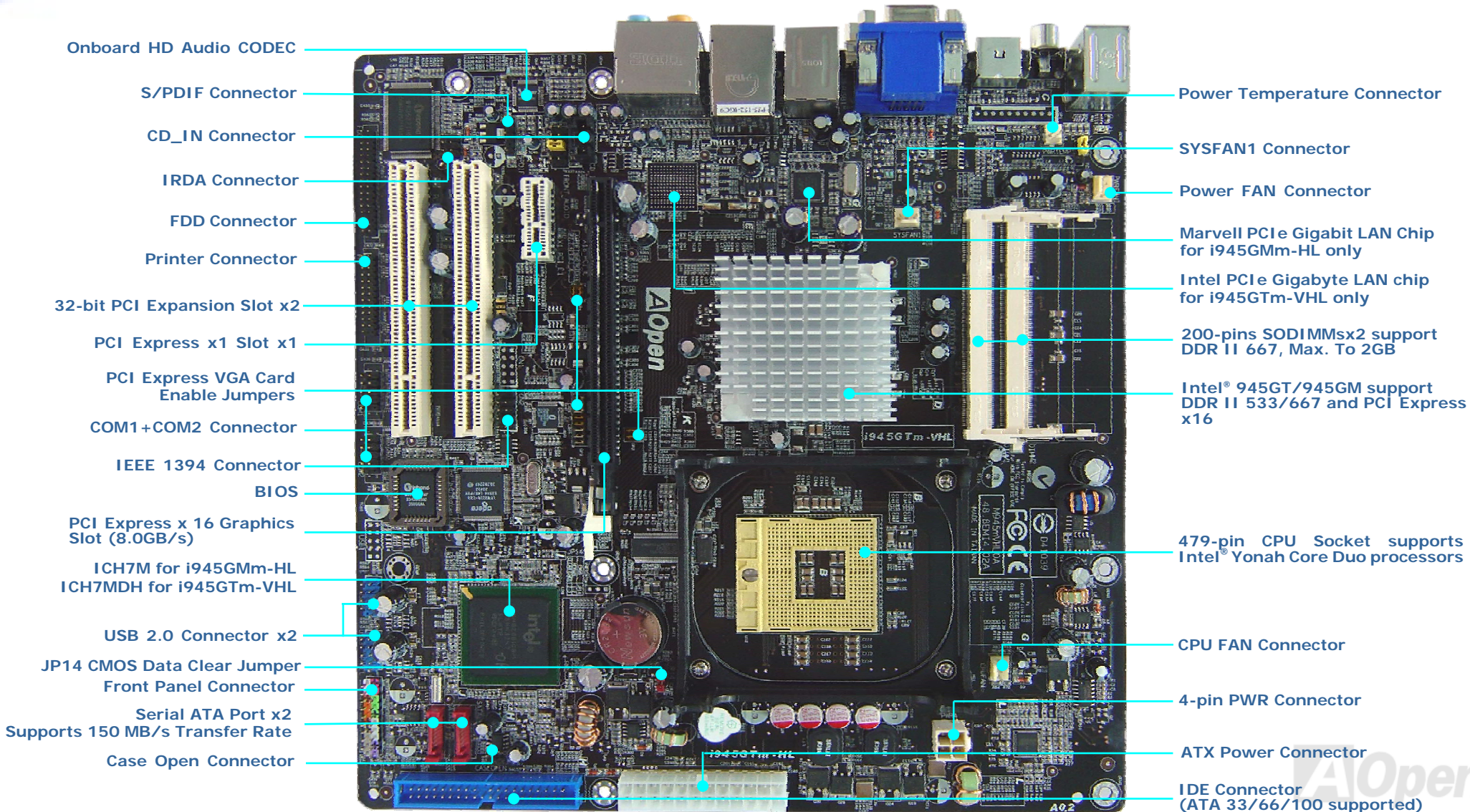

Before You Start

Everything you need to boot this motherboard is included in this Easy Installation Guide. For more information, a complete **Online User's Manual** can be found in the **Bonus Pack CD**. Thanks for the help of saving our earth.

Installing By Yourself

Accessory Checklist

- Easy Installation Guide x 1
- Enhanced Full Pictured Manual x 1
- 80-Wire IDE Cable x 1
- Floppy Drive Cable x 1
- Serial ATA Cable x 1
- Serial ATA Power Cable x 1
- Back Panel I/O Shield x 1
- Bonus Pack CD x 1
- Yonah Core Duo/Solo CPU cooler x 1

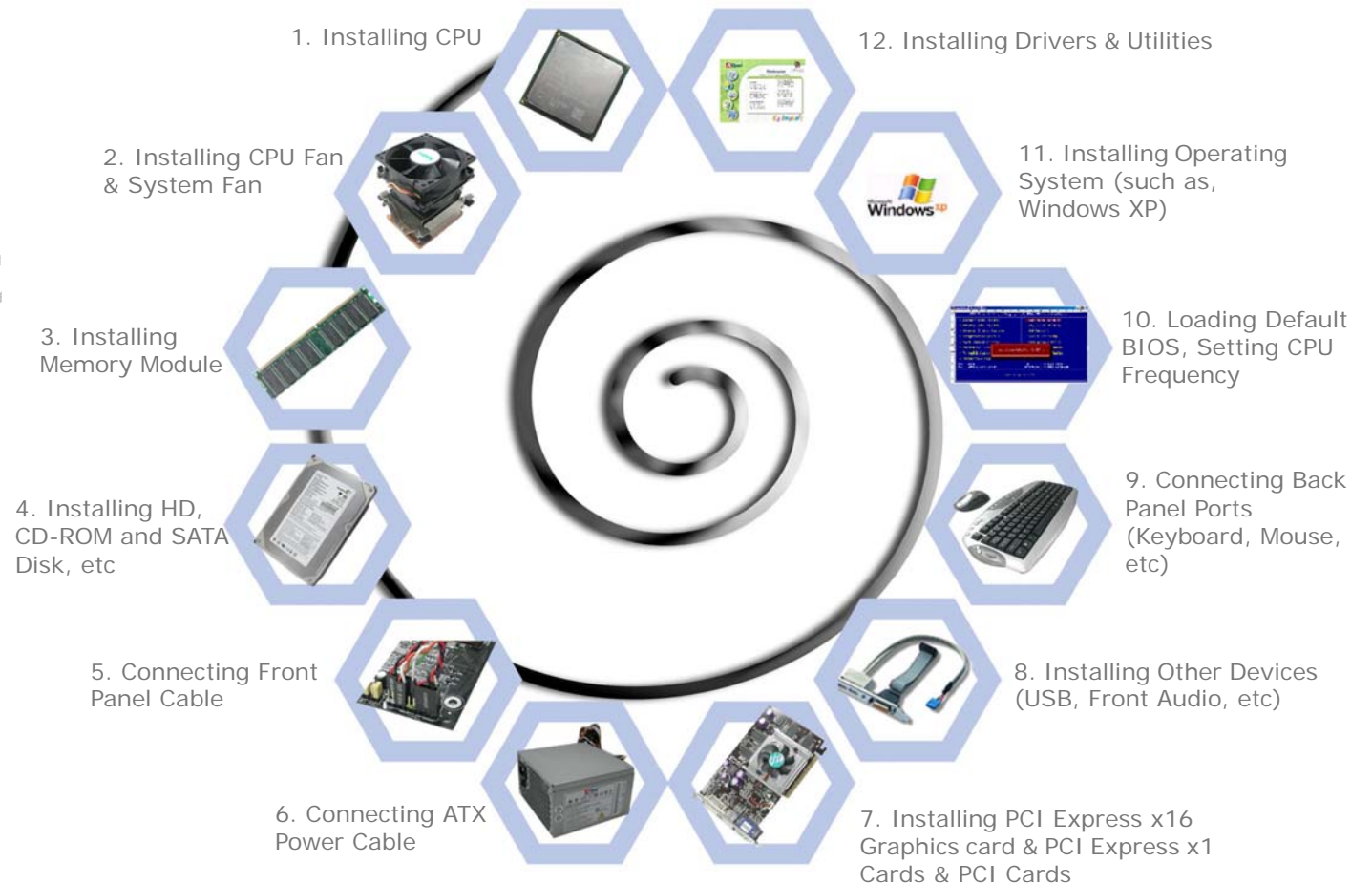

Dual Core	667 MHz FSB	667 SODIMM DDRII	IEEE 1394	USB 2.0	LAN Gigabit	Express PCI
TV	DVI	CRT	Analog Audio	SPDIF OUT Digital Audio	Serial ATA	100 PATA

PART NO: 49.8EMOD.EE10

DOC. NO: I945GTMVHL-EG-E0602A

1. Installing CPU

This socket supports Yonah Core Duo/Solo CPU, which is the latest CPU package developed by Intel. Please do not plug other CPU to avoid any damage. Other forms of CPU package are impossible to be fitted in.

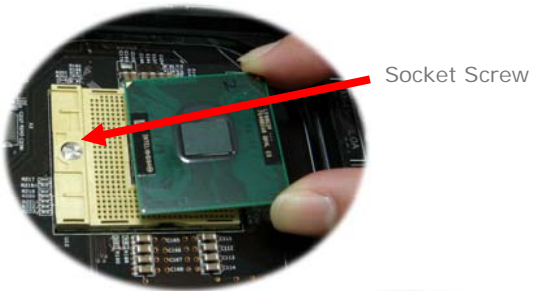

Socket Screw

1. Unscrew socket screw counter-clockwise.
2. Locate Pin 1 in the socket and look for a golden arrow on the CPU upper interface. Match Pin 1 and golden arrow. Then insert the CPU into the socket.
3. Lock the socket screw clockwise to fasten CPU.

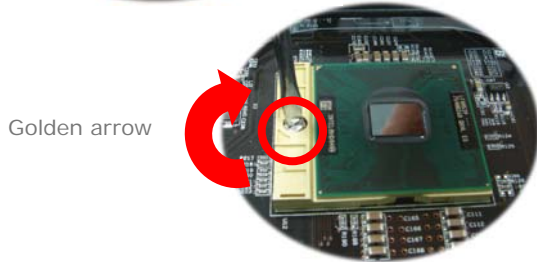

Golden arrow

Note: If you do not match the CPU socket Pin 1 and CPU golden arrow well, you may damage the CPU.

2. Installing CPU & System Fans

Plug in the CPU fan cable to the 4-pin CPUFAN connector. If you have chassis fan, you can also plug it in SYSFAN1 or PWRFAN connector.

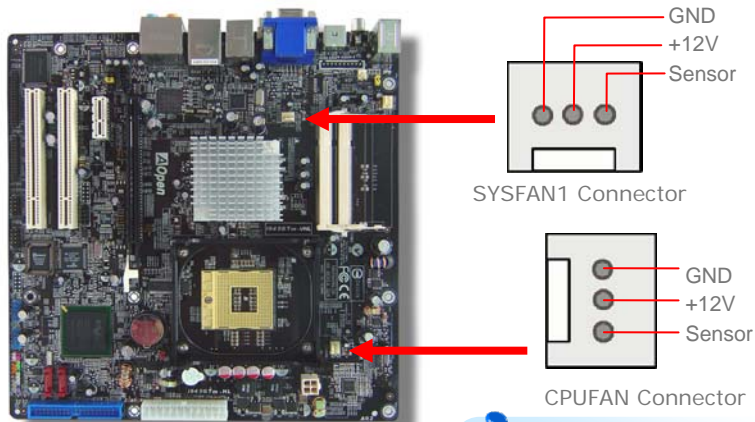

Note: Some CPU fans do not have sensor pin so they cannot support fan monitoring.

3. Installing Memory Modules

SODIMM slots are designed in high and low positions which are very easy to recognize. Insert the module straight down to the SODIMM slot with finger and press down firmly until the SODIMM module is securely in place.

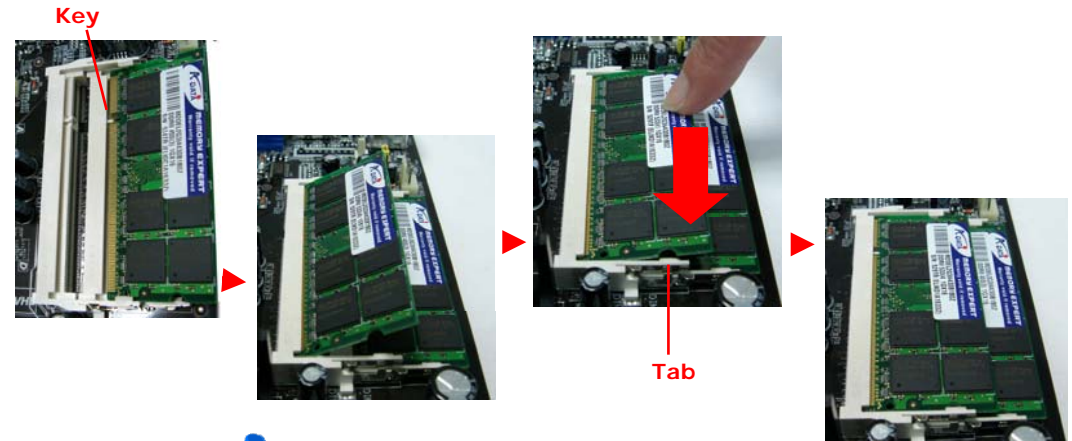

Note: The tabs of the SODIMM slot will close-up to hold the DIMM in place when the SODIMM touches the slot's bottom.

4. Connecting IDE and Floppy Cables

Connect 34-pin floppy cable and 40-pin, 80-wire IDE cable to floppy connector FDD and IDE connector. Be careful of the pin1 orientation. Wrong orientation may cause system damage.

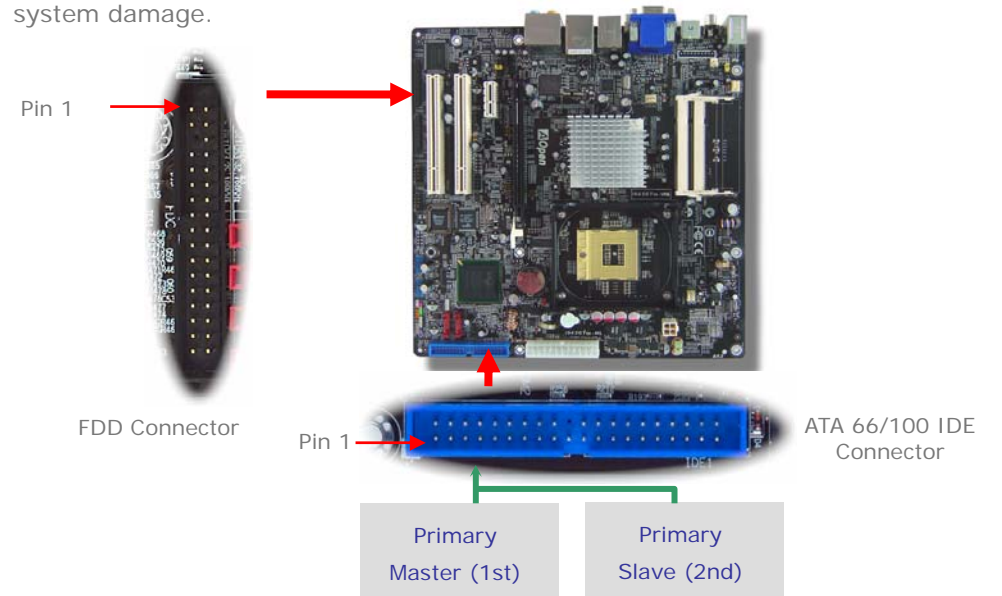

5. Connecting Front Panel cable

Attach the power LED, speaker, and reset switch connectors to the corresponding pins. If you enable "Suspend Mode" item in BIOS Setup, the ACPI & Power LED will keep flashing while the system is in suspend mode.

Locate the power switch cable from your ATX housing. It is 2-pin female connector from the housing front panel. Plug this connector to the soft-power switch connector marked *SPWR*.

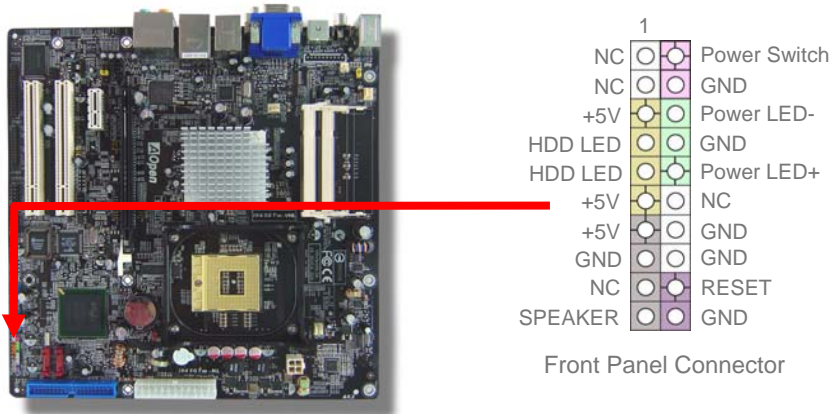

6. Connecting ATX Power Cables

This motherboard comes with a 24-pin and 4-pin ATX power connector as shown below. Make sure you plug in the right direction. We strongly recommend you to insert the 4-pin connector before connecting the 24-pin connector.

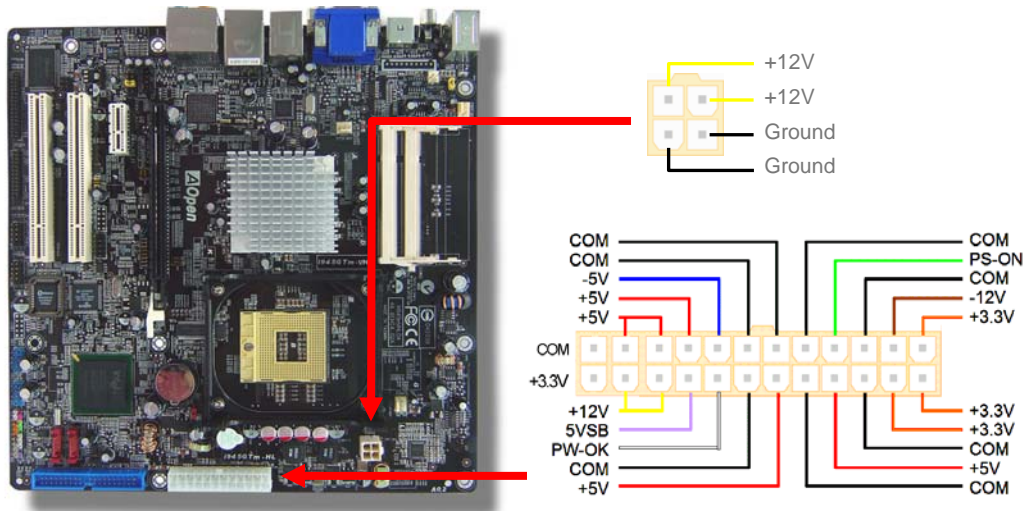

7. Power-on and Loading BIOS Setup

Del

After you finish the setting of jumpers and connect correct cables. Power on and enter the BIOS Setup, press during POST (Power On Self Test). Choose "Load Optimized Defaults" for recommended optimal performance.

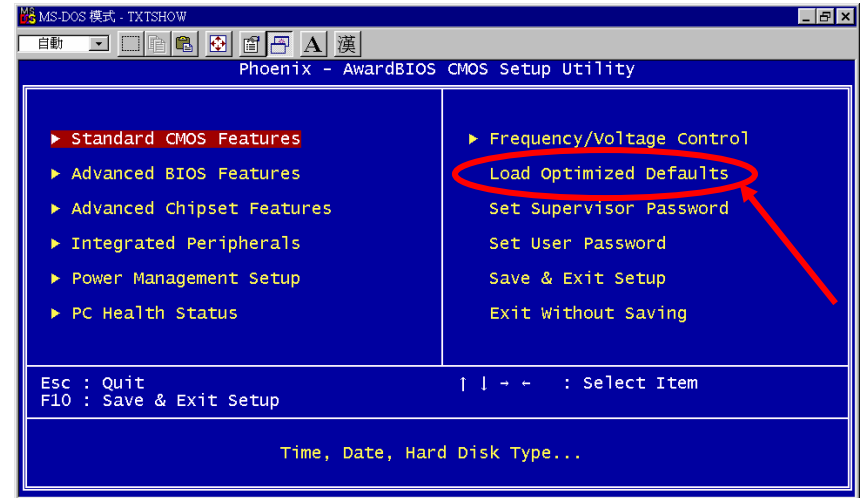

8. AOpen EzInstall and Bonus Pack CD

You can use the autorun menu of Bonus CD disc. Choose the utility and driver from the icons at left side, and then click on the "GO" button to complete installation automatically.



Setting CPU Voltage & Frequency

Setting CPU Core Voltage

This motherboard supports Voltage ID (VID) function to detect CPU voltage automatically during power-on.

Setting CPU Frequency

This motherboard is CPU jumper-less design, you can set CPU frequency through 1MHz stepping CPU Overclocking in the BIOS. CPU Core Frequency = CPU external frequency x CPU Ratio. However, all CPU now selling in the market belong to "Fixed Multiplier". That means users can not adjust the CPU Ratio but only change CPU FSB clock to achieve overclocking.

(Users do the overclocking at their own risk!!)

BIOS Setup > Frequency / Voltage Control > CPU Bus Frequency

CPU Ratio	4x, 5x... 17x, 18x, 20x
CPU FSB (Adjustment manually)	FSB = 533MHz - 667MHz by 1MHz Stepping CPU Overclocking

Processor Number	Architecture	Clock Speed	Front Side Bus	Cache	Ratio
Core Duo T2700	65nm	2.33GHz	667MHz	2MB L2	
Core Duo T2600	65nm	2.16GHz	667MHz	2MB L2	
Core Duo T2500	65nm	2GHz	667MHz	2MB L2	
Core Duo T2400	65nm	1.83GHz	667MHz	2MB L2	
Core Duo T2300	65nm	1.66GHz	667MHz	2MB L2	
Core Solo T1400	65nm	1.83GHz	667MHz	2MB L2	
Core Solo T1300	65nm	1.66GHz	667MHz	2MB L2	

Note: With CPU speed changing rapidly, there might be faster CPU on the market by the time you received this installation guide. This table is kindly for your references only.



Tip: When you fail to over-clock, you could:

1. Clear CMOS (JP14) to restore the default setting.
2. After turning power on, press "Home" immediately until the screen appears.



Warning: Intel 945GT/945GM chipset supports maximum 667MHz (166MHz*4) system bus; higher clock setting may cause serious system damage.

JP14 Clear CMOS

You can clear CMOS to restore system default setting. To clear the CMOS, follow the procedure below.

1. Turn off the system and unplug the AC power.
2. Remove ATX power cable from connector PWR3.
3. Locate JP14 and short pins 2-3 for a few seconds.
4. Return JP14 to its normal setting by shorting pin 1 & pin 2.
5. Connect ATX power cable back to connector PWR3.

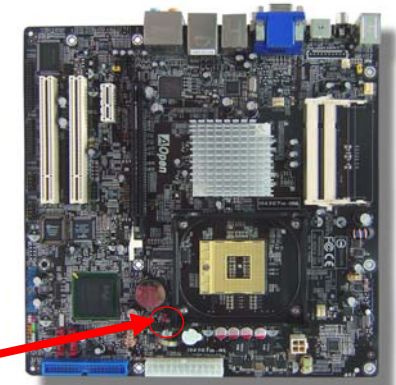

Pin 1



Tip: When should I Clear CMOS?

1. Boot fails because of overclocking...
2. Forget password...
3. Troubleshooting...

JP28 Keyboard/Mouse Wakeup Jumper

This motherboard provides keyboard / mouse wake-up function. You can use JP28 to enable or disable this function, which could resume your system from suspend mode with keyboard or mouse. The factory default setting is "Disable" (1-2), and you may enable this function by setting the jumper to 2-3.

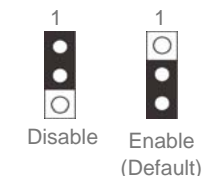
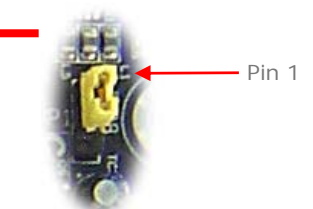

IEEE 1394 Connectors

With IEEE1394 Chip on board (AGERE 1394), having its data transfer rate up to 400Mb/s, this interface can connect to devices that require high data transferring performance such as digital camera, scanner or others IEEE 1394 devices. Please use appropriate cables to connect IEEE1394 devices.

12V Power support 6W only

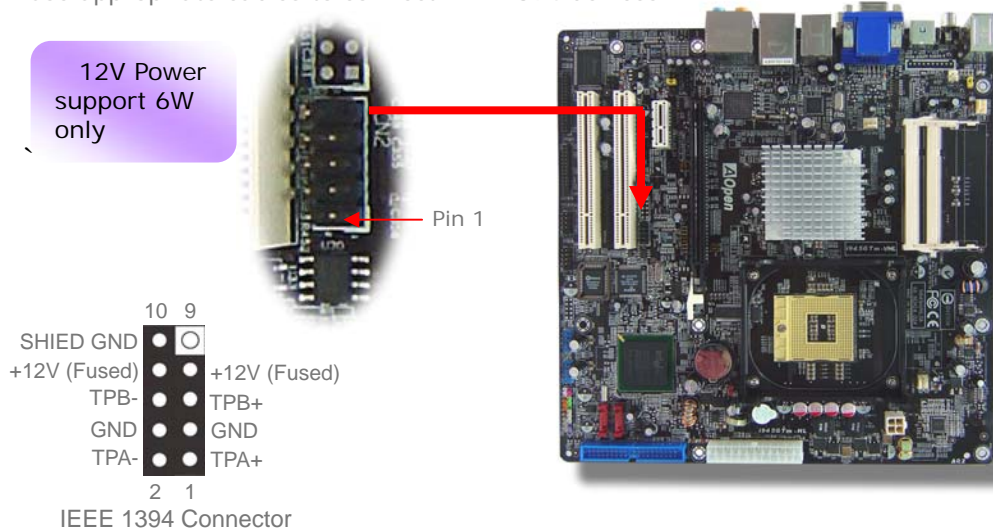

Gigabit LAN onboard

On the strength of Marvell Gigabit LAN chip on board, the motherboard provides 10/100/1000Mbps Ethernet for home and office use. The Ethernet RJ45 connector is located on top of USB connectors. The right hand side LED indicates link mode, it lights in yellow whenever linking to network. The left hand side LED indicates the transfer mode and it lights in green when data is transferring in 100Mbps (never lights while in 10Mbps), but lights in orange when transferring in Gigabit's mode. To enable or disable this function, you may simply adjust it through BIOS.

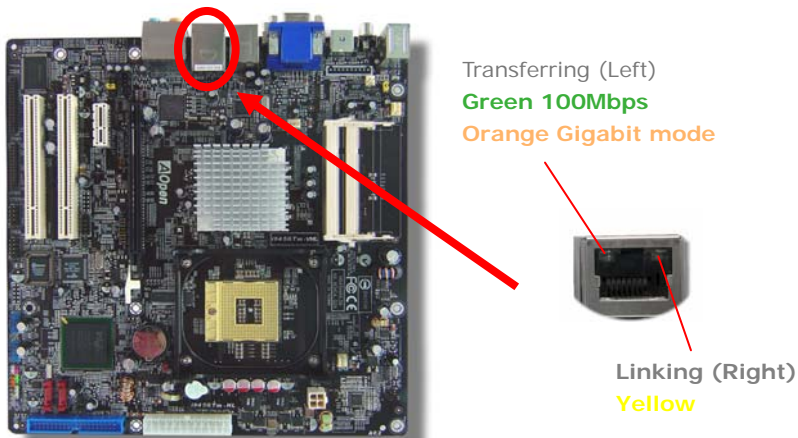

Front Audio Connectors

If the housing has been designed with an audio port on the front panel, you'll be able to connect onboard audio to front panel through this connector. By the way, please remove 5-6 and 9-10 jumper caps from the Front Audio Connector before connecting the cable. Please do not remove these 5-6 and 9-10 yellow jumper caps if there's no audio port on the front panel.

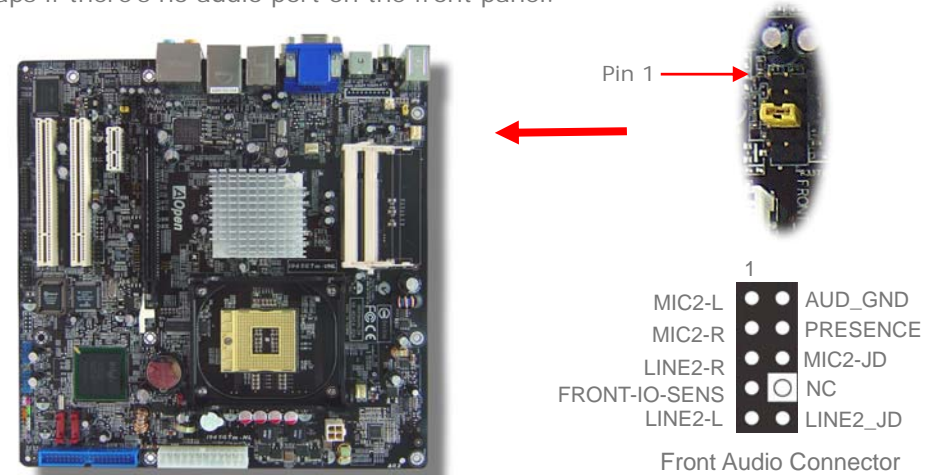

Serial ATA Connectors

To connect a serial ATA disk, you have to have a 7-pin serial ATA cable. Connect two ends of the serial ATA cable to the serial ATA header on the motherboard and the disk. Like every other traditional disk, you also have to connect a power cable. Please be noted that it is a jumper free implement; you don't need to set jumpers to define a master or slave disk. When serial ATA hard disks are installed on serial ATA ports, the one connected on SATA1 will be set as the first boot device automatically. **Please note that it supports Hot-Plug in function.**

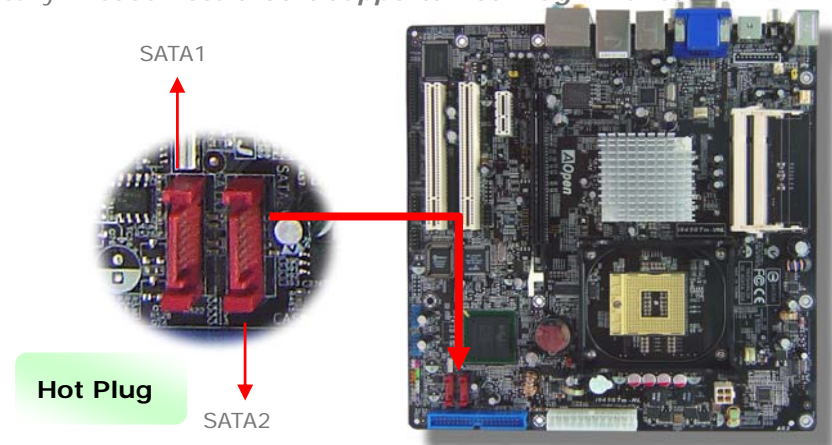



Troubleshooting

If you encounter any trouble to boot your system, follow the procedures accordingly to resolve the problem.

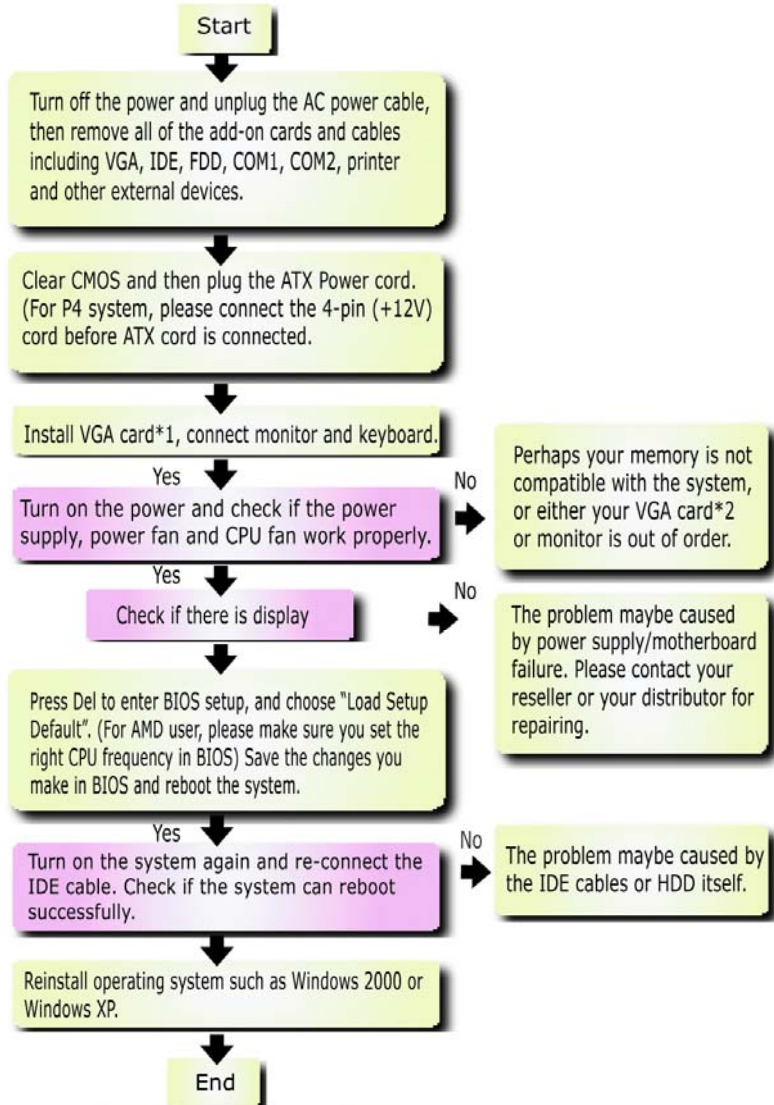

*1 The VGA card is not necessary to be installed if your monitor is connected to the onboard VGA port.
 *2 If you connect to the onboard VGA port and no screen displays, then your onboard VGA device might have problem.

Model name and BIOS version

Model name and BIOS version can be found on upper left corner of first boot screen (POST screen). For example:

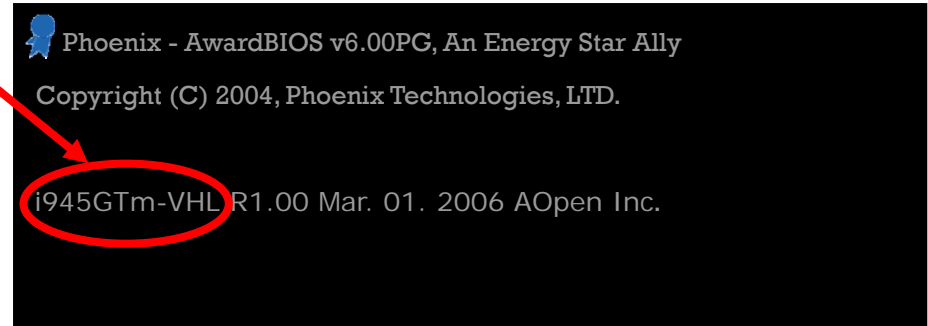

i945GTm-VHL is model name of motherboard; R1.02 is BIOS version

Register Your Motherboard

Thanks for choosing AOpen product, please register this motherboard at <http://club.aopen.com.tw/productreg/> to become a Gold member of Club AOpen, and to ensure high service quality and priority from AOpen. You will also have a chance to play slot machine game to win prize from AOpen. Please prepare the following information before you start: **Model Name, Part Number (P/N), Serial Number (S/N) and Purchase Date**. The Part Number and Serial number are printed on bar code label. You can find this bar code label on the outside packing or on component side of PCB. For example:



Part No. Serial No.

P/N: 91.88110.201 is part number, S/N: 91949378KN73 is serial number.

Phoenix-Award BIOS ERROR Message

Beep Sound	Message
1 short(Beep)	System booting is normally.
1 long - 1 short(Beep)	DRAM ERROR
1 long - 2 short(Beep)	Display card or monitor connected error
1 long - 3 short(Beep)	Keyboard Error
Long(Beep) continuous	DRAM hasn't inset correctly.



Technical Support

Dear Customer,

Thanks for choosing AOpen products. We invite you to register at <http://www.aopen.com> to become a Gold Member of Club AOpen so as to ensure quality service in the future. In order to maintain the best service to every customer of us, we recommend you to follow the procedures below and seek help from our branches according to the region you buy the product. With your help, we can then continue to provide efficient and the best quality service to every customer.

Thanks very much for your understanding!

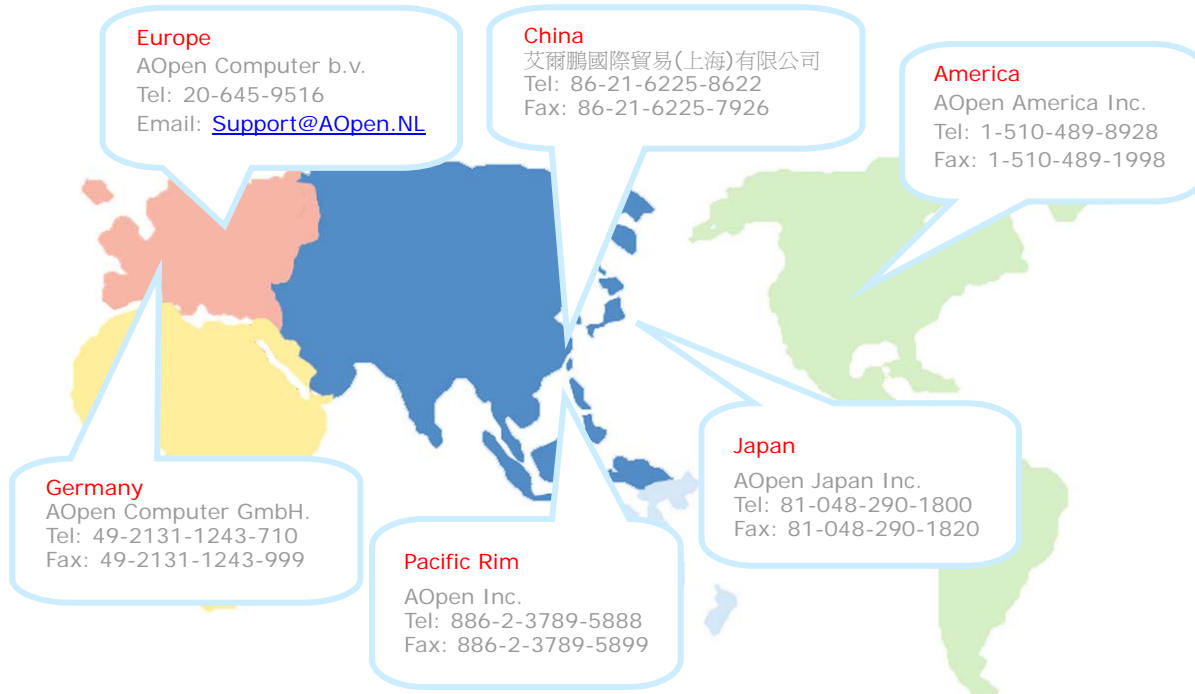

Europe	http://www.aopen.nl/tech/default.htm
Pacific Rim	http://www.aopen.com.tw/tech/default.htm
China:	http://www.aopen.com.cn/tech/default.htm
Germany	http://www.aopen.de/tech/default.htm
America	http://usa.aopen.com/tech/default.htm
Japan	http://aopen.jp/tech/index.html

Online Manual: To download manual, please log on and then select your preferred language. Under "Type" directory, choose "Manuals" to go to our manual database. You can also find the manual and EIG in AOpen Bonus Pack.
<http://download.aopen.com.tw/>

Test Report: We recommend you to choose board/card/device from the compatibility test reports for assembling your PC. It may prevent incompatibility problems.
<http://global.aopen.com.tw/tech/report/default.htm>

FAQ: Here we list problems that users often encounter and FAQ (Frequently Asked Questions). You may select your preferred language after log on, and may be able to find a solution to your problem.
<http://club.aopen.com.tw/faq/>

Download Software: After log on and having language selected, you may get the latest updated BIOS/utility and drivers you need under "Type" directory. In most case, newer versions of drivers and BIOS have solved earlier bugs or compatibility problems.
<http://download.aopen.com.tw/>

eForum: AOpen eForum is provided to discuss our products with other users, in which your problem probably had been discussed before or will be answered. After log on, you may select your preferred language under "Multi-language".
<http://club.aopen.com.tw/forum>

Contact Us: Please prepare detail system configuration and error symptom before contacting us. The part number, serial number and BIOS version are also very helpful.

Contact Distributors/Resellers: We sell our products through resellers and integrators. They should know your system configuration very well and should be able to solve your problem efficiently and provide important reference for you.