

Table of Contents

Table of Contents 1

- 1.1 A Thank-you Note Before You Get Start..... 3
- 1.2 Features of This Manual 4
- 1.3 Safety Information 4

Chapter 2 Introduction to This Motherboard 5

- 2.1 How does your motherboard look like?..... 5
- 2.2 Specification 6
- 2.3 Block Diagram 7

Chapter 3 Hardware Installation 8

- 3.1 Quick Installation Procedure 8
- 3.2 Installation You Have to Know..... 9
 - Installing CPU* 9
 - Installing CPU Cooler* 10
 - Installing CPU and System Fans* 11
 - Installing Memory Modules* 12
 - Maximum The Performance of the Dual Channel*..... 13
 - Connecting IDE and Floppy Cables* 14
 - Connecting Front Panel Cable* 15
 - Connecting ATX Power Cables*..... 16
- 3.3 Other Installation for Your Reference 17
 - Setting CPU Voltage and Frequency*..... 17
 - Connecting Serial ATA*..... 18
 - Adjusting your Hard Disk Setting*..... 19
 - Connecting PCI Express x16 Graphics Slot*..... 21
 - Connecting PCI Express x 1 Slot*..... 22
 - Connecting IrDA*..... 23
 - Connecting Game Port* 24

<i>Gigabit LAN Supported</i>	25
<i>Connecting USB2.0</i>	26
<i>Super 7.1 Channel Audio Effect</i>	27
<i>Connecting Front Audio</i>	28
<i>Connecting CD_IN</i>	29
<i>Connecting COM2 (for i915Gm-PL only)</i>	30
<i>Connecting Case Open</i>	31
<i>Connecting S/PDIF (Sony/Philips Digital Interface)</i>	32
<i>Colored Coded Back Panel (for i915Gm-PL)</i>	33
<i>Colored Coded Back Panel (for i915Pm-PL)</i>	34
<i>LED Indication</i>	35
3.4 Jumper Settings.....	36
Chapter 4 Special Features and Utilities	37
4.1 Other Useful Features.....	37
Chapter 5 Setting BIOS	38
5.1 Introduction.....	38
5.2 How To Use Phoenix-Award™ BIOS Setup Program.....	39
5.3 How To Enter BIOS Setup.....	39
5.4 BIOS Upgrade under Windows environment.....	40
5.5 Vivid BIOS technology.....	42
Chapter 6 Installing Drivers	43
6.1 Installing Drivers.....	44
6.2 Installing Utilities.....	45
Chapter 7 Troubleshooting	46
Chapter 8 Technical Support	47
<i>Model Name and BIOS Version</i>	48
<i>Register Your Motherboard</i>	48
<i>Technical Support</i>	49

1.1 A Thank-you Note Before You Get Start

First of all, we would like to express our gratitude for purchasing AOpen products. Once again, this motherboard is designed uniquely to meet all your personal needs with our great industry-designing ability and our everlasting perseverance to the quality of all our products.

This manual will introduce you how this motherboard is installed. Please keep it well for your future reference. If you lost your printed manual, you may also go to our website at <http://www.aopen.com> to download the updated file.

Now, we would like to invite you to personally experience this user-friendly manual and all of the powerful functions this AOpen product offers.

The logos of Adobe and Acrobat are the registered trademarks of Adobe Systems Incorporated.

The logos of AMD, Athlon, and Duron are the registered trademarks of Advanced Micro Devices, Inc.

The logos of Intel, Intel Celeron, Pentium II, III, Pentium 4 and Pentium Mare the registered trademarks of Intel Corporation.

The logos of nVidia are the registered trademarks of nVidia Corporation.

The logos of Microsoft, Windows are the registered trademarks of Microsoft Corporation in America and other countries.

All the titles of the products and the trademarks mentioned in this manual are for the purpose of illustrative conveniences and are possessed by their respective firms.

We regret not informing about any changes in usage standards and other related information. AOpen reserves the right of altering or modifying the content of this manual. In case of any mistakes or incorrect descriptions, which include those on the products, AOpen makes no guarantee or commitments.

This document is based on the copyright laws in order to protect our company and reserve all rights.

Under no circumstances are any types of duplicating and loading this brochure in any databases and media permitted except the permission signed on formal document by AOpen Company.

1996-2004 Copyrights, AOpen Ltd. All rights reserved.

1.2 Features of This Manual

To help you grab the useful information of this motherboard and aware of certain conditions that you might need to know, you will see the icons below frequently:



This contains knowledge you should know in process of assembling, or some helpful tips.

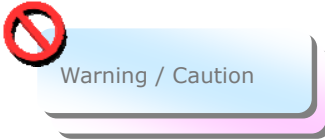

Please be careful when you see this mark. It highlights mistakes that occur often during assembling, or something you need to pay attention to.



This tip tells you some useful information that will make your installation smoothly.

1.3 Safety Information



Please wear a wrist strap and attach it to a metal part of the system unit before handling a component. Alternatively, you can also touch an object that is of ground connection or with metal surface.



Always unplug the power before you make any jumper setting.



Before you install or remove any components on the motherboard, please make sure to disconnect the power first in case of damaging motherboard or other components.

Chapter 2 Introduction to This Motherboard

2.1 How does your motherboard look like?

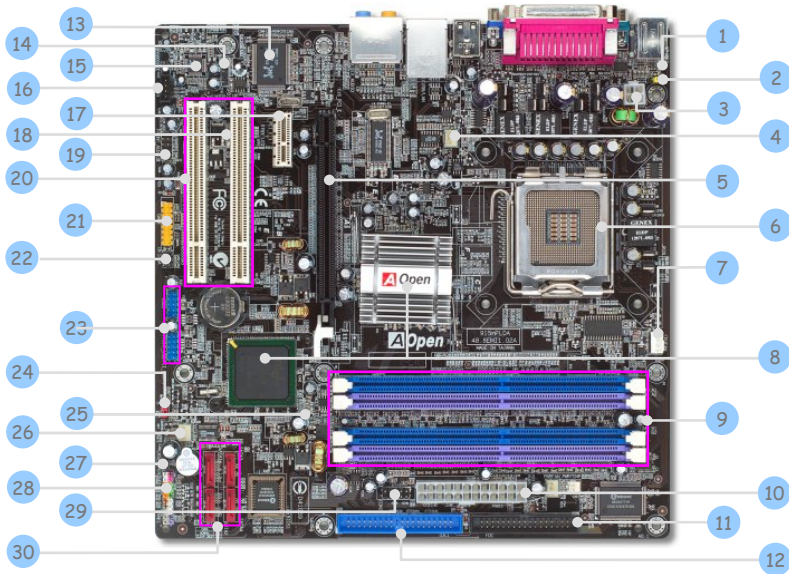

1. Resettable Fuse	16. CD-IN Connector
2. JP28 PS2 KB/Mouse Wakeup Jumper	17. PCI Express x1 Slot
3. 4-pin 12V ATX Power Connector	18. STBY LED
4. SYSFAN1 Connector	19. Front Audio Connector
5. PCI Express x 16 Graphics Slot	20. 32-bit PCI Expansion Slots x 2
6. LGA775 CPU Socket supporting Intel FC-LGA4 CPU	21. Game Port Connector
7. CPUFAN Connector	22. IRDA Connector
8. Intel 915G/ICH6 (i915Gm-PL) Intel 915P/ICH6 (i915Pm-PL)	23. USB2.0 Connectors x 2
9. 184-pin DIMMs x 4	24. JP14 CMOS Data Clear Jumper
10. ATX Power Connector	25. BOOT LED
11. FDD Connector	26. SYSFAN2 Connector
12. IDE Connector	27. Case Open Connector
13. Realtek Gigabit LAN Chip	28. Front Panel Connector
14. S/PDIF Connector	29. COM2 Connector
15. Onboard HD Audio Codec	30. Serial ATA Ports x 4

2.2 Specification

Here is the main function of your motherboard.

Models	i915Gm-PL	i915Pm-PL
CPU	Intel FC-LGA4 CPU Socket T 800MHz	Intel FC-LGA4 CPU Socket T 800MHz
Chipset	Intel 915G/ICH6	Intel 915P/ICH6
Main Memory	Dual Channel Mode DDR DDR 333/400 DDR DIMM x 4 DIMM Type : 128/256/512MB & 1GB Max Memory : 4GB	Dual Channel Mode DDR DDR 333/400 DDR DIMM x 4 DIMM Type : 128/256/512MB & 1GB Max Memory : 4GB
Graphics	Integrated VGA Engine in chipset PCI Express x 16 Graphics slot, support ADD2 card	PCI Express x 16 Graphics slot
IDE	Integrated ATA100 and Serial ATA Controller Max Disk: 144,000,000GB [by 48 bits LBA Spec.]	Integrated ATA100 and Serial ATA Controller Max Disk: 144,000,000GB [by 48 bits LBA Spec.]
LAN	Realtek Gigabit PCI LAN Chip	Realtek Gigabit PCI LAN Chip
Sound	HD Audio Codec on-Board Support Dolby Digital System, 7.1 Channel and above	HD Audio Codec on-Board Support Dolby Digital System, 7.1 Channel and above
USB	Integrated in chipset, USB 2.0 x 8	Integrated in chipset, USB 2.0 x 8
Slots	PCI Express x 1 slots x 1 PCI Express x 16 graphics slot x 1 PCI slots x 2	PCI Express x 1 slots x 1 PCI Express x 16 graphics slot x 1 PCI slots x 2
Back Panel I/O	PS/2 Keyboard x 1, PS/2 Mouse x 1 USB Port x 4, LAN Port x 1, VGA Port x 1 COM Port x 1, Printer Port x 1 Speaker_Out x 1, Line_In x 1, MIC_In x 1 Side SUR x 1, Rear SUR x 1 Center/Subwoofer x 1	PS/2 Keyboard x 1, PS/2 Mouse x 1 USB Port x 4, LAN Port x 1 COM Port x 2, Printer Port x 1 Speaker_Out x 1, Line_In x 1, MIC_In x 1 Side SUR x 1, Rear SUR x 1 Center/Subwoofer x 1
On Board Connector	Floppy Drive Connector x 1 IDE Channel: ATA100 x 1 Serial ATA Channel x 4 Front Panel x 1 Front Audio x 1 CPU FAN x 1, System FAN x 1, Chassis FAN x 1 Power FAN x 1 Power Temperature Connector x 1 Case Open Connector x 1 CD_IN x 1, IrDA x 1, S/PDIF x 1 COM2 x 1 Game Connector x 1 USB2.0 Connectors x 2	Floppy Drive Connector x 1 IDE Channel: ATA100 x 1 Serial ATA Channel x 4 Front Panel x 1 Front Audio x 1 CPU FAN x 1, System FAN x 1, Chassis FAN x 1 Power FAN x 1, Power Temperature Connector x 1 Case Open Connector x 1 CD_IN x 1, IrDA x 1, S/PDIF x 1 Game Connector x 1 USB2.0 connectors x 2
BIOS	Award PnP 4Mb Flash ROM BIOS	Award PnP 4Mb Flash ROM BIOS
Board Size	244 mm x 244 mm	244 mm x 244 mm

2.3 Block Diagram

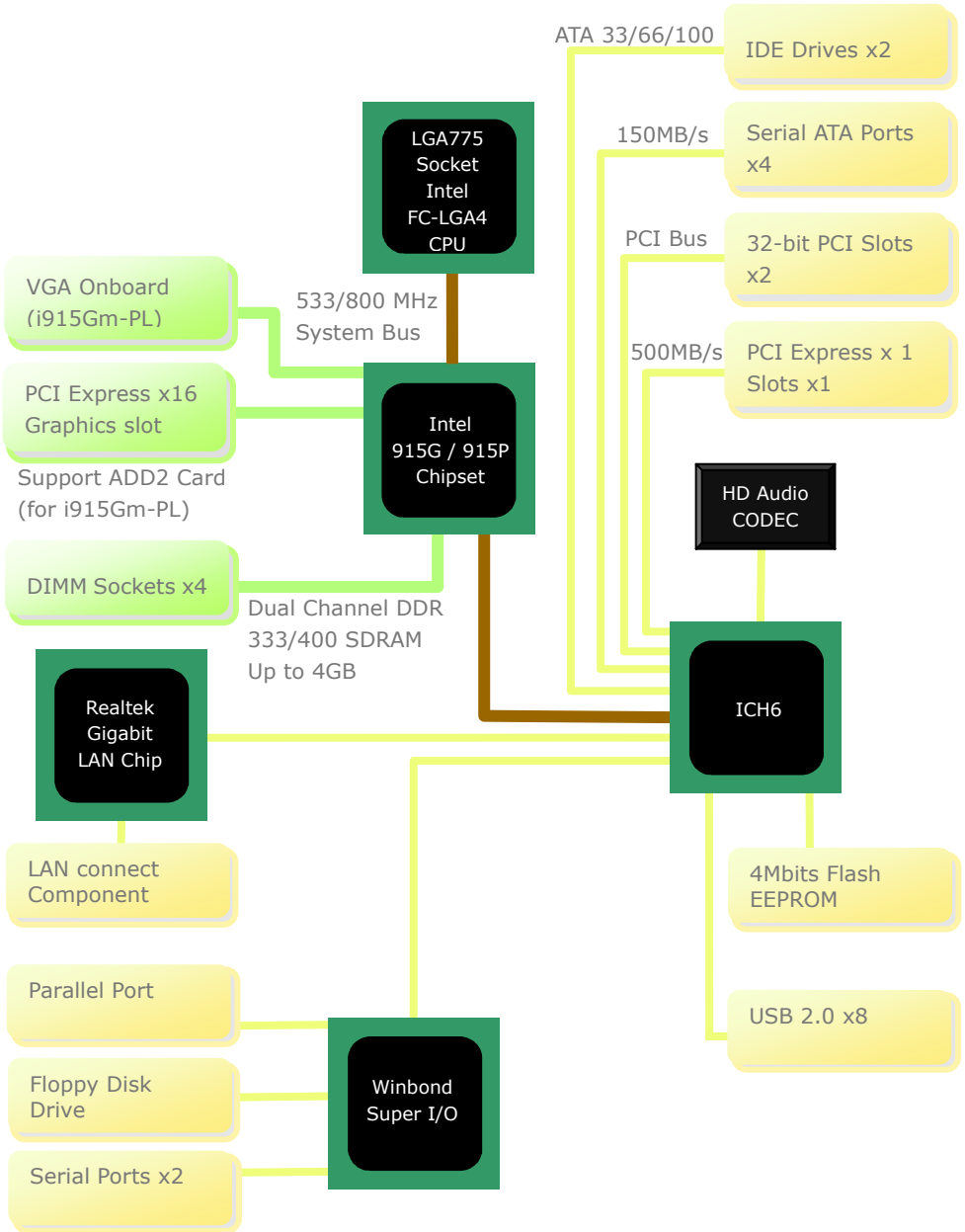

Chapter 3 Hardware Installation

3.1 Quick Installation Procedure

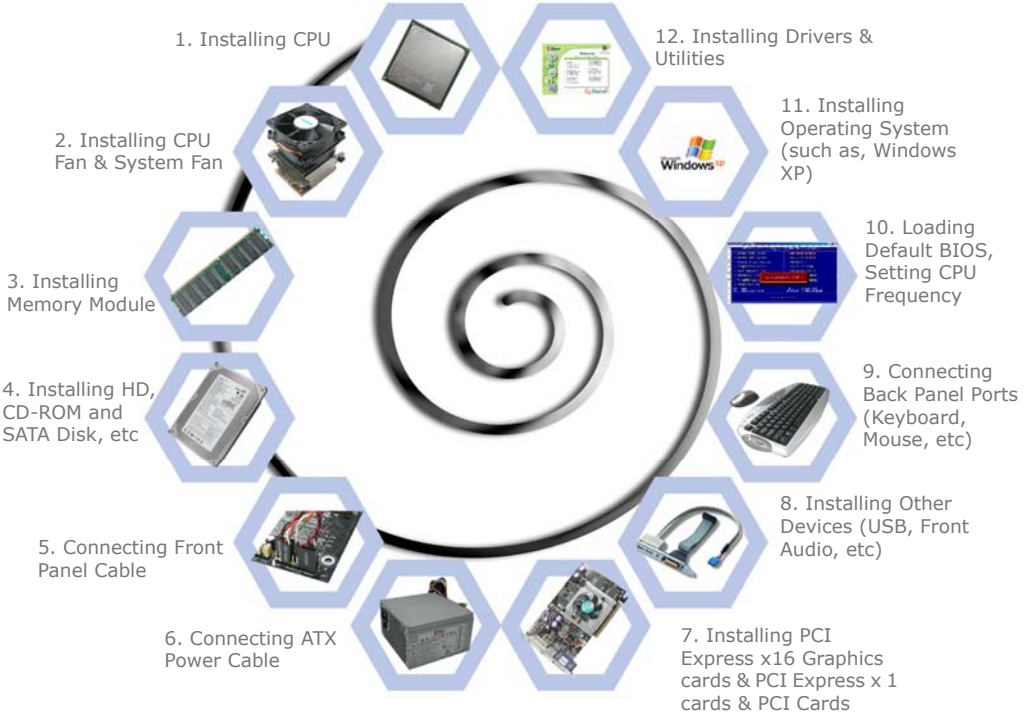

3.2 Installation You Have to Know

Installing CPU

This socket supports FC-LGA4 CPU, which is the latest CPU package developed by Intel. Other forms of CPU package are impossible to be fitted in.

1. Pull CPU socket lever and plate up.
2. Remove plastic cap from CPU socket plate.
3. Locate Pin 1 in the socket and look for a golden arrow on the CPU upper interface. Match Pin 1 and golden arrow. Then insert the CPU into the socket.
4. Press down the CPU socket plate and lever to finish CPU installation.

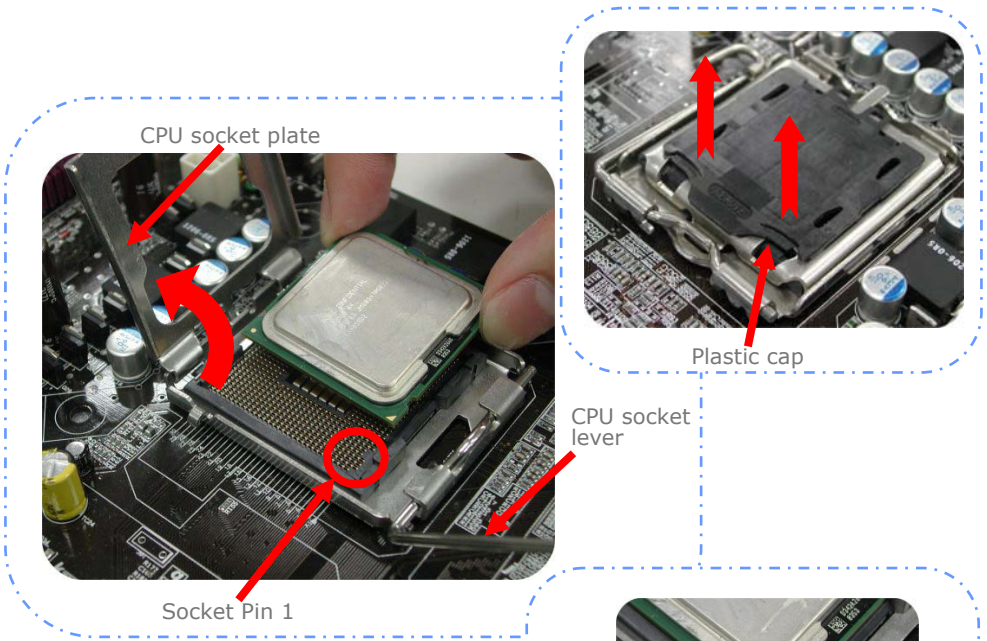

Warning: If you do not match the CPU socket Pin 1 and CPU golden arrow well, you may damage the CPU. And please don't touch CPU socket pins when installing CPU.

Note: It's strongly recommended by Intel to use thermal paste properly to avoid over-heat generated from Prescott CPU.

Installing CPU Cooler

1. Gently put down the CPU fan on CPU socket with four sticks aiming correctly to the four mounting holes.

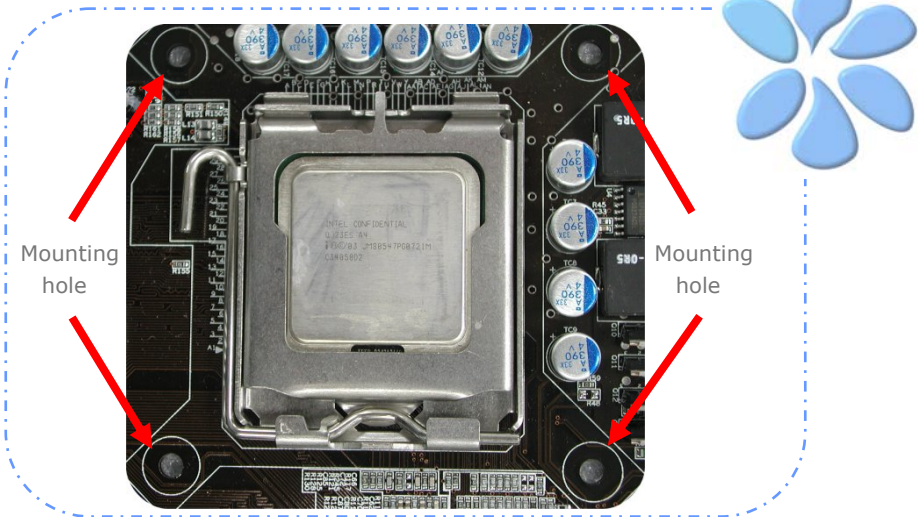

2. Press down four fixing sticks into the holes one by one. **Make sure the sticks are firmly fixed into the holes.**

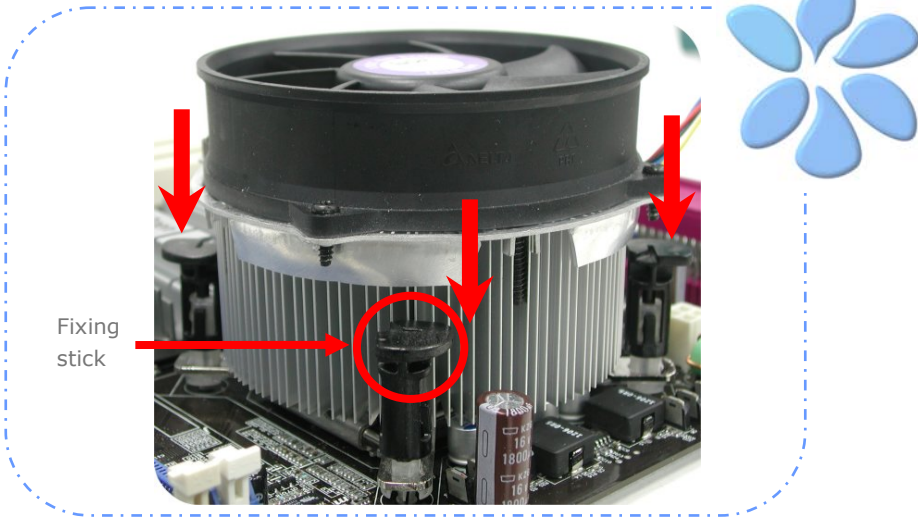

 **Note:** The picture above may look different from the product you purchased.

Installing CPU and System Fans

Plug the CPU fan cable to the 4-pin CPUFAN connector. If you have chassis fan, you can also plug it in SYSFAN1 or SYSFAN2 connector.

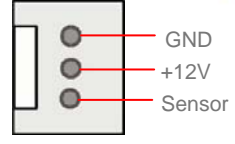
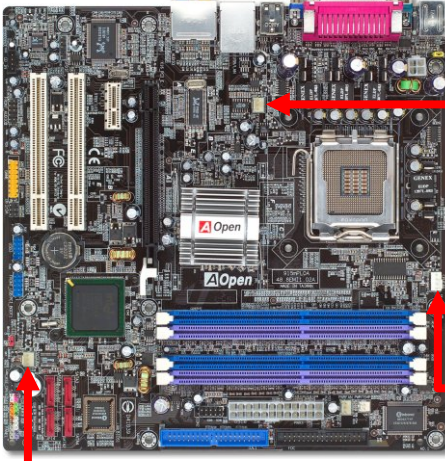

SYSFAN1 Connector

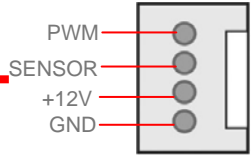

CPUFAN Connector

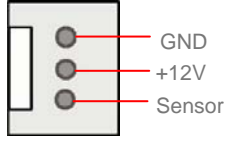

SYSFAN2 Connector

Note: Some CPU fans do not have sensor pin so that they cannot support fan monitoring.

Installing Memory Modules

DIMM slots are designed in Navy Blue and Electronic Blue which are very easy to recognize. Insert the module straight down to the DIMM slot with both hands and press down firmly until the DIMM module is securely in place.

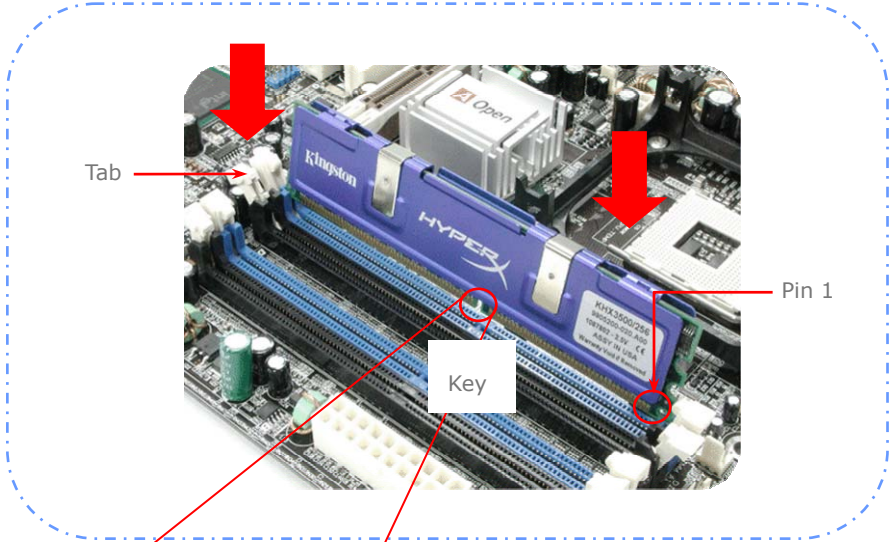

Note: The tabs of the DIMM slot will clip to hold the DIMM in place when the DIMM touches the slot's bottom.

Maximum The Performance of the Dual Channel

To obtain the highest performance of Dual Channel, the configuration of DIMM must meet the following conditions.

Matched DIMM configuration in each channel

- Same density (128MB~1GB)

As long as you insert memory modules of same density into Channel 1 (DIMM A1 & DIMM A2) and Channel 2 (DIMM B1 & DIMM B2), dual channel mode will be enabled.

DIMM A1 + DIMM A2 = DIMM B1 + DIMM B2

Ex: if you insert 1GB memory module into DIMM A1 and DIMM A2, dual channel mode will be enabled when DIMM B1 + DIMM B2 = 1GB

- Same DRAM bus width (x8 or x16)
- Either single-sided or double-sided



Note: Using memory modules of different chip will cause system unstable.

When dual channel mode is successfully enabled, the screen will show "Dual Channel Mode Enabled" while entering POST screen.

```
Phoenix - AwardBIOS v6.00PG, An Energy Star Ally
Copyright (C) 2003, Phoenix Technologies, LTD

Feb.02.2004 AOpen Inc.

Main Processor : Intel Pentium(R) 4 2.80GHz(200x14.0)
Memory Testing : 1048576K OK
CPU Brand Name : Intel(R) Pentium(R) 4 CPU 2.80GHz

Hyper-Threading Technology Enabled
Dual Channel Mode Enabled
CPU 200MHz / 200MHz Default / Setting
DRAM 400MHz / 400MHz AUTO / AUTO
AGP 66.67MHz / 66.67MHz 1.50 V / 1.50 V
PCI 33.33MHz / 33.33MHz 3.30 V / 3.30 V
IDE Channel 0 Master : WDC WD300AB-00CDB0 22.04A22
IDE Channel 0 Slave : None
IDE Channel 1 Master : None
IDE Channel 1 Slave : None
```



AOpen

<http://www.aopen.com.tw>

Press DEL to enter SETUP
02/02/2004-Springdale-G-6A79AAB9C-00

Connecting IDE and Floppy Cables

Connect the 34-pin floppy cable and 40-pin, 80-wire IDE cable to floppy connector and IDE connector. Be careful of the pin1 orientation. Wrong orientation may cause system damage.

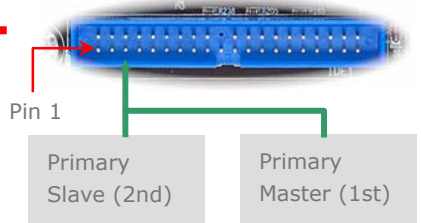
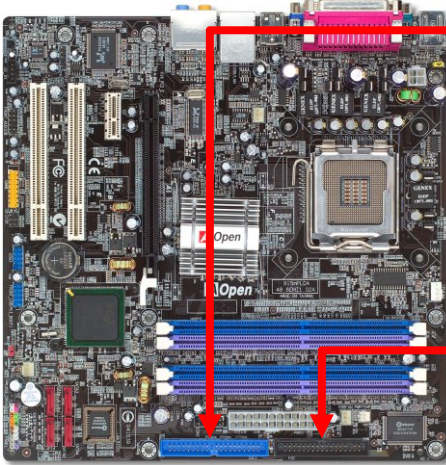

ATA 33/66/100 IDE Connector



FDD Connector

Connecting Front Panel Cable

Attach the power LED, speaker and reset switch connectors to the corresponding pins. If you enable "Suspend Mode" item in BIOS Setup, the ACPI & Power LED will keep flashing while the system is in suspend mode.

Locate the power switch cable from your housing, which is a 2-pin female connector from the housing front panel. Plug this connector to the soft-power switch connector marked SPWR.



	1			
NC			Power Switch	
NC			GND	
+5V			Power LED-	
HDD LED			GND	
HDD LED			Power LED+	
+5V			NC	
+5V			GND	
GND			GND	
NC			RESET	
SPEAKER			GND	

Front Panel Connector

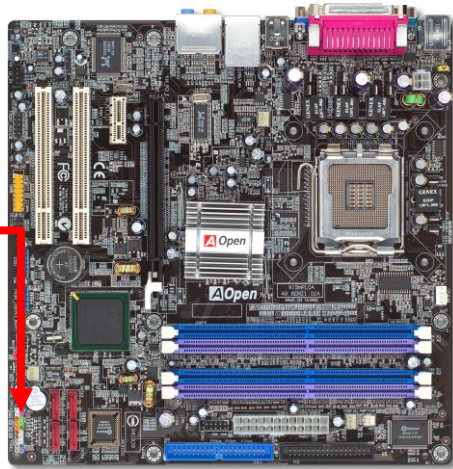

Connecting ATX Power Cables

This motherboard comes with a 24-pin and 4-pin ATX power connector as shown below. Make sure you plug them in the right direction. We strongly recommend you to insert the 4-pin connector before connecting the 24-pin connector.

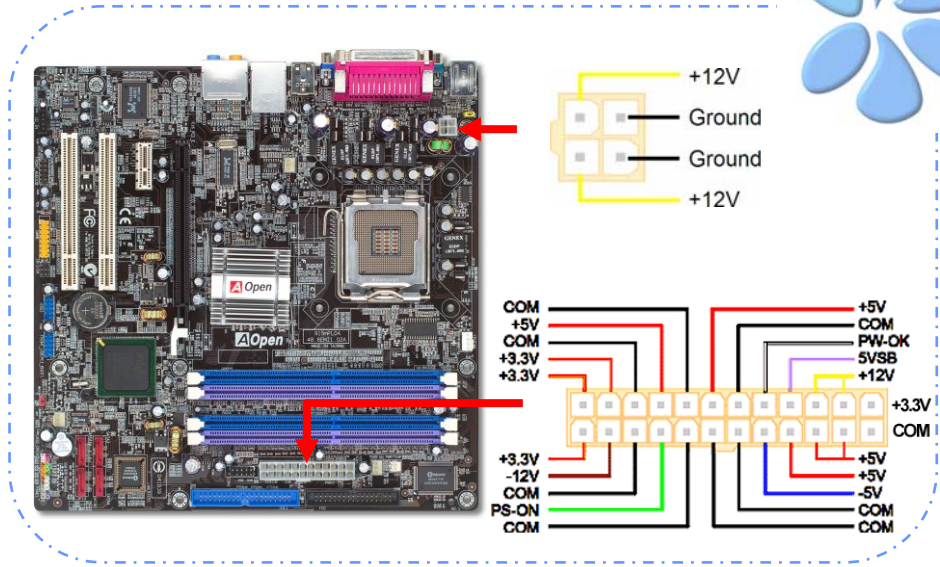

Note: Please aim the power plug at the **left side** of the 24-pin ATX power connector when the foolproof design faces you as shown.

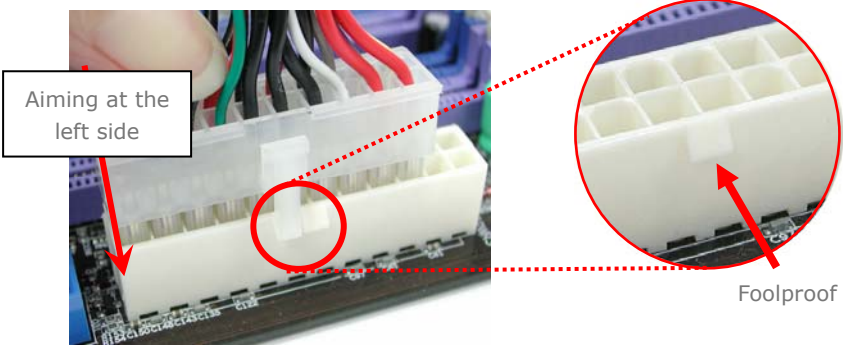

3.3 Other Installation for Your Reference

Setting CPU Voltage and Frequency

Setting CPU Core Voltage

This motherboard supports Voltage ID (VID) function to detect CPU voltage automatically during power-on. It's not necessary to set CPU core voltage.

Setting CPU Frequency

This motherboard is CPU jumper-less design; you can set CPU frequency by 1MHz stepping CPU Overclocking in the BIOS. **CPU Core Frequency = CPU FSB clock x CPU Ratio**. However, all CPU now sold in market belong to "Fixed Multiplier". That means users can not adjust the CPU Ratio but change CPU FSB clock to achieve overclocking only.

BIOS Setup > Frequency / Voltage Control > CPU Speed Setup

(Users will do the overclocking at their own risks!!)

CPU Ratio	8x, 10x... 24x, 25x, 26x, 27x, 28x
CPU FSB (Adjustment manually)	FSB = 100MHz-400MHz by 1MHz Stepping CPU Overclocking

Processor Number	Processor	Frequency	FSB	CPU Ratio	Cache
5 Series					
570		3.80G	800MHZ	19x	1MB L2
560		3.60G	800MHZ	18x	1MB L2
550		3.40G	800MHZ	17x	1MB L2
540		3.20G	800MHZ	16x	1MB L2
530		3.00G	800MHZ	15x	1MB L2
520		2.80G	800MHZ	14x	1MB L2
3 Series					
350		3.20G	533MHZ	24x	256K L2
345		3.06G	533MHZ	23x	256K L2
340		2.93G	533MHZ	22x	256K L2
335		2.80G	533MHZ	21x	256K L2

Note: With CPU speed changing rapidly, there might be faster CPU on the market by the time you received this installation guide. This table is kindly for your references only.



Warning: Intel 915G / 915P chipset support maximum 800MHz (200MHz*4) system; higher clock setting may cause serious system damage.



Note: Some CPU fans do not have sensor pin so that they can't support fan monitoring.

Connecting Serial ATA

To connect a serial ATA disk, you have to have a 7-pin serial ATA cable. Connect two ends of the serial ATA cable to the serial ATA header on the motherboard and the disk. Like every other traditional disk, you also have to connect a power cable. Please be noted that it is a jumper free implement; you don't need to set jumpers to define a master or slave disk. When serial ATA hard disks are installed on serial ATA ports, the one connected on Port0 (SATA1) will be set as the first boot device automatically. ***Please note that it doesn't support Hot-Plug in function.***

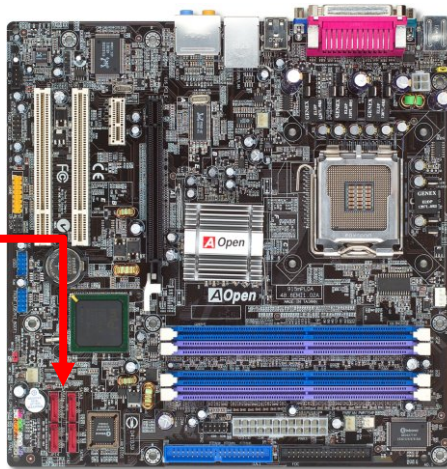
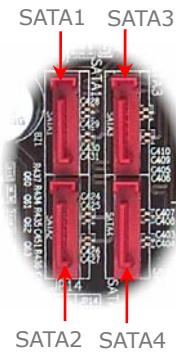

Adjusting your Hard Disk Setting

Except its original 1 set of parallel IDE, this motherboard supports the latest serial ATA hard disk. If you are unable to find your newly installed serial ATA hard disks on your operating system after having them installed, the problem may lie in the BIOS setting. You can simply adjust BIOS settings to have them work properly.

After installing your hard disks properly, you can directly go to BIOS setting screen for adjustment. Simply pressing **“Integrated Peripherals → OnChip IDE Device → On-Chip Serial ATA”** to choose your preferable mode. If you have no intention of changing its original setting, the default would be Auto.

The screenshot shows the Phoenix - AwardBIOS CMOS Setup Utility interface. The main menu is as follows:

▶ Standard CMOS Features	Load Setup Defaults
▶ Advanced BIOS Features	Load Turbo Defaults
▶ Advanced Chipset Features	Set Password
▶ Integrated Peripherals	Save & Exit Setup

Pressing Enter on 'Integrated Peripherals' leads to the 'Phoenix - AwardBIOS CMOS Setup Utility Integrated Peripherals' screen:

▶ Po	OnChip IDE Device	Press Enter	Item Help
▶ Ph	SuperIO Device	Press Enter	Menu Level ▶
▶ Si	USB Controller	Enabled	
▶ Fr	USB 2.0 Controller	Enabled	
	USB Keyboard Support	Auto	
	Onboard Audio Codec	Enabled	
	Onboard LAN Control	Enabled	

Pressing Enter on 'OnChip IDE Device' leads to the 'Phoenix - AwardBIOS CMOS Setup Utility OnChip IDE Device' screen:

*** On-Chip Serial ATA Setting ***	On-Chip Serial ATA	Auto	Item Help
	x PATA IDE Mode	Primary	Menu Level ▶
	SATA Port	SATA3,SATA4 Secondary	
*** On-Chip PATA Setting ***	On-Chip Primary PCI IDE	Enabled	[Disabled]: Disabled SATA Controller. [Auto]: Auto arrange by BIOS. [Combined Mode]: PATA and SATA are combined. Max.of 2 IDE drives in each channel. [Enhanced Mode]: Enable both SATA and PATA. Max.of 6 IDE drives are supported. [SATA Only]: SATA is operating in legacy mode.
	On-Chip Secondary PCI IDE	Enabled	

At the bottom of the screen, the following navigation keys are listed:

↑↓←→: Move Enter:Select +/-/PU/PD:Value F10:Save ESC:Exit F1:General Help
 F2:Item Help F5:Previous Values F6:Setup Defaults F7:turbo Defaults

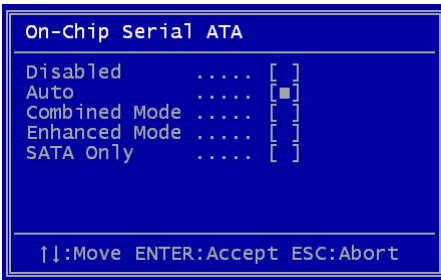

If you desire to change the default setting, press Enter for selection list:

Disabled: You can choose this item if there are only traditional IDE hard disks had been installed on your system. Disabling this item will also cancel the detection of serial ATA hard disks during POST, which will theoretically speed up your boot-up time a little bit; however,

please remember to re-adjust the setting here if you want to use serial ATA hard disk later.

Auto: This is factory default setting on this motherboard. Basically, if your system functions properly, it is no necessary to change it. The system will automatically recognize PATA (IDE) as primary..

Combined Mode: If you have traditional IDE hard disks and serial ATA hard disks installed at the same time, then you can choose this mode. Under this mode, you can randomly choose either IDE hard disks or serial ATA had disk as your first boot device. But please note, IDE will exist with serial ATA in a mapping way, which means it will occupy one of the serial Channel and leave you one serial Channel only. When PATA Mode is set to primary, SATA3 and SATA4 will be set to secondary, and when PATA Mode is set to secondary, SATA1 and SATA2 will be set to primary.

Enhanced Mode: If you are using the latest operating system (say, Windows XP, Windows.NET Server), it is highly recommended that you select Enhanced Mode. Under this mode the system will detect all six devices (traditional IDE x 2, Serial ATA x 4) completely and function perfectly. But please note that PATA Mode is set to primary under this mode.

Note: *According to practical lab tests of us, there are no obvious problems or mistakes happened when we set this mode under Windows2000 operating system; however, it is not recommended by Intel.*

SATA Only: You may select this mode if you install serial ATA hard disks only.

Connecting PCI Express x16 Graphics Slot

i915Gm-PL / i915Pm-PL provides a PCI Express x 16 Graphics slot, a black slot having the latest PCI Express x 16 specification on motherboard. The PCI Express x 16 is a bus interface targeted for high-performance 3D graphic. Traditionally AGP used both rising and falling edge of the 66MHz clock for 8X AGP, and the data transfer rate could achieve 2.1GB/s. Now PCI Express x 16 is moving to higher data transfer rate, which is upgraded to 8.0GB/s (250MB/s x 16 x 2, it's 4.0GB/s per direction). For i915Gm-PL, the PCI Express x16 Graphics slot can automatically recognize a PCI Express x 16 Graphics or a Multiplexed Intel DVO Output depending on which cards being inserted, such as PCI Express x 16 Graphics, or ADD2 (AGP Digital Display 2) cards. With an ADD2 card implemented to this slot, Multiplexed Intel DVO output will provide high-speed digital connection for digital displays or TV-OUT functionality.

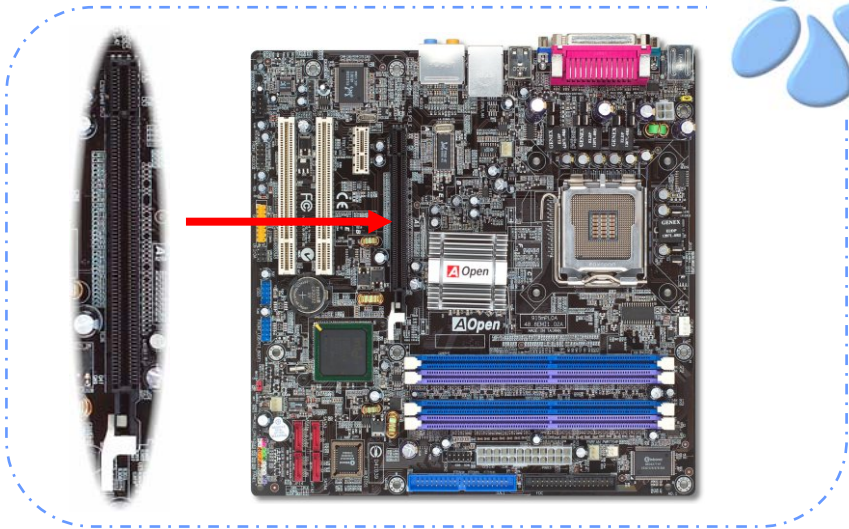

Connecting PCI Express x 1 Slot

This motherboard provides one PCI Express x 1 slot, which is located between the PCI Express x 16 and traditional PCI slot. In order to go with the step of today's and tomorrow's processors, PCI Express x 1 provides higher I/O bandwidth. The transfer data rate could achieve 500MB/s concurrently (it's 250MB/s per direction), which is nearly 4 times faster than the traditional PCI. You could install any PCI Express x 1 device in these slots for your preference.

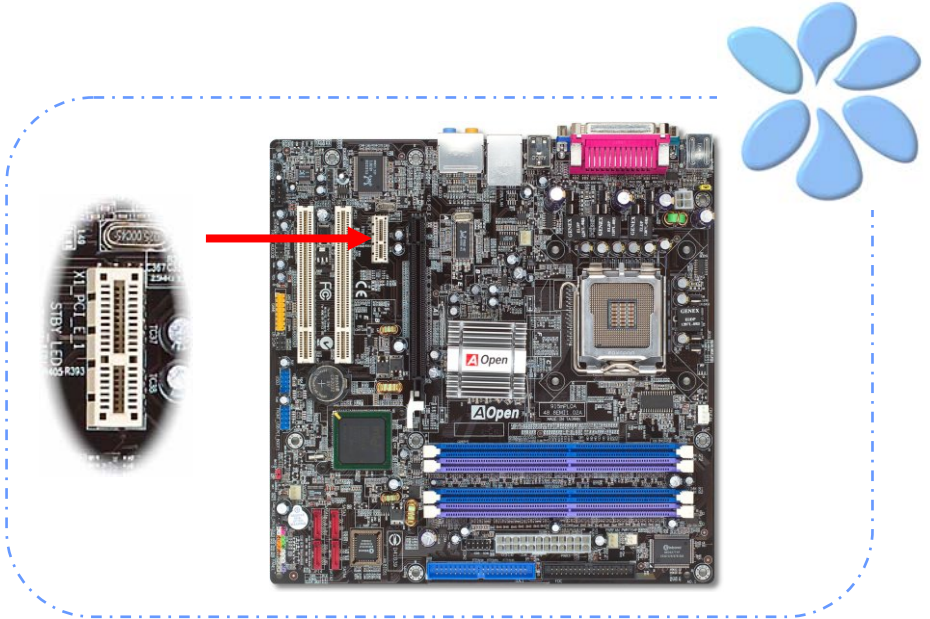

Connecting IrDA

The IrDA connector can be configured to support wireless infrared module, with this module and application software such as Laplink or Windows Direct Cable Connection, user can transfer files to or from laptops, notebooks, PDA devices and printers. This connector supports both HPSIR (115.2Kbps, 2 meters) and ASK-IR (56Kbps).

Install an infrared module onto the IrDA connector and enable the infrared function from BIOS Setup, UART Mode, you can use this function. Please make sure you connect correct orientation when plugging IrDA module.

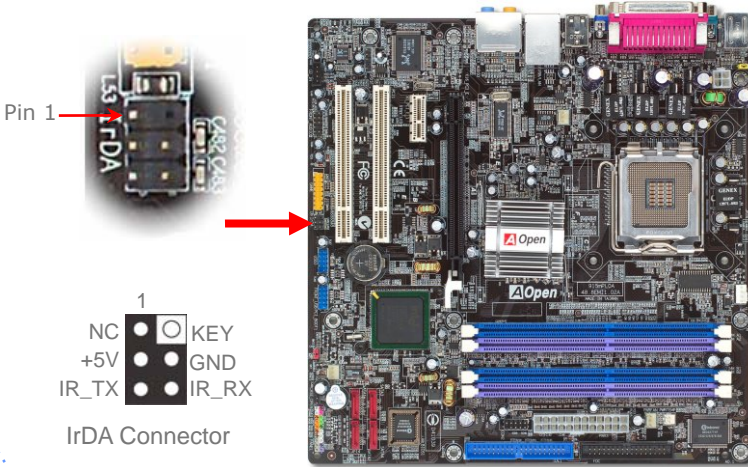

Connecting Game Port

This motherboard comes with a game port (Joystick-Midi) for you to connect any midi devices or joysticks. To use this function you have to have a joystick module and connect it with a game port cable to this port on the motherboard.

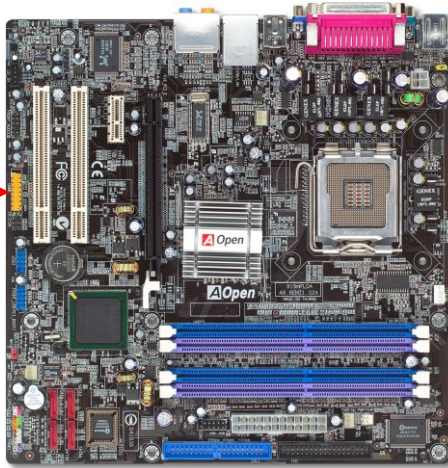
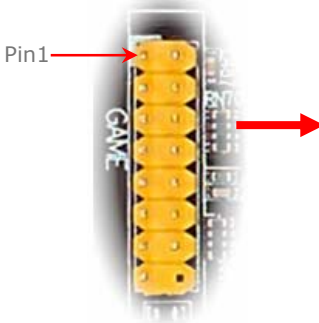

	1	2		
+5V	●	●	+5V	
JAB1	●	●	JBB1	
JACX	●	●	JBCX	
GND	●	●	MIDI_TXD	
GND	●	●	JBCY	
JACY	●	●	JBB2	
JAB2	●	●	MIDI_RXD	
+5V	●	○	KEY	
	15	16		

Game Port Connector



(User Upgrade Optional)

Gigabit LAN Supported

On the strength of Realtek Gigabit LAN controller on board, this motherboard provides 10/100/1000Mbps Ethernet for office and home use. The Ethernet RJ45 connector is located on the top of USB connectors. The right hand side LED indicates link mode; it lights in yellow when linking to network. The left hand side LED indicates the transfer mode and will light in green when data is transferring at 100Mbps (never lights while at 10Mbps), but will light in orange when transferring in Gigabit's mode. To enable or disable this function, you may simply adjust it through BIOS. To enable LAN wakeup function, you have to set the "Wake on PCI Card" enable in the BIOS "Power Management Setup" section.

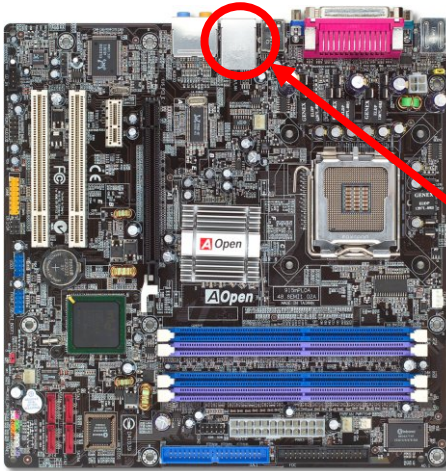

Speed LED (Left)
Green 100Mbps
Orange Gigabit mode



ACT LED (Right)
Yellow

Connecting USB2.0

This motherboard provides eight USB 2.0 ports to connect USB devices such as mouse, keyboard, modem, printer, etc. There are four ports on the back panel. You can use proper cables to connect Front USB connector to USB modules or chassis front panel.

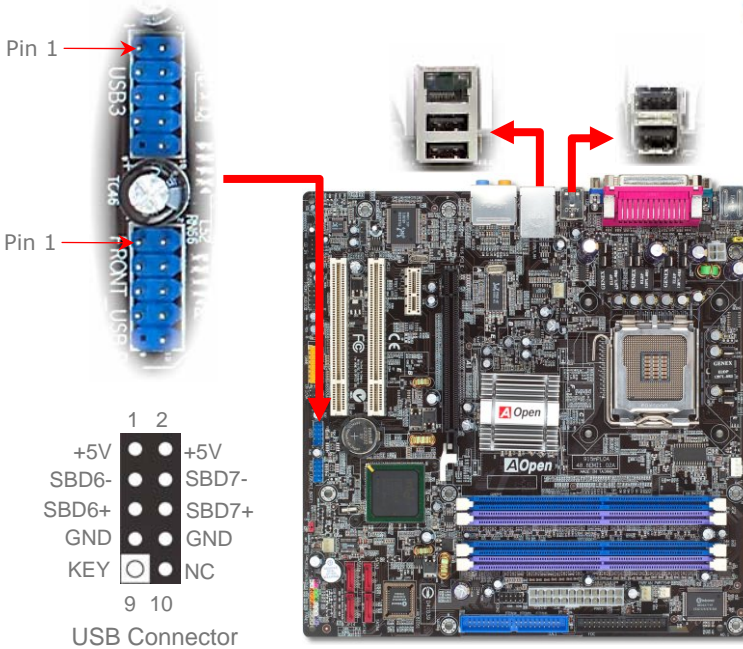

Super 7.1 Channel Audio Effect

This motherboard comes with HD Audio CODEC (Realtek ALC880), which supports the latest 7.1 Channel with high quality of audio effects, bringing you a brand new audio experience. This motherboard provides 7.1 Channel ports shown as below. Picture represents the standard location of all speakers in 7.1 Channel sound tracks. Please connect the plug of your front speakers to the green "Speaker out" port , rear surround speakers to orange port, side surround speakers to gray port and both of the center and subwoofer speakers to black port on the back panel.

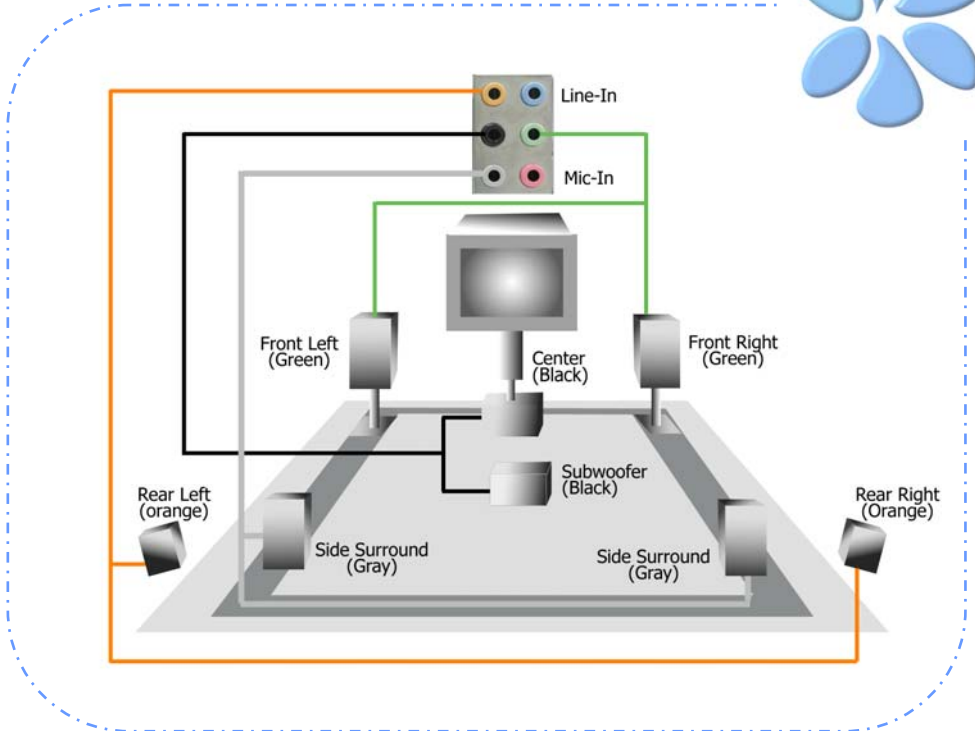

Connecting Front Audio

If the housing is designed with an audio port on the front panel, you'll be able to connect onboard audio to front panel through this connector. *Please be informed that to have front audio ports work properly, the front audio panel of the housing should be designed for High definition Audio jack. If the front audio panel is not designed for High Definition Audio jack, we strongly recommend you to connect the microphone to the back panel of the motherboard.*

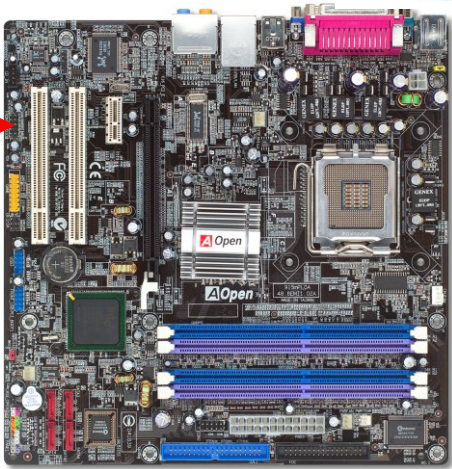
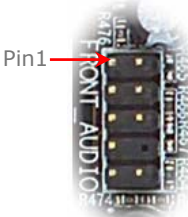

1	●	GND
PORT1L	●	PRESENCE#
PORT1R	●	SENSE1_RETURN
PORT2R	●	KEY
SENSE_SEND	○	SENSE2_RETURN
PORT2L	●	

Front Audio Connector

Connecting CD_IN

This connector is designed to connect CD Audio cable from CDROM or DVD drive to onboard sound.

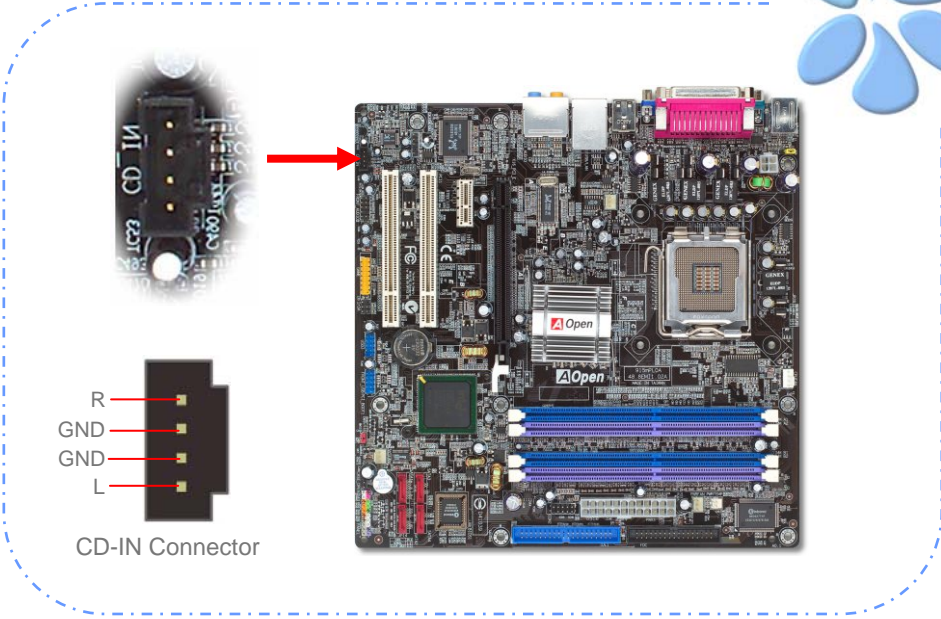

Connecting COM2 (for i915Gm-PL only)

i915Gm-PL provides two serial ports. One of them is on back panel connector, and the other is on the left of ATX power connector. With proper cable, you can connect it to the back panel of chassis.

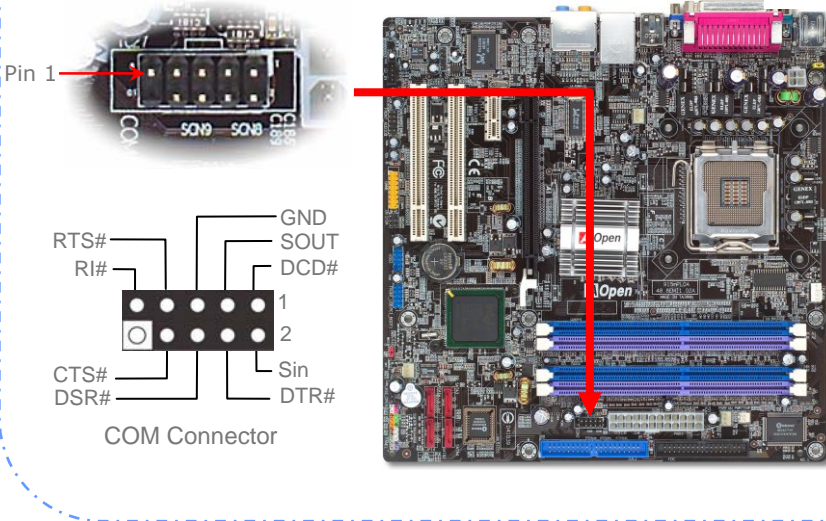

Connecting Case Open

The "CASE OPEN" header provides chassis intrusion-monitoring function. To make this function work, you have to enable it in the system BIOS, connect this header to a sensor somewhere on the chassis. So, whenever the sensor is triggered by lights or by the opening of the chassis, the system will beep to inform you. Please be informed that this useful function only applies to advanced chassis; you may purchase an extra sensor, attach it on your chassis and make a good use of this function.

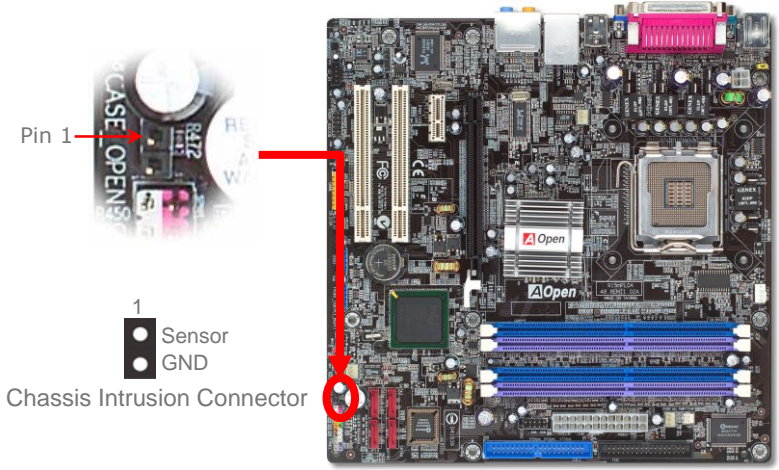

Connecting S/PDIF (Sony/Philips Digital Interface)

S/PDIF (Sony/Philips Digital Interface) is a newest audio transfer file format, which provides impressive audio quality through optical fiber and allows you to enjoy digital audio instead of analog audio. Through a specific audio cable, you can connect the S/PDIF connector to other end of the S/PDIF audio module, which bears S/PDIF digital output. Normally there are two S/PDIF outputs as shown, one for RCA connector, the most common one used for consumer audio products, and the other for optical connector with better audio quality. Same as outputs, you can also connect RCA or optical audio products to input connectors on the module and have the voice or music come out from your computer. However, you must have a S/PDIF supported speaker/amplifier/decoder with S/PDIF digital input/output to connect to the S/PDIF digital input/output to make the most out of this function.



Pin 1

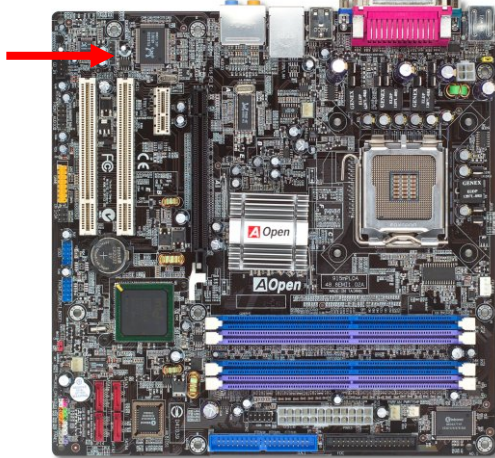
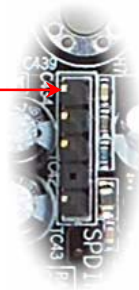

- 5 ● SPDIF IN
- GND
- SPDIF OUT
- KEY
- +5V

1
S/PDIF Connector

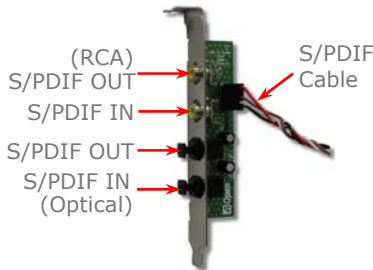

S/PDIF Module
(User Upgrade Optional)



Colored Coded Back Panel (for i915Gm-PL)

The onboard I/O devices have PS/2 Keyboard, PS/2 Mouse, RJ-45 LAN Connector, COM1, VGA port, USB, HD Audio sound and Parallel ports. The view angle of drawing shown here is from the back panel of the housing.

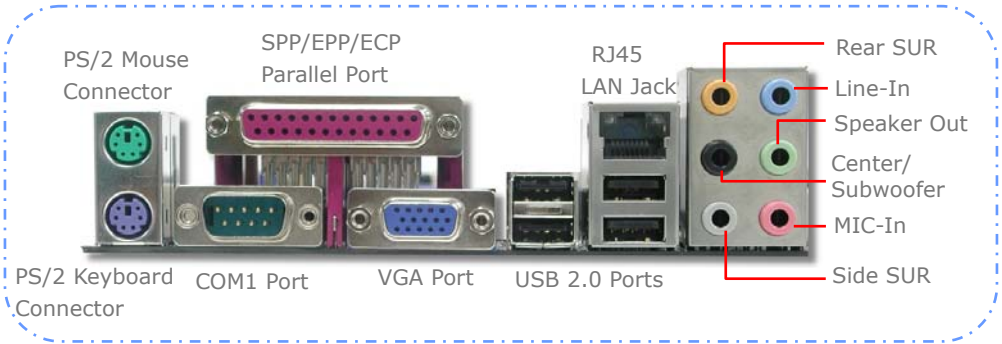

PS/2 Keyboard:

For standard keyboard, which use a PS/2 plug.

PS/2 Mouse:

For PC-Mouse, which use a PS/2 plug.

Parallel Port:

To connect with SPP/ECP/EPP printer.

COM1 Port:

To connect with pointing devices, modem or others serial devices.

RJ-45 LAN Port:

To connect Ethernet for home or office use.

VGA Connector:

To connect with PC monitor.

USB Port:

Available for connecting USB devices.

Side SUR:

For side surround speaker.

Center/Subwoofer:

For center & subwoofer speaker.

Rear SUR:

For rear speaker.

Speaker Out:

To External Speaker, Earphone or Amplifier.

Line-In:

Comes from the signal sources, such as CD/Tape player.

MIC-In:

For Microphone

Colored Coded Back Panel (for i915Pm-PL)

The onboard I/O devices have PS/2 Keyboard, PS/2 Mouse, RJ-45 LAN Connector, COM1, COM2 port, USB, HD Audio sound and Parallel ports. The view angle of drawing shown here is from the back panel of the housing.

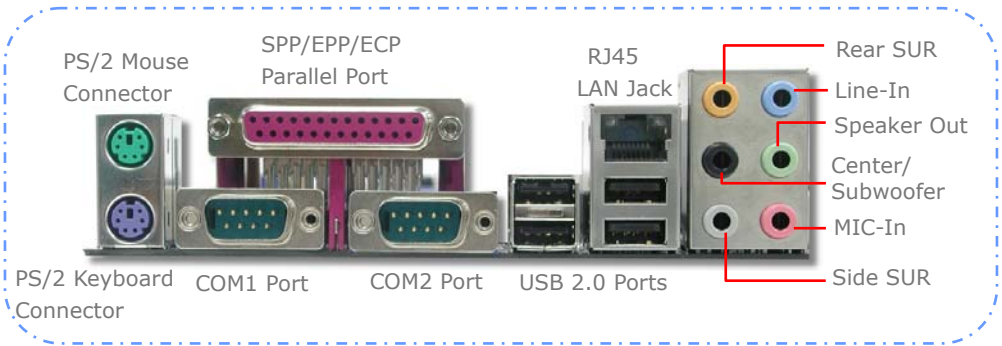

PS/2 Keyboard:

For standard keyboard, which use a PS/2 plug.

PS/2 Mouse:

For PC-Mouse, which use a PS/2 plug.

Parallel Port:

To connect with SPP/ECP/EPP printer.

COM1 / COM2 Port:

To connect with pointing devices, modem or others serial devices.

RJ-45 LAN Port:

To connect Ethernet for home or office use.

USB Port:

Available for connecting USB devices.

Side SUR:

For side surround speaker.

Center/Subwoofer:

For center & subwoofer speaker.

Rear SUR:

For rear speaker.

Speaker Out:

To External Speaker, Earphone or Amplifier.

Line-In:

Comes from the signal sources, such as CD/Tape player.

MIC-In:

For Microphone

LED Indication

LED indication including Standby LED and BOOT LED are AOpen's considerate designs that aim at providing you friendly system information.

STBY LED will light up when power is provided to the motherboard, giving you a convenient indication check the system power status in circumstances such as power on/off, stand-by mode and RAM power status during Suspend to RAM mode.

BOOT LED will keep blinking when you power the system on and when your system is under POST (Power-On Self Test). After POST diagnoses everything all right and finishes the booting, the LED will stay on otherwise it will remain flashing to warn you that mistakes have occurred during POST.

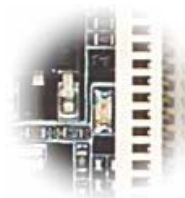
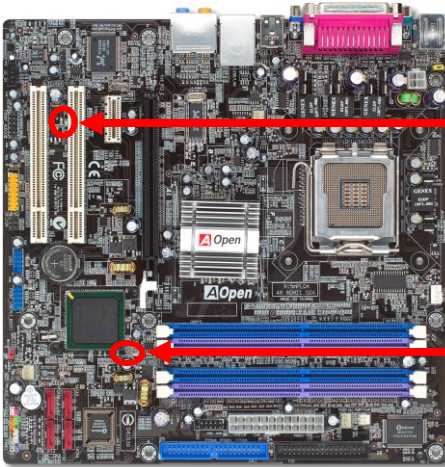

STBY LED



BOOT LED

3.4 Jumper Settings

JP28 Keyboard / Mouse Wakeup Jumper

This motherboard provides PS2 keyboard / mouse wake-up function.

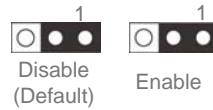
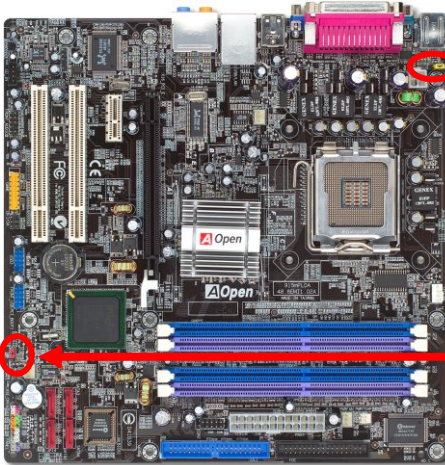

JP28 PS2 KB/Mouse
Wakeup Jumper

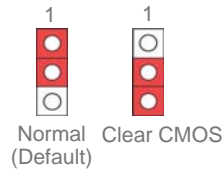

JP14 Clear CMOS Jumper

JP14 Clear CMOS Data

You can clear CMOS to restore system default setting. To clear the CMOS, follow the procedure below.

1. Turn off the system and unplug the AC power.
2. Remove ATX power cable from connector PWR3.
3. Locate JP14 and short pins 2-3 for a few seconds.
4. Return JP14 to its normal setting by shorting pin 1 & pin 2.
5. Connect ATX power cable back to connector PWR3.

Chapter 4 Special Features and Utilities

4.1 Other Useful Features

With excellent design ability of R&D team, AOpen boasts for its various powerful and handy features that come with our product like follows. You are welcomed to visit our technical website to learn more about those features. <http://english.aopen.com.tw/tech/techinside>



1MHz Stepping CPU



Serial ATA



V4 Power Engine



EzWin Flash



EzInstall



DieHard BIOS Lite



PCI Express



Dual Channel



Gigabit LAN



Hyper-Threading

Chapter 5 Setting BIOS

5.1 Introduction

System parameters can be modified by going into BIOS Setup menu; this menu allows you to configure the system parameters and save the configuration into the 128 bytes CMOS area (normally in the RTC chip or in the main chipset).

The Phoenix-Award BIOS™ that installed in the Flash ROM of the motherboard is a custom version of an industry standard BIOS. The BIOS provides critical low-level support for standard devices such as hard disk drives, serial and parallel ports.

AOpen's R&D engineering team had optimized most BIOS settings of this motherboard. However, some default settings of BIOS cannot fine-tune those sections that controlled by chipset. Therefore, this chapter is intended to guide you and help you to configure some other settings.

To enter BIOS setup menu, press when POST (Power-On Self Test) screen is shown on your monitor.



Note: Because BIOS code is the most often changed part on motherboard, the BIOS information contained in this manual may be different from the BIOS version that comes with your motherboard.

5.2 How To Use Phoenix-Award™ BIOS Setup Program

Generally, you can use arrow keys to highlight items that you want to choose, press <Enter> key to select, and use <Page Up> and <Page Down> keys to change setting values. You can press <Esc> key to quit Phoenix-Award™ BIOS setup program. The following table provides details about how to use keyboard in the Phoenix-Award™BIOS setup program.

Key	Description
Page Up or +	Change setting to next value or increase the value.
Page Down or -	Change setting to previous value or decrease value.
Enter	Select the item.
Esc	In main menu: Quit without saving any changes. In sub menu: Exit current menu to main menu.
Up Arrow	Highlight previous item.
Down Arrow	Highlight next item.
Left Arrow	Move the light bar to left side of menu.
Right Arrow	Move the light bar to right side of menu.
F6	Load Setup Default setting value from CMOS.
F7	Load turbo setting value from CMOS.
F10	Save changed settings and exit setup program.

5.3 How To Enter BIOS Setup

After finishing the jumper settings and connecting cables, you can power on and enter the BIOS Setup. Press during POST (Power-On Self Test) and choose "Load Setup Defaults" for recommended optimal performance.



The screenshot shows the Phoenix - AwardBIOS CMOS Setup Utility interface. The main menu is displayed on a dark blue background with yellow text. The 'Load Setup Defaults' option is highlighted with a red circle and a red arrow pointing to it. The menu items are:

- ▶ Standard CMOS Features
- ▶ Advanced BIOS Features
- ▶ Advanced Chipset Features
- ▶ Integrated Peripherals
- ▶ Power Management Setup
- ▶ PnP/PCI Configurations
- ▶ Silent BIOS/HW Monitor
- ▶ Frequency/Voltage Control
- Load Setup Defaults (highlighted)
- Load Turbo Defaults
- Set Password
- Save & Exit Setup
- Exit Without Saving
- Load EEPROM Defaults
- Save EEPROM Defaults
- ▶ Credits

At the bottom of the screen, the following text is displayed:

Esc : Quit
F10 : Save & Exit Setup
| | - - : Select Item



Warning: Please avoid of using "Load Turbo Defaults", unless you are certain your system components (CPU, SDRAM, HDD, etc.) are good enough for turbo setting.

5.4 BIOS Upgrade under Windows environment



With outstanding R&D ability of AOpen, we now bring you a whole new BIOS Flash wizard ---- EzWinFlash. With an eye to convenience for users, EzWinFlash combines the BIOS binary code and flash module together, so the only thing you have to do is just clicking on the utility you downloaded from web and let it help you complete the flash process automatically. EzWinFlash detects your motherboard and checks the BIOS version cleverly to prevent your system from any possible failure. Moreover, EzWinFlash has been taken into consideration to go with any windows platform you might be using, no matter if you're using Windows 95/98, 98SE/ME, NT4.0/2000, or Windows XP.

In the meanwhile, in order to provide a much more user-friendly operating environment, AOpen EzWinFlash is natively designed to have multi-language function to provide easier way for user in changing BIOS setting.

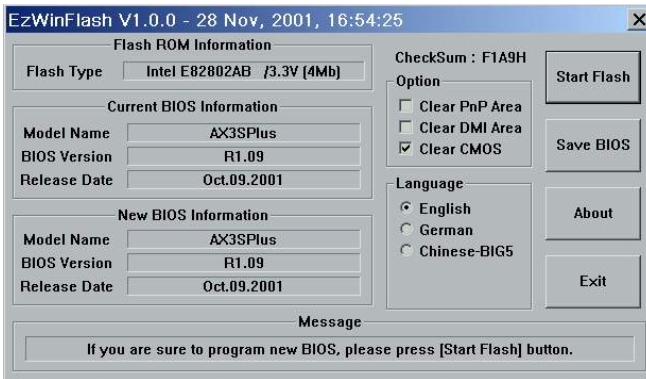

Caution: You are taking a risk of BIOS flash failure when you update your system. If your motherboard is working stable, and there are no major bugs to be fixed by a latter BIOS revision, we recommend that you **DO NOT** upgrade your BIOS. If you intent on upgrade **PLEASE MAKE SURE** you get the right BIOS revision for your motherboard model so as to avoid any possible failure.

Note: The model name on this BIOS picture is for reference only. It may not be the same model with your motherboard.





You may accomplish BIOS upgrade procedure with EzWinFlash according to following steps, and it's STRONGLY RECOMMENDED to close all applications before you start the upgrades.

Download the latest version of BIOS package zip file from AOpen official web site. (Ex: <http://english.aopen.com.tw/>)

Unzip the downloaded BIOS package (ex: WSGMAXII102.ZIP) with WinZip (<http://www.winzip.com>) in Windows environment.

Save the unzipped files into a folder, for example, WSGMAXII102.EXE & WSGMAXII102.BIN.

Double click WSGMAXII102.EXE; EzWinFlash will detect the model name and BIOS version of your motherboard. If you collect wrong BIOS, you will not be allowed to proceed with the flash steps.

You may select a preferred language in main menu, then click [Start Flash] to begin the BIOS upgrade procedure.

EzWinFlash will complete all the process automatically, and a dialogue box will pop up to ask you to restart Windows. Click [YES] to reboot Windows.

Press at POST to enter BIOS setup screen; choose "Load Setup Defaults", then "Save & Exit Setup". Done!

It is strongly recommended NOT to turn off the power or run any applications during FLASH PROCESS.



Warning: *The new BIOS upgrade will permanently replace your original BIOS setting when flashing. You may need to reconfigure the BIOS setting before your system goes back to work as normal.*

5.5 Vivid BIOS technology



Have you been fed up with the conservative and immutable POST screen? Let's rule out the tradition idea that POST screen are stiff and frigid, and let AOpen show you the newly developed VividBIOS to experience the lively vivid colorful POST screen!

Unlike earlier graphic POST screen which could occupy the whole screen and mask text information during POST, AOpen VividBIOS deals with graphics and texts separately, and makes them running simultaneously during POST. With this innovative design, VividBIOS now brings you a beautiful and sleek 256 colors screen without missing any important information shown on POST screen.

In addition, the limited space of BIOS ROM is another big issue. When all of the traditional BIOS can only show space-consuming and uncompressed Bitmap, AOpen has considerably tuned the BIOS to next generation, to recognize the smaller-sized GIF format and even dynamic-showing GIF animation.



Vivid BIOS shares the same fundamental technology with Open JukeBox CD Player, you may use the same EzSkin utility to change your VividBIOS screen or to download your favorite Open JukeBox skin. If you see this little logo shown beside your model name on the motherboard download page,  <http://english.aopen.com.tw/tech/ezskin/vivid.htm>, it is assured that your motherboard supports this innovative feature!

Chapter 6 Installing Drivers



You may think that installing drivers and utilities would be a repeated task of going through those installation wizards and steps-by-steps. Now, you will be surprised with how “Ez” EzInstall could do. Without wizards or steps, all you have to do is to do one click and then it’s done. Click and done. Yes. EzInstall makes installation easy and even foolproof!

After putting in the CD, you will be prompted with AOpen welcome page and our branches information.

First, click on the install driver ICON at left side for necessary drivers.

Second, click on the install utility ICON at left side for preferred utilities.

Practically, it’s done. But you may also browse CD contents, Readme to get more information or just exit the CD installation.

The screenshot shows the AOpen EzInstall welcome screen. On the left side, there is a vertical menu of icons: a CD-ROM, a folder, a magnifying glass, a document, and a folder with a document. Callout boxes point to these icons with the following labels: 'Install driver', 'Install utility', 'Browse CD Contents', 'Readme', and 'Exit CD'. On the right side, there is a callout box pointing to the 'Install User manual' icon with the label 'Click to install online manual'. The main content area features the AOpen logo, a 'Welcome' message, and contact information for various branches. A callout box points to this contact information with the label 'AOpen branches information'.

AOpen

Welcome

Thank you for choosing AOpen i9150m-PL

Contact us

AOpen Inc. http://www.aopen.com.tw TEL: +886-2-3789-5888 FAX: +886-2-3789-5899	AOpen Computer GmbH. http://www.aopen.com.de TEL: +49-1805-559191 FAX: +49-2102-157799
AOpen America Inc. http://english.aopen.com.tw TEL: +1-510-489-8928 FAX: +1-510-489-1998	AOpen Japan Inc. http://www.aopen.co.jp TEL: +81-048-290-1800 FAX: +81-048-290-1820
AOpen Computer B.V. http://www.aopen.nl TEL: +31-73-645-9516 FAX: +31-73-645-9604	AOpen International Co., Ltd. http://www.aopen.com.cn TEL: +86-21-6225-8622 FAX: +86-21-6225-7926

Install User manual

Ez Install

Install driver

Install utility

Browse CD Contents

Readme

Exit CD

Click to install online manual

AOpen branches information

6.1 Installing Drivers

As you may see from the Installing driver page, EzInstall had picked up necessary for your motherboard. All you have to do is just click on the "GO", and no more steps afterward, of all listed drivers, grey checks indicate necessary drivers; you cannot click them off. Red checks can be disabled if you don't want to install them now.



Press the icon will prompt the "Install Driver" page. You may also press "Back" to return to the Main page.



Once clicking "GO", EzInstall will run the installing procedure automatically, and prompt a reboot dialog (Some drivers or utilities may skip the reboot part).

6.2 Installing Utilities

Installing Utilities is virtually the same as installing drivers. AOpen provides you many friendly and powerful utilities to manage your system. You may find lots of fabulous utilities listed there, and all you have to do is to click on the "GO", then it will install the utilities to your system right away without complicated steps.



Press the icon will prompt the "Install Utilities" page for your selection. You may also press "Back" to get back to the Main page.





Troubleshooting

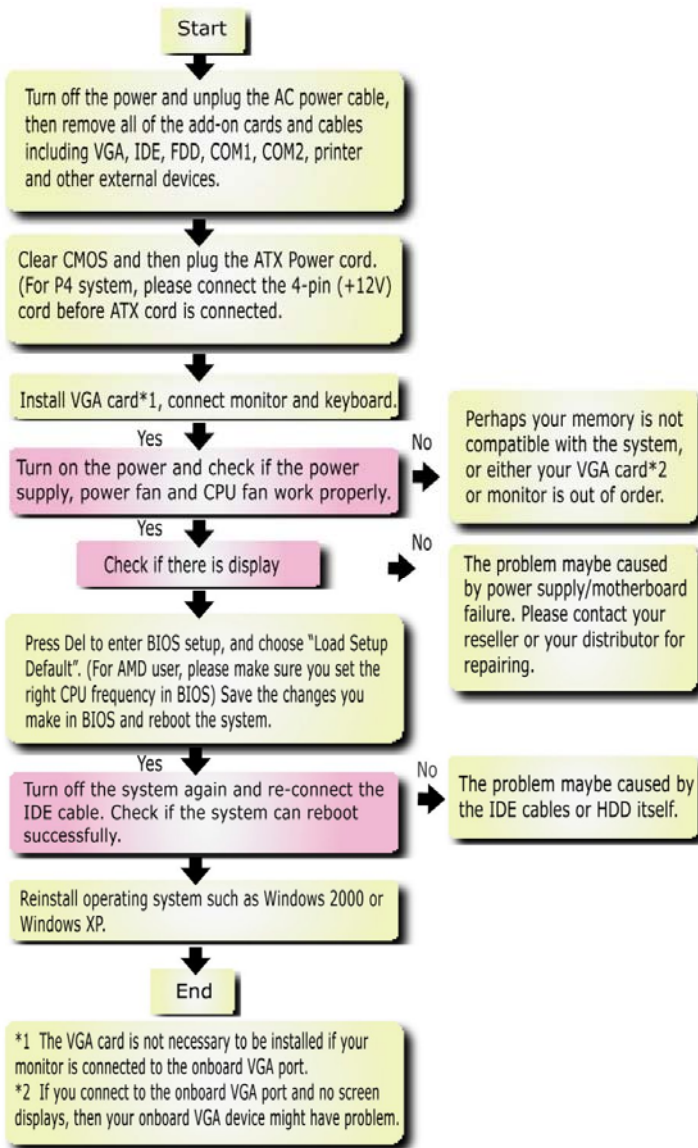

Chapter 8 Technical Support

Dear Customer,

Thanks for choosing AOpen products. We invite you to register at <http://www.aopen.com> to become a Gold Member of Club AOpen so as to ensure quality service in the future. In order to maintain the best service to every customer of us, we recommend you to follow the procedures below and seek help from our branches according to the region you buy the product. With your help, we can then continue to provide efficient and the best quality service to every customer.

Thanks very much for your understanding!

AOpen Technical Supporting Team

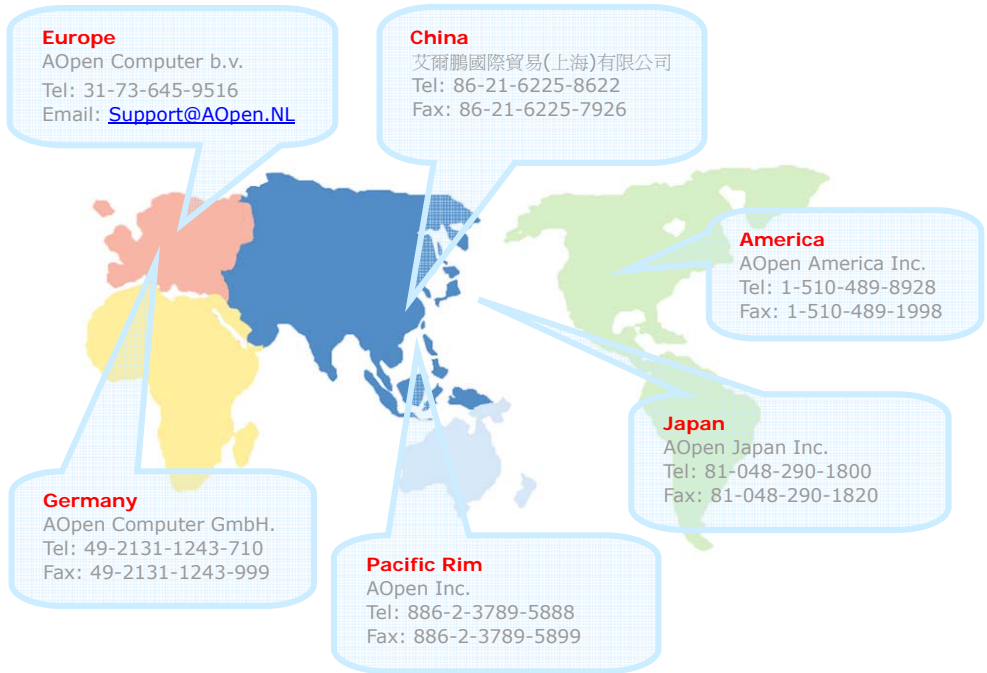

Europe Email:	Support@AOpen.NL
Pacific Rim:	http://www.aopen.com.tw/tech/default.htm
China:	http://www.aopen.com.cn/tech/default.htm
Germany:	http://www.aopencom.de/tech/default.htm
America:	http://usa.aopen.com/tech/default.htm
Japan:	http://aopen.jp/tech/index.html

Model Name and BIOS Version

Model name and BIOS version can be found on upper left corner of first boot screen (POST screen). For example:



i915Gm-PL is model name of motherboard; R1.02 is BIOS version

Register Your Motherboard

Thanks for choosing AOpen product, please register this motherboard at <http://club.aopen.com.tw/productreg/> to become a Gold member of Club AOpen, and to ensure high service quality and priority from AOpen. You will also have a chance to play slot machine game to win prize from AOpen. Please prepare the following information before you start: Model Name, Part Number (P/N), Serial Number (S/N) and Purchase Date. The Part Number and Serial number are printed on bar code label. You can find this bar code label on the outside packing or on component side of PCB. For example:



Part No.

Serial No.

P/N: 91.88110.201 is part number, S/N: 91949378KN73 is serial number.

Phoenix-Award BIOS ERROR Message

Beep Sound	Message
1 short(Beep)	System booting is normally.
1 long - 1 short(Beep)	DRAM ERROR
1 long - 2 short(Beep)	Display card or monitor connected error
1 long - 3 short(Beep)	Keyboard Error
Long(Beep) continuous	DRAM hasn't inset correctly.



Technical Support

Online Manual: To download manual, please log on and then select your preferred language. Under "Type" directory, choose "Manuals" to go to our manual database. You can also find the manual and EIG in AOpen Bonus Pack.
<http://download.aopen.com.tw/downloads>

Test Report: We recommend you to choose board/card/device from the compatibility test reports for assembling your PC. It may prevent incompatibility problems.
<http://english.aopen.com.tw/tech/report/default.htm>

FAQ: Here we list problems that users often encounter and FAQ (Frequently Asked Questions). You may select your preferred language after log on, and may be able to find a solution to your problem.
<http://club.aopen.com.tw/faq/>

Download Software: After log on and having language selected, you may get the latest updated BIOS/utility and drivers you need under "Type" directory. In most case, newer versions of drivers and BIOS have solved earlier bugs or compatibility problems.
<http://download.aopen.com.tw/downloads>

eForum: AOpen eForum is provided to discuss our products with other users, in which your problem probably had been discussed before or will be answered. After log on, you may select your preferred language under "Multi-language".
<http://club.aopen.com.tw/forum>

Contact Us: Please prepare detail system configuration and error symptom before contacting us. The part number, serial number and BIOS version are also very helpful.

Contact Distributors/Resellers: We sell our products through resellers and integrators. They should know your system configuration very well and should be able to solve your problem efficiently and provide important reference for you.