

HS-6252

**VIA C3 800MHz Embedded CPU
Industrial Single Board Computer**

- Half Size • All-in-One • CRT • 133MHz FSB •
- ATA/33/66/100 • Dual LAN • Audio •
- RS-232/422/485 • 4COM • PC/104 •
- IrDA • USB • DOC • WDT • H/W Monitor •
- PCI-ISA Bus Industrial Single Board computer •

Copyright Disclaimers

The accuracy of contents in this manual has passed thorough checking and review before publishing. BOSER Technology Co., Ltd., the manufacturer and publisher, is not liable for any infringements of patents or other rights resulting from its use. The manufacturer will not be responsible for any direct, indirect, special, incidental or consequential damages arising from the use of this product or documentation, even if advised of the possibility of such damage(s).

This manual is copyrighted and BOSER Technology Co., Ltd. reserves all documentation rights. Unauthorized reproduction, transmission, translation, and storage of any form and means (i.e., electronic, mechanical, photocopying, recording) of this document, in whole or partly, is prohibited, unless granted permission by BOSER Technology Co., Ltd.

BOSER Technology Co., Ltd. reserves the right to change or improve the contents of this document without due notice. BOSER Technology Co., Ltd. assumes no responsibility for any errors or omissions that may appear in this manual, nor does it make any commitment to update the information contained herein.

Trademarks

BOSER is a registered trademark of BOSER Technology Co., Ltd.

ISB is a registered trademark of BOSER Technology Co., Ltd.

Intel is a registered trademark of Intel Corporation.

AMI is a registered trademark of AMI Software, Inc.

All other trademarks, products and or product names mentioned herein are mentioned for identification purposes only, and may be trademarks and/or registered trademarks of their respective companies or owners.



**© Copyright 2002 BOSER Technology Co., Ltd.
All Rights Reserved.
Edition 1.3, December 27, 2002**

Table of Contents

Chapter 1	General Description	1
1.1	Major Features	2
1.2	Specifications	3
1.3	Board Dimensions	4
Chapter 2	Unpacking	5
2.1	Opening the Delivery Package	5
2.2	Inspection	5
Chapter 3	Hardware Installation	7
3.1	Before Installation	7
3.2	Board Layout	8
3.3	Jumper List	9
3.4	Connector List	9
3.5	Configuring the CPU	10
3.6	System Memory	10
3.7	DiskOnChip™ Address Setting	10
3.8	VGA Controller	12
3.9	PCI E-IDE Drive Connector	13
3.10	Floppy Disk Drive Connector	14
3.11	Serial Port Connectors	15
3.12	Parallel Connector	16
3.13	Ethernet Connector	16
3.14	IrDA Connector	17
3.15	USB Connector	17
3.16	CMOS Data Clear	17
3.17	Power, ATX Power Controller and Fan Connectors	18
3.18	Keyboard Connectors	22
3.19	PS/2 Mouse Connector	23
3.20	System Front Panel Connectors	24
3.21	Thermal Input Connector	24
3.22	Watchdog Timer	25
3.23	PC/104 Connectors	27
3.24	Audio Connectors	29

Chapter 4	AMI BIOS Setup	31
4.1	Starting Setup	31
4.2	Using Setup	32
4.3	Main Menu	33
4.4	Standard CMOS Setup	35
4.5	Advanced CMOS Setup	38
4.6	Advanced Chipset Setup	41
4.7	Power Management Setup	42
4.8	PCI / Plug and Play Setup	44
4.9	Peripheral Setup	45
4.10	Hardware Monitor Setup	47
4.11	Auto-Detect Hard Disks	48
4.12	Change Supervisor/User Password	49
4.13	Auto Configuration with Optimal Settings	50
4.14	Auto Configuration with Fail Safe Settings	51
4.15	Save Settings and Exit	52
4.16	Exit Without Saving	53
Chapter 5	Software Utilities	55
5.1	IDE and Audio Driver Installation	55
5.2	LAN Driver Installation for WIN95 & WIN98	68
5.3	LAN Driver Installation for WIN NT4.0	74

Safety Instructions

Integrated circuits on computer boards are sensitive to static electricity. To avoid damaging chips from electrostatic discharge, observe the following precautions:

- Do not remove boards or integrated circuits from their anti-static packaging until you are ready to install them.
- Before handling a board or integrated circuit, touch an unpainted portion of the system unit chassis for a few seconds. This helps to discharge any static electricity on your body.
- Wear a wrist-grounding strap, available from most electronic component stores, when handling boards and components. Fasten the ALLIGATOR clip of the strap to the end of the shielded wire lead from a grounded object. Please wear and connect the strap before handle the HS-6252 to ensure harmlessly discharge any static electricity through the strap.
- Please use an anti-static pad when putting down any components or parts or tools outside the computer. You may also use an anti-static bag instead of the pad. Please inquire from your local supplier for additional assistance in finding the necessary anti-static gadgets.

NOTE: *DO NOT TOUCH THE BOARD OR ANY OTHER SENSITIVE COMPONENTS WITHOUT ALL NECESSARY ANTI-STATIC PROTECTION*

This page intentionally left blank.

Chapter 1

General Description

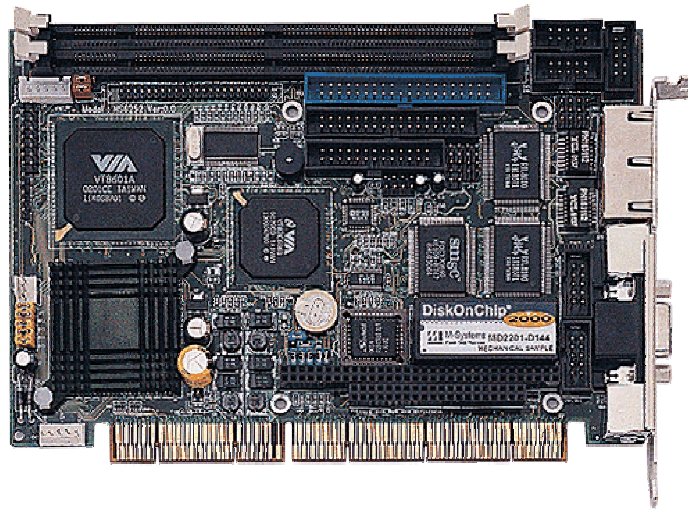

The HS-6252 is a 133MHz FSB VIA VT8601 chipset-based board designed for PCI-ISA Bus with VIA C3 800MHz Embedded CPU. These features combine and make the HS-6252 an ideal all-in-one industrial single board computer. Additional features include an enhanced I/O with CRT, Dual LAN, and 4 COM ports interface.

Its onboard ATA/33/66/100 to IDE drive interface architecture allows the HS-6252 to support data transfers of 33, 66 or 100MB/sec. to each IDE drive connection. Designed with the VIA VT8601 core logic chipset, the board supports VIA C3 800MHz Embedded CPU. The VIA VT8601 integrated Trident 3D supporting AGP Bus.

For suitable installation into any size system with 8/16/32-bit ISA and/or PCI slots operation, the board's advanced PCI-ISA bus add-on feature allows user to easily obtain both ISA's 16-bit and PCI's 32-bit full set signals from a half-size PCI-ISA slot. System memory is also sufficient with the two DIMM sockets that can support up to 1GB.

Additional onboard connectors include an advanced USB and IrDA ports providing faster data transmission, a DOS-compatible DiskOnChip™ socket with a maximum capacity of 288MB, and two external RJ-45 connectors for 10/100 Based Ethernet use.

To ensure the reliability in an unmanned or standalone system, the Watchdog Timer (WDT) onboard HS-6252 is designed with pure hardware that does not need the arithmetical functions of a real-time clock chip. If any program causes unexpected halts to the system, the onboard Watchdog Timer (WDT) will automatically reset the CPU or generate an interrupt to resolve such condition.

1.1 Major Features

The HS-6252 comes with the following features:

- VIA C3 800MHz Embedded CPU
- VIA VT8601/VT82C686B system chipset
- Supports 66/100/133MHz FSB
- Two DIMM sockets with a max. capacity of 1GB
- SMC 37C669, VIA VT82C686B super I/O chipset
- Fast PCI ATA/33/66/100 IDE controller
- Three RS-232 and one RS-232/422/485 serial ports
- PC/104 Bus connector
- VIA VT8601 CRT display controller
- Dual RealTek RTL8100 10/100 Based LAN
- AC97 3D audio controller
- DiskOnChip™ socket supporting memory sizes of up to 288MB
- Supports four USB connectors
- Supports Hardware Monitor function
- Supports Single +5V power in

1.2 Specifications

- **CPU:** VIA C3 800MHz embedded CPU
- **Bus Interface:** PCI-ISA Bus
- **Memory:** Two DIMM sockets supporting up to 1GB
- **Chipset:** VIA VT8601/VT82C686B
- **I/O Chipset:** SMC 37C669, VIA VT82C686B
- **VGA:** VIA VT8601 integrated Trident 3D supporting AGP Bus
- **IDE:** Two IDE disk drives supporting ATA/33/66/100 and with transfer rates up to 33/66/100MB/sec.
- **FDD:** Supports up to two floppy disk drives
- **Parallel:** One enhanced bi-directional parallel port supporting SPP/ECP/EPP
- **LAN:** Dual RealTek RTL8100 10/100 Based LAN
- **Audio:** AC97 3D audio controller supporting speaker out
- **Serial Port:** 16C550 UART-compatible RS-232/422/485 x 1 and RS-232 x 3 serial ports with 16-byte FIFO
- **PC/104:** PC/104 connector for 16-bit ISA Bus
- **IrDA:** One IrDA TX/RX header
- **USB:** Four USB connectors
- **Keyboard:** PS/2 6-pin Mini DIN or 5-pin connector
- **Mouse:** PS/2 6-pin Mini DIN or 4-pin connector
- **DiskOnChip™:** DiskOnChip™ socket supporting memory sizes of up to 288MB
- **BIOS:** AMI PnP Flash BIOS
- **Watchdog Timer:** Sets 1, 2, 10, 20, 110, 220 seconds, activity trigger with Reset or NMI
- **CMOS:** Battery backup
- **DMA Channels:** 7
- **Interrupt Levels:** 15
- **Operating Temperature:** 0~60°C
- **Hardware Monitor:** VIA VT82C686B
- **Board Size:** 18.5 x 12.2 cm

1.3 Board Dimensions

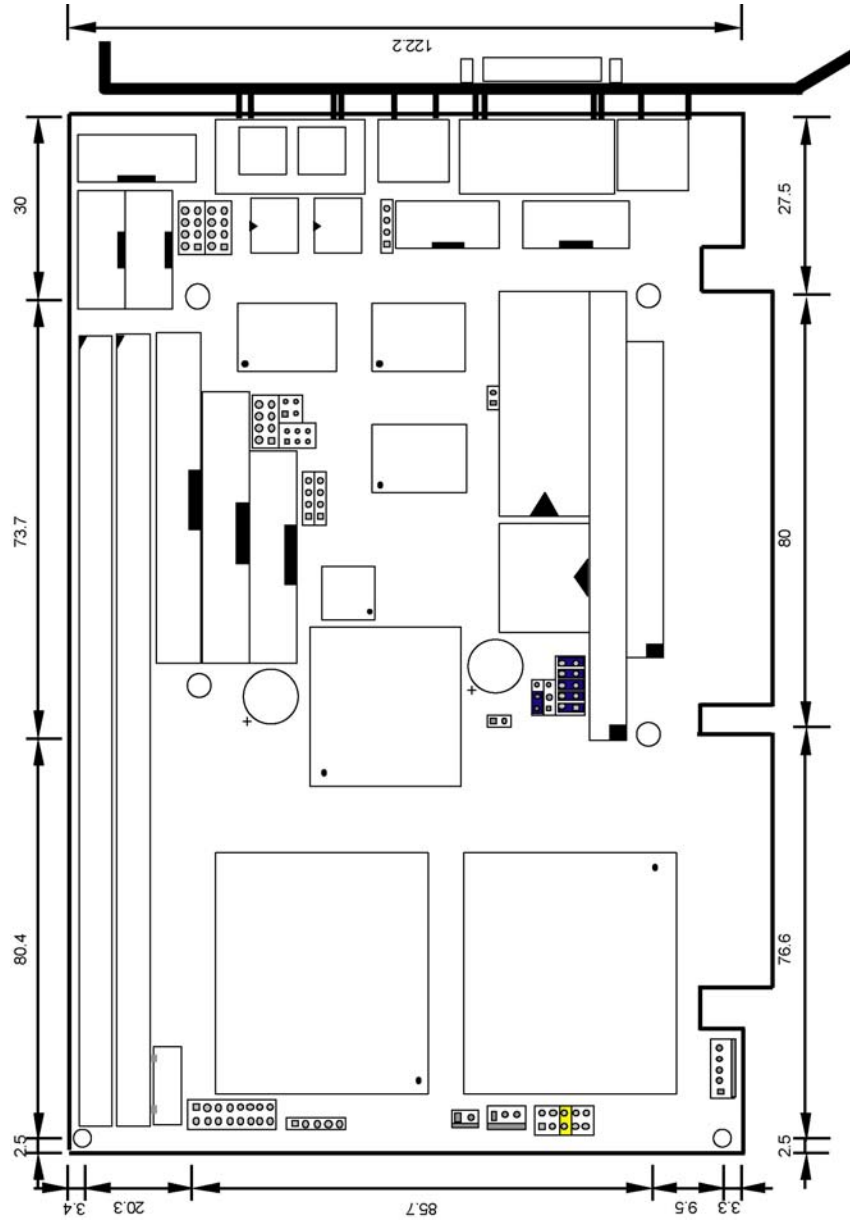

Chapter 2

Unpacking

2.1 Opening the Delivery Package

The HS-6252 is packed in an anti-static bag. The board has components that are easily damaged by static electricity. Do not remove the anti-static wrapping until proper precautions have been taken. Safety Instructions in front of this manual describe anti-static precautions and procedures.

2.2 Inspection

After unpacking the board, place it on a raised surface and carefully inspect the board for any damage that might have occurred during shipment. Ground the board and exercise extreme care to prevent damage to the board from static electricity.

Integrated circuits will sometimes come out of their sockets during shipment. Examine all integrated circuits, particularly the BIOS, processor, memory modules, ROM-Disk, and keyboard controller chip to ensure that they are firmly seated. The HS-6252 delivery package contains the following items:

- HS-6252 Board x 1
- Utility CD Disk x 1
- ATA/100 IDE flat cable x 1
- FDD flat cable x 1
- Printer cable with bracket x 1
- RS-232 COM Port cables with bracket x 2
- 8-pin USB split type cable with bracket x 1
- MIC In/Speaker In 8-pin cable + 2 phone jacks with bracket x 1
- 5-pin ATX power cable x 1
- Jumper Bag x 1
- User's Manual

IMPORTANT: *Before you turn on the power of your system, please set JP5 to Short 1-2 for normal operation.*

It is recommended that you keep all the parts of the delivery package intact and store them in a safe/dry place for any unforeseen event requiring the return shipment of the product. In case you discover any missing and/or damaged items from the list of items, please contact your dealer immediately.

Chapter 3

Hardware Installation

This chapter provides the information on how to install the hardware using the HS-6252. This chapter also contains information related to jumper settings of switch, watchdog timer, and the DiskOnChip™ address selection etc.

3.1 Before Installation

After confirming your package contents, you are now ready to install your hardware. The following are important reminders and steps to take before you begin with your installation process.

1. Make sure that all jumper settings match their default settings and CMOS setup correctly. Refer to the sections on this chapter for the default settings of each jumper.
2. Go through the connections of all external devices and make sure that they are installed properly and configured correctly within the CMOS setup. Refer to the sections on this chapter for the detailed information on the connectors.
3. Keep the manual and diskette in good condition for future reference and use.

3.2 Board Layout

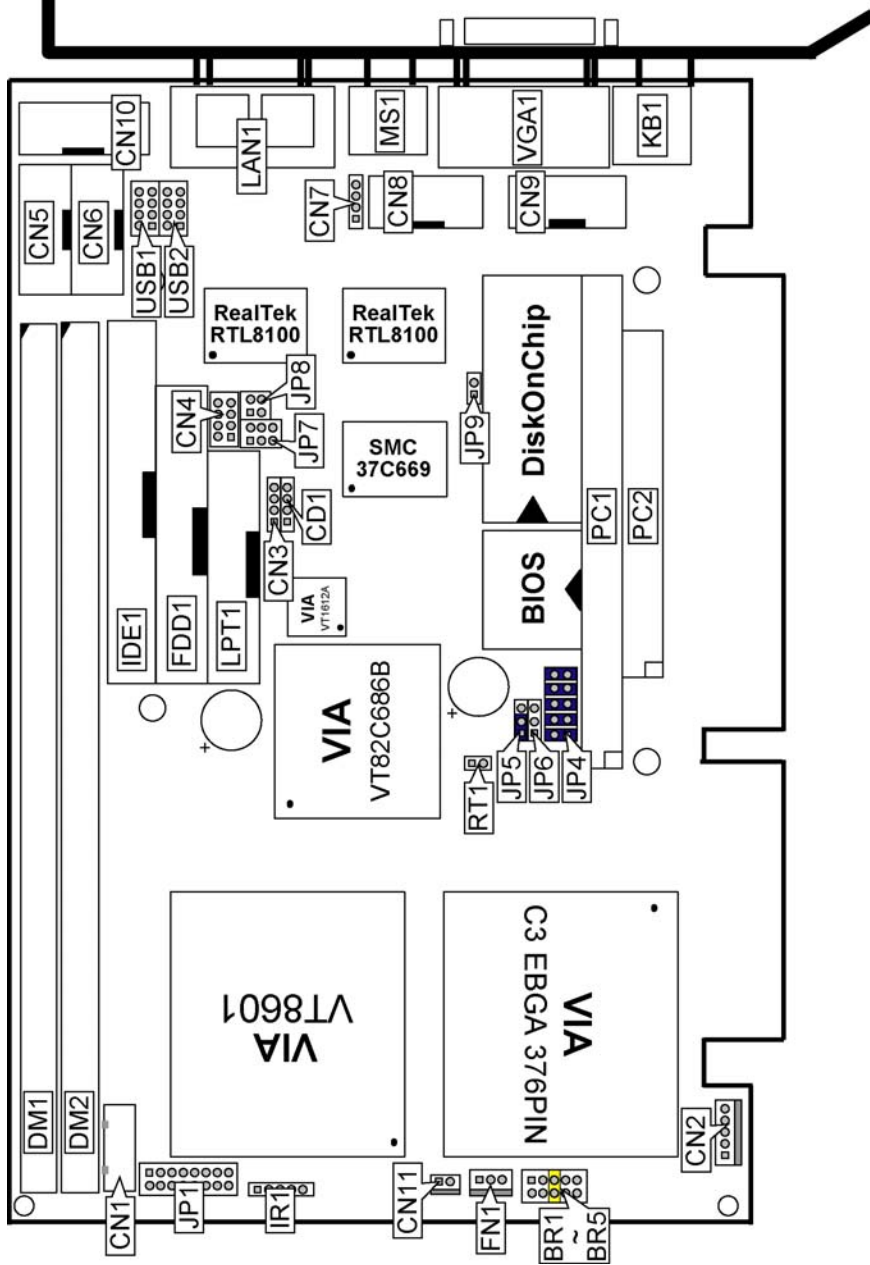

3.3 Jumper List

Jumper	Default Setting	Setting
BR3	CPU Clock Frequency: <i>800MHz</i>	Short
JP4(1-4)	DOC Address Select: <i>D000</i>	Short 1-2
JP4(5-10)	WDT Timer Select: <i>1sec.</i>	Short 5-6, 7-8, 9-10
JP5	Clear CMOS: <i>Normal Operation</i>	Short 1-2
JP6	WDT Active Type Setting: <i>Reset</i>	Short 2-3
JP7	RS-422/485 Transceiver Enabled/Disabled Select: <i>Disabled</i>	Open 1-2, 3-4, 5-6
JP8	RS-422/485 Receiver Enabled/Disabled Select: <i>Disabled</i>	Open 1-2, 3-4
JP9	COM2 Use RS-232 or RS-422/485: <i>Disabled</i>	Open

3.4 Connector List

Connector	Definition
CD1	CD-ROM Line In Connector
CN1	5-pin Keyboard Connector
CN2	5-pin ATX Power In Connector
CN3	Line In Connector
CN4	Audio Out/MIC In Connector
CN5	COM 3 Connector
CN6	COM 4 Connector
CN7	4-pin Mouse Connector
CN8	COM 2 Connector
CN9	COM 1 Connector
CN10	RS-422/485 Connector
CN11	2-pin Power In Connector
DM1 & 2	168-pin DIMM Sockets
FDD1	Floppy Connector
FN1	Fan Connector
IDE1	IDE Connector
IR1	IrDA Connector
JP1	Front Panel Connector
KB1	6-pin Mini DIN Keyboard Connector
LAN1A & 1B	Dual RJ-45 Connector
LPT1	Parallel Connector
MS1	6-pin Mini DIM Mouse Connector
PC1 & PC2	PC/104 64-pin/40-pin Connector
RT1	Thermal Input Connector
USB1 & 2	USB Connectors
VGA1	VGA Connector

3.5 Configuring the CPU

The HS-6252 is embedded with a VIA C3 800MHz CPU. User doesn't need to adjust the frequency and check the speed of the VIA C3 800MHz CPU.

3.6 System Memory

The HS-6252 provides two DIMM sockets at locations *DM1* and *DM2*. The maximum capacity of the onboard memory is 1GB.

3.7 DiskOnChip™ Address Setting

The DiskOnChip™ function allows the system to boot or operate without a FDD or a HDD. DiskOnChip™ modules may be formatted as drive C or A. With DiskOnChip™, user may also execute DOS commands such as FORMAT, SYS, COPY, XCOPY, DISCOPY and DISKCOMP etc.

The U6 location on the HS-6252 is the DiskOnChip™ module socket. Jumper *JP4(1-4)* assigns the starting memory address of the installed module. If you have another memory device that has a similar memory capacity with that of the DOC in your system, please set both at different memory address mappings to avoid the mapping area conflicts. Failing to do so will not make the HS-6252 and the additional memory device function properly.

● JP4(1-4): DiskOnChip™ Address Select

Address	PINS 1-2	PINS 3-4
* D000	Short	Short
D800	Open	Short

3.7.1 Installing DiskOnChip™ Modules

When installing a DiskOnChip™ module onto your board, please take note of the following:

1. Orient yourself properly with the location of the DiskOnChip™ socket. Try to locate the pin 1 location on your socket. Pin numbers are usually printed on either the component side or the solder side of your board.
2. Locate the Pin 1 location on your DiskOnChip™ module. More often than not, Pin 1 can be found on the lower right corner of the chip. Please refer to the diagram for the exact location.

3. Once you have figured out where the pin 1 locations are on both chip and socket, align the module's pins on an upright angle against the socket. Using both thumbs, gently press the module into the socket until all the pins are secured to their designations.

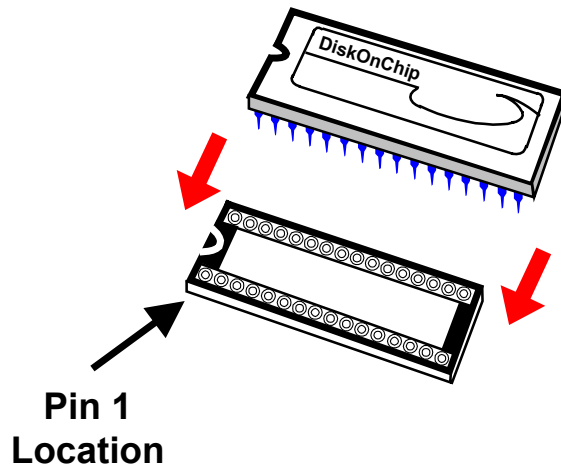

4. The installation is now complete and your module is now ready for use.

NOTE: *If you encounter difficulty installing your DiskOnChip™ module, please consult a qualified technician or engineer to perform the installation.*

3.7.2 Removing DiskOnChip™ Modules

When removing a DiskOnChip™ module from its socket, please take note of the following:

1. Loosen the contact of the module from its socket using a screwdriver.
2. Insert the screwdriver's flat head into a gap on either end of the socket. Do not insert the screwdriver head on either side where the pins are located. Doing so might damage the pins in the process.
3. Slowly lift the screwdriver handle upwards. This will disengage the module from its socket.

NOTE: *If you encounter difficulty removing your DiskOnChip™ module, please consult a qualified technician or engineer to remove it for you.*

3.8 VGA Controller

The HS-6252 has an onboard VGA controller, provides 8MB shared memory. The HS-6252 provides one connection method of a VGA device. VGA1 offers a single standard CRT connector (DB15).

- **VGA1: 15-pin CRT Connector (DB15)**

PIN	Description	PIN	Description
1	Red	2	Green
3	Blue	4	N/C
5	GND	6	GND
7	GND	8	GND
9	N/C	10	GND
11	N/C	12	SDA
13	HSYNC	14	VSYNC
15	SCL		

3.9 PCI E-IDE Drive Connector

IDE1 is a standard 40-pin connector daisy-chain driver connector serves the PCI E-IDE drive provisions onboard the HS-6252. A maximum of two ATA/33/66/100 IDE drives can connect to the HS-6252 via *IDE1*.

- **IDE1: IDE Connector**

PIN	Description	PIN	Description
1	RESET	2	GND
3	DATA 7	4	DATA 8
5	DATA 6	6	DATA 9
7	DATA 5	8	DATA 10
9	DATA 4	10	DATA 11
11	DATA 3	12	DATA 12
13	DATA 2	14	DATA 13
15	DATA 1	16	DATA 14
17	DATA 0	18	DATA 15
19	GND	20	N/C
21	PDREQ	22	GND
23	IOW#	24	GND
25	IOR#	26	GND
27	PIORDY	28	PR1PD1-
29	RPDACK-	30	GND
31	INTERRUPT	32	N/C
33	RPDA1-	34	PATA66
35	RPDA0-	36	RPDA2-
37	RPCS1-	38	RPCS3-
39	HDD ACTIVE	40	GND

3.10 Floppy Disk Drive Connector

The HS-6252 uses a standard 34-pin header connector, *FDD1*, for floppy disk drive connection. A total of two FDD drives may be connected to *FDD1* at any given time.

- **FDD1: FDD Connector**

PIN	Description	PIN	Description
1	GND	2	DRVDEN0
3	GND	4	N/C
5	GND	6	DRVDEN1
7	GND	8	INDEX#
9	GND	10	MTR0#
11	GND	12	DS1#
13	GND	14	DS0#
15	GND	16	MTR1#
17	GND	18	DIR#
19	GND	20	STEP#
21	GND	22	WDATA#
23	GND	24	WGATE#
25	GND	26	TRAK00#
27	GND	28	WRTPRT#
29	GND	30	RDATA#
31	GND	32	HDSEL#
33	GND	34	DSKCHG#

3.11 Serial Port Connectors

The HS-6252 offers two NS16C550 compatible UARTs with Read/Receive 16-byte FIFO serial ports and two internal 10-pin headers.

- **CN9, CN8, CN5 and CN6: COM1/COM2/COM3/COM4 Connectors (5x2 Header)**

PIN	Description	PIN	Description
1	DCD	2	DSR
3	RXD	4	RTX
5	TXD	6	CTX
7	DTR	8	RI
9	GND	10	N/C

- **CN10: RS-422/485 Connector (5x2 Header)**

PIN	Description	PIN	Description
1	TX-	2	TX+
3	RX+	4	RX-
5	GND	6	RTS-
7	RTS+	8	CTS+
9	CTS-	10	N/C

- **JP7: RS-422/485 Transceiver Enabled/Disabled Select**

Options	Settings
Always Enable	Short 1-2
Enable by “-RTS” signal	Short 3-4
Enable by writing the REG:2 EFH BIT0=1	Short 5-6
* Always Disabled	OPEN

- **JP8: RS-422/485 Receiver Enabled/Disabled Select**

Options	Settings
Always Enable	Short 1-2
Enable by “-RTS” signal	Short 3-4
* Always Disabled	OPEN

- **JP9: COM2 use RS-232 or RS-422/485 Selection**

Serial Port Setting	JP9
* RS-232	OPEN
RS-422/485	SHORT

3.12 Parallel Connector

LPT1 is a standard 26-pin flat cable connector deigned to accommodate parallel port connection onboard the HS-6252.

- **LPT1: Parallel Connector**

PIN	Description	PIN	Description
1	Strobe	2	DATA 0
3	DATA 1	4	DATA 2
5	DATA 3	6	DATA 4
7	DATA 5	8	DATA 6
9	DATA 7	10	Acknowledge
11	Busy	12	Paper Empty
13	Printer Select	14	Auto Form Feed
15	ERROR#	16	Initialize
17	Printer Select LN#	18	GND
19	GND	20	GND
21	GND	22	GND
23	GND	24	GND
25	GND	26	GND

3.13 Ethernet Connector

The HS-6252 provides one external dual RJ-45 10/100 Based LAN interface connector. Please refer to the following for its pin information.

- **LAN1A & 1B: Dual RJ-45 Connector**

PIN	Description
1	TX+
2	TX-
3	RX+
4	N/C
5	N/C
6	RX-
7	No Use
8	No Use
9	GND

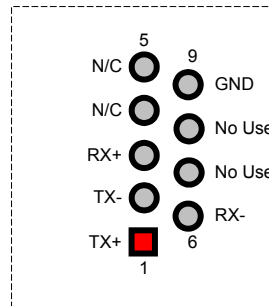

3.14 IrDA Connector

IR1 is a 5-pin internal IR communication connector for connection of an IrDA device.

- **IR1: IrDA Connector**

PIN	Description
1	VCC
2	N/C
3	IRRX
4	GND
5	IRTX

3.15 USB Connector

The HS-6252 provides two 8-pin connectors, at locations USB1 and USB2, for four USB connections to the HS-6252.

- **USB1 and USB2: USB Connector**

PIN	Description	PIN	Description
1	VCC	2	VCC
3	BD0- / BD2-	4	BD1- / BD3-
5	BD0+ / BD2+	6	BD1+ / BD3+
7	GND	8	GND

3.16 CMOS Data Clear

The HS-6252 has a Clear CMOS jumper on JP5.

- **JP5: Clear CMOS**

Options	Settings
* Normal Operation	Short 1-2
Clear CMOS	Short 2-3

IMPORTANT: Before you turn on the power of your system, please set JP5 to Short 1-2 for normal operation.

3.17 Power Supply, ATX Power Controller and Fan Connectors

HS-6252 provides one 5-pin power control connector at CN2. If you need to use ATX power supply, power supply connections to both CN2 and CN11 are must.

- **CN2: 5-pin Power Connector**

PIN	Description	PIN	Description
1	GND	2	PS_ON
3	+12V	4	5VSB
5	VCC		

Connector FN1 onboard HS-6252 is a 3-pin fan power output connector.

- **FN1: CPU Fan Connector**

PIN	Description
1	GND
2	+5V
3	Speed

HS-6252 provides one 5-pin power control connector at CN2 to support ATX function.

- **CN11: 2-pin +5V Power In Connector**

PIN	Description
1	VCC
2	GND

Also, it supports various power connections. Please refer the following:

Cable1 →

Power Switch cable supplied by chassis vendor (not attached in cable package)



Cable2 →

5-pin ATX power cable (attached in cable package)



• • • More On Next Page • • •

Cable3 →
ATX power supply transfer cable for use
ATX function without Backplane (not
attached in cable package)



Cable4 →
2-pin 5V power in cable (not attached in
cable package)



3.17.1 HS-6252 Connect with ATX Power Supply and BOSER Backplane (ATX function)

1. HS-6252 CN2 connects to 5-pin connector (Backplane). ATX power supply connect to backplane ATX connector.

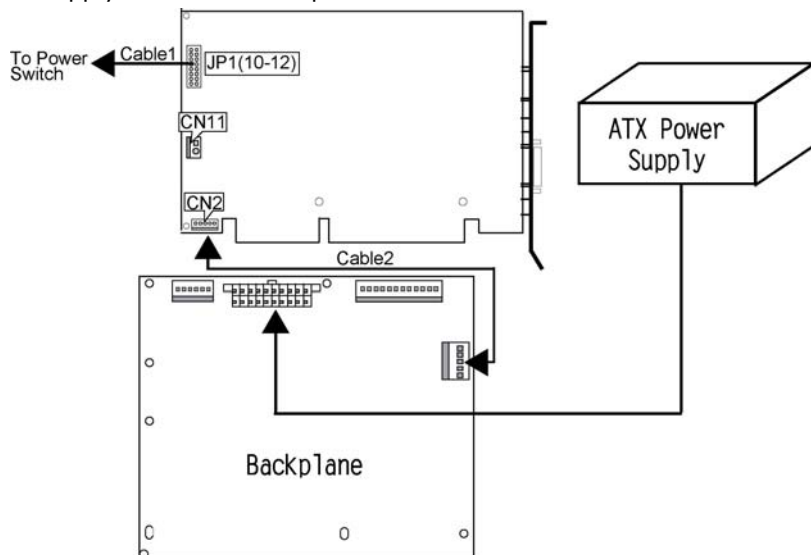

2. Power switch cable (cable1) connects to JP1(10-12).

3.17.2 HS-6252 Connect with ATX Power Supply and BOSER Backplane (AT power function)

1. 20-pin ATX power connector (Backplane) connects to ATX power supply.
2. Use Cable1 connect to pin-4 and pin-5 of 5-pin connector on BOSER's backplane.

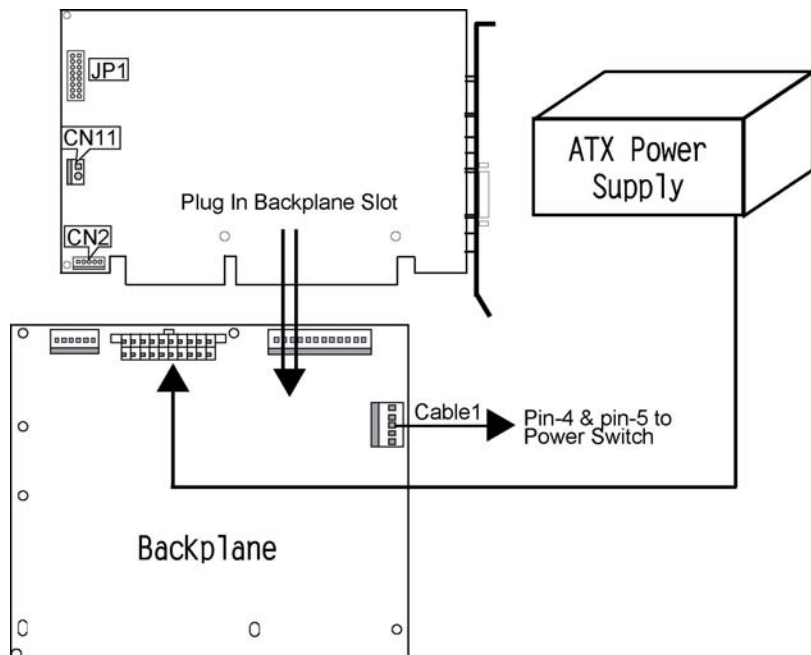

3.17.3 HS-6252 Connect with ATX Power Supply (Without Backplane)

1. Use Cable3 connect CN2 & CN11 with ATX power supply.
2. Cable1 connect to JP1(10-12).

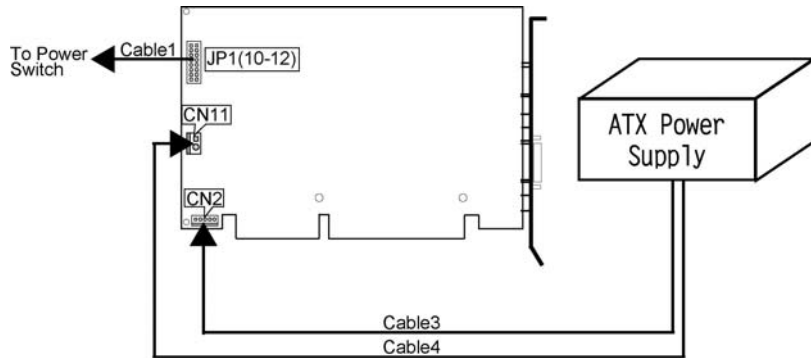

3.17.4 HS-6252 Connect with AT Power Supply and BOSER Backplane

1. Connects P8/P9 connector to AT power supply.

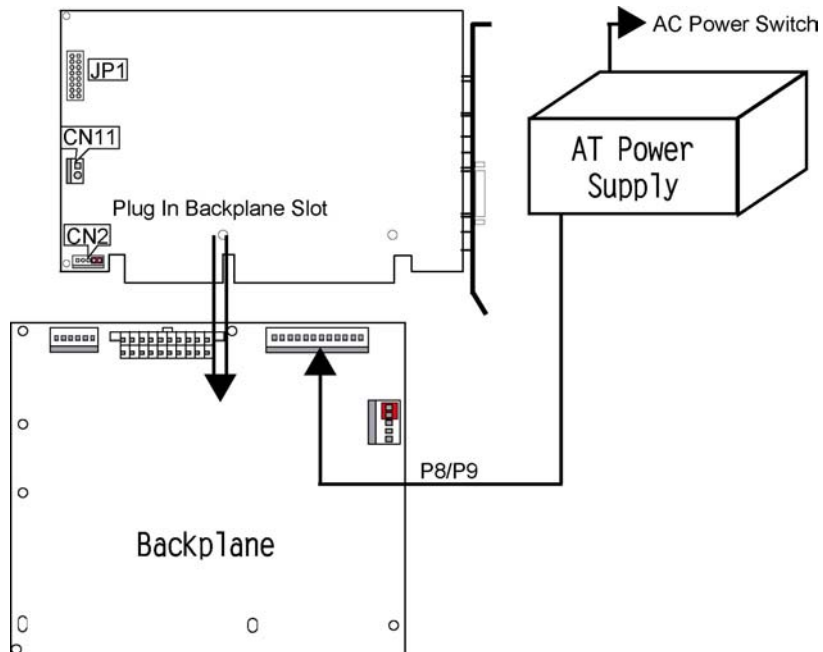

3.17.5 HS-6252 Connect with AT Power Supply

1. Connects CN11 to AT power supply. (Through cable4)

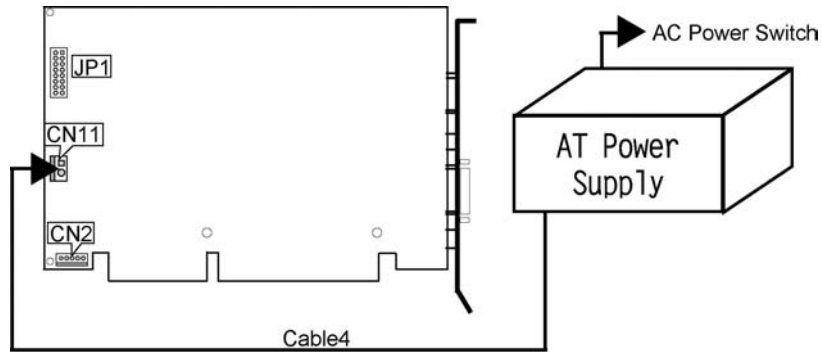

3.18 Keyboard Connectors

The HS-6252 offers two possibilities for keyboard connections. The connections are via *KB1* for an external PS/2 type keyboard or via *CN1* for an internal 5-pin cable converter to an AT keyboard.

- **CN1: 5-pin Keyboard Connector**

PIN	Description
1	Keyboard Clock
2	Keyboard Data
3	N/C
4	GND
5	+5V

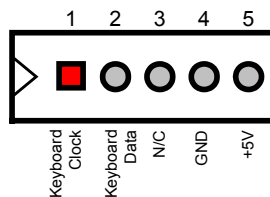

- **KB1: PS/2 6-pin Mini DIN Keyboard Connector**

PIN	Description
1	Keyboard Data
2	N/C
3	GND
4	+5V
5	Keyboard Clock
6	N/C

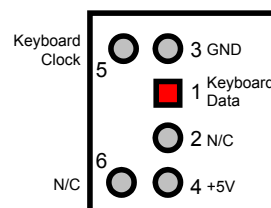

3.19 PS/2 Mouse Connector

MS1 is a 6-pin mini DIN connector for connections to an external PS/2 mouse connector. CN7 is an internal 4-pin header for cable converter to PS/2 mouse.

- **MS1: PS/2 6-pin Mini Din Mouse Connector**

PIN	Description
1	Mouse Data
2	N/C
3	GND
4	+5V
5	Mouse Clock
6	N/C

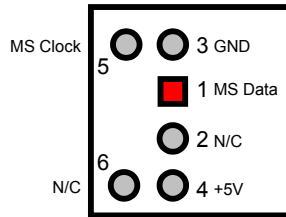

- **CN7: 4-pin Mouse Connector**

PIN	Description
1	Keyboard Clock
2	Keyboard Data
3	VCC
4	GND

3.20 System Front Panel Connectors

The HS-6252 has one LED at location *JP1*(2-4) that indicates the power-on status. This visual feature of the IDE LED may also be connected to an external IDE LED via connector *JP1*(13-15).

- **JP1: System Front Panel Connector**

PIN	Description	PIN	Description
1	VCC	2	330Ω Pull +5V
3	GND	4	GND
5	N/C	6	EXT SMI
7	Speaker	8	GND
9	GND	10	Power Button
11	Reset Switch	12	GND
13	330Ω Pull +5V	14	Sleep Button
15	HDD LED	16	GND

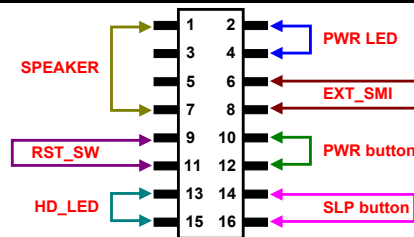

3.21 Thermal Input Connector

In relevance to the Hardware Monitoring feature provided by the onboard VIA VT82C686B, the board allows the installation of a thermal sensor via connector *RT1*. The thermal connector monitors and displays the current system temperature from the Chipset Features Setup screen on your BIOS utility program. The value displayed is read-only figures and may not be altered.

- **RT1: Thermal Input Connector**

PIN	Description
1	Sensor In
2	GND

3.22 Watchdog Timer

There are three access cycles of Watch-Dog Timer as Enable, Refresh and Disable are the three access cycles of Watchdog Timer. The Enable cycle proceeds via READ PORT 443H whereas the Disable cycle proceeds via READ PORT 045H. A continued Enable cycle after a first Enable cycle means Refresh.

Once the Enable cycle is active, a Refresh cycle is requested before the time-out period. This restarts counting of the WDT period. When the time counting goes over the period preset of WDT, it will assume that the program operation is abnormal. A System Reset signal to re-start or a NMI cycle to the CPU transpires when such error happens. Jumper *JP6* is used to select the function of Watchdog Timer.

- **JP6: Watchdog Timer Active Type Setting**

Options	Settings
Active NMI	Short 1-2
System Reset	Short 2-3
* Disabled Watchdog Timer	Open

- **JP4(5-10): WDT Timeout Period Select**

Period	PINS 5-6	PINS 7-8	PINS 9-10
* 1 sec	Short	Short	Short
2 sec	Open	Short	Short
10 sec	Short	Open	Short
20 sec	Open	Open	Short
110 sec	Short	Short	Open
220 sec	Open	Short	Open

The Watchdog Timer is disabled after the system Power-On. It can be enabled via an Enable cycle and reading the control port (443H), or via a Refresh cycle and reading the control port (443H), or via a Disable cycle and reading the disable control port (045H).

After an Enable cycle of WDT, user must immediately execute a Refresh cycle to WDT before its period setting comes to an end every 1, 2, 10, 20, 110 or 220 seconds. If the Refresh cycle does not activate before WDT period cycle, the onboard WDT architecture will issue a Reset or NMI cycle to the system. There are three I/O ports that control the Watchdog Timer.

443H	I/O Read	The Enable cycle
443H	I/O Read	The Refresh cycle
045H	I/O Read	The Disable cycle

The following sample program shows how to Enable, Disable and Refresh the Watchdog Timer:

```

WDT_EN_RF    EQU    0433H
WDT_DIS      EQU    0045H

WT_Enable    PUSH    AX                ; keep AX DX
              PUSH    DX
              MOV     DX,WDT_EN_RF    ; enable the WDT
              IN     AL,DX
              POP     DX                ; get back AX, DX
              POP     AX
              RET

WT_Refresh   PUSH    AX                ; keep AX, DX
              PUSH    DX
              MOV     DX,WDT_ET_RF    ; refresh the WDT
              IN     AL,DX
              POP     DX                ; get back AX, DX
              POP     AX
              RET

WT_DISABLE   PUSH    AX
              PUSH    DX
              MOV     DX,WDT_DIS      ; disable the WDT
              IN     AL,DX
              POP     DX                ; get back AX, DX
              POP     AX
              RET

```

3.23 PC/104 Connectors

The PC/104 expansion bus offers provisions to connect all types of PC/104 modules. With the PC/104 bus being known as the new generation of industrial embedded 16-bit PC standard bus, thousands of PC/104 modules from multiple vendors can be easily installed onboard. The detailed pin assignment of the PC/104 expansion bus connectors *PC1* and *PC2* are listed on the following tables:

NOTE : *The PC/104 connector allows direct plugging or stack-through piling of PC/104 modules without requiring the PC/104 mounting kit.*

● PC2: 40-pin PC/104 Expansion Slot

PIN	Description	PIN	Description
1	GND	21	GND
2	MEMCS16*	22	SBHE*
3	IOSC16*	23	LA23
4	IRQ10	24	LA22
5	IRQ11	25	LA21
6	IRQ12	26	LA20
7	IRQ15	27	LA19
8	IRQ14	28	LA18
9	DACK0*	29	LA17
10	DRQ0	30	MEMR*
11	DACK5*	31	MEMW*
12	DRQ5	32	SD8
13	DACK6*	33	SD9
14	DRQ6	34	SD10
15	DACK7*	35	SD11
16	DRQ7	36	SD12
17	+5V	37	SD13
18	MASTER*	38	SD14
19	GND	39	SD15
20	GND	40	N/C

Connector diagram rotated 90 degrees clockwise from original position

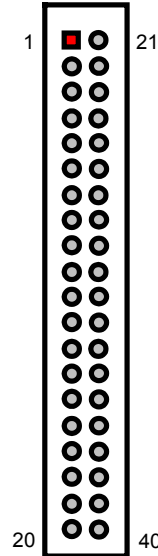

● **PC1: 64-pin PC/104 Expansion Slot**

PIN	Description	PIN	Description
1	IOCHECK*	33	GND
2	SD7	34	RESETDRV
3	SD6	35	+5V
4	SD5	36	IRQ9
5	SD4	37	-5V
6	SD3	38	DRQ2
7	SD2	39	-12V
8	SD1	40	NOW*
9	SD0	41	+12V
10	IOCHRDY	42	GND
11	AEN	43	SMEMW*
12	SA19	44	SMEMR*
13	SA18	45	IOW*
14	SA17	46	IOR*
15	SA16	47	DACK3*
16	SA15	48	DRQ3
17	SA14	49	DACK1*
18	SA13	50	DRQ1
19	SA12	51	REFRESH*
20	SA11	52	SYSCLK
21	SA10	53	IRQ7
22	SA9	54	IRQ6
23	SA8	55	IRQ5
24	SA7	56	IRQ4
25	SA6	57	IRQ3
26	SA5	58	DACK2*
27	SA4	59	TC
28	SA3	60	BALE
29	SA2	61	+5V
30	SA1	62	OSC
31	SA0	63	N/C
32	GND	64	GND

Connector diagram rotated 90 degrees clockwise from original position

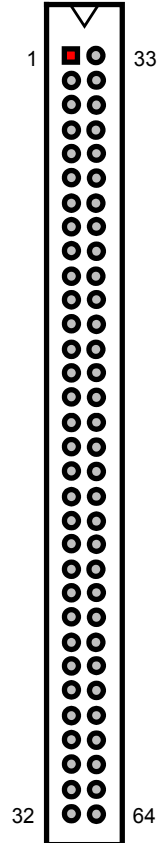

3.24 Audio Connectors

The HS-6252 has an onboard AC97 3D audio interface. The following tables list the pin assignments of the CD-ROM Analog Input, the Line In and the MIC In / Line Out connectors.

- **CD1: CD-ROM Line In Connector**

PIN	Description
1	CDL
2	GND
3	GND
4	CDR

- **CN3: Line In Connector**

PIN	Description
1	LINE_R
2	GND
3	GND
4	LINE_L

- **CN4: MIC In / Line Out Connector**

PIN	Description	PIN	Description
1	AOUTL	2	AOUTR
3	GND	4	GND
5	MIC IN	6	N/C
7	GND	8	GND

This page intentionally left blank.

Chapter 4

AMI BIOS Setup

The HS-6252 uses AMI BIOS for the system configuration. The AMI BIOS setup program is designed to provide the maximum flexibility in configuring the system by offering various options that could be selected for end-user requirements. This chapter is written to assist you in the proper usage of these features.

4.1 Starting Setup

The AMI BIOS is immediately activated when you first power on the computer. The BIOS reads the system information contained in the CMOS and begins the process of checking out the system and configuring it. When it finishes, the BIOS will seek an operating system on one of the disks and then launch and turn control over to the operating system.

While the BIOS is in control, the Setup program can be activated in one of two ways:

1. By pressing immediately after switching the system on, or
2. By pressing the key when the following message appears briefly at the bottom of the screen during the POST (Power On Self Test).

Press DEL to enter SETUP.

If the message disappears before you respond and you still wish to enter Setup, restart the system to try again by turning it OFF then ON or pressing the "RESET" button on the system case. You may also restart by simultaneously pressing <Ctrl>, <Alt>, and <Delete> keys. If you do not press the keys at the correct time and the system does not boot, an error message will be displayed and you will again be asked to...

PRESS F1 TO CONTINUE, DEL TO ENTER SETUP

4.2 Using Setup

In general, you use the arrow keys to highlight items, press <Enter> to select, use the <PageUp> and <PageDown> keys to change entries, press <F1> for help and press <Esc> to quit. The following table provides more detail about how to navigate in the Setup program using the keyboard.

Up arrow	Move to previous item
Down arrow	Move to next item
Left arrow	Move to the item in the left hand
Right arrow	Move to the item in the right hand
Esc key	Main Menu -- Quit and not save changes into CMOS Status Page Setup Menu and Option Page Setup Menu -- Exit current page and return to Main Menu
PgUp key	Increase the numeric value or make changes
PgDn key	Decrease the numeric value or make changes
+ key	Increase the numeric value or make changes
- key	Decrease the numeric value or make changes
F1 key	General help, only for Status Page Setup Menu and Option Page Setup Menu
(Shift)F2 key	Change color from total 16 colors. F2 to select color forward, (Shift) F2 to select color backward
F3 key	Calendar, only for Status Page Setup Menu
F4 key	Reserved
F5 key	Restore the previous CMOS value from CMOS, only for Option Page Setup Menu
F6 key	Load the default CMOS value from BIOS default table, only for Option Page Setup Menu
F7 key	Load the default
F8 key	Reserved
F9 key	Reserved
F10 key	Save all the CMOS changes, only for Main Menu

4.2.1 Getting Help

Press F1 to pop up a small help window that describes the appropriate keys to use and the possible selections for the highlighted item. To exit the Help Window press <Esc> or the F1 key again.

4.3 Main Menu

Once you enter the AMI BIOS CMOS Setup Utility, the Main Menu will appear on the screen. The Main Menu allows you to select from several setup functions and two exit choices. Use the arrow keys to select among the items and press <Enter> to enter the sub-menu.

AMIBIOS HIFLEX SETUP UTILITY – VERSION 1.54 (C)2001 American Megatrends, Inc. All Rights Reserved
Standard CMOS Setup Advanced CMOS Setup Advanced Chipset Setup Power Management Setup PCI / Plug and Play Setup Peripheral Setup Hardware Monitor Setup Auto-Detect Hard Disks Change User Password Change Supervisor Password Auto Configuration with Optimal Settings Auto Configuration with Fail Safe Settings Save Settings and Exit Exit Without Saving
Standard CMOS setup for changing time, date, hard disk type, etc. ESC:Exit ↑↓:Sel F2/F3: Color F10: Save & Exit

NOTE: *A brief description of the highlighted choice appears at the bottom of the screen.*

- **Standard CMOS Setup**
This setup page includes all the items in a standard, AT-compatible BIOS.
- **Advanced CMOS Setup**
This setup page includes all the items of AMI special enhanced features.
- **Advanced Chipset Setup**
This setup page includes all the items of chipset special features.
- **Power Management Setup**
This entry only appears if your system supports Power Management, “Green PC”, standards.
- **PCI/Plug and Play Setup**
This entry appears if your system supports PNP/PCI.
- **Peripheral Setup**
This section page includes all the items of IDE hard drive and Programmed Input / Output features.

- **Hardware Monitor Setup**
This menu contains the system's auto-detect functions for CPU Vcore, CPU voltage, and CPU temperature.
- **Auto-Detect Hard Disks**
Automatically detect and configure hard disk parameters. The AMI BIOS includes this ability in the event you are uncertain of your hard disk's parameters.
- **Change User/Supervisor Password**
Change, set, or disable password. It allows you to limit access to the system and Setup, or just to Setup.
- **Auto Configuration with Optimal Settings**
The BIOS defaults have been set by the manufacturer and represent settings that provide the minimum requirements for your system to operate.
- **Auto Configuration with Fail Safe Settings**
The chipset defaults are settings that provide for maximum system performance. While AMI has designed the custom BIOS to maximize performance, the manufacturer has the right to change these defaults to meet their needs.
- **Save Settings and Exit**
Save CMOS value changes to CMOS and exit setup.
- **Exit Without Saving**
Abandon all CMOS value changes and exit setup.

4.4 Standard CMOS Setup

The Standard Setup is used for the basic hardware system configuration. The main function is for Data/Time and Floppy/Hard Disk Drive settings. Please refer to the following screen for the setup. When the IDE hard disk drive you are using is larger than 528MB, you must set the HDD mode to **LBA** mode. Please use the IDE Setup Utility in BIOS SETUP to install the HDD correctly.

AMIBIOS SETUP – STANDARD CMOS SETUP (C)2001 American Megatrends, Inc. All Rights Reserved									
Date (mm/dd/yyyy)	: Thu Jan 03, 2002				Base Memory : 0 KB				
Time (hh/mm/ss)	: 19:04:12				Extd Memory : 0 MB				
Floppy Drive A:	1.44MB, 3.5"								
Floppy Drive B:	Not Installed								
	Type	Size	Cyln	Head	WPcom	Sec	LBA Mode	Blk Mode	PIO 32Bit Mode
Pri Master	: Auto								
Pri Slave	: Auto								
Sec Master	: Auto								
Sec Slave	: Auto								
Boot Sector Virus Protection :	Disabled								
Month:	Jan - Dec				ESC:Exit ↑↓:Sel				
Day:	01 - 30				PgUp/PgDn: Modify				
Year:	1980 - 2099				F1:Help F2/F3:Color				

- Date:**
 The date format is <day>, <date> <month> <year>. Press <F3> to show the calendar.

day	The day, from Sun to Sat, determined by the BIOS and is display-only
date	The date, from 1 to 31 (or the maximum allowed in the month)
month	The month, Jan through Dec.
year	The year, from 1900 through 2099

- Time:**
 The time format is <hour> <minute> <second>. The time is calculated based on the 24-hour military-time clock. For example, 1 p.m. is 13:00:00.

- **Floppy A / B:**

The category identifies the types of floppy disk drive A or drive B that have been installed in the computer.

None	No floppy drive installed
360K, 5.25 in	5-1/4 inch PC-type standard drive; 360 kilobyte capacity
1.2M, 5.25 in	5-1/4 inch AT-type high-density drive; 1.2 megabyte capacity
720K, 3.5 in	3-1/2 inch double-sided drive; 720 kilobyte capacity
1.44M, 3.5 in	3-1/2 inch double-sided drive; 1.44 megabyte capacity
2.88M, 3.5 in	3-1/2 inch double-sided drive; 2.88 megabyte capacity

- **Pri Master/Slave & Sec Master/Slave:**

The categories identify the types of 4 channels that have been installed in the computer. There are 45 predefined types with 4 user-definable types for Enhanced IDE BIOS. Type 1 to Type 45 are predefined. Type user is user-definable.

Press PgUp or PgDn to select a numbered hard disk type or type the number and press <Enter>. Note that the specifications of your drive must match with the drive table. The hard disk will not work properly if you enter improper information for this category. If your hard disk drive type is not matched or listed, you can use Type "User" to define your own drive type manually.

If you select Type "User", you will need to know the information listed below. Enter the information directly from the keyboard and press <Enter>. This information should be included in the documentation from your hard disk vendor or the system manufacturer.

If the controller of HDD interface is ESDI, the selection shall be "Type 1".

If the controller of HDD interface is SCSI, the selection shall be "None".

If you select Type "Auto", BIOS will Auto-Detect the HDD & CD-ROM Drive at the POST stage and showing the IDE for HDD & CD-ROM Drive.

If a hard disk has not been installed select NONE and press <Enter>.

TYPE	drive type
CYLS.	number of cylinders
HEADS	number of heads
PRECOMP	write precompensation
SECTORS	number of sectors
MODE	mode type

- **Boot Sector Virus Protection:**

If set to Enabled, this category will flash on the screen when there is any attempt to write to the boot sector or partition table of the hard disk drive. The system will halt and an error message will appear. You may run anti-virus program to locate the problem.

Enabled	Activates automatically when the system boots up causing a warning message to appear when anything attempts to access the boot sector or hard disk partition table.
Disabled (default)	No warning message will appear when anything attempts to access the boot sector or hard disk partition table.

4.5 Advanced CMOS Setup

This section allows you to configure your system for the basic operation. You have the opportunity to select the system's default speed, boot-up sequence, keyboard operation, shadowing and security.

AMIBIOS SETUP – STANDARD CMOS SETUP (C)2001 American Megatrends, Inc. All Rights Reserved		
Quick Boot	Enabled	▲ Available Options: ▶ Disabled Enabled
1st Boot Device	Floppy	
2nd Boot Device	IDE-0	
3rd Boot Device	CD-ROM	
Try Other Boot Devices	Yes	
S.M.A.R.T. for Hard Disks	Disabled	
BootUp Num-Lock	On	
Floppy Drive Swap	Disabled	
Floppy Drive Seek	Disabled	
PS/2 Mouse Support	Enabled	
Primary Display	VGA/EGA	
Password Check	Setup	
Boot To OS/2	No	
Wait For 'F1' If Error	Enabled	
Hit 'DEL' Message Display	Enabled	
CPU MicroCode Updation	Enabled	
CPU Serial Number	Enabled	
L1 Cache	Enabled	
L2 Cache	Enabled	
System BIOS Cacheable	Enabled	
C000,32k Shadow	Cached	
C800,16k Shadow	Disabled	
CC00,16k Shadow	Disabled	
D000,16k Shadow	Disabled	
D400,16k Shadow	Disabled	
D800,16k Shadow	Disabled	
DC00,16k Shadow	Disabled	

ESC:Exit ↑↓:Sel
PgUp/PgDn: Modify
▼ F1:Help F2/F3:Color

- Quick Boot:**
 When set as enabled, the program disables the DRAM testing function. The available options are Enabled, and Disabled.
- 1st Boot Device:**
 This option sets the type of device from where the BIOS will FIRST seek to boot from after AMIBIOS POST completes. The available settings are Disabled, IDE-0, IDE-1, IDE-2, IDE-3, Floppy, ARMD-FDD, ARMD-HDD, CDROM, and SCSI.

- **2nd Boot Device:**
This option sets the type of SECOND device from where the BIOS will seek to boot from, if and when the 1st Boot Device fails after AMIBIOS POST completes. The available settings are Disabled, IDE-0, IDE-1, IDE-2, IDE-3, Floppy, ARMD-FDD, ARMD-HDD, CDROM, and SCSI.
- **3rd Boot Device:**
This option sets the type of THIRD device from where the BIOS will seek to boot from, if and when the 1st and 2nd Boot Devices fail after AMIBIOS POST completes. The available settings are Disabled, IDE-0, IDE-1, IDE-2, IDE-3, Floppy, ARMD-FDD, ARMD-HDD, CDROM, and SCSI.
- **Try Other Boot Devices:**
Set this option to Yes to instruct AMIBIOS to attempt to boot from any other drive in the system. This is useful if the BIOS cannot find a boot drive among the drives specified in the 1st /2nd/3rd/4th Boot Devices. The available settings are Yes, and No.
- **S.M.A.R.T. for Hard Disks:**
Self-Monitoring, Analysis and Reporting Technology. This option can help the BIOS in warning the user of possible device failure, giving user a chance to back up the device before actual failure happens. The available options are Enabled, and Disabled.
- **BootUp Num-Lock:**
When set as On, this option turns off numeric lock when the system is powered, allowing the end user to use the arrow keys on both the numeric keypad and the keyboard.
- **Floppy Drive Seek:**
Set this option to Enabled to specify that floppy drive A: will perform a Seek operation at system boot. The available options are Enabled, and Disabled.
- **PS/2 Mouse Support:**
When this option is enabled, BIOS allows the system to support a PS/2 type mouse. The available options are Enabled, and Disabled.
- **Primary Display:**
Select this option to configure the type of monitor attached to the computer. The available settings are Monochrome, Color 40x25, Color 80x25, VGA/PGA/EGA, and Absent.

- **Password Check:**
This option enables the password check option every time the system boots or the end user runs Setup. If set as Always, a user password prompt appears every time the computer is tuned on. If setup is chosen, the password prompt appears if BIOS is executed.
- **Wait For 'F1' If Error: Enabled/Disabled**
- **Hit 'DEL' Message Display: Enabled/Disabled**
- **CPU Micro Code Updation: Enabled/Disabled**
- **CPU Serial Number: Enabled/Disabled**
- **Boot To OS/2:**
Set this option to Enabled if running OS/2 operating system and using more than 64MB of system memory on the system board. The available options are Yes, and No.
- **L1 Cache:**
This option enables or disables the internal cache memory of the installed processor.
- **L2 Cache:**
This option enables/disables the secondary cache memory of your board. The available options are Enabled, and Disabled.
- **System BIOS Cacheable:**
When this option is enabled, the System ROM area from C000-DC00 is copied (shadowed) to RAM for faster execution.
- **C000,16k/C400,16k/C800,16k/ CC00,16k/D000,16k/D400,16k/D800,16k/ DC00,16k Shadow:**
These options enable shadowing of the contents of the ROM area named in the option title. The available settings are Enable Disable, Cached. The ROM area that is not used by ISA adapter cards will be allocated to PCI adapter cards.

Enabled	Video ROM area from C0000-C7FFF is copied (shadowed) from ROM to RAM for faster execution.
Disabled	The contents of the video ROM are not copied to RAM
Cached	The contents of the video ROM area from C0000h-C7FFFh are copied from ROM to RAM and can be written to or read from cache memory.

4.6 Advanced Chipset Setup

This section allows you to configure the system based on the specific features of the installed chipset. This chipset manages bus speeds and the access to the system memory resources, such as DRAM and the external cache. It also coordinates the communications between the conventional ISA and PCI buses. It must be stated that these items should never be altered. The default settings have been chosen because they provide the best operating conditions for your system. You might consider and make any changes only if you discover that the data has been lost while using your system.

AMIBIOS SETUP – ADVANCED CHIPSET SETUP (C)2001 American Megatrends, Inc. All Rights Reserved		
***** DRAM Timing *****		Available Options: ▶ Disabled Enabled
Configure SDRAM Timing by SPD	Disabled	
DRAM Frequency	133Mhz	
SDRAM CAS# Latency	3	
DRAM Bank Interleave	Enabled	
Memory Hole	Disabled	
AGP Mode	4x	
AGP Read Synchronization	Enabled	
AGP Fast Write	Disabled	
AGP Aperture Size	64MB	
AGP Master 1 W/S Write	Disabled	
AGP Master 1 W/S Read	Disabled	
Search for MDA Resources	Yes	
PCI Delay Transaction	Enabled	
ISA Bus Clock	PCI CLK/4	
USB Controller	All USB Port	
USB Device Legacy Support	Disabled	
Port 64/60 Emulation	Disabled	
		ESC:Exit ↑↓:Sel PgUp/PgDn: Modify F1:Help F2/F3:Color

4.7 Power Management Setup

The Power Management Setup allows user to configure the system for saving energy in a most effective way while operating in a manner consistent with his own style of computer use.

AMIBIOS SETUP – POWER MANAGEMENT SETUP (C)2001 American Megatrends, Inc. All Rights Reserved		
ACPI Aware O/S	No	▲ Available Options:
ACPI Standby State	Auto	▶ No
USB Device Wakeup From S3-S5	Disabled	Yes
Re-Call VGA BIOS at S3 Resuming	Enabled	
Power Management / APM	Enabled	
Video Power Down Mode	Suspend	
Hard Disk Power Down Mode	Standby	
Standby Time Out (Minute)	Disabled	
Suspend Time Out (Minute)	Disabled	
Throttle Slow Clock Ratio	50%~56.25%	
Display Activity	Ignore	
IRQ3	Monitor	
IRQ4	Monitor	
IRQ5	Ignore	
IRQ7	Monitor	
IRQ9	Ignore	
IRQ10	Ignore	
IRQ11	Ignore	
IRQ12	Ignore	
IRQ13	Ignore	
IRQ14	Monitor	
IRQ15	Ignore	
System Thermal	Disabled	
Thermal Active Temperature	65°C / 149°F	
Thermal Slow Clock Ratio	50%~56.25%	
Power Button Function	On / Off	
Restore on AC / Power Loss	Last State	
AT/ATX MODE	AT	
Resume On Ring	Disabled	
Resume On LAN	Disabled	
Resume On PME#	Disabled	
Resume On KBC	Disabled	
Wake-Up Key	N/A	
Wake-Up Password	N/A	
Resume On PS/2 Mouse	Disabled	
Resume On RTC Alarm	Disabled	
RTC Alarm Date	15	
RTC Alarm Hour	12	ESC:Exit ↑↓:Sel
RTC Alarm Minute	30	PgUp/PgDn: Modify
RTC Alarm Second	30	▼ F1:Help F2/F3:Color

- **ACPI Aware O/S:**
This item is the Advanced Configuration and Power Interface (ACPI) function switch. The available options are Yes, and No.
- **ACPI Standby State:**
This item serves as the switch setting of STR (S3) or POS (S1) function. Configuration options are S3/STR, and S1/POS.
- **Power Management/APM:**
Set this option to Enabled to switch on the APM (Advanced Power Management). The available options are Enabled, and Disabled.
- **Standby Time Out:**
This option specifies the length of system inactivity period while in the Standby state. When this length of time expires, the computer enters Suspend power state.
- **Restore on AC/Power Loss:**
This field registers the last power supply unit attached to your system. If an ATX power was last used before changing to AT power supply, setting this field to Last State (default) will NOT make the AT power supply function properly on your next boot up process. Setting this field to Power On auto-detects the power supply installed each time you boot up.
- **Wake Up On Ring:**
An input signal on the serial Ring Indicator (RI) line (in other words, an incoming call on the modem) awakens the system from a soft off state. The available choices are Enabled, Disabled.
- **Wake Up On Lan**
An input signal on the local area network (LAN) awakens the system from a soft off state.
- **Wake Up On PME**
A PME# detected resumes or wakes the system from a Soft Off state.
- **Resume By Alarm**
When this option is set enabled, system will according to you set time then wakeup from soft off mode.
- **Alarm Date/Hour/Minute/Second**
You can set these fields to specify the alarm settings of your system.

4.8 PCI / Plug and Play Setup

This section describes configuring the PCI bus system. PCI, or Personal Computer Interconnect, is a system that allows I/O devices to operate at speeds nearing the speed the CPU itself uses when communicating with its own special components. This section covers some very technical items and it is strongly recommended that only experienced users should make any changes to the default settings.

AMIBIOS SETUP – PCI / PLUG AND PLAY SETUP (C)2001 American Megatrends, Inc. All Rights Reserved		
Plug and Play Aware O/S	No	Available Options:
Clear NVRAM	No	▶ No
OnChip VGA Frame Buffer Size	8MB	
PCI Latency Timer (PCI Clocks)	32	Yes
Primary Graphics Adapter	PCI	
PCI Slot1 IRQ Priority	Auto	
PCI Slot2 IRQ Priority	Auto	
PCI Slot3 IRQ Priority	Auto	
PCI Slot4 IRQ Priority	Auto	
DMA Channel 0	PnP	
DMA Channel 1	PnP	
DMA Channel 3	PnP	
DMA Channel 5	PnP	
DMA Channel 6	PnP	
DMA Channel 7	PnP	
IRQ3	PCI/PnP	
IRQ4	PCI/PnP	
IRQ5	PCI/PnP	
IRQ7	PCI/PnP	
IRQ9	PCI/PnP	
IRQ10	PCI/PnP	
IRQ11	PCI/PnP	ESC:Exit ↑↓:Sel
IRQ14	PCI/PnP	PgUp/PgDn: Modify
IRQ15	PCI/PnP	F1:Help F2/F3:Color

- Plug and Play Aware O/S:**
 If enabled, BIOS will configure only PnP ISA boot devices (i.e., all PnP ISA cards with boot flag set) then configure all other devices. If disabled, the BIOS will configure all devices without following any sequence.
- PCI Latency Timer (PCI Clocks):**
 This option specifies the latency timings (in PCI clocks) of PCI devices installed in the PCI expansion slots. The available settings are 32, 64, 96, 128, 160, 192, 224, and 248.

4.9 Peripheral Setup

The IDE hard drive controllers can support up to two separate hard drives. These drives have a master/slave relationship that is determined by the cabling configuration used to attach them to the controller. Your system supports two IDE controllers--a primary and a secondary--so you can install up to four separate hard disks.

PIO means Programmed Input/Output. Rather than having the BIOS issue a series of commands to affect the transfer to or from the disk drive, PIO allows the BIOS to tell the controller what it wants and then let the controller and the CPU perform the complete task by them. This is much simpler and more efficient (also faster).

AMIBIOS SETUP – PERIPHERAL SETUP (C)2001 American Megatrends, Inc. All Rights Reserved		
OnBoard FDC	Auto	Available Options:
OnBoard Serial Port 1	3F8/COM1	▶ Disabled
OnBoard Serial Port 2	2F8/COM2	Primary
Serial Port2 Mode	Normal	Secondary
Duplex Mode	N/A	Both
OnBoard Serial Port 3	3E8	
Serial Port3 IRQ	10	
OnBoard Serial Port 4	2E8	
Serial Port4 Mode	Normal	
Serial Port4 IRQ	11	
OnBoard Parallel Port	Auto	
Parallel Port Mode	Normal	
EPP Version	N/A	
Parallel Port DMA Channel	N/A	
Parallel Port IRQ	Auto	
OnBoard IDE	Both	
OnBoard AC'97 Audio	Enabled	
OnBoard Legacy Audio	Enabled	
Sound Blaster	Disabled	
SB I/O Base Address	200h-22Fh	ESC:Exit ↑↓:Sel
SB IRQ Select	5	PgUp/PgDn: Modify
SB DMA Select	1	F1:Help F2/F3:Color

- **OnBoard IDE/FDD:**
Set this option to Enabled to activate the floppy drive controller on the system board. The available settings are Auto (AMIBIOS automatically determines if the floppy controller should be enabled), Enabled, and Disabled.

- **OnBoard Parallel Port:**

This option specifies the base I/O port address of parallel port on the system board. The available settings are Disabled, 378h, 278h, and 3BCh.
- **Parallel Port Mode:**

This option specifies the parallel port mode. The available settings are Normal, Bi-Dir, EPP, and ECP.

Normal: The normal parallel port mode is used.

Bi-Dir: Use this setting to support bi-directional transfers on the parallel port.

EPP: The parallel port can be used with devices that adhere to the Enhanced Parallel Port (EPP) specification. EPP uses the existing parallel port signals to provide asymmetric bi-directional data transfer driven by the host device.

ECP: The parallel port can be used with devices that adhere to the Extended Capabilities Port (ECP) specification. ECP uses the DMA protocol to achieve data transfer rates up to 2.5 Megabits per second. ECP provides symmetric bi-directional communication.
- **Parallel Port IRQ:**

This option specifies the IRQ used by the parallel port. The available settings are Auto, (IRQ)5, and (IRQ)7.
- **Parallel Port DMA Channel:**

This option is only available if the setting for the Parallel Port Mode option is ECP. This option sets the DMA channel used by the parallel port. The available settings are DMA Channel 0, 1, and 3.

4.10 Hardware Monitor Setup

AMIBIOS SETUP – HARDWARE MONITOR SETUP (C)2001 American Megatrends, Inc. All Rights Reserved	
*** System Hardware Monitor ***	
Chassis Intrusion	Disabled
Available Options: ▶ Disabled Enabled Reset	
TSENS1 Temperature CPU Fan Speed Chassis Fan Speed Vcore + 2.500V +3.300V +5.000V +12.000V	
ESC:Exit ↑↓:Sel PgUp/PgDn: Modify F1:Help F2/F3:Color	

- **System Hardware Monitor:**
This field determines which component will detect the CPU temperature. If your board comes with a provision for a thermal connector, you may set this field as Thermistor. Otherwise, please configure it as CPU (also default setting).
- **TSENS1 Temperature:**
This read-only field displays the current CPU temperature as part of the hardware monitoring feature of your board.
- **Current CPU/FAN Speeds:**
These fields display the *current* speed of up to CPU, chassis (system) and Power supply fans, if your computer contains a monitoring system.
- **+5V/+12V/+3.3V/+2.5V:**
Once the hardware monitoring IC detects the current voltages of voltage regulators and power supply unit, it shows the values on these fields for read-only purposes.

4.11 Auto-Detect Hard Disks

This option detects the parameters of an IDE hard disk drive, and automatically enters them into the Standard CMOS Setup screen.

Up to four IDE drives can be detected, with parameters for each appearing in sequence inside a box. To accept the displayed entries, press the “Y” key; to skip to the next drive, press the “N” key. If you accept the values, the parameters will appear listed beside the drive letter on the screen.

AMIBIOS HIFLEX SETUP UTILITY – VERSION 1.54 (C)2001 American Megatrends, Inc. All Rights Reserved
Standard CMOS Setup Advanced CMOS Setup Advanced Chipset Setup Power Management Setup PCI / Plug and Play Setup Peripheral Setup Hardware Monitor Setup Auto-Detect Hard Disks Change User Password Change Supervisor Password Auto Configuration with Optimal Settings Auto Configuration with Fail Safe Settings Save Settings and Exit Exit Without Saving
Standard CMOS setup for changing time, date, hard disk type, etc. ESC:Exit ↑↓:Sel F2/F3: Color F10: Save & Exit

4.12 Change Supervisor/User Password

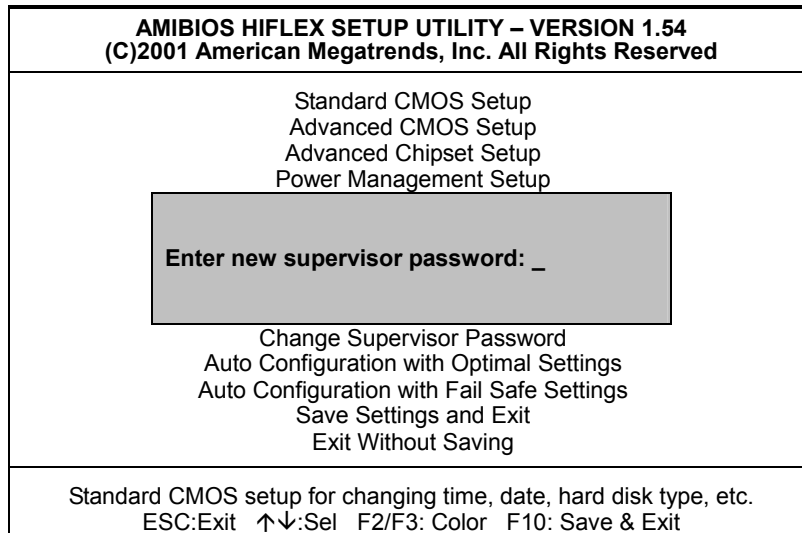

You can set either supervisor or user password, or both of them. The differences between are:

- **supervisor password:** can enter and change the options of the setup menus.
- **user password:** just can only enter but do not have the right to change the options of the setup menus.

When you select this function, the following message will appear at the center of the screen to assist you in creating a password.

ENTER PASSWORD:

Type the password, up to eight characters in length, and press <Enter>. The password typed now will clear any previously entered password from CMOS memory. You will be asked to confirm the password. Type the password again and press <Enter>. You may also press <Esc> to abort the selection and not enter a password.

To disable a password, just press <Enter> when you are prompted to enter the password. A message will confirm the password will be disabled. Once the password is disabled, the system will boot and you can enter Setup freely.

PASSWORD DISABLED.

When a password has been enabled, you will be prompted to enter it every time you try to enter Setup. This prevents an unauthorized person from changing any part of your system configuration.

Additionally, when a password is enabled, you can also require the BIOS to request a password every time your system is rebooted. This would prevent unauthorized use of your computer.

You determine when the password is required within the BIOS Features Setup Menu and its Security option (see Section 3). If the Security option is set to "System", the password will be required both at boot and at entry to Setup. If set to "Setup", prompting only occurs when trying to enter Setup.

4.13 Auto Configuration with Optimal Settings

When you press <Enter> on this item you will get a confirmation dialog box with a message shown below. This option allows you to load/restore the BIOS default values permanently stored in the BIOS ROM. Pressing 'Y' loads the BIOS default values for the most stable, minimal-performance system operations.

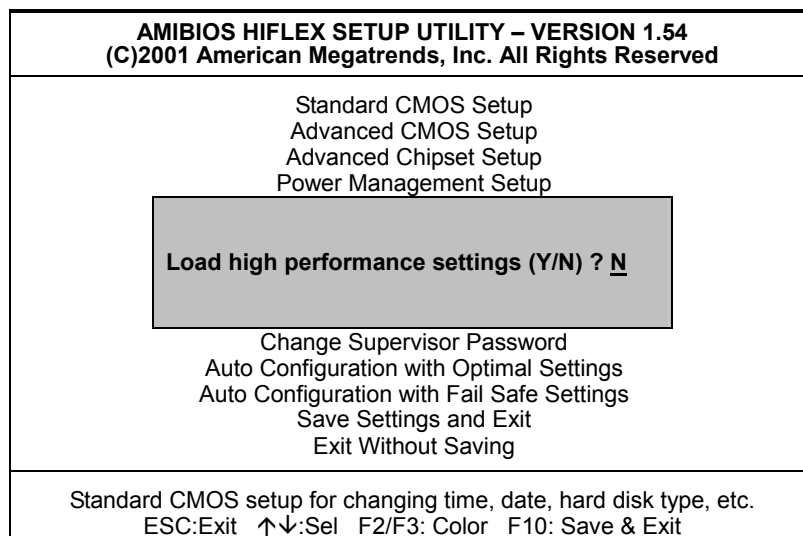

4.14 Auto Configuration with Fail Safe Settings

When you press <Enter> on this item you get a confirmation dialog box with a message similar to the figure below. This option allows you to load/restore the default values to your system configuration, optimizing and enabling all high performance features. Pressing 'Y' loads the default values that are factory settings for optimal performance system operations.

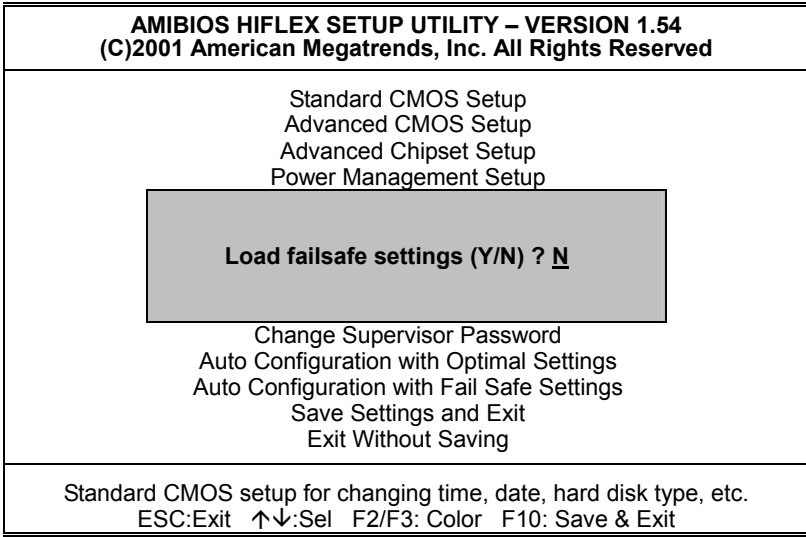

4.15 Save Settings and Exit

Pressing <Enter> on this item asks for confirmation:

AMIBIOS HIFLEX SETUP UTILITY – VERSION 1.54 (C)2001 American Megatrends, Inc. All Rights Reserved
Standard CMOS Setup Advanced CMOS Setup Advanced Chipset Setup Power Management Setup
Save current settings and exit (Y/N) ? <u>Y</u>
Change Supervisor Password Auto Configuration with Optimal Settings Auto Configuration with Fail Safe Settings Save Settings and Exit Exit Without Saving
Standard CMOS setup for changing time, date, hard disk type, etc. ESC:Exit ↑↓:Sel F2/F3: Color F10: Save & Exit

Pressing “Y” stores the selections made in the menus in CMOS – a special section of memory that stays on after you turn your system off. The next time you boot your computer, the BIOS configures your system according to the Setup selections stored in CMOS. After saving the values the system is restarted again.

4.16 Exit Without Saving

Pressing <Enter> on this item asks for confirmation:

Quit without saving (Y/N)? Y

This allows you to exit Setup without storing in CMOS any change. The previous selections remain in effect. This exits the Setup utility and restarts your computer.

<p>AMIBIOS HIFLEX SETUP UTILITY – VERSION 1.54 (C)2001 American Megatrends, Inc. All Rights Reserved</p>
<p>Standard CMOS Setup Advanced CMOS Setup Advanced Chipset Setup Power Management Setup</p> <p>Quit without saving (Y/N) ? <u>N</u></p> <p>Change Supervisor Password Auto Configuration with Optimal Settings Auto Configuration with Fail Safe Settings Save Settings and Exit Exit Without Saving</p>
<p>Standard CMOS setup for changing time, date, hard disk type, etc. ESC:Exit ↑↓:Sel F2/F3: Color F10: Save & Exit</p>
<p>Abandon all Data & Exit Setup</p>

This page intentionally left blank.

Chapter 5

Software Utilities

This chapter contains the detailed information of IDE, VGA, Audio and LAN driver installation procedures.

5.1 IDE and Audio Driver Installation

The utility disk that came with the delivery package contains an auto-run program that invokes the installation programs for the IDE, VGA and Audio drivers. The following describes the installation procedures of each driver.

5.1.1 VIA VT82C686B AGP Bus Driver Installation

1. Insert Utility CD Disk to your CD ROM. The main menu will pop up as shown below.

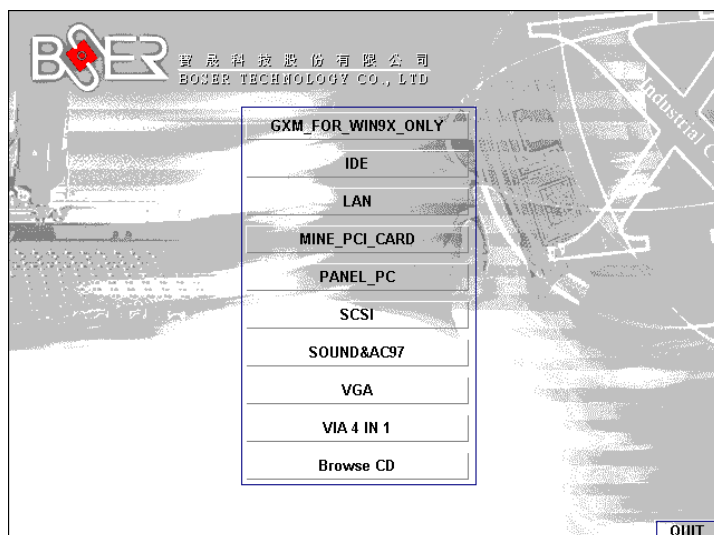

2. Press "VIA 4 IN 1" and to go Setup.
3. Once the Welcome screen appears on the screen, make sure to close any applications running and then click on the Next button.

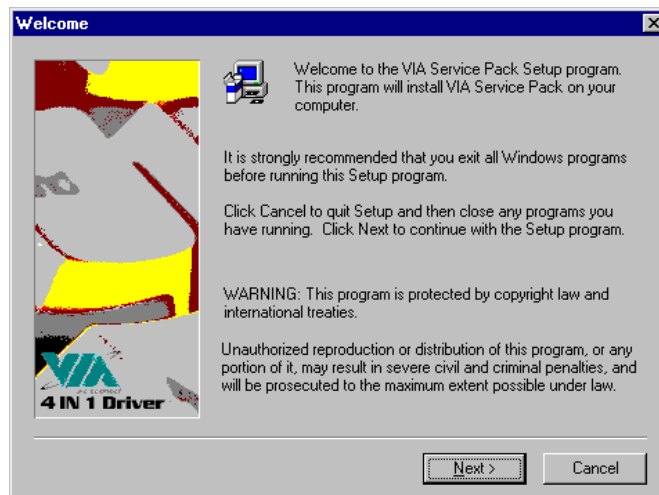

4. When the Readme window pops on the screen, you may read the whole document including the license agreement or just press Yes to skip through and continue installation.

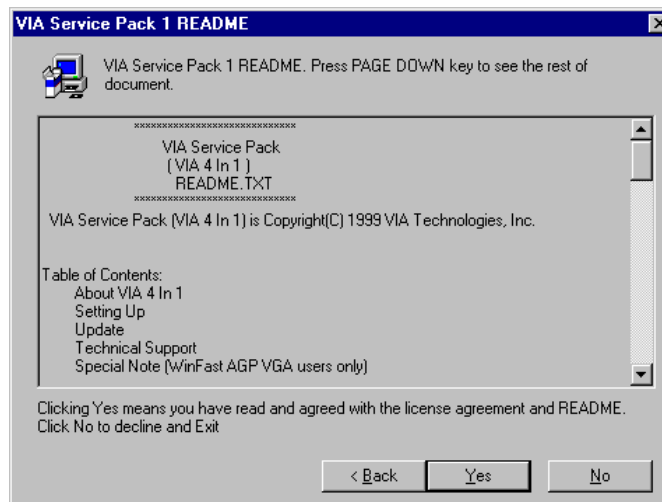

5. The 4 in 1 Setup dialog is now displayed. Select on Normally Install and then click on Next.

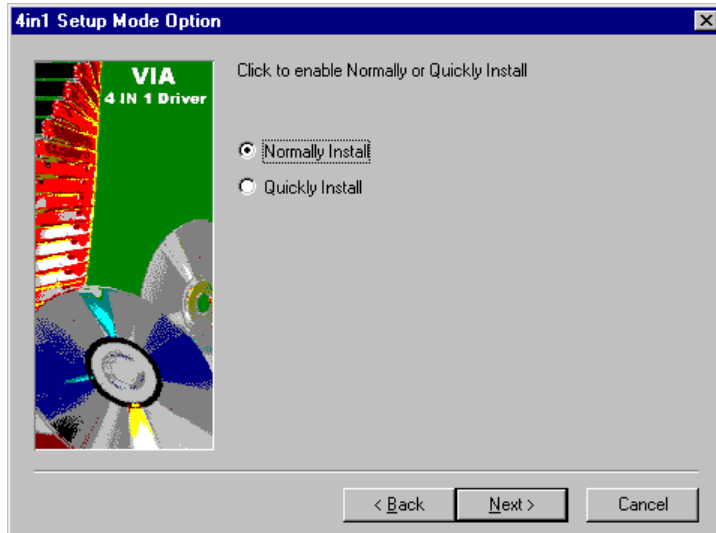

6. The next window lists all components detected in your system and asks you to select the ones requiring drivers. Tick on all items then proceed by clicking on the Next button below the screen.

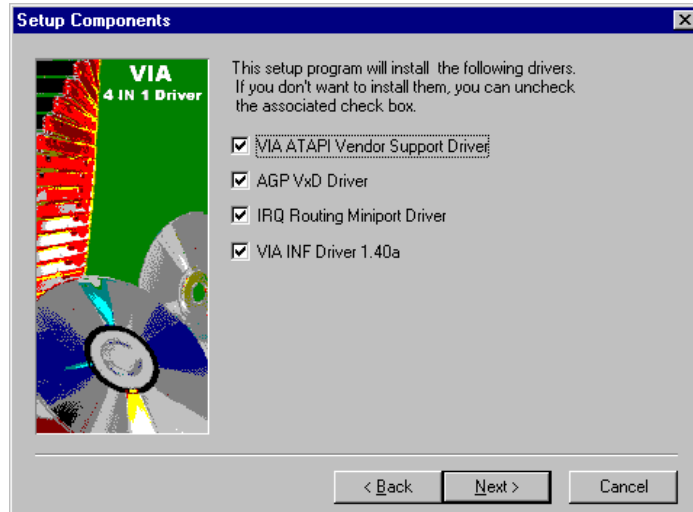

7. The program starts to install the ATAPI driver when you click the Next button on the screen below.

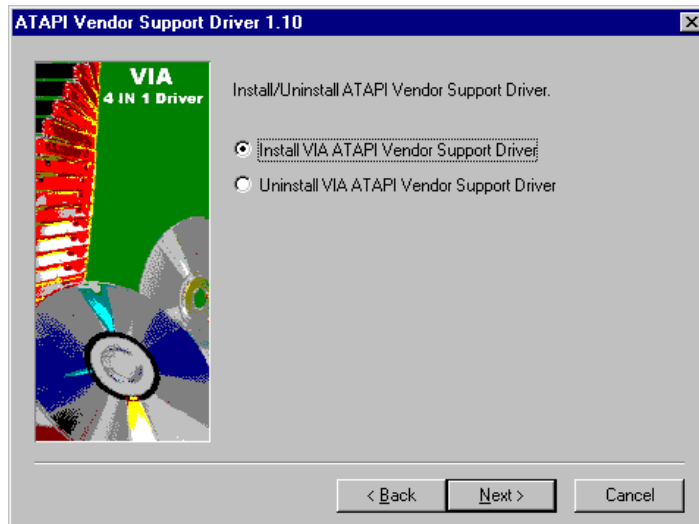

8. When the ATAPI driver is completely installed. The utility then displays your DMA mode status and allows you to enable it. Tick on the box and press on the Next button to continue.

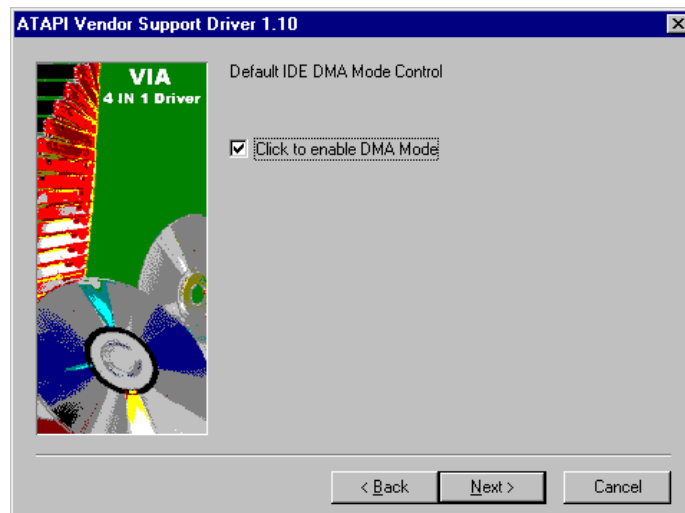

9. The following screen then gives you the choice of installing the AGP driver in standard or turbo mode. Select on the Standard Mode and then click on Next to proceed.

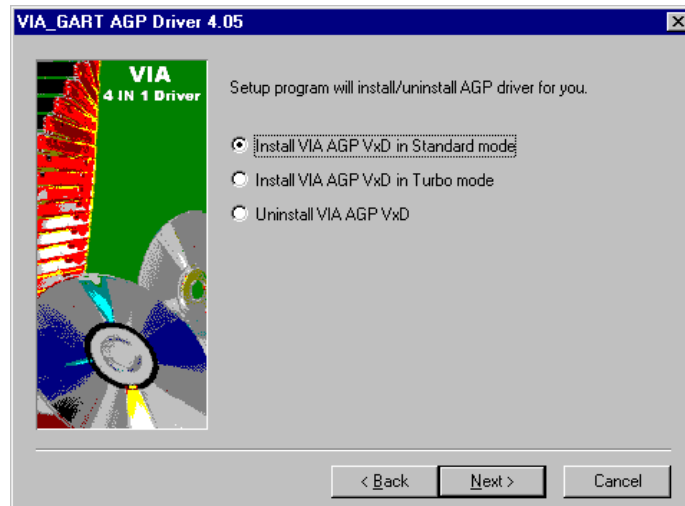

10. Installation of the AGP driver is now complete. Once the screen below appears, select on restarting your computer to activate all drivers/settings completed.

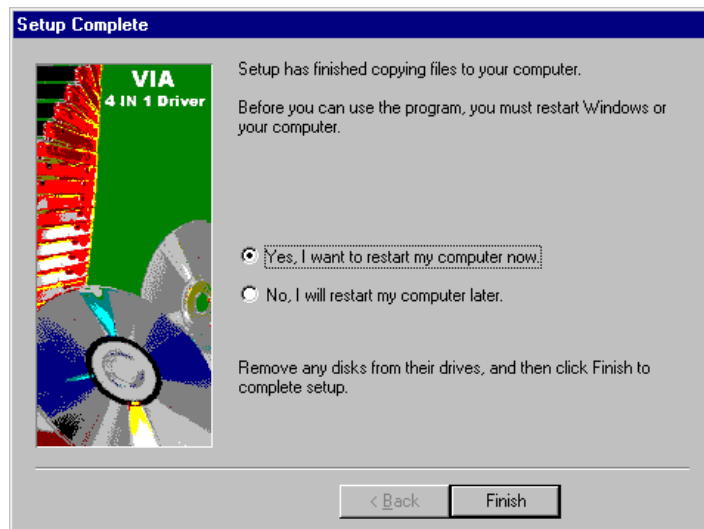

5.1.2 VIA IDE Tool Installation

1. With the Utility CD Disk still in your CD ROM drive, open the File Manager and then select the CD-ROM drive. As soon as the system reads the disk, the following screen will appear on your display. Click on VIA_IDE from the main menu to start installing the VIA ID Tool.



2. Once the Welcome screen appears on the screen, make sure to close applications that are running and then click the Next button.

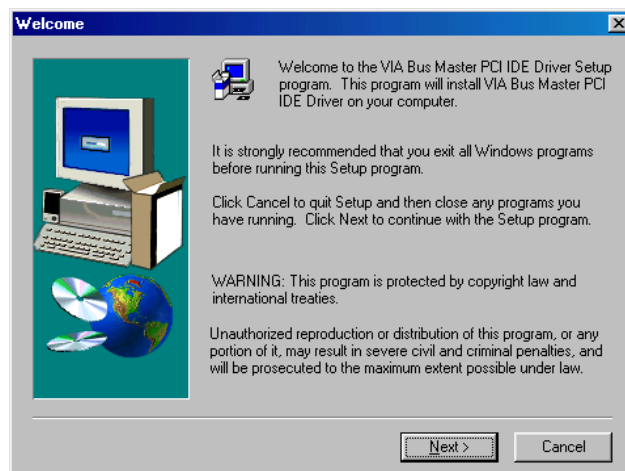

3. The Select Components dialog box is now displayed. Select on Install and then click on Next.

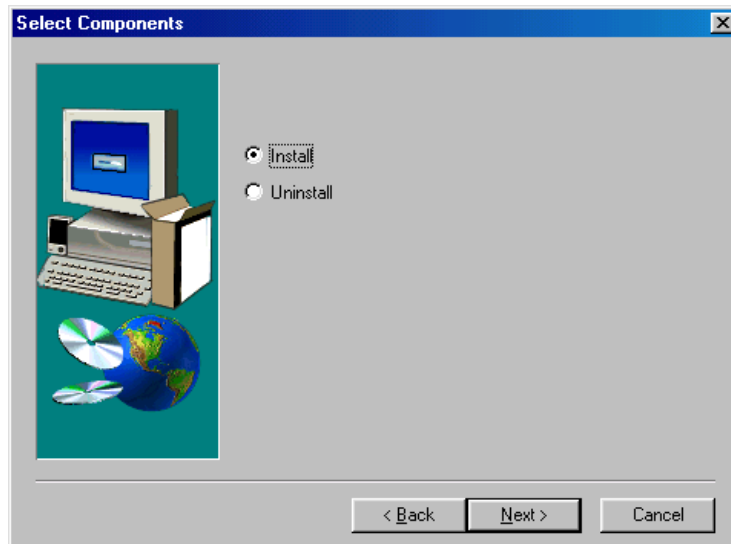

4. Choose the folder to where the program will install the driver. Select the default folder (C:\Program Files\IDETOOL) and then click on Next to proceed.

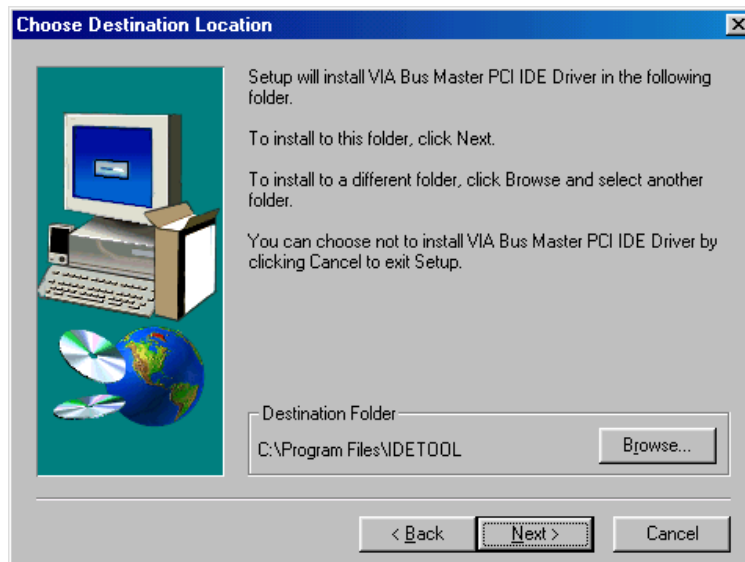

5. The program will now create an icon for the IDETOOL. Simply press Next to continue with the installation.

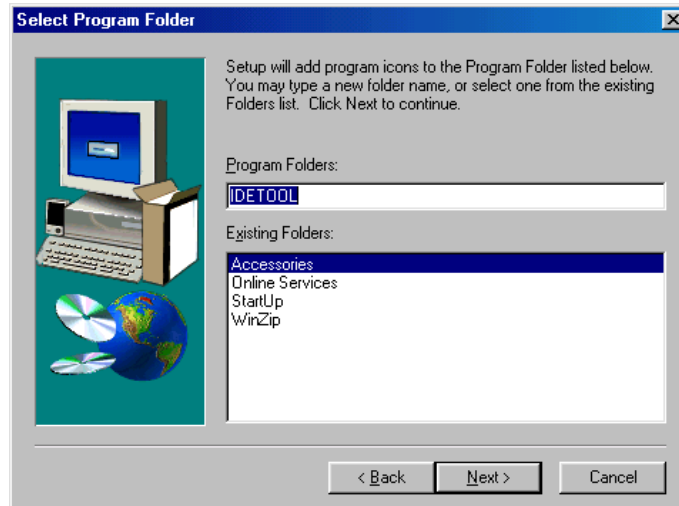

6. The program now installs and transfers the files to your system. After it finishes, you will be prompted to restart your system. We recommend you to reboot your computer to allow the new settings to take effect. Click on the Finish button to reboot.

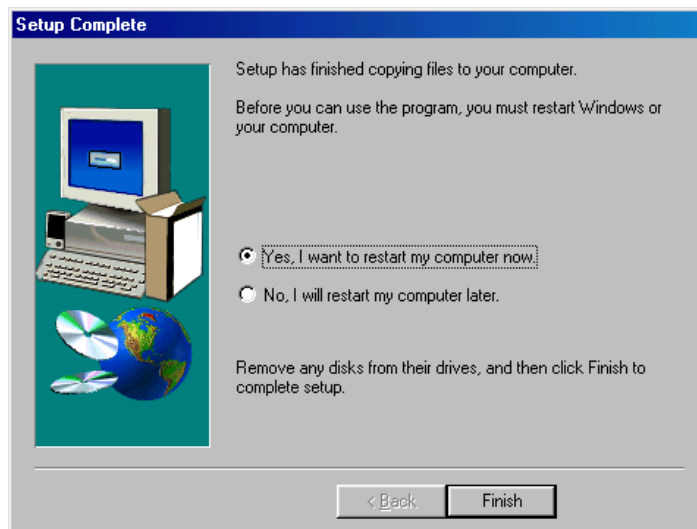

- Once the system enters the main Windows screen, it will display a new icon along the right hand task bar. This icon represents the IDE Tool quick launch program.

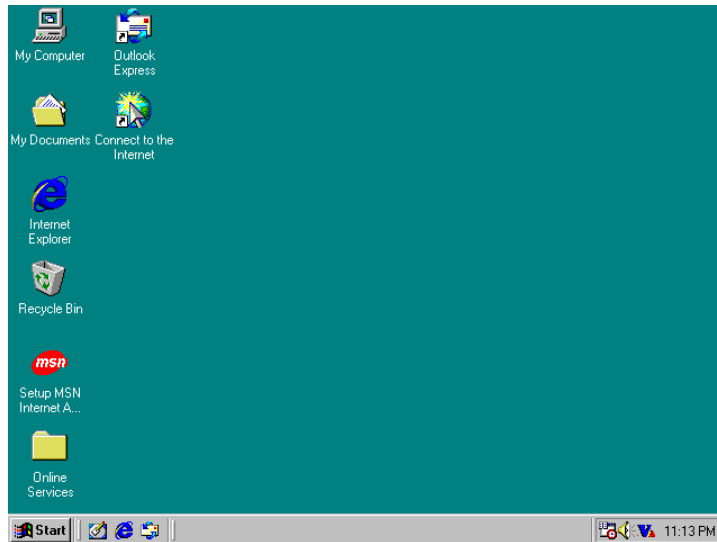

- Double-clicking on this new task bar icon will launch the IDE Tool's Drive Feature dialog box, as shown below.

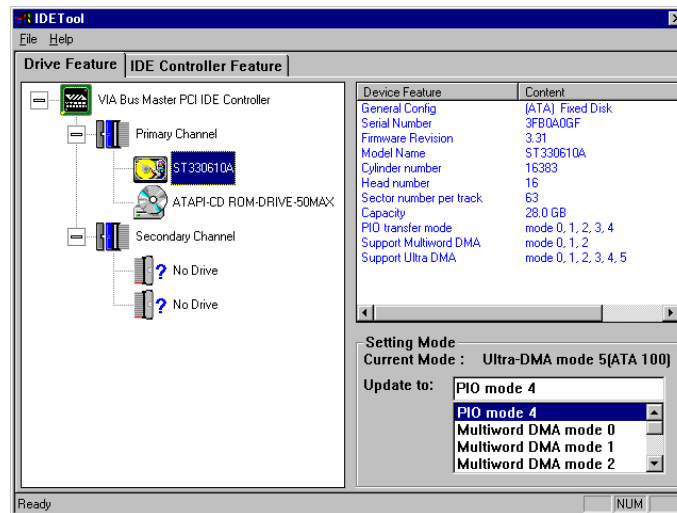

- The Drive Feature dialog box has 2 columns of information. The left column lets you to view the hardware installed on your system. When you select any hardware, the right column displays the device's information and specifications. You may also update the settings of your devices from the right column.

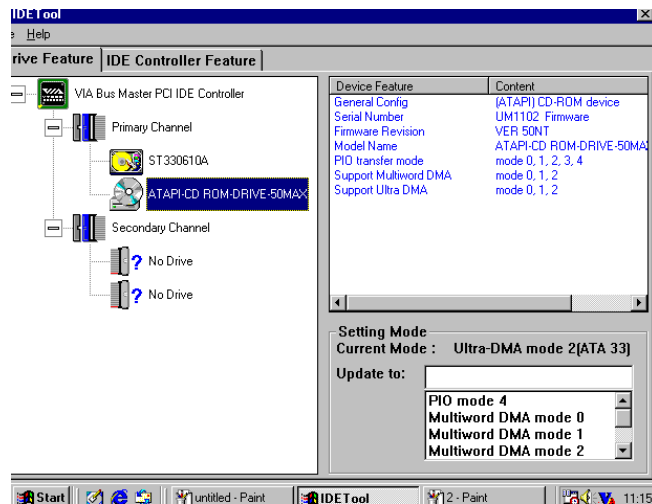

- Once you select the IDE Controller Feature from the IDE Tool dialog box, a list of read-only information related to the system's IDE controller is shown.

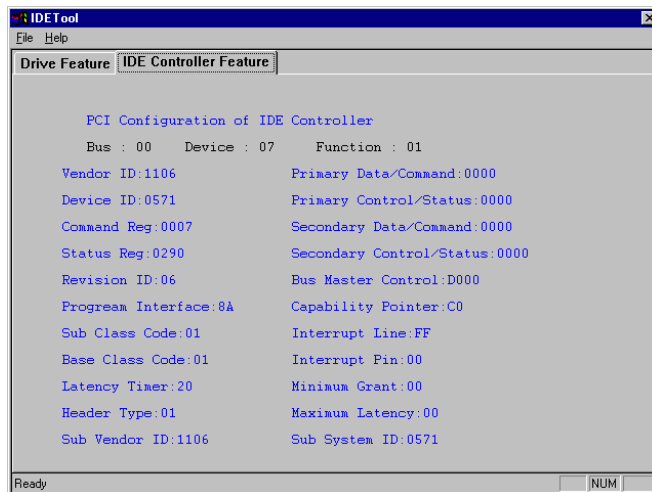

5.1.3 Audio Driver Installation

1. With the Utility CD Disk still in your CD ROM drive, open the File Manager and then select the CD-ROM drive. As soon as the system reads the disk, the VGA Menu screen below will appear on your display. Click on VIA_AC97 from the main menu.



2. Once the Welcome screen appears on the screen, make sure to close applications that are running and then click the Next button.

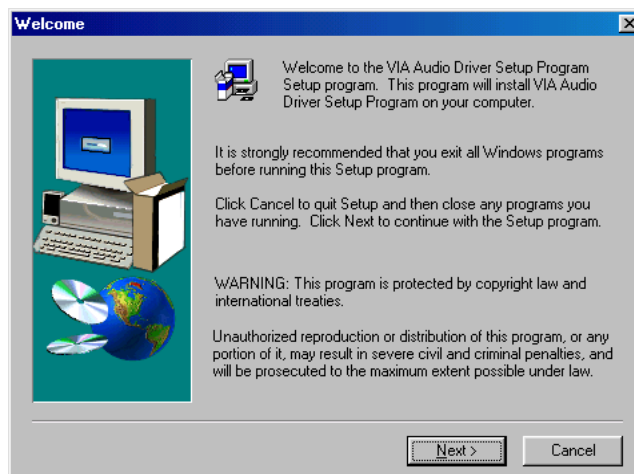

3. The Select Components dialog box is now displayed. Select on Install driver and then click on Next.

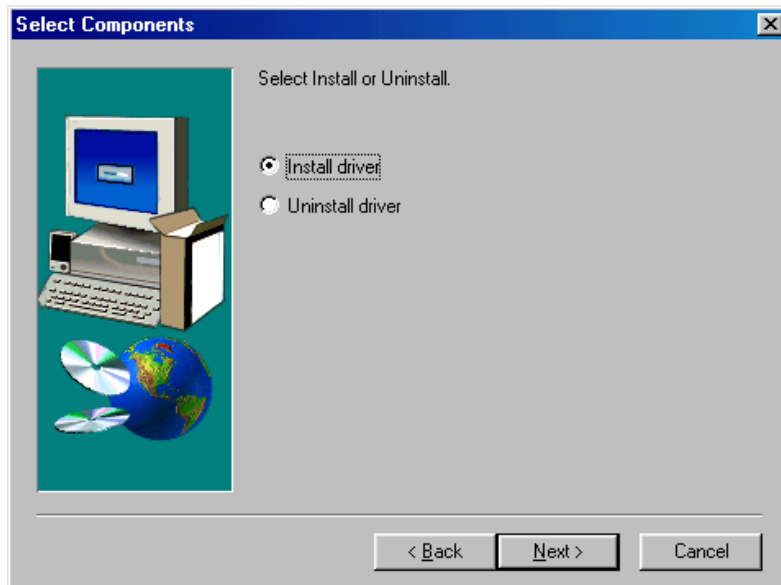

4. The program will now require the Windows installation disk for proper hardware installation. Insert the CD and then click on Next.

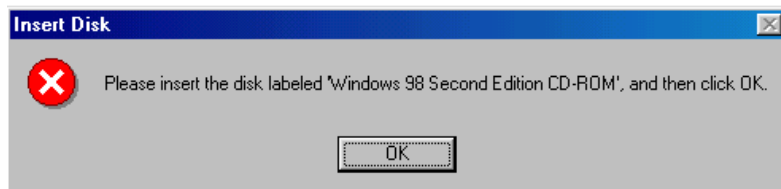

- When the display below appears on your screen, Setup is already installing and copying the related files onto your hard drive. Click on the Next button to proceed.

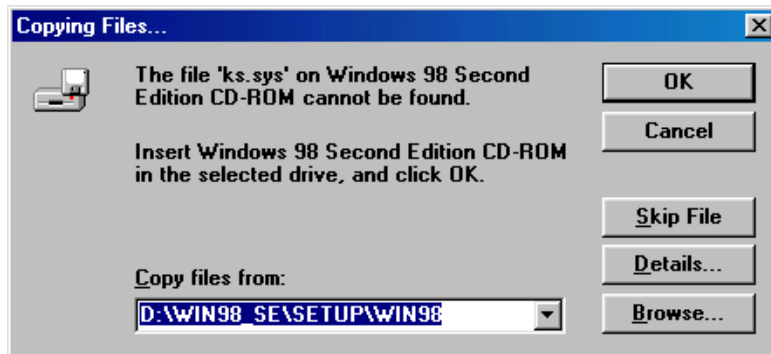

- After the audio driver installation finishes, select the Finish button to complete the installation process.



5.2 LAN Driver Installation for WIN95 & WIN98

1. With the Utility CD Disk still in your CD ROM drive, right click on My Computer icon from the Windows menu. Select on System Properties and then proceed to the Device Manager from the main menu.

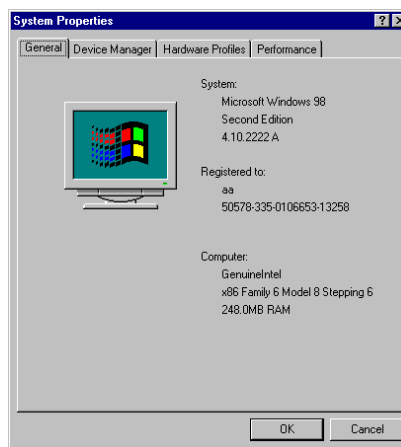

2. Select on Other Devices from the list of devices then double-click on PCI Ethernet Controller.

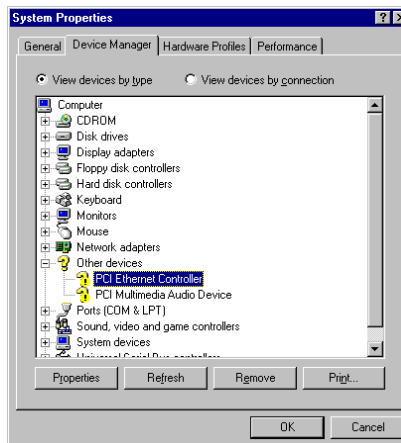

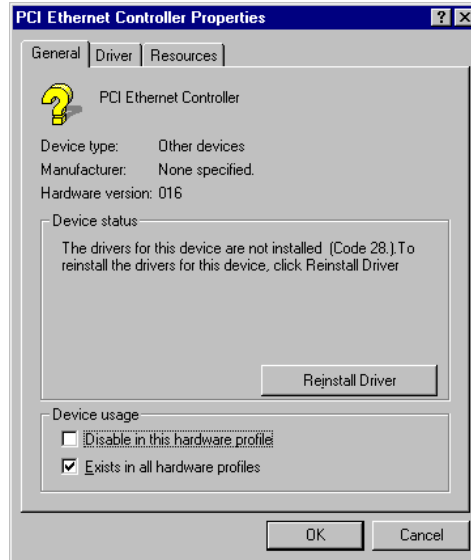

3. The PCI Ethernet Controller Properties screen then appears, allowing you to re-install the driver. Select Driver from the main menu to proceed.

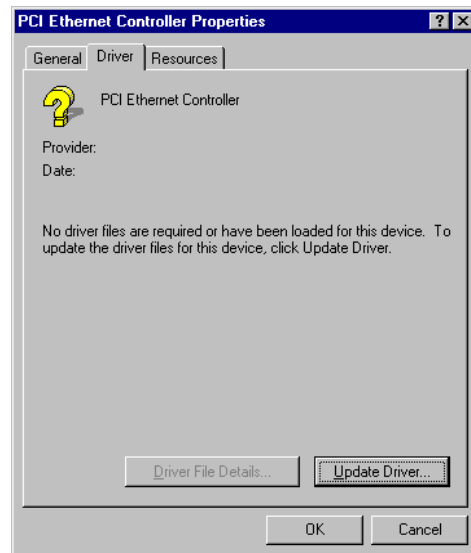

- The window then displays the current status of your LAN driver. Press on Update Driver button to continue.
- The program will then launch the Update Device Driver Wizard window that will install your device driver. Click on the Next button to proceed to the next step.



- When the succeeding window asks you what you wish Windows to do, tick on the "Search for a better driver...." Click on the Next button to proceed.



7. The Update Device Driver Wizard will then ask you to specify, by ticking, the path of the new driver. Tick on the open boxes where you require the program to search for the device driver then click on the Browse button to manually specify the path.



8. Press on the OK button as soon as you have located the path of your driver.

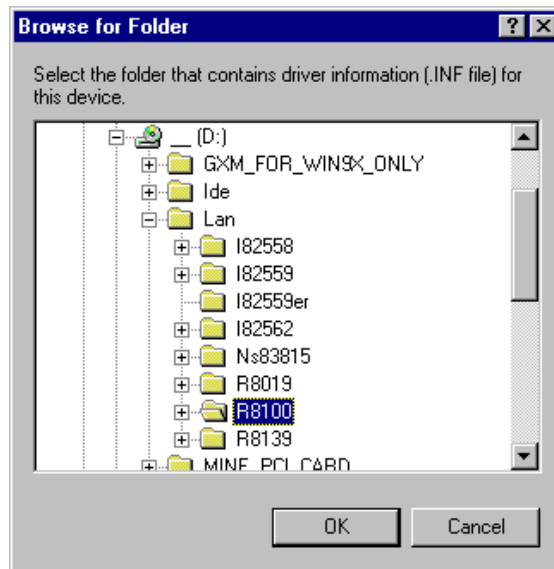

9. Once the program returns to the Add New Hardware Wizard screen, your specified location will appear. Press on the Next button to continue.



10. Once the program detects the device driver (*.inf) file from your specified location, it will automatically copy the files into your hard drive.
11. When copying of driver files finishes, the program will then ask you to insert your Windows.



12. The program then copies the necessary files from your Windows installation disk to complete the driver setup process. Once the driver is completely installed, the following message appears on your display. Click on the Finish button to proceed.

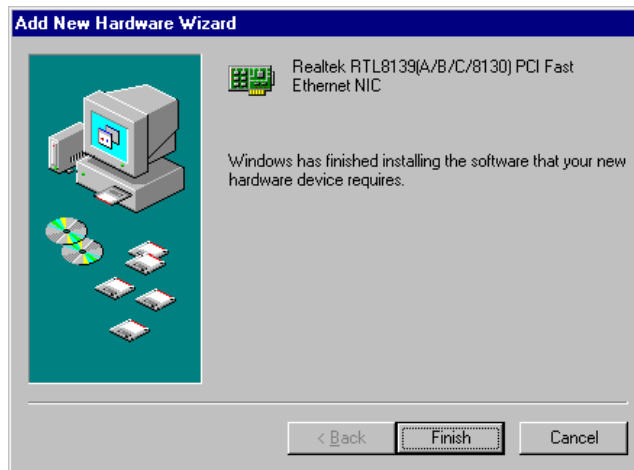

13. Restart your computer to make the new system settings take effect. Click on the Yes button when the screen below appears and your LAN Driver for Win95 and Win98 are now completely installed.



5.3 LAN Driver Installation for WIN NT4.0

1. With the Utility CD Disk still in your CD ROM drive, right click on Network Neighborhood icon from the Windows menu. Select on Properties.

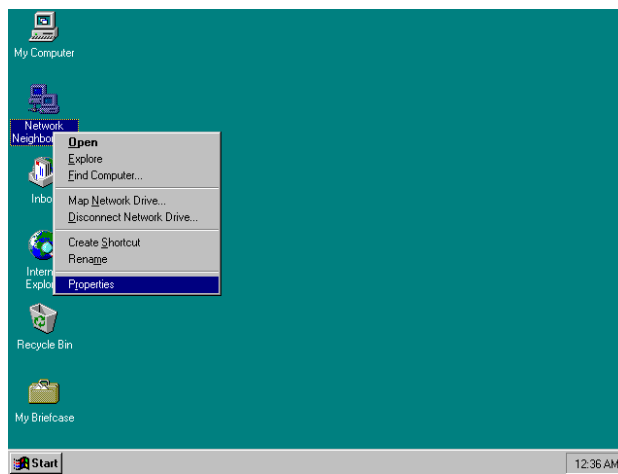

2. The system automatically detects the absence of Windows NT Networking. Click on the Yes button to start installation.

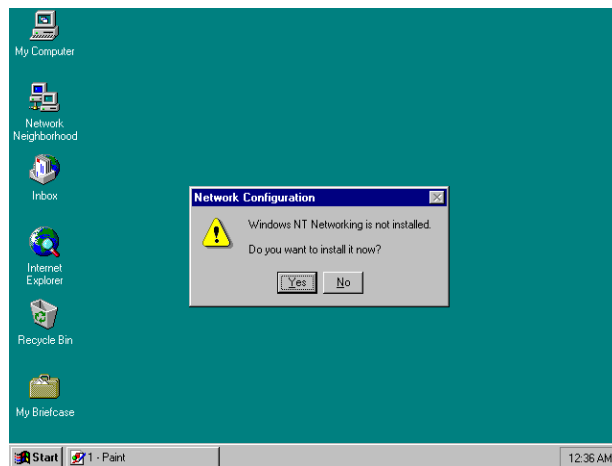

3. Tick on the "Wired to Network" once the following screen appears. Click on the Next to proceed.

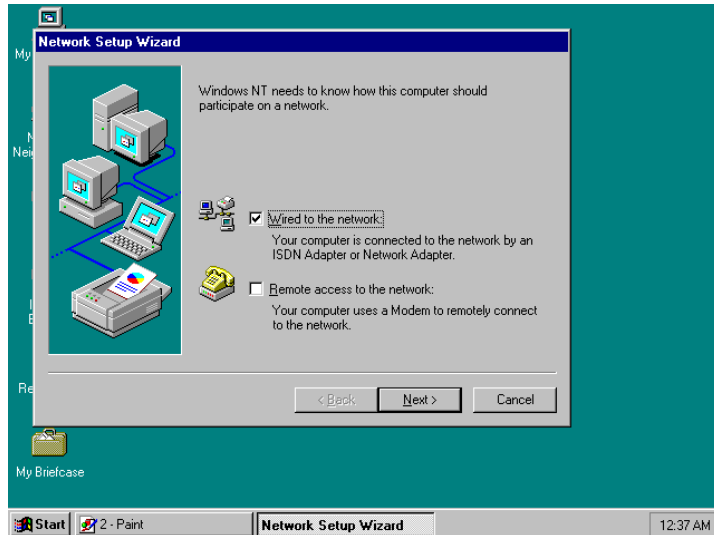

4. Click on the Start Search button for the program to locate the Network Adapter.

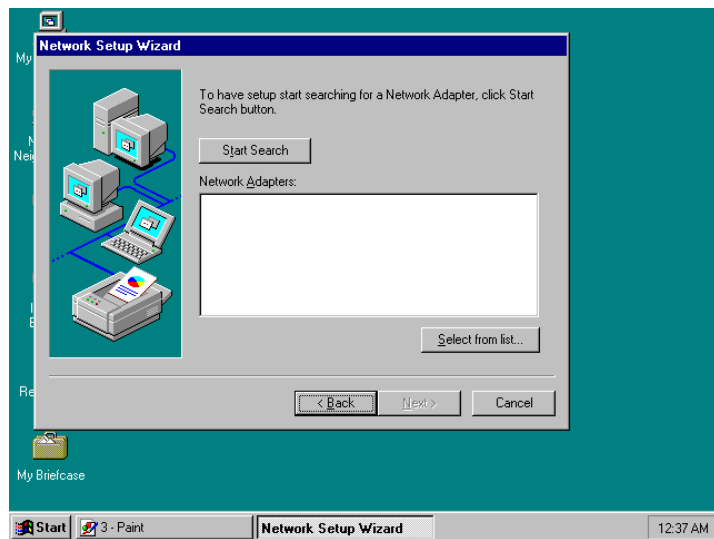

- Once setup finishes the search, it will list a number of adapters for you to choose from. Press on the Have Disk button to assign the driver path location.

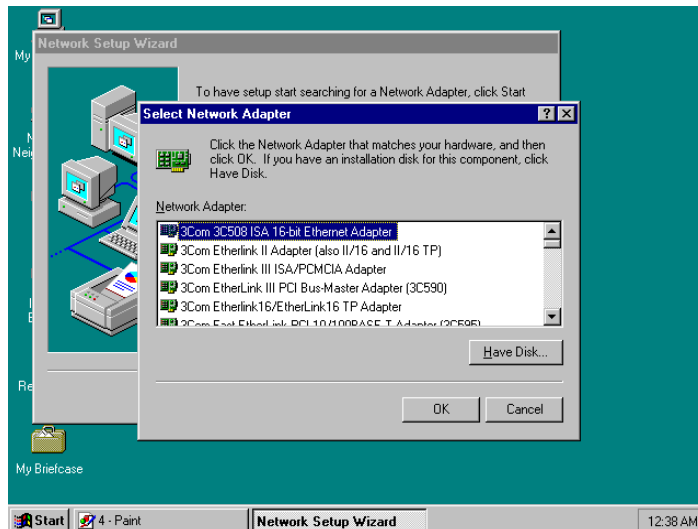

- Setup now asks you for the location of the driver. When you have entered the new driver path, press on the OK button to continue.

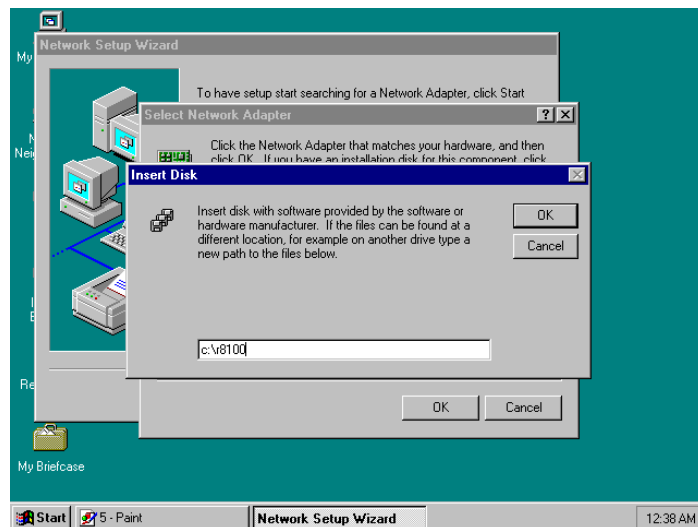

- When Setup finds the information it needs about the new driver, it will display the device it found on the following screen. Press on the OK button to accept and proceed.

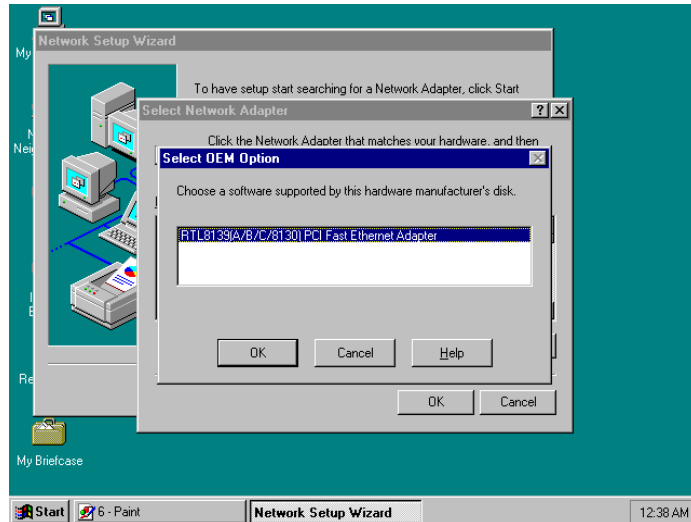

- Setup then returns to Network Setup Wizard screen and displays your new Network Adapter. Click on Next to continue.

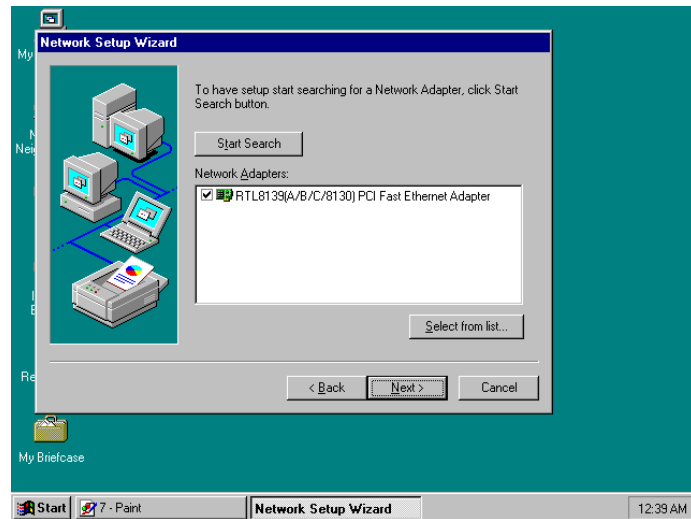

9. The Network Setup Wizard then allows you to set the Network Protocols on your network. Select the appropriate protocol and then click on Next to continue.

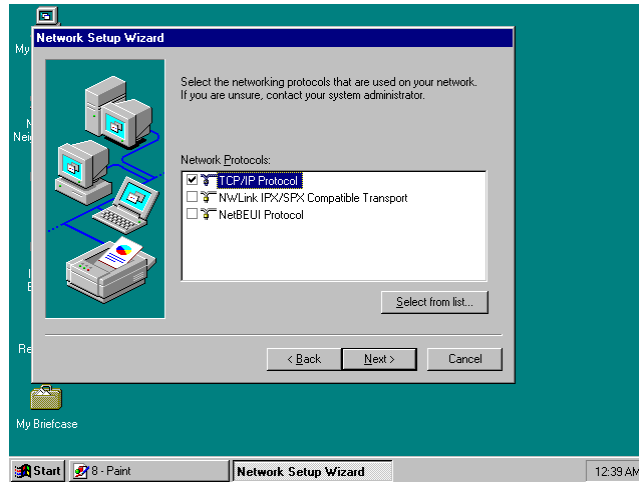

10. Before Setup starts installing the components found and the settings you made, it will give you the option to proceed or go back for changes from the following screen. Click on the Next button once you are sure of your devices.

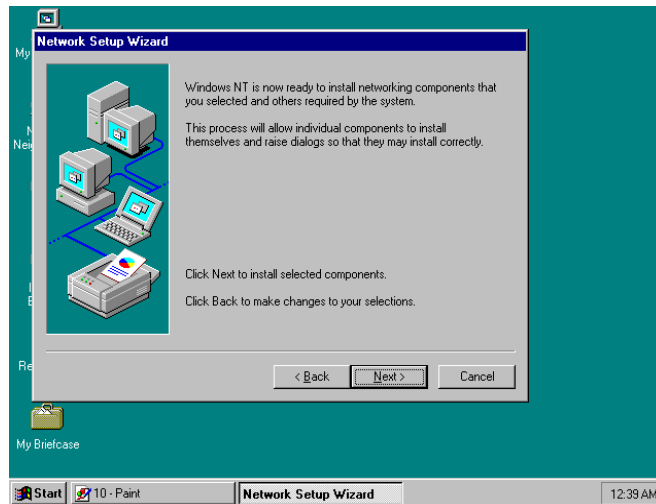

11. Windows NT Setup will then need to copy files necessary to update the system information. Specify the path then press Continue.

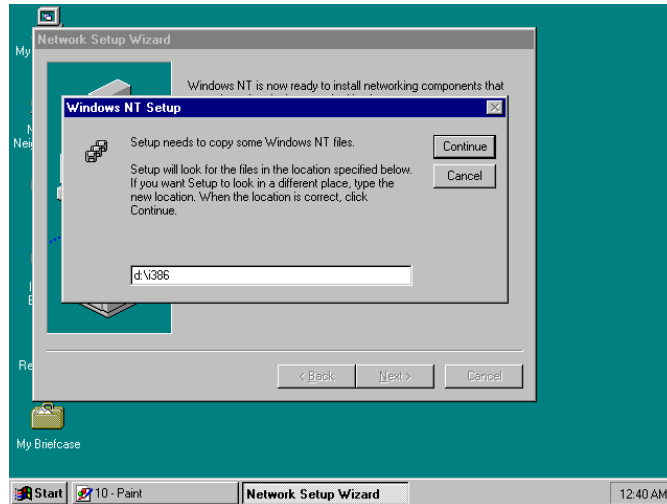

12. Once it finishes copying the files, Setup will now allow you to choose the Duplex Mode of your LAN controller. Press on the Continue button after making your selection.

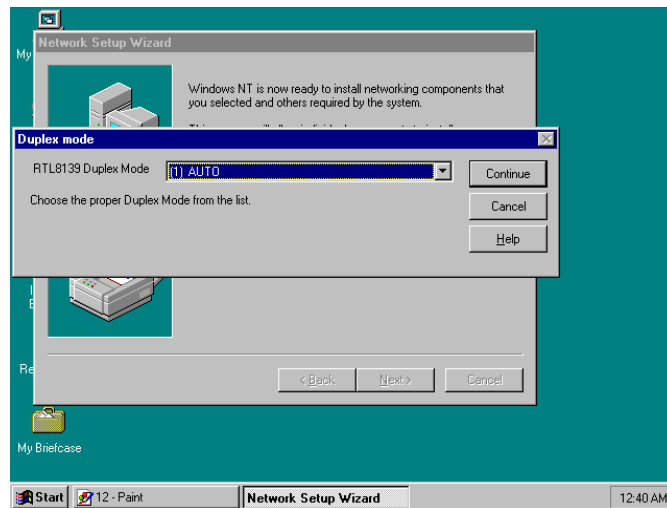

13. When Setup asks if you wish to change the TCP/IP settings of your system, select the appropriately. The default choice is No.

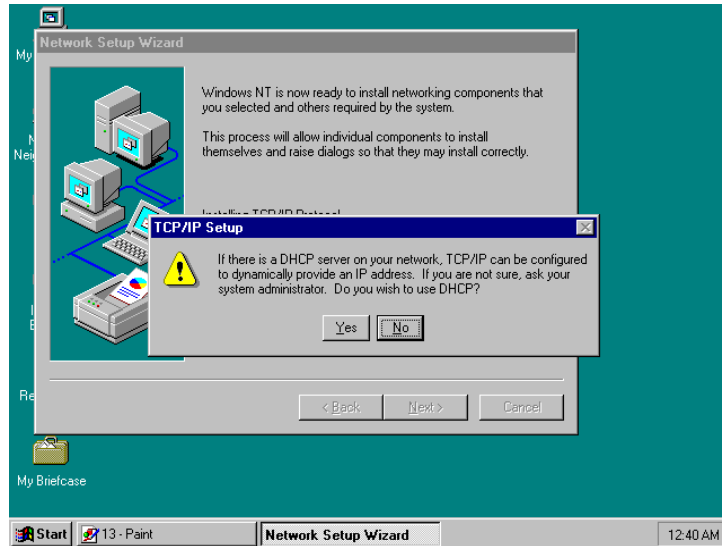

14. Setup then starts the Networking installation and copies the files.

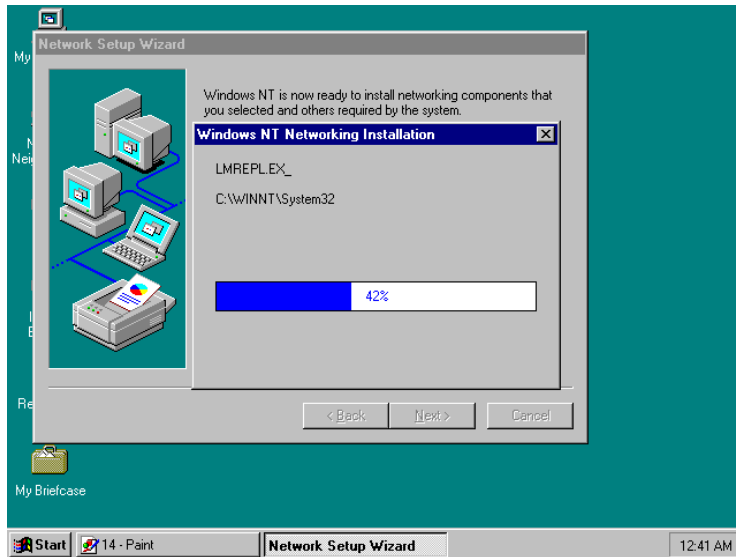

15. When Setup finishes copying, the TCP/IP properties of your system will then pop up on your screen like the one shown below. Make the necessary changes then click on OK to continue.

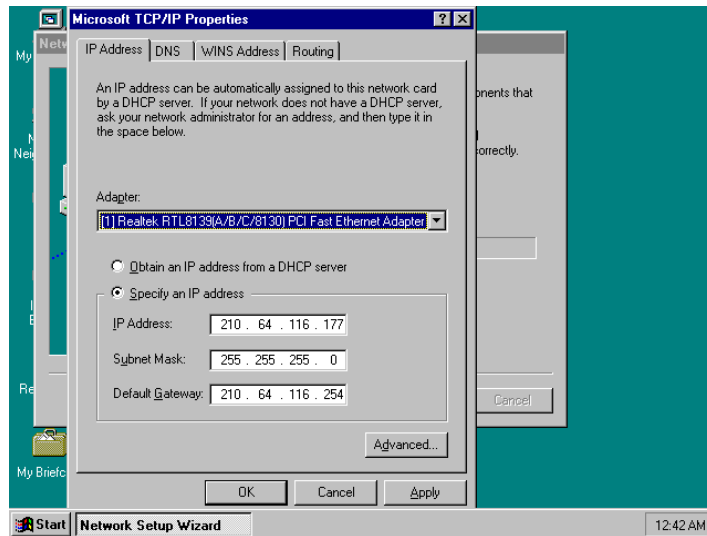

16. When the screen below appears, click on Next to continue.

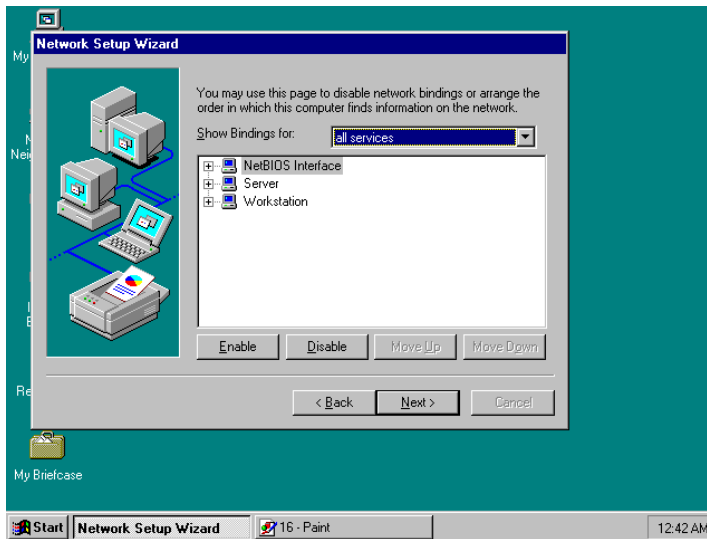

17. Setup then prompts you that it is ready to start the network. You may complete the installation thereafter. Click on Next to continue.

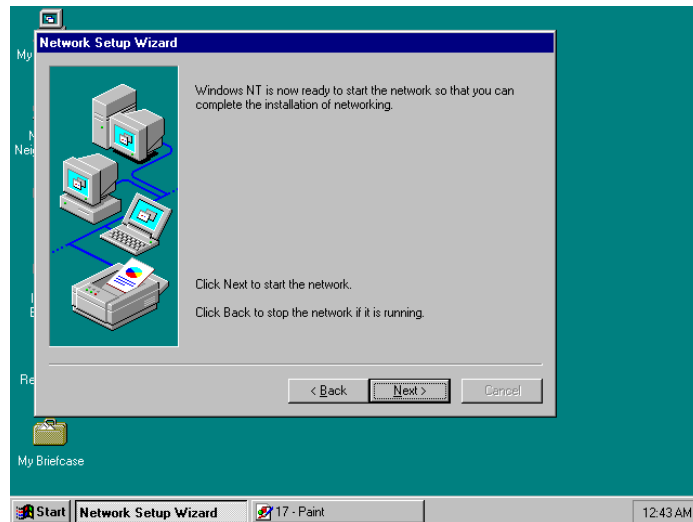

18. Assign the workgroup or domain setting of your computer. Click on Next to continue.

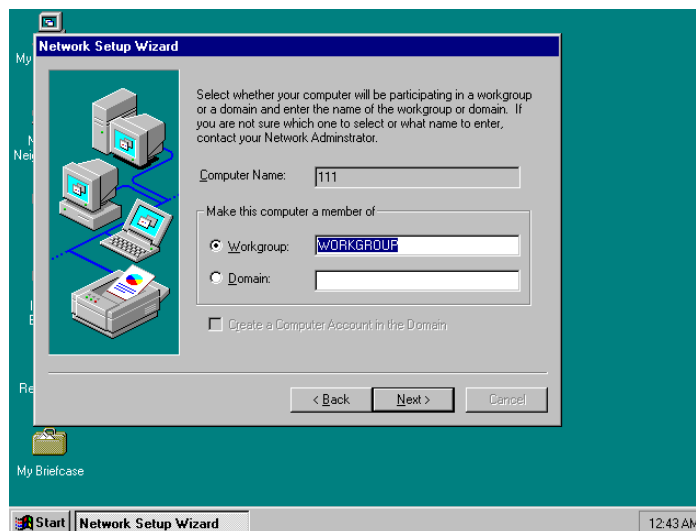

19. Restart your computer once the screen below appears. Click on Finish to continue.

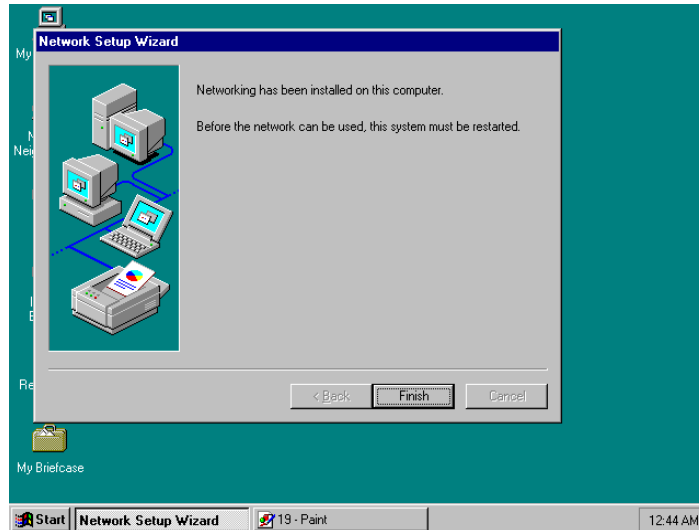

20. Click on the Yes button to restart your computer. The LAN driver installation for WIN NT4.0 is now complete.

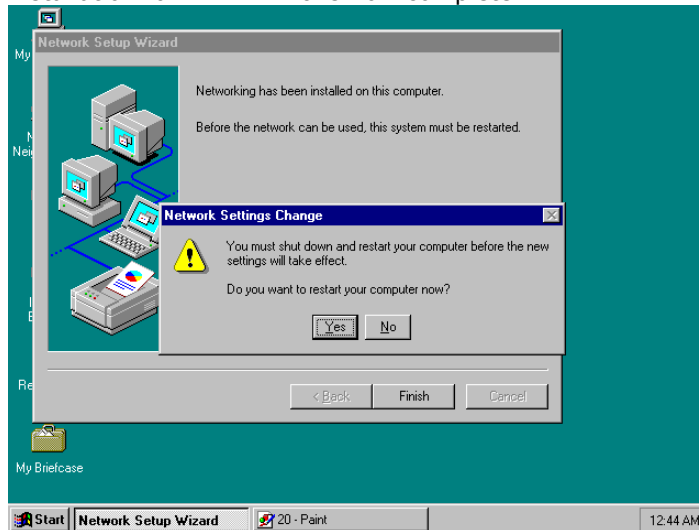

This page intentionally left blank.