

---

# Table of Contents

<b>Chapter 1. Introduction .....</b>	<b>3</b>
1.1 Product Overview .....	3
1.2 Specification .....	4
1.3 Component Placement .....	7
1.4 Block Diagram .....	8
<b>Chapter 2. Hardware Setup .....</b>	<b>9</b>
2.1 Jumpers and Connectors Location .....	9
2.2 CPU Setting .....	12
2.3 CMOS Setting .....	12
2.4 Watchdog Timer Setting .....	13
2.5 Embedded Flash Disk .....	14
2.6 Power and Fan Connectors .....	15
2.7 Display Interface .....	16
2.8 Ethernet Interface .....	17
2.9 Audio Interface .....	18
2.10 Serial Port COM2 Mode Configuration .....	19
2.11 Switches and Indicators .....	20
<b>Chapter 3. BIOS Setup .....</b>	<b>21</b>
<b>Chapter 4. Driver Installation .....</b>	<b>23</b>
4.1 Install Board's Software .....	23
4.2 Install Ultra ATA IDE Driver .....	23
4.3 Install VGA Driver .....	23
4.4 Install LAN Driver .....	23
4.5 Install Audio Driver .....	23
4.6 Link to < Website > Homepage .....	23
4.7 Browse this CD .....	23

---

<b>Appendix A. System Resources</b> .....	<b>25</b>
A.1 I/O Port Address Map.....	25
A.2 Memory Address Map .....	27
A.3 System IRQ and DMA Resource.....	28
<b>Appendix B. Flash the BIOS</b> .....	<b>29</b>
B.1 BIOS Auto Flash Tool .....	29
B.2 Flash Method .....	29
<b>Appendix C. I/O Port Pin Assignment</b> .....	<b>31</b>
C.1 IDE Port .....	31
C.2 Floppy Port.....	32
C.3 Parallel Port .....	33
C.4 RS-232 Serial Port.....	34
C.5 USB Port.....	35
C.6 IrDA Port .....	35
C.7 VGA Port.....	36
C.8 LAN Port .....	36
C.9 AT Keyboard Port.....	37
C.10 PS/2 Keyboard and Mouse Port.....	37

---

# Chapter 1. Introduction

## 1.1 Product Overview

COMMELL's HE-860 / HE-860S SBC (Single Board Computer) is an all-in-one industrial half-size PISA (PCI/ISA)-bus / ISA-bus CPU card based on VIA Eden embedded low power platform. Based on PISA-bus interface, HE-860 offers the flexible expansibility with PCI or ISA expansive interfaces via the industrial backplane. With 1 GBytes per seconds of data transfer rate let HE-860 provide several times of bandwidth rather than NS Geode, Transmeta Crusoe, and Intel ULP Celeron based SBC. With VIA Eden platform, 512 MB PC-133 SDRAM, integrated 3D SVGA8MB VRAM, 10/100 Mbps LAN, UltraATA/100 IDE, AC97 3D Audio, SSD interfaces and ISA 64mA high drive capacity, the HE-860 provides the ideal embedded solutions for:

**Advanced Embedded Computing Platform:** advanced 686 level VIA Eden platform with 533 MHz of speed at 133 MHz of FSB, provides 1 GBytes/sec of data transfer rate. Based on x86 architecture and VIA's latest technology, HE-860 supports most of the x86-based OS and AP. That is, with HE-860, the embedded systems can be integrated and upgraded easily with the existent and popular x86-based software.

**Ultra-Low Power / Fan Free Solution:** based on the latest .13 of IC manufacturing procedure, the operating voltage range of VIA Eden ESP processor is from only 1.05 to 1.2 volts. The advanced thermal design makes HE-860 ideal for fan free embedded system designs as well as small size and lower profile form factors.

**All-in-one Integrated Solution:** HE-860 integrated with 3D SVGA, 10/100 Mbps LAN, AC97 3D Audio, UltraATA/100 IDE, DiskOnChip embedded solid state flash disk interfaces and ISA 64mA high drive capacity, provides the high integration solution for high-end embedded applications features high speed, high integration, low power, fan free, and full embedded systems with embedded OS in flash disk.

---

## 1.2 Specification

### General Specification

<b>Form Factor</b>	<b>HE-860 : PISA</b> 1.7 compliant, with 4 bus master PCI <b>HE-860S : ISA</b> bus interface only
<b>CPU</b>	Onboard VIA Eden 533 MHz CPU at 133 MHz FSB <b>Optional Compatible CPU Configuration for OEM</b> VIA Eden 400, 667 MHz CPU (fan free operating) VIA EPGA C3 800, 977 MHz and above CPU (with onboard low profile CPU cooling fan)
<b>Chipset</b>	VIA PLE133T chipset with 8601T and 686B
<b>Memory</b>	512 MB PC100/133 SDRAM on 1 168-pin DIMM socket
<b>BIOS</b>	Phoenix-Award 2Mb PnP flash BIOS
<b>Green Function</b>	ACPI version 1.0 and APM version 1.2 compliant
<b>Watchdog Timer</b>	6-level generates NMI or system reset watchdog timer
<b>Real Time Clock</b>	VIA 686B built-in RTC with onboard lithium battery
<b>Enhanced IDE</b>	PCI enhanced IDE interface supports dual ports up to 4 ATAPI devices with UltraATA/100 supported IDE2 Vcc power supported for cable free DOM (DiskOnModule)
<b>ISA High Drive</b>	ISA 64mA high drive capacity with TI 245 buffer, supports over 20 pieces of ISA-based add-on cards

### Multi-I/O Port

<b>Chipset</b>	VIA 686B chipset built-in super I/O controller
<b>Serial Port</b>	1 x RS-232 serial port COM1 1 x jumper selectable RS-232/422/485 serial port COM2 Both with 16C550 compatible UART and 16 bytes FIFO
<b>USB Port</b>	Two USB ports with USB version 1.1 compliant
<b>Parallel Port</b>	One bi-direction parallel port with SPP/ECP/EPP mode
<b>Floppy</b>	One floppy port supports up to two FDD
<b>IrDA Port</b>	One IrDA compliant Infrared interface supports SIR
<b>K/B &amp; Mouse</b>	External PS/2 keyboard / mouse port with MiniDIN on bracket; Internal AT keyboard port

## Solid State Disk Interface

<b>Flash Type</b>	M-systems DiskOnChip-2000 and DiskOnChip Millennium embedded solid state flash disk
<b>Package</b>	Single chip flash disk in 32-pin DIP JEDEC
<b>Capacity</b>	Up to 1 GBytes flash memory
<b>Data Reliability</b>	ECC / EDC data protection
<b>Memory Window</b>	8 Kbytes of memory window

## Display Interface

<b>Chipset</b>	VIA 8601T built-in Trident Blade3D SVGA controller
<b>Video Memory</b>	8 MBytes shared with system memory
<b>Display Type</b>	CRT, LCD monitor and analog VGA display Optional onboard TMDS interface for TMDS LCD
<b>Connector</b>	DB15 female connector on bracket Optional onboard 20-pin header for TMDS interface

## Ethernet Interface

<b>Chipset</b>	PCI RTL8100(B) Fast Ethernet controller
<b>Type</b>	10Base-T / 100Base-TX, auto-switching Fast Ethernet, full duplex, IEEE802.3U compliant
<b>Connector</b>	External RJ45 with LED on bracket

## Audio Interface

<b>Chipset</b>	VIA 686B built-in AC97 3D audio controller with onboard ALC201A codec
<b>Interface</b>	Line-in, line-out, Mic-in and CD-in interface
<b>Connector</b>	Internal 10-pin header for line-in, line-out and mic-in Internal 4-pin wafer for CD-in

---

## Power and Environment

---

<b>Power Req.</b>	+5V, +12V, -12V DC
<b>Dimension</b>	185 x 127 mm (L x H)
<b>Weight</b>	0.28 Kg
<b>Temperature</b>	Operating within 0 ~ 60°C (32 ~ 140°F) Storage within -20 ~ 85°C (-4 ~ 185°F)

---

## Ordering Code

---

<b>HE-860VL</b>	Half-size <b>PISA-bus</b> Embedded VIA Eden CPU Card with onboard VIA Eden 533MHz CPU, VGA, LAN, Audio, DiskOnChip Interfaces and ISA High Drive Capacity
<b>HE-860VXL</b>	Same as HE-860VL but <b>with onboard TMDS Panel Link Interface</b>
<b>HE-860SVL</b>	Half-size <b>ISA-bus</b> Embedded VIA Eden CPU Card with onboard VIA Eden 533MHz CPU, VGA, LAN, Audio, DiskOnChip Interfaces and ISA High Drive Capacity
<b>HE-860SVXL</b>	Same as HE-860SVL but <b>with onboard TMDS Panel Link Interface</b>
<b>OEM Version</b>	Other Configuration Based on HE-860 with Compatible Eden/C3 CPU, Optional Onboard Functions and Others for OEM Projects

---

Online product information detail and updates are available on <http://www.commell.com.tw>

## 1.3 Component Placement

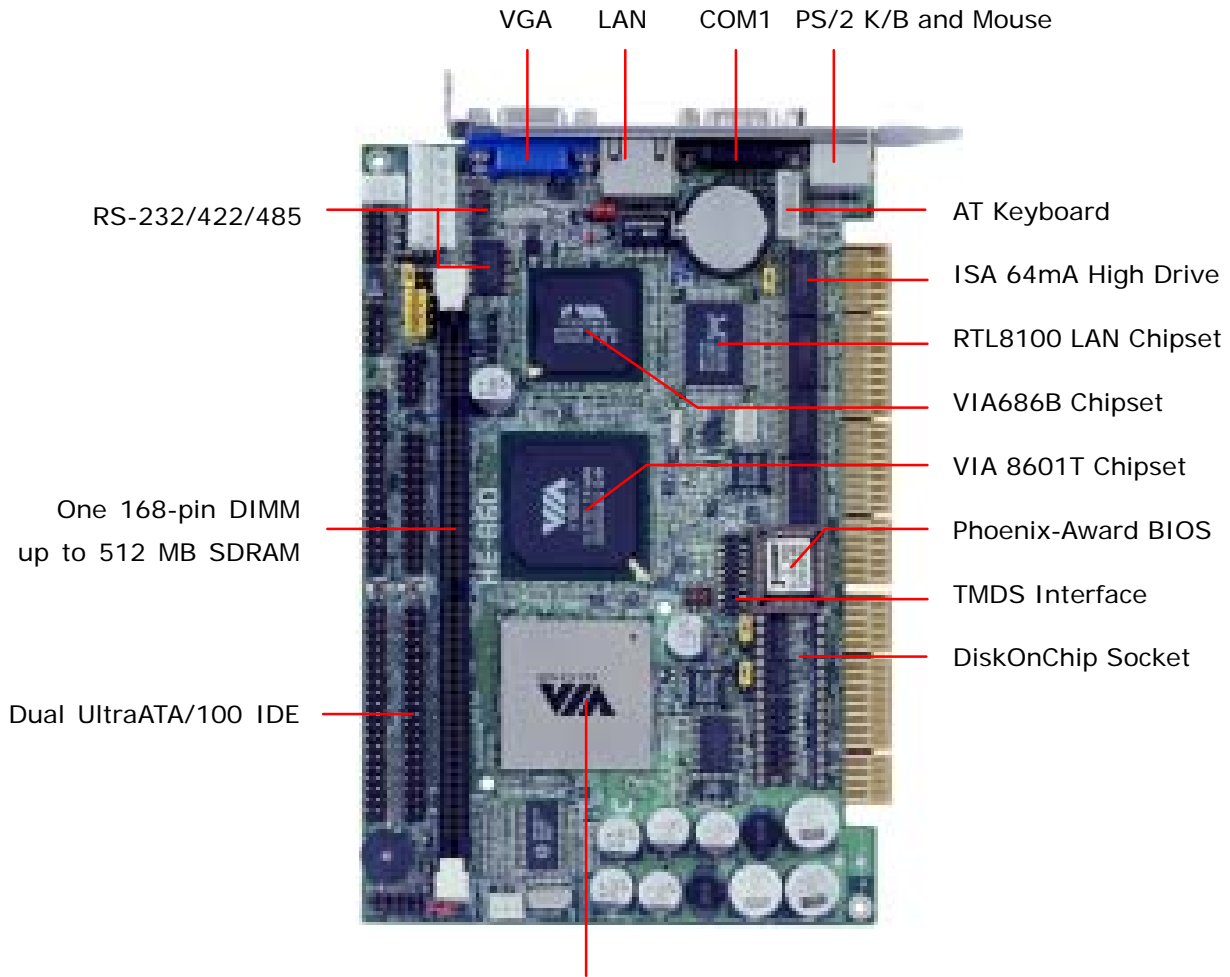

Embedded VIA Eden / C3 CPU

VIA Eden Ultra Low Voltage CPU for Fan Free Operation

VIA EBGA C3 CPU with Onboard CPU Cooling Fan



Same Location on HE-860S  
(Half-size **ISA Bus** CPU Card)

## 1.4 Block Diagram

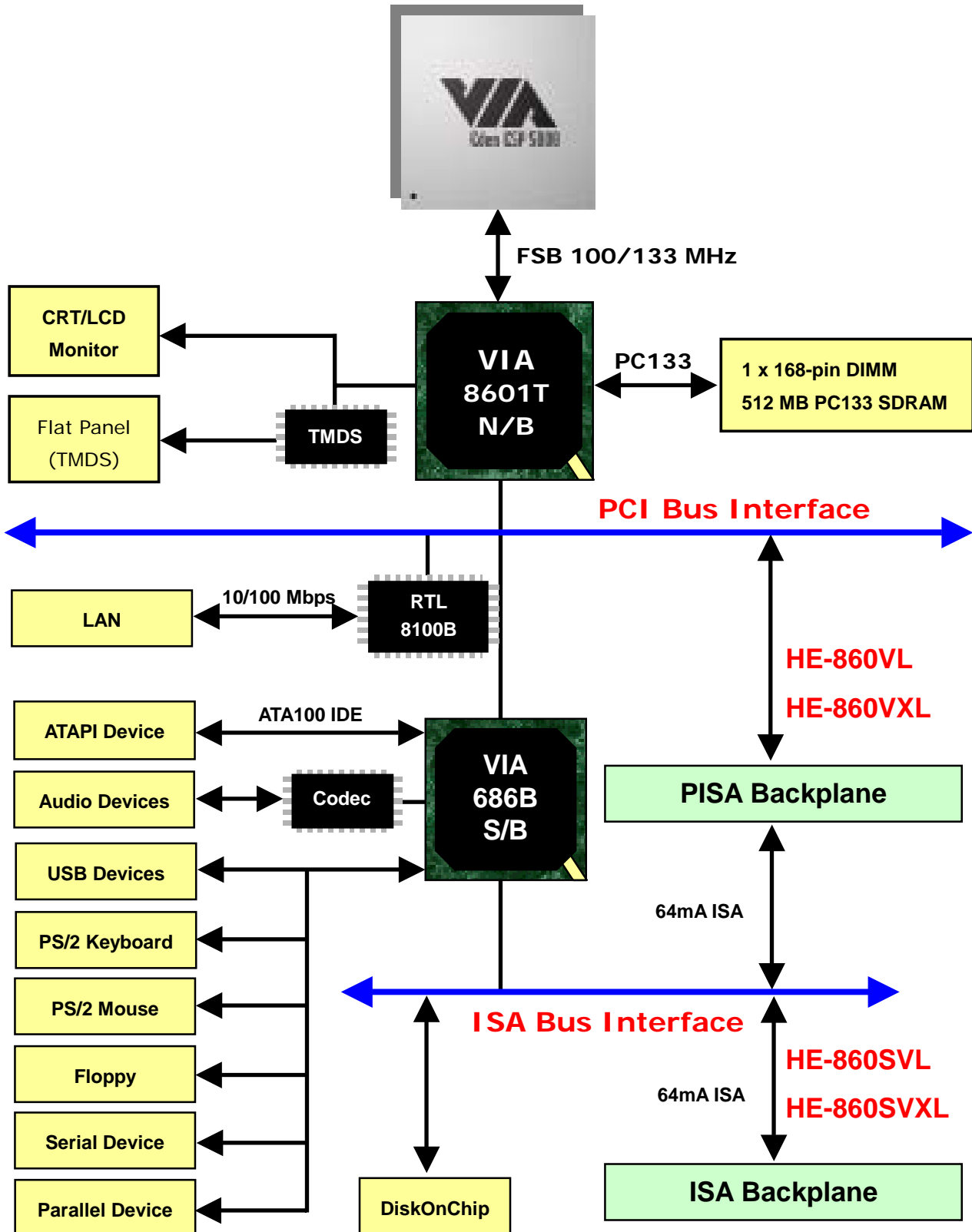



## Chapter 2. Hardware Setup

This chapter contains the information for installation of hardware. The install procedure includes jumper settings, CPU and memory installation, fan, I/O and panel connections.

### 2.1 Jumpers and Connectors Location

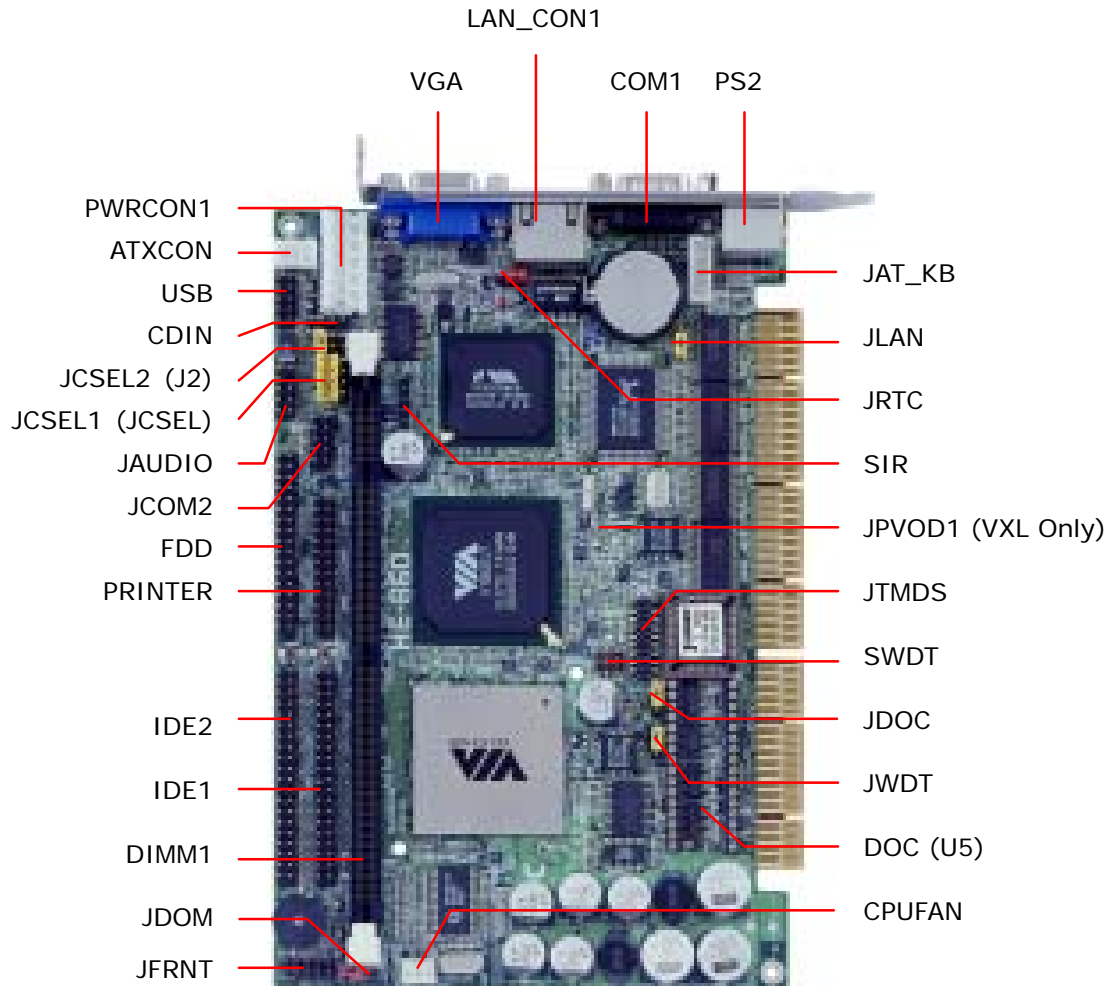

Same Location on HE-860S  
(Half-size **ISA Bus** CPU Card)

---

### 2.1.1 Jumper Reference

<b>Jumper</b>	<b>Function</b>	<b>Section</b>
JRTC	COMS Setting	<a href="#">2.3</a>
JWDT	Watchdog Timer Setting	<a href="#">2.4</a>
SWDT	Watchdog Timer Timeout Value Setting	<a href="#">2.4</a>
JDOC	DiskOnChip Address Setting	<a href="#">2.5.1</a>
JDOM	DiskOnModule Power Setting	<a href="#">2.5.2</a>
JPVOD1	TMDS Voltage Setting	<a href="#">2.7</a>
JLAN	LAN Enable / Disable Setting	<a href="#">2.8</a>
JCSEL1 (JCSEL)	COM2 RS232/422/485 Mode Setting	<a href="#">2.10</a>
JCSEL2 (J2)	COM2 RS232/422/485 Mode Setting	<a href="#">2.10</a>

---

## 2.1.2 Connector Reference

<b>Connector</b>	<b>Function</b>	<b>Remark</b>
DIMM1	168-pin DIMM Socket	Standard
IDE1	40-pin Primary IDE Port	Standard
IDE2	40-pin Secondary IDE Port	Standard
FDD	34-pin FDD Port	Standard
PRINTER	26-pin Parallel Port	Standard
USB	10-pin 1st / 2nd USB Port	Standard
JCOM2	10-pin COM2 RS232/422/485 Serial Port	Standard
DOC (U5)	32-pin DiskOnChip Socket	Standard
JAT_KB	5-pin AT/PC Keyboard Connector	Standard
SIR	5-pin SIR Infrared Port	Standard
PWRCON1	6-pin AT P8 Power Connector	Standard
ATXCON	3-pin ATX Signal Connector	Standard
JFRNT	10-pin Front Panel Connector	Standard
CPUFAN	3-pin CPU Fan Connector	Standard
JAUDIO	10-pin Audio Connector	Standard
CDIN	5-pin CD-in Connector	Standard
JTMDS	20-pin TMDS Panel Link Connector	VXL only
VGA	DB15 Female VGA Port on Bracket	Standard
PS2	6-pin MiniDIN PS/2 Keyboard and Mouse Connector on Bracket	Standard
LAN_CON	RJ45 Primary LAN Port on Bracket	VL, VXL only
COM1	DB9 Male COM1 Port on Bracket	Standard

---

## 2.2 CPU Setting

The board is based on VIA embedded Eden platform features standard x86 architecture, high performance, low power consumption and supports VIA Eden / C3 CPU with onboard SMT.

With VIA's high integrated PLE133T chipset and Eden embedded CPU, the board can easily update the old 486 or 586 level embedded x86 based systems like Intel mobile Pentium, Tillamook, and other RISC based systems like NS GX1 and Transmeta Crusoe. Based on the latest 0.13 micron of semi-conductor technology, the VIA Eden works at the ultra low voltage of 1.0 to 1.2 Volts of Vcore. It makes the VIA Eden platform be the ideal solution for embedded high performance applications.

The FSB, ratio and voltage of CPU is default set by onboard CPU and without any additional jumper selection.

## 2.3 CMOS Setting

The board's data of CMOS can be setting in BIOS. If the board refuses to boot due to inappropriate CMOS settings, here is how to proceed to clear (reset) the CMOS to its default values.

Jumper: JRTC

Type: onboard 3-pin header

JRTC	Mode
1-2	Clear CMOS
2-3	Normal Operation

Default setting

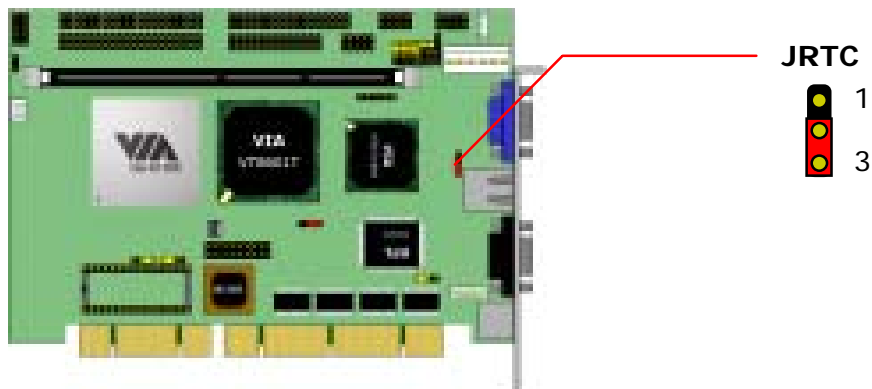

## 2.4 Watchdog Timer Setting

The onboard watchdog timer can be used on system-self monitor and reset.

### 2.4.1 Watchdog Timer Mode Setting

Jumper: JWDT

Type: onboard 3-pin header

JWDT	Watchdog Timer
1-2	Active NMI
2-3	Reset

Default setting

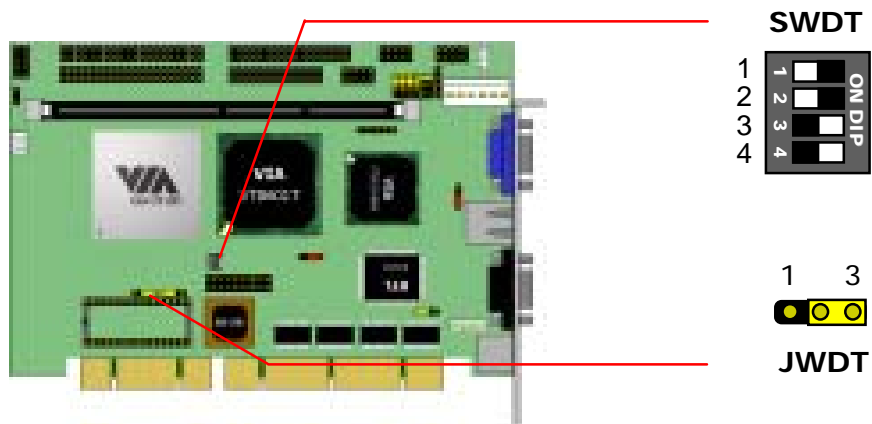

### 2.4.2 Watchdog Timer Time-out Value Setting

Jumper: SWDT

Type: onboard 4-way DIP Switch

Time-out Value	SWDT			
1 Sec.	OFF	OFF	ON	OFF
2 Sec.	OFF	OFF	ON	ON
10 Sec.	OFF	ON	OFF	OFF
20 Sec.	OFF	ON	OFF	ON
110 Sec.	ON	OFF	OFF	OFF
220 Sec.	ON	OFF	OFF	ON

Default setting

## 2.5 Embedded Flash Disk

The board supports both 32-pin [DiskOnChip 2000](#) and [DiskOnChip IDE Pro](#) embedded flash disk. The onboard 32-pin socket, supports DiskOnChip 2000 single chip flash disk in 32-pin DIP JEDEC with jumper selectable address on jumper JDOC; onboard 40-pin IDE2 box header supports normal DOM (DiskOnModule) or M-systems DiskOnChip IDE Pro flash disk with jumper selectable +5V Vcc power for cable free applications on jumper JDOM.

### 2.5.1 DiskOnChip 2000 Address Setting

Jumper: JDOC

Type: onboard 4-pin header

JDOC	DiskOnChip Address
1-2	D000h
2-3	D800h

Default setting

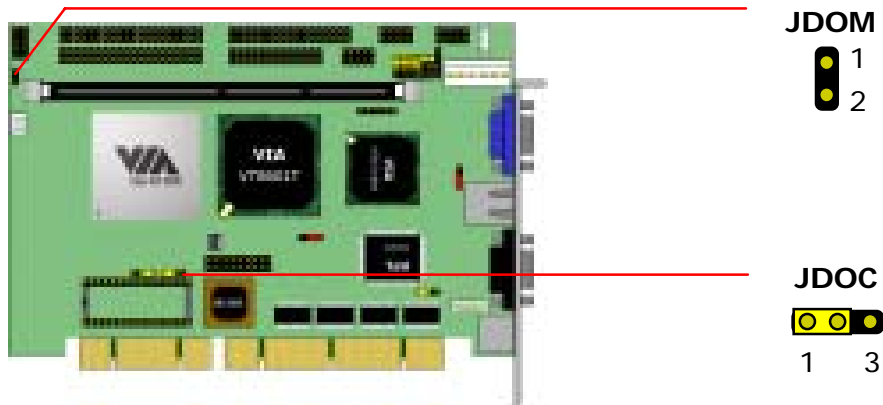

### 2.5.2 DiskOnModule or DiskOnChip 2000 IDE Pro

Jumper: JDOM

Type: onboard 2-pin header

JDOM	+5V on Pin-20 of IDE2
OFF	Disable
ON	Enable

Default setting

## 2.6 Power and Fan Connectors

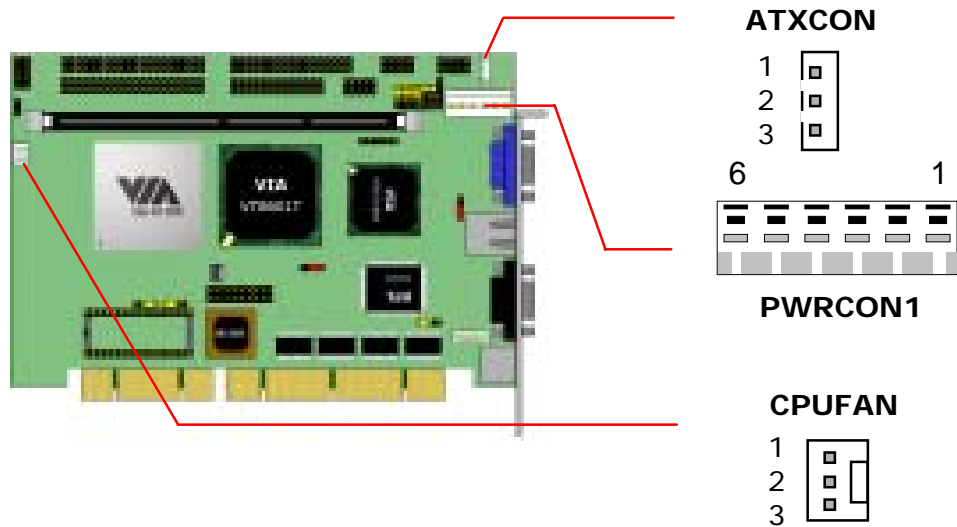

Connector: PWRCON1  
Type: 6-pin Standard AT P8 Power Connector

Pin	Description
1	Power Good
2	Vcc
3	+12V
4	-12V
5	Ground
6	Ground

Connector: ATXCON  
Type: 3-pin Header for ATX Function

Pin	Description	Pin	Description	Pin	Description
1	5V Standby	2	Ground	3	Power On

Connector: CPUFAN  
Type: 3-pin Header for CPU or System Fan

Pin	Description	Pin	Description	Pin	Description
1	Fan Ctrl	2	+12V	3	Ground

## 2.7 Display Interface

The board uses VIA8601T integrated Trident 2xAGP VGA accelerator with 3D/2D engine and up to 8 MB of video memory shared with system memory. It supports CRT and LCD monitor via the standard DB15 female connector on bracket an optional TMDS panel link interface via onboard 20-pin header JTMDS and voltage jumper JPVOD1.

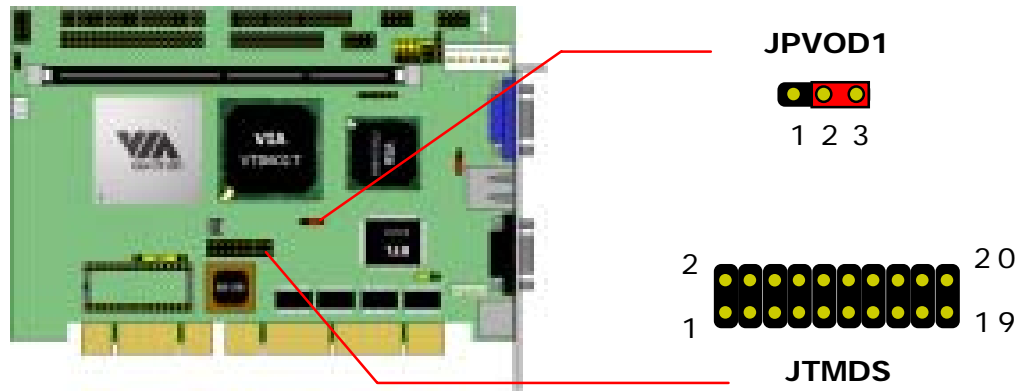

Jumper: JPVOD1  
Type: onboard 3-pin header

JPVOD1	TMDS Panel Voltage Setting
1-2	+5V
2-3	+3.3V

Default setting

Connector: JTMDS  
Type: 20-pin header

Pin	Description	Pin	Description
1	TX1+	2	TX1-
3	SHLD1	4	SHLDC
5	TXC+	6	TXC-
7	Ground	8	+5V
9	N/C	10	N/C
11	TX2+	12	TX1+
13	SHLD2	14	SHLDC
15	TX0+	16	TX0-
17	N/C	18	N/C
19	DDC_Data	20	DDC_Clock



---

## 2.8 Ethernet Interface

The board integrated with dual RTL8100 Fast Ethernet controller, provides the 10Base-T/100Base-TX auto-switching Fast Ethernet interface with full duplex and IEEE 802.3U compliant, connects with RJ45 connector on bracket. The LAN function can enable or disable by jumper JLAN.

Jumper: JLAN

Type: onboard 3-pin header

JLAN	LAN Enable / Disable Setting
1-2	Enable
2-3	Disable

Default setting

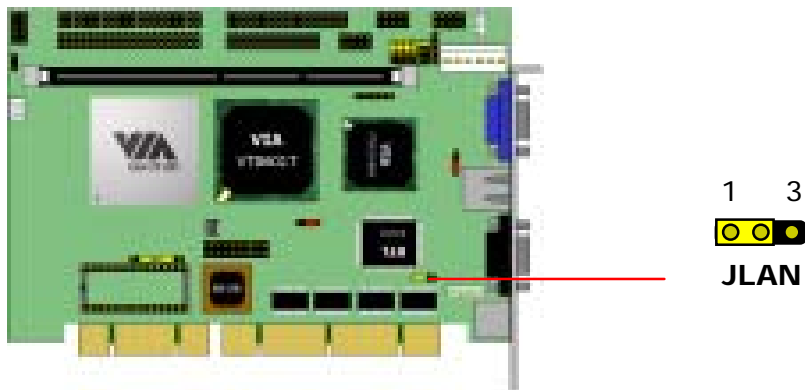

## 2.9 Audio Interface

The board integrates with AC97 3D audio interface with VIA686B built-in audio controller and ALC201A codec, provides line-in, line-out, Mic-in, and CD-in interfaces.

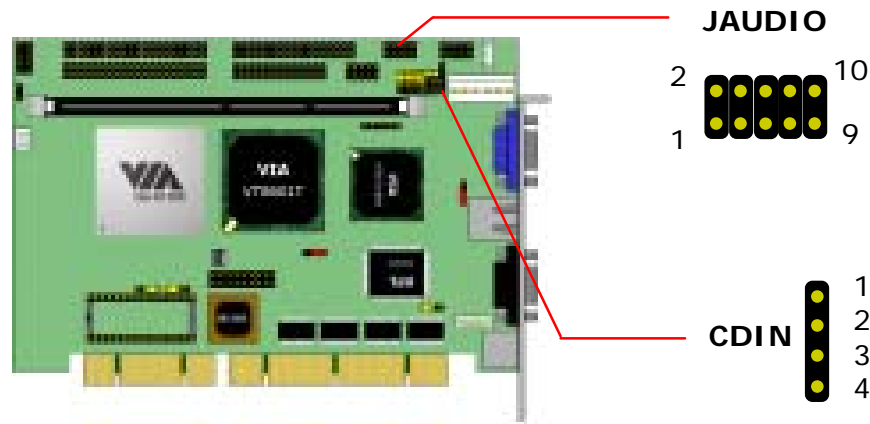

Connector: JAUDIO  
Type: 10-pin header

Pin	Description	Pin	Description
1	Line – Right	2	Ground
3	Line – Left	4	MIC
5	MIC	6	Ground
7	N/C	8	Line Out – Left
9	Line Out – Right	10	Ground

Connector: CDIN  
Type: 4-pin header

Pin	Description
1	CD – Left
2	Ground
3	Ground
4	CD – Right

## 2.10 Serial Port COM2 Mode Configuration

The board offers two serial ports including one RS232 COM1 and one jumper selectable RS232/422/485 COM2. The configuration of COM2 can be setting with jumpers JCOM2 (J2) and JCOM1 (J1).

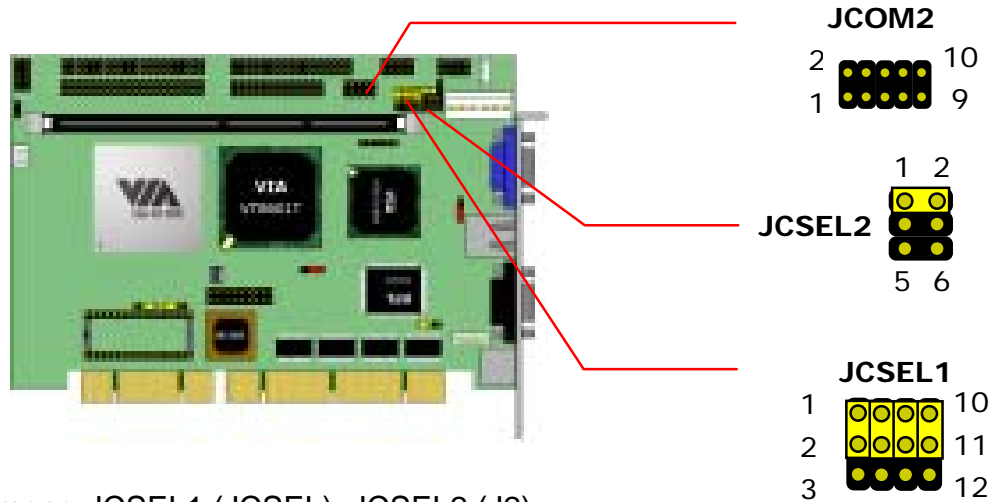

Jumper: JCOM1 (J1), JCOM2 (J2)  
Type: onboard 6-, 12-pin header

COM2 Mode	JCOM2 (J2)	JCOM1 (J1)
RS-232	1-2	1-2/4-5/7-8/10-11
RS-422	5-6	2-3/5-6/8-9/11-12
RS-485	3-4	2-3/5-6/8-9/11-12

Default setting

Connector: JCOM2  
Type: 10-pin header

Pin	RS232	RS422	RS485	Pin	RS232	RS422	RS485
1	DCD	TX-	485-	2	RXD	TX+	485+
3	TXD	RX+	N/C	4	DTR	RX-	N/C
5	Ground	N/C	N/C	6	DSR	N/C	N/C
7	RTS	N/C	N/C	8	CTS	N/C	N/C
9	RI	N/C	N/C	10	N/C	N/C	N/C

## 2.11 Switches and Indicators

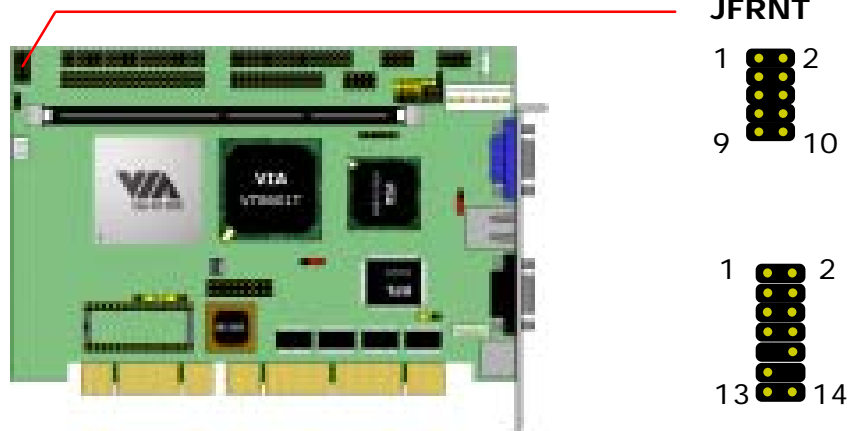

Connector: JFRNT (Type-I)  
Type: onboard 10-pin header

Pin	Description	Pin	Description	Function
1	Ground	2	Vcc	Power LED
3	Active	4	Vcc	HDD LED
5	Reset	6	Ground	Reset
7	PWR BN	8	Ground	Power Button
9	Speaker	10	Vcc	Speaker

10-pin JFRNT includes additional speaker and power LED cables in the packing list.

Connector: JFRNT (Type-II)  
Type: onboard 14-pin header

Function	Signal	PIN	Signal	Function
IDE LED	Vcc (+)	1	2	Power LED
	Active	3	4	
Reset	Reset	5	6	Speaker
	GND	7	8	
	N/C	9	10	
Power Button	PWRBT	11	12	Speaker
	GND	13	14	

---

## Chapter 3. BIOS Setup

The single board computer uses the Award BIOS for the system configuration. The Award BIOS in the single board computer is a customized version of the industrial standard BIOS for IBM PC AT-compatible computers. It supports Intel x86 and compatible CPU architecture based processors and computers. The BIOS provides critical low-level support for the system central processing, memory and I/O sub-systems.

The BIOS setup program of the single board computer let the customers modify the basic configuration setting. The settings are stored in a dedicated battery-backed memory, NVRAM, retains the information when the power is turned off. If the battery runs out of the power, then the settings of BIOS will come back to the default setting.

The BIOS section of the manual is subject to change without notice and is provided here for reference purpose only. The settings and configurations of the BIOS are current at the time of print, and therefore they may not be exactly the same as that displayed on your screen.

To activate CMOS Setup program, press < DEL > key immediately after you turn on the system. The following message “Press DEL to enter SETUP” should appear in the lower left hand corner of your screen. When you enter the CMOS Setup Utility, the Main Menu will be displayed as **Figure 3-1**. You can use arrow keys to select your function, press < Enter > key to accept the selection and enter the sub-menu.

**Figure 3-1.** CMOS Setup Utility Main Screen

Phoenix – Award BIOS CMOS Setup Utility

>Standard CMOS Features	>Frequency/Voltage Control
>Advanced BIOS Features	Load Fail-Safe Defaults
>Advanced Chipset Features	Load Optimized Defaults
>Integrated Peripherals	Set Supervisor Password
>Power Management Setup	Set User Password
>PnP / PCI Configurations	Save & Exit Setup
>PC Health Status	Exit Without Saving
Esc : Quit	↑ ↓ → ← : Select Item
F10 : Save & Exit Setup	

---

**Notes** (This page left blank intentionally)



---

## Chapter 4. Driver Installation

The driver CD offers auto-run menu. It will detect and select the type of single board computer and helps you install the drivers automatically.

### 4.1 Install Board's Software

The selection helps you install the drivers of chipset. It will detect your version of OS automatically.

### 4.2 Install Ultra ATA IDE Driver

The selection helps you to install the driver of IDE interface.

### 4.3 Install VGA Driver

The selection helps you to install the driver of onboard VGA interface.

### 4.4 Install LAN Driver

The selection helps you to install the driver of onboard LAN interface.

### 4.5 Install Audio Driver

The selection helps you to install the driver of onboard audio interface.

### 4.6 Link to < Website > Homepage

The selection help you to link to the website to find the updated technical documents and download directly.

### 4.7 Browse this CD

The selection helps you to find the drivers in this CD directly.

---

**Notes** (This page left blank intentionally)





---

# Appendix A. System Resources

## A.1 I/O Port Address Map

Address Range	Device
0x0022-0x003F	PCI bus
0x0044-0x0047	PCI bus
0x004C-0x006F	PCI bus
0x0072-0x007F	PCI bus
0x0090-0x0091	PCI bus
0x0093-0x009F	PCI bus
0x00A2-0x00BF	PCI bus
0x00E0-0x00EF	PCI bus
0x0100-0x0CF7	PCI bus
0x0D00-0xFFFF	PCI bus
0x03B0-0x03BB	VIA CPU to AGP Controller
0x03B0-0x03BB	VIA Tech VT8361/VT8601 Graphics Controller 5.12.01.3105
0x03C0-0x03DF	VIA CPU to AGP Controller
0x03C0-0x03DF	VIA Tech VT8361/VT8601 Graphics Controller 5.12.01.3105
0x0A79-0x0A79	ISAPNP Read Data Port
0x0279-0x0279	ISAPNP Read Data Port
0x0274-0x0277	ISAPNP Read Data Port
0xD000-0xD00F	VIA Bus Master IDE Controller
0x01F0-0x01F7	Primary IDE Channel
0x03F6-0x03F6	Primary IDE Channel
0x0170-0x0177	Secondary IDE Channel
0x0376-0x0376	Secondary IDE Channel
0xD400-0xD41F	VIA USB Universal Host Controller
0xDC00-0xDCFF	Avance AC'97 Audio for VIA (R) Audio Controller
0xE000-0xE003	Avance AC'97 Audio for VIA (R) Audio Controller
0xE400-0xE403	Avance AC'97 Audio for VIA (R) Audio Controller
0xE800-0xE8FF	Realtek RTL8139(A) PCI Fast Ethernet Adapter
0x0020-0x0021	Programmable interrupt controller
0x00A0-0x00A1	Programmable interrupt controller
0x0040-0x0043	System timer
0x0000-0x000F	Direct memory access controller
0x0081-0x0083	Direct memory access controller
0x0087-0x0087	Direct memory access controller
0x0089-0x008B	Direct memory access controller

---

0x008F-0x0091	Direct memory access controller
0x00C0-0x00DF	Direct memory access controller
0x0060-0x0060	PC/AT Enhanced PS/2 Keyboard (101/102-Key)
0x0064-0x0064	PC/AT Enhanced PS/2 Keyboard (101/102-Key)
0x0378-0x037F	Printer Port (LPT1)
0x03F8-0x03FF	Communications Port (COM1)
0x02F8-0x02FF	Communications Port (COM2)
0x03F0-0x03F5	Standard floppy disk controller
0x03F7-0x03F7	Standard floppy disk controller
0x0061-0x0061	System speaker
0x0070-0x0071	System CMOS/real time clock
0x00F0-0x00FF	Numeric data processor

---

---

## A.2 Memory Address Map

<b>Range</b>	<b>Device</b>
0xA0000-0xBFFFF	PCI bus
0xA0000-0xBFFFF	VIA CPU to AGP Controller
0xA0000-0xBFFFF	VIA Tech VT8361/VT8601 Graphics Controller 5.12.01.3105
0xCC000-0xEFFFF	PCI bus
0x1F80000-0xFFFFEFFF	PCI bus
0xE400000-0xE6FFFFFF	VIA CPU to AGP Controller
0xE000000-0xE3FFFFFF	VIA CPU to AGP Controller
0xE580000-0xE5FFFFFF	VIA Tech VT8361/VT8601 Graphics Controller 5.12.01.3105
0xE600000-0xE601FFFF	VIA Tech VT8361/VT8601 Graphics Controller 5.12.01.3105
0xE500000-0xE57FFFFFF	VIA Tech VT8361/VT8601 Graphics Controller 5.12.01.3105
0xE700000-0xE70000FF	Realtek RTL8139(A) PCI Fast Ethernet Adapter
0x0000-0x9FFFF	System board
0xFFFE0000-0xFFFFFFFF	System board
0xFEE00000-0xFEE0FFFF	System board
0x100000-0xFFFFFFF	System board
0xF0000-0xF3FFF	Motherboard resources
0xF4000-0xF7FFF	Motherboard resources
0xF8000-0xFBFFF	Motherboard resources
0xFC000-0xFFFFF	Motherboard resources

---

---

## A.3 System IRQ and DMA Resource

### A.3.1 IRQ

Range	Device
0	System timer
1	Standard 101/102-Key or Microsoft Natural Keyboard
2	Programmable interrupt controller
3	Communications Port (COM2)
4	Communications Port (COM1)
5	Avance AC'97 Audio for VIA (R) Audio Controller
6	Standard Floppy Disk Controller
7	Printer Port (LPT1)
8	System CMOS/real time clock
9	(free)
10	VIA Tech VT8361/VT8601 Graphics Controller 4.12.01.3105
11	Realtek RTL8139(A/B/C/8130) PCI Fast Ethernet NIC
11	VIA Tech 3038 PCI to USB Universal Host Controller
12	PS/2 Compatible Mouse Port
13	Numeric data processor
14	Primary IDE controller (dual fifo)
14	VIA Bus Master PCI IDE Controller
15	Secondary IDE controller (dual fifo)
15	VIA Bus Master PCI IDE Controller

### A.3.2 DMA

Range	Device
0	(free)
1	(free)
2	Standard Floppy Disk Controller
3	(free)
4	Direct memory access controller
5	(free)
6	(free)
7	(free)

---

# Appendix B. Flash the BIOS

## B.1 BIOS Auto Flash Tool

The board is based on Award BIOS and can be updated easily by the BIOS auto flash tool. You can download the tool online at the address below:

<http://www.award.com>

<http://www.commell.com.tw/Support/Support.htm>

File name of the tool is “awdf flash.exe”, it’s the utility that can write the data into the BIOS flash ship and update the BIOS.

## B.2 Flash Method

1. Get the “.bin” file including the image of new BIOS you want to update.
2. Power on the system and flash the BIOS.
3. Re-star the system.

Any question about the BIOS re-flash please contact your distributors or visit the web-site at below:

<http://www.commell.com.tw/Support/Support.htm>

---

**Notes** (This page left blank intentionally)



---

# Appendix C. I/O Port Pin Assignment

## C.1 IDE Port

Connector: IDE1, IDE2

Type: 40-pin header



Pin	Description	Pin	Description
1	Reset	2	Ground
3	D7	4	D8
5	D6	6	D9
7	D5	8	D10
9	D4	10	D11
11	D3	12	D12
13	D2	14	D13
15	D1	16	D14
17	D0	18	D15
19	Ground	20	N/C (Vcc)
21	REQ	22	Ground
23	IOW-/STOP	24	Ground
25	IOR-/HDMARDY	26	Ground
27	IORDY/DDMARDY	28	IDESEL
29	DACK-	30	Ground
31	IRQ	32	N/C
33	A1	34	CBLID
35	A0	36	A2
37	CS0 (MASTER CS)	38	CS1 (SLAVE CS)
39	LED ACT-	40	Ground

Note: The pin-20 of IDE1 is jumper selectable as +5V Vcc for the DOM (DiskOnModule) or DiskOnChip IDE Pro flash disk without the additional power cable.

---

## C.2 Floppy Port

Connector: FDD

Type: 34-pin header

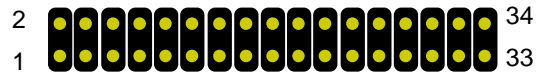

Pin	Description	Pin	Description
1	Ground	2	DRIVE DENSITY SELECT 0
3	Ground	4	DRIVE DENSITY SELECT 1
5	Ground	6	N/C
7	Ground	8	INDEX-
9	Ground	10	MOTOR ENABLE A-
11	Ground	12	DRIVER SELECT B-
13	Ground	14	DRIVER SELECT A-
15	Ground	16	MOTOR ENABLE B-
17	Ground	18	DIRECTION-
19	Ground	20	STEP-
21	Ground	22	WRITE DATA-
23	Ground	24	WRITE GATE-
25	Ground	26	TRACK 0-
27	Ground	28	WRITE PROTECT-
29	Ground	30	READ DATA-
31	Ground	32	HEAD SELECT-
33	Ground	34	DISK CHANGE-



---

## C.3 Parallel Port

Connector: PRINTER

Type: 26-pin header



Pin	Description	Pin	Description
1	STROBE-	14	AUTO FEED-
2	D0	15	ERROR-
3	D1	16	INITIALIZE-
4	D2	17	SELECT INPUT-
5	D3	18	Ground
6	D4	19	Ground
7	D5	20	Ground
8	D6	21	Ground
9	D7	22	Ground
10	ACKNOWLEDGE-	23	Ground
11	BUSY	24	Ground
12	PAPER EMPTY	25	Ground
13	SELECT+	26	N/C

---

## C.4 RS-232 Serial Port

### C.4.1 Onboard RS-232 Serial Port

Connector: JCOM2  
Type: 10-pin header

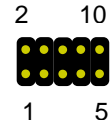

Pin	Description	Pin	Description
1	DCD	2	RXD
3	TXD	4	DTR
5	Ground	6	DSR
7	RTS	8	CTS
9	RI	10	N/C

### C.4.2 On Bracket RS-232 Serial Port

Connector: COM1  
Type: 9-pin D-sub male connector on bracket

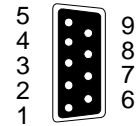

Pin	Description	Pin	Description
1	DCD	2	RXD
3	TXD	4	DTR
5	Ground	6	DSR
7	RTS	8	CTS
9	RI		

---

## C.5 USB Port

Connector: USB

Type: 10-pin header for dual USB Ports

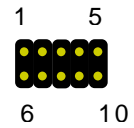

Pin	Description	Pin	Description
1	Vcc	6	Vcc
2	Data0-	7	Data1-
3	Data0+	8	Data2+
4	Ground	9	Ground
5	Ground	10	Ground

## C.6 IrDA Port

Connector: SIR

Type: 5-pin header for SIR Ports



Pin	Description
1	Vcc
2	N/C
3	IRRX
4	Ground
5	IRTX

## C.7 VGA Port

Connector: VGA

Type: 15-pin D-sub female connector on bracket

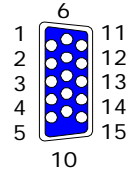

Pin	Description	Pin	Description	Pin	Description
1	RED	6	Ground	11	N/C
2	GREEN	7	Ground	12	VDDAT
3	BLUE	8	Ground	13	HSYNC
4	N/C	9	Vcc	14	VSYNC
5	Ground	10	Ground	15	VDCLK

## C.8 LAN Port

Connector: LAN\_CON1

Type: RJ45 connector on bracket

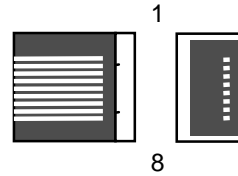

Pin	1	2	3	4	5	6	7	8
Description	TX+	TX-	RX+	N/C	N/C	RX-	N/C	N/C

---

## C.9 AT Keyboard Port

Connector: JAT\_KB  
Type: 5-pin box header



Pin	1	2	3	4	5
Description	CLK	DATA	N/C	Ground	Vcc

## C.10 PS/2 Keyboard and Mouse Port

Connector: PS2  
Type: 6-pin MiniDIN connector on bracket

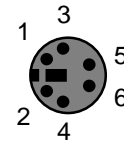

Pin	1	2	3	4	5	6
Description	KBD	MSD	Ground	N/C	KBC	MSC

Note: The PS/2 connector supports standard PS/2 keyboard directly or both PS/2 keyboard and mouse through the PS/2 Y-type cable. The cable is the standard one in the packing list