

HE-B73

PICMG 1.3 Half-size CPU Card

User's Manual

Edition 1.2
2021/11/18

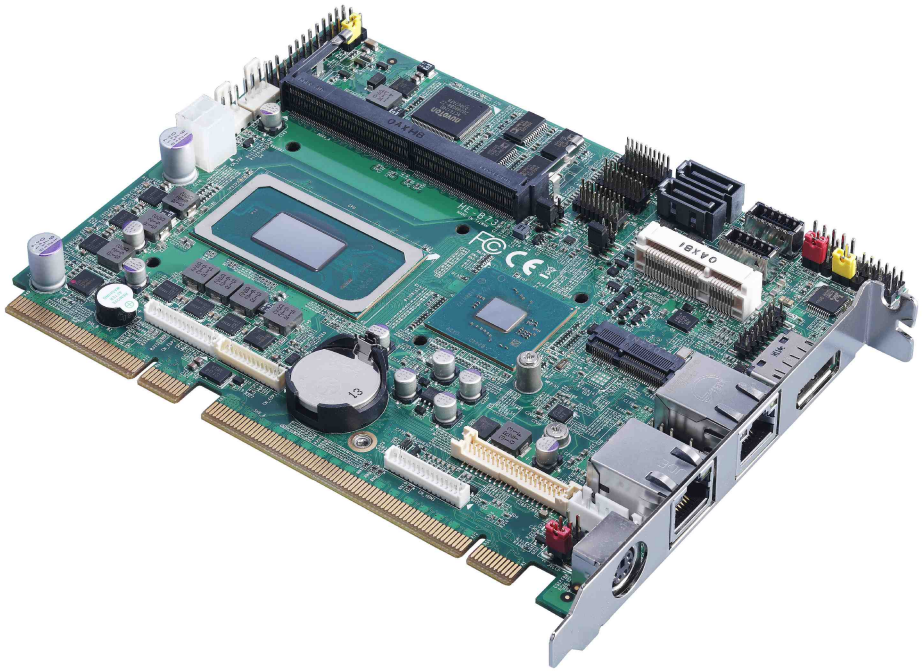

Copyright

Copyright 2021, all rights reserved. This document is copyrighted and all rights are reserved. The information in this document is subject to change without prior notice to make improvements to the products.

This document contains proprietary information and protected by copyright. No part of this document may be reproduced, copied, or translated in any form or any means without prior written permission of the manufacturer.

All trademarks and/or registered trademarks contains in this document are property of their respective owners.

Disclaimer

The company shall not be liable for any incidental or consequential damages resulting from the performance or use of this product.

The company does not issue a warranty of any kind, express or implied, including without limitation implied warranties of merchantability or fitness for a particular purpose.

The company has the right to revise the manual or include changes in the specifications of the product described within it at any time without notice and without obligation to notify any person of such revision or changes.

Trademark

All trademarks are the property of their respective holders.

Any questions please visit our website at <http://www.commell.com.tw>

Packing List:

Please check the package content before you starting using the board.



1 x HE-B73 PICMG 1.3 Half-size CPU Card
(include Cooler Fan)

[Appendix G](#)

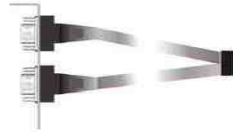

1 x Dual COM PORT Cable
(OALES-BKU2) / (1040087)

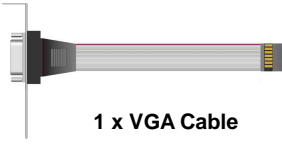

1 x VGA Cable
(OALVGA-S-7) / (1040556)



2 x SATA Cable
(OALSATA3-L) / (1040529)

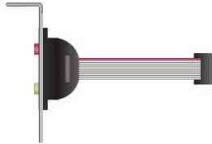

1 x Audio Cable
(OALPJ-HD) / (1040120)



1 x PS/2 Keyboard & Mouse Cable
(OALPS2/MKN) / (1040551)

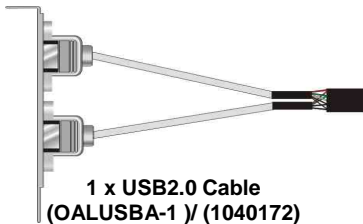

1 x USB2.0 Cable
(OALUSBA-1) / (1040172)



1 x Driver CD
(Including User's Manual)



1 x USB3.2 Gen2 Cable (Optional)
(OALUSBE-USBC-L30 / 1040681)



1 x DVI Cable (Optional)
(BADPDVIP_A & OALDVI-MX15-L15)
(4120008021 & 1040683)

Index

Chapter 1 <Introduction>.....	4
1.1 <Product Overview>.....	4
1.2 <Product Specification>	5
1.3 <Block Diagram>.....	6
Chapter 2 <Hardware setup>	7
2.1 <Connector Location and Reference>	7
2.1.1 <Internal connectors list>	8
2.1.2 <External connectors list>	8
2.2 <Memory Setup>.....	9
2.3 <Jumper Location and Reference>	10
2.3.1 <Jumper list>	10
2.3.2 <Clear CMOS and Power on type selection>.....	11
2.4 <I/O interface>	11
2.4.1 <Serial ATA interface>	11
2.4.2 <Ethernet interface>.....	12
2.4.3 <Display interface>	12
2.4.4 <Serial Port interface>	16
2.4.5 <USB interface>.....	18
2.4.6 <Audio interface>	19
2.4.7 <Expansion slot>.....	20
2.4.8 <Front panel switch and indicator>	21
2.4.9 <GPIO and Other interface>	22
2.5 <Power supply>	24
2.5.1 <Power input>	24
Appendix A <Flash BIOS>.....	25
Appendix B <LCD Panel Type select>	26
Appendix C <Programmable Watch Dog Timer>.....	27
Appendix D <Hardware Monitor>	29
Appendix E <Programmable GPIO>	30
Appendix F <RAID Setting>	31
Appendix G <Cooler fan>.....	32
Contact information	33

Chapter 1 <Introduction>

1.1 <Product Overview>

HE-B73 is a PICMG 1.3 Half-size CPU Card which supports Tiger Lake/11th Gen H Processors, integrated UHD Graphics, DDR4 memory, Realtek High Definition Audio, Intel Gigabit LAN, USB3.2 Gen2, SATA3 with AHCI function for a system.

New feature for Tiger Lake H

Tiger Lake/11th Gen H Processors are based on the 10nm SuperFin process, and offer long-life availability. They have Intel UHD Graphics up to 32 EUs.

All in One multimedia solution

The board provides one MiniPCIe slot (support mSATA), one M.2 2230 slot, one M.2 2280 slot (PCIe Gen4).

Tiger Lake support Windows10 version 20H2 64bit and Linux kernel 5.8

Intel recommends using Windows 10 version 20H2 64bit. It may lose some drivers if you use other Windows version.

1.2 <Product Specification>

System

Processor	Tiger Lake/11th Gen H Processor FCBGA1787 package
Chipset	Intel® QM580E / RM590E (TGL-H Xeon CPUs have to use RM590E)
Memory	2 x DDR4 SO-DIMM 3200 MHz up to 64GB, Support Non-ECC, unbuffered memory (TGL-H Xeon CPUs can support ECC memory)
Watchdog Timer	Generates a system reset with internal timer for 1min/s ~ 255min/s
Real Time Clock	Chipset integrated RTC with onboard lithium battery
Expansion	1 x MiniPCIe with SIM slot (support mSATA) 1 x M.2 2280 Key M support PCIe Gen4 and SATA 1 x M.2 2230 Key E for Wi-Fi and Bluetooth 1 x PCIe X16 slot (Backplane) 4 x PCIe X1 slot or 1 x PCIe X4 slot (Backplane) (Optional)

Graphics

Chipset	Intel® 11th Gen integrated UHD Graphics
Display Interface	1 x LVDS (Note1), 1 x DVI(Note5), 1 x DisplayPort(Note2), 1 x VGA

LAN

Chip	1 x Intel® I219-LM Gigabit PHY LAN (Support iAMT 15.0) 1 x Intel® I225-LM Gigabit LAN (up to 2.5GbE)
------	---

I/O

Serial ATA	2 x SATA3
Audio	Realtek ALC888S HD Audio
Internal I/O	1 x VGA, 1 x DVI(Note5), 1 x Audio, 1 x GPIO, 2 x SATA3, 4 x RS232, 2 x RS232/RS422/RS485, 1 x SMBus, 2 x USB3.2 Gen2 (Type E), 4 x USB2.0, 1 x LVDS, 1 x LCD inverter connector
Rear I/O	1 x DisplayPort, 2 x LAN, 1 x PS/2

Mechanical & Environmental

Power Requirement	Standard 24-pin ATX power from Backplane
Size	168mm x 126mm (L x W)
Temperature	Operating within 0°C~60°C (32°F~140°F) (Note3) Storage within -20°C~80°C (-4°F~176°F)
Relative Humidity	10%~90%, non-condensing

Note1: Onboard 18/24-bit single/dual channel +3.3V/ +5V/ +12V LVDS

Note2: Add ADP-3355 supports 2nd VGA or Add ADP-3460 supports 2nd LVDS.

Note3: W-11865MRE, W-11555MRE, W-11155MRE can operate within -40°C~85°C

Note4: Please don't remove cooler fan, it's will destroy thermal paste on CPU.

Note5: DVI cable is optional.

1.3 <Block Diagram>

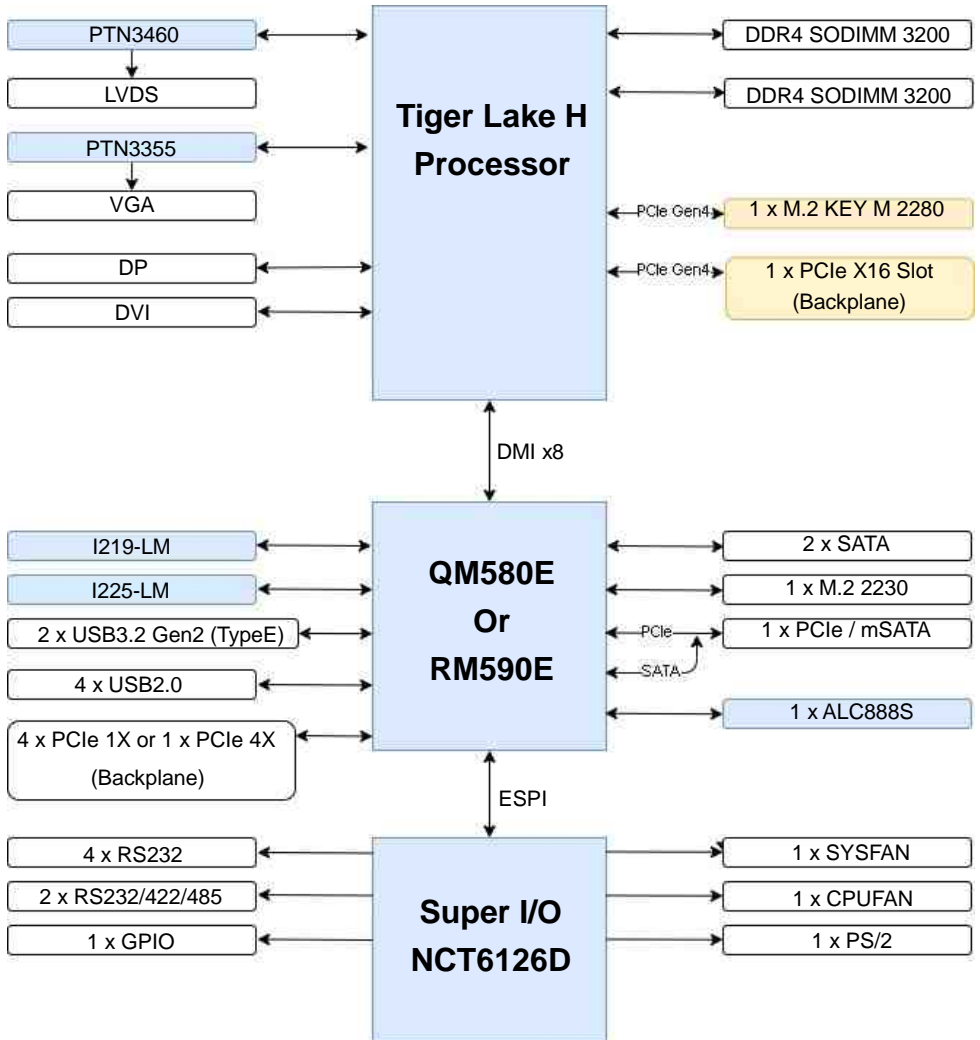

Chapter 2 <Hardware setup>

2.1 <Connector Location and Reference>

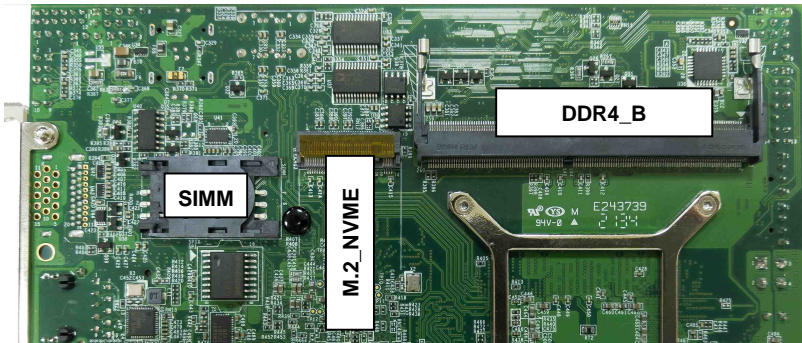
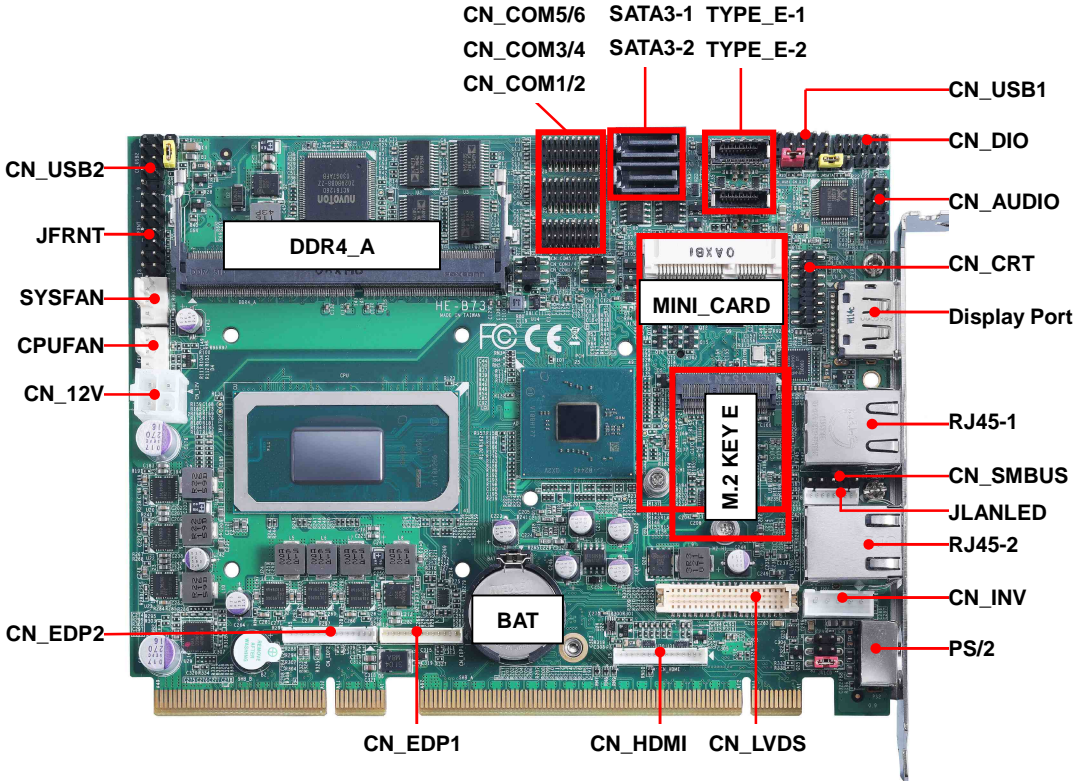

2.1.1 <Internal connectors list>

Connector	Function
DDR4_A/B	260-pin DDR4 SO-DIMM slot
SATA3-1/ 3-2	7-pin SATA3 connector
CN_AUDIO	5 x 2-pin audio pin header
CN_LVDS	20 x 2-pin LVDS connector
CN_INV	5-pin LCD inverter connector
CN_SMBUS	5-pin SMBus connector
CN_COM1/2	20-pin RS232/RS422/RS485 connector
CN_COM3/4/5/6	20-pin RS232 connector
CN_USB1/2	5 x 2-pin USB2.0 pin header
CN_DIO	6 x 2-pin digital I/O connector
CN_EDP1	13-pin eDP connector (Optional)
CN_EDP2	15-pin eDP connector (Optional)
CN_HDMI	15-pin DVI connector
CPUFAN	4-pin CPU fan connector
SYSFAN	4-pin system fan connector
JLANLED	8-pin RJ45-1/2 LED
SIMM	6-pin socket
JFRNT	10-pin front panel switch/indicator connector
TYPE_E-1/2	20-pin Type E USB3.2 Gen2 connector
MINI_CARD	52-pin MiniPCle card slot
M2	75-pin M.2 Key E slot
M2_NVME	75-pin M.2 Key M slot support PCIe Gen4 and SATA
CN_12V	4-pin power input Terminal Block

2.1.2 <External connectors list>

Connector	Function
DisplayPort	DisplayPort connector
RJ45-1	RJ45 connector (I219-LM)
RJ45-2	RJ45 connector (I225-LM)
PS/2	PS/2 keyboard and mouse connector

2.2 <Memory Setup>

HE-B73 has 260-pin DDR4 SODIMM support up to 64GB of memory capacity and 1.2 Voltage. The memory frequency supports 3200 MHz. Only Non-ECC memory is supported.

In the process, the board must be powered off.

1. Put the memory tilt into the slot. Note the Memory notch key aligned slot key.
2. Then press down till lock into the mounting notch.

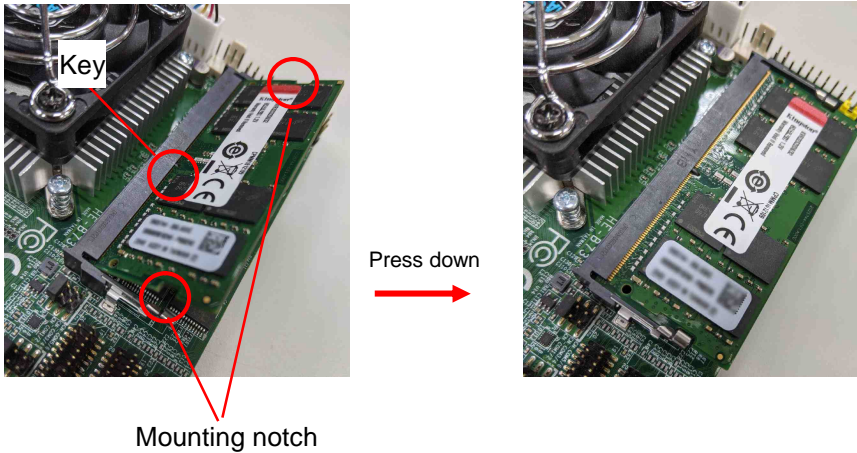

3. To remove the memory, push outward on both sides of the latch.

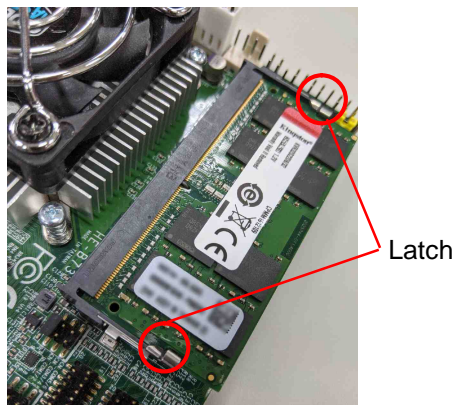

2.3 <Jumper Location and Reference>

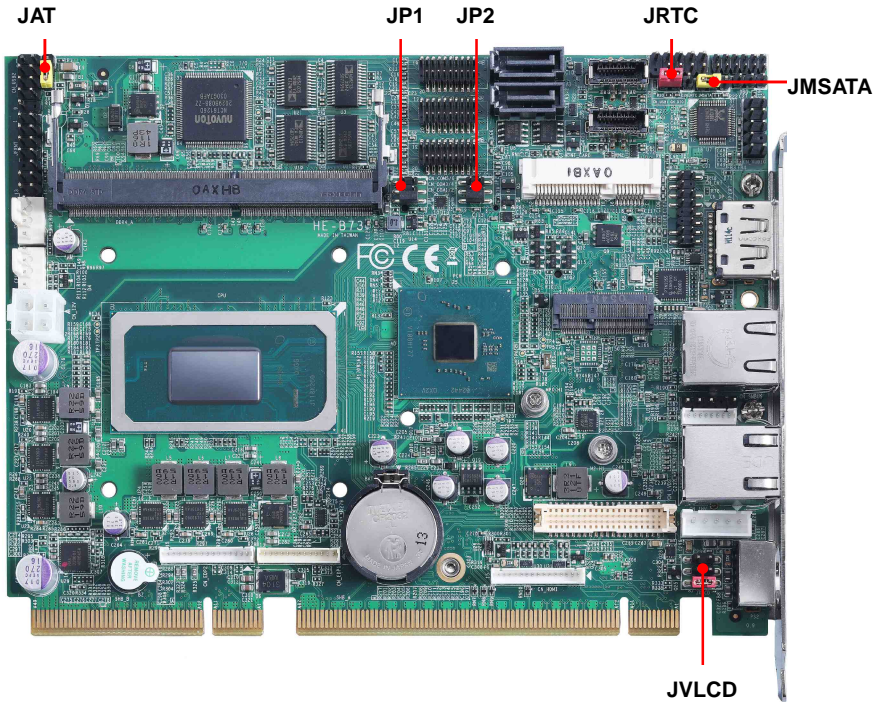

2.3.1 <Jumper list>

Jumper	Function
JAT	Power mode select
JRTC	CMOS Normal/Clear Setting
JVLCD	Panel Voltage Setting
JMSATA	MiniCard mSATA Setting
JP1	COM1 Voltage Setting (For Pin 9)
JP2	COM2 Voltage Setting (For Pin 9)

2.3.2 <Clear CMOS and Power on type selection>

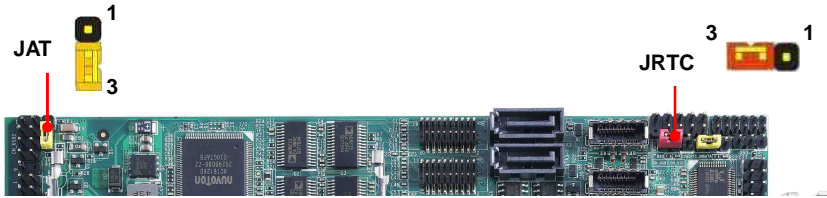

JAT: AT/ATX mode select jumper

Jumper settings	Function
1-2	AT mode
2-3	ATX mode (Default)

JRTC: Clear CMOS data jumper

Jumper settings	Function
1-2	Clear CMOS
2-3	Normal (Default)

2.4 <I/O interface>

2.4.1 <Serial ATA interface>

SATA3-1/2 : SATA3 7-pin connector

Pin	Signal
1	GND
2	TX+
3	TX-
4	GND
5	RX-
6	RX+
7	GND

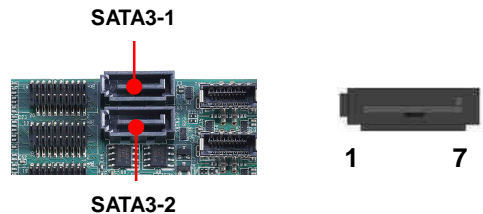

2.4.2 <Ethernet interface>

The board provides I219-LM and I225-LM Gigabit Ethernet which supports WOL on rear I/O. It supports Intel® AMT 15.0 feature on I219-LM.

(Note that the CPU must support vPro technology.)

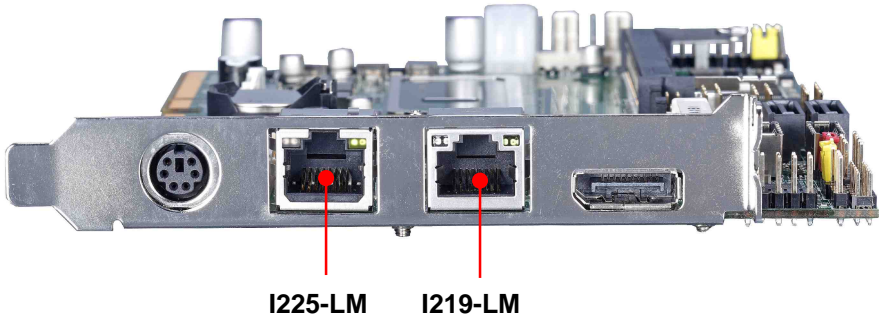

2.4.3 <Display interface>

Based on the 11th Gen CPU with built-in Intel® UHD Graphics, the DisplayPort resolution up to 3840x2160 @ 60Hz or 4096x2304 @ 60Hz, the DVI up to 1920x1080 @ 60Hz and LVDS up to 1920x1200 @ 60Hz supports single bus or dual bus LVDS signaling with color depths of 18 bits or 24 bits. About select LCD Panel Type in BIOS, please refer [Appendix B](#). The built-in UHD Graphics support Quad display function with clone mode and extended mode.



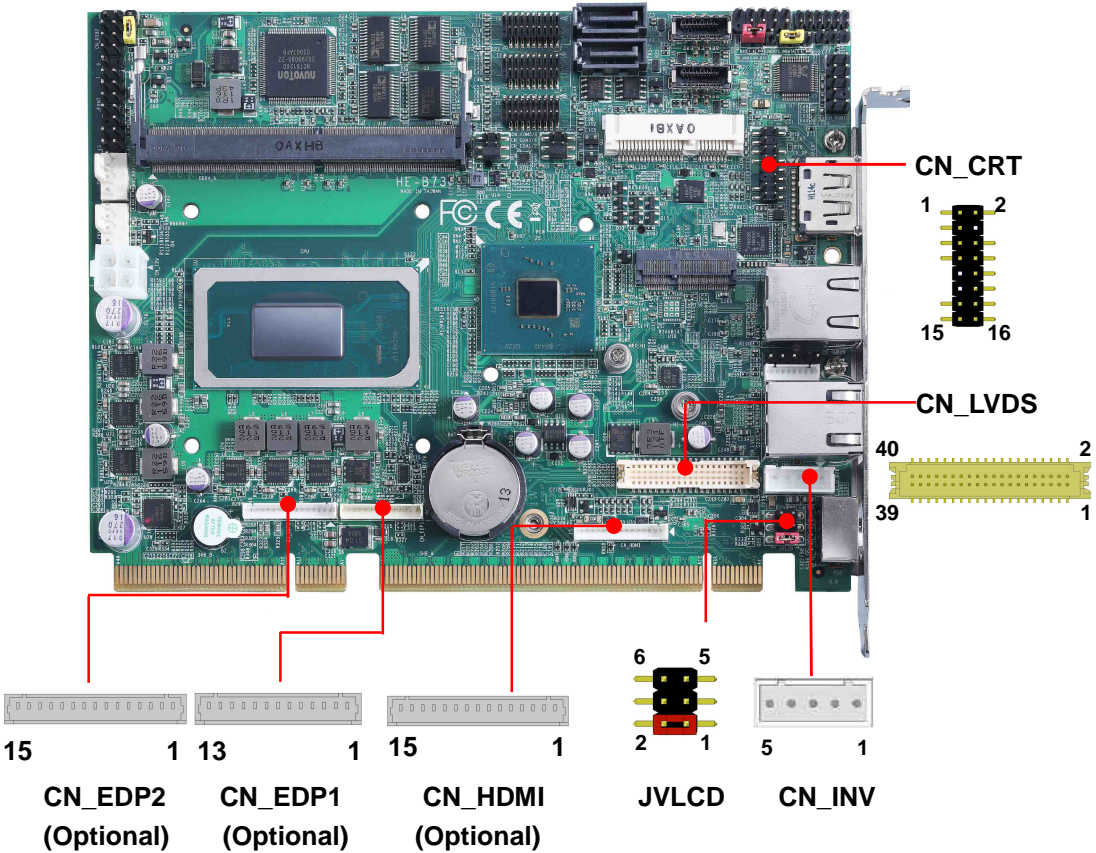

CN_CRT: VGA 16-pin connector (Pitch 2.00 mm)

Pin	Signal	Pin	Signal
1	BR	2	BG
3	BB	4	NC
5	IOGND1	6	IOGND1
7	IOGND1	8	IOGND1
9	NC	10	IOGND1
11	NC	12	5VCDA
13	5HSYNC	14	5VSYNC
15	5VCLK	16	NC

CN_LVDS: LVDS 40-pin connector (Model: HIROSE DF13-40DP-1.25V compatible)

Pin	Signal	Pin	Signal
2	Set by JVLCD	1	Set by JVLCD
4	Detect (Active low)	3	GND
6	A_LVDS_0-	5	B_LVDS_0-
8	A_LVDS_0+	7	B_LVDS_0+
10	GND	9	GND
12	A_LVDS_1-	11	B_LVDS_1-
14	A_LVDS_1+	13	B_LVDS_1+
16	GND	15	GND
18	A_LVDS_2-	17	B_LVDS_2-
20	A_LVDS_2+	19	B_LVDS_2+
22	GND	21	GND
24	A_LVDS_CLK-	23	B_LVDS_3-
26	A_LVDS_CLK+	25	B_LVDS_3+
28	GND	27	GND
30	A_LVDS_3-	29	B_LVDS_CLK-
32	A_LVDS_3+	31	B_LVDS_CLK+
34	GND	33	GND
36	LVDS_DDCSCL	35	NC
38	LVDS_DDCSDA	37	NC
40	NC	39	NC

Pin4 only need to be connected to GND

CN_INV: LVDS 5-pin Backlight power connector

Pin	Signal
1	12V
2	Backlight Control
3	5V
4	GND
5	Enable Backlight

JVLCD: LVDS panel power select jumper

Jumper settings	Function
1-2	3.3V (Default)
3-4	5V
5-6	12V

CN_HDMI: DVI 15-pin connector

Pin	Signal	Pin	Signal
1	TMDS Data2+	9	GND
2	TMDS Data2-	10	TMDS Clock+
3	GND	11	TMDS Clock-
4	TMDS Data1+	12	SCL
5	TMDS Data1-	13	SDA
6	GND	14	5V
7	TMDS Data0+	15	HPD
8	TMDS Data0-		

CN_EDP1: eDP 13-pin connector

Pin	Signal	Pin	Signal
1	EDP0+	8	AUX-
2	EDP0-	9	GND
3	GND	10	EDP_HPDP
4	EDP1+	11	3.3V (EDP power)
5	EDP1-	12	SDA
6	GND	13	SCL
7	AUX+		

CN_EDP2: eDP 15-pin connector

Pin	Signal	Pin	Signal
1	EDP2+	9	GND
2	EDP2-	10	3.3V (EDP power)
3	GND	11	3.3V (EDP power)
4	EDP3+	12	12V (Backlight power)
5	EDP3-	13	12V (Backlight power)
6	GND	14	12V (Backlight power)
7	PWM	15	12V (Backlight power)
8	Enable Backlight		

2.4.4 <Serial Port interface>

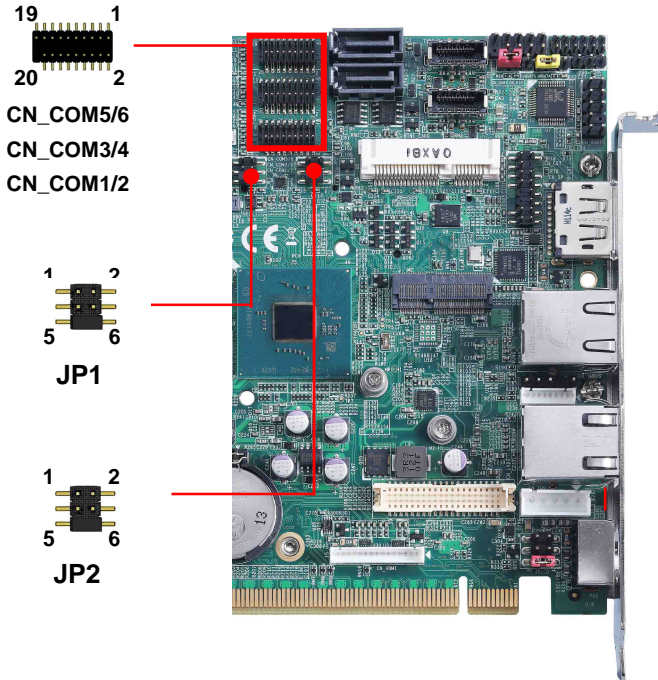

CN_COM1/2: RS232/422/485 20-pin header (Pitch 2.54 x 1.27mm)

Pin	Signal	Pin	Signal
1	DCD1/ 422TX-/ 485-	2	RXD1/ 422TX+/ 485+
3	TXD1	4	DTR1
5	GND	6	DSR1/ 422RX+
7	RTS1	8	CTS1/ 422RX-
9	RI1	10	NC
11	DCD2/ 422TX-/ 485-	12	RXD2/ 422TX+/ 485+
13	TXD2	14	DTR2
15	GND	16	DSR2/ 422RX+
17	RTS2	18	CTS2/ 422RX-
19	RI2	20	Key

COM1 & COM2

RS-232/422/485 can set by BIOS.

You can find the setting from

Advanced-> Motherboard Advanced menu-> Super IO configuration-> Serial Port configuration->Interface

If you want to use RS485, please follow below step before connection.

COM1 RTX- Data- : short Pin1& Pin8

COM1 RTX+ Data+ : short Pin2& Pin6

COM2 RTX- Data-: short Pin1& Pin8

COM2 RTX+ Data+: short Pin2& Pin6

JP1, JP2: COM1, COM2 pin-9 setting

Jumper settings	Function
1-2	5V
3-4	12V
5-6	RI (Default)

Effective patterns of connection:

1-2 / 3-4 / 5-6

Other may cause damage

CN_COM3/4, CN_COM/5/6: RS232 20-pin header (Pitch 2.54 x 1.27mm)

Pin	Signal	Pin	Signal
1	DCD1	2	RXD1
3	TXD1	4	DTR1
5	GND	6	DSR1
7	RTS1	8	CTS1
9	RI1	10	NC
11	DCD2	12	RXD2
13	TXD2	14	DTR2
15	GND	16	DSR2
17	RTS2	18	CTS2
19	RI2	20	Key

2.4.5 <USB interface>

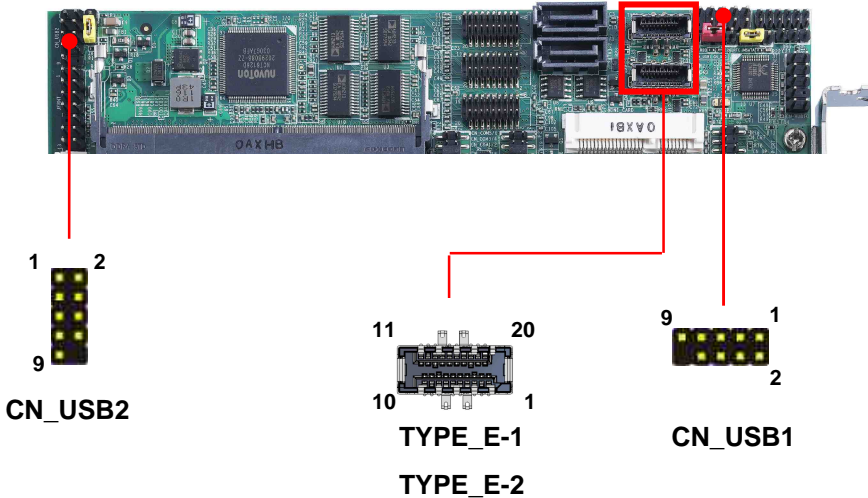

CN_USB1/2: USB2.0 10-pin header (Pitch 2.54 mm)

Pin	Signal	Pin	Signal
1	5VSB	2	5VSB
3	DATA0-	4	DATA1-
5	DATA0+	6	DATA1+
7	GND	8	GND
9	GND	10	Key

TYPE_E: USB3.2 Gen2 20-pin header (Cable optional)

Pin	Signal	Pin	Signal
1	5V	20	N/A
2	USB3.2_Gen2_TX1+	19	USB2.0_DATA+
3	USB3.2_Gen2_TX1-	18	USB2.0_DATA-
4	GND	17	GND
5	USB3.2_Gen2_RX1+	16	USB3.2_Gen2_RX2-
6	USB3.2_Gen2_RX1-	15	USB3.2_Gen2_RX2+
7	5V	14	GND
8	N/A	13	USB3.2_Gen2_TX2-
9	N/A	12	USB3.2_Gen2_TX2+
10	N/A	11	5V

2.4.6 <Audio interface>

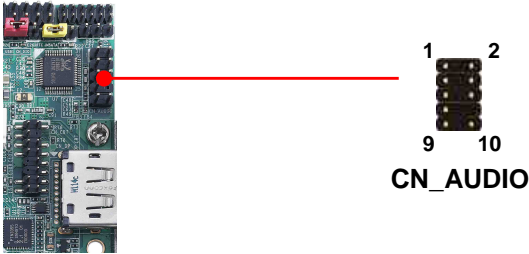

CN_AUDIO: Front panel audio 10-pin header (Pitch 2.54mm)

Pin	Signal	Pin	Signal
1	MIC_L	2	GND
3	MIC_R	4	NC
5	FP_OUT_R	6	MIC_DETECT
7	SENSE	8	Key
9	FP_OUT_L	10	FP_OUT_DETECT

2.4.7 <Expansion slot>

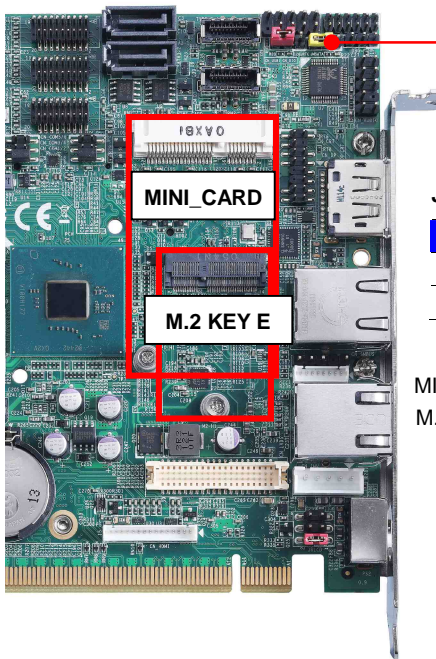

JMSATA

JMSATA: Setting MINI_CARD to support PCIe/mSATA

Settings	Function
1-2	Support mSATA
2-3	Normal operation (Default)

MINI_CARD support mSATA by JMSATA, and connect SIM card
M.2_NVME support PCIe Gen4 and SATA

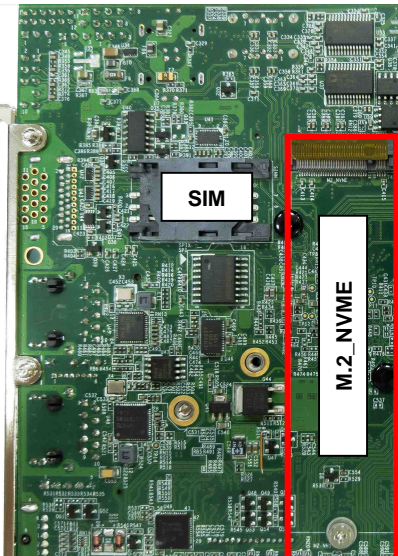

2.4.8 <Front panel switch and indicator>

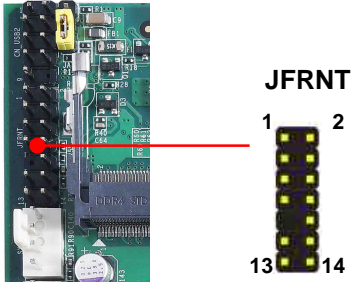

JFRNT: Front panel switch and indicator 14-pin header

Pin	Signal	Pin	Signal
1	HDD_LED+	2	Power_LED+
3	HDD_LED-	4	NC
5	Reset+	6	Power_LED-
7	Reset-	8	Speaker+
9	Key	10	NC
11	Power_ON+	12	NC
13	Power_ON-	14	Speaker-

2.4.9 <GPIO and Other interface>

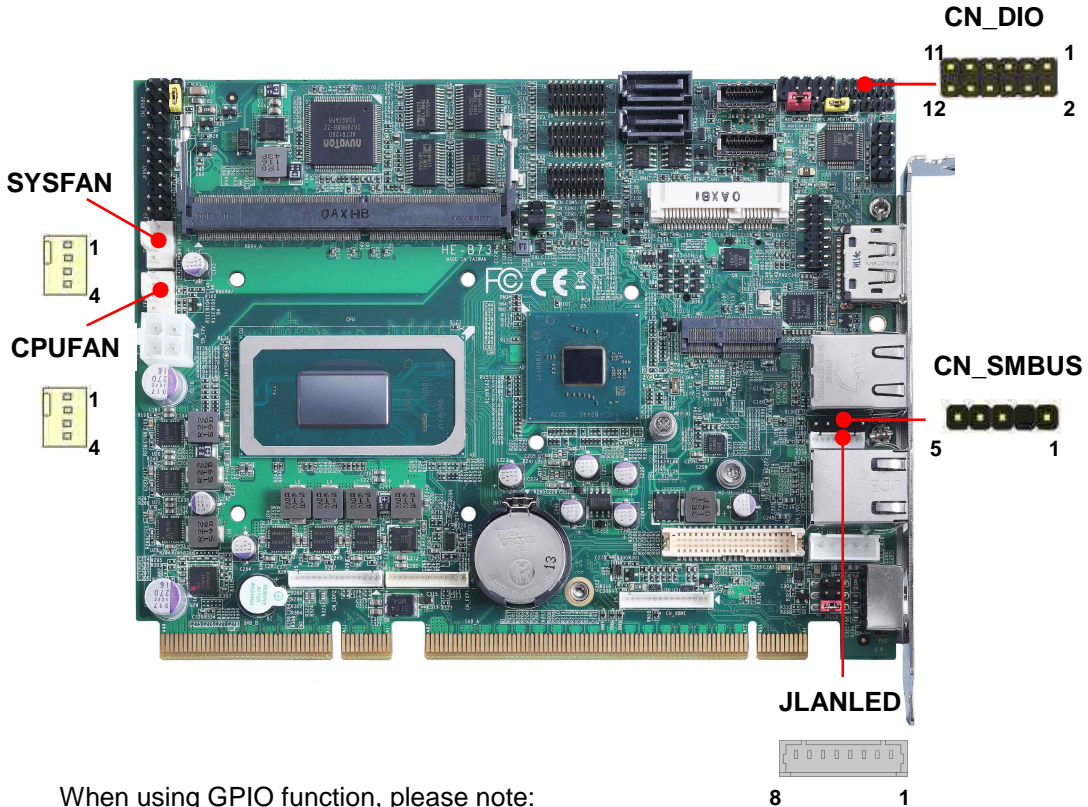

When using GPIO function, please note:

As Output: **Open-drain**, most applications need use an external pull up resistor.

(If not may cause damage)

As Input: **TTL-level**.

GPIO DC characteristics (open drain mode)

Parameter	SYM	MIN	TYP	MAX	UNIT	Conditions
Input Low Voltage	V_{IL}			0.8	V	
Input High Voltage	V_{IH}	2.0			V	
Output Low Voltage	V_{OL}			0.4	V	$I_{OL} = 12\text{mA}$
Input High Leakage	I_{LIH}			+10	μA	$V_{IN} = 3.3\text{V}$
Input Low Leakage	I_{LIL}			-10	μA	$V_{IN} = 0\text{V}$

Please refer to [Appendix E](#) to program the configuration register

CN_DIO: GPIO 12-pin header (Pitch 2.00mm)

Pin	Signal	Pin	Signal
1	GND	2	GND
3	GP40	4	GP44
5	GP41	6	GP45
7	GP42	8	GP46
9	GP43	10	GP47
11	5V	12	12V

CN_SMBUS: SMBus 5-pin connector (Pitch 2.54mm)

Pin	1	2	3	4	5
Signal	5V	NC	SMBDAT	SMBCLK	GND

CPUFAN: CPU cooler fan 4-pin connector

Pin	1	2	3	4
Signal	GND	12V	Sensor	Control

SYSFAN: System cooler fan 4-pin connector

Pin	1	2	3	4
Signal	GND	12V	Sensor	Control

JLANLED: RJ45 LED 8-pin connector

Pin	Signal
1	I219 SPEED LED+ (1G) / I219 SPEED LED- (10/100M)
2	I219 SPEED LED- (1G) / I219 SPEED LED+ (10/100M)
3	I219 ACT LED-
4	I219 ACT LED+
5	I225 SPEED LED+ (2.5G) / I225 SPEED LED- (1G)
6	I225 SPEED LED- (2.5G) / I225 SPEED LED+ (1G)
7	I225 ACT LED-
8	I225 ACT LED+

2.5 <Power supply>

2.5.1 <Power input>

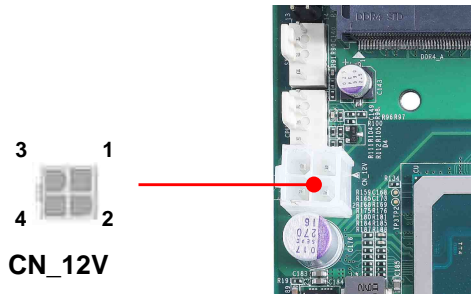

CN_12V: 4-pin 12V connector

Pin	Signal	Pin	Signal
1	GND	2	GND
3	12V	4	12V

Appendix A <Flash BIOS>

A.1 <Flash tool>

The board is based on Phoenix BIOS and can be updated easily by the BIOS auto flash tool. You can download the tool online at the address below:

[FPT Tool](#)

The tool's file name is "FPT.exe", it's the utility that can write the data into the BIOS flash chip and update the BIOS.

A.2 <Flash BIOS process>

- 1.Extract the zip file(re-flash tool and BIOS file) to root of the USB flash drive.
- 2.Insert your USB flash drive in USB port of the board and power on the system.
- 3.Press F5 in the Phoenix Logo screen
- 4.Click the Internal Shell, then input the "fs0:" command to switch to the root of the USB flash drive.
5. Type the " fpt -savemac -f xxx.bin" command to start flash BIOS processes. (xxx.bin means the BIOS file that you want to update)
6. When it finished all update processes, restart the system.

```

UEFI Interactive Shell v2.2
EDK II
UEFI v2.70 (Phoenix Technologies Ltd., 0x12345678)
Mapping table
FS0: Alias(s) :HD0g0b::BLK1:
    PciRoot (0x0)/Pci (0x14,0x0)/USB (0x6,0x0)/HD (1,MBR,0x00260119,0x000,0x1DD1000)
BLK0: Alias(s) :
    PciRoot (0x0)/Pci (0x14,0x0)/USB (0x6,0x0)
Press ESC in 1 seconds to skip startup.nsh or any other key to continue.
Shell> fs0:
FS0:\> fpt -savemac -f 671310.bin_
  
```

Appendix B <LCD Panel Type select>

According your panel, it needs to select the correct resolution in the BIOS. If there is no fit your panel type, please feedback for us to make OEM model.

Find the setting from

Advanced->Motherboard Advanced menu->LVDS Configuration

EDID Panel type: There are 7 resolutions in LCD Panel Type, if your panel is not in the list, please contact tech@commell.com.tw

LVDS Bus: Select Single / Dual channel

Panel Color Depth: Select VESA 24 bit / JEIDA 24 bit / VESA and JEIDA 18 bit

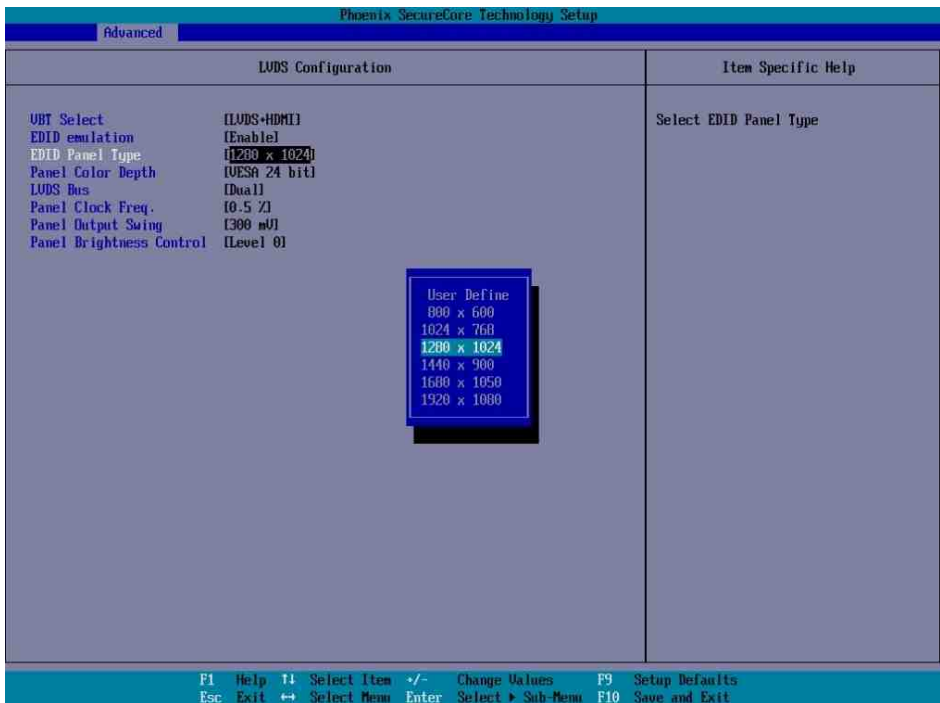

Appendix C <Programmable Watch Dog Timer>

The watchdog timer makes the system auto-reset while it stops to work for a period. The integrated watchdog timer can be setup as system reset mode by program. You can select Timer setting in the BIOS, after setting the time options, the system will reset according to the period of your selection.

Find the setting from

Advanced → Motherboard Advanced Menu → Power Advanced menu →

Watch dog timer select



Program sample

Watchdog timer setup as system reset with 5 second of timeout

```
-o 4E 87      ;enter configuration
-o 4E 87
-o 4E 07
-o 4F 08      ;select Logical Device
-o 4E 30
-o 4F 01      ; activate WDTO# function
-o 4E F0
-o 4F 00      ;set "00" is second mode, set "08" is minute mode
-o 4E F1
-o 4F 05      ;00h: Timeout Disable
                ;01h: Timeout occurs after 1 minute only
                ;02h: Timeout occurs after 2 second/minute
                ;03h: Timeout occurs after 3 second/minute
                ;
                ;FFh: Timeout occurs after 255 second/minute
                (The deviation is approx 1 second.)
```

For further information, please refer to Nuvoton NCT6126D datasheet

Appendix D <Hardware Monitor>

Find the setting from

Advanced-> Motherboard Advanced menu-> Super IO configuration->

└ Hardware Monitor

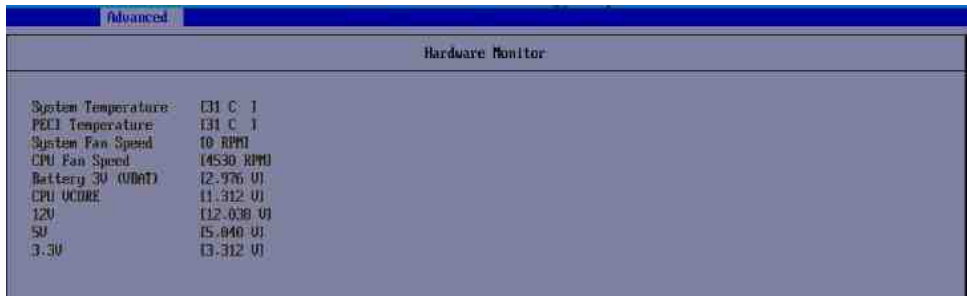

The screenshot shows the 'Advanced' BIOS menu with the 'Hardware Monitor' option selected. The 'Hardware Monitor' screen displays the following system status information:

System Temperature	C31 C: 1
PECI Temperature	C31 C: 1
System Fan Speed	10 RPM
CPU Fan Speed	14530 RPM
Battery SV (VBAT)	12.976 V
CPU VCCORE	11.312 V
V20	112.038 V
V50	15.040 V
V3.30	13.312 V

Appendix E <Programmable GPIO>

The GPIO can be programmed using simple IN/OUT commands.

GPIO	0	1	2	3	4	5	6	7
bit	0	1	2	3	4	5	6	7

- o 4E 87 ;enter configuration
- o 4E 87
- o 4E 07
- o 4F 07 ;select Logical Device
- o 4E 30
- o 4F 10 ;activate GPIO function (The board use GPIO4)
- o 4E F0
- o 4F XX ;set "01" GPIO as input, set "00" GPIO as output
- o 4E F1
- o 4F XX ;if set GPIO as output, this register's value can be set "00~ FF"

Optional

- o 4E F2
- o 4F XX ;set "01", the respective bit are inverted (Both input and output)
- ;set "00", the respective bit are normal

For further information, please refer to Nuvoton NCT6126D datasheet

Appendix F <RAID Setting>

When use RAID function, it need to enter the BIOS set RAID mode first.

Advanced → Intel Advanced menu → SA Configuration → VMD Configuraion →

1. Find VMD controller, and set to enable
2. Set "Map this Root port under VMD" to enable.
3. Set "Intel Optane memory to disabled
4. Press F10 to save.
5. In Misc page, you can find Intel® Rapid Storage Technology,
6. You can see "Create RAID Volume", then choose two disks to create.



Note: if you use two M.2 2280 SSD to create RAID, you have to load driver when install Windows 10.

Appendix G <Cooler fan>

You will see two different cool fans on CPU.

OHS-P-M-L is for high power CPU (Core™ i7-11850HE, Core™ i5-11500HE, Xeon® W-11865MRE, Xeon® W-11555MRE, Xeon® W-11155MRE)



OHS-P-M-L

OHS-P-M-K is for low power CPU (Core™ i3-11100HE, Celeron® 6600HE, Xeon® W-11865MLE, Xeon® W-11555MLE, Xeon® W-11155MLE)

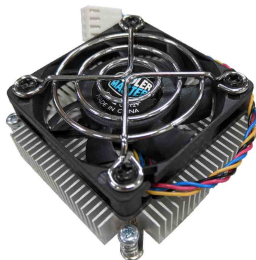

OHS-P-M-K

Contact information

Any advice or comment about our products and service, or anything we can help you please don't hesitate to contact with us. We will do our best to support you for your products, projects and business.

Taiwan Commate computer Inc.

Address	19F., NO.94, Sec. 1, Xintai 5 th Rd., Xizhi Dist., New Taipei City 22102, Taiwan.
TEL	+886-2-26963909
Website	www.commell.com.tw
E-mail	info@commell.com.tw (General information) tech@commell.com.tw (Technical Support)

Commell is a brand name of Taiwan Commate computer Inc.