

# HE-875P

---

Half-size Single Board Computer

## **User's Manual**

Edition 1.1

2009/7/20



## **Copyright**

Copyright 2009. All rights reserved. This document is copyrighted and all rights are reserved. The information in this document is subject to change without prior notice to make improvements to the products.

This document contains proprietary information and protected by copyright. No part of this document may be reproduced, copied, or translated in any form or any means without prior written permission of the manufacturer.

All trademarks and/or registered trademarks contains in this document are property of their respective owners.

## **Disclaimer**

The company shall not be liable for any incidental or consequential damages resulting from the performance or use of this product.

The company does not issue a warranty of any kind, express or implied, including without limitation implied warranties of merchantability or fitness for a particular purpose. The company has the right to revise the manual or include changes in the specifications of the product described within it at any time without notice and without obligation to notify any person of such revision or changes.

## **Trademark**

All trademarks are the property of their respective holders.

---

Any questions please visit our website at <http://www.commell.com.tw>

## Packing List:

Please check the package content before you starting using the board.

### Hardware:

HE-875P Half-size Single Board Computer x 1

### Cable Kit:

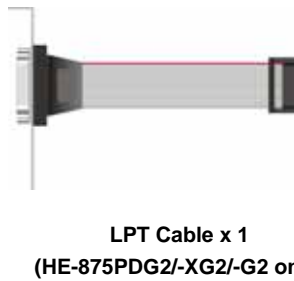
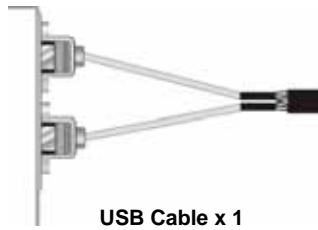
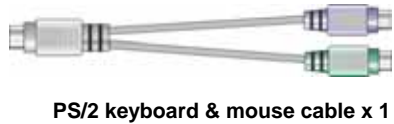
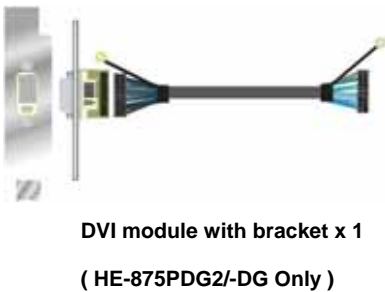
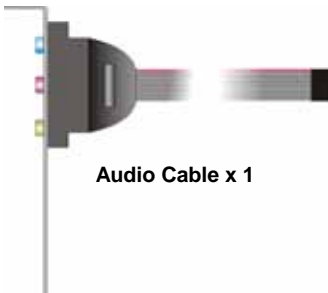
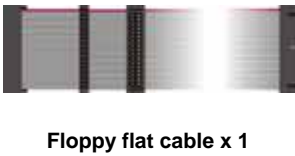
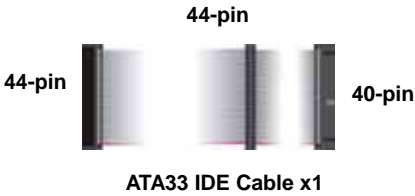

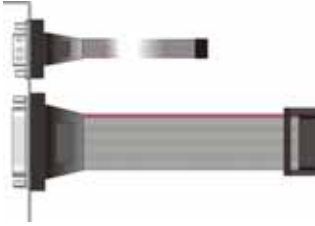

**COM & LTP cable x 1**  
**(HE-875PDG/-XG/-G only)**



**Dual COM cable x 1**  
**(HE-875PDG2/-XG2/-G2 only)**

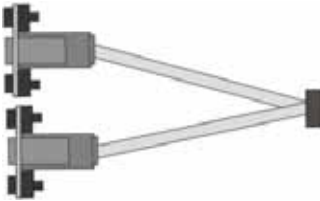

**SDTV Cable x 1**  
**(Optional)**

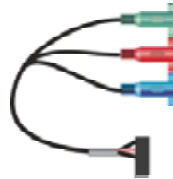

**YPbPr Cable x 1**  
**(Optional)**

**Printed Matters:**

**Driver CD x 1 (Including User's Manual)**

---

## Index

Chapter 1 <Introduction>.....	6
1.1 <Product Overview> .....	6
1.2 <Product Specification> .....	7
1.3 <Mechanical Drawing> .....	9
1.4 <Block Diagram > .....	10
Chapter 2 <Hardware Setup>.....	11
2.1 <Connector Location>.....	11
2.2 <Jumper Reference> .....	13
2.3 <Connector Reference>.....	14
2.3.1 <Internal Connector>.....	14
2.3.2 <External Connector>.....	14
2.4 <Memory Setup> .....	15
2.5 <CMOS & ATX Setup> .....	16
2.6 <Enhanced IDE & CF Interface>.....	17
2.7 <Serial ATA Interface>.....	18
2.8 <LAN Interface>.....	18
2.9 <Onboard Display Interface> .....	19
2.9.1 <Analog VGA Interface>.....	19
2.9.2 <Digital Display>.....	20
2.9.3 <DVI Interface > .....	24
2.9.4 <TV-out Interface> .....	25
2.10 <Onboard Audio Interface>.....	26
2.11 <USB2.0 & IR Interface> .....	27
2.12 <GPIO Interface>.....	29
2.13 <Serial Port Jumper Setting > .....	30
2.14 <Power and Fan Connector > .....	32
2.14.1 <Power connectors>.....	32
2.14.2 <Fan Connector> .....	33
2.15 <Indicator and Switch> .....	34

---

Chapter 3 <System Configuration>.....	35
3.1 <Video Memory Setup>.....	35
3.2 <Audio Configuration >.....	37
Chapter 4 <BIOS Setup>.....	38
Appendix A <I/O Port Pin Assignment> .....	39
A.1 <IDE Port> .....	39
A.2 <IrDA Port> .....	39
A.3 < CRT Port >.....	40
A.4 <Serial ATA Port>.....	40
A.5 <Serial Port>.....	40
A.6 <LAN Port> .....	41
A.7 <Parallel Port> .....	41
A.8 < Floppy Port > .....	42
A.9 <AT Keyboard Port> .....	42
Appendix B <Flash BIOS> .....	43
B.1 <BIOS Auto Flash Tool>.....	43
B.2 <Flash Method> .....	43
Appendix C <System Resources> .....	44
C.1 <I/O Port Address Map> .....	44
C.2 <Memory Address Map >.....	46
C.3 < System IRQ Resources > .....	47
Appendix D <Programming GPIO's> .....	48
Appendix E <Watch Dog timer Setting >.....	49
Contact Information.....	50

## Chapter 1 <Introduction>

### 1.1 <Product Overview>

**HE-875P** is an all-in-one single board computer with PISA bus, with Intel® Atom N270 processor for 533 MHz front side bus, Intel® 945GSE and ICH7M chipset, integrated GMA950 graphics, DDR2 SO-DIMM memory, Realtek AC97 Audio, Serial ATA and Intel® 82574L Gigabit LAN.

#### **Intel Atom Processor**

The Intel® Atom N270 single core processor is with 533 MHz front side bus, 512KB L2 cache. It's built on 45nm process technology support Hyper-Threading Technology, Enhanced Intel SpeedStep® Technology reduces average system power consumption.

#### **Mobile Intel® 945GSE chipset**

The board integrates Intel® 945GSE and ICH7M chipset. The chipset features power-efficient graphics with an integrated 32-bit 3D graphics engine based on Intel® Graphics Media Accelerator 950 architecture with DVI, LVDS, CRT, and TV-Out display ports. It provides I/O capabilities and flexibility via high-bandwidth interfaces such as PCI, Serial ATA and Hi-Speed USB 2.0 connectivity. It also includes a single channel for 400/533 MHz DDR2 system memory (SODIMM), AC97 Audio with 5.1 channels surrounding sound.

#### **All in One multimedia solution**

Based on Intel 945GSE and ICH7M chipset, the board provides high performance onboard graphics, 18-bit Dual channel LVDS interface, DVI and HDTV and 5.1 channels AC97 Audio, to meet the every requirement of the multimedia application.

#### **Flexible Extension Interface**

The board also provides Compact Flash Type II socket and one mini-PCI socket.

## 1.2 <Product Specification>

### General Specification

Form Factor	Half-size PISA CPU Card
CPU	Intel® Atom N270 1.6GHz processor Package type: FCBGA8 L2 cache: 512KB Front side bus: 533MHz
Memory	1 x 200-pin DDR2 SO-DIMM SDRAM up to 2GB Unbuffered, none-ECC memory supported only
Chipset	Intel® 945GSE and ICH7M
BIOS	Phoenix-Award v6.00PG 8Mb SPI flash BIOS
Green Function	Power saving mode includes doze, standby and suspend modes. ACPI version 1.0 and APM version 1.2 compliant
Watchdog Timer	System reset programmable watchdog timer with 1 ~ 255 sec./min. of timeout value
Real Time Clock	Intel® ICH7M built-in RTC with lithium battery
Enhanced IDE	UltraDMA33 IDE interface supports up to 2 ATAPI devices One 44-pin IDE port onboard One CompactFlash Type II socket on solder side
Serial ATA	Intel® ICH7M integrates 2 Serial ATA interfaces Up to 150MB/s of transfer rate (No RAID Function)

### Multi-I/O Port

Chipset	Intel® ICH7M with Winbond® W83627THG controller
Serial Port	One RS-232/422/485 serial port and one RS-232
USB Port	Six internal Hi-Speed USB 2.0 ports with 480Mbps of transfer rate
IrDA Port	One IrDA compliant Infrared interface supports SIR
K/B & Mouse	PS/2 keyboard and mouse port
GPIO	One 12-pin Digital I/O connector with 8-bit programmable I/O interface
Smart Fan	One CPU fan connectors for fan speed controllable

### VGA Display Interface

Chipset	Intel® 945GSE GMCH (Graphic Memory Controller Hub)
Frame Buffer	Up to 224MB shared with system memory
Display Type	CRT, LCD monitor with analog display, DVI, HDTV
Connector	External DB15 female connector on rear I/O panel Onboard 40-Pin LVDS connector Onboard 26-Pin DVI connector Onboard 10-Pin TV-out connector

### Ethernet Interface

Controller	2 x Intel 82574L Gigabit Ethernet controller
Type	Triple speed 10/100/1000Base-T, auto-switching Fast Ethernet



## HE-875P User's Manual

	Full duplex, IEEE802.3U compliant
Connector	Two External RJ45 connector with LED on rear I/O panel
<b>Solid State Disk Interface</b>	
Flash Type	Compact Flash Type II for Compact Flash Card or Micro Drive
<b>ISA Interface</b>	
ISA Bridge	Winbond W83628AG & W83629AG
Function	I/O & IRQ supported only, no support DMA & bus mastering
<b>Audio Interface</b>	
Chipset	REALTEK ALC655
Interface	5.1 channel surround audio with Line-in, Line-out and MIC-in
Connector	Onboard audio connector with pin header Onboard CD-IN connector
<b>Expansive Interface</b>	
Mini PCI	1 x Mini PCI socket
<b>Power and Environment</b>	
Power Requirement	+5V, +12 DC input & 5V <sub>SB</sub> Requirement
Dimension	185 (L) x 127(H) mm
Temperature	Operating within 0 ~ 60°C Storage within -20 ~ 85°C
<b>Ordering Code</b>	
<b>HE-875PDG2</b>	Support Intel Atom N270 processor with onboard VGA, LVDS for 18-bit dual channel, HDTV, IDE, CF, SATA, COM, USB2.0, Mini PCI, AC97 Audio, <b>DVI</b> and <b>2 x Gigabit LAN</b> .
<b>HE-875PDG</b>	Support Intel Atom N270 processor with onboard VGA, LVDS for 18-bit dual channel, HDTV, IDE, CF, SATA, COM, USB2.0, Mini PCI, AC97 Audio, <b>DVI</b> and <b>1 x Gigabit LAN</b> .
<b>HE-875PG2</b>	Support Intel Atom N270 processor with onboard VGA, LVDS for 18-bit dual channel, HDTV, IDE, CF, SATA, COM, USB2.0, Mini PCI, AC97 Audio and <b>2 x Gigabit LAN</b> .
<b>HE-875PG</b>	Support Intel Atom N270 processor with onboard VGA, LVDS for 18-bit dual channel, HDTV, IDE, CF, SATA, COM, USB2.0, Mini PCI, AC97 Audio <b>1 x Gigabit LAN</b> .
<b>HE-875PXG2</b>	Support Intel Atom N270 processor with onboard VGA, LVDS for <b>24-bit</b> dual channel, HDTV, IDE, CF, SATA, COM, USB2.0, Mini PCI, AC97 Audio and <b>2 x Gigabit LAN</b> .
<b>HE-875PXG</b>	Support Intel Atom N270 processor with onboard VGA, LVDS for <b>24-bit</b> dual channel, HDTV, IDE, CF, SATA, COM, USB2.0, Mini PCI, AC97 Audio and <b>1 x Gigabit LAN</b> .

The specifications may be different as the actual production.

For further product information please visit the website at <http://www.commell.com.tw>

## 1.3 &lt;Mechanical Drawing&gt;

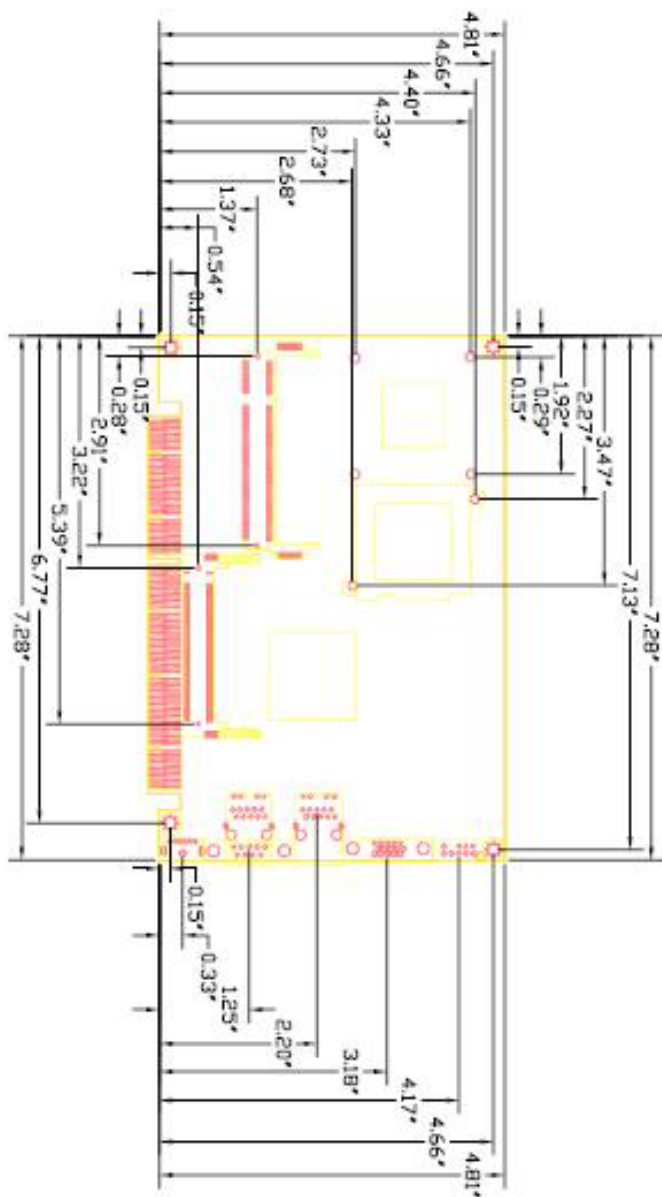

Unit: inch

# 1.4 < Block Diagram >

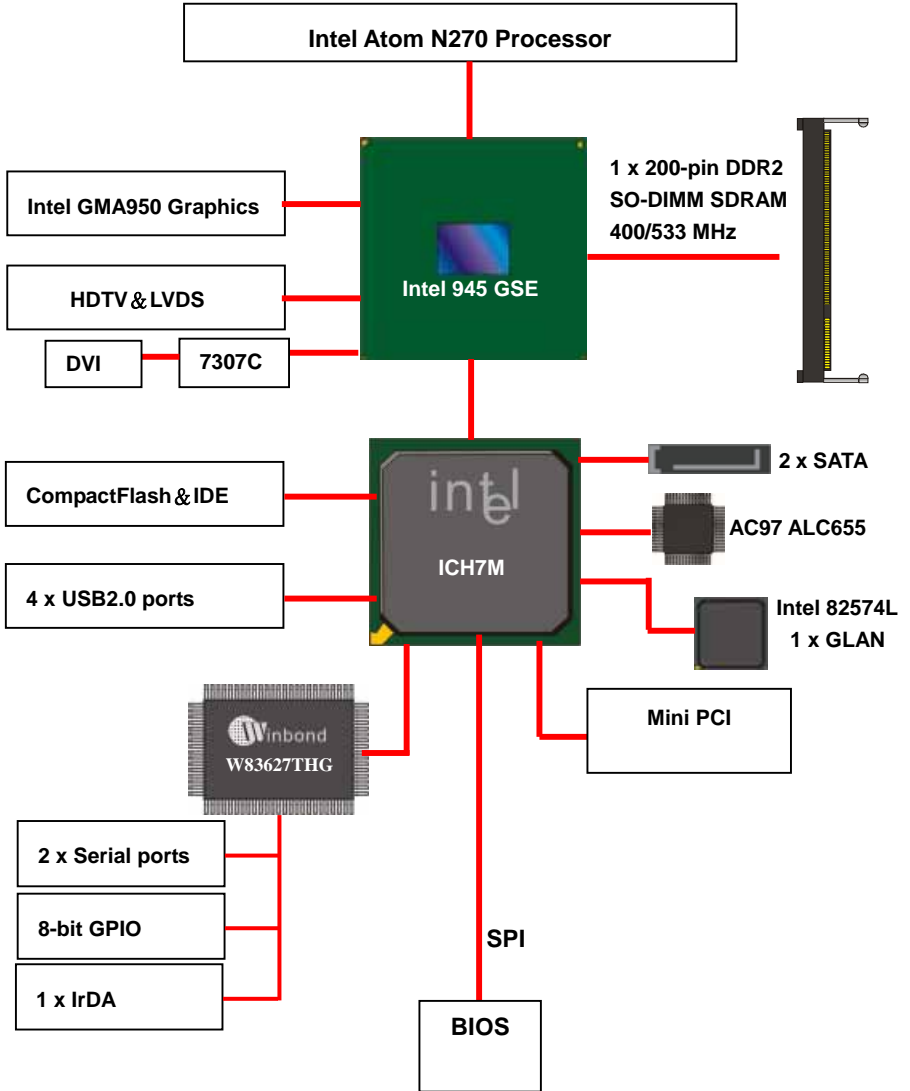

# Chapter 2 <Hardware Setup>

## 2.1 <Connector Location>

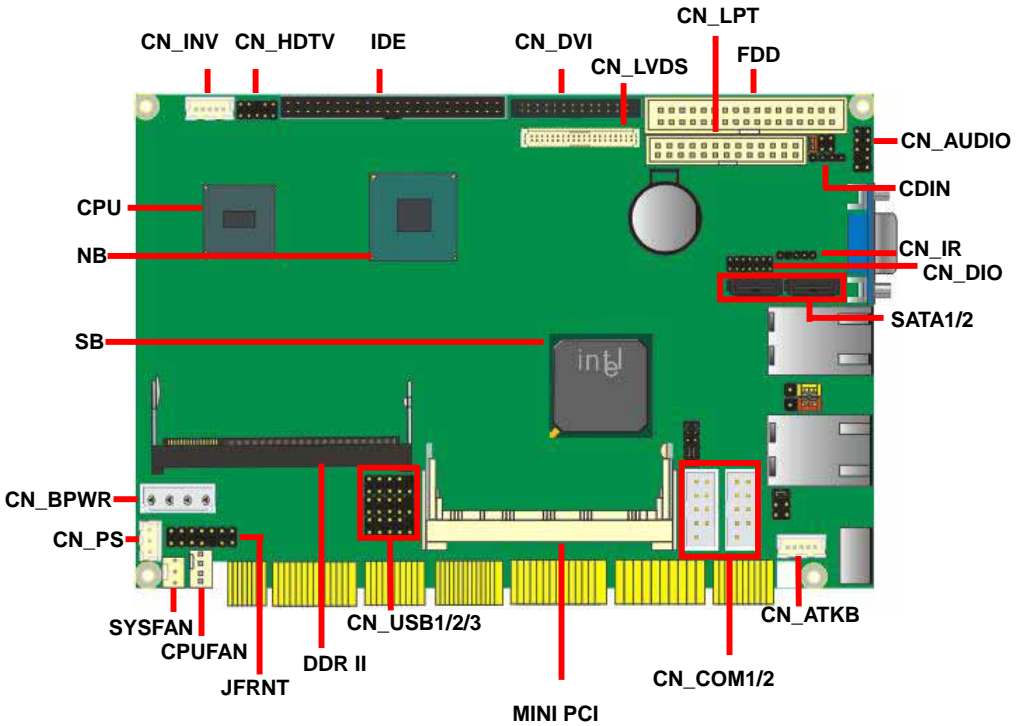

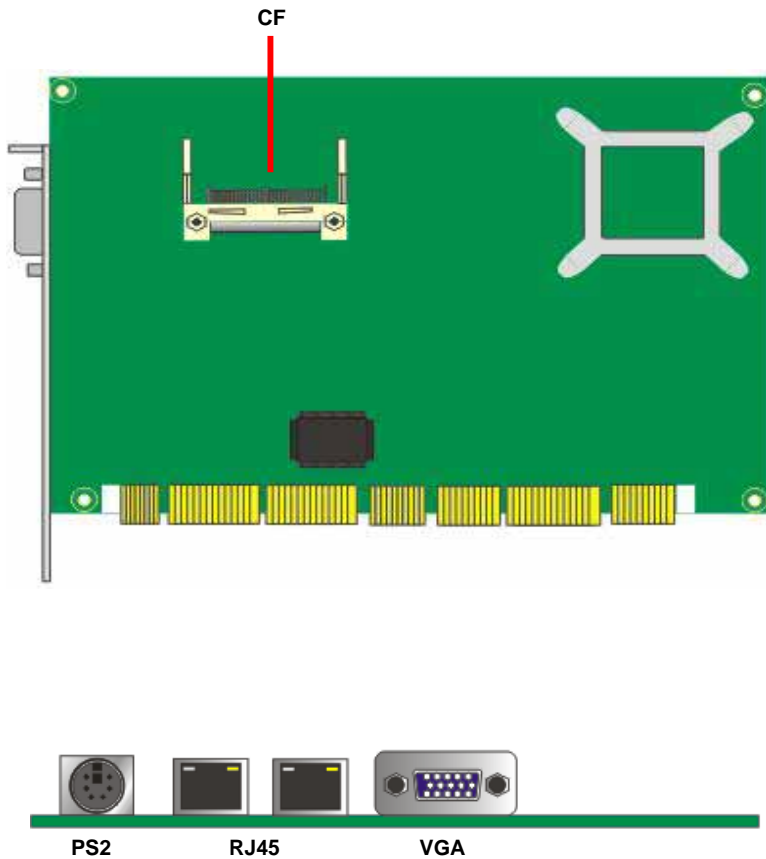

## 2.2 <Jumper Reference>

Jumper	Function
JRTC	CMOS Operating/Clear Setting
JVLCD	LCD Panel Voltage Setting
JAT	AT & ATX mode setting
JCSEL1/2	COM2 RS232/422/485 mode setting

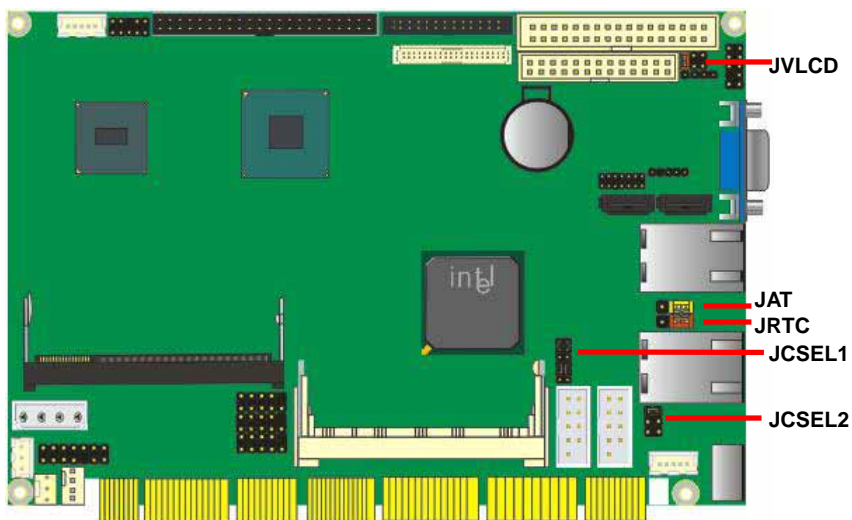

## 2.3 <Connector Reference>

### 2.3.1 <Internal Connector>

Connector	Function	Remark
JFRNT	14-pin switch/indicator connector	Standard
CPUFAN	4-pin CPU cooler fan connector	Standard
SYSFAN	3-pin system cooler fan connector	Standard
IDE	44-pin primary IDE connector	Slim
FDD	26-pin floppy connector	Standard
SATA1/2	7-pin Serial ATA connector	Standard
CDIN	4-pin CD-ROM audio input connector	Standard
CN_USB1/2/3	5 x 2-pin USB connector	Standard
CN_AUDIO	5 x 2-pin audio connector	Standard
CN_DIO	6 x 2-pin digital I/O connector	Slim
CN_COM1/2	5 x 2-pin com connector	Standard
CN_IR	5-pin IrDA connector	Standard
CN_LPT	13 x 2-pin LPT connector	Standard
CN_ATKB	5-pin AT keyboard connector	Standard
CN_PS	5Vsb & PS_ON connector	Standard
CN_BPWR	4-pin 5V/12V power input connector	Standard
CN_DVI	13 x 2-pin DVI interface	Standard
CN_HDTV	5 x 2-pin HDTV interface	Standard
CN_LVDS	20 x 2-pin LVDS connector	Standard
CN_INV	5-pin LCD inverter connector	Standard
DDR2	200 -pin DDR2 SO-DIMM socket	Standard
MINIPCI	Mini-PCI socket	Standard
CF	Compact Flash Type II socket	Standard

### 2.3.2 <External Connector>

Connector	Function	Remark
CRT	DB15 VGA connector	Standard
RJ45	One RJ45 LAN connector	Standard
PS2	PS/2 keyboard and mouse connector	Standard

## 2.4 <Memory Setup>

The board provides one 200-pin DDRII SO-DIMM to support DDRII 533 memory modules up to 2GB of capacity. Non-ECC, unbuffered memory is supported only.

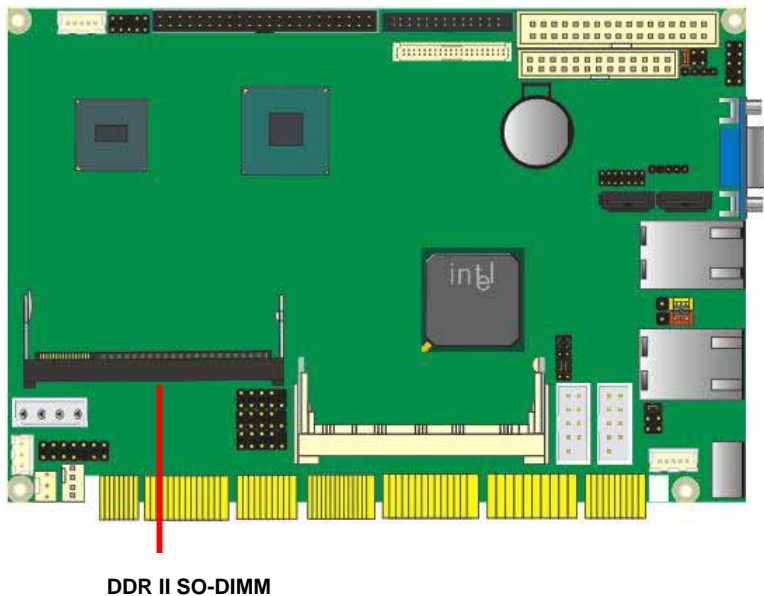



## 2.5 <CMOS & ATX Setup>

The board's data of CMOS can be setting in BIOS. If the board refuses to boot due to inappropriate CMOS settings, here is how to proceed to clear (reset) the CMOS to its default values.

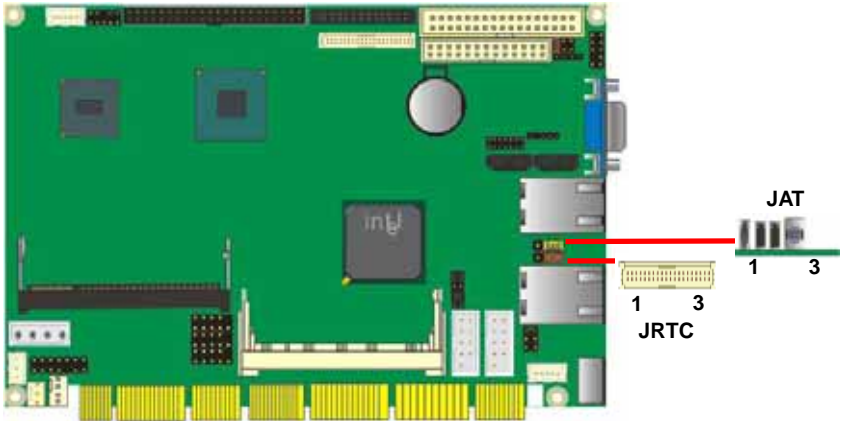

Jumper: **JRTC**

Type: Onboard 3-pin jumper

JRTC	Mode
1-2	Clear CMOS
2-3	Normal Operation

Default setting: 2-3

Jumper: **JAT**

Type: onboard 2-pin header

JAT	Mode
1-2	AT Mode
2-3	ATX Mode

Default setting: 2-3

## 2.6 <Enhanced IDE & CF Interface>

The board has one Ultra DMA33 IDE interface to support up to 2 ATAPI devices, and one Compact Flash Type II socket on the solder side.

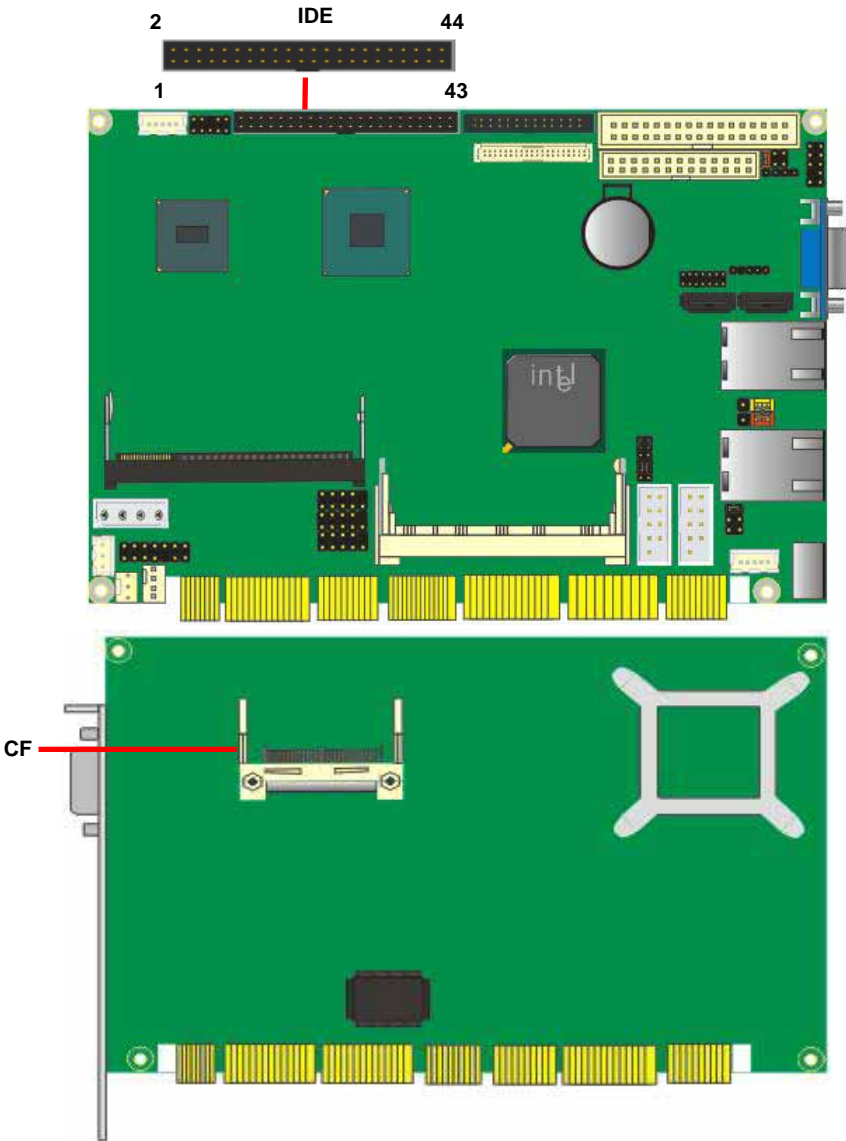



## 2.9 <Onboard Display Interface>

Based on Intel 945GSE chipset with built-in GMA (Graphic Media Accelerator) 950 graphics, the board provides one DB15 connector on rear external I/O port, and one 40-pin LVDS interface with 5-pin LCD backlight inverter connector. The board provides dual display function with clone mode and extended desktop mode for CRT and LCD and DVI and TV-out.

### 2.9.1 <Analog VGA Interface>

Please connect your CRT or LCD monitor with DB15 male connector to the onboard DB15 female connector on rear I/O port.

The board supports up to 2048 x 1536 (QXGA) of resolution.



CRT

### 2.9.2 <Digital Display>

The board provides one 40-pin LVDS connector for 18/ 24 bit dual channel panels, supports up to 1600 x 1200 (UXGA) of resolution, with one LCD backlight inverter connector and one jumper for panel voltage setting

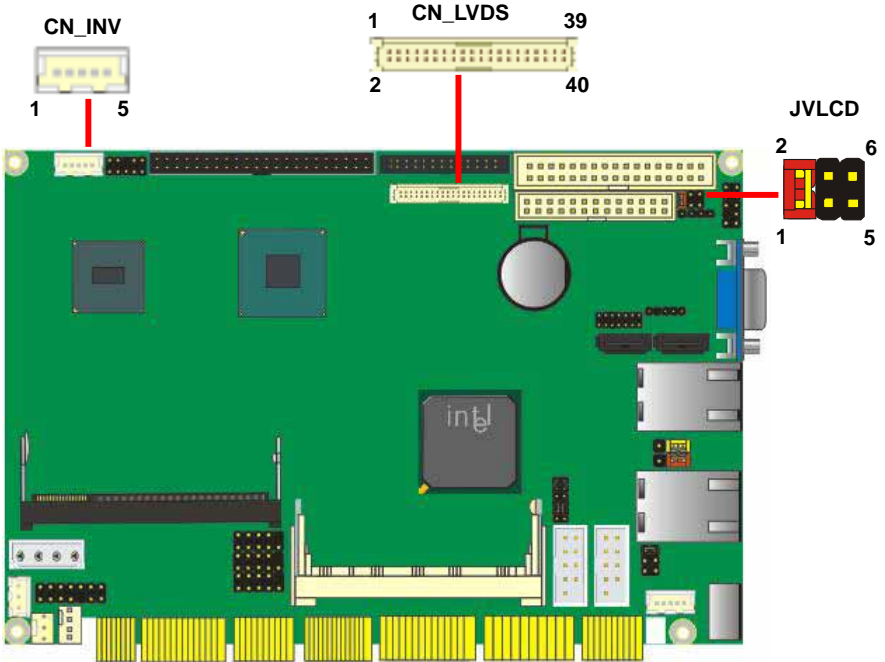

**Effective patterns of connection: 1-2 / 3-4 / 5-6**



**Warning: others cause damages**

Connector: **CN\_INV**

Type: 5-pin LVDS Power Header

Connector model: **JST B5B-XH-A**

Pin	Description
1	+12V
2	GND
3	GND
4	GND
5	ENABKL

Connector: **JVLCD**

Type: 6-pin Power select Header

Pin	Description
1-2	LCDVCC (+3.3V)
3-4	LCDVCC (+5V)
5-6	LCDVCC (+12V)

Default : 1-2

Connector: **CN\_LVDS**

Type: onboard 40-pin connector for LVDS connector

Connector model: **HIROSE DF13-40DP-1.25V**

Pin	Signal	Pin	Signal
2	LCDVCC	1	LCDVCC
4	GND	3	GND
6	ATX0-	5	BTX0-
8	ATX0+	7	BTX0+
10	GND	9	GND
12	ATX1-	11	BTX1-
14	ATX1+	13	BTX1+
16	GND	15	GND
18	ATX2-	17	BTX2-
20	ATX2+	19	BTX2+
22	GND	21	GND
24	ACLK-	23	BTX3-(HE-875PXG/-G2)
26	ACLK+	25	BTX3+(HE-875PXG/-G2)
28	GND	27	GND
30	ATX3-(HE-875PXG/-G2)	29	BCLK-
32	ATX3+(HE-875PXG/-G2)	31	BCLK+
34	GND	33	GND
36	N/C	35	N/C
38	N/C	37	N/C
40	N/C	39	N/C

## HE-875P User's Manual

To setup the LCD, you need the component below:

1. A panel with LVDS interfaces.
2. An inverter for panel's backlight power.
3. A LCD cable and an inverter cable.

**For the cables, please follow the pin assignment of the connector to make a cable, because every panel has its own pin assignment, so we do not provide a standard cable; please find a local cable manufacture to make cables.**

### LCD Installation Guide:

1. Preparing the HE-875P, LCD panel and the backlight inverter



2. Please check the datasheet of the panel to see the voltage of the panel, and set the jumper **JVLCD** to +12V, +5V or +3.3V.
3. You would need a LVDS type cable.

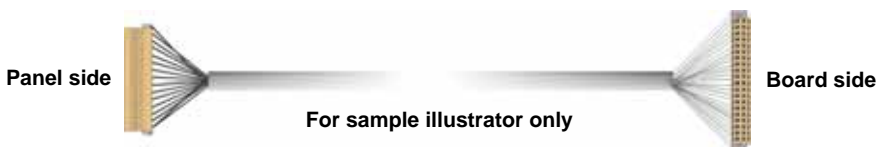

4. Connected all of the devices well.

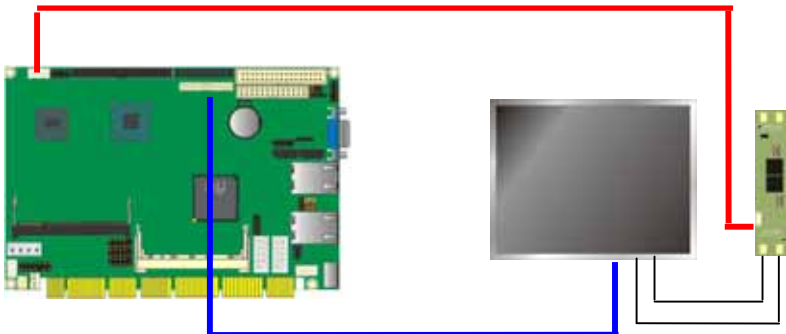

After setup the devices well, you need to select the LCD panel type in the BIOS.



The panel type mapping is list below:

HE-875P BIOS panel type selection form			
On board 18 bit LVDS			
Single channel		Dual channel	
NO.	Output format	NO.	Output format
1	640 x 480	9	1280 x 768
2	800 x 480		
3	800 x 600		
4	1024 x 600		
5	1024 x 768		
6	1280 x 600		
7	1280 x 768		
8	1280x 800		

HE-875PX BIOS panel type selection form	
On board 18/24 bit LVDS	
NO.	Output format
1	640 x 480 single channel 24bit
2	800 x 480 single channel 24bit
3	1024 x 768 single channel 24bit
4	1280 x 1024 dual channel 24bit



### 2.9.3 <DVI Interface >

The board also comes with a DVI interface with Chrontel CH7307C for digital video interface. Supports up to 1600 x 1200 (UXGA) of resolution.

Connector: **CN\_DVI**

Connector type: 26-pin header connector (pitch = 2.00mm)

Pin Number	Assignment	Pin Number	Assignment
1	TX1+	2	TX1-
3	Ground	4	Ground
5	TXC+	6	TXC-
7	Ground	8	PVDD
9	N/C	10	N/C
11	TX2+	12	TX2-
13	Ground	14	Ground
15	TX0+	16	TX0-
17	N/C	18	HPDET
19	DCCDATA	20	DCCCLK
21	GND	22	N/C
23	N/C	24	N/C
25	N/C	26	N/C

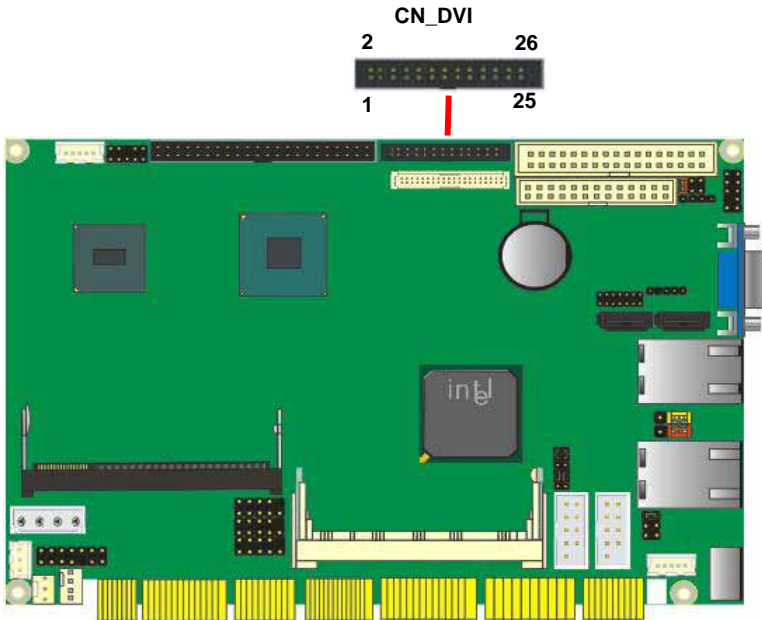

### 2.9.4 <TV-out Interface>

The board provides an HDTV interface with Intel 945GSE, supports PAL and NTSC of TV system, and display (clone or extended desktop) function with CRT, LVDS and DVI.

Connector: **CN\_HDTV**

Connector type: 10-pin header HDTV connector (pitch = 2.54mm)

Pin Number	Assignment	Pin Number	Assignment
1	GND	2	DACB1
3	DACB2	4	N/C
5	GND	6	GND
7	DACB3	8	N/C
9	N/C	10	N/C

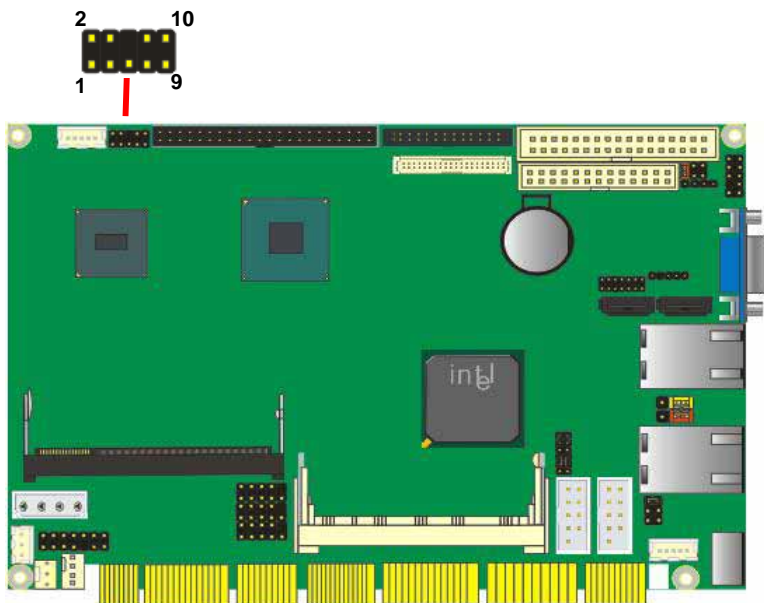

## 2.10 <Onboard Audio Interface>

The board provides the onboard AC97 5.1-channel audio interface with Realtek ALC655

**Connector: CN\_AUDIO**

Type: 10-pin (2 x 5) 2.54mm x 2.54 mm-pitch header

Pin	Description	Pin	Description
1	LIN_L	2	Ground
3	LIN_R	4	MIC 1
5	MIC 2	6	Ground
7	N/C	8	FRONTL
9	FRONTR	10	Ground

**Connector: CDIN**

Type: 4-pin header (pitch = 2.54mm)

Pin	Description
1	CD – Left
2	Ground
3	Ground
4	CD – Right

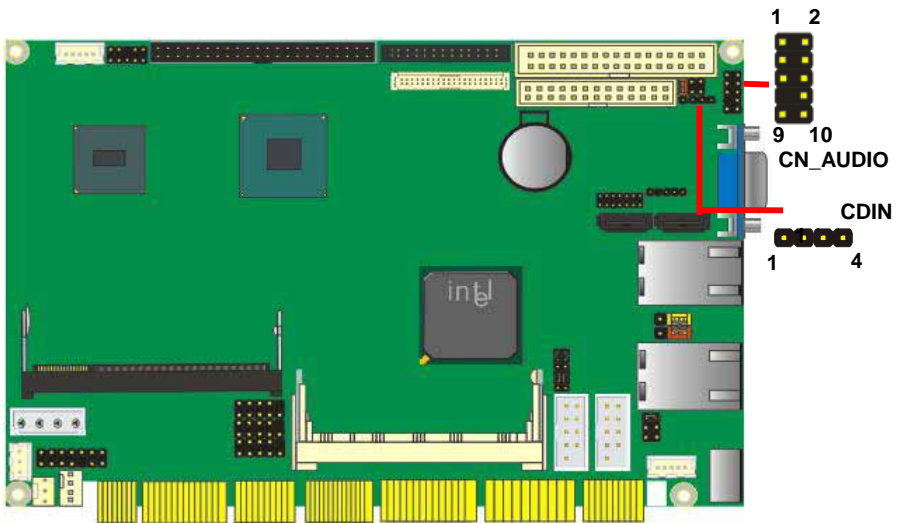

## 2.11 <USB2.0 & IR Interface>

Based on Intel ICH7M, the board provides 6 USB2.0 ports. The USB2.0 interface provides up to 480Mbps of transferring rate.

Interface	USB2.0
Controller	ICH7M
Transfer Rate	Up to 480Mb/s
Output Current	500mA

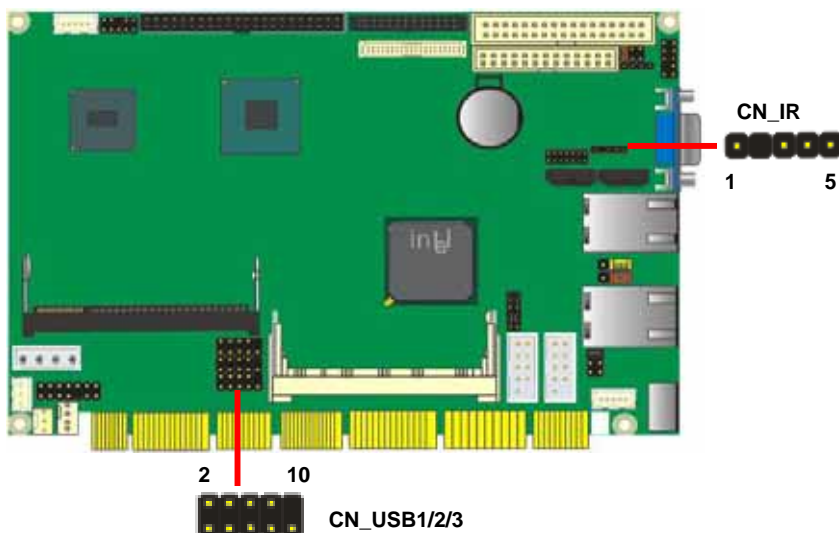

Connector: **CN\_IR**

Type: 5-pin header for SIR Port

Pin	Description
1	Vcc
2	N/C
3	IRRX
4	Ground
5	IRTX

Connector: **CN\_USB1/2/3**

Type: 10-pin (5 x 2) header for USB Port

Pin	Description	Pin	Description
1	VCC	2	VCC
3	Data0-	4	Data1-
5	Data0+	6	Data1+
7	Ground	8	Ground
9	Ground	10	N/C

PS: The USB2.0 will be only active when you connecting with the USB2.0 devices, if you insert an USB1.1 device, the port will be changed to USB1.1 protocol automatically. The transferring rate of USB2.0 as 480Mbps is depends on device compatible, exact transferring rate may not be up to 480Mbps.

## 2.12 <GPIO Interface>

The board provides a programmable 8-bit digital I/O interface; you can use this general purpose I/O port for system control like POS or KIOSK.

Connector: **CN\_DIO**

Type: onboard 2 x 6-pin header, pitch=2.0mm

Pin	Description	Pin	Description
1	Ground	2	Ground
3	GP0	4	GP4
5	GP1	6	GP5
7	GP2	8	GP6
9	GP3	10	GP7
11	VCC	12	+12V

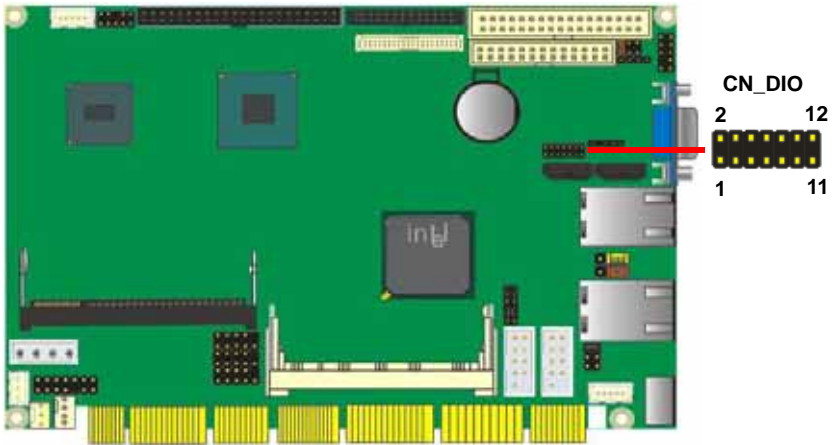

## 2.13 <Serial Port Jumper Setting >

The board provides three RS232 serial ports, with jumper selectable RS422/485 for COM2.

Connector: **CN\_COM1/2**

Type: 10-pin (5 x 2) 2.54mm x 2.54mm-pitch header for COM1/2

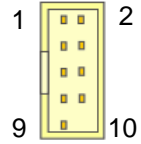

Pin	Description	Pin	Description
1	DCD/422TX-/485-	2	RXD/422TX+/485+
3	TXD/422RX+	4	DTR/422RX-
5	GND	6	DSR
7	RTS	8	CTS
9	RI	10	N/C

	JCSEL1	JCSEL2
<b>RS-232</b>	<p>Diagram showing the RS-232 configuration with the JCSEL1 jumper at position 1. The jumper is a small rectangular component with two pins, one at position 1 and one at position 2.</p>	<p>Diagram showing the RS-232 configuration with the JCSEL2 jumper at position 1. The jumper is a small rectangular component with two pins, one at position 1 and one at position 2.</p>
<b>RS-485</b>	<p>Diagram showing the RS-485 configuration with the JCSEL1 jumper at position 2. The jumper is a small rectangular component with two pins, one at position 1 and one at position 2.</p>	<p>Diagram showing the RS-485 configuration with the JCSEL2 jumper at position 2. The jumper is a small rectangular component with two pins, one at position 1 and one at position 2.</p>
<b>RS-422</b>	<p>Diagram showing the RS-422 configuration with the JCSEL1 jumper at position 1. The jumper is a small rectangular component with two pins, one at position 1 and one at position 2.</p>	<p>Diagram showing the RS-422 configuration with the JCSEL2 jumper at position 2. The jumper is a small rectangular component with two pins, one at position 1 and one at position 2.</p>

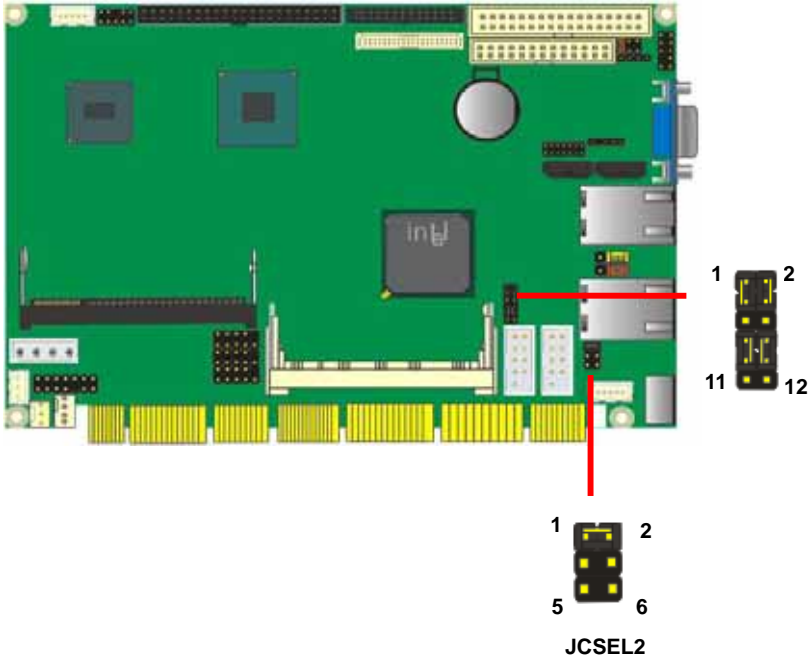



## 2.14 <Power and Fan Connector >

The board comes with a 4-pin AT power connector for powering the board, three fan connectors for Northbridge, CPU and system. The board also provides a 3-pin ATX function connector. You can just connect the two power connectors without any backplane to work.

### 2.14.1 <Power connectors>

Connector: **DC\_BPWR**

Type: 4-pin P-type connector for +5V/+12V input

Pin	Description	Pin	Description	Pin	Description	Pin	Description
1	+12V	2	Ground	3	Ground	4	+5V

Connector: **CN\_PS**

Type: 3-pin ATX function connector

Pin	Description	Pin	Description	Pin	Description
1	5V Standby	2	Ground	3	PS_ON

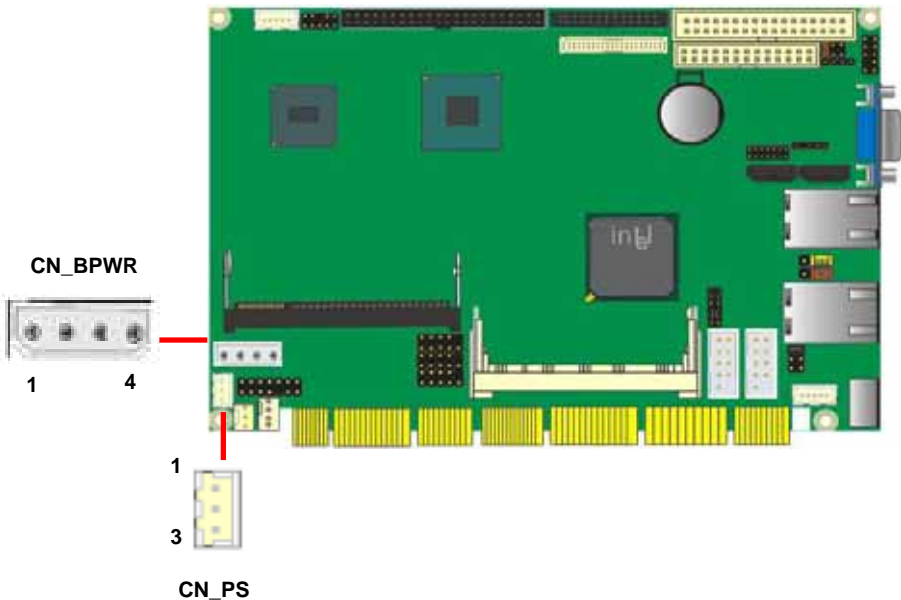

### 2.14.2 <Fan Connector>

Connector: **SYSFAN**

Type: 3-pin fan wafer connector

Pin	Description	Pin	Description	Pin	Description
1	Ground	2	+12V	3	Fan Control

Connector: **CPUFAN**

Type: 4-pin P-type connector

Pin	Description	Pin	Description	Pin	Description	Pin	Description
1	Ground	2	+12V	3	Fan Speed detect	4	Sense

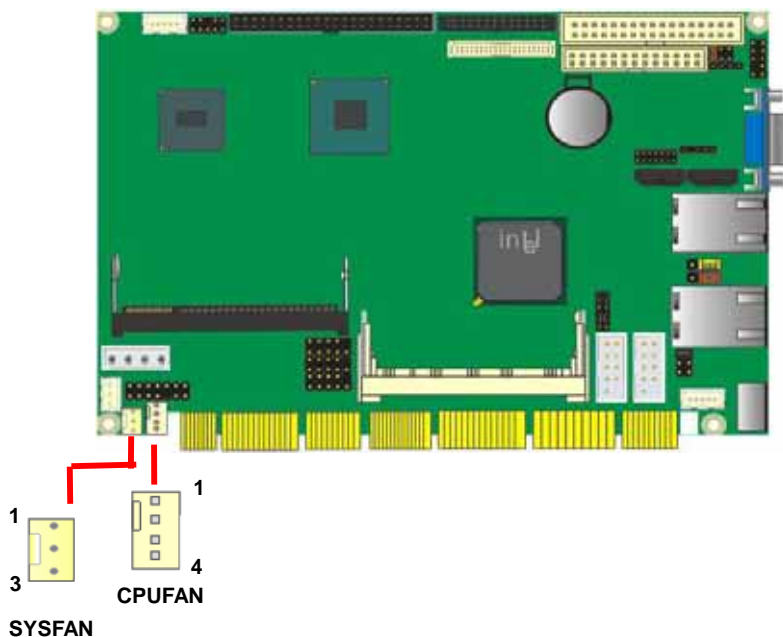

## 2.15 <Indicator and Switch>

The **JFRNT** provides front control panel of the board, such as power button, reset and beeper, etc. Please check well before you connecting the cables on the chassis.

Connector: **JFRNT**

Type: onboard 14-pin (2 x 7) 2.54-pitch header

Function	Signal	PIN		Signal	Function
IDE LED	HDLED+	1	2	PWRLED+	Power LED
	HDLED-	3	4	N/C	
Reset	Reset+	5	6	PWRLED-	Speaker
	Reset-	7	8	SPK+	
N/C		9	10	N/C	
Power	PWRBT+	11	12	N/C	
Button	PWRBT-	13	14	SPK-	

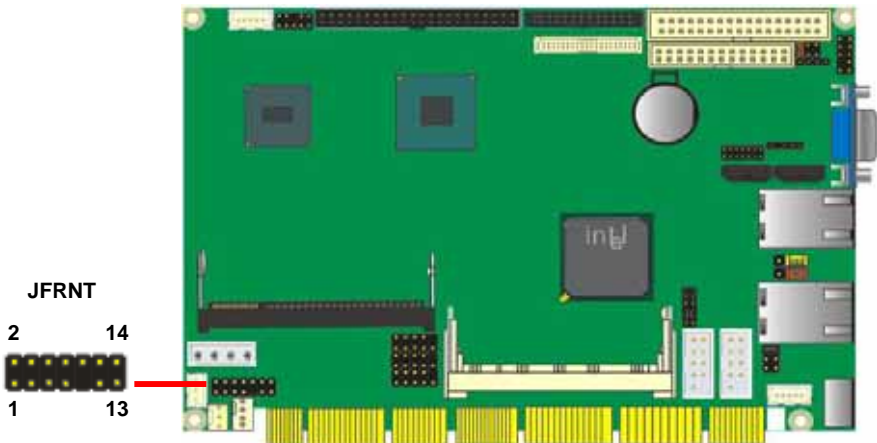

## Chapter 3 <System Configuration>

### 3.1 <Video Memory Setup>

Based on Intel® 945GSE chipset with GMA (Graphic Media Accelerator) 950, the board supports Intel® DVMT (Dynamic Video Memory Technology) 3.0, which would allow the video memory to be allocated up to 224MB.

To support DVMT, you need to install the Intel GMA 950 Driver with supported OS.

#### BIOS Setup:



#### On-Chip Frame Buffer Size:

This item can let you select video memory which been allocated for legacy VGA and SVGA graphics support and compatibility. The available option is **1MB** and **8MB**.

#### Fixed + DVMT Memory Size:

You can select the fixed amount and the DVMT amount at the same time for a guaranteed video memory and additional dynamic video memory, please check the table below for available setting.

Notice:

1. The On-Chip Frame Buffer Size would be included in the Fixed Memory.  
Please select the memory size according to this table.

<b>System Memory</b>	<b>On-Chip Frame Buffer Size</b>	<b>Fixed Memory Size</b>	<b>DVMT Memory Size</b>	<b>Total Graphic Memory</b>
128MB~255MB	1MB	32MB	0MB	32MB
	1MB	0MB	32MB	32MB
	8MB	32MB	0MB	32MB
	8MB	0	32MB	32MB
256MB~511MB	1MB	64MB	0MB	64MB
	1MB	0	64MB	64MB
	1MB	128MB	0MB	128MB
	1MB	0	128MB	128MB
	1MB	64MB	64MB	128MB
	8MB	64MB	0MB	64MB
	8MB	0	64MB	64MB
	8MB	128MB	0MB	128MB
	8MB	0	128MB	128MB
	8MB	64MB	64MB	128MB
512MB upper	1MB	64MB	0	64MB
	1MB	0	64MB	64MB
	1MB	128MB	0	128MB
	1MB	0	128MB	128MB
	1MB	64MB	64MB	128MB
	8MB	64MB	0	64MB
	8MB	0	64MB	64MB
	8MB	128MB	0	128MB
	8MB	0	128MB	128MB
	8MB	64MB	64MB	128MB

### 3.2 <Audio Configuration >

The board provides 5.1 channel audio interface with driver installed, please install the Realtek ALC655 audio driver in the CD before getting start to enjoy the 5.1 channel sound system.

1. Install REALTEK AC97 Audio driver.



2. Launch the control panel and Sound Effect Manager.
3. Select Speaker Configuration.

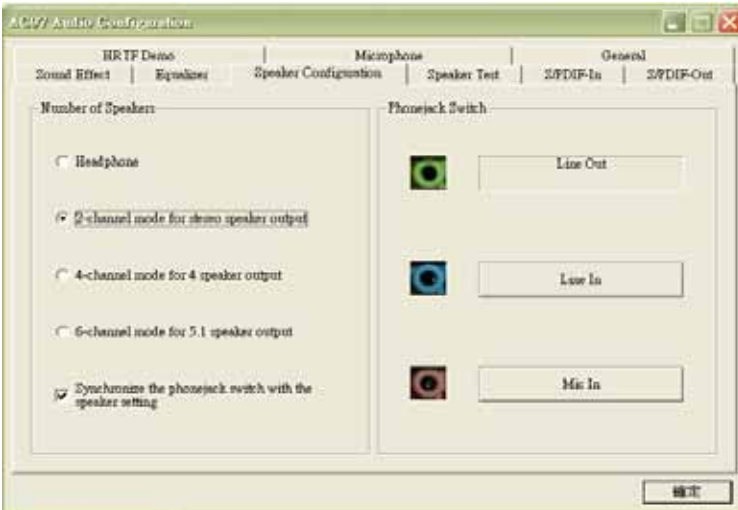

4. Select the sound mode to meet your speaker system.



# Appendix A <I/O Port Pin Assignment>

## A.1 <IDE Port>

Connector: IDE

Type: 44-pin (22 x 2) box header



Pin	Description	Pin	Description
1	Reset	2	Ground
3	D7	4	D8
5	D6	6	D9
7	D5	8	D10
9	D4	10	D11
11	D3	12	D12
13	D2	14	D13
15	D1	16	D14
17	D0	18	D15
19	Ground	20	N/C
21	REQ	22	Ground
23	IOW-/STOP	24	Ground
25	IOR-/HDMARDY	26	Ground
27	IRDY/DDMARDY	28	Ground
29	DACK-	30	Ground
31	IRQ	32	N/C
33	A1	34	SD
35	A0	36	A2
37	CS1	38	CS3
39	ASP1	40	Ground
41	Vcc	42	Vcc
43	Ground	44	Ground

## A.2 <IrDA Port>

Connector: CN\_IR

Type: 5-pin header for SIR Port



Pin	Description
1	Vcc
2	N/C
3	IRRX
4	Ground
5	IRTX



### A.3 < CRT Port >

Connector: **CRT**

Type: 15-pin D-sub female connector on rear panel

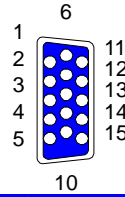

Pin	Description	Pin	Description	Pin	Description
1	RED	6	Ground	11	N/C
2	GREEN	7	Ground	12	5VCD A
3	BLUE	8	Ground	13	HSYNC
4	N/C	9	LVGA5V	14	VS YNC
5	Ground	10	Ground	15	5VCLK

### A.4 <Serial ATA Port>

Connector: **SATA1/2**

Type: 7-pin wafer connector

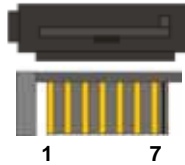

1	2	3	4	5	6	7
GND	RSATA_TXP1	RSATA_TXN1	GND	RSATA_RXN1	RSATA_RXP1	GND

### A.5 <Serial Port>

Connector: **COM1 (HE-875PDG/-XG/-G)**

Type: 9-pin D-sub male connector on rear panel

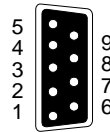

Pin	Description	Pin	Description
1	DCD	6	DSR
2	SIN	7	RTS
3	SO	8	CTS
4	DTR	9	RI
5	Ground		

## A.6 <LAN Port>

Connector: **RJ45**

Type: RJ45 connector with LED on rear panel

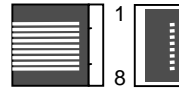

Pin	1	2	3	4	5	6	7	8
Description	TRD0+	TRD0-	TRD1+	TRD2+	TRD2-	TRD1-	TRD3+	TRD3-

## A.7 <Parallel Port>

Connector: **LPT**

Type: 26-Pin box header

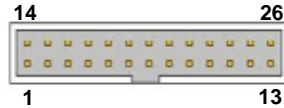

Pin	Description	Pin	Description
1	-PSTB	14	AFD-
2	PRO0	15	ERR-
3	PRO1	16	INT-
4	PRO2	17	SLIN-
5	PRO3	18	Ground
6	PRO4	19	Ground
7	PRO5	20	Ground
8	PRO6	21	Ground
9	PRO7	22	Ground
10	ACK-	23	Ground
11	BUSY	24	Ground
12	PE	25	Ground
13	SLCT	26	N/C

## A.8 < Floppy Port >

Connector: **FDD**

Type: 34-pin connector

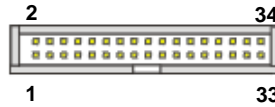

Pin	Description	Pin	Description
1	VCC	2	INDEX
3	VCC	4	DR0
5	VCC	6	DSKCHG
7	N/C	8	N/C
9	N/C	10	MTR0
11	DRVDE0	12	DIR
13	N/C	14	STEP
15	Ground	16	WRITE DATA
17	Ground	18	WRITE GATE
19	Ground	20	TRAK 0
21	N/C	22	WRPT0
23	Ground	24	RDATA-
25	Ground	26	HDSEL

## A.9 <AT Keyboard Port>

Connector: **CN\_ATKB**

Type: 5-pin box header



Pin	1	2	3	4	5
Description	VCC	Ground	N/C	DATA	CLK

## Appendix B <Flash BIOS>

### B.1 <BIOS Auto Flash Tool>

The board is based on Award BIOS and can be updated easily by the BIOS auto flash tool. You can download the tool online at the address below:

<http://www.award.com>

<http://www.commell.com.tw/support/support.htm>

File name of the tool is "awdfash.exe", it's the utility that can write the data into the BIOS flash chip and update the BIOS.

### B.2 <Flash Method>

1. Please make a bootable floppy disk.
2. Get the last .bin files you want to update and copy it into the disk.
3. Copy awardflash.exe to the disk.
4. Power on the system and flash the BIOS. (Example: C:/ awardflash XXX.bin)
5. Re-start the system.

Any question about the BIOS re-flash please contact your distributors or visit the web-site at below:

<http://www.commell.com.tw/support/support.htm>

## Appendix C <System Resources>

### C.1 <I/O Port Address Map>

[00000000 - 0000000F]	Direct memory access controller
[00000000 - 00000CF7]	PCI bus
[00000010 - 0000001F]	Motherboard resources
[00000020 - 00000021]	Programmable interrupt controller
[00000022 - 0000003F]	Motherboard resources
[00000040 - 00000043]	System timer
[00000044 - 0000005F]	Motherboard resources
[00000060 - 00000060]	Standard 101/102-Key or Microsoft Natural PS/2 Keyboard
[00000061 - 00000061]	System speaker
[00000062 - 00000063]	Motherboard resources
[00000064 - 00000064]	Standard 101/102-Key or Microsoft Natural PS/2 Keyboard
[00000065 - 0000006F]	Motherboard resources
[00000070 - 00000073]	System CMOS/real time clock
[00000074 - 0000007F]	Motherboard resources
[00000080 - 00000090]	Direct memory access controller
[00000091 - 00000093]	Motherboard resources
[00000094 - 0000009F]	Direct memory access controller
[000000A0 - 000000A1]	Programmable interrupt controller
[000000A2 - 000000BF]	Motherboard resources
[000000C0 - 000000DF]	Direct memory access controller
[000000E0 - 000000EF]	Motherboard resources
[000000F0 - 000000FF]	Numeric data processor
[00000170 - 00000177]	Secondary IDE Channel
[000001F0 - 000001F7]	Primary IDE Channel
[00000200 - 00000200]	Standard Game Port
[00000201 - 00000207]	Standard Game Port
[00000274 - 00000277]	ISAPNP Read Data Port
[00000279 - 00000279]	ISAPNP Read Data Port
[000002F8 - 000002FF]	Communications Port (COM2)
[00000376 - 00000376]	Secondary IDE Channel
[00000378 - 0000037F]	Printer Port (LPT1)
[000003B0 - 000003BB]	Mobile Intel(R) 945 Express Chipset Family
[000003C0 - 000003DF]	Mobile Intel(R) 945 Express Chipset Family
[000003F0 - 000003F5]	Standard floppy disk controller

[000003F6 - 000003F6] Primary IDE Channel  
[000003F7 - 000003F7] Standard floppy disk controller  
[000003F8 - 000003FF] Communications Port (COM1)  
[00000400 - 000004BF] Motherboard resources  
[000004D0 - 000004D1] Motherboard resources  
[00000500 - 0000051F] Intel(R) 82801G (ICH7 Family) SMBus Controller - 27DA  
[00000778 - 0000077B] Printer Port (LPT1)  
[00000880 - 0000088F] Motherboard resources  
[00000A79 - 00000A79] ISAPNP Read Data Port  
[00000D00 - 0000FFFF] PCI bus  
[00008000 - 00008FFF] Intel(R) 82801G (ICH7 Family) PCI Express Root Port - 27D2  
[0000BF00 - 0000BF1F] Intel(R) 82574L Gigabit Network Connection  
[0000C000 - 0000CFFF] Intel(R) 82801G (ICH7 Family) PCI Express Root Port - 27D0  
[0000CF00 - 0000CF1F] Intel(R) 82574L Gigabit Network Connection #2  
[0000F000 - 0000F0FF] Realtek AC'97 Audio  
[0000F800 - 0000F80F] Intel(R) 82801GBM/GHM (ICH7-M Family) Serial ATA Storage Controller - 27C4  
[0000FA00 - 0000FA3F] Realtek AC'97 Audio  
[0000FB00 - 0000FB1F] Intel(R) 82801G (ICH7 Family) USB Universal Host Controller - 27CB  
[0000FC00 - 0000FC1F] Intel(R) 82801G (ICH7 Family) USB Universal Host Controller - 27CA  
[0000FD00 - 0000FD1F] Intel(R) 82801G (ICH7 Family) USB Universal Host Controller - 27C9  
[0000FE00 - 0000FE1F] Intel(R) 82801G (ICH7 Family) USB Universal Host Controller - 27C8  
[0000FF00 - 0000FF07] Mobile Intel(R) 945 Express Chipset Family

## C.2 <Memory Address Map >

[00000000 - 0009FFFF]	System board
[000A0000 - 000BFFFF]	Mobile Intel(R) 945 Express Chipset Family
[000A0000 - 000BFFFF]	PCI bus
[000C0000 - 000DFFFF]	PCI bus
[000E0000 - 000EFFFF]	System board
[000F0000 - 000FFFFF]	System board
[00100000 - 3F6DFFFF]	System board
[3F6E0000 - 3F6FFFFF]	System board
[3F750000 - FEBFFFFF]	PCI bus
[D0000000 - DFFFFFFF]	Mobile Intel(R) 945 Express Chipset Family
[E0000000 - EFFFFFFF]	Motherboard resources
[FD800000 - FD8FFFFF]	Intel(R) 82801G (ICH7 Family) PCI Express Root Port - 27D2
[FD900000 - FD9FFFFF]	Intel(R) 82801G (ICH7 Family) PCI Express Root Port - 27D2
[FD9C0000 - FD9DFFFF]	Intel(R) 82574L Gigabit Network Connection
[FD9FC000 - FD9FFFFF]	Intel(R) 82574L Gigabit Network Connection
[FDA00000 - FDAFFFFF]	Intel(R) 82801G (ICH7 Family) PCI Express Root Port - 27D0
[FDD00000 - FDDFFFFF]	Intel(R) 82801G (ICH7 Family) PCI Express Root Port - 27D0
[FDDC0000 - FDDDFFFF]	Intel(R) 82574L Gigabit Network Connection #2
[FDDFC000 - FDDFFFFF]	Intel(R) 82574L Gigabit Network Connection #2
[FDF00000 - FDF7FFFF]	Mobile Intel(R) 945 Express Chipset Family
[FDF80000 - FDFBFFFF]	Mobile Intel(R) 945 Express Chipset Family
[FDFD0000 - FDFD0FFF]	Realtek AC'97 Audio
[FDFE0000 - FDFE1FFF]	Realtek AC'97 Audio
[FDFE0000 - FDFE3FFF]	Intel(R) 82801G (ICH7 Family) USB2 Enhanced Host Controller - 27CC
[FEB80000 - FEBFFFFF]	Mobile Intel(R) 945 Express Chipset Family
[FEC00000 - FEC0FFFF]	System board
[FED13000 - FED1DFFF]	System board
[FED20000 - FED8FFFF]	System board
[FEE00000 - FEE0FFFF]	System board
[FFB00000 - FFB7FFFF]	System board
[FFB80000 - FFBFFFFF]	Intel(R) 82802 Firmware Hub Device
[FFF00000 - FFFFFFFF]	System board

**C.3 < System IRQ Resources >**

- (ISA) 0 System timer
- (ISA) 1 Standard 101/102-Key or Microsoft Natural PS/2 Keyboard
- (ISA) 3 Communications Port (COM2)
- (ISA) 4 Communications Port (COM1)
- (ISA) 6 Standard floppy disk controller
- (ISA) 8 System CMOS/real time clock
- (ISA) 9 Microsoft ACPI-Compliant System
- (ISA) 13 Numeric data processor
- (ISA) 14 Primary IDE Channel
- (ISA) 15 Secondary IDE Channel
- (PCI) 11 Intel(R) 82801G (ICH7 Family) SMBus Controller - 27DA
- (PCI) 16 Intel(R) 82574L Gigabit Network Connection #2
- (PCI) 16 Intel(R) 82801G (ICH7 Family) PCI Express Root Port - 27D0
- (PCI) 16 Intel(R) 82801G (ICH7 Family) USB Universal Host Controller - 27CB
- (PCI) 16 Mobile Intel(R) 945 Express Chipset Family
- (PCI) 17 Intel(R) 82574L Gigabit Network Connection
- (PCI) 17 Intel(R) 82801G (ICH7 Family) PCI Express Root Port - 27D2
- (PCI) 17 Realtek AC'97 Audio
- (PCI) 18 Intel(R) 82801G (ICH7 Family) USB Universal Host Controller - 27CA
- (PCI) 19 Intel(R) 82801G (ICH7 Family) USB Universal Host Controller - 27C9
- (PCI) 23 Intel(R) 82801G (ICH7 Family) USB Universal Host Controller - 27C8
- (PCI) 23 Intel(R) 82801G (ICH7 Family) USB2 Enhanced Host Controller - 27CC



## Appendix D <Programming GPIO's>

The GPIO can be programmed with the MSDOS debug program using simple IN/OUT commands. The following lines show an example how to do this.

GPIO0.....GPIO7 bit0.....bit7

```
-o 2E 87          ;enter configuration
-o 2E 87
-o 2E 29
-o 2F 40          ;enable GPIO function
-o 2E 07
-o 2F 07          Select Logic Device 7
-o 2E F0
-o 2F xx          ;set GPIO as input/output; set '1' for input,'0'for output
-o 2E F1
-o 2F xx          ;if set GPIO's as output,in this register its value can be set
```

Optional :

```
-o 2E F2
-o 2F xx          ; Data inversion register ; '1' inverts the current value of the
                  bits ,'0' leaves them as they are
-o 2E 30
-o 2F 01          ; active GPIO's
```

For further information, please refer to Winbond W83627THF datasheet.

## Appendix E <Watch Dog timer Setting >

The watchdog timer makes the system auto-reset while it stops to work for a period. The integrated watchdog timer can be setup as system reset mode by program.

### Timeout Value Range

- 1 to 255
- Second or Minute

### Program Sample

Watchdog timer setup as system reset with 5 second of timeout

---

```

2E, 87
2E, 87
2E, 07
2F, 08      Logical Device 8
2E, 30      Activate
2F, 01
2E, F5      Set as Second*
2F, 00
2E, F6      Set as 5
2F, 05
    
```

---

\* Minute: bit 3 = 0; Second: bit 3 = 1

You can select Timer setting in the BIOS, after setting the time options, the system will reset according to the period of your selection.

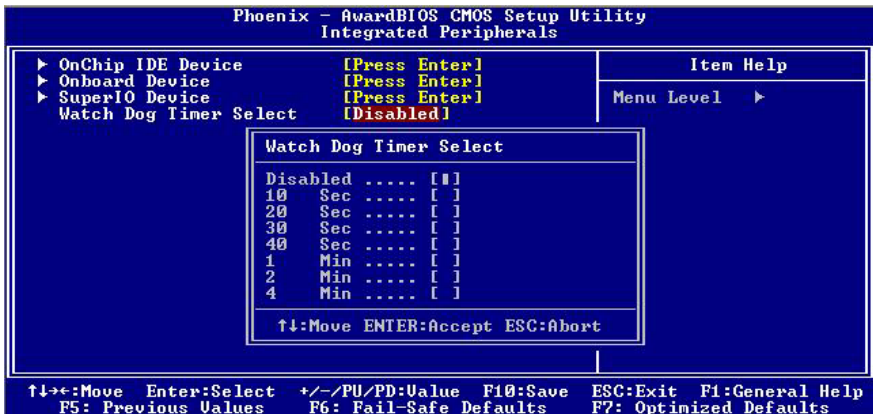

## Contact Information

Any advice or comment about our products and service, or anything we can help you please don't hesitate to contact with us. We will do our best to support you for your products, projects and business.

### Taiwan Commate Computer Inc.

---

Address	19 F No. 94, Sec. 1, Shin Tai Wu Rd., Shi Chih Taipei Hsien, Taiwan
TEL	+886-2-26963909
FAX	+886-2-26963911
Website	<a href="http://www.commell.com.tw">http://www.commell.com.tw</a>
E-Mail	<a href="mailto:info@commell.com.tw">info@commell.com.tw</a> (General Information) <a href="mailto:tech@commell.com.tw">tech@commell.com.tw</a> (Technical Support)

---

**Commell is our trademark of industrial PC division**