

FCC Information and Copyright

This equipment has been tested and found to comply with the limits of a Class B digital device, pursuant to Part 15 of the FCC Rules. These limits are designed to provide reasonable protection against harmful interference in a residential installation. This equipment generates, uses, and can radiate radio frequency energy and, if not installed and used in accordance with the instructions, may cause harmful interference to radio communications. There is no guarantee that interference will not occur in a particular installation.

The vendor makes no representations or warranties with respect to the contents here and specially disclaims any implied warranties of merchantability or fitness for any purpose. Further the vendor reserves the right to revise this publication and to make changes to the contents here without obligation to notify any party beforehand.

Duplication of this publication, in part or in whole, is not allowed without first obtaining the vendor's approval in writing.

The content of this user's manual is subject to be changed without notice and we will not be responsible for any mistakes found in this user's manual. All the brand and product names are trademarks of their respective companies.

Table of Contents

Chapter 1: Introduction	1
1.1 Before You Start	1
1.2 Package Checklist	1
1.3 Motherboard Features	2
1.4 Rear Panel Connectors	3
1.5 Motherboard Layout	4
Chapter 2: Hardware Installation	5
2.1 Installing Central Processing Unit (CPU)	5
2.2 FAN Headers	7
2.3 Installing System Memory	8
2.4 Connectors and Slots	10
Chapter 3: Headers & Jumpers Setup	12
3.1 How to Setup Jumpers	12
3.2 Detail Settings	12
Chapter 4: RAID Functions	19
4.1 Operation System	19
4.2 Raid Arrays	19
4.3 How RAID Works	19
Chapter 5: Useful Help	23
5.1 Driver Installation Note	23
5.2 Software	24
5.3 Extra Information	28
5.4 AMI BIOS Beep Code	30
5.5 Troubleshooting	31
Appendicies: SPEC In Other Language	32
German	32
France	34
Italian	36
Spanish	38
Portuguese	40
Polish	42
Russian	44
Arabic	46
Japanese	48

CHAPTER 1: INTRODUCTION

1.1 BEFORE YOU START

Thank you for choosing our product. Before you start installing the motherboard, please make sure you follow the instructions below:

- Prepare a dry and stable working environment with sufficient lighting.
- Always disconnect the computer from power outlet before operation.
- Before you take the motherboard out from anti-static bag, ground yourself properly by touching any safely grounded appliance, or use grounded wrist strap to remove the static charge.
- Avoid touching the components on motherboard or the rear side of the board unless necessary. Hold the board on the edge, do not try to bend or flex the board.
- Do not leave any unfastened small parts inside the case after installation. Loose parts will cause short circuits which may damage the equipment.
- Keep the computer from dangerous area, such as heat source, humid air and water.

1.2 PACKAGE CHECKLIST

- ✚ HDD Cable X 1
- ✚ Serial ATA Cable X 1
- ✚ Rear I/O Panel for ATX Case X 1
- ✚ Installation Guide X 1
- ✚ Fully Setup Driver CD X 1 (full version manual files inside)
- ✚ FDD Cable X 1 (optional)
- ✚ USB 2.0 Cable X1 (optional)
- ✚ S/PDIF out Cable X 1 (optional)
- ✚ Serial ATA Power Cable X 1 (optional)

Note: The package contents may differ by area or your motherboard version.

1.3 MOTHERBOARD FEATURES

SPEC			
CPU	Socket AM2+ AMD Athlon 64 / Athlon 64 FX / Athlon 64 x2 / Sempron / Phenom processors		AMD 64 Architecture enables 32 and 64 bit computing Supports Hyper Transport 3.0 and PowerNow
FSB	Support HyperTransport 3.0 Supports up to 5.2 GT/s Bandwidth		
Chipset	GeForce 8100		
Super I/O	ITE 8718F Provides the most commonly used legacy Super I/O functionality		Low Pin Count Interface Environment Control initiatives H/W Monitor ITE's "Smart Guardian" function
Main Memory	DDR2 DIMM Slots x 2 Max Memory Capacity 8GB Each DIMM supports 256MB/512MB/1GB/2GB/4GB DDR2		Dual Channel Mode DDR2 memory module Supports DDR2 533 / 667 / 800 Supports DDR2 1066 (by AM2+ CPU) Registered DIMM and ECC DIMM is not supported
Graphics	Integrated in GeForce 8100 Chipset		Max Shared Video Memory is 512MB DX10 / HDCP / PureVideo support
IDE	Integrated IDE Controller		Ultra DMA 33 / 66 / 100 / 133 Bus Master Mode supports PIO Mode 0~4,
SATA II	Integrated Serial ATA Controller		Data transfer rates up to 3 Gb/s SATA Version 2.0 specification compliant
LAN	Realtek RTL 8201CL PHY		10 / 100 Mb/s auto negotiation Half / Full duplex capability
Sound	ALC662		5.1 channels audio out High Definition Audio
Slots	PCI Express Gen2 x16 slot PCI slot	x1 x2	Supports PCI-E Gen2 x16 expansion cards Supports PCI expansion cards
On Board Connector	Floppy connector IDE Connector SATA Connector Front Panel Connector Front Audio Connector	x1 x1 x6 x1 x1	Each connector supports 2 Floppy drives Each connector supports 2 IDE device Each connector supports 1 SATA devices Supports front panel facilities Supports front panel audio function

SPEC			
	CD-in Connector	x1	Supports CD audio-in function
	S/PDIF out connector	x1	Supports digital audio out function
	CPU Fan header	x1	CPU Fan power supply (with Smart Fan function)
	System Fan header	x1	System Fan Power supply
	CMOS clear header	x1	Restore CMOS data to factory default
	USB connector	x4	Each connector supports 2 front panel USB ports
	Power Connector (24pin)	x1	Connects to Power supply
	Power Connector (4pin)	x1	Connects to Power supply
	Printer Port Connector	x1	Each connector supports 1 Printer port
	Serial port Connector	x1	Connects to RS-232 Port
Back Panel I/O	PS/2 Keyboard	x1	Connects to PS/2 Keyboard
	PS/2 Mouse	x1	Connects to PS/2 Mouse
	DVI port	x1	Connect to DVI-D monitor
	VGA port	x1	Connect to D-SUB monitor
	LAN port	x1	Connect to RJ-45 ethernet cable
	USB Port	x4	Connect to USB devices
	Audio Jack	x3	Provide Audio-In/Out and microphone connection
Board Size	190 mm(W) x 244 mm(L)		
Special Features	RAID 0 / 1 / 5 / 0+1 support Hybrid SLI support (by nVIDIA driver)		
OS Support	Windows XP / VISTA		Biostar Reserves the right to add or remove support for any OS With or without notice.

1.4 REAR PANEL CONNECTORS

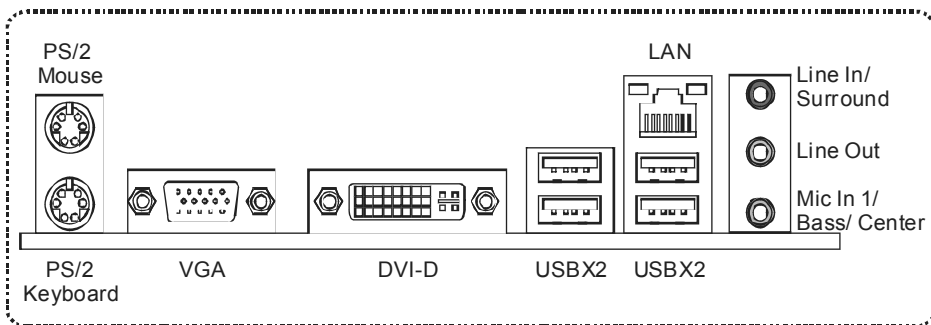

1.5 MOTHERBOARD LAYOUT

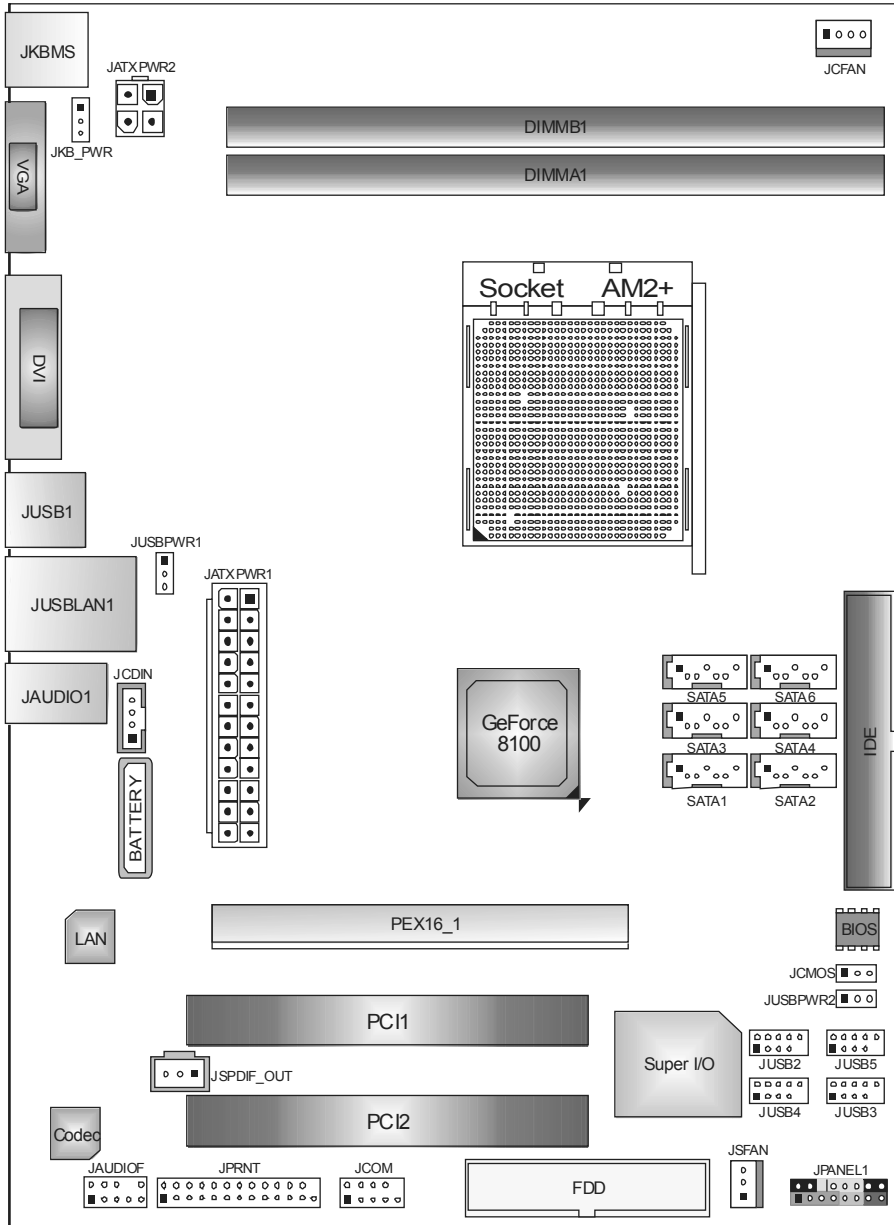

Note: ■ represents the 1st pin.

CHAPTER 2: HARDWARE INSTALLATION

2.1 INSTALLING CENTRAL PROCESSING UNIT (CPU)

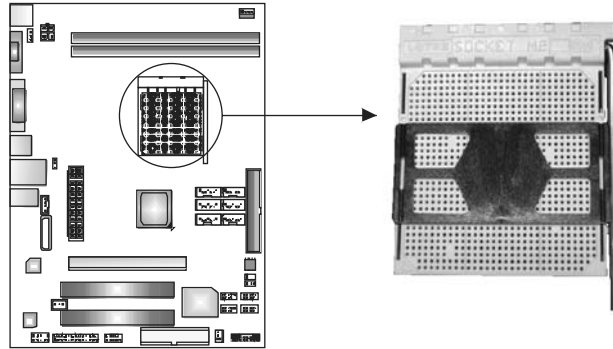

Step 1: Remove the socket protection cap.

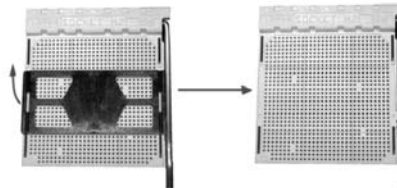

Step 2: Pull the lever toward direction A from the socket and then raise the lever up to a 90-degree angle.

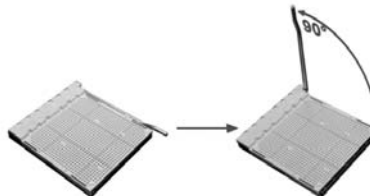

Step 3: Look for the white triangle on socket, and the gold triangle on CPU should point towards this white triangle. The CPU will fit only in the correct orientation.



Motherboard Manual

Step 4: Hold the CPU down firmly, and then close the lever toward direct B to complete the installation.

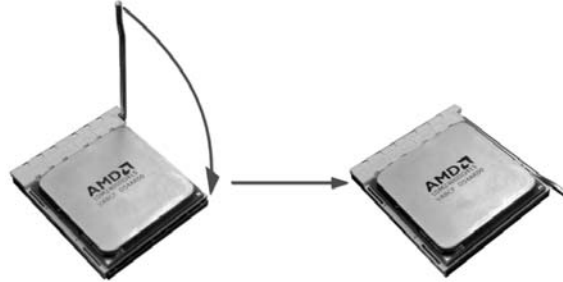

Step 5: Put the CPU Fan on the CPU and buckle it. Connect the CPU FAN power cable to the JCFAN. This completes the installation.

Note: Please update the BIOS to the latest version while using AM2+ CPUs. Due to the latest CPU transition, you may encounter the situation that the new system failed to boot while using new AM2+ CPUs. In this case, please install one standard AM2 CPU to boot your system, and update the latest BIOS from our website for AM2+ CPUs support.

2.2 FAN HEADERS

These fan headers support cooling-fans built in the computer. The fan cable and connector may be different according to the fan manufacturer. Connect the fan cable to the connector while matching the black wire to pin#1.

JCFAN: CPU Fan Header

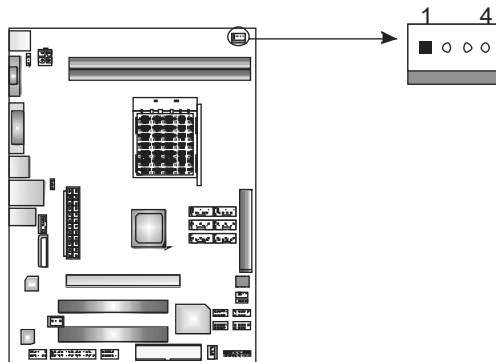

Pin	Assignment
1	Ground
2	+12V
3	FAN RPM rate sense
4	Smart Fan Control (By Fan)

JSFAN: System Fan Header

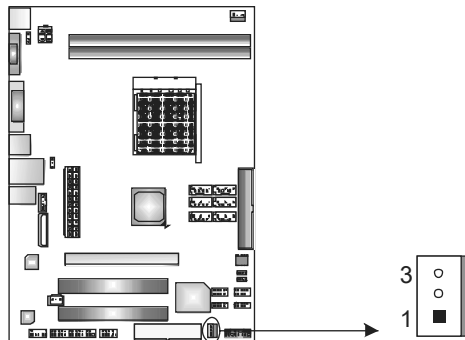

Pin	Assignment
1	Ground
2	+12V
3	FAN RPM rate sense

Note:

The JCFAN supports 4-pin head connector. The JSFAN supports 3-pin head connector. When connecting with wires onto connectors, please note that the red wire is the positive and should be connected to pin#2, and the black wire is Ground and should be connected to GND.

2.3 INSTALLING SYSTEM MEMORY

A. Memory Modules

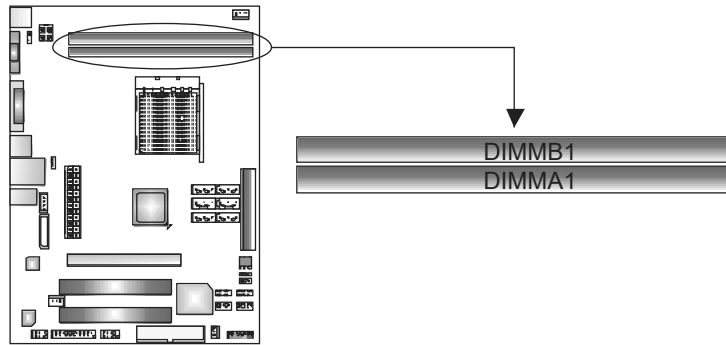

1. Unlock a DIMM slot by pressing the retaining clips outward. Align a DIMM on the slot such that the notch on the DIMM matches the break on the Slot.

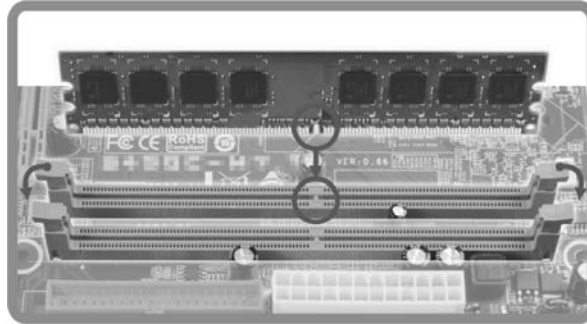

2. Insert the DIMM vertically and firmly into the slot until the retaining chip snap back in place and the DIMM is properly seated.

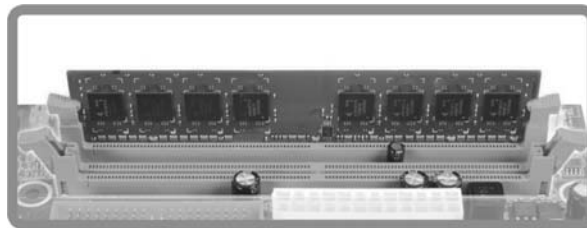

B. Memory Capacity

DIMM Socket Location	DDR2 Module	Total Memory Size
DIMMA1	256MB/512MB/1GB/2GB/4GB	Max is 8GB.
DIMMB1	256MB/512MB/1GB/2GB/4GB	

C. Dual Channel Memory installation

To trigger the Dual Channel function of the motherboard, the memory module must meet the following requirements:

Install memory module of the same density in pairs, shown in the following table.

Dual Channel Status	DIMMA1	DIMMB1
Disabled	O	X
Disabled	X	O
Enabled	O	O

(O means memory installed, X means memory not installed.)

The DRAM bus width of the memory module must be the same (x8 or x16)

2.4 CONNECTORS AND SLOTS

FDD: Floppy Disk Connector

The motherboard provides a standard floppy disk connector that supports 360K, 720K, 1.2M, 1.44M and 2.88M floppy disk types. This connector supports the provided floppy drive ribbon cable.

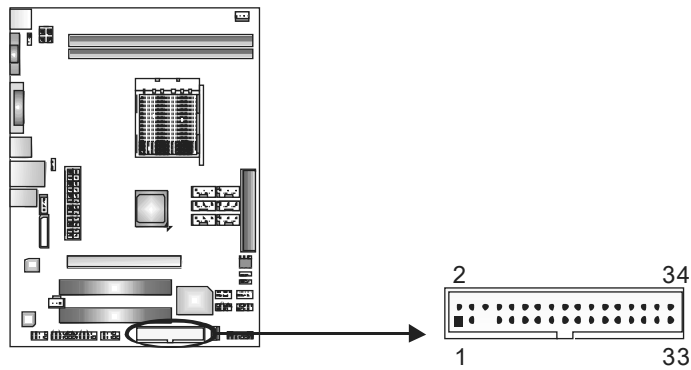

IDE: Hard Disk Connector

The motherboard has a 32-bit Enhanced PCI IDE Controller that provides PIO Mode 0~4, Bus Master, and Ultra DMA 33/66/100/133 functionality.

The IDE connector can connect a master and a slave drive, so you can connect up to two hard disk drives.

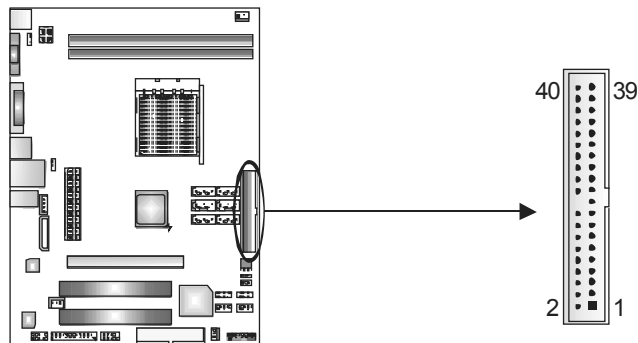

PEX16_1: PCI-Express Gen2 x16 Slot

- PCI-Express 2.0 compliant.
- Maximum theoretical realized bandwidth of 8GB/s simultaneously per direction, for an aggregate of 16GB/s totally.
- PCI-Express Gen2 supports a raw bit-rate of 5.0Gb/s on the data pins.
- 2X bandwidth over the PCI-Express 1.0 architecture.

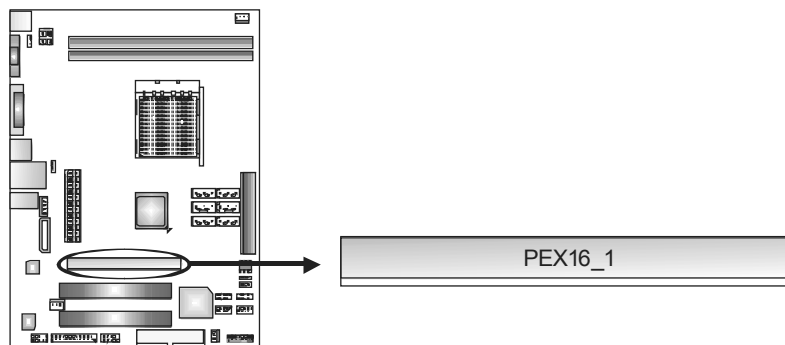

PCI1/PCI2: Peripheral Component Interconnect Slots

This motherboard is equipped with 2 standard PCI slots. PCI stands for Peripheral Component Interconnect, and it is a bus standard for expansion cards. This PCI slot is designated as 32 bits.

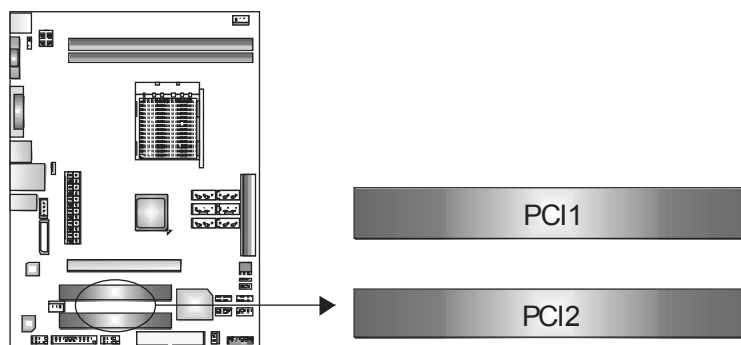

CHAPTER 3: HEADERS & JUMPERS SETUP

3.1 HOW TO SETUP JUMPERS

The illustration shows how to set up jumpers. When the jumper cap is placed on pins, the jumper is “close”, if not, that means the jumper is “open”.



3.2 DETAIL SETTINGS

J PANEL1: Front Panel Header

This 16-pin connector includes Power-on, Reset, HDD LED, Power LED, and speaker connection. It allows user to connect the PC case’s front panel switch functions.

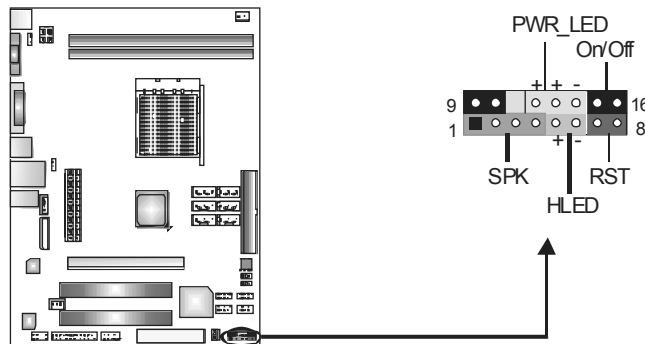

Pin	Assignment	Function	Pin	Assignment	Function
1	+5V	Speaker Connector	9	N/A	N/A
2	N/A		10	N/A	
3	N/A		11	N/A	
4	Speaker	Hard drive LED	12	Power LED (+)	Power LED
5	HDD LED (+)		13	Power LED (+)	
6	HDD LED (-)	Reset button	14	Power LED (-)	Power-on button
7	Ground		15	Power button	
8	Reset control		16	Ground	

JATXPWR1: ATX Power Source Connector

This connector allows user to connect 24-pin power connector on the ATX power supply.

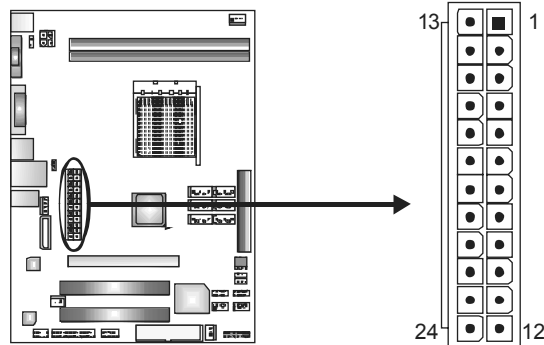

Pin	Assignment	Pin	Assignment
13	+3.3V	1	+3.3V
14	-12V	2	+3.3V
15	Ground	3	Ground
16	PS_ON	4	+5V
17	Ground	5	Ground
18	Ground	6	+5V
19	Ground	7	Ground
20	NC	8	PW_OK
21	+5V	9	Standby Voltage+5V
22	+5V	10	+12V
23	+5V	11	+12V
24	Ground	12	+3.3V

JATXPWR2: ATX Power Source Connector

By connecting this connector, it will provide +12V to CPU power circuit.

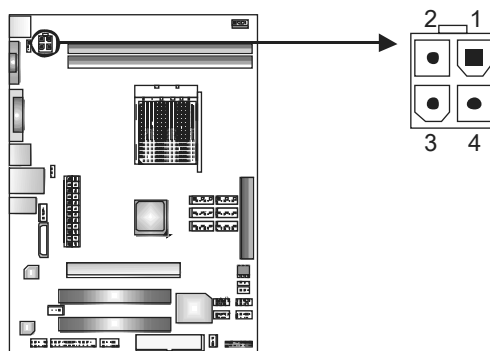

Pin	Assignment
1	+12V
2	+12V
3	Ground
4	Ground

Note:

Before power on the system, please make sure that both JATXPWR1 and JATXPWR2 connectors have been plugged-in.

JUSB2~JUSB5: Headers for USB 2.0 Ports at Front Panel

These headers allow user to connect additional USB cable on the PC front panel, and also can be connected with internal USB devices, like USB card reader.

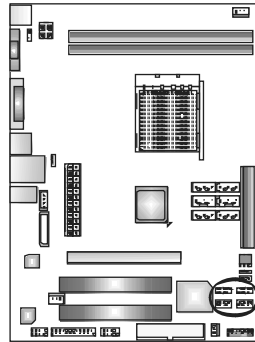

JUSB2 JUSB5
JUSB4 JUSB3

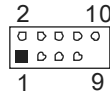

Pin	Assignment
1	+5V (fused)
2	+5V (fused)
3	USB-
4	USB-
5	USB+
6	USB+
7	Ground
8	Ground
9	NC
10	Key

SATA1~SATA6: Serial ATA Connectors

The motherboard has a PCI to SATA Controller with 6 channels SATA interface, it satisfies the SATA 2.0 spec and with transfer rate of 3.0Gb/s.

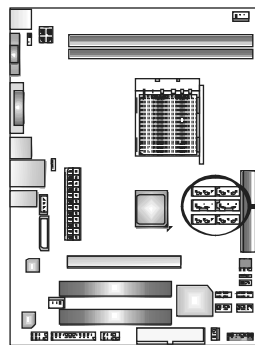

SATA5 SATA6
SATA3 SATA4
SATA1 SATA2

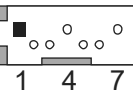

Pin	Assignment
1	Ground
2	TX+
3	TX-
4	Ground
5	RX-
6	RX+
7	Ground

Note:

Due to the chipset's specification, SATA5 and SATA6 do not support SATA mode, only support AHCI+RAID mode.

JSPDIF_OUT: Digital Audio-out Connector

This connector allows user to connect the PCI bracket SPDIF output header.

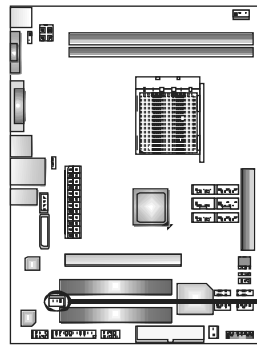

Pin	Assignment
1	+5V
2	SPDIF_OUT
3	Ground

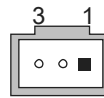

JAUDIOF: Front Panel Audio Header

This header allows user to connect the front audio output cable with the PC front panel. This header allows only HD audio front panel connector; AC'97 connector is not acceptable.

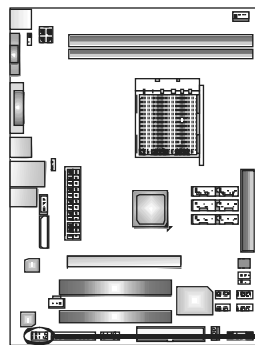

Pin	Assignment
1	Mic Left in
2	Ground
3	Mic Right in
4	GPIO
5	Right line in
6	Jack Sense
7	Front Sense
8	Key
9	Left line in
10	Jack Sense

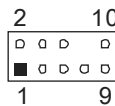

JCDIN: CD-ROM Audio-in Connector

This connector allows user to connect the audio source from the variety devices, like CD-ROM, DVD-ROM, PCI sound card, PCI TV turner card etc.

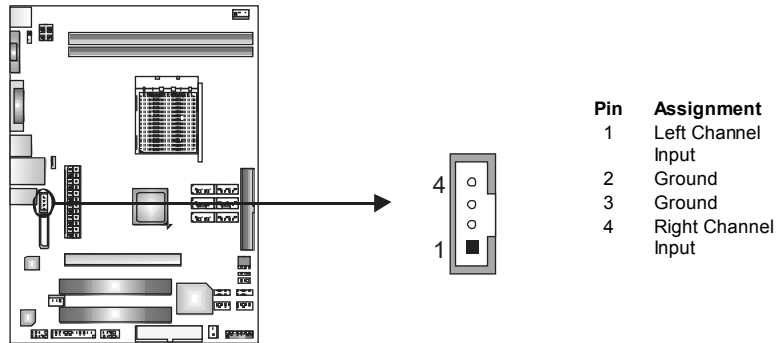

JCMOS: Clear CMOS Header

By placing the jumper on pin2-3, it allows user to restore the BIOS safe setting and the CMOS data, please carefully follow the procedures to avoid damaging the motherboard.

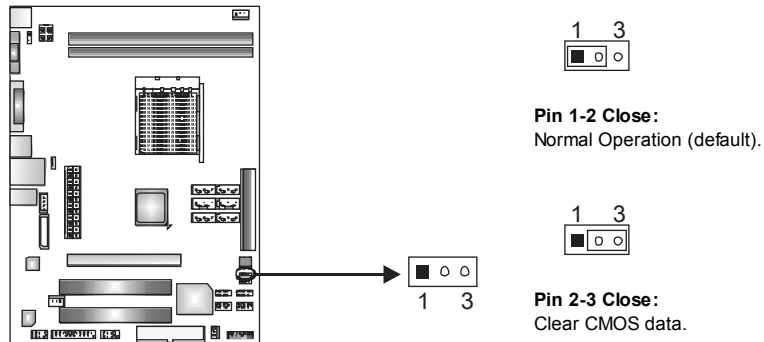

※ Clear CMOS Procedures:

1. Remove AC power line.
2. Set the jumper to "Pin 2-3 close".
3. Wait for five seconds.
4. Set the jumper to "Pin 1-2 close".
5. Power on the AC.
6. Reset your desired password or clear the CMOS data.

JPRNT: Printer Port Connector

This header allows you to connect printer port on the PC.

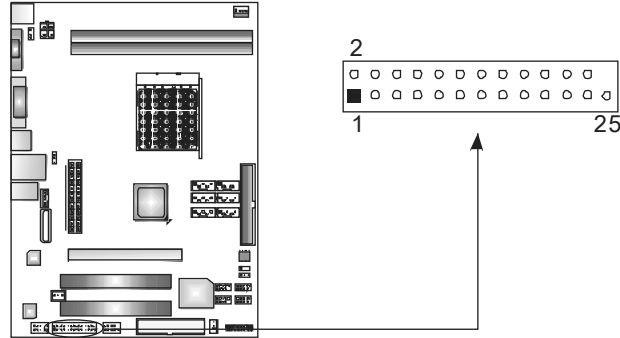

Pin	Assignment	Pin	Assignment
1	-Strobe	14	Ground
2	-ALF	15	Data 6
3	Data 0	16	Ground
4	-Error	17	Data 7
5	Data 1	18	Ground
6	-Init	19	-ACK
7	Data 2	20	Ground
8	-Scltin	21	Busy
9	Data 3	22	Ground
10	Ground	23	PE
11	Data 4	24	Ground
12	Ground	25	SCLT
13	Data 5	26	Key

JCOM: Serial port Connector

The motherboard has a Serial Port Connector for connecting RS-232 Port.

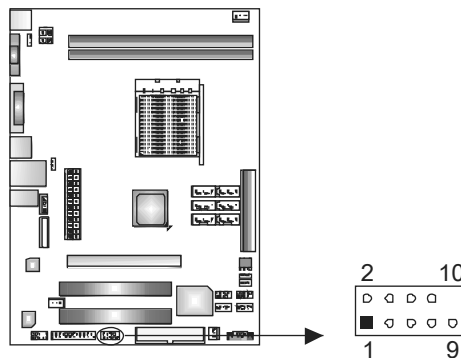

Pin	Assignment
1	Carrier detect
2	Received data
3	Transmitted data
4	Data terminal ready
5	Signal ground
6	Data set ready
7	Request to send
8	Clear to send
9	Ring indicator
10	NC

JUSBPWR1/JUSBPWR2: Power Source Headers for USB Ports

Pin 1-2 Close:

JUSBPWR1: +5V for USB ports at JUSB1/JUSBLAN1.

JUSBPWR2: +5V for USB ports at front panel (JUSB2~JUSB5).

Pin 2-3 Close:

JUSBPWR1: +5V STB for USB ports at JUSB1/JUSBLAN1.

JUSBPWR2: +5V STB for USB ports at front panel (JUSB2~JUSB5).

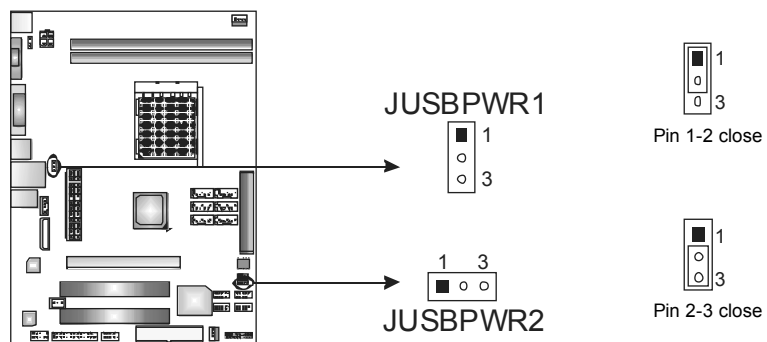

JKB_PWR: Power Source Header for PS/2 Keyboard and Mouse

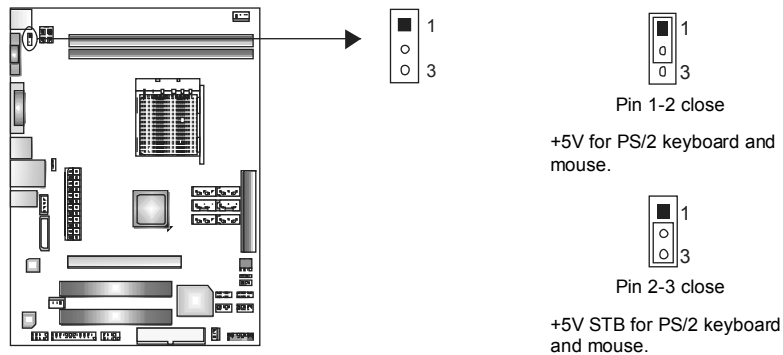

CHAPTER 4: RAID FUNCTIONS

4.1 OPERATION SYSTEM

Supports Windows XP Home/Professional Edition, and Windows Vista.

4.2 RAID ARRAYS

RAID supports the following types of RAID arrays:

RAID 0: RAID 0 defines a disk striping scheme that improves disk read and write times for many applications.

RAID 1: RAID 1 defines techniques for mirroring data.

RAID 0+1: RAID 0+1 combines the techniques used in RAID 0 and RAID 1.

RAID 5: RAID 5 provides fault tolerance and better utilization of disk capacity.

4.3 How RAID WORKS

RAID 0:

The controller “stripes” data across multiple drives in a RAID 0 array system. It breaks up a large file into smaller blocks and performs disk reads and writes across multiple drives in parallel. The size of each block is determined by the stripe size parameter, which you set during the creation of the RAID set based on the system environment. This technique reduces overall disk access time and offers high bandwidth.

Features and Benefits

- **Drives:** Minimum 2, and maximum is up to 6 or 8. Depending on the platform.
- **Uses:** Intended for non-critical data requiring high data throughput, or any environment that does not require fault tolerance.
- **Benefits:** provides increased data throughput, especially for large files. No capacity loss penalty for parity.
- **Drawbacks:** Does not deliver any fault tolerance. If any drive in the array fails, all data is lost.
- **Fault Tolerance:** No.

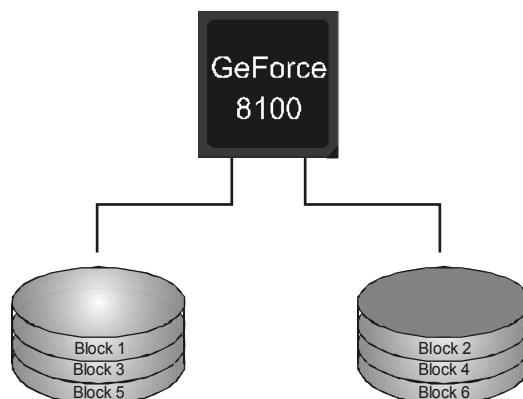

RAID 1:

Every read and write is actually carried out in parallel across 2 disk drives in a RAID 1 array system. The mirrored (backup) copy of the data can reside on the same disk or on a second redundant drive in the array. RAID 1 provides a hot-standby copy of data if the active volume or drive is corrupted or becomes unavailable because of a hardware failure.

RAID techniques can be applied for high-availability solutions, or as a form of automatic backup that eliminates tedious manual backups to more expensive and less reliable media.

Features and Benefits

- **Drives:** Minimum 2, and maximum is 2.
- **Uses:** RAID 1 is ideal for small databases or any other application that requires fault tolerance and minimal capacity.
- **Benefits:** Provides 100% data redundancy. Should one drive fail, the controller switches to the other drive.
- **Drawbacks:** Requires 2 drives for the storage space of one drive. Performance is impaired during drive rebuilds.
- **Fault Tolerance:** Yes.

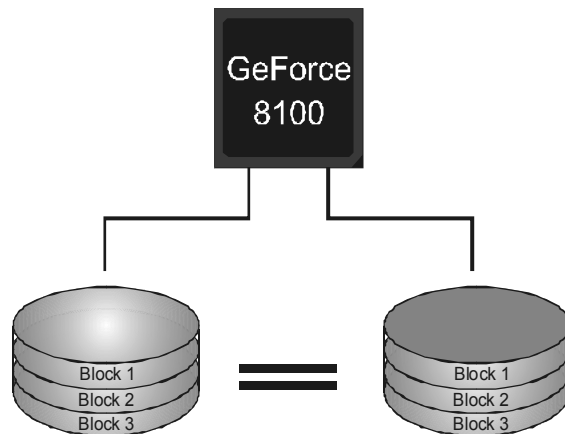

RAID 0+1:

RAID 0 drives can be mirrored using RAID 1 techniques. Resulting in a RAID 0+1 solution for improved performance plus resiliency.

Features and Benefits

- **Drives:** Minimum 4, and maximum is 6 or 8, depending on the platform.
- **Benefits:** Optimizes for both fault tolerance and performance, allowing for automatic redundancy. May be simultaneously used with other RAID levels in an array, and allows for spare disks.
- **Drawbacks:** Requires twice the available disk space for data redundancy, the same as RAID level 1.
- **Fault Tolerance:** Yes.

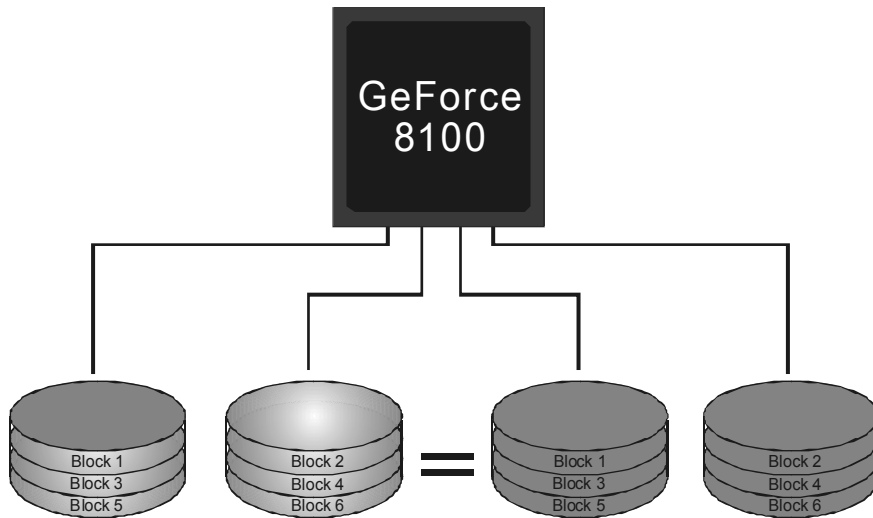

RAID 5:

RAID 5 stripes both data and parity information across three or more drives. It writes data and parity blocks across all the drives in the array. Fault tolerance is maintained by ensuring that the parity information for any given block of data is placed on a different drive from those used to store the data itself.

Features and Benefits

- **Drives:** Minimum 3.
- **Uses:** RAID 5 is recommended for transaction processing and general purpose service.
- **Benefits:** An ideal combination of good performance, good fault tolerance, and high capacity and storage efficiency.
- **Drawbacks:** Individual block data transfer rate same as a single disk. Write performance can be CPU intensive.
- **Fault Tolerance:** Yes.

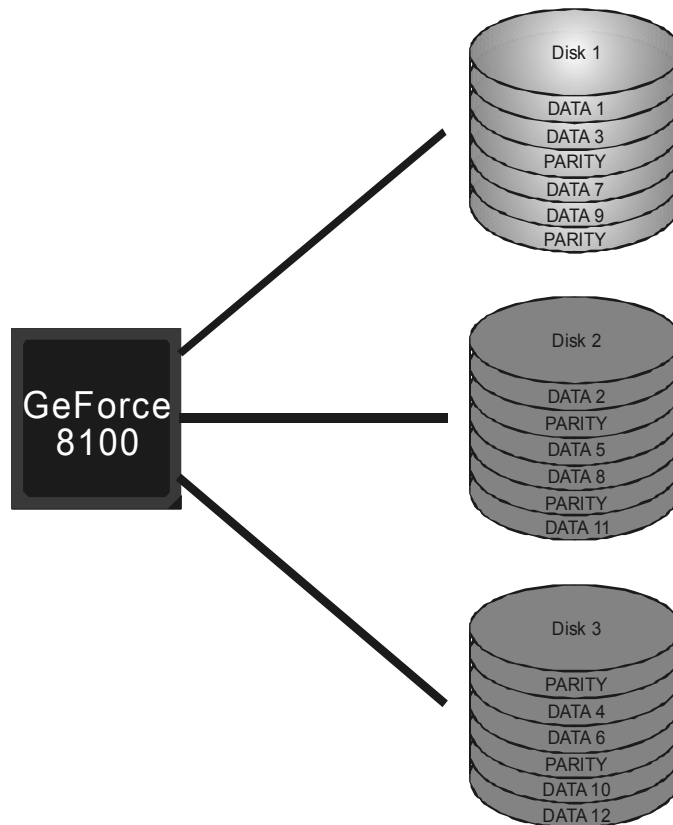

※ For more detailed setup information, please refer to the Driver CD, or go to http://www.nvidia.com/object/IO_28159.html to download the NVIDIA RAID User's Guide.

CHAPTER 5: USEFUL HELP

5.1 DRIVER INSTALLATION NOTE

After you installed your operating system, please insert the Fully Setup Driver CD into your optical drive and install the driver for better system performance.

You will see the following window after you insert the CD



The setup guide will auto detect your motherboard and operating system.

Note:

If this window didn't show up after you insert the Driver CD, please use file browser to locate and execute the file **SETUP.EXE** under your optical drive.

A. Driver Installation

To install the driver, please click on the Driver icon. The setup guide will list the compatible driver for your motherboard and operating system. Click on each device driver to launch the installation program.

B. Software Installation

To install the software, please click on the Software icon. The setup guide will list the software available for your system, click on each software title to launch the installation program.

C. Manual

Aside from the paperback manual, we also provide manual in the Driver CD. Click on the Manual icon to browse for available manual.

Note:

You will need Acrobat Reader to open the manual file. Please download the latest version of Acrobat Reader software from <http://www.adobe.com/products/acrobat/readstep2.html>

5.2 SOFTWARE

Installing Software

1. Insert the Setup CD to the optical drive. The drivers installation program would appear if the Autorun function has been enabled.
2. Select **Software Installation**, and then click on the respective software title.
3. Follow the on-screen instructions to complete the installation.

Launching Software

After the installation process, you will see the software icon “eHOT Line” / “BIOS Update” appears on the desktop. Double-click the icon to launch the utility.

eHot-Line (Optional)

eHot-Line is a convenient utility that helps you to contact with our Tech-Support system. This utility will collect the system information which is useful for analyzing the problem you may have encountered, and then send these information to our tech-support department to help you fix the problem.

 Before you use this utility, please set Outlook Express as your default e-mail client application program.

*represents important information that you must provide. Without this information, you may not be able to send out the mail.

This block will show the information which would be collected in the mail.

*Describe condition of your system.

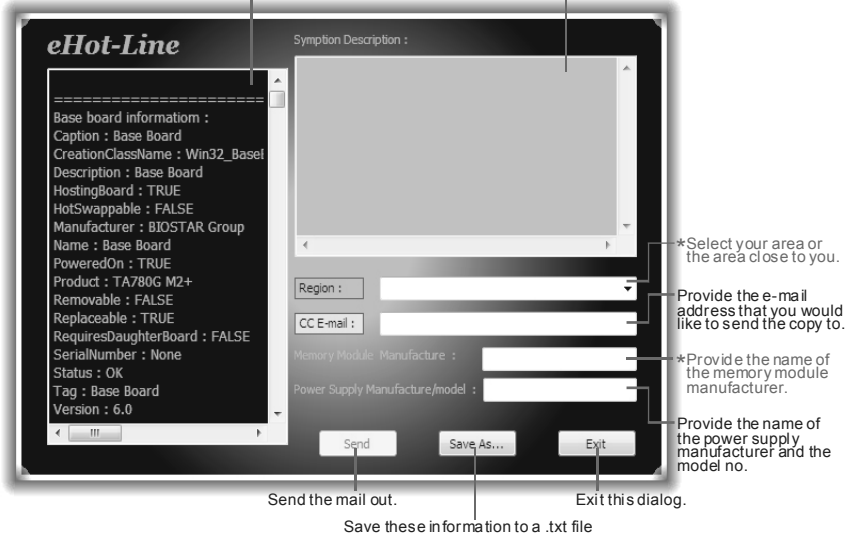

The screenshot shows the eHot-Line utility window. On the left, a text area displays system information: Base board information: Caption: Base Board, CreationClassName: Win32_Base, Description: Base Board, HostingBoard: TRUE, HotSwappable: FALSE, Manufacturer: BIOSTAR Group, Name: Base Board, PoweredOn: TRUE, Product: TA780G M2+, Removable: FALSE, Replaceable: TRUE, RequiresDaughterBoard: FALSE, SerialNumber: None, Status: OK, Tag: Base Board, Version: 6.0. The main area is titled 'Sympton Description' and contains a large text input field. Below this are fields for 'Region', 'CC E-mail', 'Memory Module Manufacture', and 'Power Supply Manufacture/model'. At the bottom are 'Send', 'Save As...', and 'Exit' buttons. Annotations with arrows point to various parts of the interface: the left text area, the Sympton Description field, the Region dropdown, the CC E-mail field, the Memory Module Manufacture field, the Power Supply Manufacture/model field, the Send button, the Save As... button, and the Exit button.

*Select your area or the area close to you.

Provide the e-mail address that you would like to send the copy to.

*Provide the name of the memory module manufacturer.

Provide the name of the power supply manufacturer and the model no.

Send the mail out.

Save these information to a .txt file

Exit this dialog.

After filling up this information, click **“Send”** to send the mail out. A warning dialog would appear asking for your confirmation; click **“Send”** to confirm or **“Do Not Send”** to cancel.



If you want to save this information to a .txt file, click **“Save As...”** and then you will see a saving dialog appears asking you to enter file name.

Enter the file name and then click **“Save”**. Your system information will be saved to a .txt file.

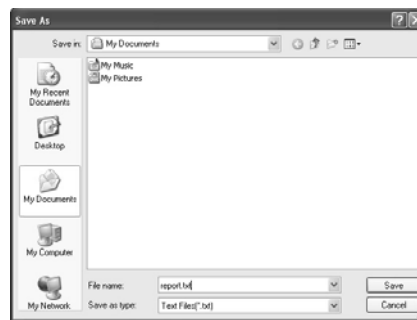

Open the saved .txt file, you will see your system information including motherboard/BIOS/CPU/video/device/OS information. This information is also concluded in the sent mail.



We will not share customer’s data with any other third parties, so please feel free to provide your system information while using eHot-Line service.



If you are not using Outlook Express as your default e-mail client application, you may need to save the system information to a .txt file and send the file to our tech support with other e-mail application. Go to the following web <http://www.biostar.com.tw/app/en-us/about/contact.php> for getting our contact information.

BIOS Update

BIOS Update is a convenient utility which allows you to update your motherboard BIOS under Windows system.

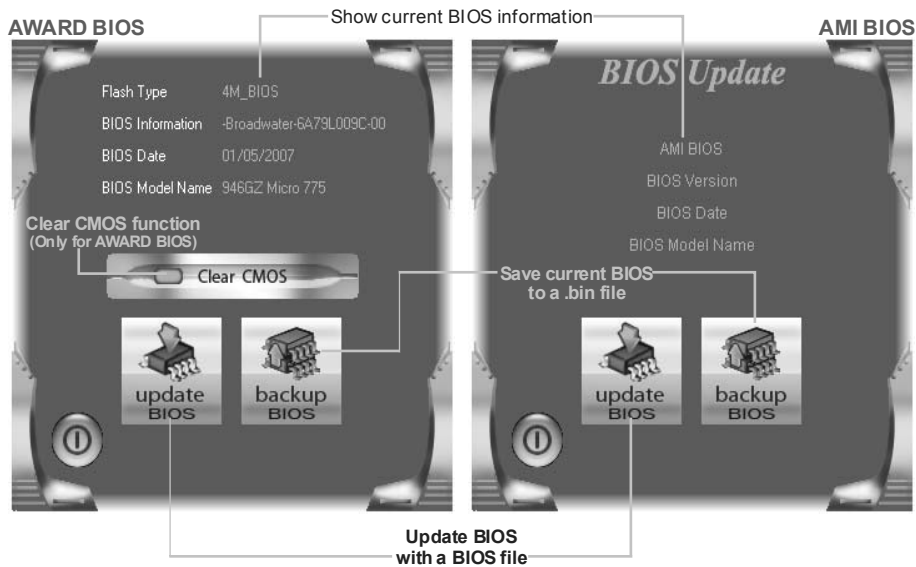

<Backup BIOS>

Once click on this button, the saving dialog will show. Choose the position to save file and enter file name. (We recommend that the file name should be English/number and no longer than 7 characters.) Then click **Save**.

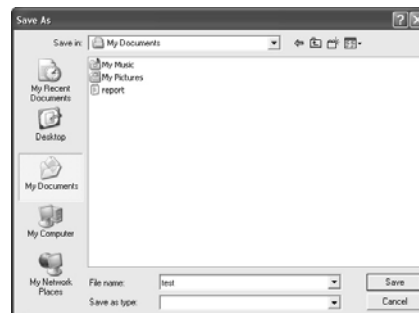

After the saving process, finish dialog will show. Click on **OK** to complete the BIOS Backup procedure.

<Update BIOS>

Before doing this, please download the proper BIOS file from the website.

For AWARD BIOS, update BIOS procedure should be run with Clear CMOS function, so please check on Clear CMOS first.

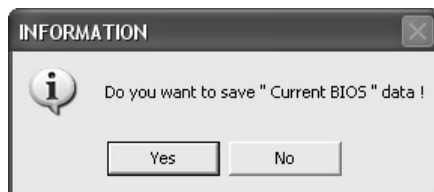

Then click Update BIOS button, a dialog will show for asking you backup current BIOS. Click **Yes** for BIOS backup and refer to the Backup BIOS procedure; or click **No** to skip this procedure.

After the BIOS Backup procedure, the open dialog will show for requesting the BIOS file which is going to be updated. Please choose the proper BIOS file for updating, then click on **Open**.

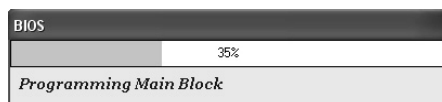

The utility will update BIOS with the proper BIOS file, and this process may take minutes. Please do not open any other applications during this process.

After the BIOS Update process, click on **OK** to restart the system.

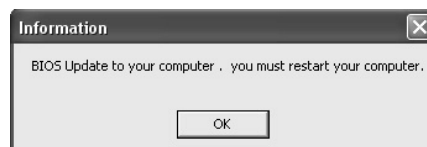

While the system boots up and the full screen logo shows, press  <Delete> key to enter BIOS setup.

In the BIOS setup, use the **Load Optimized Defaults** function and then **Save and Exit Setup** to exit BIOS setup. BIOS Update is completed.



All the information and content above about the software are subject to be changed without notice. For better performance, the software is being continuously updated. The information and pictures described above are for your reference only. The actual information and settings on board may be slightly different from this manual.

5.3 EXTRA INFORMATION

CPU Overheated

If the system shutdown automatically after power on system for seconds, that means the CPU protection function has been activated.

When the CPU is over heated, the motherboard will shutdown automatically to avoid a damage of the CPU, and the system may not power on again.

In this case, please double check:

1. The CPU cooler surface is placed evenly with the CPU surface.
2. CPU fan is rotated normally.
3. CPU fan speed is fulfilling with the CPU speed.

After confirmed, please follow steps below to relief the CPU protection function.

1. Remove the power cord from power supply for seconds.
2. Wait for seconds.
3. Plug in the power cord and boot up the system.

Or you can:

1. Clear the CMOS data.
(See "Close CMOS Header: JCMOS1" section)
2. Wait for seconds.
3. Power on the system again.

BIO-Flasher

BIO-Flasher is a BIOS flashing utility providing you an easy and simple way to update your BIOS via USB pen drive or floppy disk.

The BIO-Flasher is built in the BIOS chip. To enter the utility, **press <F12> during the Power-On Self Tests (POST)** procedure while booting up.

Updating BIOS with BIO-Flasher

1. Go to the website to download the latest BIOS file for the motherboard.
2. Then, save the BIOS file into a USB pen drive or a floppy disk.
3. Insert the USB pen drive or the floppy disk that contains the BIOS file to the USB port or the floppy disk drive.
4. Power on or reset the computer and then press **<F12>** during the **POST** process. A select dialog as the picture on the right appears. Select the device contains the BIOS file and press **<Enter>** to enter the utility.



5. The utility will show the BIOS files and their respective information. Select the proper BIOS file and press **<Enter>** then **<Y>** to perform the BIOS update process.

6. After the update process, the utility will ask you to reboot the system. Press **<Y>** to proceed. BIOS update completes.



- This utility only allows storage device with FAT32/16 format and single partition.
- Shutting down or resetting the system while updating the BIOS will lead to system boot failure.

5.4 AMI BIOS BEEP CODE

Boot Block Beep Codes

Number of Beeps	Description
1	No media present. (Insert diskette in floppy drive A:)
2	"AMIBOOT.ROM" file not found in root directory of diskette in A:
3	Insert next diskette if multiple diskettes are used for recovery
4	Flash Programming successful
5	File read error
7	No Flash EPROM detected
10	Flash Erase error
11	Flash Program error
12	"AMIBOOT.ROM" file size error
13	BIOS ROM image mismatch (file layout does not match image present in flash device)

POST BIOS Beep Codes

Number of Beeps	Description
1	Memory refresh timer error
3	Base memory read/write test error
6	Keyboard controller BAT command failed
7	General exception error (processor exception interrupt error)
8	Display memory error (system video adapter)

Troubleshooting POST BIOS Beep Codes

Number of Beeps	Troubleshooting Action
1, 3	Reseat the memory, or replace with known good modules.
6, 7	<p>Fatal error indicating a serious problem with the system. Consult your system manufacturer. Before declaring the motherboard beyond all hope, eliminate the possibility of interference by a malfunctioning add-in card. Remove all expansion cards except the video adapter.</p> <ul style="list-style-type: none"> ● If beep codes are generated when all other expansion cards are absent, consult your system manufacturer's technical support. ● If beep codes are not generated when all other expansion cards are absent, one of the add-in cards is causing the malfunction. Insert the cards back into the system one at a time until the problem happens again. This will reveal the malfunctioning card.
8	If the system video adapter is an add-in card, replace or reseat the video adapter. If the video adapter is an integrated part of the system board, the board may be faulty.

5.5 TROUBLESHOOTING

Probable	Solution
1. No power to the system at all Power light don't illuminate, fan inside power supply does not turn on. 2. Indicator light on keyboard does not turn on.	1. Make sure power cable is securely plugged in. 2. Replace cable. 3. Contact technical support.
System inoperative. Keyboard lights are on, power indicator lights are lit, and hard drive is spinning.	Using even pressure on both ends of the DIMM, press down firmly until the module snaps into place.
System does not boot from hard disk drive, can be booted from optical drive.	1. Check cable running from disk to disk controller board. Make sure both ends are securely plugged in; check the drive type in the standard CMOS setup. 2. Backing up the hard drive is extremely important. All hard disks are capable of breaking down at any time.
System only boots from optical drive. Hard disk can be read and applications can be used but booting from hard disk is impossible.	1. Back up data and applications files. 2. Reformat the hard drive. Re-install applications and data using backup disks.
Screen message says "Invalid Configuration" or "CMOS Failure."	Review system's equipment. Make sure correct information is in setup.
Cannot boot system after installing second hard drive.	1. Set master/slave jumpers correctly. 2. Run SETUP program and select correct drive types. Call the drive manufacturers for compatibility with other drives.

APPENDENCIES: SPEC IN OTHER LANGUAGE**GERMAN**

<i>Spezifikationen</i>		
CPU	Sockel AM2+ AMD Athlon 64 / Athlon 64 FX / Athlon 64 X2 / Sempron / Phenom Prozessoren	Die AMD 64-Architektur unterstützt eine 32-Bit- und 64-Bit-Datenverarbeitung Unterstützt Hyper Transport 3.0 und PowerNow
FSB	Unterstützt HyperTransport 3.0 mit einer Bandbreite von bis zu 5.2 GT/s	
Chipsatz	GeForce 8100	
Super E/A	ITE8718F Bietet die häufig verwendeten alten Super E/A-Funktionen.	Low Pin Count-Schnittstelle Umgebungskontrolle, Hardware-Überwachung "Smart Guardian"-Funktion von ITE
Arbeitsspeicher	DDR2 DIMM-Steckplätze x 2 Max. 8GB Arbeitsspeicher Jeder DIMM unterstützt 256MB/512MB/1GB/2GB/4GB DDR2.	Dual-Kanal DDR2 Speichermodul Unterstützt DDR2 533 / 667 / 800 Unterstützt DDR2 1066 (by AM2+ CPU) registrierte DIMMs. ECC DIMMs werden nicht unterstützt.
Grafik	Integrierter GeForce 8100-Chipsatz	Max. 512MB gemeinsam benutzter Videospeicher Unterstützt DX10 / HDCP / PureVideo
IDE	Integrierter IDE-Controller	Ultra DMA 33 / 66 / 100 / 133 Bus Master-Modus Unterstützt PIO-Modus 0~4,
SATA	Integrierter Serial ATA-Controller	Datentransferrate bis zu 3 Gb/s Konform mit der SATA-Spezifikation Version 2.0.
LAN	Realtek RTL 8201CL PHY	10 / 100 Mb/s Auto-Negotiation Halb-/ Vollduplex-Funktion
HD Audio-Unterstützung	ALC662	5.1-Kanal-Audioausgabe Unterstützt High-Definition Audio
Steckplätze	PCI Express Gen2 x16 Steckplatz x1 PCI-Steckplatz x2	

Spezifikationen			
Onboard-Anschluss	Diskettenlaufwerkanschluss	x1	Jeder Anschluss unterstützt 2 Diskettenlaufwerke
	IDE-Anschluss	x1	Jeder Anschluss unterstützt 2 IDE-Laufwerke
	SATA-Anschluss	x6	Jeder Anschluss unterstützt 1 SATA-Laufwerk
	Fronttafelanschluss	x1	Unterstützt die Fronttafel-funktionen
	Front-Audioanschluss	x1	Unterstützt die Fronttafel-Audioanschlussfunktion
	CD-IN-Anschluss	x1	Unterstützt die CD Audio-In-Funktion
	S/PDIF- Ausgangsanschluss	x1	Unterstützt die digitale Audioausgabefunktion
	CPU-Lüfter-Sockel	x1	CPU-Lüfterstromversorgungsanschluss (mit Smart Fan-Funktion)
	System-Lüfter-Sockel	x1	System-Lüfter-Stromversorgungsanschluss
	"CMOS löschen"-Sockel	x1	
	USB-Anschluss	x4	Jeder Anschluss unterstützt 2 Fronttafel-USB-Anschlüsse
	Stromanschluss (24-polig)	x1	
Stromanschluss (4-polig)	x1		
Druckeranschluss Anschluss	x1	Jeder Anschluss unterstützt 1 Druckeranschluss	
Serieller Anschluss	x1		
Rückseiten-E/A	PS/2-Tastatur	x1	
	PS/2-Maus	x1	
	VGA-Anschluss	x1	
	LAN-Anschluss	x1	
	USB-Anschluss	x4	
	Audioanschluss	x3	
DVI-Anschluss	x1		
Platinengröße	190 mm (B) X 244 mm (L)		
Sonderfunktionen	Unterstützt RAID 0 / 1 / 5 / 0+1		
	Unterstützt Hybrid SLI (by nVIDIA driver)		
OS-Unterstützung	Windows XP / VISTA		Biostar behält sich das Recht vor, ohne Ankündigung die Unterstützung für ein Betriebssystem hinzuzufügen oder zu entfernen.

FRANCE

SPEC		
UC	Socket AM2+ Processeurs AMD Athlon 64 / Athlon 64 FX / Athlon 64 X2 / Sempron / Phenom	L'architecture AMD 64 permet le calcul 32 et 64 bits Prend en charge Hyper Transport 3.0 et PowerNow
Bus frontal	Prend en charge Hyper Transport 3.0 jusqu'à une bande passante de 5.2 GT/s	
Chipset	GeForce 8100	
Super E/S	ITE 8718F Fournit la fonctionnalité de Super E/S patrimoniales la plus utilisée.	Interface à faible compte de broches Initiatives de contrôle environnementales, Moniteur de matériel Fonction "Gardien intelligent" de l'ITE
Mémoire principale	Fentes DDR2 DIMM x 2 Capacité mémoire maximale de 8 Go Chaque DIMM prend en charge des DDR2 de 256Mo/512Mo/1Go/2Go/4Go	Module de mémoire DDR2 à mode à double voie Prend en charge la DDR2 533 / 667 / 800 Prend en charge la DDR2 1066 (by AM2+ CPU) Les DIMM à registres et DIMM avec code correcteurs d'erreurs ne sont pas prises en charge
Graphiques	Intégré dans la chipset GeForce 8100	Mémoire vidéo partagée maximale de 512 Mo Prise en charge DX10 / HDCP / PureVideo
IDE	Contrôleur IDE intégré	Mode principale de Bus Ultra DMA 33 / 66 / 100 / 133 Prend en charge le mode PIO 0~4,
SATA	Contrôleur Serial ATA intégré	Taux de transfert jusqu'à 3 Go/s. Conforme à la spécification SATA Version 2.0
LAN	Realtek RTL 8201CL PHY	10 / 100 Mb/s négociation automatique Half / Full duplex capability
Prise en charge audio HD	ALC662	Sortie audio à 5.1 voies Prise en charge de l'audio haute définition
Fentes	Fente PCI Express Gen2 x16 x1 Fente PCI x2	
Connecteur embarqué	Connecteur de disquette x1 Connecteur IDE x1 Connecteur SATA x6	Chaque connector prend en charge 2 lecteurs de disquettes Chaque connecteur prend en charge 2 périphériques IDE Chaque connecteur prend en charge 1 périphérique SATA

SPEC			
	Connecteur du panneau avant	x1	Prend en charge les équipements du panneau avant
	Connecteur Audio du panneau avant	x1	Prend en charge la fonction audio du panneau avant
	Connecteur d'entrée CD	x1	Prend en charge la fonction d'entrée audio de CD
	Connecteur de sortie S/PDIF	x1	Prend en charge la fonction de sortie audio numérique
	Embase de ventilateur UC	x1	Alimentation électrique du ventilateur UC (avec fonction de ventilateur intelligent)
	Embase de ventilateur système	x1	Alimentation électrique du ventilateur système
	Embase d'effacement CMOS	x1	
	Connecteur USB	x4	Chaque connecteur prend en charge 2 ports USB de panneau avant
	Connecteur d'alimentation (24 broches)	x1	
	Connecteur d'alimentation (4 broches)	x1	
	Connecteur de Port d'imprimante	x1	Chaque connector prend en charge 1 Port d'imprimante
	Connecteur de Port série	x1	
E/S du panneau arrière	Clavier PS/2	x1	
	Souris PS/2	x1	
	Port VGA	x1	
	Port LAN	x1	
	Port USB	x4	
	Fiche audio	x3	
	Port DVI	x1	
Dimension s de la carte	190 mm (l) X 244 mm (H)		
Fonctionnalités spéciales	Prise en charge RAID 0 / 1 / 5 / 0+1 Prise en charge Hybrid SLI (by nVIDIA driver)		
Support SE	Windows XP / VISTA		Biostar se réserve le droit d'ajouter ou de supprimer le support de SE avec ou sans préavis.

ITALIAN

SPECIFICA		
CPU	Socket AM2+ Processori AMD Athlon 64 / Athlon 64 FX / Athlon 64 X2 / Sempron / Phenom	L'architettura AMD 64 abilita la computazione 32 e 64 bit Supporto di Hyper Transport 3.0 e PowerNow
FSB	Supporto di HyperTransport 3.0 fino a 5.2 GT/s di larghezza di banda	
Chipset	GeForce 8100	
Super I/O	ITE 8718F Fornisce le funzionalità legacy Super I/O usate più comunemente.	Interfaccia LPC (Low Pin Count) Funzioni di controllo dell'ambiente: Monitoraggio hardware Funzione "Smart Guardian" di ITE
Memoria principale	Alloggi DIMM DDR2 x 2 Capacità massima della memoria 8GB Ciascun DIMM supporta DDR2 256MB/512MB/1GB/2GB/4GB	Modulo di memoria DDR2 a canale doppio Supporto di DDR2 533 / 667 / 800 Supporto di DDR2 1066 (by AM2+ CPU) DIMM registrati e DIMM ECC non sono supportati
Grafica	Integrata nel Chipset GeForce 8100	La memoria video condivisa massima è di 512 MB Supporto DX10 / HDCP / PureVideo
IDE	Controller IDE integrato	Modalità Bus Master Ultra DMA 33 / 66 / 100 / 133 Supporto modalità PIO Mode 0-4
SATA	Controller Serial ATA integrato	Velocità di trasferimento dei dati fino a 3 Gb/s. Compatibile specifiche SATA Versione 2.0.
LAN	Realtek RTL 8201CL PHY	Negoziazione automatica 10 / 100 Mb/s Capacità Half / Full Duplex
Supporto audio HD	ALC662	Uscita audio 5.1 canali Supporto audio High-Definition (HD)
Alloggi	Alloggio PCI Express Gen2 x16 x1 Alloggio PCI x2	
Connettori su scheda	Connettore floppy x1 Connettore IDE x1 Connettore SATA x6 Connettore pannello frontale x1	Ciascun connettore supporta 2 unità Floppy Ciascun connettore supporta 2 unità IDE Ciascun connettore supporta 1 unità SATA Supporta i servizi del pannello frontale

SPECIFICA			
	Connettore audio frontale	x1	Supporta la funzione audio pannello frontale
	Connettore CD-in	x1	Supporta la funzione input audio CD
	Connettore output SPDIF	x1	Supporta la funzione d'output audio digitale
	Collettore ventolina CPU	x1	Alimentazione ventolina CPU (con funzione Smart Fan)
	Collettore ventolina sistema	x1	Alimentazione ventolina di sistema
	Collettore cancellazione CMOS	x1	
	Connettore USB	x4	Ciascun connettore supporta 2 porte USB pannello frontale
	Connettore alimentazione (24 pin)	x1	
	Connettore alimentazione (4 pin)	x1	
	Connettore Porta stampante	x1	Ciascun connettore supporta 1 Porta stampante
	Connettore Porta seriale	x1	
I/O pannello posteriore	Tastiera PS/2	x1	
	Mouse PS/2	x1	
	Porta VGA	x1	
	Porta LAN	x1	
	Porta USB	x4	
	Connettore audio	x3	
	Porta DVI	x1	
Dimensioni scheda	190 mm (larghezza) x 244 mm (altezza)		
Caratteristiche speciali	Supporto RAID 0 / 1 / 5 / 0+1 Supporto Hybrid SLI (by nVIDIA driver)		
Sistemi operativi supportati	Windows XP / VISTA		Biostar si riserva il diritto di aggiungere o rimuovere il supporto di qualsiasi sistema operativo senza preavviso.

SPANISH

<i>Especificación</i>			
CPU	Conector AM2+ Procesadores AMD Athlon 64 / Athlon 64 FX / Athlon 64 X2 / Sempron / Phenom		La arquitectura AMD 64 permite el procesado de 32 y 64 bits Soporta las tecnologías Hyper Transport 3.0 y PowerNow
FSB	Admite HyperTransport 3.0 con un ancho de banda de hasta 5.2 GT/s		
Conjunto de chips	GeForce 8100		
Súper E/S	ITE 8718F Le ofrece las funcionalidades heredadas de uso más común Súper E/S.		Interfaz de cuenta Low Pin Iniciativas de control de entorno, Monitor hardware Función "Guardia inteligente" de ITE
Memoria principal	Ranuras DIMM DDR2 x 2 Capacidad máxima de memoria de 8GB Cada DIMM admite DDR de 256MB/512MB/1GB/2GB/4GB		Módulo de memoria DDR2 de canal Doble Admite DDR2 de 533 / 667 / 800 Admite DDR2 de 1066 (by AM2+ CPU) No admite DIMM registrados o DIMM compatibles con ECC
Gráficos	Integrados en el conjunto de chips GeForce 8100		Memoria máxima de vídeo compartida de 512 MB Admite DX10 / HDCP / PureVideo
IDE	Controlador IDE integrado		Modo bus maestro Ultra DMA 33 / 66 / 100 / 133 Soporte los Modos PIO 0~4,
SATA	Controlador ATA Serie Integrado		Tasas de transferencia de hasta 3 Gb/s. Compatible con la versión SATA 2.0.
Red Local	Realtek RTL 8201CL PHY		Negociación de 10 / 100 Mb/s Funciones Half / Full dúplex
Soporte de sonido HD	ALC662		Salida de sonido de 5.1 canales Soporte de sonido Alta Definición
Ranuras	Ranura PCI Express Gen2 x16 Ranura PCI	X1 X2	
Conectores en placa	Conector disco flexible Conector IDE Conector SATA	X1 X1 X6	Cada conector soporta 2 unidades de disco flexible Cada conector soporta 2 dispositivos IDE Cada conector soporta 1 dispositivos SATA

Especificación			
	Conector de panel frontal	X1	Soporta instalaciones en el panel frontal
	Conector de sonido frontal	X1	Soporta funciones de sonido en el panel frontal
	Conector de entrada de CD	X1	Soporta función de entrada de sonido de CD
	Conector de salida S/PDIF	X1	Soporta función de salida de sonido digital
	Cabecera de ventilador de CPU	X1	Fuente de alimentación de ventilador de CPU (con función Smart Fan)
	Cabecera de ventilador de sistema	X1	Fuente de alimentación de ventilador de sistema
	Cabecera de borrado de CMOS	X1	
	Conector USB	X4	Cada conector soporta 2 puertos USB frontales
	Conector de alimentación (24 patillas)	X1	
	Conector de alimentación (4 patillas)	X1	
	Conector Puerto de impresora	X1	Cada conector soporta 1 Puerto de impresora
	Conector Puerto serie	X1	
Panel trasero de E/S	Teclado PS/2	X1	
	Ratón PS/2	X1	
	Puerto VGA	X1	
	Puerto de red local	X1	
	Puerto USB	X4	
	Conector de sonido	X3	
	Puerto DVI	X1	
Tamaño de la placa	190 mm. (A) X 244 Mm. (H)		
Funciones especiales	Admite RAID 0 / 1 / 5 / 0+1 Admite Hybrid SLI (by nVIDIA driver)		
Soporte de sistema operativo	Windows XP / VISTA		Biostar se reserva el derecho de añadir o retirar el soporte de cualquier SO con o sin aviso previo.

PORTUGUESE

ESPECIFICAÇÕES		
CPU	Socket AM2+ Processadores AMD Athlon 64 / Athlon 64 FX / Athlon 64 X2 / Sempron / Phenom	A arquitetura AMD 64 permite uma computação de 32 e 64 bits Suporta as tecnologias Hyper Transport 3.0 e PowerNow
FSB	Suporta a tecnologia HyperTransport 3.0 com uma largura de banda até 5.2 GT/s	
Chipset	GeForce 8100	
Especificação Super I/O	ITE 8718F Proporciona as funcionalidades mais utilizadas em termos da especificação Super I/O.	Interface LPC (Low Pin Count). Iniciativas para controlo do ambiente Monitorização do hardware Função "Smart Guardian" da ITE
Memória principal	Ranhuras DIMM DDR2 x 2 Capacidade máxima de memória: 8 GB Cada módulo DIMM suporta uma memória DDR2 de 256MB/512MB/1GB/2GB/4GB	Módulo de memória DDR2 de canal duplo Suporta módulos DDR2 533 / 667 / 800 Suporta módulos DDR2 1066 (by AM2+ CPU) Os módulos DIMM registados e os DIMM ECC não são suportados
Placa gráfica	Integrada no chipset GeForce 8100	Memória de vídeo máxima partilhada: 512 MB Suporta as funções DX10 / HDCP / PureVideo
IDE	Controlador IDE integrado	Modo Bus master Ultra DMA 33 / 66 / 100 / 133 Suporta o modo PIO 0~4,
SATA	Controlador Serial ATA integrado	Velocidades de transmissão de dados até 3 Gb/s. Compatibilidade com a especificação SATA versão 2.0.
LAN	Realtek RTL 8201CL PHY	Auto negociação de 10 / 100 Mb/s Capacidade semi/full-duplex
Suporte para áudio de alta definição	ALC662	Saída de áudio de 5.1 canais Suporta a especificação High-Definition Audio
Ranhuras	Ranhura PCI Express Gen2 x16 x1 Ranhura PCI x2	
Conectores na placa	Conector da unidade de disquetes x1 Conector IDE x1 Conector SATA x6 Conector do painel frontal x1	Cada conector suporta 2 unidades de disquetes Cada conector suporta 2 dispositivos IDE Cada conector suporta 1 dispositivo SATA Para suporte de várias funções no painel frontal

ESPECIFICAÇÕES			
	Conector de áudio frontal	x1	Suporta a função de áudio no painel frontal
	Conector para entrada de CDs	x1	Suporta a entrada de áudio a partir de CDs
	Conector de saída S/PDIF	x1	Suporta a saída de áudio digital
	Conector da ventoinha da CPU	x1	Alimentação da ventoinha da CPU (com a função Smart Fan)
	Conector da ventoinha do sistema	x1	Alimentação da ventoinha do sistema
	Conector para limpeza do CMOS	x1	
	Conector USB	x4	Cada conector suporta 2 portas USB no painel frontal
	Conector de alimentação (24 pinos)	x1	
	Conector de alimentação (4 pinos)	x1	
	Conector da para impressora	x1	Cada conector suporta 1 Porta para impressora
	Conector da Porta série	x1	
Entradas/Saídas no painel traseiro	Teclado PS/2	x1	
	Rato PS/2	x1	
	Porta VGA	x1	
	Porta LAN	x1	
	Porta USB	x4	
	Tomada de áudio	x3	
Porta DVI	x1		
Tamanho da placa	190 mm (L) X 244 mm (A)		
Características especiais	Suporta as funções RAID 0 / 1 / 5 / 0+1		
	Suporta as funções Hybrid SLI (by nVIDIA driver)		
Sistemas operativos suportados	Windows XP / VISTA		A Biostar reserva-se o direito de adicionar ou remover suporte para qualquer sistema operativo com ou sem aviso prévio.

POLISH

SPEC		
Procesor	Socket AM2+ AMD Athlon 64 / Athlon 64 FX / Athlon 64 X2 / Sempron / Phenom Procesory	Architektura AMD 64 umożliwia przetwarzanie 32 i 64 bitowe Obsługa Hyper Transport 3.0 oraz PowerNow
FSB	Obsługa HyperTransport 3.0 o szerokości pasma do 5.2 GT/s	
Chipset	GeForce 8100	
Pamięć główna	Gniazda DDR2 DIMM x 2 Maks. wielkość pamięci 8GB Każde gniazdo DIMM obsługuje moduły 256MB/512MB/1GB/2GB/4GB DDR2	Moduł pamięci DDR2 z trybem podwójnego kanału Obsługa DDR2 533 / 667 / 800 Obsługa DDR2 1066 (by AM2+ CPU) Brak obsługi Registered DIMM oraz ECC DIMM
Super I/O	ITE 8718F Zapewnia najbardziej powszechne funkcje Super I/O.	Interfejs Low Pin Count Funkcje kontroli warunków pracy, Monitor H/W Funkcja ITE "Smart Guardian"
Grafika	Zintegrowana w chipsecie GeForce 8100	Maks. wielkość współdzielonej pamięci video wynosi 512 MB Obsługa DX10 / HDCP / PureVideo
IDE	Zintegrowany kontroler IDE	Ultra DMA 33 / 66 / 100 / 133 Tryb Bus Master obsługa PIO tryb 0~4,
SATA	Zintegrowany kontroler Serial ATA	Transfer danych do 3 Gb/s. Zgodność ze specyfikacją SATA w wersji 2.0.
LAN	Realtek RTL 8201CL PHY	10 / 100 Mb/s z automatyczną negocjacją szybkości Działanie w trybie połowicznego / pełnego duplexu
Obsługa audio HD	ALC662	5.1 kanałowe wyjście audio Obsługa High-Definition Audio
Gniazda	Gniazdo PCI Express Gen2 x16 x1 Gniazdo PCI x2	
Złącza wbudowane	Złącze napędu dyskietek x1 Złącze IDE x1 Złącze SATA x6	Każde złącze obsługuje 2 napędy dyskietek Każde złącze obsługuje 2 urządzenia IDE Każde złącze obsługuje 1 urządzenie SATA

<i>SPEC</i>			
	Złącze panela przedniego	x1	Obsługa elementów panela przedniego
	Przednie złącze audio	x1	Obsługa funkcji audio na panelu przednim
	Złącze wejścia CD	x1	Obsługa funkcji wejścia audio CD
	Złącze wyjścia S/PDIF	x1	Obsługa funkcji cyfrowego wyjścia audio
	Złącze główkowe wentylatora procesora	x1	Zasilanie wentylatora procesora (z funkcją Smart Fan)
	Złącze główkowe wentylatora systemowego	x1	Zasilanie wentylatora systemowego
	Złącze główkowe kasowania CMOS	x1	
	Złącze USB	x4	Każde złącze obsługuje 2 porty USB na panelu przednim
	Złącze zasilania (24 pinowe)	x1	
	Złącze zasilania (4 pinowe)	x1	
	Złącze Port drukarki	x1	Każde złącze obsługuje 1 Port drukarki
	Złącze Port szeregowy	x1	
Back Panel I/O	Klawiatura PS/2	x1	
	Mysz PS/2	x1	
	Port VGA	x1	
	Port LAN	x1	
	Port USB	x4	
	Gniazdo audio	x3	
	Port DVI	x1	
Wymiary płyty	190 mm (S) X 244 mm (W)		
Funkcje specjalne	Obsługa RAID 0 / 1 / 5 / 0+1 Obsługa Hybrid SLI (by nVIDIA driver)		
Obsługa systemu operacyjnego	Windows XP / VISTA		Biostar zastrzega sobie prawo dodawania lub odwoływania obsługi dowolnego systemu operacyjnego bez powiadomienia.

RUSSIAN

СПЕЦ		
CPU (центральный процессор)	Гнездо AM2+ Процессоры AMD Athlon 64 / Athlon 64 FX / Athlon 64 X2 / Sempron / Phenom	Архитектура AMD 64 разрешать обработка данных на 32 и 64 бит Поддержка Hyper Transport 3.0 и PowerNow
FSB	Поддержка HyperTransport 3.0 с пропускной способностью до 5.2 GT/s	
Набор микросхем	GeForce 8100	
Основная память	Слоты DDR2 DIMM x 2 Максимальная ёмкость памяти 8 Гб Каждый модуль DIMM поддерживает 256Мб/512Мб/1Гб/2Гб/4Гб DDR2	Модуль памяти с двухканальным режимом DDR2 Поддержка DDR2 533 / 667 / 800 Поддержка DDR2 1066 (by AM2+ CPU) Не поддерживает зарегистрированные модули DIMM and ECC DIMM
Super I/O	ITE 8718F Обеспечивает наиболее используемые действующие функциональные возможности Super I/O.	Интерфейс с низким количеством выводов Инициативы по охране окружающей среды, Аппаратный монитор Функция ITE "Smart Guardian" (Интеллектуальная защита)
Графика	Встроенная в набор микросхем GeForce 8100	Максимальная совместно используемая видео память составляет 512 Мб Поддержка DX10 / HDCP / PureVideo
IDE	Встроенное устройство управления встроенными интерфейсами устройств	Режим "хозяина" шины Ultra DMA 33 / 66 / 100 / 133 Поддержка режима PIO 0~4,
SATA	Встроенное последовательное устройство управления ATA	скорость передачи данных до 3 гигабит/с. Соответствие спецификации SATA версия 2.0.
Локальная сеть	Realtek RTL 8201CL PHY	Автоматическое согласование 10 / 100 Мб/с Частичная / полная дуплексная способность
Звуковая поддержка жесткого диска	ALC662	Звуковая поддержка High-Definition 5.1канальный звуковой выход
Слоты	Слот PCI Express Gen2 x16 x1 Слот PCI x2	
Встроенный разъём	Разъём НГМД x1 Разъём IDE x1	Каждый разъём поддерживает 2 накопителя на гибких магнитных дисках Каждый разъём поддерживает 2 встроенных интерфейса накопителей

СПЕЦ			
	Разъём SATA	x6	Каждый разъём поддерживает 1 устройство SATA
	Разъём на лицевой панели	x1	Поддержка устройств на лицевой панели
	Входной звуковой разъём	x1	Поддержка звуковых функций на лицевой панели
	Разъём ввода для CD	x1	Поддержка функции ввода для CD
	Разъём вывода для S/PDIF	x1	Поддержка вывода цифровой звуковой функции
	Контактирующее приспособление вентилятора центрального процессора	x1	Источник питания для вентилятора центрального процессора (с функцией интеллектуального вентилятора)
	Контактирующее приспособление вентилятора системы	x1	Источник питания для вентилятора системы
	Открытое контактирующее приспособление CMOS	x1	
	USB-разъём	x4	Каждый разъём поддерживает 2 USB-порта на лицевой панели
	Разъём питания (24 вывод)	x1	
	Разъём питания (4 вывод)	x1	
	Разъём Порт подключения принтера	x1	Каждый разъём поддерживает 1 Порт подключения принтера
	Разъём Последовательный порт	x1	
Задняя панель средств ввода-вывода	Клавиатура PS/2	x1	
	Мышь PS/2	x1	
	Порт VGA	x1	
	Порт LAN	x1	
	USB-порт	x4	
	Гнездо для подключения наушников	x3	
	Порт DVI	x1	
Размер панели	190 мм (Ш) X 244 мм (В)		
Специальные технические характеристики	Поддержка RAID 0 / 1 / 5 / 0+1 Поддержка Hybrid SLI (by nVIDIA driver)		
Поддержка OS	Windows XP / VISTA		Biostar сохраняет за собой право добавлять или удалять средства обеспечения для OS с или без предварительного уведомления.

ARABIC

لمواصفات		
وحدة المعالجة المركزية	AM2+ مقبس AMD Athlon 64 / Athlon 64 FX / Sempron / Phenom / Athlon 64 X2 معالجت	إجراء العمليات الحاسوبية بسرعة 32 و 64 بت AMD 64 يمكن تقنية PowerNow و Hyper Transport 3.0 تدعم تقنية
النقل الأممي الجانبي	5.2 GT/s يتردد يصل إلى HyperTransport 3.0 تدعم تقنية	
مجموعة الشرائح	GeForce 8100	
Super I/O	ITE 8718F الأكثر استخداماً Super I/O يوفر وظيفة	Low Pin Count Interface تدعم تقنية وسائل التحكم في البيئة: مراقب لمعرفة حالة الأجزاء ITE من "Smart Guardian" وظيفة
الذاكرة الرئيسية	قناة DDR2 DIMM سعة ذاكرة قصوى 8 جيجا بايت ميغا 256/512 سعة DDR2 تدعم ذاكرة من نوع DIMM كل قناة بايت و 1/2 و 4 جيجا بايت	عدد 2 مزدوجة القناة DDR2 وحدة ذاكرة سعت 800 / 667 / 533 ميجا بايت DDR2 تدعم الذاكرة من نوع سعت 1066 ميجا بايت DDR2 تدعم الذاكرة من نوع (DDR2 1066 is by AM2+ CPU) ECC وتلك التي لا تتوافق مع DIMM لا تدعم رقائق الذاكرة
بطاقة الرسومات	GeForce 8100 مدمجة في رقائق	ميغا بايت 512 أقصى سعة لذاكرة الفيديو المشتركة DX10 / HDCP / PureVideo تدعم تقنية
منفذ IDE	متكامل IDE متحكم	وضع رئيسي 33 / 66 / 100 / 133 Ultra DMA نقل بتقنية PIO Mode 0~4 دعم وضع
SATA	متكامل Serial ATA متحكم	جيجابت/ثانية، 3 نقل البيثت بسرعة تصل إلى 2.0 الإصدار SATA مطابقة لمواصفات
شبكة داخلية	Realtek RTL 8201CL PHY	تفاوض تلقائي 100/10 ميجا بايت / ثانية إمكانية النقل المزدوج الكامل/القصي
دعم الصوت عالي التعريف	ALC662	قوات لخرج الصوت 5,1 تدعم تقنية الصوت عالي التعريف من
القنوات	قناة PCI Express Gen2 x16 قناة PCI	عدد 1 عدد 2
المنفذ على سطح اللوحة	منفذ محرك أقراص مرنة منفذ IDE منفذ SATA منفذ اللوحة الأمومية	عدد 1 عدد 1 عدد 6 عدد 1
		يدعم محرك الأقراص المرنة IDE يدعم كل منفذ اثنين من أجهزة SATA يدعم كل منفذ واحد من أجهزة يدعم تجهيزات اللوحة الأمومية

GF8100 M2+ SE

المواصفات		
منفذ الصوت الأمامي	عدد 1	يدعم وظيفة الصوت باللوحة الأمامية
منفذ CD-IN	عدد 1	يدعم وظيفة دخل صوت القرص المدمج
منفذ خرج SPDIF	عدد 1	يدعم وظيفة خرج الصوت الرقمي
وصلة مروحة وحدة المعالجة المركزية	عدد 1	Smart Fan لتوصيل الطلقة لمروحة وحدة المعالجة مع وظيفة
وصلة مروحة النظام	عدد 1	لتوصيل الطلقة لمروحة النظام
وصلة مسح CMOS	عدد 1	
منفذ USB	عدد 4	باللوحة الأمامية USB يدعم كل منفذ قحني
منفذ توصيل الطلقة (24 دبوس)	عدد 1	
منفذ توصيل الطلقة (4 دبوس)	عدد 1	
منفذ طباعة	عدد 1	
منفذ تسلسلي	عدد 1	
لوحة مفاتيح PS/2	عدد 1	
ملوس PS/2	عدد 1	
منفذ VGA	عدد 1	
منفذ شبكة اتصال محلية	عدد 1	
منافذ USB	عدد 4	
مقيس صوت	عدد 3	
منافذ DVI	عدد 1	
حجم اللوحة	190 مم (عرض) X 244 مم (الارتفاع)	
مزايا خاصة	RAID 0 / 1 / 5 / 0+1 تدعم تقنية Hybrid SLI (by nVIDIA driver) تدعم تقنية	
دعم أنظمة التشغيل	Windows XP / VISTA	بحقها في إضافة أو إزالة الدعم لأي نظام تشغيل بإخطار أو Biostar تحتفظ بدون إخطار .

JAPANESE

仕様		
CPU	Socket AM2+ AMD Athlon 64 / Athlon 64 FX / Athlon 64 X2 / Sempron / Phenom プロセッサ	AMD 64アーキテクチャでは、32ビットと64ビット計算が可能です ハイバートランスポート3.0とクールアンドクワイアットをサポートします
FSB	5.2 GT/sのバンド幅までハイバートランスポート3.0をサポートします	
チップセット	GeForce 8100	
メインメモリ	DDR2 DIMMスロット x 2 最大メモリ容量8GB 各DIMMは 256MB/512MB/1GB/2GB/4GB DDR2をサポート	デュアル チャンネルモードDDR2 メモリモジュール DDR2 533 / 667 / 800 をサポート DDR2 1066 をサポート (by AM2+ CPU) 登録済みDIMMとECC DIMMはサポートされません
Super I/O	ITE 8718F もっとも一般に使用されるレガシーSuper I/O機能を採用しています。	低ピンカウントインターフェイス 環境コントロールイニシアチブ、 H/Wモニター ITEの「スマートガーディアン」機能
グラフィックス	GeForce 8100チップセットに統合	最大の共有ビデオメモリは512MBです DX10 / HDCP / PureVideo のサポート
IDE	統合IDEコントローラ	Ultra DMA 33 / 66 / 100 / 133バスマスタモード PIO Mode 0~4のサポート、
SATA	統合シリアルATAコントローラ	最高3Gb/秒のデータ転送速度 SATAバージョン2.0仕様に準拠。
LAN	Realtek RTL 8201CL PHY	10 / 100 Mb/秒のオートネゴシエーション 半/全二重機能
HDオーディオのサポート	ALC662	5.1チャンネルオーディオアウト ハイデフィニションオーディオのサポート
スロット	PCI Express Gen2 x16スロット x1 PCIスロット x2	
オンボードコネクタ	フロッピーコネクタ x1 IDEコネクタ x1 SATAコネクタ x6	各コネクタは2つのフロッピードライブをサポートします 各コネクタは2つのIDEデバイスをサポートします 各コネクタは1つのSATAデバイスをサポートします

仕様			
	フロントパネルコネクタ	x1	フロントパネル機能をサポートします
	フロントオーディオコネクタ	x1	フロントパネルオーディオ機能をサポートします
	CDインコネクタ	x1	CDオーディオイン機能をサポートします
	S/PDIFアウトコネクタ	x1	デジタルオーディオアウト機能をサポートします
	CPUファンヘッダ	x1	CPUファン電源装置(スマートファン機能を搭載)
	システムファンヘッダ	x1	システムファン電源装置
	CMOSクリアヘッダ	x1	
	USBコネクタ	x4	各コネクタは2つのフロントパネルUSBポートをサポートします
	電源コネクタ(24ピン)	x1	
	電源コネクタ(4ピン)	x1	
	プリンタポートコネクタ	x1	各コネクタは1つのプリンタポートをサポートします
	シリアルポートコネクタ	x1	
背面パネル I/O	PS/2キーボード	x1	
	PS/2マウス	x1	
	VGAポート	x1	
	LANポート	x1	
	USBポート	x4	
	オーディオジャック	x3	
	DVIポート	x1	
ボードサイズ	190 mm (幅) X 244 mm (高さ)		
特殊機能	RAID 0 / 1 / 5 / 0+1 のサポート Hybrid SLI のサポート(by nVIDIA driver)		
OSサポート	Windows XP / VISTA		Biostarは事前のサポートなしにOSサポートを追加または削除する権利を留保します。

2008/04/25