

FCC Information and Copyright

This equipment has been tested and found to comply with the limits of a Class B digital device, pursuant to Part 15 of the FCC Rules. These limits are designed to provide reasonable protection against harmful interference in a residential installation. This equipment generates, uses, and can radiate radio frequency energy and, if not installed and used in accordance with the instructions, may cause harmful interference to radio communications. There is no guarantee that interference will not occur in a particular installation.

The vendor makes no representations or warranties with respect to the contents here and specially disclaims any implied warranties of merchantability or fitness for any purpose. Further the vendor reserves the right to revise this publication and to make changes to the contents here without obligation to notify any party beforehand.

Duplication of this publication, in part or in whole, is not allowed without first obtaining the vendor's approval in writing.

The content of this user's manual is subject to be changed without notice and we will not be responsible for any mistakes found in this user's manual. All the brand and product names are trademarks of their respective companies.

Table of Contents

Chapter 1: Introduction	1
1.1 Before You Start	1
1.2 Package Checklist	1
1.3 Motherboard Features	2
1.4 Rear Panel Connectors	3
1.5 Motherboard Layout	4
Chapter 2: Hardware Installation	5
2.1 Installing Central Processing Unit (CPU)	5
2.2 FAN Headers	7
2.3 Installing System Memory	8
2.4 Connectors and Slots	10
Chapter 3: Headers & Jumpers Setup	12
3.1 How to Setup Jumpers	12
3.2 Detail Settings	12
Chapter 4: RAID Functions	19
4.1 Operation System	19
4.2 Raid Arrays	19
4.3 How RAID Works	19
Chapter 5: Useful Help	22
5.1 Driver Installation Note	22
5.2 Award BIOS Beep Code	23
5.3 Extra Information	23
5.4 Troubleshooting	24
Appendencies: SPEC In Other Language	26
German	26
France	28
Italian	30
Spanish	32
Portuguese	34
Polish	36
Russian	38
Arabic	40
Japanese	42

CHAPTER 1: INTRODUCTION

1.1 BEFORE YOU START

Thank you for choosing our product. Before you start installing the motherboard, please make sure you follow the instructions below:

- Prepare a dry and stable working environment with sufficient lighting.
- Always disconnect the computer from power outlet before operation.
- Before you take the motherboard out from anti-static bag, ground yourself properly by touching any safely grounded appliance, or use grounded wrist strap to remove the static charge.
- Avoid touching the components on motherboard or the rear side of the board unless necessary. Hold the board on the edge, do not try to bend or flex the board.
- Do not leave any unfastened small parts inside the case after installation. Loose parts will cause short circuits which may damage the equipment.
- Keep the computer from dangerous area, such as heat source, humid air and water.

1.2 PACKAGE CHECKLIST

- ✦ HDD Cable X 1
- ✦ Rear I/O Panel for ATX Case X 1
- ✦ Installation Guide X 1
- ✦ Fully Setup Driver CD X 1 (full version manual files inside)
- ✦ Serial ATA Cable X 1
- ✦ FDD Cable X 1 (optional)
- ✦ Serial ATA Power Cable X 1 (optional)
- ✦ USB 2.0 Cable X1 (optional)
- ✦ S/PDIF out Cable X 1 (optional)

Note: The package contents may differ by area or your motherboard version.

1.3 MOTHERBOARD FEATURES

SPEC		
CPU	LGA 775 Intel Core2Duo / Core2Quad / Celeron 4xx / Pentium D / Pentium 4 processor Supports 45nm CPU	Supports Hyper-Threading / Execute Disable Bit / Enhanced Intel SpeedStep® / Intel Architecture-64 / Extended Memory 64 Technology / Virtualization Technology
FSB	1333 MHz	
Chipset	GeForce 7050/rForce 610	
Graphics	GeForce 7050/rForce 610	Max Shared Video Memory is 512MB(under OS)
Super I/O	ITE 8718F Provides the most commonly used legacy Super I/O functionality Low Pin Count Interface	Environment Control initiatives, H/W Monitor Fan Speed Controller ITE's "Smart Guardian" function
Main Memory	DIMM Slots x 2 Each DIMM supports 256MB/512MB/1GB/ 2GB DDR2 Max Memory Capacity 4GB Supports DDR2 533 / 667 / 800	Single Channel Mode DDR2 memory module Registered DIMM and ECC DIMM is not supported
IDE	Integrated IDE Controller	Ultra DMA 33 / 66 / 100 / 133 Bus Master Mode supports PIO Mode 0~4,
SATA	Integrated Serial ATA Controller	Data transfer rates up to 3.0 Gb/s. SATA Version 2.0 specification compliant. RAID 0 / 1 / 0+1 support
LAN	Realtek 8201CL PHY	10 / 100 Mb/s auto negotiation Half / Full duplex capability
Sound Codec	ALC662	5.1 channels audio out High-Definition Audio support
Slots	PCI Express x16 slot x1 PCI Express x1 slot x1 PCI slot x2	Supports PCI-E x16 expansion cards Supports PCI-E x1 expansion cards Supports PCI expansion cards
On Board Connector	Floppy connector x1 IDE Connector x1 Printer Port Connector x1 SATA Connector x4	Each connector supports 2 Floppy drives Each connector supports 2 IDE device Each connector supports 1 Printer port Each connector supports 1 SATA devices

SPEC			
	Front Panel Connector	x1	Supports front panel facilities
	Front Audio Connector	x1	Supports front panel audio function
	CD-in Connector	x1	Supports CD audio-in function
	S/PDIF out connector	x1	Supports digital audio out function
	CPU Fan header	x1	CPU Fan power supply (with Smart Fan function)
	System Fan header	x1	System Fan Power supply
	Clear CMOS header	x1	Restore CMOS data to factory default
	USB connector	x2	Each connector supports 2 front panel USB ports
	Power Connector (24pin)	x1	Connects to Power supply
	Power Connector (4pin)	x1	Connects to Power supply
Back Panel I/O	PS/2 Keyboard	x1	Connects to PS/2 Keyboard
	PS/2 Mouse	x1	Connects to PS/2 Mouse
	Serial Port	x1	Provide RS-232 Serial connection
	VGA port	x1	Connects to monitor
	LAN port	x1	Connects to RJ-45 ethernet cable
	USB Port	x4	Connects to USB devices
	Audio Jack	x3	Provide Audio-In/Out and microphone connection
Board Size	185 (W) x 244 (L) mm		Micro ATX form Factor
OS Support	Windows XP / VISTA		Biostar Reserves the right to add or remove support for any OS with or without notice.

1.4 REAR PANEL CONNECTORS

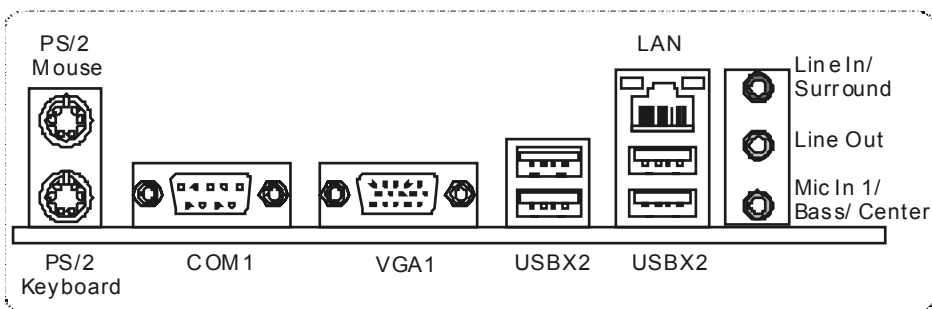

Since the audio chip supports High Definition Audio Specification, the function of each audio jack can be defined by software. The input/output function of each audio jack listed above represents the default setting. However, when connecting external microphone to the audio port, please use the Line In (Blue) and Mic In (Pink) audio jack.

1.5 MOTHERBOARD LAYOUT

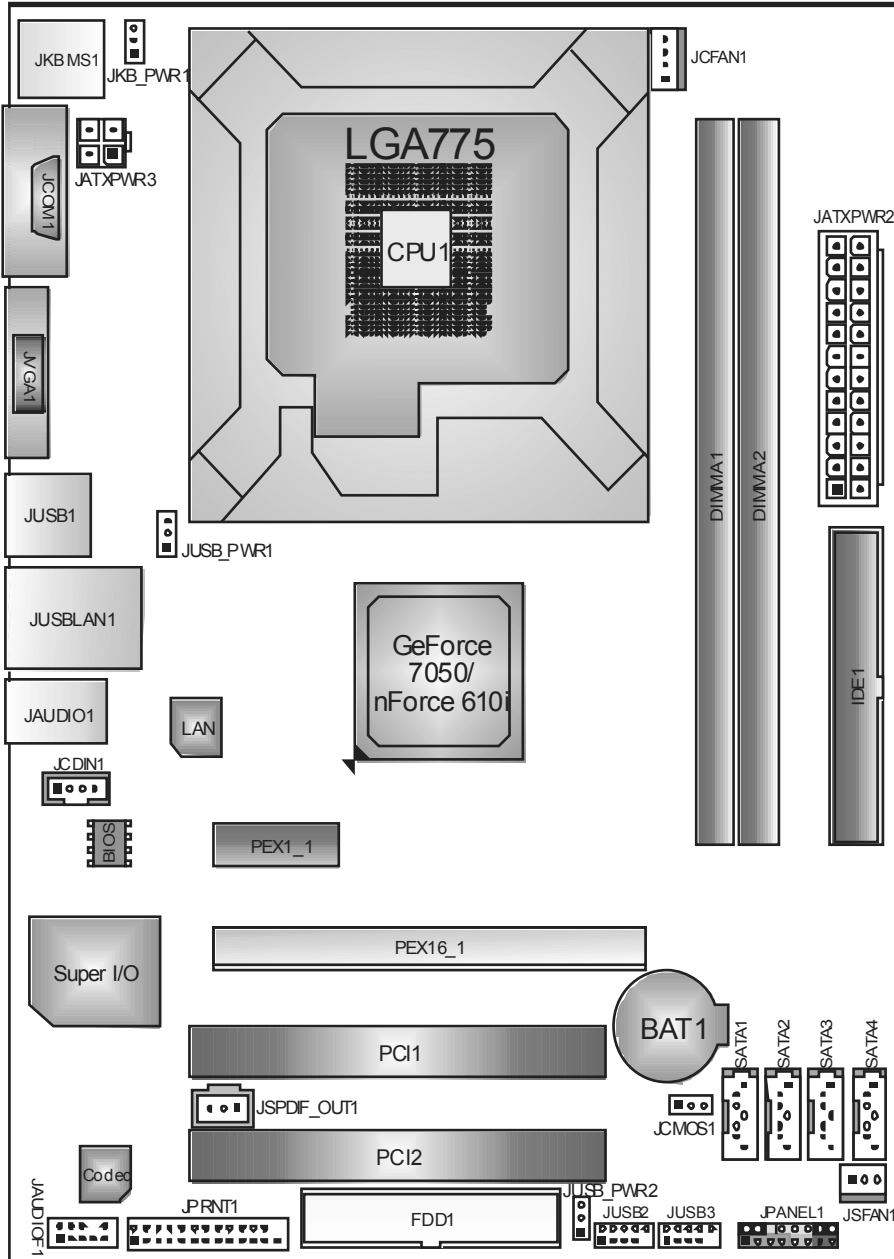

Note: ■ represents the 1st pin.

CHAPTER 2: HARDWARE INSTALLATION

2.1 INSTALLING CENTRAL PROCESSING UNIT (CPU)

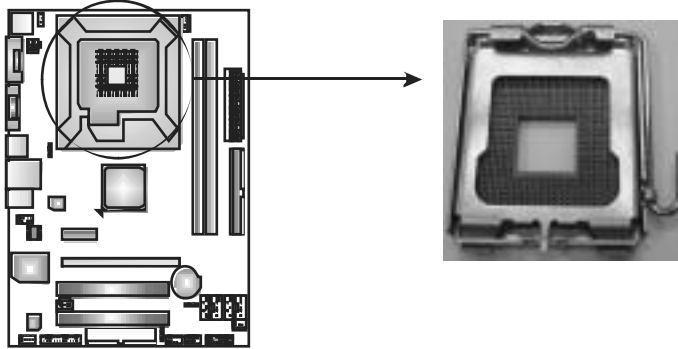

Special Notice

Remove Pin Cap before installation, and make good preservation for future use. When the CPU is removed, cover the Pin Cap on the empty socket to ensure pin legs won't be damaged.

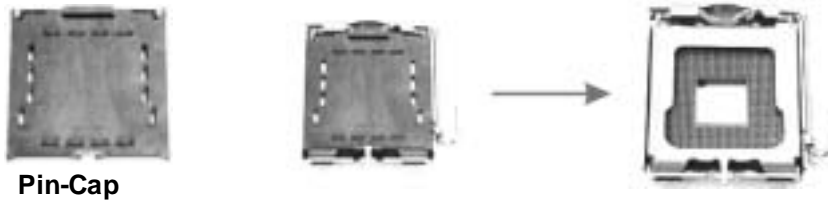

Pin-Cap

Step 1: Pull the socket locking lever out from the socket and then raise the lever up to a 90-degree angle.

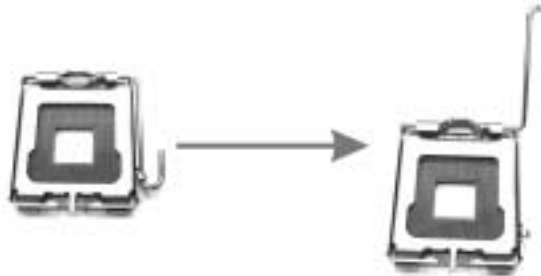

Step 2: Look for the triangular cut edge on socket, and the golden dot on CPU should point forwards this triangular cut edge. The CPU will fit only in the correct orientation.

Step 2-1:



Step 2-2:

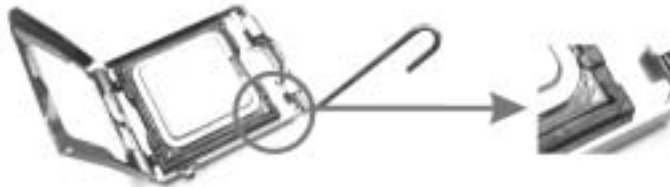

Step 3: Hold the CPU down firmly, and then lower the lever to locked position to complete the installation.



Step 4: Put the CPU Fan and heatsink assembly on the CPU and buckle it on the retention frame. Connect the CPU FAN power cable into the JCFAN1. This completes the installation.

2.2 FAN HEADERS

These fan headers support cooling-fans built in the computer. The fan cable and connector may be different according to the fan manufacturer. Connect the fan cable to the connector while matching the black wire to pin#1.

JCFAN1: CPU Fan Header

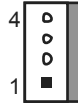
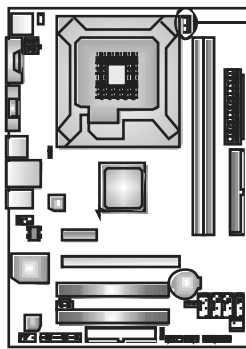

Pin	Assignment
1	Ground
2	+12V
3	FAN RPM rate sense
4	Smart Fan Control

JSFAN1: System Fan Header

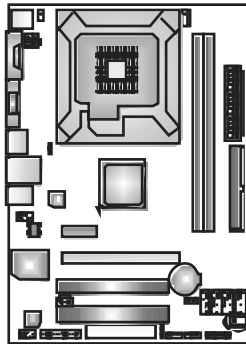

Pin	Assignment
1	Ground
2	+12V
3	FAN RPM rate sense

Note:

The JCFAN1 and JSFAN1 support 4-pin and 3-pin head connector. When connecting with wires onto connectors, please note that the red wire is the positive and should be connected to pin#2, and the black wire is Ground and should be connected to GND.

2.3 INSTALLING SYSTEM MEMORY

A. Memory Modules

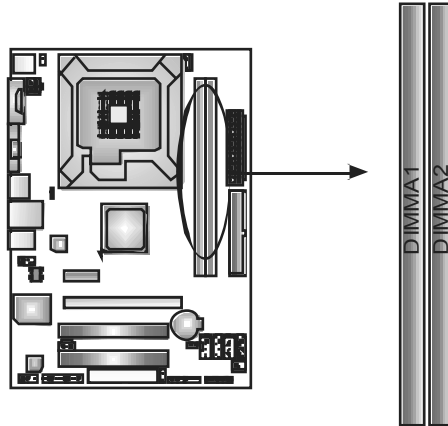

1. Unlock a DIMM slot by pressing the retaining clips outward. Align a DIMM on the slot such that the notch on the DIMM matches the break on the Slot.

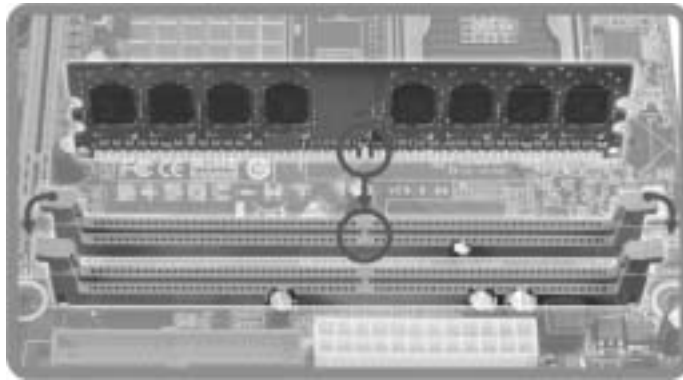

2. Insert the DIMM vertically and firmly into the slot until the retaining chip snap back in place and the DIMM is properly seated.



B. Memory Capacity

DIMM Socket Location	DDR2 Module	Total Memory Size
DIMMA1	256MB/512MB/1024MB/2048MB	Max is 4GB.
DIMMA2	256MB/512MB/1024MB/2048MB	

2.4 CONNECTORS AND SLOTS

FDD1: Floppy Disk Connector

The motherboard provides a standard floppy disk connector that supports 360K, 720K, 1.2M, 1.44M and 2.88M floppy disk types. This connector supports the provided floppy drive ribbon cables.

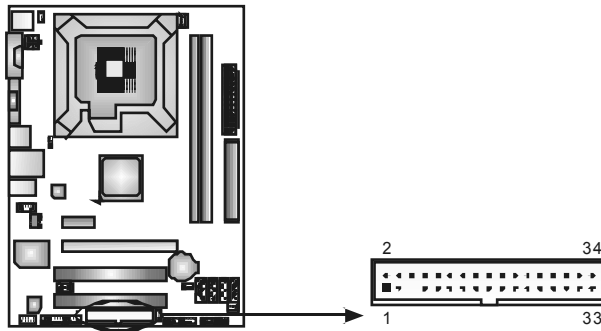

IDE1: Hard Disk Connector

The motherboard has a 32-bit Enhanced PCI IDE Controller that provides PIO Mode 0~4, Bus Master, and Ultra DMA 33/66/100/133 functionality.

The IDE connector can connect a master and a slave drive, so you can connect up to two hard disk drives.

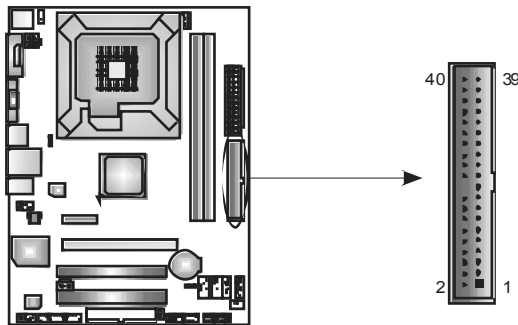

PEX16_1: PCI-Express x16 Slot

- PCI-Express 1.0a compliant.
- Maximum theoretical realized bandwidth of 2GB/s simultaneously per direction, for an aggregate of 4GB/s totally.
- x8 Speed by Chipset Specification.

PEX1_1: PCI-Express x1 Slot

- PCI-Express 1.0a compliant.
- Data transfer bandwidth up to 250MB/s per direction; 500MB/s in total.
- PCI-Express supports a raw bit-rate of 2.5Gb/s on the data pins.
- 2X bandwidth over the traditional PCI architecture.

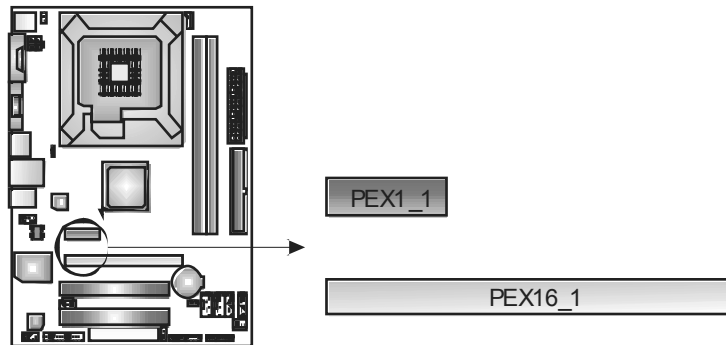
**PC11~PC12: Peripheral Component Interconnect Slots**

The motherboard is equipped with 2 standard PCI slots. PCI stands for Peripheral Component Interconnect, and it is a bus standard for expansion cards. This PCI slot is designated as 32 bits.

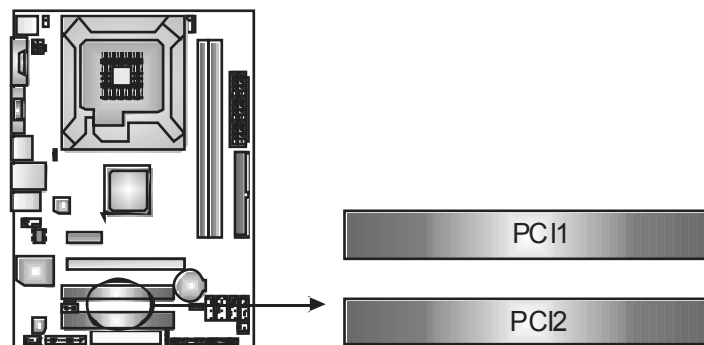

CHAPTER 3: HEADERS & JUMPERS SETUP

3.1 HOW TO SETUP JUMPERS

The illustration shows how to set up jumpers. When the jumper cap is placed on pins, the jumper is “close”, if not, that means the jumper is “open”.



Pin opened



Pin dosed



Pin1-2 dosed

3.2 DETAIL SETTINGS

JPANEL1: Front Panel Header

This 16-pin connector includes Power-on, Reset, HDD LED, Power LED, and speaker connections. It allows user to connect the PC case's front panel switch functions.

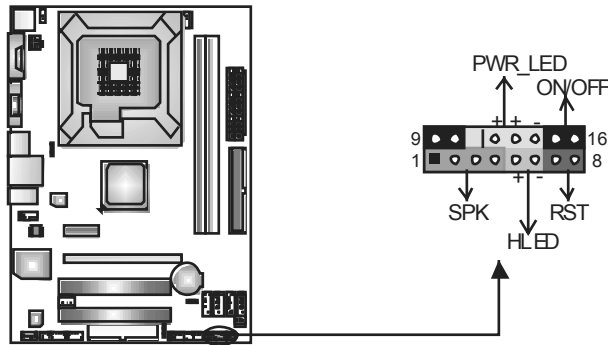

Pin	Assignment	Function	Pin	Assignment	Function
1	+5V	Speaker Connector	9	N/A	N/A
2	N/A		10	N/A	N/A
3	N/A		11	N/A	N/A
4	Speaker	Hard drive LED	12	Power LED (+)	Power LED
5	HDD LED (+)		13	Power LED (+)	
6	HDD LED (-)		14	Power LED (-)	
7	Ground	Reset button	15	Power button	Power-on button
8	Reset control		16	Ground	

JATXPWR1: ATX Power Source Connector

This connector allows user to connect 24-pin power connector on the ATX power supply.

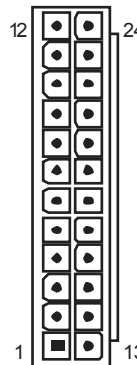
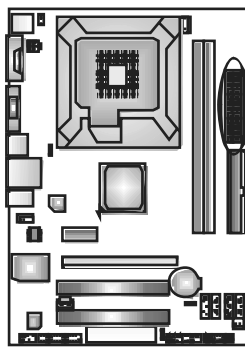

Pin	Assignment
1	+3.3V
2	+3.3V
3	Ground
4	+5V
5	Ground
6	+5V
7	Ground
8	PW_OK
9	Standby Voltage +5V
10	+12V
11	+12V
12	+3.3V
13	+3.3V
14	-12V
15	Ground
16	PS_ON
17	Ground
18	Ground
19	Ground
20	-5V
21	+5V
22	+5V
23	+5V
24	Ground

JATXPWR2: ATX Power Source Connector

By connecting this connector, it will provide +12V to CPU power circuit.

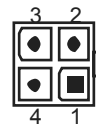
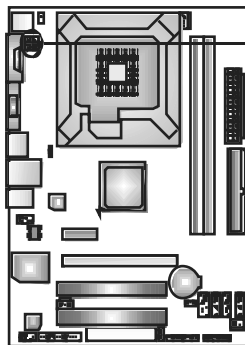

Pin	Assignment
1	+12V
2	+12V
3	Ground
4	Ground

Note:

Before power on the system, please make sure that both JATXPWR1 and JATXPWR2 connectors have been plugged-in.

JUSB2/JUSB3: Headers for USB 2.0 Ports at Front Panel

This motherboard provides 2 USB 2.0 headers, which allow user to connect additional USB cable on the PC front panel, and also can be connected with internal USB devices, like USB card reader.

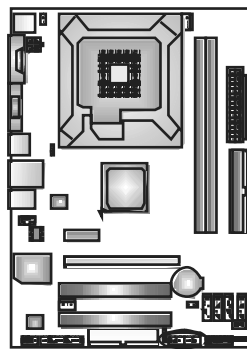

JUSB2 JUSB3

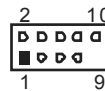

Pin	Assignment
1	+5V (fused)
2	+5V (fused)
3	USB-
4	USB-
5	USB+
6	USB+
7	Ground
8	Ground
9	Key
10	NC

SATA1~SATA4: Serial ATA Connectors

The motherboard has a PCI to SATA Controller with 4 channels SATA interface, it satisfies the SATA 2.0 spec and with transfer rate of 3Gb/s.

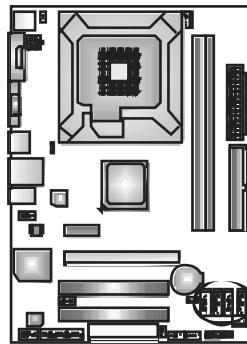

SATA1
SATA2
SATA3
SATA4

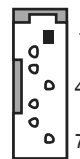

Pin	Assignment
1	Ground
2	TX+
3	TX-
4	Ground
5	RX-
6	RX+
7	Ground

JSPDIF_OUT1: Digital Audio out Connectors

This connector allows user to connect the PCI bracket SPDIF output header.

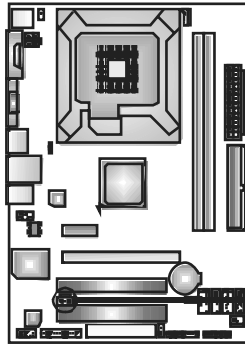

Pin	Assignment
1	+5V
2	SPDIF_OUT 1
3	Ground

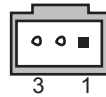

JAUDIO F1: Front Panel Audio Header

This header allows user to connect the front audio output cable with the PC front panel. This header allows only HD audio front panel connector; AC'97 connector is not acceptable.

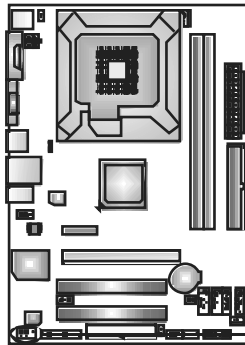

Pin	Assignment
1	Mic Left in
2	Ground
3	Mic Right in
4	GPIO
5	Right line in
6	Jack Sense
7	Front Sense
8	Key
9	Left line in
10	Jack Sense

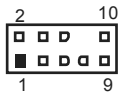

JCDIN1: CD-ROM Audio-in Connector

This connector allows user to connect the audio source from the variety devices, like CD-ROM, DVD-ROM, PCI sound card, PCI TV tuner card etc..

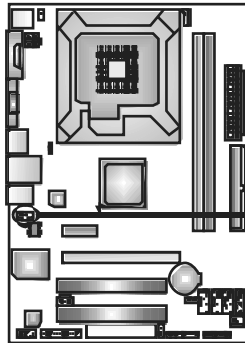

Pin	Assignment
1	Left Channel Input
2	Ground
3	Ground
4	Right Channel Input

JCMOS1: Clear CMOS Header

By placing the jumper on pin2-3, it allows user to restore the BIOS safe setting and the CMOS data, please carefully follow the procedures to avoid damaging the motherboard.

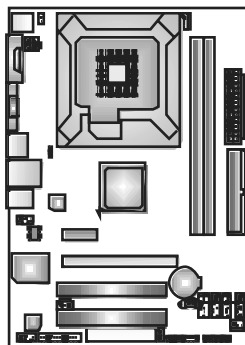

1 3

Pin 1-2 Close:
Normal Operation (Default).



1 3

Pin 2-3 Close:
Clear CMOS data.

※ Clear CMOS Procedures:

1. Remove AC power line.
2. Set the jumper to "Pin 2-3 close".
3. Wait for five seconds.
4. Set the jumper to "Pin 1-2 close".
5. Power on the AC.
6. Reset your desired password or clear the CMOS data.

JUSB_PWR1/JUSB_PWR2: Power Source Headers for USB Ports

Pin 1-2 Close:

JUSB_PWR1: +5V for USB ports at JUSB1/JUSBLAN1.

JUSB_PWR2: +5V for USB ports at front panel (JUSB2/JUSB3).

Pin 2-3 Close:

JUSB_PWR1: +5V STB for USB ports at JUSB1/JUSBLAN1.

JUSB_PWR2: +5V STB for USB ports at front panel (JUSB2/JUSB3).

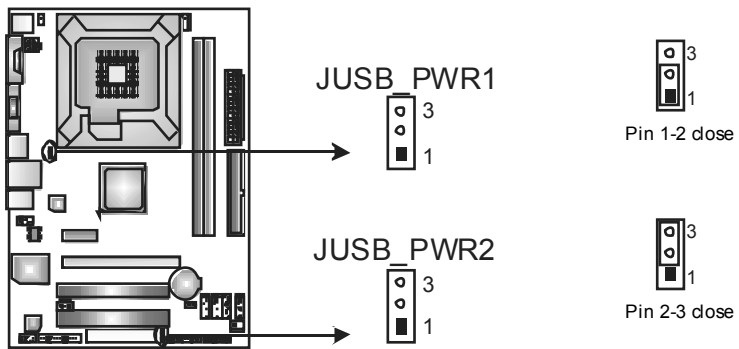

JKB_PWR1: Power Source Header for PS/2 Keyboard and Mouse

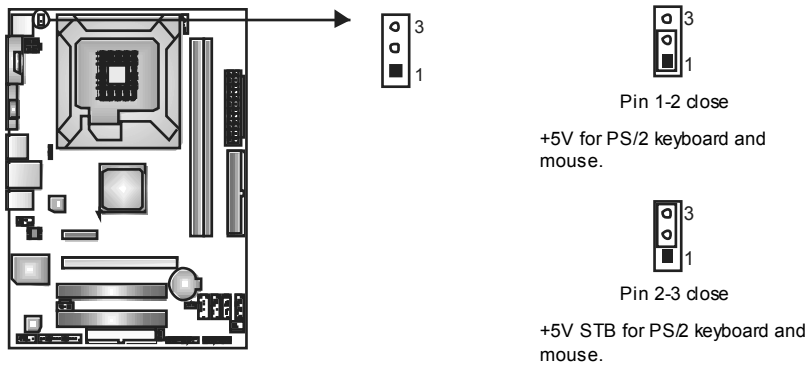

JPRNT1: Printer Port Connector

This header allows you to connector printer on the PC.

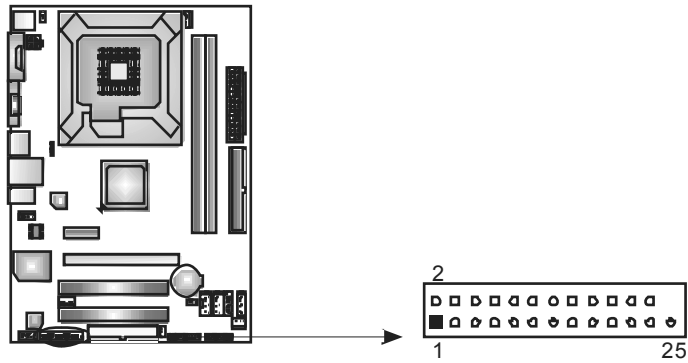

Pin	Assignment	Pin	Assignment
1	-Strobe	14	Ground
2	-ALF	15	Data 6
3	Data 0	16	Ground
4	-Error	17	Data 7
5	Data 1	18	Ground
6	-Init	19	-ACK
7	Data 2	20	Ground
8	-Scltin	21	Busy
9	Data 3	22	Ground
10	Ground	23	PE
11	Data 4	24	Ground
12	Ground	25	SCLT
13	Data 5	26	Key

CHAPTER 4: RAID FUNCTIONS

4.1 OPERATION SYSTEM

- Supports Windows XP Home/Professional Edition and Windows Vista.

4.2 RAID ARRAYS

RAID supports the following types of RAID arrays:

RAID 0: RAID 0 defines a disk striping scheme that improves disk read and write times for many applications.

RAID 1: RAID 1 defines techniques for mirroring data.

RAID 0+1: RAID 0+1 combines the techniques used in RAID 0 and RAID 1.

4.3 HOW RAID WORKS

RAID 0:

The controller “stripes” data across multiple drives in a RAID 0 array system. It breaks up a large file into smaller blocks and performs disk reads and writes across multiple drives in parallel. The size of each block is determined by the stripe size parameter, which you set during the creation of the RAID set based on the system environment. This technique reduces overall disk access time and offers high bandwidth.

Features and Benefits

- **Drives:** Minimum 1, and maximum is up to 6 or 8. Depending on the platform.
- **Uses:** Intended for non-critical data requiring high data throughput, or any environment that does not require fault tolerance.
- **Benefits:** provides increased data throughput, especially for large files. No capacity loss penalty for parity.
- **Drawbacks:** Does not deliver any fault tolerance. If any drive in the array fails, all data is lost.
- **Fault Tolerance:** No.

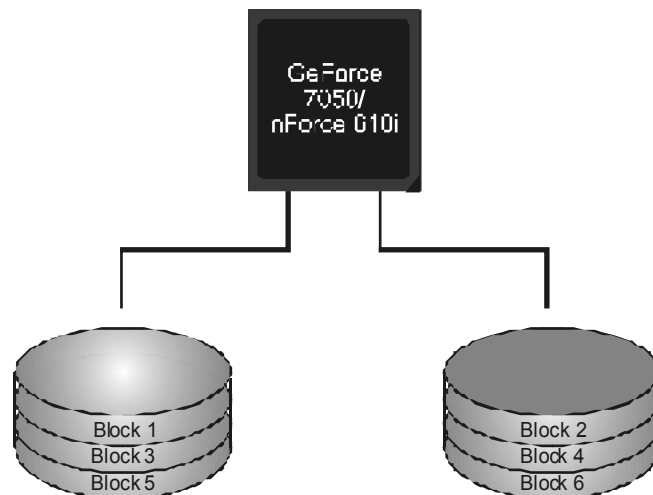

RAID 1:

Every read and write is actually carried out in parallel across 2 disk drives in a RAID 1 array system. The mirrored (backup) copy of the data can reside on the same disk or on a second redundant drive in the array. RAID 1 provides a hot-standby copy of data if the active volume or drive is corrupted or becomes unavailable because of a hardware failure.

RAID techniques can be applied for high-availability solutions, or as a form of automatic backup that eliminates tedious manual backups to more expensive and less reliable media.

Features and Benefits

- **Drives:** Minimum 2, and maximum is 2.
- **Uses:** RAID 1 is ideal for small databases or any other application that requires fault tolerance and minimal capacity.
- **Benefits:** Provides 100% data redundancy. Should one drive fail, the controller switches to the other drive.
- **Drawbacks:** Requires 2 drives for the storage space of one drive. Performance is impaired during drive rebuilds.
- **Fault Tolerance:** Yes.

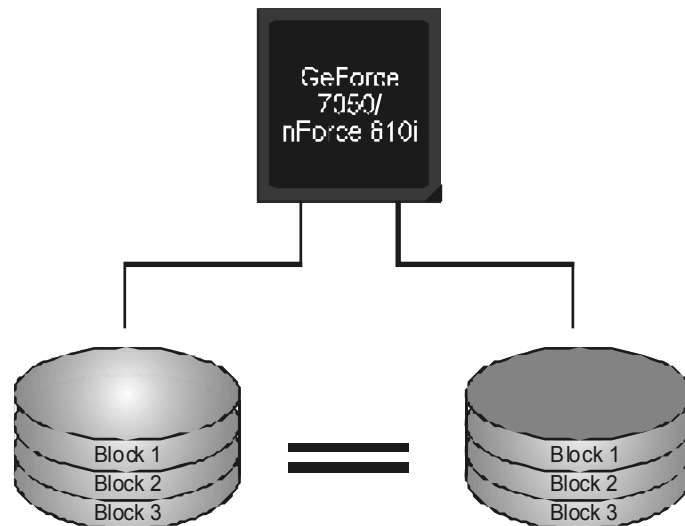

RAID 0+1:

RAID 0 drives can be mirrored using RAID 1 techniques. Resulting in a RAID 0+1 solution for improved performance plus resiliency.

Features and Benefits

- **Drives:** Minimum 4, and maximum is 6 or 8, depending on the platform.
- **Benefits:** Optimizes for both fault tolerance and performance, allowing for automatic redundancy. May be simultaneously used with other RAID levels in an array, and allows for spare disks.
- **Drawbacks:** Requires twice the available disk space for data redundancy, the same as RAID level 1.
- **Fault Tolerance:** Yes.

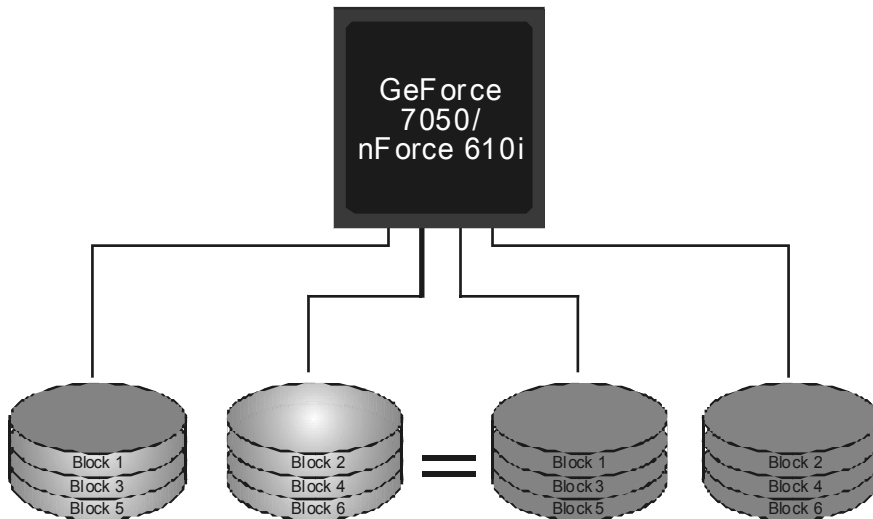

※ For more detailed setup information, please refer to the Driver CD, or go to http://www.nvidia.com/object/IO_28159.html to download the NVIDIA RAID User's Guide.

CHAPTER 5: USEFUL HELP

5.1 DRIVER INSTALLATION NOTE

After you installed your operating system, please insert the Fully Setup Driver CD into your optical drive and install the driver for better system performance.

You will see the following window after you insert the CD



The setup guide will auto detect your motherboard and operating system.

Note:

If this window didn't show up after you insert the Driver CD, please use file browser to locate and execute the file **SETUPEXE** under your optical drive.

A. Driver Installation

To install the driver, please click on the Driver icon. The setup guide will list the compatible driver for your motherboard and operating system. Click on each device driver to launch the installation program.

B. Software Installation

To install the software, please click on the Software icon. The setup guide will list the software available for your system, click on each software title to launch the installation program.

C. Manual

Aside from the paperback manual, we also provide manual in the Driver CD. Click on the Manual icon to browse for available manual.

Note:

You will need Acrobat Reader to open the manual file. Please download the latest version of Acrobat Reader software from

<http://www.adobe.com/products/acrobat/readstep2.html>

5.2 AWARD BIOS BEEP CODE

Beep Sound	Meaning
One long beep followed by two short beeps	Video card not found or video card memory bad
High-low siren sound	CPU overheated System will shut down automatically
One Short beep when system boot-up	No error found during POST
Long beeps every other second	No DRAM detected or install

5.3 EXTRA INFORMATION

CPU Overheated

If the system shutdown automatically after power on system for seconds, that means the CPU protection function has been activated.

When the CPU is over heated, the motherboard will shutdown automatically to avoid a damage of the CPU, and the system may not power on again.

In this case, please double check:

1. The CPU cooler surface is placed evenly with the CPU surface.
2. CPU fan is rotated normally.
3. CPU fan speed is fulfilling with the CPU speed.

After confirmed, please follow steps below to relief the CPU protection function.

1. Remove the power cord from power supply for seconds.
2. Wait for seconds.
3. Plug in the power cord and boot up the system.

Or you can:

1. Clear the CMOS data.
(See "Close CMOS Header: JCMOS1" section)
2. Wait for seconds.
3. Power on the system again.

5.4 TROUBLESHOOTING

Probable	Solution
<ol style="list-style-type: none"> 1. No power to the system at all. Power light don't illuminate, fan inside power supply does not turn on. 2. Indicator light on key board does not turn on. 	<ol style="list-style-type: none"> 1. Make sure power cable is securely plugged in. 2. Replace cable. 3. Contact technical support.
<p>System inoperative. Keyboard lights are on, power indicator lights are lit, and hard drive is spinning.</p>	<p>Using even pressure on both ends of the DIMM, press down firmly until the module snaps into place.</p>
<p>System does not boot from hard disk drive, can be booted from optical drive.</p>	<ol style="list-style-type: none"> 1. Check cable running from disk to disk controller board. Make sure both ends are securely plugged in; check the drive type in the standard CMOS setup. 2. Backing up the hard drive is extremely important. All hard disks are capable of breaking down at any time.
<p>System only boots from optical drive. Hard disk can be read and applications can be used but booting from hard disk is impossible.</p>	<ol style="list-style-type: none"> 1. Back up data and applications files. 2. Reformat the hard drive. Re-install applications and data using backup disks.
<p>Screen message says "Invalid Configuration" or "CMOS Failure."</p>	<p>Review system's equipment. Make sure correct information is in setup.</p>
<p>Cannot boot system after installing second hard drive.</p>	<ol style="list-style-type: none"> 1. Set master/slave jumpers correctly. 2. Run SETUP program and select correct drive types. Call the drive manufacturers for compatibility with other drives.

This page is intentionally left blank.

APPENDENCIES: SPEC IN OTHER LANGUAGE**GERMAN**

<i>Spezifikationen</i>		
CPU	LGA 775 Intel Core2Duo / Core2Quad / Celeron 4xx / Pentium 4 / Pentium D Prozessoren Unterstützt 45nm CPU	Unterstützt Hyper-Threading / Execute Disable Bit / Enhanced Intel SpeedStep® / Intel Architecture-64 / Extended Memory 64 Technology / Virtualization Technology
FSB	1333 MHz	
Chipsatz	GeForce 7050/rForce 610	
Grafik	GeForce 7050/rForce 610	Max. 512MB gemeinsam benutzter Videospeicher (under OS)
Super E/A	ITE 8718F Bietet die häufig verwendeten alten Super E/A-Funktionen. Low Pin Count-Schnittstelle	Umgebungskontrolle, Hardware-Überwachung Lüfterdrehzahl-Controller "Smart Guardian"-Funktion von ITE
Arbeitsspeicher	DDR2 DIMM-Steckplätze x 2 Jeder DIMM unterstützt 256MB/512MB/1GB/ 2GB DDR2 Max. 4GB Arbeitsspeicher Unterstützt DDR2 533 / 667 / 800	Ein-Kanal DDR2 Speichermodul registrierte DIMMs. ECC DIMMs werden nicht unterstützt.
IDE	Integrierter IDE-Controller	Ultra DMA 33 / 66 / 100 / 133 Bus Master-Modus Unterstützt PIO-Modus 0~4
SATA	Integrierter Serial ATA-Controller	Datentransferrate bis zu 3Gb/s Konform mit der SATA-Spezifikation Version 2.0 Unterstützt RAID 0 / 1 / 0+1
LAN	Realtek 8201CL PHY	10 / 100 Mb/s Auto-Negotiation Halb-/Voll duplex-Funktion
Audio-Codec	ALC662	5.1-Kanal-Audioausgabe Unterstützt High-Definition Audio
Steckplätze	PCI Express x16 Steckplatz x1 PCI Express x1-Steckplatz x1	

Spezifikationen			
	PCI-Steckplatz	x2	
Onboard-Anschluss	Diskettenlaufwerkanschluss	x1	Jeder Anschluss unterstützt 2 Diskettenlaufwerke
	IDE-Anschluss	x1	Jeder Anschluss unterstützt 2 IDE-Laufwerke
	Druckeranschluss	x1	Jeder Anschluss unterstützt 1 Druckeranschluss
	SATA-Anschluss	x4	Jeder Anschluss unterstützt 1 SATA-Laufwerk
	Fronttafelanschluss	x1	Unterstützt die Fronttafel-Funktionen
	Front-Audioanschluss	x1	Unterstützt die Fronttafel-Audioanschlussfunktion
	CD-IN-Anschluss	x1	Unterstützt die CDAudio-In-Funktion
	S/PDIF-Ausgangsanschluss	x1	Unterstützt die digitale Audioausgabefunktion
	CPU-Lüfter-Sockel	x1	CPU-Lüfterstromversorgungsanschluss (mit Smart Fan-Funktion)
	System-Lüfter-Sockel	x1	System-Lüfter-Stromversorgungsanschluss
	"CMOS löschen"-Sockel	x1	
	USB-Anschluss	x2	Jeder Anschluss unterstützt 2 Fronttafel-USB-Anschlüsse
	Stromanschluss (24-polig)	x1	
Stromanschluss (4-polig)	x1		
Rückseiten-E/A	PS/2-Tastatur	x1	
	PS/2-Maus	x1	
	Serieller Anschluss	x1	
	VGA-Anschluss	x1	
	LAN-Anschluss	x1	
	USB-Anschluss	x4	
	Audioanschluss	x3	
Platinengröße	185 mm (B) X 244 mm (L)		
OS-Unterstützung	Windows XP / VISTA		Biostar behält sich das Recht vor, ohne Ankündigung die Unterstützung für ein Betriebssystem hinzuzufügen oder zu entfernen.

FRANCE

SPEC		
UC	LGA 775 Processeurs Intel Core2Duo / Core2Quad / Celeron 4xx / Pentium 4 / Pentium D Prend en charge le 45nm UC	Prend en charge les technologies Hyper-Threading / d'exécution de bit de désactivation / Intel SpeedStep® optimisée/ d'architecture Intel 64 / de mémoire étendue 64 / de virtualisation
Bus frontal	1333 MHz	
Chipset	GeForce 7050/rForce 610	
Graphiques	GeForce 7050/rForce 610	Mémoire vidéo partagée maximale de 512 Mo (under OS)
Super E/S	ITE 8718F Fournit la fonctionnalité de Super E/S patrimoniales la plus utilisée. Interface à faible compte de broches	Initiatives de contrôle environnementales, Moniteur de matériel Contrôleur de vitesse de ventilateur Fonction "Garden intelligent" de l'ITE
Mémoire principale	Fentes DDR2 DIMM x 2 Chaque DIMM prend en charge des DDR2 de 256Mo/512Mo et 1Go/2Go Capacité mémoire maximale de 4 Go Prend en charge la DDR2 533 / 667 / 800	Module de mémoire DDR2 à mode à simple voie Les DIMM à registres et DIMM avec code correcteurs d'erreurs ne sont pas prises en charge
IDE	Contrôleur IDE intégré	Mode principale de Bus Ultra DMA 33/ 66 / 100 / 133 Prend en charge le mode PIO 0~4,
SATA	Contrôleur Serial ATA intégré :	Taux de transfert jusqu'à 3 Go/s. Conforme à la spécification SATA Version 2.0 Prise en charge RAID 0 / 1 / 0+1
LAN	Realtek 8201CL PHY	10 / 100 Mb/s négociation automatique Half / Full duplex capability
Codec audio	ALC662	Sortie audio à 5.1 voies Prise en charge de l'audio haute définition
Fentes	PCI Express x16 Steckplatz x1 PCI Express x1 Steckplatz x1 Fente PCI x2	
Connecteur embarqué	Connecteur de disquette x1	Chaque connector prend en charge 2 lecteurs de disquettes

SPEC			
	Connecteur IDE	x1	Chaque connecteur prend en charge 2 périphériques IDE
	Connecteur de Port d'imprimante	x1	Chaque connecteur prend en charge 1 Port d'imprimante
	Connecteur SATA	x4	Chaque connecteur prend en charge 1 périphérique SATA
	Connecteur du panneau avant	x1	Prend en charge les équipements du panneau avant
	Connecteur Audio du panneau avant	x1	Prend en charge la fonction audio du panneau avant
	Connecteur d'entrée CD	x1	Prend en charge la fonction d'entrée audio de CD
	Connecteur de sortie S/PDIF	x1	Prend en charge la fonction de sortie audio numérique
	Embase de ventilateur UC	x1	Alimentation électrique du ventilateur UC (avec fonction de ventilateur intelligent)
	Embase de ventilateur système	x1	Alimentation électrique du ventilateur système
	Embase d'effacement CMOS	x1	
	Connecteur USB	x2	Chaque connecteur prend en charge 2 ports USB de panneau avant
	Connecteur d'alimentation (24 broches)	x1	
	Connecteur d'alimentation (4 broches)	x1	
E/S du panneau arrière	Clavier PS/2	x1	
	Souris PS/2	x1	
	Port série	x1	
	Port VGA	x1	
	Port LAN	x1	
	Port USB	x4	
	Fiche audio	x3	
Dimensions de la carte	185mm (l) X 244 mm (H)		
Support SE	Windows XP / VISTA		BioStar se réserve le droit d'ajouter ou de supprimer le support de SE avec ou sans préavis.

ITALIAN

SPECIFICA		
CPU	LGA 775 Processore Intel Core 2Duo / Core 2Quad / Celeron 4xx / Pentium 4 / Pentium D Supporto 45nm CPU	Supporto di Hyper-Threading / Execute Disable Bit / Enhanced Intel SpeedStep® / Architettura Intel 64 / Tecnologia Extended Memory 64 / Tecnologia Virtualization
FSB	1333 MHz	
Chipset	GeForce 7050/rForce 610	
Grafica	GeForce 7050/rForce 610	La memoria video condivisa massima è di 512MB (under OS)
Super I/O	ITE 8718F Fornisce le funzionalità legacy Super I/O usate più comunemente. Interfaccia LPC (Low Pin Count)	Funzioni di controllo dell'ambiente: Monitoraggio hardware Controller velocità ventolina Funzione "Smart Guardian" di ITE
Memoria principale	Alloggi DIMM DDR 2 x 2 Ciascun DIMM supporta DDR2 256MB/ 512MB e 1GB/2GB Capacità massima della memoria 4GB Supporto di DDR2 533 / 667 / 800	Modulo di memoria DDR2 a canale singolo DIMM registrati e DIMM ECC non sono supportati
IDE	Controller IDE integrato	Modalità Bus Master Ultra DMA 33 / 66 / 100 / 133 Supporto modalità PIO Mode 0-4
SATA	Controller Serial ATA integrato	Velocità di trasferimento dei dati fino a 3 Gb/s. Compatibile specifiche SATA Versione 2.0. Supporto RAID 0 / 1 / 0+1
LAN	Realtek 8201CLPHY	Negoziatura automatica 10 / 100 Mb/s Capacità Half / Full Duplex
Codec audio	ALC662	Uscita audio 5.1 canali Supporto audio High-Definition (HD)
Alloggi	Fente PCI Express x16 x1 Fente PCI Express x1 x1	

SPECIFICA			
	Alloggio PCI	x2	
Connettori su scheda	Connettore floppy	x1	Ciascun connettore supporta 2 unità Floppy
	Connettore IDE	x1	Ciascun connettore supporta 2 unità IDE
	Connettore Porta stampante	x1	Ciascun connettore supporta 1 Porta stampante
	Connettore SATA	x4	Ciascun connettore supporta 1 unità SATA
	Connettore pannello frontale	x1	Supporta i servizi del pannello frontale
	Connettore audio frontale	x1	Supporta la funzione audio pannello frontale
	Connettore CD-in	x1	Supporta la funzione input audio CD
	Connettore output SPDIF	x1	Supporta la funzione d'output audio digitale
	Collettore ventolina CPU	x1	Alimentazione ventolina CPU (con funzione Smart Fan)
	Collettore ventolina sistema	x1	Alimentazione ventolina di sistema
	Collettore cancellazione CMOS	x1	
	Connettore USB	x2	Ciascun connettore supporta 2 porte USB pannello frontale
	Connettore alimentazione (24 pin)	x1	
Connettore alimentazione (4 pin)	x1		
I/O pannello posteriore	Tastiera PS/2	x1	
	Mouse PS/2	x1	
	Porta seriale	x1	
	Porta VGA	x1	
	Porta LAN	x1	
	Porta USB	x4	
	Connettore audio	x3	
Dimensioni i scheda	185 mm (larghezza) x 244 mm (altezza)		
Sistemi operativi supportati	Windows XP / VISTA		Biostar si riserva il diritto di aggiungere o rimuovere il supporto di qualsiasi sistema operativo senza preavviso.

SPANISH

Especificación		
CPU	LGA 775 Procesador Intel Core2Duo / Core2Quad / Celeron 4xx / Pentium 4 / Pentium D Admite 45nm CPU	Admite Hyper-Threading / Bit de deshabilitación de ejecución / Intel SpeedStep® Mejorado / Intel Architecture-64 / Tecnología Extended Memory 64 / Tecnología de virtualización
FSB	1333 MHz	
Conjunto de chips	GeForce 7050/nForce 610	
Gráficos	GeForce 7050/nForce 610	Memoria máxima de vídeo compartida de 512MB (under OS)
Súper E/S	ITE 8718F Le ofrece las funcionalidades heredadas de uso más común Súper E/S. Interfaz de cuenta Low Pin	Iniciativas de control de entorno, Monitor hardware Controlador de velocidad de ventilador Función "Guarda inteligente" de ITE
Memoria principal	Ranuras DIMM DDR2 x 2 Cada DIMM admite DDR de 256MB/512MB y 1GB/2GB Capacidad máxima de memoria de 4GB Admite DDR2 de 533 / 667 / 800	Módulo de memoria DDR2 de canal Sencillo No admite DIMM registrados o DIMM compatibles con ECC
IDE	Controlador IDE integrado	Modo bus maestro Ultra DMA 33 / 66 / 100 / 133 Soporte los Modos PIO 0~4.
SATA	Controlador ATA Serie Integrado	Tasas de transferencia de hasta 3 Gb/s. Compatible con la versión SATA 2.0. Admite RAID 0 / 1 / 0+1
Red Local	Realtek 8201CL PHY	Negociación de 10 / 100 Mb/s Funciones Half / Full dúplex
Códecs de sonido	ALC662	Salida de sonido de 5.1 canales Soporte de sonido Alta Definición
Ranuras	Ranura PCI Express x16 X1 Ranura PCI Express x1 X1	

Especificación			
	Ranura PCI	X2	
Conectores en placa	Conector disco flexible	X1	Cada conector soporta 2 unidades de disco flexible
	Conector IDE	X1	Cada conector soporta 2 dispositivos IDE
	Conector Puerto de impresora	X1	Cada conector soporta 1 Puerto de impresora
	Conector SATA	X4	Cada conector soporta 1 dispositivos SATA
	Conector de panel frontal	X1	Soporta instalaciones en el panel frontal
	Conector de sonido frontal	X1	Soporta funciones de sonido en el panel frontal
	Conector de entrada de CD	X1	Soporta función de entrada de sonido de CD
	Conector de salida S/PDIF	X1	Soporta función de salida de sonido digital
	Cabecera de ventilador de CPU	X1	Fuente de alimentación de ventilador de CPU (con función Smart Fan)
	Cabecera de ventilador de sistema	X1	Fuente de alimentación de ventilador de sistema
	Cabecera de borrado de CMOS	X1	
	Conector USB	X2	Cada conector soporta 2 puertos USB frontales
	Conector de alimentación (24 patillas)	X1	
Conector de alimentación (4 patillas)	X1		
Panel trásero de E/S	Teclado PS/2	X1	
	Ratón PS/2	X1	
	Puerto serie	X1	
	Puerto VGA	X1	
	Puerto de red local	X1	
	Puerto USB	X4	
	Conector de sonido	X3	
Tamaño de la placa	185 mm. (A) X 244 mm. (H)		
Soporte de sistema operativo	Windows XP / VISTA		Biostar se reserva el derecho de añadir o retirar el soporte de cualquier SO con o sin aviso previo.

PORTUGUESE

ESPECIFICAÇÕES		
CPU	LGA 775 Processador Intel Core2Duo / Core2Quad / Celeron 4xx / Pentium 4 / Pentium D Suporta 45nm CPU	Suporta as tecnologias Hyper-Threading / Execute Disable Bit / Enhanced Intel SpeedStep® / Intel Architecture -64 / Extended Memory 64 / Virtualization
FSB	1333 MHz	
Chipset	GeForce 7050/rForce 610	
Placa gráfica	GeForce 7050/rForce 610	Memória de vídeo máxima partilhada: 512 MB (under OS)
Especificação do Super I/O	ITE 8718F Proporciona as funcionalidades mais utilizadas em termos da especificação Super I/O. Interface LPC (Low Pin Count).	Iniciativas para controlo do ambiente Monitorização do hardware Controlador da velocidade da ventoinha Função "Smart Guardian" da ITE
Memória principal	Ranhuras DIMM DDR2 x2 Cada módulo DIMM suporta uma memória DDR2 de 256 MB/512 MB & 1 GB/2 GB Capacidade máxima de memória: 4 GB Suporta módulos DDR2 533 / 667 / 800	Módulo de memória DDR2 de canal simples Os módulos DIMM registados e os DIMM ECC não são suportados
IDE	Controlador IDE integrado	Modo Bus master Ultra DMA 33 / 66 / 100 / 133 Suporta o modo PIO 0~4.
SATA	Controlador Serial ATA integrado	Velocidades de transmissão de dados até 3 Gb/s. Compatibilidade com a especificação SATA versão 2.0. Suporta as funções RAID 0 / 1 / 0+1
LAN	Realtek 8201CL PHY	Auto negociação de 10 / 100 Mb/s Capacidade semi/full-duplex
Codec de som	ALC662	Saída de áudio de 5.1 canais Suporta a especificação High-Definition Audio
Ranhuras	Ranhura PCI Express x16 x1 Ranhura PCI Express x1 x1 Ranhura PCI x2	

ESPECIFICAÇÕES			
Conectores na placa	Conector da unidade de disquetes	x1	Cada conector suporta 2 unidades de disquetes
	Conector IDE	x1	Cada conector suporta 2 dispositivos IDE
	Conector da para impressora	x1	Cada conector suporta 1 Porta para impressora
	Conector SATA	x4	Cada conector suporta 1 dispositivo SATA
	Conector do painel frontal	x1	Para suporte de várias funções no painel frontal
	Conector de áudio frontal	x1	Suporta a função de áudio no painel frontal
	Conector para entrada de CDs	x1	Suporta a entrada de áudio a partir de CDs
	Conector de saída S/PDIF	x1	Suporta a saída de áudio digital
	Conector da ventoinha da CPU	x1	Alimentação da ventoinha da CPU (com a função Smart Fan)
	Conector da ventoinha do sistema	x1	Alimentação da ventoinha do sistema
	Conector para limpeza do CMOS	x1	
Entradas/Saídas no painel traseiro	Conector USB	x2	Cada conector suporta 2 portas USB no painel frontal
	Conector de alimentação (24 pinos)	x1	
	Conector de alimentação (4 pinos)	x1	
	Teclado PS/2	x1	
	Rato PS/2	x1	
Tamanho da placa	Porta série	x1	
	Porta VGA	x1	
	Porta LAN	x1	
	Porta USB	x4	
Sistemas operativos suportados	Tomada de áudio	x3	
	Windows XP / VISTA		A Biostar reserva-se o direito de adicionar ou remover suporte para qualquer sistema operativo com ou sem aviso prévio.

POLISH

SPEC		
Procesor	LGA 775 Procesor Intel Core2Duo / Core2Quad / Celeron 4xx / Pentium 4 / Pentium D Obsługa 45nm Procesor	Obsługa Hyper-Threading / Execute Disable Bit / Enhanced Intel SpeedStep® / Intel Architecture-64 / Extended Memory 64 Technology / Virtualization Technology
FSB	1333 MHz	
Chipset	GeForce 7050/nForce 610	
Grafika	GeForce 7050/nForce 610	Maks. wielkość współdzielonej pamięci video wynosi 512MB (under OS)
Pamięć główna	Gniazda DDR2 DIMM x 2 Każde gniazdo DIMM obsługuje moduły 256MB/ 512MB oraz 1GB/2GB DDR2 Maks. wielkość pamięci 4GB Obsługa DDR2 533 / 667 / 800	Moduł pamięci DDR2 z trybem pojedynczego kanału Brak obsługi Registered DIMM oraz ECC DIMM
Super I/O	ITE 8718F Zapewnia najbardziej powszechne funkcje Super I/O. Interfejs Low Pin Count	Funkcje kontroli warunków pracy Monitor H/W Kontroler prędkości wentylatora Funkcja ITE "Smart Guardian"
IDE	Zintegrowany kontroler IDE	Ultra DMA 33 / 66 / 100 / 133 Tryb Bus Master obsługa PIO tryb 0~4
SATA	Zintegrowany kontroler Serial ATA	Transfer danych do 3 Gb/s. Zgodność ze specyfikacją SATA w wersji 2.0. Obsługa RAID 0 / 1 / 0+1
LAN	Realtek 8201CL PHY	10 / 100 Mb/s z automatyczną negocjacją szybkości Działanie w trybie półowicznego / pełnego dupleksu
Kodek dźwiękowy	ALC662	5.1 kanałowe wyjście audio Obsługa High-Definition Audio
Gniazda	Gniazdo PCI Express x16 x1 Gniazdo PCI Express x1 x1 Gniazdo PCI x2	

SPEC			
Złącza wbudowane	Złącze napędu dyskietek	x1	Każde złącze obsługuje 2 napędy dyskietek
	Złącze IDE	x1	Każde złącze obsługuje 2 urządzenia IDE
	Złącze Port drukarki	x1	Każde złącze obsługuje 1 Port drukarki
	Złącze SATA	x4	Każde złącze obsługuje 1 urządzenie SATA
	Złącze panela przedniego	x1	Obsługa elementów panela przedniego
	Przednie złącze audio	x1	Obsługa funkcj audio na panelu przednim
	Złącze wejścia CD	x1	Obsługa funkcj wejścia audio CD
	Złącze wyjścia S/PDIF	x1	Obsługa funkcj cyfrowego wyjścia audio
	Złącze główkowe wentylatora procesora	x1	Zasilanie wentylatora procesora (z funkcją Smart Fan)
	Złącze główkowe wentylatora systemowego	x1	Zasilanie wentylatora systemowego
	Złącze główkowe kasowania CMOS	x1	
Złącze USB	x2	Każde złącze obsługuje 2 porty USB na panelu przednim	
Złącze zasilania (24 pinowe)	x1		
Złącze zasilania (4 pinowe)	x1		
Back Panel I/O	Klawiatura PS/2	x1	
	Mysz PS/2	x1	
	Port szeregowy	x1	
	Port VGA	x1	
	Port LAN	x1	
	Port USB	x4	
	Gniazdo audio	x3	
Wymiary płyty	185 mm (S) X 244 mm (W)		
Obsługa systemu operacyjne go	Windows XP / VISTA		Biostar zastrzega sobie prawo dodawania lub odwoływania obsługi dowolnego systemu operacyjnego bez powiadomienia.

RUSSIAN

СПЕЦ		
CPU (центральный процессор)	LGA 775 Процессор Intel Core2Duo / Core2Quad / Celeron 4xx / Pentium 4 / Pentium D Поддержка технологий 45nm CPU	Поддержка технологий Hyper-Threading / Execute Disable Bit / Enhanced Intel SpeedStep® / Intel Architecture-64 / Extended Memory 64 Technology / технологии виртуализация
FSB	1333 МГц	
Набор микросхем	GeForce 7050/nForce 610	
Графика	GeForce 7050/nForce 610	Максимальная совместно используемая видеопамять составляет 512 МБ (under OS)
Основная память	Слоты DDR2 DIMM x 2 Каждый модуль DIMM поддерживает 256 МБ / 512 МБ & 1 ГБ / 2 ГБ DDR2 Максимальная ёмкость памяти 4 ГБ Поддержка DDR2 533 / 667 / 800	Модуль памяти с одноканальным режимом DDR2 Не поддерживает зарегистрированные модули DIMM and ECC DIMM
Super I/O	ITE 8718F Обеспечивает наиболее используемые действующие функциональные возможности Super I/O. Интерфейс с низким количеством выводов	Инициативы по охране окружающей среды, Аппаратный монитор Регулятор скорости Функция ITE "Smart Guardian" (Интеллектуальная защита)
IDE	Встроенное устройство управления встроенными интерфейсами устройств	Режим "хвояина" шины Ultra DMA 33 / 66 / 100 / 133 Поддержка режима PIO 0~4,
SATA	Встроенное последовательное устройство управления ATA	скорость передачи данных до 3 гигабит/с. Соответствие спецификации SATA версия 2.0. Поддержка RAID 0 / 1 / 0+1
Локальная сеть	Realtek 8201CL PHY	Автоматическое согласование 10 / 100 Мб/с Частичная / полная дуплексная способность
Звуковой кодек	ALC662	5.1 канальный звуковой выход Звуковая поддержка High-Definition
Слоты	Слот PCI Express x16 x1 Слот PCI Express x1 x1 Слот PCI x2	
Встроенный разъём	Разъём HГМД x1 Разъём IDE x1	Каждый разъём поддерживает 2 накопителя на гибких магнитных дисках Каждый разъём поддерживает 2 встроенных интерфейса накопителей

СПЕЦ			
	Разъём Порт подключения принтера	x1	Каждый разъём поддерживает 1 Порт подключения принтера Каждый разъём поддерживает 1 устройство SATA Поддержка устройств на лицевой панели Поддержка звуковых функций на лицевой панели Поддержка функции ввода для CD Поддержка вывода цифровой звуковой функции Источник питания для вентилятора центрального процессора (с функцией интеллектуального вентилятора) Источник питания для вентилятора системы Открытое контактирующее приспособление CMOS Каждый разъём поддерживает 2 USB-порта на лицевой панели
	Разъём SATA	x4	
	Разъём на лицевой панели	x1	
	Входной звуковой разъём	x1	
	Разъём ввода для CD	x1	
	Разъём вывода для S/PDIF	x1	
	Контактирующее приспособление вентилятора центрального процессора	x1	
	Контактирующее приспособление вентилятора системы	x1	
	Открытое контактирующее приспособление CMOS	x1	
	USB-разъём	x2	
	Разъём питания (24 вывод)	x1	
	Разъём питания (4 вывод)	x1	
Задняя панель средств ввода-вывода	Клавиатура PS/2	x1	
	Мышь PS/2	x1	
	Последовательный порт	x1	
	Порт VGA	x1	
	Порт LAN	x1	
	USB-порт	x4	
	Гнездо для подключения наушников	x3	
Размер панели	185 мм (Ш) X 244 мм (В)		
Поддержка OS	Windows XP / VISTA		Biostar сохраняет за собой право добавлять или удалять средства обеспечения для OS с или без предварительного уведомления.

ARABIC

المواصفات		
Hyper-Threading / Execute Disable Bit / Enhanced Intel SpeedStep® / Intel Architecture-64 / Extended Memory 64 Technology / Virtualization Technology	LGA 775 Intel Core2Duo / Core2Quad / Celeron 4xx Pentium 4 / Pentium D 45nm CPU	وحدة لمعالجة المركبة
	1333 تردد	النقل الأممي الجانبي
	GeForce 7050/nForce 610i	مجموعة لشرايح
ميجا بايت (under OS) 512 أقصى سعة لذاكرة لفيبرو لمشوكة	GeForce 7050/nForce 610i	بطاقة الرسومات
أحلية للذاكرة DDR2 وحدة ذاكرة ECC وتك التي لا تتوافق مع DIMM لا تدعم رقائق الذاكرة	2 عدد DDR2 DIMM فتحة ميجا 256/512 سعة DDR2 دعم ذاكرة من نوع DIMM تدعم كل فتحة بيت و 1/2 جيجا بايت سعة ذاكرة قصوى 4 جيجا بايت ميجا بايت 800 / 667 / 533 سعرات DDR2 تدعم الذاكرة من نوع	الذاكرة الرئيسية
وسائل التحكم في البيئة مراقب لمعرفة حالة الأجهزة مراقب في سرعة المروحة ITE من "Smart Guardian" وظيفة	ITE 8718F الأكثر استخداماً. Super I/O يوفر وظيفة Low Pin Count Interface تدعم تقنية	Super I/O
Ultra DMA 33 / 66 / 100 / 133 وضع رئيسي PIO Mode 0 ~ 4	متكامل IDE متحكم	منفذ IDE
تصل البيانات بمسرعات تصل إلى 3 جيجابت/ثانية. الإصدار SATA مطابقة للمواصفات RAID 0 / 1 / 0+1 تدعم تقنية	متكامل Serial ATA متحكم	SATA
تقويض قتي 100/10 ميجا بايت /ثانية إمكانية النقل لمزيج الكامل/القصي	Realtek 8201CL PHY	شبكة داخلية 100/10
قنوات لخرج الصوت 5.1 تدعم تقنية الصوت على التعريف من	ALC662	كوديك الصوت
	عدد 1 فتحة PCI Express x16 عدد 1 فتحة PCI Express x1 عدد 2 فتحة PCI	الفتحات

المواصفات		
مقذ محرك أقراص مرنة	عدد 1	يدعم محركين لأقراص مرنة
مقذ IDE	عدد 1	IDE يدعم كل من الأقراص من أجهزة
مقذ طابعة	عدد 1	
مقذ SATA	عدد 4	SATA يدعم كل من منفذ واحد من أجهزة
مقذ اللوحة الأممية	عدد 1	يدعم تجهيزات اللوحة الأممية
مقذ الصوت الأممي	عدد 1	يدعم وظيفة الصوت باللوحة الأممية
مقذ CD-IN	عدد 1	يدعم وظيفة دخل صوت الوصل لدمج
مقذ خرج S/PDIF	عدد 1	يدعم وظيفة خرج لصوت رقمي
وصلة مروحة وحدة المعالجة المركزية	عدد 1	(Smart Fan) لتوصيل الطاقة لروحة وحدة المعالجة (مع وظيفة
وصلة مروحة للتظلم	عدد 1	لتوصيل الطاقة لروحة التظلم
وصلة مسح CMOS	عدد 1	
مقذ USB	عدد 2	بالوحة الأممية USB يدعم كل من قحني
مقذ توصيل الطاقة (24-دوس)	عدد 1	
مقذ توصيل الطاقة (4-بيليس)	عدد 1	
لوحة مفاتيح PS2	عدد 1	
موس PS/2	عدد 1	
مقذ تسلسلي	عدد 1	
مقذ VGA	عدد 1	
مقذ شبكة لتصل محلية	عدد 1	
منافذ USB	عدد 4	
مقيس صوت	عدد 3	
حجم اللوحة	185 مم (عرض) X 244 مم (ارتفاع)	
دعم أنظمة تشغيل	Windows XP / VISTA	بخطها في إضافة أو إزالة الدعم لأي نظام تشغيل بإخطار أو Biostar تحتفظ بيون إخطار.

JAPANESE

仕様		
CPU	LGA 775 Intel Core2Duo / Core2Quad / Celeron 4xx / Pentium 4 / Pentium D processor 45nm CPU をサポートします	Hyper-Threading / Execute Disable Bit / Enhanced Intel SpeedStep® / Intel Architecture-64 / Extended Memory 64 Technology / Virtualization Technologyをサポート します
FSB	1333 MHz	
チップセット	GeForce 7050/nForce 610	
グラフィック ス	GeForce 7050/nForce 610	最大の共有ビデオメモリは512MBです (under OS)
メインメモリ ート	DDR2 DIMMスロット x 2 各DIMMは256MB/512MB/1GB/2GB DDR2をサポ ート 最大メモリ容量 4GB DDR2 533 / 667 / 800 をサポート	シングル チャンネルモードDDR2メモリモジュール 登録済みDIMMとECC DIMMはサポートされません
Super I/O	ITE 8718F もつとも一般に使用されるレガシーSuper I/O機能を 採用しています。 低ピンカウントインターフェイス	環境コントロールイニシアチブ、 H/Wモニター ファン速度コントローラ / モニター ITEの「スマートガーディアン」機能
IDE	統合IDEコントローラ	Ultra DMA 33 / 66 / 100 / 133バスマスタモード PIO Mode 0~4のサポート
SATA	統合シリアルATAコントローラ	最高3 Gb/秒のデータ転送速度 SATAバージョン2.0仕様に準拠。 RAID 0 / 1 / 0+1 のサポート
10/100 LAN	Realtek 8201CL PHY	10 / 100 Mb/秒のオート ネゴシエーション 半/全二重機能
サウンド Codec	ALC662	5.1チャンネルオーディオアウト ハイデフィニションオーディオのサポート
スロット	PCI Express x16スロット x1 PCI Express x1スロット x1 PCIスロット x2	

仕様			
オンボードコネクタ	フロッピーコネクタ	x1	各コネクタは2つのフロッピードライブをサポートします
	IDEコネクタ	x1	各コネクタは2つのIDEデバイスをサポートします
	プリンタポートコネクタ	x1	各コネクタは1つのプリンタポートをサポートします
	SATAコネクタ	x4	各コネクタは1つのSATAデバイスをサポートします
	フロントパネルコネクタ	x1	フロントパネル機能をサポートします
	フロントオーディオコネクタ	x1	フロントパネルオーディオ機能をサポートします
	CDインコネクタ	x1	CDオーディオイン機能をサポートします
	S/PDIFアウトコネクタ	x1	デジタルオーディオアウト機能をサポートします
	CPUファンヘッダ	x1	CPUファン電源装置(スマートファン機能を搭載)
	システムファンヘッダ	x1	システムファン電源装置
	CMOSクリアヘッダ	x1	
	USBコネクタ	x2	各コネクタは2つのフロントパネルUSBポートをサポートします
	電源コネクタ(24ピン)	x1	
電源コネクタ(4ピン)	x1		
背面パネルI/O	PS/2キーボード	x1	
	PS/2マウス	x1	
	シリアルポート	x1	
	VGAポート	x1	
	LANポート	x1	
	USBポート	x4	
	オーディオジャック	x3	
ボードサイズ	185 mm (幅) X 244 mm (高さ)		
OSサポート	Windows XP / VISTA	Bicstarは事前のサポートなしにOSサポートを追加または削除する権利を留保します。	

2008/02/22