

FCC Information and Copyright

This equipment has been tested and found to comply with the limits of a Class B digital device, pursuant to Part 15 of the FCC Rules. These limits are designed to provide reasonable protection against harmful interference in a residential installation. This equipment generates, uses, and can radiate radio frequency energy and, if not installed and used in accordance with the instructions, may cause harmful interference to radio communications. There is no guarantee that interference will not occur in a particular installation.

The vendor makes no representations or warranties with respect to the contents here and specially disclaims any implied warranties of merchantability or fitness for any purpose. Further the vendor reserves the right to revise this publication and to make changes to the contents here without obligation to notify any party beforehand.

Duplication of this publication, in part or in whole, is not allowed without first obtaining the vendor's approval in writing.

The content of this user's manual is subject to be changed without notice and we will not be responsible for any mistakes found in this user's manual. All the brand and product names are trademarks of their respective companies.

Table of Contents

Chapter 1: Introduction	3
1.1 Before You Start.....	3
1.2 Package Checklist.....	3
1.3 Motherboard Features.....	4
1.4 Rear Panel Connectors.....	6
1.5 Motherboard Layout.....	7
Chapter 2: Hardware Installation.....	8
2.1 Installing Central Processing Unit (CPU).....	8
2.2 FAN Headers.....	10
2.3 Installing System Memory.....	11
2.4 Connectors and Slots.....	13
Chapter 3: Headers & Jumpers Setup	15
3.1 How to Setup Jumpers.....	15
3.2 Detail Settings.....	15
Chapter 4: RAID Functions.....	21
4.1 Operation System.....	21
4.2 Raid Arrays.....	21
4.3 How RAID Works.....	21
Chapter 5: Useful Help	25
5.1 Driver Installation Note	25
5.2 Award BIOS Beep Code.....	26
5.3 Extra Information.....	26
5.4 Troubleshooting.....	27
Chapter 6: WarpSpeeder™ III	28
6.1 Introduction.....	28
6.2 System Requirement.....	28
6.3 Installation	29
6.4 WarpSpeeder™ III.....	30
Appendices: SPEC In Other Language	36
German.....	36
France.....	38
Italian.....	40
Spanish.....	42
Portuguese.....	44
Polish.....	46
Russian.....	48
Arabic.....	50
Japanese	52

CHAPTER 1: INTRODUCTION

1.1 BEFORE YOU START

Thank you for choosing our product. Before you start installing the motherboard, please make sure you follow the instructions below:

- Prepare a dry and stable working environment with sufficient lighting.
- Always disconnect the computer from power outlet before operation.
- Before you take the motherboard out from anti-static bag, ground yourself properly by touching any safely grounded appliance, or use grounded wrist strap to remove the static charge.
- Avoid touching the components on motherboard or the rear side of the board unless necessary. Hold the board on the edge, do not try to bend or flex the board.
- Do not leave any unfastened small parts inside the case after installation. Loose parts will cause short circuits which may damage the equipment.
- Keep the computer from dangerous area, such as heat source, humid air and water.

1.2 PACKAGE CHECKLIST

- ✦ HDD Cable X 1
- ✦ Serial ATA Cable X 1
- ✦ Rear I/O Panel for ATX Case X 1
- ✦ User's Manual X 1
- ✦ Fully Setup Driver CD X 1
- ✦ FDD Cable X 1 (optional)
- ✦ USB 2.0 Cable X1 (optional)
- ✦ S/PDIF out Cable X 1 (optional)

1.3 MOTHERBOARD FEATURES

	<i>Ver 5.x</i>	<i>Ver 6.x</i>
CPU	Socket AM2 AMD Athlon 64 / Athlon 64 FX / Athlon 64 x2 / Sempron processors AMD 64 Architecture enables 32 and 64 bit computing Supports Hyper Transport and Cool'nQuiet	Socket AM2 AMD Athlon 64 / Athlon 64 FX / Athlon 64 x2 / Sempron processors AMD 64 Architecture enables 32 and 64 bit computing Supports Hyper Transport and Cool'nQuiet
FSB	Supports up to 1 GHz Bandwidth Support HyperTransport	Supports up to 1 GHz Bandwidth Support HyperTransport
Chipset	GeForce 7025/NF 630a	GeForce 7025/NF 630a
Super I/O	ITE 8716F Provides the most commonly used legacy Super I/O functionality Low Pin Count Interface Environment Control initiatives, H/W Monitor Fan Speed Controller ITE's "Smart Guardian" function	ITE 8716F Provides the most commonly used legacy Super I/O functionality Low Pin Count Interface Environment Control initiatives, H/W Monitor Fan Speed Controller ITE's "Smart Guardian" function
Main Memory	DDR2 DIMM Slots x 2 Max Memory Capacity 4GB Each DIMM supports 256MB/512MB/1GB/ 2GB DDR2 Dual Channel Mode DDR2 memory module Supports DDR2 533 / 667 / 800 Registered DIMM and ECC DIMM is not supported	DDR2 DIMM Slots x 2 Max Memory Capacity 4GB Each DIMM supports 256MB/512MB/1GB/ 2GB DDR2 Dual Channel Mode DDR2 memory module Supports DDR2 533 / 667 / 800 Registered DIMM and ECC DIMM is not supported
Graphics	Integrated in GeForce 7025/NF630a Chipset Max Shared Video Memory is 512MB	Integrated in GeForce 7025/NF630a Chipset Max Shared Video Memory is 512MB
IDE	Integrated IDE Controller Ultra DMA 33 / 66 / 100 / 133 Bus Master Mode supports PIO Mode 0~4,	Integrated IDE Controller Ultra DMA 33 / 66 / 100 / 133 Bus Master Mode supports PIO Mode 0~4,
SATA II	Integrated Serial ATA Controller Data transfer rates up to 3 Gb/s. SATA Version 2.0 specification compliant.	Integrated Serial ATA Controller Data transfer rates up to 3 Gb/s. SATA Version 2.0 specification compliant.
LAN	Realtek RTL 8201N / 8211B (optional) 10 / 100 Mb/s / 1Gb/s auto negotiation (Gigabit bandwidth is for RTL 8211B only) Half / Full duplex capability	Realtek RTL 8201N / 8211B (optional) 10 / 100 Mb/s / 1Gb/s auto negotiation (Gigabit bandwidth is for RTL 8211B only) Half / Full duplex capability

	<i>Ver 5.x</i>		<i>Ver 6.x</i>	
Sound	ALC888 7.1 channels audio out High Definition Audio		ALC662 5.1 channels audio out High Definition Audio	
Slots	PCI slot	x2	PCI slot	x2
	PCI Express x16 slot	x1	PCI Express x16 slot	x1
	PCI Express x 1 slot	x1	PCI Express x 1 slot	x1
On Board Connector	Floppy connector	x1	Floppy connector	x1
	Printer Port connector	x1	Printer Port connector	x1
	IDE Connector	x1	IDE Connector	x1
	SATA Connector	x4	SATA Connector	x4
	Front Panel Connector	x1	Front Panel Connector	x1
	Front Audio Connector	x1	Front Audio Connector	x1
	CD-in Connector	x1	CD-in Connector	x1
	S/PDIF out connector	x1	S/PDIF out connector	x1
	CPU Fan header	x1	CPU Fan header	x1
	System Fan header	x1	System Fan header	x1
	CMOS clear header	x1	CMOS clear header	x1
	USB connector	x3	USB connector	x3
	Serial port Connector	x1	Serial port Connector	x1
	Power Connector (24pin)	x1	Power Connector (24pin)	x1
Power Connector (4pin)	x1	Power Connector (4pin)	x1	
Back Panel I/O	PS/2 Keyboard	x1	PS/2 Keyboard	x1
	PS/2 Mouse	x1	PS/2 Mouse	x1
	VGA port	x1	VGA port	x1
	DVI-D port	x1	DVI-D port	x1
	LAN port	x1	LAN port	x1
	USB Port	x4	USB Port	x4
	Audio Jack	x6	Audio Jack	x3
Board Size	208 mm(W) x 244 mm(L)		208 mm(W) x 244 mm(L)	
Special Features	RAID 0 / 1 / 5 / 0+1 support		RAID 0 / 1 / 5 / 0+1 support	
OS Support	Windows 2000 / XP / VISTA Biostar Reserves the right to add or remove support for any OS With or without notice.		Windows 2000 / XP / VISTA Biostar Reserves the right to add or remove support for any OS With or without notice.	

1.4 REAR PANEL CONNECTORS

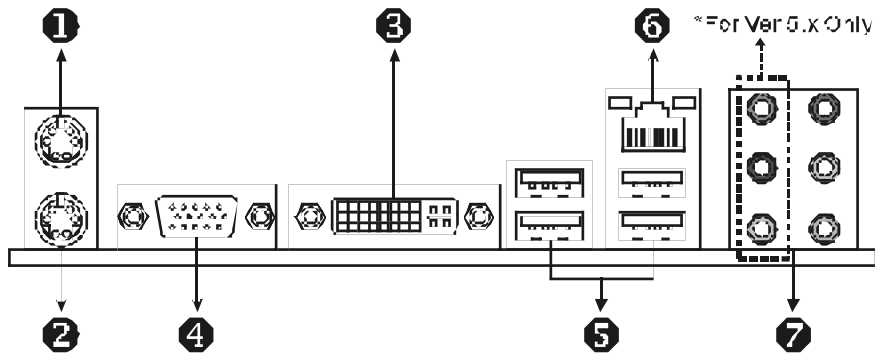

1 PS/2 Mouse Port

2 PS/2 Keyboard Port

3 DVI-D VGA Port

The Digital Visual Interface (DVI) is a video interface transmitting digital video signals to digital display devices such as flat panel LCDs or digital projectors. The DVI-D connector allows digital signals transmission only.

4 D-Sub VGA Port

Transmit analog video signals to computer monitor or any other display panels equipped with D-Sub VGA input.

5 USB 2.0 Port x 4

6 RJ-45 LAN Port

7 Audio Jack x 6 (for Ver 5.x) / Audio Jack x 3 (for Ver 6.x)

Port	2-Channel	4-Channel	6-Channel/8-Channel
Blue	Line-In	Line-In	Line-In
Green	Line-Out	Front Speaker Out	Front Speaker Out
Pink	Mic In	Mic In	Mic In
Orange			Center/Subwoofer
Black	Rear Speaker Out	Rear Speaker Out	Rear Speaker Out
Grey			Side Speaker Out

1.5 MOTHERBOARD LAYOUT

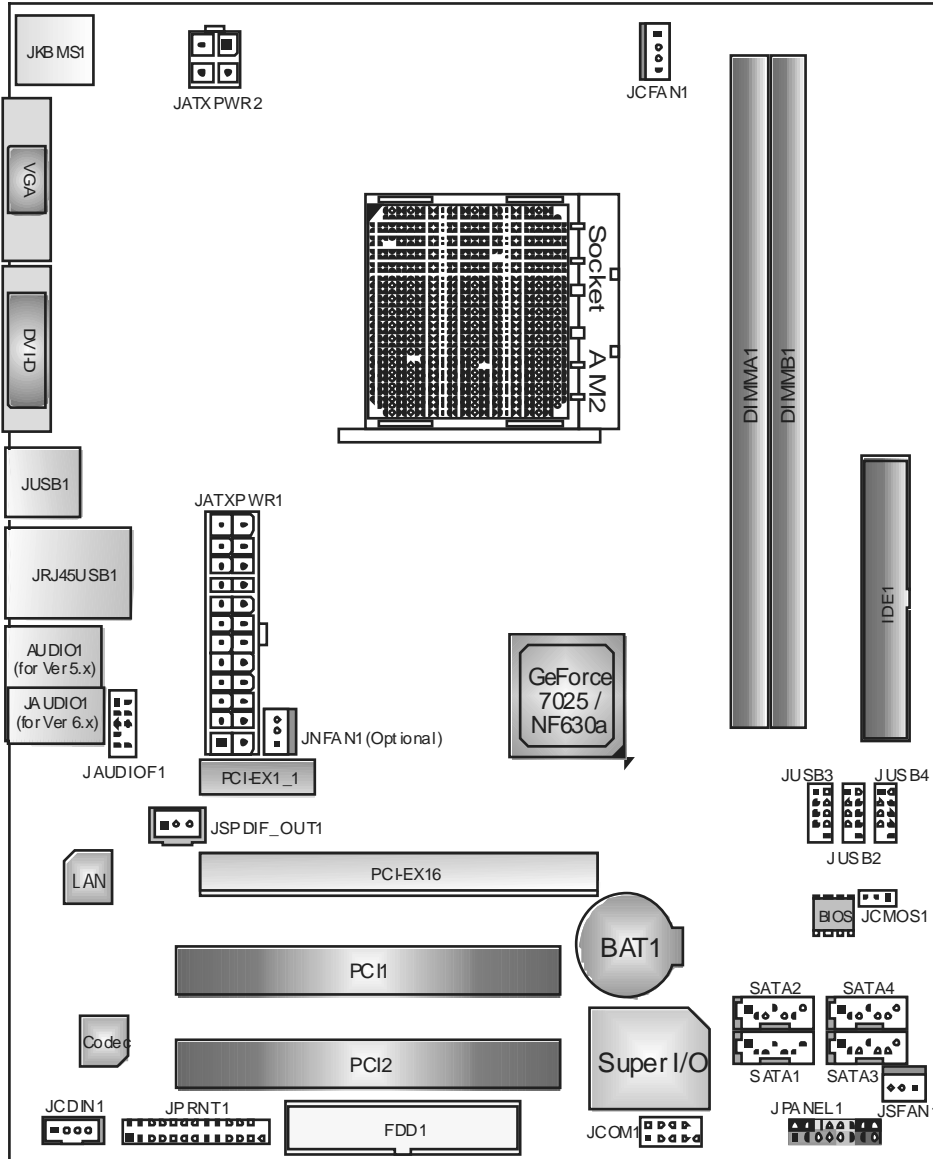

Note: ■ represents the 1st pin.

CHAPTER 2: HARDWARE INSTALLATION

2.1 INSTALLING CENTRAL PROCESSING UNIT (CPU)

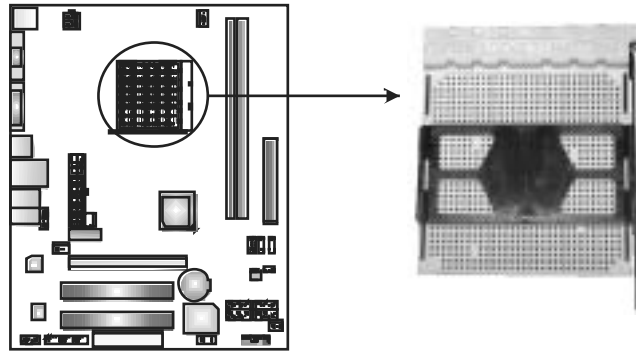

Step 1: Remove the socket protection cap.

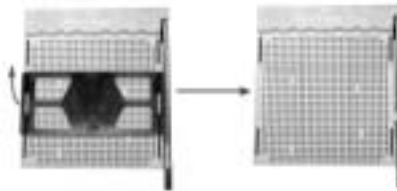

Step 2: Pull the lever toward direction A from the socket and then raise the lever up to a 90-degree angle.

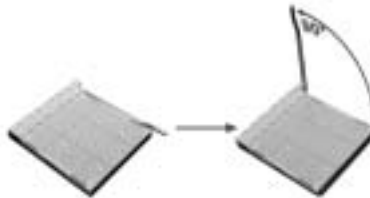

Step 3: Look for the white triangle on socket, and the gold triangle on CPU should point towards this white triangle. The CPU will fit only in the correct orientation.



Step 4: Hold the CPU down firmly, and then close the lever toward direct B to complete the installation.

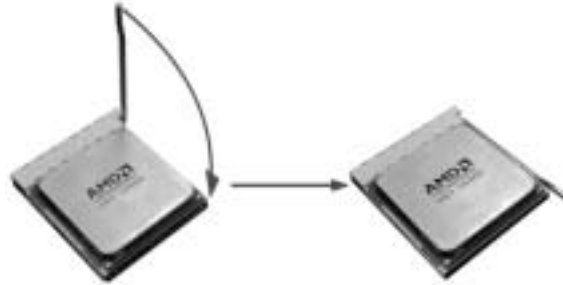

Step 5: Put the CPU Fan on the CPU and buckle it. Connect the CPU FAN power cable to the JCFAN1. This completes the installation.

2.2 FAN HEADERS

These fan headers support cooling-fans built in the computer. The fan cable and connector may be different according to the fan manufacturer. Connect the fan cable to the connector while matching the black wire to pin#1.

JCFAN1: CPU Fan Header

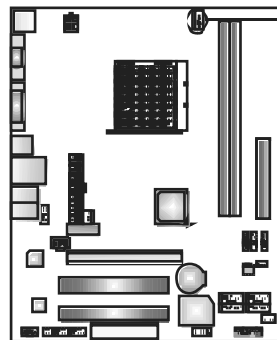

Pin	Assignment
1	Ground
2	+12V
3	FAN RPM rate sense
4	Smart Fan Control (By Fan)

JNFAN1: North Bridge Fan Header (Optional)

JSFAN1: System Fan Header

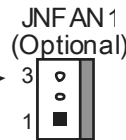
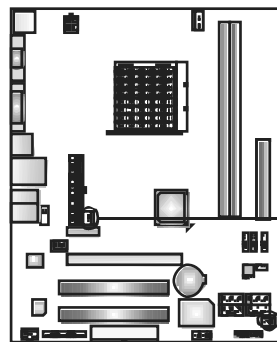

Pin	Assignment
1	Ground
2	+12V
3	FAN RPM rate sense

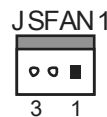

Note:

The JCFAN1 supports 4-pin head connector. The JSFAN1 and JNFAN1 support 3-pin head connectors. When connecting with wires onto connectors, please note that the red wire is the positive and should be connected to pin#2, and the black wire is Ground and should be connected to GND.

2.3 INSTALLING SYSTEM MEMORY

A. Memory Modules

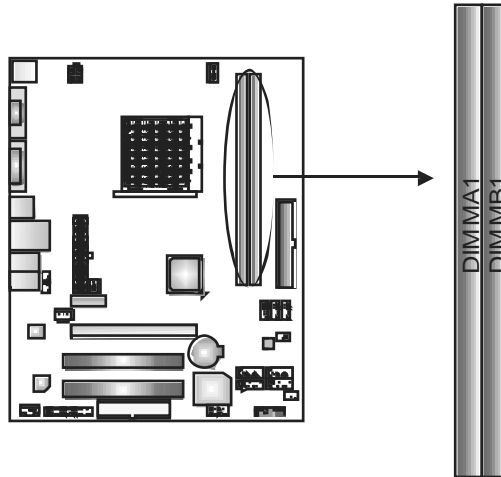

1. Unlock a DIMM slot by pressing the retaining clips outward. Align a DIMM on the slot such that the notch on the DIMM matches the break on the Slot.

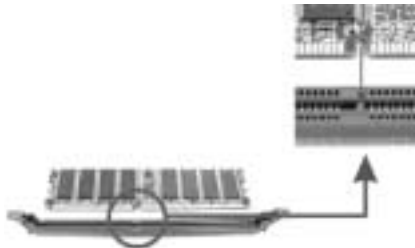

2. Insert the DIMM vertically and firmly into the slot until the retaining chip snap back in place and the DIMM is properly seated.

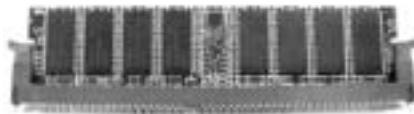

B. Memory Capacity

DIMM Socket Location	DDR2 Module	Total Memory Size
DIMMA1	256MB/512MB/1GB/2GB	Max is 4GB.
DIMMB1	256MB/512MB/1GB/2GB	

C. Dual Channel Memory installation

To trigger the Dual Channel function of the motherboard, the memory module must meet the following requirements:

Install memory module of the same density in pair, shown in the following table.

Dual Channel Status	DIMMA1	DIMMB1
Disabled	O	X
Disabled	X	O
Enabled	O	O

(O means memory installed, X means memory not installed.)

The DRAM bus width of the memory module must be the same (x8 or x16)

2.4 CONNECTORS AND SLOTS

FDD1: Floppy Disk Connector

The motherboard provides a standard floppy disk connector that supports 360K, 720K, 1.2M, 1.44M and 2.88M floppy disk types. This connector supports the provided floppy drive ribbon cables.

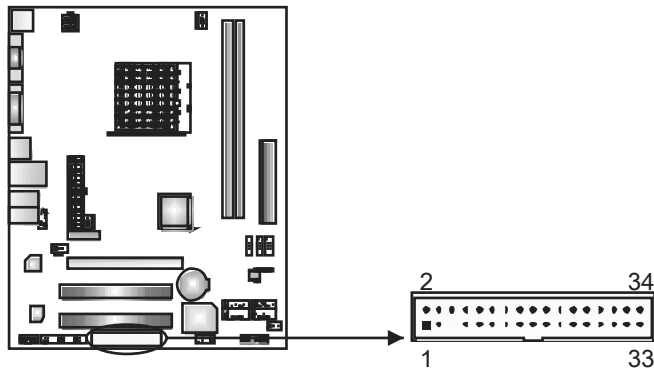

IDE1: Hard Disk Connector

The motherboard has a 32-bit Enhanced PCI IDE Controller that provides PIO Mode 0-4, Bus Master, and Ultra DMA 33/66/100/133 functionality.

The IDE connector can connect a master and a slave drive, so you can connect up to two hard disk drives.

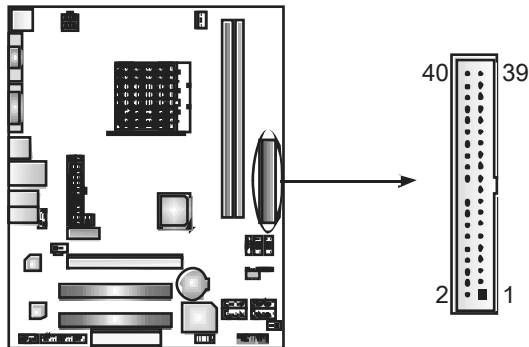

PCI-EX16: PCI-Express x16 Slot

- PCI-Express 1.0a compliant.
- Maximum theoretical realized bandwidth of 4GB/s simultaneously per direction, for an aggregate of 8GB/s totally.

PCI-EX1_1: PCI-Express x1 Slot

- PCI-Express 1.0a compliant.
- Data transfer bandwidth up to 250MB/s per direction; 500MB/s in total.
- PCI-Express supports a raw bit-rate of 2.5GB/s on the data pins.
- 2X bandwidth over the traditional PCI architecture.

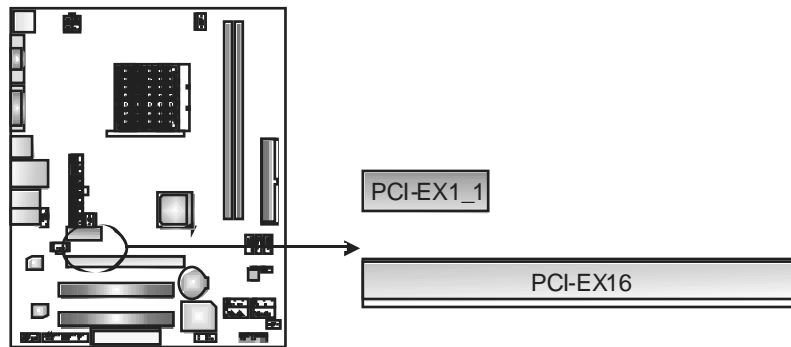

PCI1~PCI2: Peripheral Component Interconnect Slots

This motherboard is equipped with 2 standard PCI slots. PCI stands for Peripheral Component Interconnect, and it is a bus standard for expansion cards. This PCI slot is designated as 32 bits.

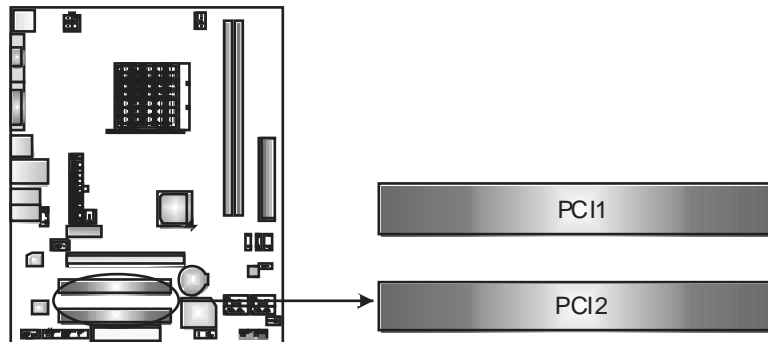

CHAPTER 3: HEADERS & JUMPERS SETUP

3.1 HOW TO SETUP JUMPERS

The illustration shows how to set up jumpers. When the jumper cap is placed on pins, the jumper is “close”, if not, that means the jumper is “open”.



3.2 DETAIL SETTINGS

JPANEL1: Front Panel Header

This 16-pin connector includes Power-on, Reset, HDD LED, Power LED, Sleep button and speaker connection. It allows user to connect the PC case's front panel switch functions.

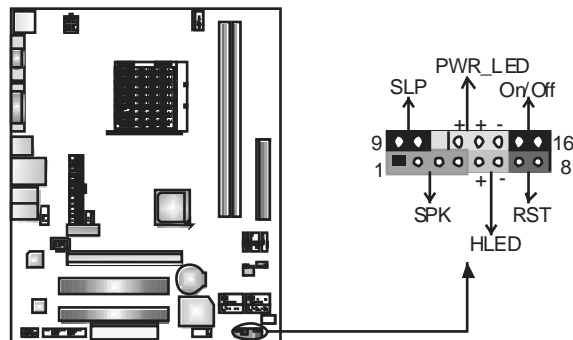

Pin	Assignment	Function	Pin	Assignment	Function
1	+5V		9	Sleep control	Sleep button
2	N/A	Speaker Connector	10	Ground	
3	N/A		11	N/A	N/A
4	Speaker		12	Power LED (+)	Power LED
5	HDD LED (+)	Hard drive LED	13	Power LED (+)	
6	HDD LED (-)		14	Power LED (-)	
7	Ground	Reset button	15	Power button	Power-on button
8	Reset control		16	Ground	

JATXPWR1: ATX Power Source Connector

This connector allows user to connect 24-pin power connector on the ATX power supply.

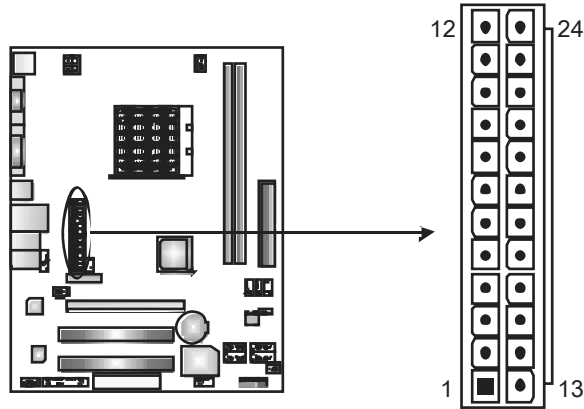

Pin	Assignment	Pin	Assignment
13	+3.3V	1	+3.3V
14	-12V	2	+3.3V
15	Ground	3	Ground
16	PS_ON	4	+5V
17	Ground	5	Ground
18	Ground	6	+5V
19	Ground	7	Ground
20	NC	8	PW_OK
21	+5V	9	StandbyVoltage+5V
22	+5V	10	+12V
23	+5V	11	+12V
24	Ground	12	+3.3V

JATXPWR2: ATX Power Source Connector

By connecting this connector, it will provide +12V to CPU power circuit.

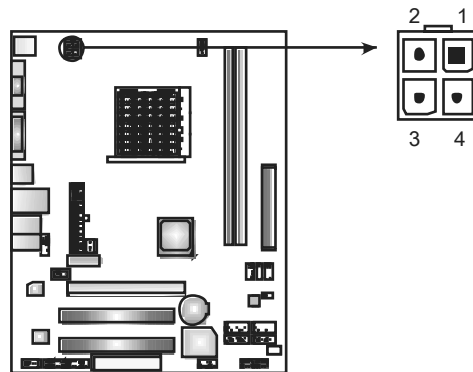

Pin	Assignment
1	+12V
2	+12V
3	Ground
4	Ground

JUSB2/JUSB3/JUSB4: Headers for USB 2.0 Ports at Front Panel

This header allows user to connect additional USB cable on the PC front panel, and also can be connected with internal USB devices, like USB card reader.

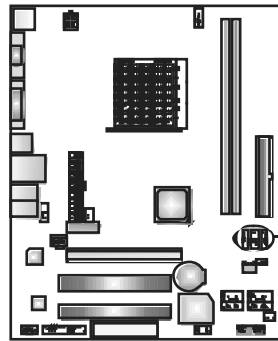

Pin	Assignment
1	+5V (fused)
2	+5V (fused)
3	USB-
4	USB-
5	USB+
6	USB+
7	Ground
8	Ground
9	Key
10	NC

SATA1~SATA4: Serial ATA Connectors

The motherboard has a PCI to SATA Controller with 4 channels SATA interface.

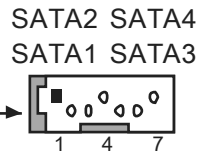
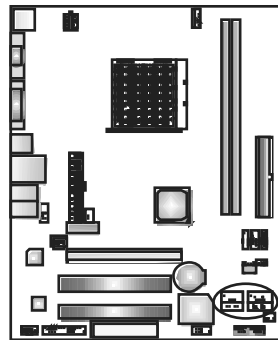

Pin	Assignment
1	Ground
2	TX+
3	TX-
4	Ground
5	RX-
6	RX+
7	Ground

JAUDIO F1: Front Panel Audio Header

This header allows user to connect the front audio output cable with the PC front panel. It will disable the output on back panel audio connectors.

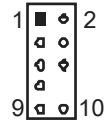
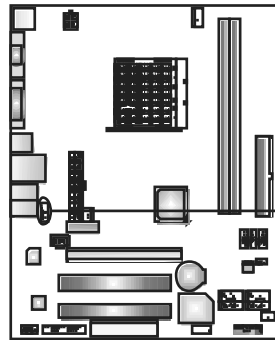

Pin	Assignment
1	Mic Left in
2	Ground
3	Mic Right in
4	GPIO
5	Right line in
6	Jack Sense
7	Front Sense
8	Key
9	Left line in
10	Jack Sense

JCDIN1: CD-ROM Audio-in Connector

This connector allows user to connect the audio source from the variety devices, like CD-ROM, DVD-ROM, PCI sound card, PCI TV turner card etc..

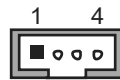
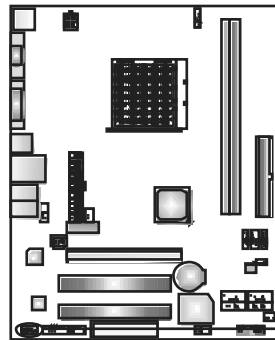

Pin	Assignment
1	Left Channel Input
2	Ground
3	Ground
4	Right Channel Input

JSPDIF_OUT1: Digital Audio-out Connector

This connector allows user to connect the PCI bracket SPDIF output header.

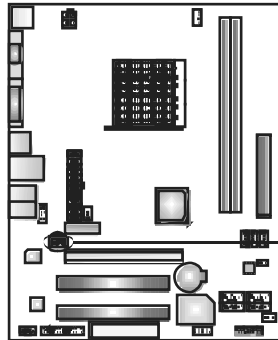

Pin	Assignment
1	+5V
2	SPDIF_OUT
3	Ground

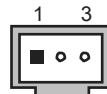

JCMOS1: Clear CMOS Header

By placing the jumper on pin2-3, it allows user to restore the BIOS safe setting and the CMOS data, please carefully follow the procedures to avoid damaging the motherboard.

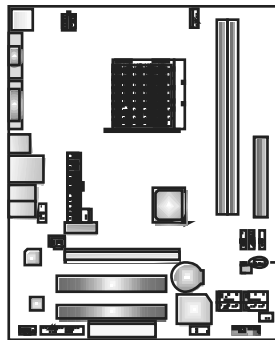

Pin 1-2 Close:
Normal Operation
(default).



Pin 2-3 Close:
Clear CMOS data.

※ Clear CMOS Procedures:

1. Remove AC power line.
2. Set the jumper to "Pin 2-3 close".
3. Wait for five seconds.
4. Set the jumper to "Pin 1-2 close".
5. Power on the AC.
6. Reset your desired password or clear the CMOS data.

JPRNT1: Printer Port Connector

This header allows you to connect printer on the PC.

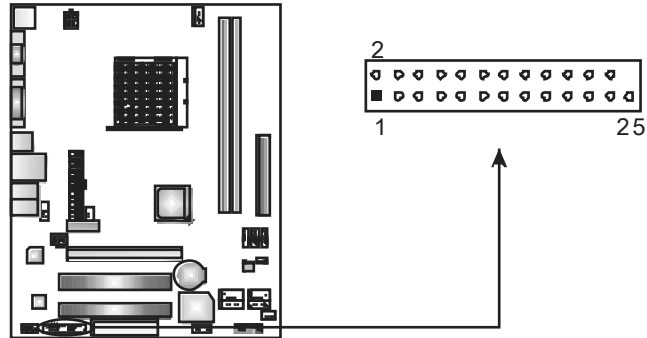

Pin	Assignment	Pin	Assignment
1	-Strobe	14	Ground
2	-ALF	15	Data 6
3	Data 0	16	Ground
4	-Error	17	Data 7
5	Data 1	18	Ground
6	-Init	19	-ACK
7	Data 2	20	Ground
8	-Scltin	21	Busy
9	Data 3	22	Ground
10	Ground	23	PE
11	Data 4	24	Ground
12	Ground	25	SCLT
13	Data 5	26	Key

JCOM1: Serial port Connector

The motherboard has a Serial Port Connector for connecting RS-232 Port.

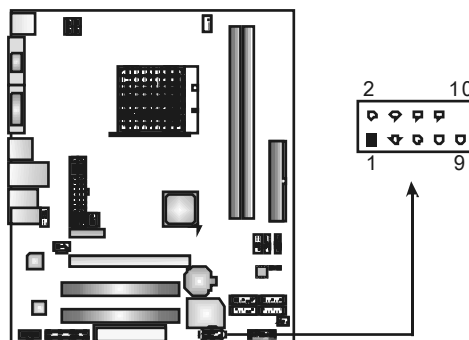

Pin	Assignment
1	Carrier detect
2	Received data
3	Transmitted data
4	Data terminal ready
5	Signal ground
6	Data set ready
7	Request to send
8	Clear to send
9	Ring indicator
10	Key

CHAPTER 4: RAID FUNCTIONS

4.1 OPERATION SYSTEM

- Supports Windows XP Home/Professional Edition, and Windows 2000 Professional.

4.2 RAID ARRAYS

RAID supports the following types of RAID arrays:

RAID 0: RAID 0 defines a disk striping scheme that improves disk read and write times for many applications.

RAID 1: RAID 1 defines techniques for mirroring data.

RAID 0+1: RAID 0+1 combines the techniques used in RAID 0 and RAID 1.

RAID 5: RAID 5 provides fault tolerance and better utilization of disk capacity.

4.3 HOW RAID WORKS

RAID 0:

The controller “stripes” data across multiple drives in a RAID 0 array system. It breaks up a large file into smaller blocks and performs disk reads and writes across multiple drives in parallel. The size of each block is determined by the stripe size parameter, which you set during the creation of the RAID set based on the system environment. This technique reduces overall disk access time and offers high bandwidth.

Features and Benefits

- **Drives:** Minimum 1, and maximum is up to 6 or 8. Depending on the platform.
- **Uses:** Intended for non-critical data requiring high data throughput, or any environment that does not require fault tolerance.
- **Benefits:** provides increased data throughput, especially for large files. No capacity loss penalty for parity.
- **Drawbacks:** Does not deliver any fault tolerance. If any drive in the array fails, all data is lost.
- **Fault Tolerance:** No.

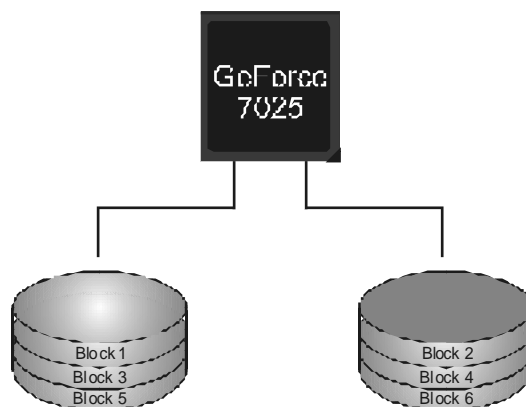

RAID 1:

Every read and write is actually carried out in parallel across 2 disk drives in a RAID 1 array system. The mirrored (backup) copy of the data can reside on the same disk or on a second redundant drive in the array. RAID 1 provides a hot-standby copy of data if the active volume or drive is corrupted or becomes unavailable because of a hardware failure.

RAID techniques can be applied for high-availability solutions, or as a form of automatic backup that eliminates tedious manual backups to more expensive and less reliable media.

Features and Benefits

- **Drives:** Minimum 2, and maximum is 2.
- **Uses:** RAID 1 is ideal for small databases or any other application that requires fault tolerance and minimal capacity.
- **Benefits:** Provides 100% data redundancy. Should one drive fail, the controller switches to the other drive.
- **Drawbacks:** Requires 2 drives for the storage space of one drive. Performance is impaired during drive rebuilds.
- **Fault Tolerance:** Yes.

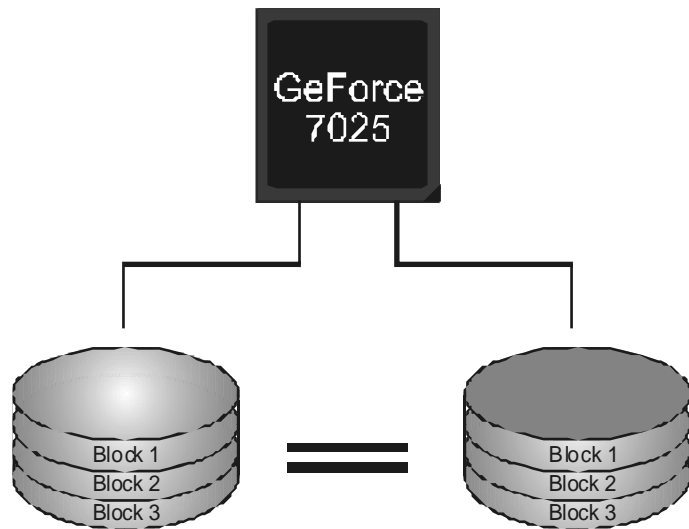

RAID 0+1:

RAID 0 drives can be mirrored using RAID 1 techniques. Resulting in a RAID 0+1 solution for improved performance plus resiliency.

Features and Benefits

- **Drives:** Minimum 4, and maximum is 6 or 8, depending on the platform.
- **Benefits:** Optimizes for both fault tolerance and performance, allowing for automatic redundancy. May be simultaneously used with other RAID levels in an array, and allows for spare disks.
- **Drawbacks:** Requires twice the available disk space for data redundancy, the same as RAID level 1.
- **Fault Tolerance:** Yes.

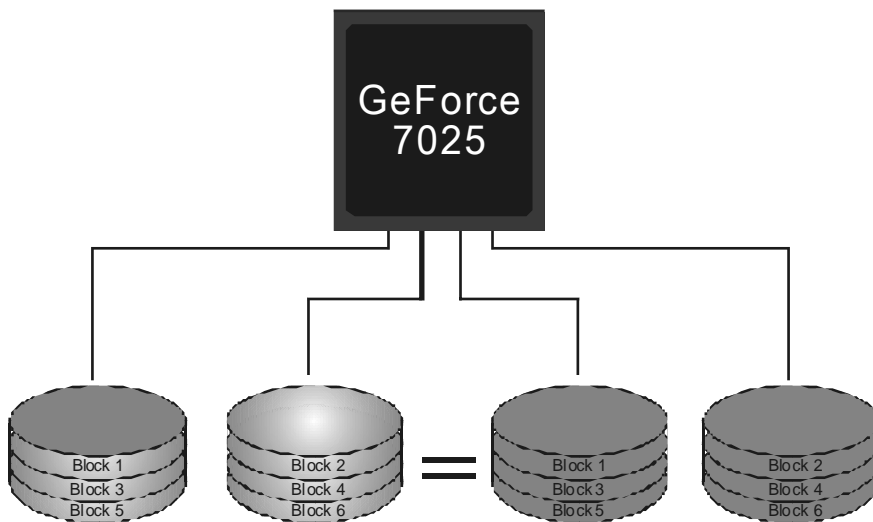

RAID 5:

RAID 5 stripes both data and parity information across three or more drives. It writes data and parity blocks across all the drives in the array. Fault tolerance is maintained by ensuring that the parity information for any given block of data is placed on a different drive from those used to store the data itself.

Features and Benefits

- **Drives:** Minimum 3.
- **Uses:** RAID 5 is recommended for transaction processing and general purpose service.
- **Benefits:** An ideal combination of good performance, good fault tolerance, and high capacity and storage efficiency.
- **Drawbacks:** Individual block data transfer rate same as a single disk. Write performance can be CPU intensive.
- **Fault Tolerance:** Yes.

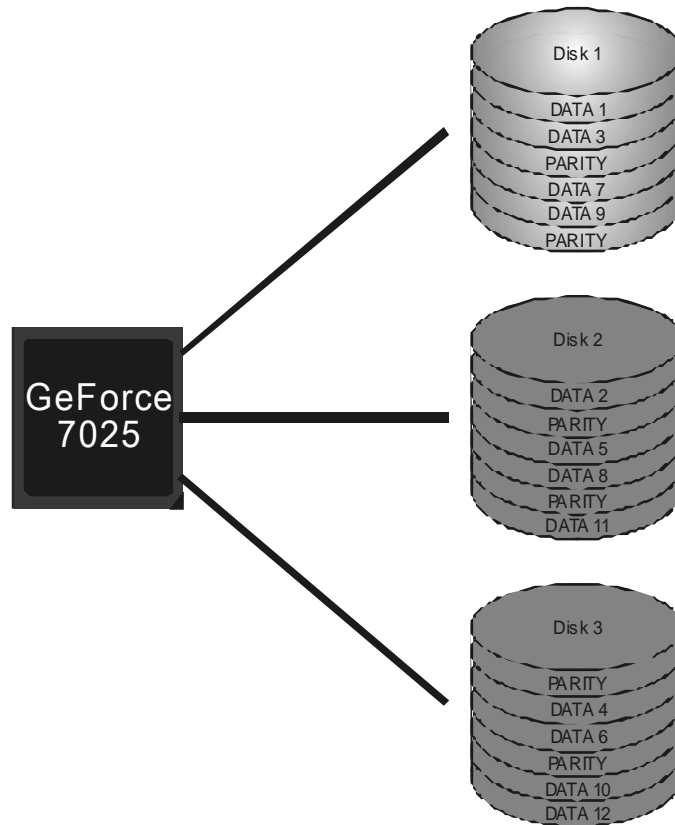

※ For more detailed setup information, please refer to the Driver CD, or go to http://www.nvidia.com/page/pg_20011106217193.html to download NVIDIA nForce Tutorial Flash.

CHAPTER 5: USEFUL HELP

5.1 DRIVER INSTALLATION NOTE

After you installed your operating system, please insert the Fully Setup Driver CD into your optical drive and install the driver for better system performance.

You will see the following window after you insert the CD



The setup guide will auto detect your motherboard and operating system.

Note:

If this window didn't show up after you insert the Driver CD, please use file browser to locate and execute the file **SETUPEXE** under your optical drive.

A. Driver Installation

To install the driver, please click on the Driver icon. The setup guide will list the compatible driver for your motherboard and operating system. Click on each device driver to launch the installation program.

B. Software Installation

To install the software, please click on the Software icon. The setup guide will list the software available for your system, click on each software title to launch the installation program.

C. Manual

Aside from the paperback manual, we also provide manual in the Driver CD. Click on the Manual icon to browse for available manual.

Note:

You will need Acrobat Reader to open the manual file. Please download the latest version of Acrobat Reader software from

<http://www.adobe.com/products/acrobat/readstep2.html>

5.2 AWARD BIOS BEEP CODE

Beep Sound	Meaning
One long beep followed by two short beeps	Video card not found or video card memory bad
High-low siren sound	CPU overheated System will shut down automatically
One Short beep when system boot-up	No error found during POST
Long beeps every other second	No DRAM detected or install

5.3 EXTRA INFORMATION

CPU Overheated

If the system shutdown automatically after power on system for seconds, that means the CPU protection function has been activated.

When the CPU is over heated, the motherboard will shutdown automatically to avoid a damage of the CPU, and the system may not power on again.

In this case, please double check:

1. The CPU cooler surface is placed evenly with the CPU surface.
2. CPU fan is rotated normally.
3. CPU fan speed is fulfilling with the CPU speed.

After confirmed, please follow steps below to relief the CPU protection function.

1. Remove the power cord from power supply for seconds.
2. Wait for seconds.
3. Plug in the power cord and boot up the system.

Or you can:

1. Clear the CMOS data.
(See "Close CMOS Header: JCMOS1" section)
2. Wait for seconds.
3. Power on the system again.

5.4 TROUBLESHOOTING

Probable	Solution
1. No power to the system at all Power light don't illuminate, fan inside power supply does not turn on. 2. Indicator light on key board does not turn on.	1. Make sure power cable is securely plugged in. 2. Replace cable. 3. Contact technical support.
System inoperative. Keyboard lights are on, power indicator lights are lit, and hard drive is spinning.	Using even pressure on both ends of the DIMM, press down firmly until the module snaps into place.
System does not boot from hard disk drive, can be booted from optical drive.	1. Check cable running from disk to disk controller board. Make sure both ends are securely plugged in; check the drive type in the standard CMOS setup. 2. Backing up the hard drive is extremely important. All hard disks are capable of breaking down at any time.
System only boots from optical drive. Hard disk can be read and applications can be used but booting from hard disk is impossible.	1. Back up data and applications files. 2. Reformat the hard drive. Re-install applications and data using backup disks.
Screen message says "Invalid Configuration" or "CMOS Failure."	Review system's equipment. Make sure correct information is in setup.
Cannot boot system after installing second hard drive.	1. Set master/slave jumpers correctly. 2. Run SETUP program and select correct drive types. Call the drive manufacturers for compatibility with other drives.

CHAPTER 6: WARPSPEEDER™ III



6.1 INTRODUCTION

[WarpSpeeder™ III], a new powerful control utility, features three user-friendly functions including Overclock Manager, Overvoltage Manager, and Hardware Monitor.

With the Overclock Manager, users can easily adjust the frequency they prefer or they can get the best CPU performance with just one click. The Overvoltage Manager, on the other hand, helps to power up CPU core voltage and Memory voltage. The cool Hardware Monitor smartly indicates the temperatures, voltage and CPU fan speed as well as the chipset information. Also, in the About panel, you can get detail descriptions about BIOS model and chipsets. In addition, the frequency status of CPU, memory, VGA and PCI along with the CPU speed are synchronically shown on our main panel.

Moreover, to protect users' computer systems if the setting is not appropriate when testing and results in system fail or hang, [WarpSpeeder™ III] technology assures the system stability by automatically rebooting the computer and then restart to a speed that is either the original system speed or a suitable one.

6.2 SYSTEM REQUIREMENT

OS Support: Windows 98 SE, Windows Me, Windows 2000, Windows XP, Windows Vista

DirectX: DirectX 8.1 or above. (The Windows XP operating system includes DirectX 8.1. If you use Windows XP, you do not need to install DirectX 8.1.)

6.3 INSTALLATION

1. Execute the setup execution file, and then the following dialog will pop up. Please click “Next” button and follow the default procedure to install.

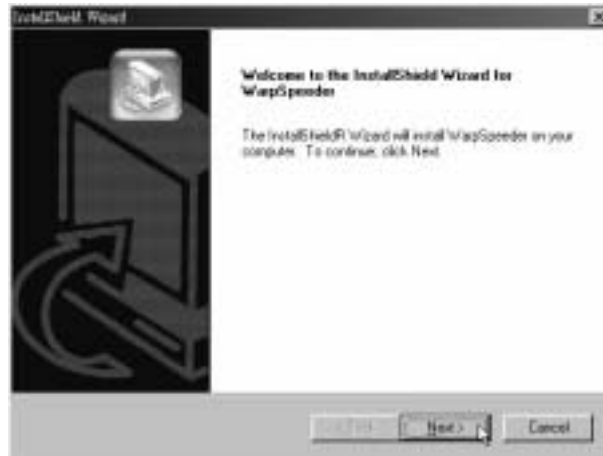

2. When you see the following dialog in setup procedure, it means setup is completed. Click “Finish” button.



Usage:

The following figures are only for reference, the screen printed in this user manual will change according to your motherboard on hand.

6.4 WARPSPEDER™ III

1. Desktop Icon:

After the [WarpSpeeder™ III] has been installed, a [WarpSpeeder™ III] icon will appear on the desktop, just like the icon shown below.



Now you can launch the [WarpSpeeder™ III] utility simply by double-clicking the desktop icon.

2. Main Panel

If you double-click the desktop icon, [WarpSpeeder™ III] will be launched. Please refer to the following figure; the utility's first window you will see is Main Panel.

Main Panel contains features as follows:

- a. Display the CPU Speed, CPU external clock, Memory dock, VGA clock, and PCI dock information.
- b. Contains About, Voltage/Overdock, and Hardware Monitor Buttons for invoking respective panels. The On/Off button is for closing the program.

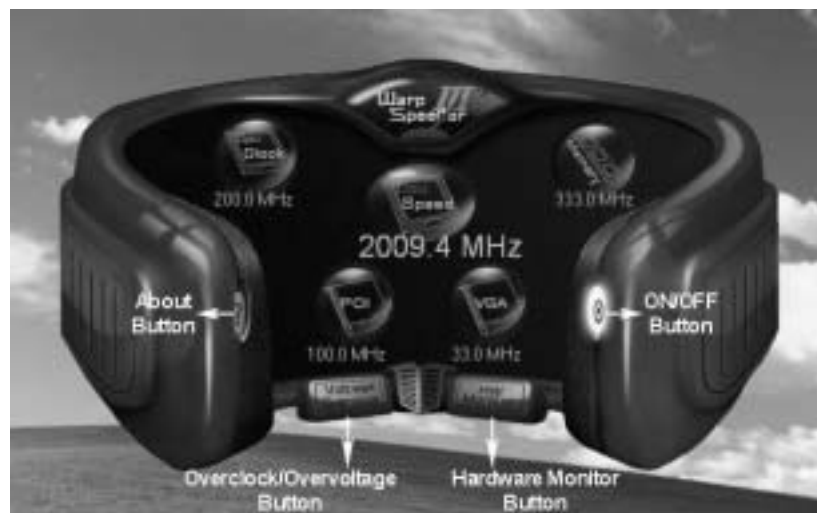

3. **Overclock/Overvoltage Panel**

Click the Overdock/Overvoltage button in the Main Panel, the button will be highlighted and the Overclock/Overvoltage Panel will show up as the following figure. As you can see, the Overclock Panel is on the right side, and the Overvoltage Panel is on the left side.



Overclock Panel contains these features:

- a. “Auto-Overdock”:
User can click this button and [WarpSpeeder™ III] will set the best and stable performance and frequency automatically. A warning dialog as below will show up to notify you that the system may become unstable, click on “OK” to proceed.



Then [WarpSpeeder™ III] utility will execute a series of testing until system fail. Then system will do fail-safe reboot by using Watchdog function. After reboot, launch the [WarpSpeeder™ III] utility again and the utility will load the previously verified best and stable frequency.

- b. “Verify”:
If you use the “Manual Adjust” bar to adjust the CPU frequency, then you can click this button and [WarpSpeeder™ III] will proceed a testing for current frequency. If the testing is ok, then the current frequency will be saved into system registry. If the testing fails, system will do a fail-safe rebooting. After reboot, the [WarpSpeeder™ III] utility will restore to the hardware default setting.

Warning:

Manually overclock is potentially dangerous, especially when the overlocking percentage is over 110 %. We strongly recommend you verify every speed you overclock by click the Verify button. Or, you can just click Auto overclock button and let [WarpSpeeder™ III] automatically gets the best result for you.

- c. “V3 Engine”/“V6 Engine”/“V9 Engine”:
Provide user the ability to do real-time overdock adjustment.
- d. “Recovery”:
Click this button and the [WarpSpeeder™ III] utility will restore all values to the hardware default setting.

Overvoltage Panel contains these features:

- a. "CPU Voltage":
This function allows user to adjust CPU voltage. Click on "+" to increase or "-" to decrease the CPU voltage.
- b. "Memory Voltage":
This function allows user to adjust Memory voltage. Click on "+" to increase or "-" to decrease the Memory voltage.

4. Hardware Monitor Panel

Click the Hardware Monitor button in Main Panel, the button will be highlighted and the Hardware Monitor panel will show up as the following figure.

In this panel, you can get the real-time status information of your system. The information will be refreshed every 1 second.



5. About Panel

Click the “about” button in Main Panel, the button will be highlighted and the About Panel will show up as the following figure.

In this panel, you can get model name and detail information in hints of all the chipset that are related to overclocking. You can also get the the version number of [WarpSpeeder™ III] utility.



Note:

Because the overclock, overvoltage, and hardware monitor features are controlled by several separate chipset, [WarpSpeeder™ III] divide these features to separate panels. If one chipset is not on board, the correlative button in Main panel will be disabled, but will not interfere other panels' functions. This property can make [WarpSpeeder™ III] utility more robust.

This page is intentionally left blank.

APPENDENCIES: SPEC IN OTHER LANGUAGE**GERMAN**

	<i>Ver 5.x</i>	<i>Ver 6.x</i>
CPU	Sockel AM2 AMD Athlon 64 / Athlon 64 FX / Athlon 64 x2 / Sempron Prozessoren Die AMD 64-Architektur unterstützt eine 32-Bit- und 64-Bit-Datenverarbeitung Unterstützt Hyper Transport und Cool'n'Quiet	Sockel AM2 AMD Athlon 64 / Athlon 64 FX / Athlon 64 x2 / Sempron Prozessoren Die AMD 64-Architektur unterstützt eine 32-Bit- und 64-Bit-Datenverarbeitung Unterstützt Hyper Transport und Cool'n'Quiet
FSB	Unterstützt Hyper Transport mit einer Bandbreite von bis zu 1 GHz	Unterstützt Hyper Transport mit einer Bandbreite von bis zu 1 GHz
Chipsatz	GeForce 7025/NF 630a	GeForce 7025/NF 630a
Super E/A	ITE 8716F Bietet die häufig verwendeten alten Super E/A-Funktionen Low Pin Court-Schnittstelle Umgebungskontrolle, Hardware-Überwachung Lüfterdrehzahl-Controller "Smart Guardian"-Funktion von ITE	ITE 8716F Bietet die häufig verwendeten alten Super E/A-Funktionen Low Pin Court-Schnittstelle Umgebungskontrolle, Hardware-Überwachung Lüfterdrehzahl-Controller "Smart Guardian"-Funktion von ITE
Arbeitsspeicher	DDR2 DIMM-Steckplätze x 2 Max. 4GB Arbeitsspeicher Jeder DIMM unterstützt 256MB/512MB/1GB/ 2GB DDR2 Dual-Kanal DDR2 Speichermodul Unterstützt DDR2 533 / 667 / 800 registrierte DIMMs. ECC DIMMs werden nicht unterstützt.	DDR2 DIMM-Steckplätze x 2 Max. 4GB Arbeitsspeicher Jeder DIMM unterstützt 256MB/512MB/1GB/ 2GB DDR2 Dual-Kanal DDR2 Speichermodul Unterstützt DDR2 533 / 667 / 800 registrierte DIMMs. ECC DIMMs werden nicht unterstützt.
Grafik	Integrierter GeForce 7025/NF630a-Chipsatz Max. 512MB gemeinsam benutzter Videospeicher	Integrierter GeForce 7025/NF630a-Chipsatz Max. 512MB gemeinsam benutzter Videospeicher
IDE	Integrierter IDE-Controller Ultra DMA 33 / 66 / 100 / 133 Bus Master-Modus Unterstützt PIO-Modus 0~4,	Integrierter IDE-Controller Ultra DMA 33 / 66 / 100 / 133 Bus Master-Modus Unterstützt PIO-Modus 0~4,
SATA II	Integrierter Serial ATA-Controller Datentransfer rate bis zu 3Gb/s Konform mit der SATA-Spezifikation Version 2.0	Integrierter Serial ATA-Controller Datentransfer rate bis zu 3Gb/s Konform mit der SATA-Spezifikation Version 2.0
LAN	Realtek RTL 8201N / 8211B (optional) 10 / 100 / 1000 Mb/s Auto-Negotiation (Gigabit-Bandbreite nur beim RTL 8211B) Halb-/Voll-duplex-Funktion	Realtek RTL 8201N / 8211B (optional) 10 / 100 / 1000 Mb/s Auto-Negotiation (Gigabit-Bandbreite nur beim RTL 8211B) Halb-/Voll-duplex-Funktion

	Ver 5.x	Ver 6.x
Audio-Codec	ALC888 7.1-Kanal-Audioausgabe Unterstützt High-DefinitionAudio	ALC662 5.1-Kanal-Audioausgabe Unterstützt High-DefinitionAudio
Steckplätze	PCI-Steckplatz x2 PCI Express x16 Steckplatz x1 PCI Express x 1-Steckplatz x1	PCI-Steckplatz x2 PCI Express x16 Steckplatz x1 PCI Express x 1-Steckplatz x1
Onboard-Anschluss	Diskettenlaufwerkanschluss x1 Druckeranschluss Anschluss x1 IDE-Anschluss x1 SATA-Anschluss x4 Fronttafelanschluss x1 Front-Audioanschluss x1 CD-IN-Anschluss x1 S/PDIF- Ausgangsanschluss x1 CPU-Lüfter-Sockel x1 System-Lüfter-Sockel x1 "CMOS löschen"-Sockel x1 USB-Anschluss x3 Serieller Anschluss x1 Stromanschluss (24-pdig) x1 Stromanschluss (4-polig) x1	Diskettenlaufwerkanschluss x1 Druckeranschluss Anschluss x1 IDE-Anschluss x1 SATA-Anschluss x4 Fronttafelanschluss x1 Front-Audioanschluss x1 CD-IN-Anschluss x1 S/PDIF- Ausgangsanschluss x1 CPU-Lüfter-Sockel x1 System-Lüfter-Sockel x1 "CMOS löschen"-Sockel x1 USB-Anschluss x3 Serieller Anschluss x1 Stromanschluss (24-pdig) x1 Stromanschluss (4-polig) x1
Rückseiten-E/A	PS/2-Tastatur x1 PS/2-Maus x1 VGA-Anschluss x1 DVI-D-Anschluss x1 LAN-Anschluss x1 USB-Anschluss x4 Audioanschluss x6	PS/2-Tastatur x1 PS/2-Maus x1 VGA-Anschluss x1 DVI-D-Anschluss x1 LAN-Anschluss x1 USB-Anschluss x4 Audioanschluss x3
Platinengröße	208 mm (B) X 244 mm (L)	208 mm (B) X 244 mm (L)
Sonderfunktionen	Unterstützt RAID 0 / 1 / 5 / 0+1	Unterstützt RAID 0 / 1 / 5 / 0+1
OS-Unterstützung	Windows 2000 / XP / VISTA Biostar behält sich das Recht vor, ohne Ankündigung die Unterstützung für ein Betriebssystem hinzuzufügen oder zu entfernen.	Windows 2000 / XP / VISTA Biostar behält sich das Recht vor, ohne Ankündigung die Unterstützung für ein Betriebssystem hinzuzufügen oder zu entfernen.

FRANCE

	Ver 5.x	Ver 6.x
UC	Socket AM2 Processeurs AMD Athlon 64 / Athlon 64 FX / Athlon 64 x2 / Sempron L'architecture AMD 64 permet le calcul 32 et 64 bits Prend en charge Hyper Transport et Cod'nQuiet	Socket AM2 Processeurs AMD Athlon 64 / Athlon 64 FX / Athlon 64 x2 / Sempron L'architecture AMD 64 permet le calcul 32 et 64 bits Prend en charge Hyper Transport et Cod'nQuiet
Bus frontal	Prend en charge Hyper Transport jusqu'à une bande passante de 1 GHz	Prend en charge Hyper Transport jusqu'à une bande passante de 1 GHz
Chipset	GeForce 7025/NF 630a	GeForce 7025/NF 630a
Super E/S	ITE 8716F Fournit la fonctionnalité de Super E/S patrimoniales la plus utilisée. Interface à faible compte de broches Initiatives de contrôle environnementales, Moniteur de matériel Contrôleur de vitesse de ventilateur Fonction "Garden intelligent" de l'ITE	ITE 8716F Fournit la fonctionnalité de Super E/S patrimoniales la plus utilisée. Interface à faible compte de broches Initiatives de contrôle environnementales, Moniteur de matériel Contrôleur de vitesse de ventilateur Fonction "Garden intelligent" de l'ITE
Mémoire principale	Fentes DDR2 DIMM x 2 Capacité mémoire maximale de 4 Go Chaque DIMM prend en charge des DDR2 de 256 Mo/512 Mo et 1Go/2Go Module de mémoire DDR2 à mode à double voie Prend en charge la DDR2 533 / 667 / 800 Les DIMM à registres et DIMM avec code correcteurs d'erreurs ne sont pas prises en charge	Fentes DDR2 DIMM x 2 Capacité mémoire maximale de 4 Go Chaque DIMM prend en charge des DDR2 de 256 Mo/512 Mo et 1Go/2Go Module de mémoire DDR2 à mode à double voie Prend en charge la DDR2 533 / 667 / 800 Les DIMM à registres et DIMM avec code correcteurs d'erreurs ne sont pas prises en charge
Graphiques	Intégré dans le chipset GeForce 7025/NF630a Mémoire vidéo partagée maximale de 512 Mo	Intégré dans le chipset GeForce 7025/NF630a Mémoire vidéo partagée maximale de 512 Mo
IDE	Contrôleur IDE intégré Mode principale de Bus Ultra DMA 33 / 66 / 100 / 133 Prend en charge le mode PIO 0~4,	Contrôleur IDE intégré Mode principale de Bus Ultra DMA 33 / 66 / 100 / 133 Prend en charge le mode PIO 0~4,
SATA II	Contrôleur Serial ATA intégré : Taux de transfert jusqu'à 3 Go/s. Conforme à la spécification SATA Version 2.0	Contrôleur Serial ATA intégré : Taux de transfert jusqu'à 3 Go/s. Conforme à la spécification SATA Version 2.0
LAN	Realtek RTL 8201N / 8211B (optional) 10 / 100 / 1000 Mb/s négociation automatique (La bande passante Gigabit est pour le RTL 8211B uniquement) Half / Full duplex capability	Realtek RTL 8201N / 8211B (optional) 10 / 100 / 1000 Mb/s négociation automatique (La bande passante Gigabit est pour le RTL 8211B uniquement) Half / Full duplex capability

	Ver 5.x	Ver 6.x
Codec audio	ALC888 Sortie audio à 7.1 voies Prise en charge de l'audio haute definition	ALC662 Sortie audio à 5.1 voies Prise en charge de l'audio haute definition
Fentes	Fente PCI x2 Slot PCI Express x16 x1 Slot PCI Express x 1 x1	Fente PCI x2 Slot PCI Express x16 x1 Slot PCI Express x 1 x1
Connecteur embarqué	Connecteur de disquette x1 Connecteur de Port d'imprimante x1 Connecteur IDE x1 Connecteur SATA x4 Connecteur du panneau avant x1 Connecteur Audio du panneau avant x1 Connecteur d'entrée CD x1 Connecteur de sortie S/PDIF x1 Embase de ventilateur UC x1 Embase de ventilateur système x1 Embase d'effacement CMOS x1 Connecteur USB x3 Connecteur de Port série x1 Connecteur d'alimentation (24 broches) x1 Connecteur d'alimentation (4 broches) x1	Connecteur de disquette x1 Connecteur de Port d'imprimante x1 Connecteur IDE x1 Connecteur SATA x4 Connecteur du panneau avant x1 Connecteur Audio du panneau avant x1 Connecteur d'entrée CD x1 Connecteur de sortie S/PDIF x1 Embase de ventilateur UC x1 Embase de ventilateur système x1 Embase d'effacement CMOS x1 Connecteur USB x3 Connecteur de Port série x1 Connecteur d'alimentation (24 broches) x1 Connecteur d'alimentation (4 broches) x1
E/S du panneau arrière	Clavier PS/2 x1 Souris PS/2 x1 Port VGA x1 Port DVI-D x1 Port LAN x1 Port USB x4 Fiche audio x6	Clavier PS/2 x1 Souris PS/2 x1 Port VGA x1 Port DVI-D x1 Port LAN x1 Port USB x4 Fiche audio x3
Dimensions de la carte	208 mm (l) X 244 mm (H)	208 mm (l) X 244 mm (H)
Fonctionnalités spéciales	Prise en charge RAID 0 / 1 / 5 / 0+1	Prise en charge RAID 0 / 1 / 5 / 0+1
Support SE	Windows 2000 / XP / VISTA Biostar se réserve le droit d'ajouter ou de supprimer le support de SE avec ou sans préavis.	Windows 2000 / XP / VISTA Biostar se réserve le droit d'ajouter ou de supprimer le support de SE avec ou sans préavis.

ITALIAN

	<i>Ver 5.x</i>	<i>Ver 6.x</i>
CPU	Socket AM2 Processori AMD Athlon 64 / Athlon 64 FX / Athlon 64 x2 / Sempron L'architettura AMD 64 abilita la computazione 32 e 64 bit Supporto di Hyper Transport e Cool'n'Quiet	Socket AM2 Processori AMD Athlon 64 / Athlon 64 FX / Athlon 64 x2/ Sempron L'architettura AMD 64 abilita la computazione 32 e 64 bit Supporto di Hyper Transport e Cool'n'Quiet
FSB	Supporto di HyperTransport fino a 1 GHz di larghezza di banda	Supporto di HyperTransport fino a 1 GHz di larghezza di banda
Chipset	GeForce 7025/NF 630a	GeForce 7025/NF 630a
Super I/O	ITE 8716F Fornisce le funzionalità legacy Super I/O usate più comunemente. Interfaccia LPC (Low Pin Count) Funzioni di controllo dell'ambiente: Monitoraggio hardware Controller velocità ventolina Funzione "Smart Guardian" di ITE	ITE 8716F Fornisce le funzionalità legacy Super I/O usate più comunemente. Interfaccia LPC (Low Pin Count) Funzioni di controllo dell'ambiente: Monitoraggio hardware Controller velocità ventolina Funzione "Smart Guardian" di ITE
Memoria principale	Alloggi DIMM DDR 2 x 2 Capacità massima della memoria a 4GB Ciascun DIMM supporta DDR2 256MB/ 512MB e 1GB/2GB Modulo di memoria DDR2 a canale doppio Supporto di DDR2 533 / 667 / 800 DIMM registrati e DIMM ECC non sono supportati	Alloggi DIMM DDR 2 x 2 Capacità massima della memoria a 4GB Ciascun DIMM supporta DDR2 256MB/ 512MB e 1GB/2GB Modulo di memoria DDR2 a canale doppio Supporto di DDR2 533 / 667 / 800 DIMM registrati e DIMM ECC non sono supportati
Grafica	Integrata nel Chipset GeForce 7025/NF 630a La memoria video condivisa massima è di 512MB	Integrata nel Chipset GeForce 7025/NF 630a La memoria video condivisa massima è di 512MB
IDE	Controller IDE integrato Modalità Bus Master Ultra DMA 33 / 66 / 100 / 133 Supporto modalità PIO Mode 0-4	Controller IDE integrato Modalità Bus Master Ultra DMA 33 / 66 / 100 / 133 Supporto modalità PIO Mode 0-4
SATA II	Controller Serial ATA integrato Velocità di trasferimento dei dati fino a 3 Gb/s. Compatibile specifiche SATA Versione 2.0.	Controller Serial ATA integrato Velocità di trasferimento dei dati fino a 3 Gb/s. Compatibile specifiche SATA Versione 2.0.
LAN	Realtek RTL 8201N / 8211B (optional) Negoziazione automatica 10 / 100 / 1000 Mb/s (la larghezza di banda Gigabit è solo per RTL 8211B) Capacità Half / Full Duplex	Realtek RTL 8201N / 8211B (optional) Negoziazione automatica 10 / 100 / 1000 Mb/s (la larghezza di banda Gigabit è solo per RTL 8211B) Capacità Half / Full Duplex

	<i>Ver 5.x</i>		<i>Ver 6.x</i>	
Codec audio	ALC888 Uscita audio 7.1 canali Supporto audio High-Definition (HD)		ALC662 Uscita audio 5.1 canali Supporto audio High-Definition (HD)	
Alloggi	Alloggio PCI	x2	Alloggio PCI	x2
	Alloggio PCI Express x16	x1	Alloggio PCI Express x16	x1
	Alloggio PCI Express x1	x1	Alloggio PCI Express x1	x1
Connettori su scheda	Connettore floppy	x1	Connettore floppy	x1
	Connettore Porta stampante	x1	Connettore Porta stampante	x1
	Connettore IDE	x1	Connettore IDE	x1
	Connettore SATA	x4	Connettore SATA	x4
	Connettore pannello frontale	x1	Connettore pannello frontale	x1
	Connettore audio frontale	x1	Connettore audio frontale	x1
	Connettore CD-in	x1	Connettore CD-in	x1
	Connettore output SPDIF	x1	Connettore output SPDIF	x1
	Collettore ventolina CPU	x1	Collettore ventolina CPU	x1
	Collettore ventolina sistema	x1	Collettore ventolina sistema	x1
	Collettore cancellazione CMOS	x1	Collettore cancellazione CMOS	x1
	Connettore USB	x3	Connettore USB	x3
	Connettore Porta seriale	x1	Connettore Porta seriale	x1
	Connettore alimentazione (24 pin)	x1	Connettore alimentazione (24 pin)	x1
	Connettore alimentazione (4 pin)	x1	Connettore alimentazione (4 pin)	x1
I/O pannello posteriore	Tastiera PS/2	x1	Tastiera PS/2	x1
	Mouse PS/2	x1	Mouse PS/2	x1
	Porta VGA	x1	Porta VGA	x1
	Porta DVI-D	x1	Porta DVI-D	x1
	Porta LAN	x1	Porta LAN	x1
	Porta USB	x4	Porta USB	x4
	Connettore audio	x6	Connettore audio	x3
Dimensioni scheda	208 mm (larghezza) x 244 mm (altezza)		208 mm (larghezza) x 244 mm (altezza)	
Caratteristiche speciali	Supporto RAID 0 / 1 / 5 / 0+1		Supporto RAID 0 / 1 / 5 / 0+1	
Sistemi operativi supportati	Windows 2000 / XP / VISTA Biostar si riserva il diritto di aggiungere o rimuovere il supporto di qualsiasi sistema operativo senza preavviso.		Windows 2000 / XP / VISTA Biostar si riserva il diritto di aggiungere o rimuovere il supporto di qualsiasi sistema operativo senza preavviso.	

SPANISH

	Ver 5.x	Ver 6.x
CPU	<p>Conector AM2</p> <p>Procesadores AMD Athlon 64 / Athlon 64 FX / Athlon 64 x2 / Sempron</p> <p>La arquitectura AMD 64 permite el procesamiento de 32 y 64 bits</p> <p>Soporta las tecnologías Hyper Transport y Cool'n'Quiet</p>	<p>Conector AM2</p> <p>Procesadores AMD Athlon 64 / Athlon 64 FX / Athlon 64 x2 / Sempron</p> <p>La arquitectura AMD 64 permite el procesamiento de 32 y 64 bits</p> <p>Soporta las tecnologías Hyper Transport y Cool'n'Quiet</p>
FSB	Admite HyperTransport con un ancho de banda de hasta 1 GHz	Admite HyperTransport con un ancho de banda de hasta 1 GHz
Conjunto de chips	GeForce 7025/NF 630a	GeForce 7025/NF 630a
Súper E/S	<p>ITE 8716F</p> <p>Le ofrece las funcionalidades heredadas de uso más común Súper E/S.</p> <p>Interfaz de cuenta Low Pin</p> <p>Iniciativas de control de entorno, Monitor hardware</p> <p>Controlador de velocidad de ventilador</p> <p>Función "Guarda inteligente" de ITE</p>	<p>ITE 8716F</p> <p>Le ofrece las funcionalidades heredadas de uso más común Súper E/S.</p> <p>Interfaz de cuenta Low Pin</p> <p>Iniciativas de control de entorno, Monitor hardware</p> <p>Controlador de velocidad de ventilador</p> <p>Función "Guarda inteligente" de ITE</p>
Memoria principal	<p>Ranuras DIMM DDR2 x 2</p> <p>Capacidad máxima de memoria de 4GB</p> <p>Cada DIMM admite DDR de 256MB/512MB y 1GB/2GB</p> <p>Módulo de memoria DDR2 de canal Doble</p> <p>Admite DDR2 de 533 / 667 / 800</p> <p>No admite DIMM registrados o DIMM compatibles con ECC</p>	<p>Ranuras DIMM DDR2 x 2</p> <p>Capacidad máxima de memoria de 4GB</p> <p>Cada DIMM admite DDR de 256MB/512MB y 1GB/2GB</p> <p>Módulo de memoria DDR2 de canal Doble</p> <p>Admite DDR2 de 533 / 667 / 800</p> <p>No admite DIMM registrados o DIMM compatibles con ECC</p>
Gráficos	<p>Integrados en el conjunto de chips GeForce 7025/NF630a</p> <p>Memoria máxima de vídeo compartida de 512MB</p>	<p>Integrados en el conjunto de chips GeForce 7025/NF630a</p> <p>Memoria máxima de vídeo compartida de 512MB</p>
IDE	<p>Controlador IDE integrado</p> <p>Modo bus maestro Ultra DMA 33/ 66 / 100 / 133</p> <p>Soporta los Modos PIO 0~4,</p>	<p>Controlador IDE integrado</p> <p>Modo bus maestro Ultra DMA 33/ 66 / 100 / 133</p> <p>Soporta los Modos PIO 0~4,</p>
SATA II	<p>Controlador ATA Serie Integrado</p> <p>Tasas de transferencia de hasta 3 Gb/s.</p> <p>Compatible con la versión SATA 2.0.</p>	<p>Controlador ATA Serie Integrado</p> <p>Tasas de transferencia de hasta 3 Gb/s.</p> <p>Compatible con la versión SATA 2.0.</p>
Red Local	<p>Realtek RTL 8201N / 8211B (opcional)</p> <p>Negociación de 10 / 100 / 1000 Mb/s (el ancho de banda Gigabit es únicamente para RTL 8211B)</p> <p>Funciones Half/ Full dúplex</p>	<p>Realtek RTL 8201N / 8211B (opcional)</p> <p>Negociación de 10 / 100 / 1000 Mb/s (el ancho de banda Gigabit es únicamente para RTL 8211B)</p> <p>Funciones Half/ Full dúplex</p>

	<i>Ver 5.x</i>		<i>Ver 6.x</i>	
Códex de sonido	ALC888		ALC662	
	Salida de sonido de 7.1 canales Soporte de sonido Alta Definición		Salida de sonido de 5.1 canales Soporte de sonido Alta Definición	
Ranuras	Ranura PCI	X2	Ranura PCI	X2
	Ranura PCI Express x16	X1	Ranura PCI Express x16	X1
	Ranura PCI express x 1	X1	Ranura PCI express x 1	X1
Conectores en placa	Conector disco flexible	X1	Conector disco flexible	X1
	Conector Puerto de impresora	X1	Conector Puerto de impresora	X1
	Conector IDE	X1	Conector IDE	X1
	Conector SATA	X4	Conector SATA	X4
	Conector de panel frontal	X1	Conector de panel frontal	X1
	Conector de sonido frontal	X1	Conector de sonido frontal	X1
	Conector de entrada de CD	X1	Conector de entrada de CD	X1
	Conector de salida S/PDIF	X1	Conector de salida S/PDIF	X1
	Cabecera de ventilador de CPU	X1	Cabecera de ventilador de CPU	X1
	Cabecera de ventilador de sistema	X1	Cabecera de ventilador de sistema	X1
	Cabecera de borrado de CMOS	X1	Cabecera de borrado de CMOS	X1
	Conector USB	X3	Conector USB	X3
	Conector Puerto serie	X1	Conector Puerto serie	X1
	Conector de alimentación (24 patillas)	X1	Conector de alimentación (24 patillas)	X1
	Conector de alimentación (4 patillas)	X1	Conector de alimentación (4 patillas)	X1
Panel trasero de E/S	Teclado PS/2	X1	Teclado PS/2	X1
	Ratón PS/2	X1	Ratón PS/2	X1
	Puerto VGA	X1	Puerto VGA	X1
	Puerto DVI-D	X1	Puerto DVI-D	X1
	Puerto de red local	X1	Puerto de red local	X1
	Puerto USB	X4	Puerto USB	X4
	Conector de sonido	X6	Conector de sonido	X3
Tamaño de la placa	208 mm. (A) X 244 Mm. (H)		208 mm. (A) X 244 Mm. (H)	
Funciones especiales	Admite RAID 0 / 1 / 5 / 0+1		Admite RAID 0 / 1 / 5 / 0+1	
Soporte de sistema operativo	Windows 2000 / XP / VISTA Bióstar se reserva el derecho de añadir o retirar el soporte de cualquier SO con o sin aviso previo.		Windows 2000 / XP / VISTA Bióstar se reserva el derecho de añadir o retirar el soporte de cualquier SO con o sin aviso previo.	

PORTUGUESE

	<i>Ver 5.x</i>	<i>Ver 6.x</i>
CPU	Socket AM2 Processadores AMD Athlon 64 / Athlon 64 FX / Athlon 64 x2 / Sempron A arquitectura AMD 64 permite uma computação de 32 e 64 bits Suporta as tecnologias Hyper Transport e Cool'nQuiet	Socket AM2 Processadores AMD Athlon 64 / Athlon 64 FX / Athlon 64 x2 / Sempron A arquitectura AMD 64 permite uma computação de 32 e 64 bits Suporta as tecnologias Hyper Transport e Cool'nQuiet
FSB	Suporta a tecnologia HyperTransport com uma largura de banda até 1 GHz	Suporta a tecnologia HyperTransport com uma largura de banda até 1 GHz
Chipset	GeForce 7025/NF 630a	GeForce 7025/NF 630a
Especificação Super I/O	ITE 8716F Proporciona as funcionalidades mais utilizadas em termos da especificação Super I/O. Interface LPC (Low Pin Count). Iniciativas para controlo do ambiente Monitorização do hardware Controlador da velocidade da ventoinha Função "Smart Guardian" da ITE	ITE 8716F Proporciona as funcionalidades mais utilizadas em termos da especificação Super I/O. Interface LPC (Low Pin Count). Iniciativas para controlo do ambiente Monitorização do hardware Controlador da velocidade da ventoinha Função "Smart Guardian" da ITE
Memória principal	Ranhuras DIMM DDR2 x 2 Capacidade máxima de memória: 4 GB Cada módulo DIMM suporta uma memória DDR2 de 256 MB/512 MB & 1 GB/2 GB Módulo de memória DDR2 de canal duplo Suporta módulos DDR2 533 / 667 / 800 Os módulos DIMM registados e os DIMM ECC não são suportados	Ranhuras DIMM DDR2 x 2 Capacidade máxima de memória: 4 GB Cada módulo DIMM suporta uma memória DDR2 de 256 MB/512 MB & 1 GB/2 GB Módulo de memória DDR2 de canal duplo Suporta módulos DDR2 533 / 667 / 800 Os módulos DIMM registados e os DIMM ECC não são suportados
Placa gráfica	Integrada no chipset GeForce 7025/NF630a Memória de vídeo máxima partilhada: 512 MB	Integrada no chipset GeForce 7025/NF630a Memória de vídeo máxima partilhada: 512 MB
IDE	Controlador IDE integrado Modo Bus master Ultra DMA 33 / 66 / 100 / 133 Suporta o modo PIO 0~4,	Controlador IDE integrado Modo Bus master Ultra DMA 33 / 66 / 100 / 133 Suporta o modo PIO 0~4,
SATA II	Controlador Serial ATA integrado Velocidades de transmissão de dados até 3 Gb/s. Compatibilidade com a especificação SATA versão 2.0.	Controlador Serial ATA integrado Velocidades de transmissão de dados até 3 Gb/s. Compatibilidade com a especificação SATA versão 2.0.
LAN	Realtek RTL 8201N / 8211B (opcional) Auto negociação de 10 / 100 / 1000 Mb/s (a largura de banda Ggabit refere-se apenas à especificação RTL 8211B) Capacidade semi/full-duplex	Realtek RTL 8201N / 8211B (opcional) Auto negociação de 10 / 100 / 1000 Mb/s (a largura de banda Ggabit refere-se apenas à especificação RTL 8211B) Capacidade semi/full-duplex

	<i>Ver 5.x</i>	<i>Ver 6.x</i>
Codec de som	ALC888 Saída de áudio de 7.1 canais Suporta a especificação High-Definition Audio	ALC662 Saída de áudio de 5.1 canais Suporta a especificação High-Definition Audio
Ranhuras	Ranhura PCI x2 Ranhura PCI Express x16 x1 Ranhura PCI Express x 1 x1	Ranhura PCI x2 Ranhura PCI Express x16 x1 Ranhura PCI Express x 1 x1
Conectores na placa	Conector da unidade de disquetes x1 Conector da para impressora x1 Conector IDE x1 Conector SATA x4 Conector do painel frontal x1 Conector de áudio frontal x1 Conector para entrada de CDs x1 Conector de saída S/PDIF x1 Conector da ventoinha da CPU x1 Conector da ventoinha do sistema x1 Conector para limpeza do CMOS x1 Conector USB x3 Conector da Porta série x1 Conector de alimentação (24 pinos) x1 Conector de alimentação (4 pinos) x1	Conector da unidade de disquetes x1 Conector da para impressora x1 Conector IDE x1 Conector SATA x4 Conector do painel frontal x1 Conector de áudio frontal x1 Conector para entrada de CDs x1 Conector de saída S/PDIF x1 Conector da ventoinha da CPU x1 Conector da ventoinha do sistema x1 Conector para limpeza do CMOS x1 Conector USB x3 Conector da Porta série x1 Conector de alimentação (24 pinos) x1 Conector de alimentação (4 pinos) x1
Entradas/Saídas no painel traseiro	Teclado PS/2 x1 Rato PS/2 x1 Porta VGA x1 Porta DVI-D x1 Porta LAN x1 Porta USB x4 Tomada de áudio x6	Teclado PS/2 x1 Rato PS/2 x1 Porta VGA x1 Porta DVI-D x1 Porta LAN x1 Porta USB x4 Tomada de áudio x3
Tamanho da placa	208 mm (L) X 244 mm (A)	208 mm (L) X 244 mm (A)
Características especiais	Suporta as funções RAID 0 / 1 / 5 / 0+1	Suporta as funções RAID 0 / 1 / 5 / 0+1
Sistemas operativos suportados	Windows 2000 / XP / VISTA A Biostar reserva-se o direito de adicionar ou remover suporte para qualquer sistema operativo com ou sem aviso prévio.	Windows 2000 / XP / VISTA A Biostar reserva-se o direito de adicionar ou remover suporte para qualquer sistema operativo com ou sem aviso prévio.

POLISH

	<i>Ver 5.x</i>	<i>Ver 6.x</i>
Procesor	Socket AM2 AMD Athlon 64 / Athlon 64 FX / Athlon 64 x2 / Sempron Procesory Architektura AMD 64 umożliwia przetwarzanie 32 i 64 bitowe Obsługa Hyper Transport oraz Cool'n'Quiet	Socket AM2 AMD Athlon 64 / Athlon 64 FX / Athlon 64 x2 / Sempron Procesory Architektura AMD 64 umożliwia przetwarzanie 32 i 64 bitowe Obsługa Hyper Transport oraz Cool'n'Quiet
FSB	Obsługa HyperTransport o szerokości pasma do 1 GHz	Obsługa HyperTransport o szerokości pasma do 1 GHz
Chipset	GeForce 7025/NF630a	GeForce 7025/NF630a
Pamięć główna	Gniazda DDR2 DIMM x 2 Maks. wielkość pamięci 4GB Każde gniazdo DIMM obsługuje moduły 256MB/512MB oraz 1GB/2GB DDR2 Moduł pamięci DDR2 z trybem podwójnego kanału Obsługa DDR2 533 / 667 / 800 Brak obsługi Registered DIMM oraz ECC DIMM	Gniazda DDR2 DIMM x 2 Maks. wielkość pamięci 4GB Każde gniazdo DIMM obsługuje moduły 256MB/512MB oraz 1GB/2GB DDR2 Moduł pamięci DDR2 z trybem podwójnego kanału Obsługa DDR2 533 / 667 / 800 Brak obsługi Registered DIMM oraz ECC DIMM
Super I/O	ITE 8716F Zapewnia najbardziej powszechne funkcje Super I/O. Interfejs Low Pin Count Funkcje kontroli warunków pracy, Monitor H/W Kontroler prędkości wentylatora Funkcja ITE "Smart Guardian"	ITE 8716F Zapewnia najbardziej powszechne funkcje Super I/O. Interfejs Low Pin Count Funkcje kontroli warunków pracy, Monitor H/W Kontroler prędkości wentylatora Funkcja ITE "Smart Guardian"
Grafika	Zintegrowana w chipsecie GeForce 7025/NF630a Maks. wielkość współdzielonej pamięci video wynosi 512MB	Zintegrowana w chipsecie GeForce 7025/NF630a Maks. wielkość współdzielonej pamięci video wynosi 512MB
IDE	Zintegrowany kontroler IDE Ultra DMA 33 / 66 / 100 / 133 Tryb Bus Master obsługa PIO tryb 0~4,	Zintegrowany kontroler IDE Ultra DMA 33 / 66 / 100 / 133 Tryb Bus Master obsługa PIO tryb 0~4,
SATA II	Zintegrowany kontroler Serial ATA Transfer danych do 3 Gb/s. Zgodność ze specyfikacją SATA w wersji 2.0.	Zintegrowany kontroler Serial ATA Transfer danych do 3 Gb/s. Zgodność ze specyfikacją SATA w wersji 2.0.
LAN	Realtek RTL 8201N / 8211B (opcja) 10 / 100 / 1000 Mb/s z automatyczną negocjacją szybkości (Pasmo gigabitowe wyłącznie dla RTL 8211B) Działanie w trybie półowicznego / pełnego dupleksu	Realtek RTL 8201N / 8211B (opcja) 10 / 100 / 1000 Mb/s z automatyczną negocjacją szybkości (Pasmo gigabitowe wyłącznie dla RTL 8211B) Działanie w trybie półowicznego / pełnego dupleksu

	<i>Ver 5.x</i>	<i>Ver 6.x</i>
Kodek dźwiękowy	ALC888 7.1 kanałowe wyjście audio Obsługa High-Definition Audio	ALC662 5.1 kanałowe wyjście audio Obsługa High-Definition Audio
Gniazda	Gniazdo PCI x2 Gniazdo PCI Express x16 x1 Gniazdo PCI Express x 1 x1	Gniazdo PCI x2 Gniazdo PCI Express x16 x1 Gniazdo PCI Express x 1 x1
Złącza wbudowane	Złącze napędu dyskietek x1 Złącze Port drukarki x1 Złącze IDE x1 Złącze SATA x4 Złącze pętla przedniego x1 Przednie złącze audio x1 Złącze wejścia CD x1 Złącze wyjścia S/PDIF x1 Złącze głośnikowe wentylatora procesora x1 Złącze głośnikowe wentylatora systemowego x1 Złącze głośnikowe kasowania CMOS x1 Złącze USB x3 Złącze Port szeregowy x1 Złącze zasilania (24 pinowe) x1 Złącze zasilania (4 pinowe) x1	Złącze napędu dyskietek x1 Złącze Port drukarki x1 Złącze IDE x1 Złącze SATA x4 Złącze pętla przedniego x1 Przednie złącze audio x1 Złącze wejścia CD x1 Złącze wyjścia S/PDIF x1 Złącze głośnikowe wentylatora procesora x1 Złącze głośnikowe wentylatora systemowego x1 Złącze głośnikowe kasowania CMOS x1 Złącze USB x3 Złącze Port szeregowy x1 Złącze zasilania (24 pinowe) x1 Złącze zasilania (4 pinowe) x1
Back Panel I/O	Klawiatura PS/2 x1 Mysz PS/2 x1 Port VGA x1 Port DVI-D x1 Port LAN x1 Port USB x4 Gniazdo audio x6	Klawiatura PS/2 x1 Mysz PS/2 x1 Port VGA x1 Port DVI-D x1 Port LAN x1 Port USB x4 Gniazdo audio x3
Wymiary płyty	208 mm (S) X 244 mm (W)	208 mm (S) X 244 mm (W)
Funkcje specjalne	Obsługa RAID 0 / 1 / 5 / 0+1	Obsługa RAID 0 / 1 / 5 / 0+1
Obsługa systemu operacyjnego	Windows 2000 / XP / VISTA Bios/Star zastrzega sobie prawo dodawania lub odwoływania obsługi dowolnego systemu operacyjnego bez powiadomienia.	Windows 2000 / XP / VISTA Bios/Star zastrzega sobie prawo dodawania lub odwoływania obsługi dowolnego systemu operacyjnego bez powiadomienia.

RUSSIAN

	Ver 5.x	Ver 6.x
CPU (центральный процессор)	Гнездо AM2 Процессоры AMD Athlon 64 / Athlon 64 FX / Athlon 64 X2 / Sempron Архитектура AMD 64 разрешает обработку данных на 32 и 64 бит Поддержка Hyper Transport и Cool'n'Quiet	Гнездо AM2 Процессоры AMD Athlon 64 / Athlon 64 FX / Athlon 64 X2 / Sempron Архитектура AMD 64 разрешает обработку данных на 32 и 64 бит Поддержка Hyper Transport и Cool'n'Quiet
FSB	Поддержка HyperTransport с пропускной способностью до 1 ГГц	Поддержка HyperTransport с пропускной способностью до 1 ГГц
Набор микросхем	GeForce 7025/NF 630a	GeForce 7025/NF 630a
Основная память	Слоты DDR2 DIMM x 2 Максимальная ёмкость памяти 4 ГБ Каждый модуль DIMM поддерживает 256 МБ / 512 МБ & 1 ГБ / 2 ГБ DDR2 Модуль памяти с двужанальным режимом DDR2 Поддержка DDR2 533 / 667 / 800 Не поддерживает зарегистрированные модули DIMM and ECC DIMM	Слоты DDR2 DIMM x 2 Максимальная ёмкость памяти 4 ГБ Каждый модуль DIMM поддерживает 256 МБ / 512 МБ & 1 ГБ / 2 ГБ DDR2 Модуль памяти с двужанальным режимом DDR2 Поддержка DDR2 533 / 667 / 800 Не поддерживает зарегистрированные модули DIMM and ECC DIMM
Super I/O	ITE 8716F Обеспечивает наиболее используемые действующие функциональные возможности Super I/O. Интерфейс с низким количеством выводов Инициативы по охране окружающей среды, Аппаратный монитор Регулятор скорости Функция ITE "Smart Guardian" (Интеллектуальная защита)	ITE 8716F Обеспечивает наиболее используемые действующие функциональные возможности Super I/O. Интерфейс с низким количеством выводов Инициативы по охране окружающей среды, Аппаратный монитор Регулятор скорости Функция ITE "Smart Guardian" (Интеллектуальная защита)
Графика	Встроенная в набор микросхем GeForce 7025/NF630a Максимальная совместно используемая видеопамять составляет 512 МБ	Встроенная в набор микросхем GeForce 7025/NF630a Максимальная совместно используемая видеопамять составляет 512 МБ
IDE	Встроенное устройство управления встроенными интерфейсами устройств Режим "хвояина" шины Ultra DMA 33 / 66 / 100 / 133 Поддержка режима PIO 0~4,	Встроенное устройство управления встроенными интерфейсами устройств Режим "хвояина" шины Ultra DMA 33 / 66 / 100 / 133 Поддержка режима PIO 0~4,
SATA II	Встроенное последовательное устройство управления ATA скорость передачи данных до 3 гигабит/с. Соответствие спецификации SATA версия 2.0.	Встроенное последовательное устройство управления ATA скорость передачи данных до 3 гигабит/с. Соответствие спецификации SATA версия 2.0.
Локальная сеть	Realtek RTL 8201N / 8211B (дополнительно) Автоматическое согласование 10 / 100 / 1000 Мб/с (гигабитная пропускная способность только для гигабитного физического уровня) Частичная / полная дуплексная способность	Realtek RTL 8201N / 8211B (дополнительно) Автоматическое согласование 10 / 100 / 1000 Мб/с (гигабитная пропускная способность только для гигабитного физического уровня) Частичная / полная дуплексная способность

	<i>Ver 5.x</i>	<i>Ver 6.x</i>
Звуковой кодек	ALC888 7.1-канальный звуковой выход Звуковая поддержка High-Definition	ALC662 5.1-канальный звуковой выход Звуковая поддержка High-Definition
Слоты	Слот PCI x2 Слот PCI Express x16 x1 Слот PCI Express x 1 x1	Слот PCI x2 Слот PCI Express x16 x1 Слот PCI Express x 1 x1
Встроенный разъём	Разъём НГМД x1 Разъём Порт подключения принтера x1 Разъём IDE x1 Разъём SATA x4 Разъём на лицевой панели x1 Входной звуковой разъём x1 Разъём ввода для CD x1 Разъём вывода для S/PDIF x1 Контактирующее приспособление вентилятора центрального процессора x1 Контактирующее приспособление вентилятора системы x1 Открытое контактирующее приспособление CMOS x1 USB-разъём x3 Разъём Последовательный порт x1 Разъём питания (24 вывод) x1 Разъём питания (4 вывод) x1	Разъём НГМД x1 Разъём Порт подключения принтера x1 Разъём IDE x1 Разъём SATA x4 Разъём на лицевой панели x1 Входной звуковой разъём x1 Разъём ввода для CD x1 Разъём вывода для S/PDIF x1 Контактирующее приспособление вентилятора центрального процессора x1 Контактирующее приспособление вентилятора системы x1 Открытое контактирующее приспособление CMOS x1 USB-разъём x3 Разъём Последовательный порт x1 Разъём питания (24 вывод) x1 Разъём питания (4 вывод) x1
Задняя панель средств ввода-вывода	Клавиатура PS/2 x1 Мышь PS/2 x1 Порт VGA x1 Порт DVI-D x1 Порт LAN x1 USB-порт x4 Гнездо для подключения наушников x6	Клавиатура PS/2 x1 Мышь PS/2 x1 Порт VGA x1 Порт DVI-D x1 Порт LAN x1 USB-порт x4 Гнездо для подключения наушников x3
Размер панели	208 мм (Ш) X 244 мм (В)	208 мм (Ш) X 244 мм (В)
Специальные технические характеристики	Поддержка RAID 0/ 1 / 5 / 0+1	Поддержка RAID 0/ 1 / 5 / 0+1
Поддержка OS	Windows 2000 / XP / VISTA Biostar сохраняет за собой право добавлять или удалять средства обеспечения для OS с или без предварительного уведомления.	Windows 2000 / XP / VISTA Biostar сохраняет за собой право добавлять или удалять средства обеспечения для OS с или без предварительного уведомления.

ARABIC

Ver 6.x	Ver 5.x	
AM2 معيّن AMD Athlon 64 / Athlon 64FX / Athlon 64 x2 / Sempron إجراء العمليات لحلوية بسعة 32 و 64 بت AMD تمكن تقنية Hyper Transport و Cod'riQuiet تدعم تقنية	AM2 معيّن AMD Athlon 64 / Athlon 64FX / Athlon 64 x2 / Sempron إجراء العمليات لحلوية بسعة 32 و 64 بت AMD تمكن تقنية Hyper Transport و Cod'riQuiet تدعم تقنية	وحدة لمعالجة المركبة
تردد 1000 بتربديصل إلى Hyper Transport تدعم تقنية	تردد 1000 بتربديصل إلى Hyper Transport تدعم تقنية	النقل الأمامي الجذبي
GeForce 7025/NF 630a	GeForce 7025/NF 630a	مجموعة لشرايح
عدد 2 فتحة DDR2 DIMM سعة ذاكرة قصوى 4 جيجا بايت ميجا 256/512 سعة DDR2 دعم ذاكرة من نوع DIMM تدعم كل فتحة بليت و 1/2 جيجابايت مزوجة فتحة DDR2 وحدة ذاكرة سعات 800 / 667 / 533 ميجا بليت DDR2 تدعم الذاكرة من نوع ECC و تلك التي لا تتوافق مع DIMM لا تدعم نقل الذاكرة	عدد 2 فتحة DDR2 DIMM سعة ذاكرة قصوى 4 جيجا بايت ميجا 256/512 سعة DDR2 دعم ذاكرة من نوع DIMM تدعم كل فتحة بليت و 1/2 جيجابايت مزوجة فتحة DDR2 وحدة ذاكرة سعات 800 / 667 / 533 ميجا بليت DDR2 تدعم الذاكرة من نوع ECC و تلك التي لا تتوافق مع DIMM لا تدعم نقل الذاكرة	الذاكرة الرئيسية
ITE 8716F الأكثر استخداماً Super I/O توفر وظيفة Low Pin Count Interface تدعم تقنية وسائل التحكم في البيئة مراقب لمعومة حلقة الأجهزة مراقب في سرعة لمروحة ITE من "Smart Guardian" وظيفة	ITE 8716F الأكثر استخداماً Super I/O توفر وظيفة Low Pin Count Interface تدعم تقنية وسائل التحكم في البيئة مراقب لمعومة حلقة الأجهزة مراقب في سرعة لمروحة ITE من "Smart Guardian" وظيفة	Super I/O
GeForce 7025/NF 630a منمجة في رفاق ميجابايت 512 أقصى سعة لذاكرة الفيديو لمشوكة	GeForce 7025/NF 630a منمجة في رفاق ميجابايت 512 أقصى سعة لذاكرة الفيديو لمشوكة	بطاقة الرسومات
متكامل IDE متحكم وضع رئيسي 133 / 100 / 66 / 33 Ultra DMA نقل بتقية PIO Mode 0~4 دعم وضع	متكامل IDE متحكم وضع رئيسي 133 / 100 / 66 / 33 Ultra DMA نقل بتقية PIO Mode 0~4 دعم وضع	منفذ IDE
متكامل Serial ATA متحكم قل البيانات بسرعات تصل إلى 3 جيجابت/ثانية. 2.0 الإصدار SATA مطابقة لمواصفات	متكامل Serial ATA متحكم قل البيانات بسرعات تصل إلى 3 جيجابت/ثانية. 2.0 الإصدار SATA مطابقة لمواصفات	SATA II
Realtek RTL 8201N / RTL 8211B (اختياري) قلووض قلني 100/10 ميجا بايت / ثلثية و 1 جيجا بت/ثانية RTL 8211B القلق الترددي لججبلت مقصور ققط على إمكانية الققل لمزوح الكامل/القصفي	Realtek RTL 8201N / RTL 8211B (اختياري) قلووض قلني 100/10 ميجا بايت / ثلثية و 1 جيجا بت/ثانية RTL 8211B القلق الترددي لججبلت مقصور ققط على إمكانية الققل لمزوح الكامل/القصفي	شبكة داخلية

Ver 6.x		Ver 5.x		
ALC662	قنوات لوج الصوت 1, 5. تدعم تقنية الصوت علي تعريف من	ALC888	قنوات لوج الصوت 1, 7. تدعم تقنية الصوت علي تعريف من	كوديك الصوت
عدد 2	فتحة PCI	عدد 2	فتحة PCI	الفتحات
عدد 1	فتحة PCI Expressx16	عدد 1	فتحة PCI Expressx16	
عدد 1	فتحة PCI Express x 1	عدد 1	فتحة PCI Express x 1	
عدد 1	مقذ محرك أقراص مرنة	عدد 1	مقذ محرك أقراص مرنة	المنافذ على سطح اللوحة
عدد 1	مقذ طابعة	عدد 1	مقذ طابعة	
عدد 1	مقذ IDE	عدد 1	مقذ IDE	
عدد 4	مقذ SATA	عدد 4	مقذ SATA	
عدد 1	مقذ اللوحة الأممية	عدد 1	مقذ اللوحة الأممية	
عدد 1	مقذ الصوت الأممي	عدد 1	مقذ الصوت الأممي	
عدد 1	مقذ CD-IN	عدد 1	مقذ CD-IN	
عدد 1	مقذ خرج S/PDIF	عدد 1	مقذ خرج S/PDIF	
عدد 1	وصلة مروحة وحدة المعالجة المركزية	عدد 1	وصلة مروحة وحدة المعالجة المركزية	
عدد 1	وصلة مروحة النظم	عدد 1	وصلة مروحة النظم	
عدد 1	وصلة مسح CMOS	عدد 1	وصلة مسح CMOS	
عدد 3	مقذ USB	عدد 3	مقذ USB	
عدد 1	مقذ تسلسلي	عدد 1	مقذ تسلسلي	
عدد 1	مقذ توصيل الطاقة (24دوس)	عدد 1	مقذ توصيل الطاقة (24دوس)	
عدد 1	مقذ توصيل الطاقة (4دبليس)	عدد 1	مقذ توصيل الطاقة (4دبليس)	
عدد 1	لوحة مفاتيح PS/2	عدد 1	لوحة مفاتيح PS/2	منافذ دخل/خرج اللوحة الخلفية
عدد 1	مؤس PS/2	عدد 1	مؤس PS/2	
عدد 1	منافذ VGA	عدد 1	منافذ VGA	
عدد 1	منافذ DVI-D	عدد 1	منافذ DVI-D	
عدد 1	مقذ شبكة تصل محلية	عدد 1	مقذ شبكة تصل محلية	
عدد 4	منافذ USB	عدد 4	منافذ USB	
عدد 3	مقيس صوت	عدد 6	مقيس صوت	
RAID 0 / 1 / 5 / 0+1 تدعم تقنية		RAID 0 / 1 / 5 / 0+1 تدعم تقنية		مزايا خاصة
208 مم (عرض) X 244 مم (ارتفاع)		208 مم (عرض) X 244 مم (ارتفاع)		حجم اللوحة
Windows 2000 / XP / VISTA بخطا في اإضافة أو إزالة ادم لاني نظام تشغيل بإخطل أو Biostar تحتفظ بيون إخطل.		Windows 2000 / XP / VISTA بخطا في اإضافة أو إزالة ادم لاني نظام تشغيل بإخطل أو Biostar تحتفظ بيون إخطل.		دعم أنظمة تشغيل

JAPANESE

	Ver 5.x	Ver 6.x
CPU	Socket AM2 AMDAthlon 64 / Athlon 64 FX / Athlon 64 x2/ Sempron プロセッサ AMD 64アーキテクチャでは、32ビットと64ビット計算が可能です ハイパートランスポートとクールアンドクワイアットをサポートします	Socket AM2 AMDAthlon 64 / Athlon 64 FX / Athlon 64 x2/ Sempron プロセッサ AMD 64アーキテクチャでは、32ビットと64ビット計算が可能です ハイパートランスポートとクールアンドクワイアットをサポートします
FSB	1GHzのバンド幅までハイパートランスポートをサポートします	1GHzのバンド幅までハイパートランスポートをサポートします
チップセット	GeForce 7025/NF 630a	GeForce 7025/NF 630a
メインメモリ	DDR2 DIMMスロット x 2 最大メモリ容量4GB 各DIMMは 256MB/512MB & 1GB/2GB DDR2をサポート デュアル チャンネルモードDDR2メモリモジュール DDR2 533 / 667 / 800をサポート 登録済みDIMMとECC DIMMはサポートされません	DDR2 DIMMスロット x 2 最大メモリ容量4GB 各DIMMは 256MB/512MB & 1GB/2GB DDR2をサポート デュアル チャンネルモードDDR2メモリモジュール DDR2 533 / 667 / 800をサポート 登録済みDIMMとECC DIMMはサポートされません
Super I/O	ITE 8716F もっとも一般に使用されるレガシーSuper I/O機能を採用しています。 低ピンカウントインターフェイス 環境コントロールイニシアチブ、 H/Wモニター ファン速度コントローラ/ モニター ITEの「スマートガーディアン」機能	ITE 8716F もっとも一般に使用されるレガシーSuper I/O機能を採用しています。 低ピンカウントインターフェイス 環境コントロールイニシアチブ、 H/Wモニター ファン速度コントローラ/ モニター ITEの「スマートガーディアン」機能
グラフィックス	GeForce 7025/NF630aチップセットに統合 最大の共有ビデオメモリは512MBです	GeForce 7025/NF630aチップセットに統合 最大の共有ビデオメモリは512MBです
IDE	統合IDEコントローラ Ultra DMA 33 / 66 / 100 / 133バスマスタモード PIO Mode 0~4のサポート、	統合IDEコントローラ Ultra DMA 33 / 66 / 100 / 133バスマスタモード PIO Mode 0~4のサポート、
SATA II	統合シリアルATAコントローラ 最高3 Gb/秒のデータ転送速度 SATAバージョン2.0仕様に準拠。	統合シリアルATAコントローラ 最高3 Gb/秒のデータ転送速度 SATAバージョン2.0仕様に準拠。
LAN	Realtek RTL 8201N / 8211B (オプション) 10 / 100 / 1000 Mb/秒のオートネゴシエーション (Gigabitバンド幅はRTL 8211B 専用です) 半/全二重機能	Realtek RTL 8201N / 8211B (オプション) 10 / 100 / 1000 Mb/秒のオートネゴシエーション (Gigabitバンド幅はRTL 8211B 専用です) 半/全二重機能

	Ver 5.x		Ver 6.x	
サウンド Codec	ALC888 7.1チャンネルオーディオアウト ハイデフィニションオーディオのサポート		ALC662 5.1チャンネルオーディオアウト ハイデフィニションオーディオのサポート	
スロット	PCIスロット	x2	PCIスロット	x2
	PCI Express x16スロット	x1	PCI Express x16スロット	x1
	PCI Express x1スロット	x1	PCI Express x1スロット	x1
オンボードコ ネクタ	フロッピーコネクタ	x1	フロッピーコネクタ	x1
	プリンタポートコネクタ	x1	プリンタポートコネクタ	x1
	IDEコネクタ	x1	IDEコネクタ	x1
	SATAコネクタ	x4	SATAコネクタ	x4
	フロントパネルコネクタ	x1	フロントパネルコネクタ	x1
	フロントオーディオコネクタ	x1	フロントオーディオコネクタ	x1
	CDインコネクタ	x1	CDインコネクタ	x1
	S/PDIFアウトコネクタ	x1	S/PDIFアウトコネクタ	x1
	CPUファンヘッダ	x1	CPUファンヘッダ	x1
	システムファンヘッダ	x1	システムファンヘッダ	x1
	CMOS クリアヘッダ	x1	CMOS クリアヘッダ	x1
	USBコネクタ	x3	USBコネクタ	x3
	シリアルポートコネクタ	x1	シリアルポートコネクタ	x1
電源コネクタ (24ピン)	x1	電源コネクタ (24ピン)	x1	
電源コネクタ (4ピン)	x1	電源コネクタ (4ピン)	x1	
背面パネル I/O	PS/2キーボード	x1	PS/2キーボード	x1
	PS/2マウス	x1	PS/2マウス	x1
	VGAポート	x1	VGAポート	x1
	DVI-Dポート	x1	DVI-Dポート	x1
	LANポート	x1	LANポート	x1
	USBポート	x4	USBポート	x4
	オーディオジャック	x6	オーディオジャック	x3
ボードサイズ	208 mm (幅) X 244 mm (高さ)		208 mm (幅) X 244 mm (高さ)	
特殊機能	RAID 0 / 1 / 5 / 0+1 のサポート		RAID 0 / 1 / 5 / 0+1 のサポート	
OSサポート	Windows 2000 / XP / VISTA Bicstarは事前のサポートなしにOSサポートを追加または削除する権利を留保します。		Windows 2000 / XP / VISTA Bicstarは事前のサポートなしにOSサポートを追加または削除する権利を留保します。	

2007/06/01

GF7025-M2 BIOS Setup

BIOS Setup	1
1 Main Menu	3
2 Standard CMOS Features.....	7
3 Advanced BIOS Features	9
4 Advanced Chipset Features.....	16
5 Integrated Peripherals.....	18
6 Power Management Setup.....	25
7 PnP/PCI Configurations.....	29
8 PC Health Status	31
9 Performance Booster Zone.....	34

GF7025-M2

BIOS Setup

Introduction

The purpose of this manual is to describe the settings in the Phoenix-Award™ BIOS Setup program on this motherboard. The Setup program allows users to modify the basic system configuration and save these settings to CMOS RAM. The power of CMOS RAM is supplied by a battery so that it retains the Setup information when the power is turned off.

Basic Input-Output System (BIOS) determines what a computer can do without accessing programs from a disk. This system controls most of the input and output devices such as keyboard, mouse, serial ports and disk drives. BIOS activates at the first stage of the booting process, loading and executing the operating system. Some additional features, such as virus and password protection or chipset fine-tuning options are also included in BIOS.

The rest of this manual will to guide you through the options and settings in BIOS Setup.

Plug and Play Support

This PHOENIX-AWARD BIOS supports the Plug and Play Version 1.0A specification and ESCD (Extended System Configuration Data) write.

EPA Green PC Support

This PHOENIX-AWARD BIOS supports Version 1.03 of the EPA Green PC specification.

APM Support

This PHOENIX-AWARD BIOS supports Version 1.1&1.2 of the Advanced Power Management (APM) specification. Power management features are implemented via the System Management Interrupt (SMI). Sleep and Suspend power management modes are supported. Power to the hard disk drives and video monitors can also be managed by this PHOENIX-AWARD BIOS.

GF7025-M2

ACPI Support

Phoenix-Award ACPI BIOS support Version 1.0b of Advanced Configuration and Power interface specification (ACPI). It provides ASL code for power management and device configuration capabilities as defined in the ACPI specification, developed by Microsoft, Intel and Toshiba.

PCI Bus Support

This PHOENIX-AWARD BIOS also supports Version 3.0 of the Intel PCI (Peripheral Component Interconnect) local bus specification.

DRAM Support

DDR2 SDRAM (Double Data Rate Synchronous DRAM) is supported.

Supported CPUs

This PHOENIX-AWARD BIOS supports the AMD CPU.

Using Setup

Use the arrow keys to highlight items in most of the place, press <Enter> to select, use the <PgUp> and <PgDn> keys to change entries, press <F1> for help and press <Esc> to quit. The following table provides more detail about how to navigate in the Setup program by using the keyboard.

Keystroke	Function
Up arrow	Move to previous item
Down arrow	Move to next item
Left arrow	Move to the item on the left (menu bar)
Right arrow	Move to the item on the right (menu bar)
Move Enter	Move to the item you desired
PgUp key	Increase the numeric value or make changes
PgDn key	Decrease the numeric value or make changes
+ Key	Increase the numeric value or make changes
- Key	Decrease the numeric value or make changes
Esc key	Main Menu – Quit and not save changes into CMOS Status Page Setup Menu and Option Page Setup Menu – Exit Current page and return to Main Menu
F1 key	General help on Setup navigation keys
F5 key	Load previous values from CMOS
F7 key	Load the optimized defaults
F10 key	Save all the CMOS changes and exit

GF7025-M2

1 Main Menu

Once you enter Phoenix-Award BIOS™ CMOS Setup Utility, the Main Menu will appear on the screen. The Main Menu allows you to select from several setup functions. Use the arrow keys to select among the items and press <Enter> to accept and enter the sub-menu.

!! WARNING !!

For better system performance, the BIOS firmware is being continuously updated. The BIOS information described in this manual (**Figure 1, 2, 3, 4, 5, 6, 7, 8, 9**) is for your reference only. The actual BIOS information and settings on board may be slightly different from this manual.

■ **Figure 1: Main Menu**

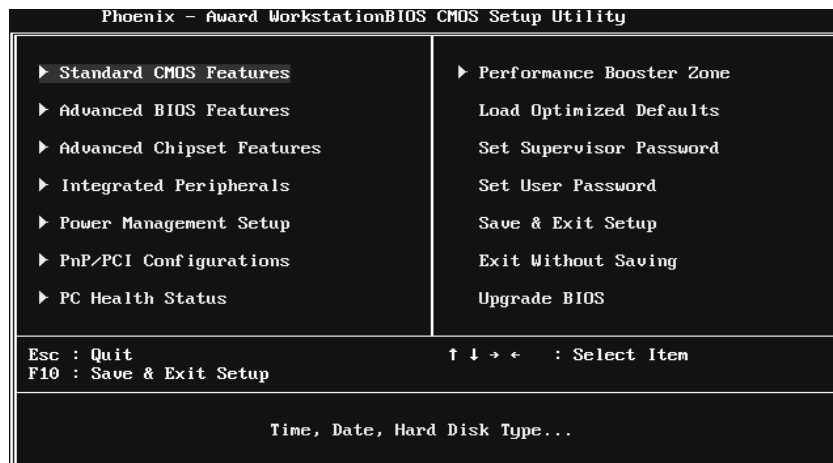

Standard CMOS Features

This submenu contains industry standard configurable options.

GF7025-M2

Advanced BIOS Features

This submenu allows you to configure advanced features of the BIOS.

Advanced Chipset Features

This submenu allows you to configure special chipset features.

Integrated Peripherals

This submenu allows you to configure certain IDE hard drive options and Programmed Input/ Output features.

Power Management Setup

This submenu allows you to configure the power management features.

PnP/PCI Configurations

This submenu allows you to configure certain “Plug and Play” and PCI options.

PC Health Status

This submenu allows you to monitor the hardware of your system.

Performance Booster Zone

This submenu allows you to change CPU Vcore Voltage and CPU/PCI clock. (However, we suggest you to use the default setting. Changing the voltage and clock improperly may damage the CPU or M/B!)

Load Optimized Defaults

This selection allows you to reload the BIOS when problem occurs during system booting sequence. These configurations are factory settings optimized for this system. A confirmation message will be displayed before defaults are set.



Load Optimized Defaults (Y/N)? N

GF7025-M2

Set Supervisor Password

Setting the supervisor password will prohibit everyone except the supervisor from making changes using the CMOS Setup Utility. You will be prompted with to enter a password.



```
Enter Password:
```

Set User Password

If the Supervisor Password is not set, then the User Password will function in the same way as the Supervisor Password. If the Supervisor Password is set and the User Password is set, the “User” will only be able to view configurations but will not be able to change them.



```
Enter Password:
```

Save & Exit Setup

Save all configuration changes to CMOS (memory) and exit setup. Confirmation message will be displayed before proceeding.



```
SAVE to CMOS and EXIT (Y/N)? Y
```

Exit Without Saving

Abandon all changes made during the current session and exit setup. Confirmation message will be displayed before proceeding.



```
Quit Without Saving (Y/N)? N
```

GF7025-M2

Upgrade BIOS

This submenu allows you to upgrade bios.

BIOS UPDATE UTILITY (Y/N)? N

GF7025-M2

2 Standard CMOS Features

The items in Standard CMOS Setup Menu are divided into several categories. Each category includes no, one or more than one setup items. Use the arrow keys to highlight the item and then use the <PgUp> or <PgDn> keys to select the value you want in each item.

■ **Figure 2: Standard CMOS Setup**

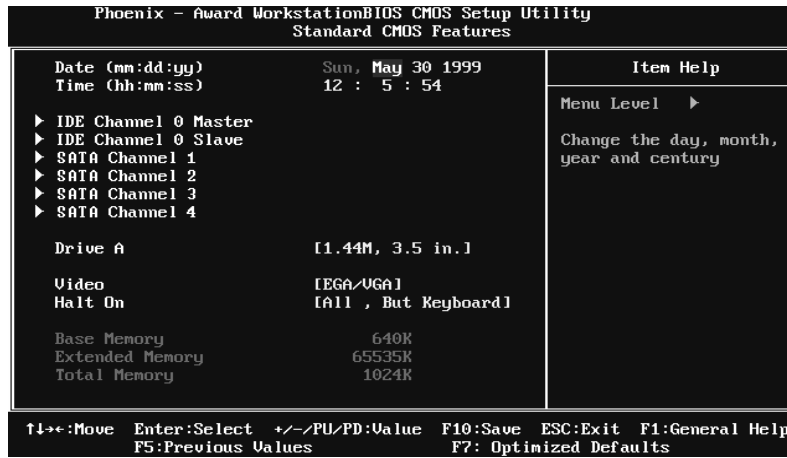

Main Menu Selections

This table shows the items and the available options on the Main Menu.

Item	Options	Description
Date	mm : dd : yy	Set the system date. Note that the 'Day' automatically changes when you set the date.
Time	hh : mm : ss	Set the system internal clock.
IDE Channel 0 Master	Options are in its sub menu.	Press <Enter> to enter the sub menu of detailed options
IDE Channel 0 Slave	Options are in its sub menu.	Press <Enter> to enter the sub menu of detailed options.

GF7025-M2

Item	Options	Description
SATA Channel 1~4	Options are in its sub menu.	Press <Enter> to enter the sub menu of detailed options.
Drive A	360K, 5.25 in 1.2M, 5.25 in 720K, 3.5 in 1.44M, 3.5 in 2.88M, 3.5 in None	Select the type of floppy disk drive installed in your system.
Video	EGA/VGA CGA 40 CGA 80 MONO	Select the default video device.
Halt On	All Errors No Errors All, but Keyboard All, but Diskette All, but Disk/ Key	Select the situation in which you want the BIOS to stop the POST process and notify you.
Base Memory	N/A	Displays the amount of conventional memory detected during boot up.
Extended Memory	N/A	Displays the amount of extended memory detected during boot up.
Total Memory	N/A	Displays the total memory available in the system.

GF7025-M2

3 Advanced BIOS Features

■ Figure 3: Advanced BIOS Setup

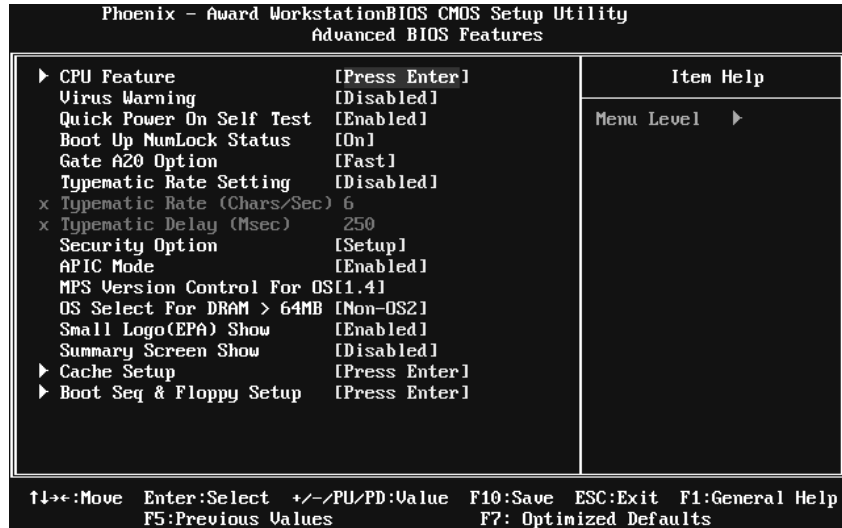

CPU Feature

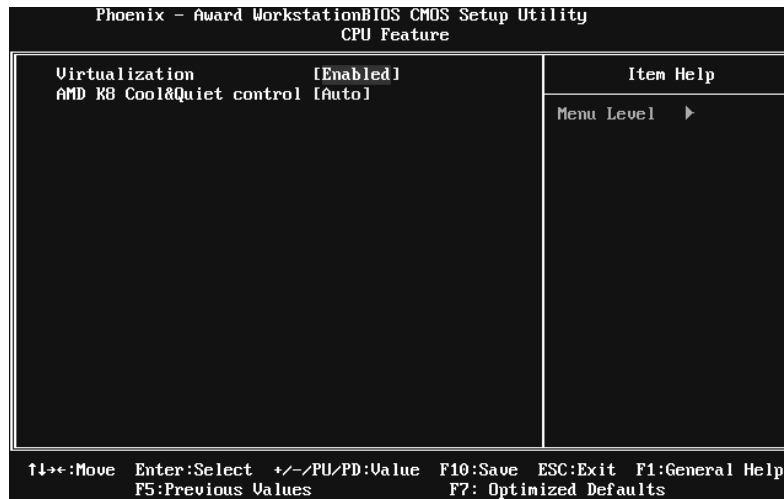

GF7025-M2

Virtualization

The item allows you control the Virtualization function.

The Choices: **Enabled** (default), Disabled.

AMD K8 Cool&Quiet control

The item allows you select K8 Cool'n'Quiet control.

The Choices: **Auto** (default), Disabled.

Virus Warning

This option allows you to choose the VIRUS Warning feature that is used to protect the IDE Hard Disk boot sector. If this function is enabled and an attempt is made to write to the boot sector, BIOS will display a warning message on the screen and sound an alarm beep.

Disabled (default) Virus protection is disabled.
Enabled Virus protection is activated.

Quick Power On Self Test

Enabling this option will cause an abridged version of the Power On Self-Test (POST) to execute after you power up the computer.

Disabled Normal POST.
Enabled (default) Enable quick POST.

Boot Up NumLock Status

Selects the NumLock State after the system switched on.

The Choices:

On (default) Numpad is number keys.
Off Numpad is arrow keys.

Gate A20 Option

Select if chipset or keyboard controller should control Gate A20.

Normal A pin in the keyboard controller controls GateA20.
Fast (default) Lets chipset control Gate A20.

GF7025-M2

Typematic Rate Setting

When a key is held down, the keystroke will repeat at a rate determined by the keyboard controller. When enabled, the typematic rate and typematic delay can be configured.

The Choices: Disabled (default), Enabled.

Typematic Rate (Chars/Sec)

Sets the rate at which a keystroke is repeated when you hold the key down.

The Choices: 6 (default), 8, 10, 12, 15, 20, 24, 30.

Typematic Delay (Msec)

Sets the delay time after the key is held down before it begins to repeat the keystroke.

The Choices: 250 (default), 500, 750, 1000.

Security Option

This option will enable only individuals with passwords to bring the system online and/or to use the CMOS Setup Utility.

System: A password is required for the system to boot and is also required to access the Setup Utility.

Setup (default): A password is required to access the Setup Utility only.

This will only apply if passwords are set from the Setup main menu.

APIC MODE

Selecting Enabled enables APIC device mode reporting from the BIOS to the operating system.

The Choices: Enabled (default), Disabled.

MPS Version Control For OS

The BIOS supports version 1.1 and 1.4 of the Intel multiprocessor specification. Select version supported by the operation system running on this computer.

The Choices: 1.4 (default), 1.1.

GF7025-M2

OS Select For DRAM > 64MB

A choice other than Non-OS2 is only used for OS2 systems with memory exceeding 64MB.

The Choices: Non-OS2 (default), OS2.

Small Logo(EPA) Show

This item allows you to select whether the “Small Logo” shows. Enabled (default) “Small Logo” shows when system boots up. Disabled No “Small Logo” shows when system boots

The Choices: Enabled (default), Disabled.

Summary Screen Show

This item allows you to enable/disable the summary screen. Summary screen means system configuration and PCI device listing.

The Choices: Disabled (default), Enabled.

Cache Setup

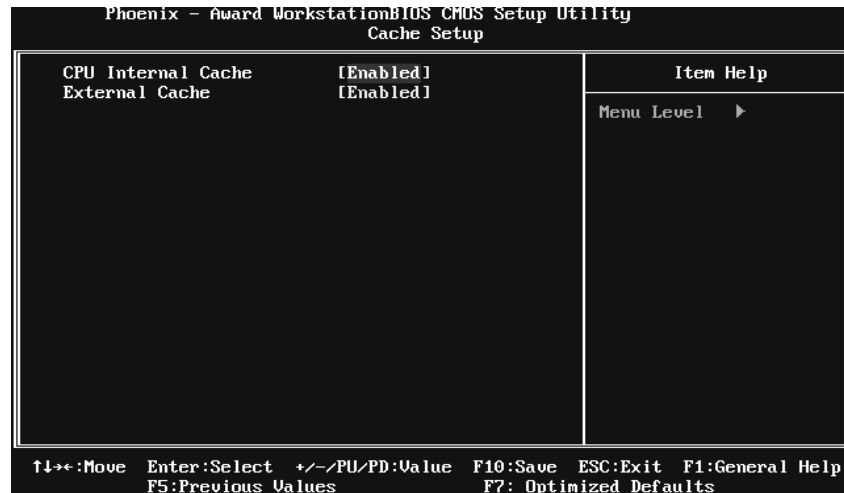

GF7025-M2

CPU Internal Cache

Depending on the CPU/chipset in use, you may be able to increase memory access time with this option.

- Enabled** (default) Enable cache.
- Disabled Disable cache.

External Cache

This option enables or disables "Level 2" secondary cache on the CPU, which may improve performance.

- Enabled** (default) Enable cache.
- Disabled Disable cache.

Boot Seq & Floppy Setup

This item allows you to setup boot sequence & Floppy.

```
Phoenix - Award WorkstationBIOS CMOS Setup Utility
Boot Seq & Floppy Setup

▶ Removable Device Priority [Press Enter]
▶ Hard Disk Boot Priority   [Press Enter]
▶ CD-ROM Boot Priority     [Press Enter]
  First Boot Device       [Removable]
  Second Boot Device      [Hard Disk]
  Third Boot Device       [CDROM]
  Boot Other Device       [Enabled]
  Boot Up Floppy Seek     [Enabled]

Item Help
Menu Level ▶
Select Removable Boot
Device Priority

↑↓←→:Move  Enter:Select  +/-/PU/PD:Value  F10:Save  ESC:Exit  F1:General Help
F5:Previous Values      F7: Optimized Defaults
```

GF7025-M2

Removable Device Priority

Select Removable Boot Device Priority.

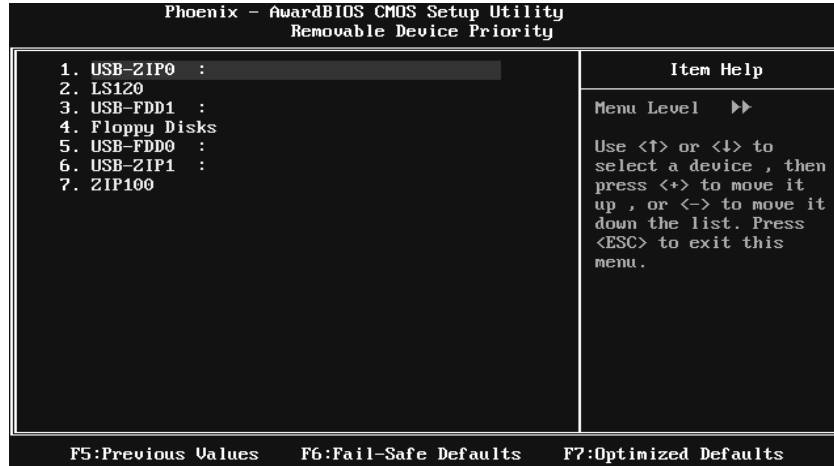

The Choices: Floppy Disks, Zip100, USB-FDD0, USB-FDD1, USB-ZIP0, USB-ZIP1, LS120.

Hard Disk Boot Priority

The BIOS will attempt to arrange the Hard Disk boot sequence automatically.

You can change the Hard Disk booting sequence here.



The Choices: Pri. Master, Pri. Slave, Sec. Master, Sec. Slave, USB HDD0, USB HDD1, USB HDD2, and Bootable Add-in Cards.

GF7025-M2

CD-ROM Boot Priority

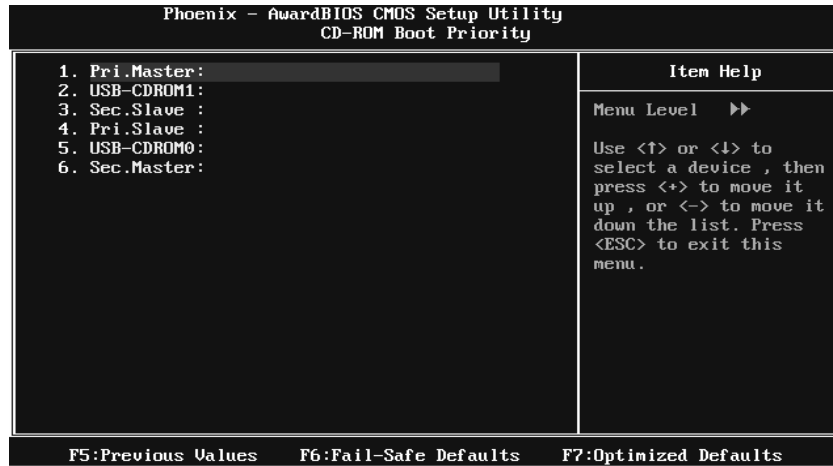

The Choices: Pri. Master, Pri. Slave, Sec. Master, Sec. Slave, USB CDR0M0, USB CDR0M 1.

First/Second/Third Boot Device

The BIOS will attempt to load the operating system in this order.

The Choices: Removable, Hard Disk, CDROM, Legacy LAN, Disabled.

Boot Other Device

When enabled, BIOS will try to load the operating system from other device when it failed to load from the three devices above.

The Choices: Enabled (default), Disabled

Boot Up Floppy Seek

When enabled, System will test the floppy drives to determine if they have 40 or 80 tracks during boot up. Disabling this option reduces the time it takes to boot-up.

The Choices: Enabled (default), Disabled.

GF7025-M2

4 Advanced Chipset Features

This submenu allows you to configure the specific features of the chipset installed on your system. This chipset manage bus speeds and access to system memory resources, such as DRAM. It also coordinates communications with the PCI bus. The default settings that came with your system have been optimized and therefore should not be changed unless you are suspicious that the settings have been changed incorrectly.

■ **Figure 4: Advanced Chipset Setup**

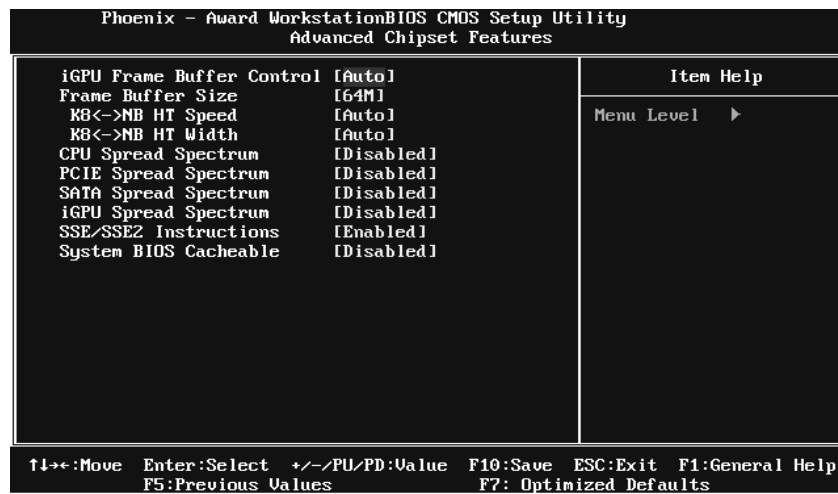

iGPU Frame Buffer Control

This item allows you to control the iGPU frame buffer.

The Choices: AUTO (default), Manual.

Frame Buffer Size

This item allows you to choose the frame buffer size of on-chip VGA.

The Choices: 64M (default), 16M, 32M, 128M, 256M, Disabled.

K8<->NB HT Speed

The Choices: AUTO (default), 1x, 2x, 3x, 4x, 5x.

GF7025-M2

K8<->NB HT Width

The Choices: AUTO (default), ↓8↑8, ↓16↑16.

CPU Spread Spectrum

This item allows you to select the CPU Spread Spectrum function.

The Choices: 0.50% H.Kiss Cntr, 0.50% H.Kiss Down, 0.75% H.Kiss Cntr, 0.75% H.Kiss Down, **Disabled** (default).

PCIE Spread Spectrum

This item allows you to select the PCIE Spread Spectrum function.

The Choices: **Disabled** (default), Linear Down.

SATA Spread Spectrum

This item allows you to select the SATA Spread Spectrum function.

The Choices: **Disabled** (default), Linear Down.

iGPU Spread Spectrum

This item allows you to select the iGPU Spread Spectrum function.

The Choices: **Disabled** (default), 1%, 2%, 3%.

SSE/SSE2 instructions

This item allows you to enable/disable SSE/SSE2 instruction.

The Choices: **Enabled** (default), Disabled.

System BIOS Cacheable

Selecting the “Enabled” option allows caching of the system BIOS ROM at F0000h-FFFFFh, which is able to improve the system performance. However, any programs that attempts to write to this memory block will cause conflicts and result in system errors.

The Choices: **Disabled** (default), Enabled.

GF7025-M2

5 Integrated Peripherals

■ Figure 5. Integrated Peripherals

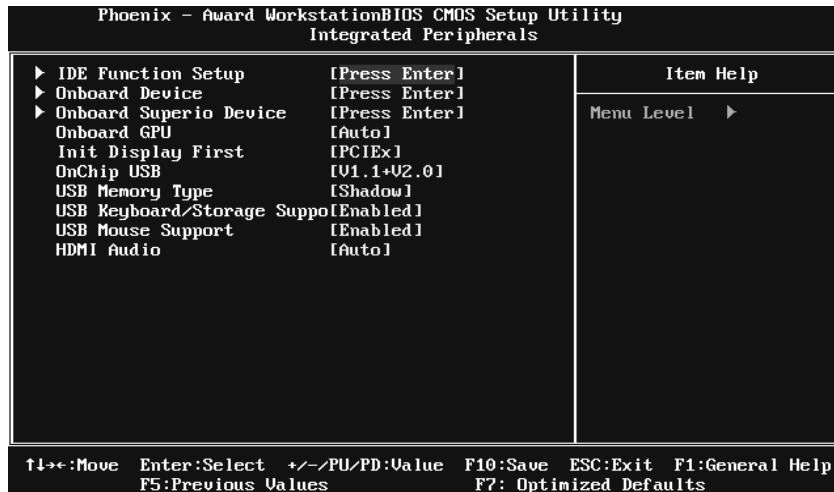

IDE Function Setup

Highlight the “Press Enter” label next to the “IDE Function Setup” label and press enter key will take you a submenu with the following options:

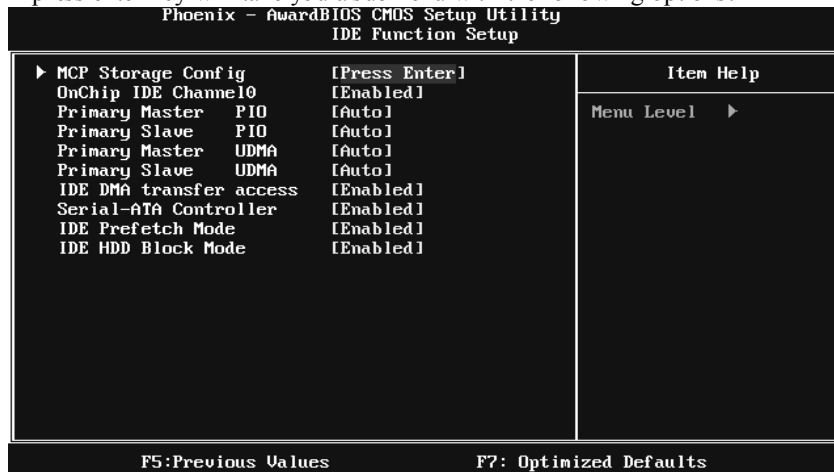

GF7025-M2

MCP Storage Config

Phoenix - AwardBIOS CMOS Setup Utility
MCP Storage Config

SATA Operation Mode	[IDE]	Item Help
x SATA Pri-Master RAID	Disabled	Menu Level ▶▶
x SATA Pri-Slave RAID	Disabled	
x SATA Sec-Master RAID	Disabled	
x SATA Sec-Slave RAID	Disabled	

F5: Previous Values F7: Optimized Defaults

SATA Operation Mode

This option allows you to choose SATA function.

The Choices: IDE (default), RAID, AHCI, Linux AHCI.

SATA Pri-/Sec- Master/Slave RAID

This option allows you to enable or disable SATA Primary/Secondary RAID.

The Choices: Disabled (default), Enabled.

On-chip IDE Channel 0

The motherboard chipset contains a PCI IDE interface with support for two IDE channels. Select "Enabled" to activate the first and/or second IDE interface. Select "Disabled" to deactivate an interface if you are going to install a primary and/or secondary add-in IDE interface.

The Choices: Enabled (default), Disabled.

Primary Master/Slave PIO

The IDE PIO (Programmed Input / Output) fields let you set a PIO mode (0-4) for each of the IDE devices that the onboard IDE interface supports. Modes 0 to 4 will increase performance progressively. In Auto mode, the system automatically determines the best mode for each device.

The Choices: Auto (default), Mode0, Mode1, Mode2, Mode3, Mode4.

GF7025-M2

Primary Master/Slave UDMA

Ultra DMA function can be implemented if it is supported by the IDE hard drives in your system. As well, your operating environment requires a DMA driver (Windows 95 or OSR2 may need a third party IDE bus master driver). If your hard drive and your system software both support Ultra DMA, select Auto to enable BIOS support.

The Choices: Auto (default), Disabled.

IDE DMA Transfer Access

This item allows you to enable or disable the IDE DMA transfer access.

The Choices: Enabled (default), Disabled.

Serial-ATA Controller

This item allows you to enable or disable the Serial ATA function.

The Choices: Enabled (default), Disabled.

IDE Prefetch Mode

The “onboard” IDE drive interfaces supports IDE prefetch function for faster drive access. If the interface on your drive does not support prefetching, or if you install a primary and/or secondary add-in IDE interface, set this option to “Disabled”.

The Choices: Enabled (default), Disabled.

IDE HDD Block Mode

Block mode is also called block transfer, multiple commands, or multiple sectors read / write. If your IDE hard drive supports block mode (most new drives do), select Enabled for automatic detection of the optimal number of block mode (most new drives do), select Enabled for automatic detection of the optimal number of block read / write per sector where the drive can support.

The Choices: Enabled (default), Disabled.

GF7025-M2

Onboard Device

Highlight the “Press Enter” label next to the “Onboard Device” label and press the enter key will take you a submenu with the following options:

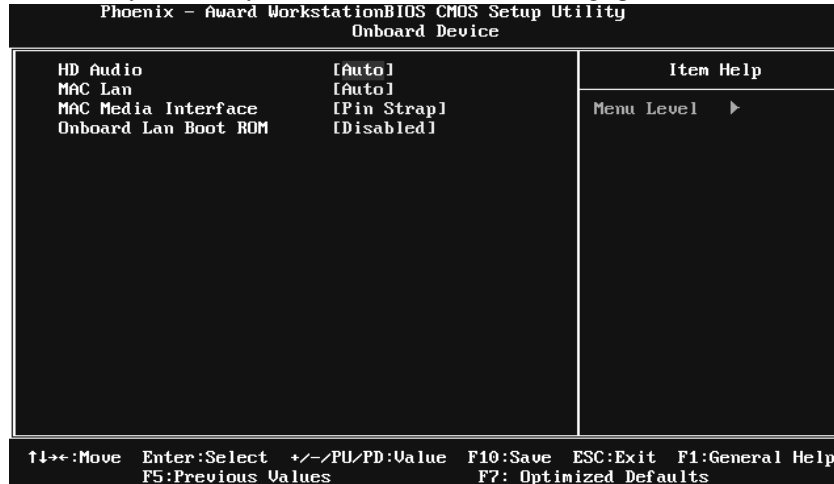

HD Audio

This option allows you to control the onboard HD audio.

The Choices: Auto (default), Disabled.

MAC LAN

This option allows you to control the onboard LAN.

The Choices: Auto (default), Disabled.

MAC Media Interface

This option allows you to select the MAC media interface.

The Choices: Pin Strap (default), MII, RGMII.

Onboard LAN Boot ROM

This item allows you to enable or disable the Onboard LAN Boot ROM.

The Choices: Disabled (default), Enabled.

GF7025-M2

Onboard SuperIO Device

Press Enter to configure the Super I/O device.

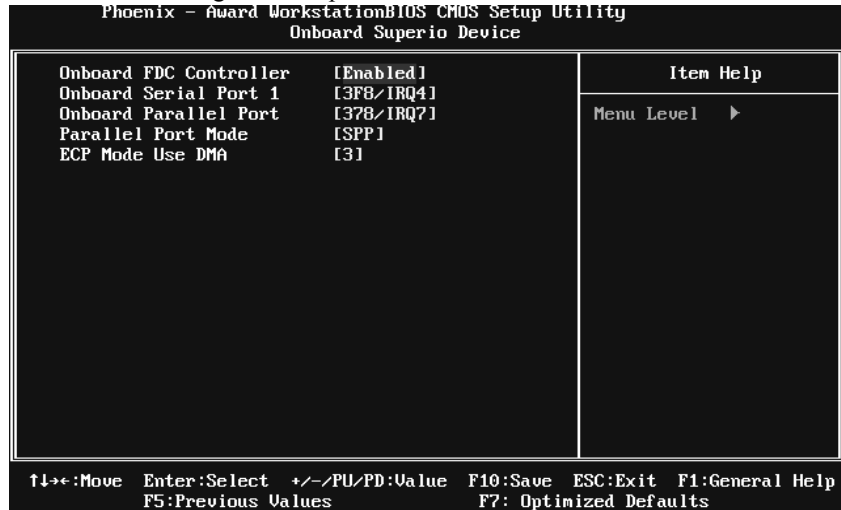

Onboard FDC Controller

Select enabled if your system has a floppy disk controller (FDC) installed on the system board and you wish to use it. If you installed another FDC or the system uses no floppy drive, select disabled in this field.

The Choices: Enabled (default), Disabled.

Onboard Serial Port 1

Select an address and corresponding interrupt for the first and second serial ports.

The Choices: 3F8/IRQ4 (default), Disabled, 2F8/IRQ3, 3E8/IRQ4, 2E8/IRQ3, Auto.

Onboard Parallel Port

This item allows you to determine access onboard parallel port controller with which I/O Address.

The Choices: 378/IRQ7 (default), 278/IRQ5, 3BC/IRQ7, Disabled.

GF7025-M2

Parallel Port Mode

This item allows you to determine how the parallel port should function. The default value is SPP.

The Choices:

SPP (default)	Using Parallel port as Standard Printer Port.
EPP	Using Parallel Port as Enhanced Parallel Port.
ECP	Using Parallel port as Extended Capabilities Port.
ECP+EPP	Using Parallel port as ECP & EPP mode.

ECP Mode Use DMA

Select a DMA Channel for the port.

The Choices: 3 (default), 1.

Onboard GPU

This item allows you to control the onboard GPU.

The Choices: Auto (default), Always Enable.

Init Display First

This item allows you to decide to active whether PCI Slot or on-chip VGA first.

The Choices: PCIEx (default), PCI Slot, Onboard.

OnChip USB

This option should be enabled if your system has a USB installed on the system board. You may need to disable this feature if you add a higher performance controller.

The Choices: V1.1+V2.0 (default), Disabled, V1.1

USB Memory Type

This option allows you to choose the USB memory type.

The Choices: SHADOW (default), Base Memory(640K).

GF7025-M2

USB Keyboard/Storage Support

This item allows you to enable or disable the USB Keyboard / storage Legacy Support.

- | | |
|--------------------------|--|
| Enabled (default) | Enable USB Keyboard / storage Support. |
| Disabled | Disable USB Keyboard/ storage Support. |

USB Mouse Support

This item allows you to enable or disable the USB mouse Legacy Support.

- | | |
|--------------------------|----------------------------|
| Enabled (default) | Enable USB mouse Support. |
| Disabled | Disable USB mouse Support. |

HDMI Audio

This item allows you to control the audio function of HDMI.

The Choices: **Auto** (default), Disabled.

GF7025-M2

6 Power Management Setup

The Power Management Setup Menu allows you to configure your system to utilize energy conservation and power up/power down features.

■ Figure 6. Power Management Setup

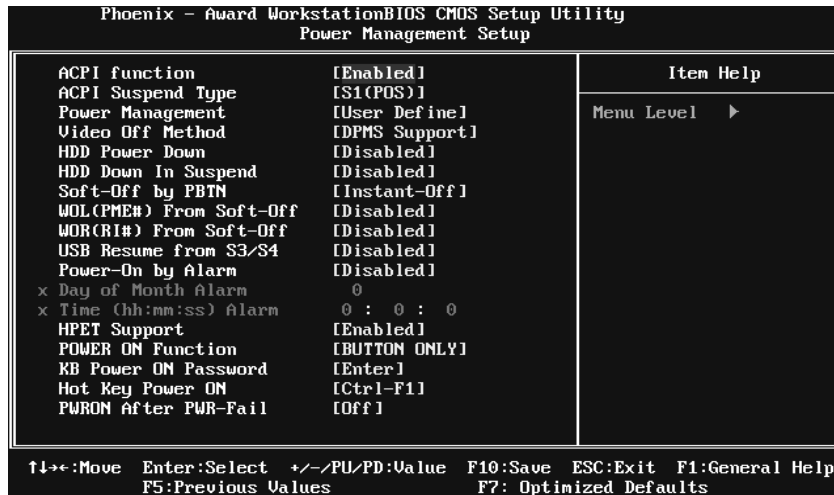

ACPI Function

This item displays the status of the Advanced Configuration and Power Management (ACPI).

The Choices: Enabled (default), Disabled.

ACPI Suspend Type

The item allows you to select the suspend type under the ACPI operating system.

The Choices: S1 (POS) (default) Power on Suspend
S3 (STR) Suspend to RAM
S1 & S3 POS+STR

GF7025-M2

Power Management

This category allows you to select the power saving method and is directly related to the following modes:

1. HDD Power Down.
2. Suspend Mode.

There are three options of Power Management, three of which have fixed mode settings

Min. Power Saving

Minimum power management.

Suspend Mode = 1 hr.

HDD Power Down = 15 min

Max. Power Saving

Maximum power management only available for s1 CPU's.

Suspend Mode = 1 min.

HDD Power Down = 1 min.

User Define (default)

Allow you to set each option individually.

When you choose user define, you can adjust each of the item from 1 min. to 1 hr. except for HDD Power Down which ranges from 1 min. to 15 min.

Video Off Method

This option determines the manner when the monitor goes blank.

V/H SYNC+Blank

This selection will cause the system to turn off the vertical and horizontal synchronization ports and write blanks to the video buffer.

Blank Screen

This option only writes blanks to the video buffer.

DPMS Support (default)

Initial display power management signaling.

HDD Power Down

When enabled, the hard-disk drives will power down after a set time of system inactivity. All other devices remain active.

The Choices: Disabled (default), 1 Min, 2 Min, 3 Min, 4 Min, 5 Min, 6 Min, 7 Min, 8 Min, 9 Min, 10 Min, 11 Min, 12 Min, 13 Min, 14 Min, 15Min.

GF7025-M2

HDD Down In Suspend

This option allows you to enable or disable the HDD power down function in suspend mode.

The Choices: Disabled (default), Enabled

Soft-Off by PBTN

This item determines the behavior of system power button. Instant off turns off the power immediately, and Delay 4 Sec. will require you to press and hold the power button for 4 seconds to cut off the system power.

The Choices: Delay 4 Sec, Instant-Off (default).

WOL(PME#)/ From Soft-Off

This item allows you to enable or disable Wake On LAN from Soft-Off function.

The Choices: Disabled (default), Enabled.

WOR(RI#) From Soft-Off

This item allows you to enable or disable Wake On Ring from Soft-Off function.

The Choices: Disabled (default), Enabled.

USB Resume From S3/S4

This item allows you to enable or disable the USB resume from S3/S4 function.

The Choices: Disabled (default), Enabled.

Power-On by Alarm

This function is for setting date and time for your computer to boot up. When enabled, you can choose the date and time to boot up the system.

The Choices: Disabled (default), Enabled.

GF7025-M2

Date (of Month) Alarm

You can choose which month the system will boot up.

Time (hh:mm:ss) Alarm

You can choose the system boot up time, input hour, minute and second to specify.

Note: If you have change the setting, you must let the system boot up until it goes to the operating system, before this function will work.

HPET Support

This option allows you to disabled or enables the High Precision Event Timer.

The Choices: Enabled (default), Disabled.

POWER ON Function`

This item allows you to choose the power on method.

The Choices: Button Only(default), Password, Hot Key, Mouse Move, Mouse Click, Any Key, Keyboard 98.

KB Power ON Password

Input password and press Enter to set the Keyboard power on password.

Hot Key Power ON

Choose the Hot Key combination to boot up the system.

The Choices: Ctrl-F1(default), Ctrl-F2, Ctrl-F3, Ctrl-F4, Ctrl-F5, Ctrl-F6, Ctrl-F7, Ctrl-F8, Ctrl-F9, Ctrl-F10, Ctrl-F11, and Ctrl-F12.

PWRON After PWR-Fail

This setting specifies how your system should behave after a power fail or interrupts occurs. By choosing off will leave the computer in the power off state. Choosing On will reboot the computer. Former-Sts will restore the system to the status before power failure or interrupt occurs.

The Choices: Off (default), On, Former-Sts.

GF7025-M2

7 PnP/PCI Configurations

This section describes configuring the PCI bus system. PCI, or Personal Computer Interconnect, is a system which allows I/O devices to operate at speeds nearing the speed of the CPU itself uses when communicating with its own special components. This section covers some very technical items and it is strongly recommended that only experienced users should make any changes to the default settings.

■ **Figure 7: PnP/PCI Configurations**

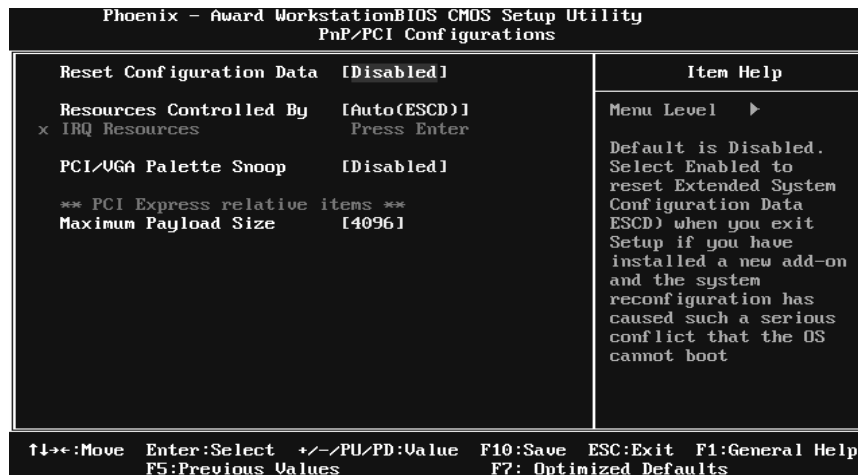

Reset Configuration Data

The system BIOS supports the PnP feature which requires the system to record which resources are assigned and protects resources from conflict. Every peripheral device has a node, which is called ESCD. This node records which resources are assigned to it. The system needs to record and update ESCD to the memory locations. These locations are reserved in the system BIOS. If the Disabled (default) option is chosen, the system's ESCD will update only when the new configuration varies from the last one. If the Enabled option is chosen, the system is forced to update ESCDs and then is automatically set to the "Disabled" mode.

GF7025-M2

The above settings will be shown on the screen only if “Manual” is chosen for the resources controlled by function.

Legacy is the term, which signifies that a resource is assigned to the ISA Bus and provides non-PnP ISA add-on cards. PCI / ISA PnP signify that a resource is assigned to the PCI Bus or provides for ISA PnP add-on cards and peripherals.

The Choices: Disabled (default), Enabled.

Resources Controlled By

By Choosing “Auto(ESCD)” (default), the system BIOS will detect the system resources and automatically assign the relative IRQ and DMA channel for each peripheral. By Choosing “Manual”, the user will need to assign IRQ & DMA for add-on cards. Be sure that there are no IRQ/DMA and I/O port conflicts.

The Choices: Auto (ESCD) (default), Manual.

IRQ Resources

This submenu will allow you to assign each system interrupt a type, depending on the type of device using the interrupt. When you press the “Press Enter” tag, you will be directed to a submenu that will allow you to configure the system interrupts. This is only configurable when “Resources Controlled By” is set to “Manual”.

IRQ-5	assigned to PCI Device
IRQ-7	assigned to PCI Device
IRQ-9	assigned to PCI Device
IRQ-10	assigned to PCI Device
IRQ-11	assigned to PCI Device
IRQ-14	assigned to PCI Device

PCI / VGA Palette Snoop

Some old graphic controllers need to “snoop” on the VGA palette and then map it to their display as a way to provide boot information and VGA compatibility. This item allows such snooping to take place.

The Choices: Disabled (default), Enabled

Maximum Payload Size

Set the maximum payload size for Transaction packets (TLP).

The Choice: 4096 (default.), 128, 256, 512, 1024, 2048.

GF7025-M2

8 PC Health Status

■ Figure 8: PC Health Status

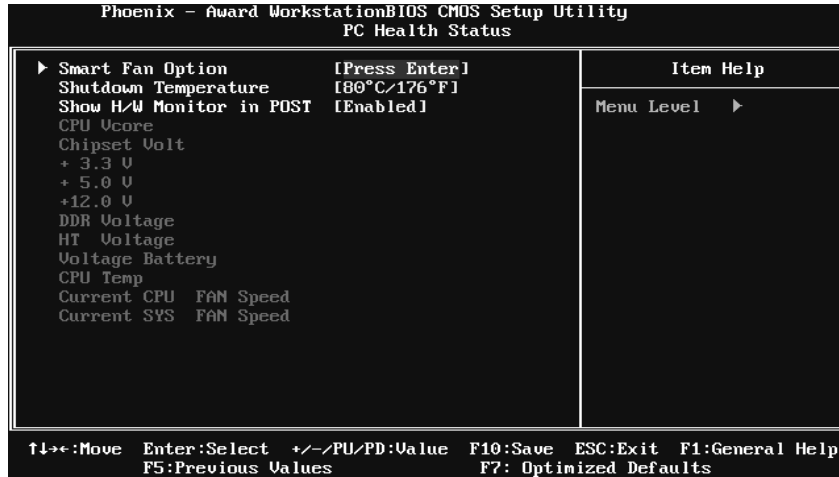

Smart Fan Option

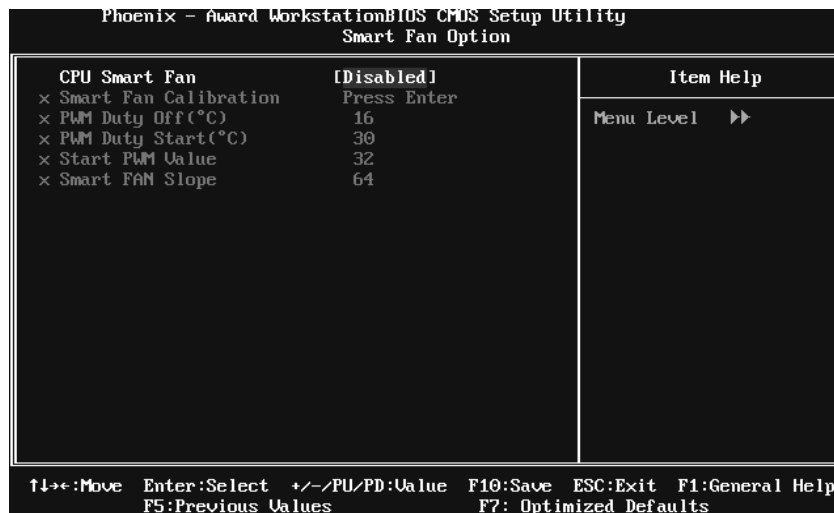

GF7025-M2

CPU Smart Fan

This item allows you to control the CPU Fan.

The Choices: Disabled (default), Auto, 4-pin, 3-pin..

Smart Fan Calibration

Choose this item and then the BIOS will auto test and detect the CPU fan functions and show CPU fan speed.

PWM Duty Off<°C>

If the CPU Temperature is lower than the set value, FAN will turn off.

The Choices: Min=0,.Max=127, Key in a DEC number.

PWM Duty Start<°C>

CPU fan starts to work under smart fan function when arrive this set value.

The Choices: Min=0,.Max=127, Key in a DEC number.

Start PWM Value

When CPU temperature arrives to the set value, the CPU fan will work under Smart Fan Function mode. The range is from 0~127, with an interval of 1.

The Choices: Min=0,.Max=127, Key in a DEC number.

Smart Fan Slope

Increasing the value of slope PWM will raise the speed of CPU fan.

The Choices: Min=1,.Max=127, Key in a DEC number.

Shutdown Temperature

This item allows you to set up the CPU shutdown Temperature. This item is only effective under Windows 98 ACPI mode.

The Choices: Disabled , 60°C / 140°F , 65°C / 149°F , 70°C / 158°F , 75°C / 167°F , 80°C / 176°F (default), 85°C / 185°F , 90°C / 167°F .

Show HW Monitor in POST

If you computer contains a monitoring system, it will show PC health status during POST stage. The item offers several different delay times.

The Choices: Enabled (default), Disabled.

GF7025-M2

CPU Vcore, Chipset Volt, +3.3V, +5.0V, +12.0V, DDR Voltage, HT Voltage, Voltage Battery

Detect the system's voltage status automatically.

CPU Temp

This field displays the current temperature of CPU.

Current CPU FAN Speed

This field displays the current speed of CPU fan.

Current SYS FAN Speed

This field displays the current speed SYSTEM fan.

GF7025-M2

9 Performance Booster Zone

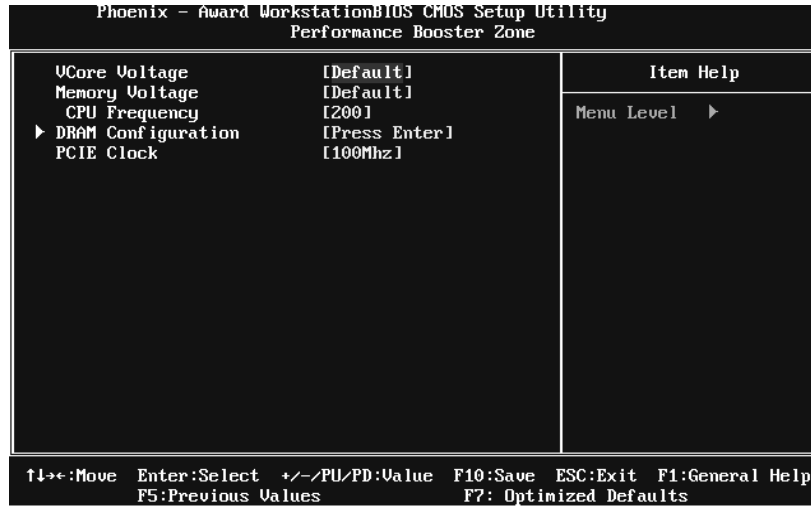

VCore Voltage

This item allows you to adjust the CPU Vcore voltage.
The Choices: Default (default), +3.3%, +6.6%, +10%

Memory Voltage

This item allows you to adjust the memory voltage.
The Choices: Default (default), 2.000V, 2.045V, 2.100V

CPU Frequency

This item allows you to select the CPU Frequency.
The Choices: 200 (default); Min=200, Max=450, Key in a DEC number.

GF7025-M2

DRAM Configuration

Phoenix - Award WorkstationBIOS CMOS Setup Utility		DRAM Configuration	
Timing Mode	[Auto]	Item Help	
x Memory Clock value or Limi	DDR 400	Menu Level	▶
DQS Training Control	[Skip DQS]	Auto, no user limit	
CKE base power down mode	[Enabled]	MaxMemClk, limit by	
CKE based powerdown	[Per Channel]	Memory Clock value	
Memclock tri-stating	[Disabled]		
Memory Hole Remapping	[Enabled]		
Auto Optimize Bottom IO	[Enabled]		
x Bottom of [31:24] IO space	C0		
Bottom of UMA DRAM	[31:24]FC		
↑↓←→:Move Enter:Select +/-/PU/PD:Value F10:Save ESC:Exit F1:General Help F5:Previous Values F7: Optimized Defaults			

Timing Mode

This item allows you to choose to manually or automatically regulate the DDR Timing.

The Choices: Auto (default), MaxMemClk.

Memory Clock Value OR Limi

The Choices: DDR 400 (default), DDR 533, DDR 667, DDR 800.

DQS Training Control

The Choices: Perform DQS, Skip DQS (default).

CKE base power down mode

The Choices: Enabled (default), Disabled.

CKE based power down

The Choices: Per Channel (default), Per CS.

Memclock tri-stating

The Choices: Disabled (default), Enabled.

GF7025-M2

Memory Hole Remapping

The Choices: **Enabled** (default), Disabled.

Auto Optimize Bottom IO

The Choices: **Enabled** (default), Disabled.

Bottom of [31:24] IO space

The Choices: **C0** (default); Min=0000, Max=00FF, key in a HEX number.

Bottom of UMA DRAM [31:24]

The Choices: **FC** (default); Min=0000, Max=00FC, key in a HEX number.

PCIE Clock

This item allows you to select the PCIE clock.

The Choices: **100Mhz** (default), 101Mhz~150Mhz.