

GA-8STXC
P4 Titan-DDR Motherboard

USER'S MANUAL

Pentium® 4 Processor Motherboard

Rev. 1001

12ME-8STXC-1001



WARNING!

Computer motherboards and expansion cards contain very delicate Integrated Circuit (IC) chips. To protect them against damage from static electricity, you should follow some precautions whenever you work on your computer.

1. Unplug your computer when working on the inside.
2. Use a grounded wrist strap before handling computer components. If you do not have one, touch both of your hands to a safely grounded object or to a metal object, such as the power supply case.
3. Hold components by the edges and try not touch the IC chips, leads or connectors, or other components.
4. Place components on a grounded antistatic pad or on the bag that came with the components whenever the components are separated from the system.
5. Ensure that the ATX power supply is switched off before you plug in or remove the ATX power connector on the motherboard.

Installing the motherboard to the chassis...

If the motherboard has mounting holes, but they don't line up with the holes on the base and there are no slots to attach the spacers, do not become alarmed you can still attach the spacers to the mounting holes. Just cut the bottom portion of the spacers (the spacer may be a little hard to cut off, so be careful of your hands). In this way you can still attach the motherboard to the base without worrying about short circuits. Sometimes you may need to use the plastic springs to isolate the screw from the motherboard PCB surface, because the circuit wire may be near by the hole. Be careful, don't let the screw contact any printed circuit write or parts on the PCB that are near the fixing hole, otherwise it may damage the board or cause board malfunctioning.

Chapter 1 Introduction

Features Summary

| | |
|----------------------|--|
| Form Factor | <ul style="list-style-type: none"> • 30.6cm x 24.4cm ATX size form factor, 4 layers PCB |
| CPU | <ul style="list-style-type: none"> • Socket 478 for Intel® Micro FC-PGA2 Pentium® 4 processor • Support Intel® Pentium® 4 (Northwood, 0.13µm) processor • Intel Pentium® 4 400/533MHz FSB • 2nd cache depends on CPU |
| Chipset | <ul style="list-style-type: none"> • SiS 645DX Host/Memory controller • SiS 962L MuTIOL Media I/O |
| Memory | <ul style="list-style-type: none"> • 3 184-pin DDR DIMM sockets • Supports DDR333/DDR266/DDR200 DIMM • Supports Up to 2 un-buffer double-sided DIMM DDR333 or up to 3 un-buffer Double-sided DIMM DDR266/200 • Supports up to 3GB DRAM (Max)(DDR266/200) • Supports only 2.5V DDR DIMM • Supports 64bit ECC type DRAM integrity mode |
| I/O Control | <ul style="list-style-type: none"> • IT8705 |
| Slots | <ul style="list-style-type: none"> • 1 CNR (Communication and Networking Riser) Slot • 1 Universal AGP slot (1X/2X/4X) device support • 5 PCI slot supports 33MHz & PCI 2.2 compliant |
| On-Board IDE | <ul style="list-style-type: none"> • 2 IDE bus master (Dual UDMA33/ATA66/ATA100/ATA133) IDE ports for up to 4 ATAPI devices • Supports PIO mode 3,4 (UDMA 33/ATA66/ATA100/ATA133) IDE & ATAPI CD-ROM |
| On-Board Peripherals | <ul style="list-style-type: none"> • 1 Floppy port supports 2 FDD with 360K, 720K, 1.2M, 1.44M and 2.88M bytes • 1 Parallel port supports Normal/EPP/ECP mode • 2 Serial ports (COMA & COMB) • 6 x USB 2.0/1.1 (2 x Rear,4 x Front by cable) • 1 IrDA connector for IR • 1 Front Audio connector |

to be continued.....

| | |
|---------------------|--|
| Hardware Monitor | <ul style="list-style-type: none"> • CPU/System/Power Fan Revolution detect • CPU Temperature Detect • System Voltage Detect |
| On-Board Sound | <ul style="list-style-type: none"> • Realtek ALC650 CODEC • Line Out / 2 front speaker • Line In / 2 rear speaker (by s/w switch) • Mic In / center & woofer (by s/w switch) • SPDIF out • Line In / Line Out / Mic In / CD In / Game Port |
| On-Board LAN | <ul style="list-style-type: none"> • Built in RTL8100BL Chipset |
| PS/2 Connector | <ul style="list-style-type: none"> • PS/2 Keyboard interface and PS/2 Mouse interface |
| BIOS | <ul style="list-style-type: none"> • Licensed AWARD BIOS, 2M bit Flash ROM • Supports Q-Flash |
| Additional Features | <ul style="list-style-type: none"> • PS/2 Keyboard power on by password • PS/2 Mouse power on • STR (Suspend-To-RAM) • Wake on LAN (WOL) • Wake on Ring (WOR) |



Please set the CPU host frequency in accordance with your processor's specifications. We don't recommend you to set the system bus frequency over the CPU's specification because these specific bus frequencies are not the standard specifications for CPU, chipset and most of the peripherals. Whether your system can run under these specific bus frequencies properly will depend on your hardware configurations, including CPU, Chipsets, SDRAM, Cards...etc.

GA-8STXC Motherboard Layout

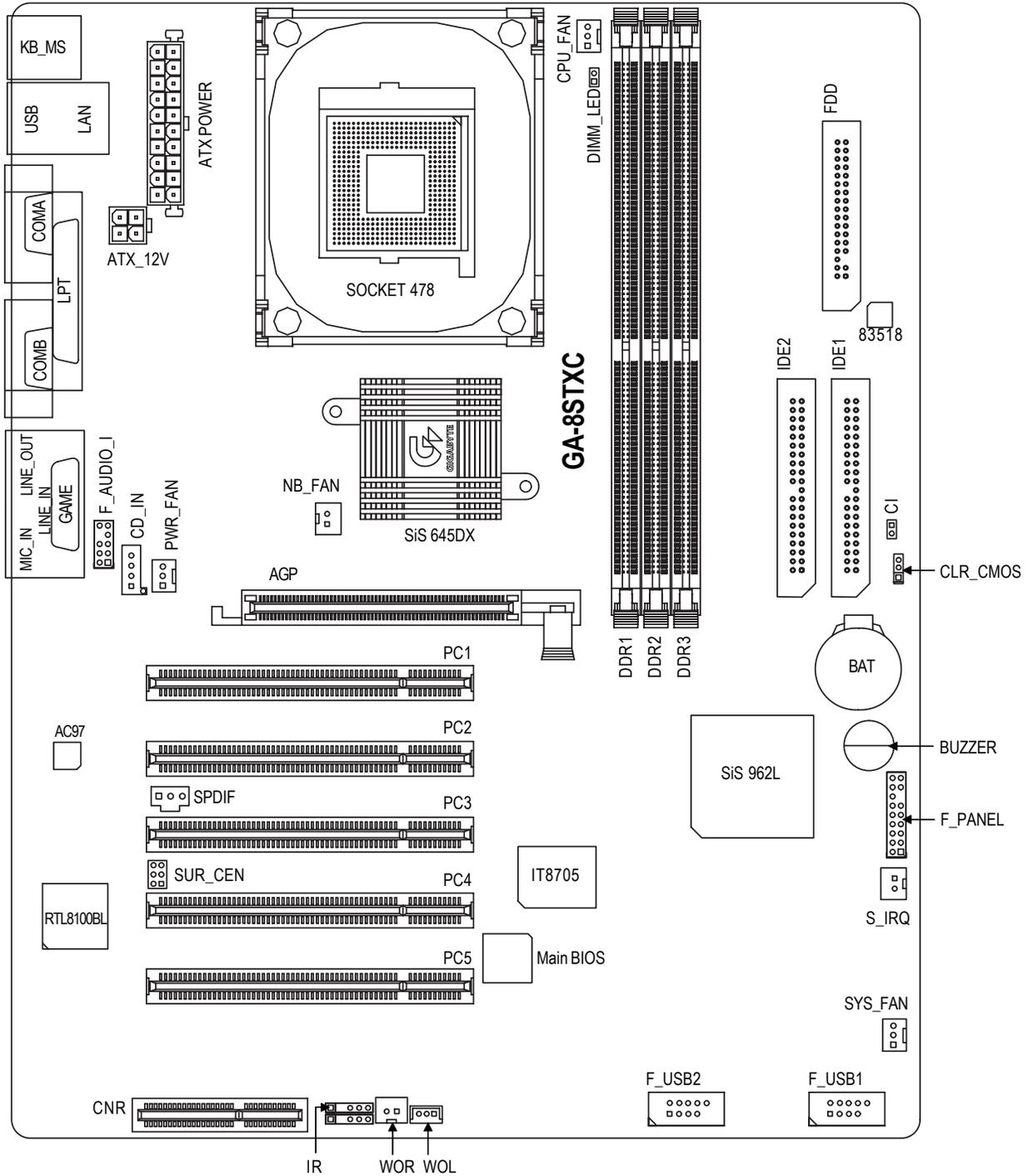

Chapter 2 Hardware Installation Process

To set up your computer, you must complete the following steps:

Step 1- Install the Central Processing Unit (CPU)

Step 2- Install memory modules

Step 3- Install expansion cards

Step 4- Connect ribbon cables, cabinet wires and power supply

Step 5- Setup BIOS software

Step 6- Install supporting software tools

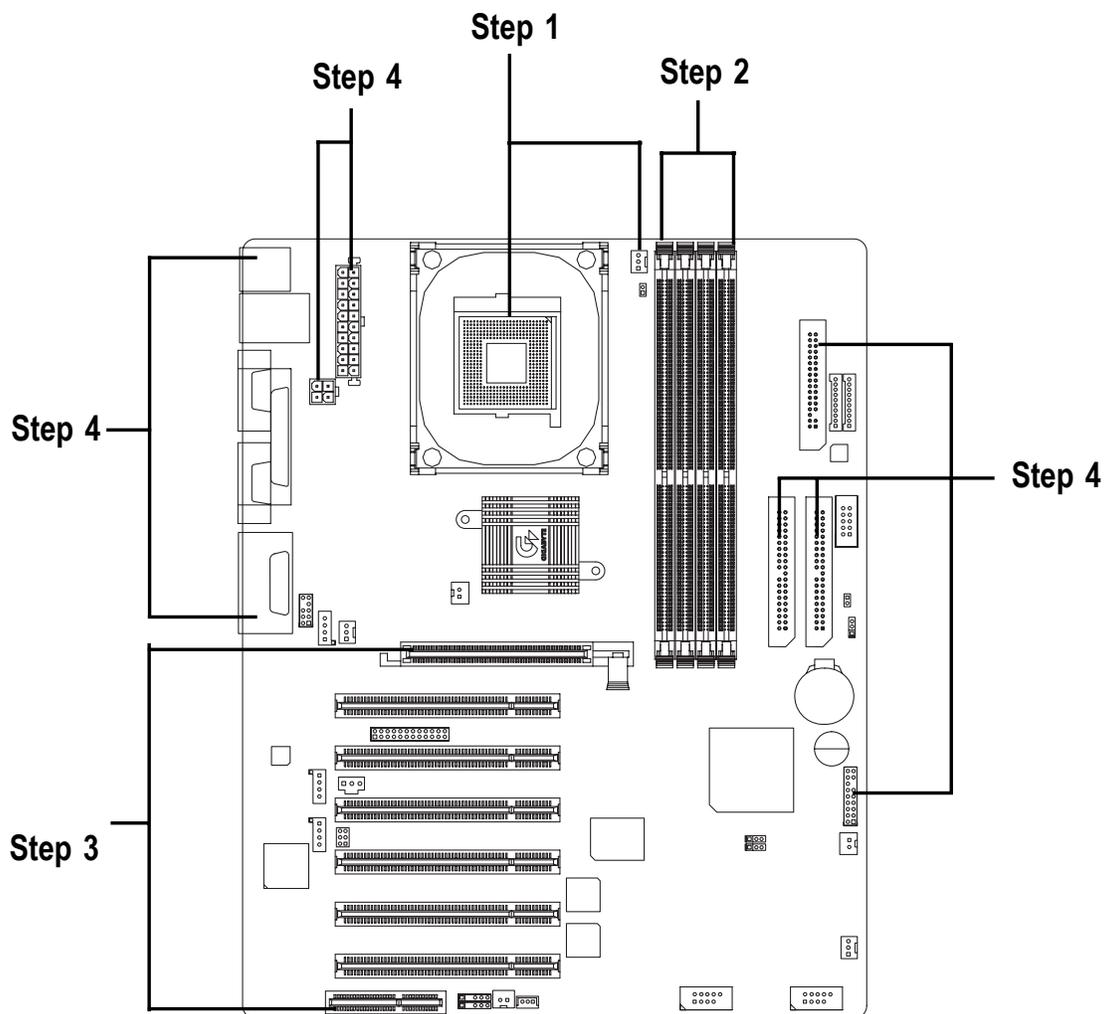

Step 1: Install the Central Processing Unit (CPU)

Step1-1 : CPU Installation



CPU Top View

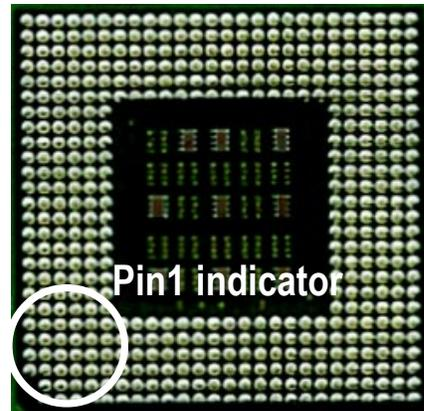

CPU Bottom View

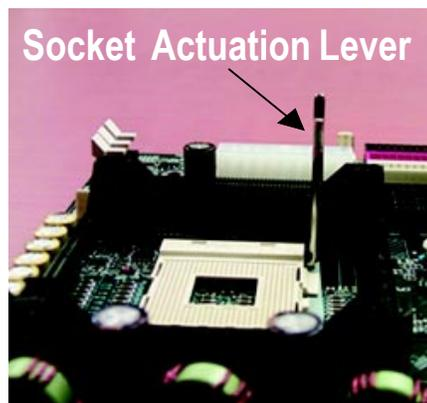

1. Pull up the CPU socket lever and up to 90-degree angle.
3. Press down the CPU socket lever and finish CPU installation.



2. Locate Pin 1 in the socket and look for a (golden) cut edge on the CPU upper corner. Then insert the CPU into the socket.

- ⚠ Please make sure the CPU type is supported by the motherboard.
- ⚠ If you do not match the CPU socket Pin 1 and CPU cut edge well, it will cause improper installation. Please change the insert orientation.

Step1-2 : CPU Heat Sink Installation



1. Hook one end of the cooler bracket to the CPU socket first.

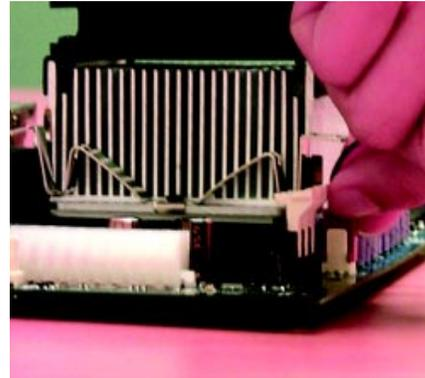

2. Hook the other end of the cooler bracket to the CPU socket.

- ❗ Please use Intel approved cooling fan.
- ❗ We recommend you to apply the thermal tape to provide better heat conduction between your CPU and heatsink.
(The CPU cooling fan might stick to the CPU due to the hardening of the thermal paste. During this condition if you try to remove the cooling fan, you might pull the processor out of the CPU socket along with the cooling fan, and might damage the processor. To avoid this from happening, we suggest you to either use thermal tape instead of thermal paste, or remove the cooling fan with extreme caution.)
- ❗ Make sure the CPU fan power cable is plugged in to the CPU fan connector, this completes the installation.
- ❗ Please refer to CPU heat sink user's manual for more detail installation procedure.

Step 2: Install memory modules

The motherboard has 3 dual inline memory module (DIMM) sockets. The BIOS will automatically detects memory type and size. To install the memory module, just push it vertically into the DIMM socket. The DIMM module can only fit in one direction due to the notch. Memory size can vary between sockets.

Support Unbuffered DDR DIMM Sizes type:

| | | |
|-------------------------|-------------------------|-------------------------|
| 64 Mbit (2Mx8x4 banks) | 64 Mbit (1Mx16x4 banks) | 128 Mbit(4Mx8x4 banks) |
| 128 Mbit(2Mx16x4 banks) | 256 Mbit(8Mx8x4 banks) | 256 Mbit(4Mx16x4 banks) |
| 512 Mbit(16Mx8x4 banks) | 512 Mbit(8Mx16x4 banks) | |

Install memory in any combination table:

| DDR1 (Bank 0&1) | DDR2 (Bank 2&3) | DDR3 (Bank 4&5) |
|-----------------|-----------------|-----------------|
| SS | none | none |
| DS | none | none |
| SS | SS | none |
| DS | SS | none |
| DS | DS | none |
| SS | SS | SS |
| DS | SS | SS |
| DS | DS | SS |
| DS | DS | DS |

SS: Single Side, DS: Double Side

Note:

1. GA-8STXC can only support 4 banks of DDR333.
2. If you mix DDR266 and DDR333 then all modules will run as DDR266.

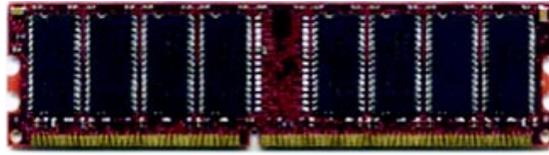

DDR

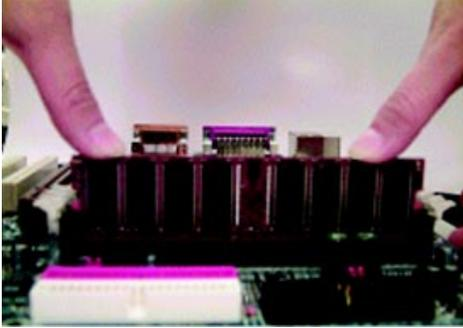

1. The DIMM socket has a notch, so the DIMM memory module can only fit in one direction.
2. Insert the DIMM memory module vertically into the DIMM socket. Then push it down.
3. Close the plastic clip at both edges of the DIMM sockets to lock the DIMM module.

Reverse the installation steps when you wish to remove the DIMM module.

- 🔦 **When STR/DIMM LED is ON, do not install/remove DIMM from socket.**
- 🔦 **Please note that the DIMM module can only fit in one direction due to the one notches. Wrong orientation will cause improper installation. Please change the insert orientation.**

DDR Introduction

Established on the existing SDRAM industry infrastructure, DDR (Double Data Rate) memory is a high performance and cost-effective solution that allows easy adoption for memory vendors, OEMs and system integrators.

DDR memory is a sensible evolutionary solution for the PC industry that builds on the existing SDRAM infrastructure, yet makes awesome advances in solving the system performance bottleneck by doubling the memory bandwidth. DDR SDRAM will offer a superior solution and migration path from existing SDRAM designs due to its availability, pricing and overall market support. PC2100 DDR memory (DDR266) doubles the data rate through reading and writing at both the rising and falling edge of the clock, achieving data bandwidth 2X greater than PC133 when running with the same DRAM clock frequency. With peak bandwidth of 2.1GB per second, DDR memory enables system OEMs to build high performance and low latency DRAM subsystems that are suitable for servers, workstations, high-end PC's and value desktop SMA systems. With a core voltage of only 2.5 Volts compared to conventional SDRAM's 3.3 volts, DDR memory is a compelling solution for small form factor desktops and notebook applications.

Step 3: Install expansion cards

1. Read the related expansion card's instruction document before install the expansion card into the computer.
2. Remove your computer's chassis cover, screws and slot bracket from the computer.
3. Press the expansion card firmly into expansion slot in motherboard.
4. Be sure the metal contacts on the card are indeed seated in the slot.
5. Replace the screw to secure the slot bracket of the expansion card.
6. Replace your computer's chassis cover.
7. Power on the computer, if necessary, setup BIOS utility of expansion card from BIOS.
8. Install related driver from the operating system.

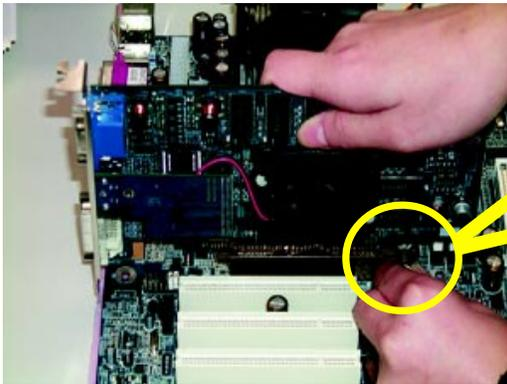

AGP Card



Please carefully pull out the small white-drawable bar at the end of the AGP slot when you try to install / uninstall the AGP card. Please align the AGP card to the onboard AGP slot and press firmly down on the slot. Make sure your AGP card is locked by the small white-drawable bar.

Issues To Beware Of When Installing CNR

Please use standard CNR card like the one in order to avoid mechanical problem.

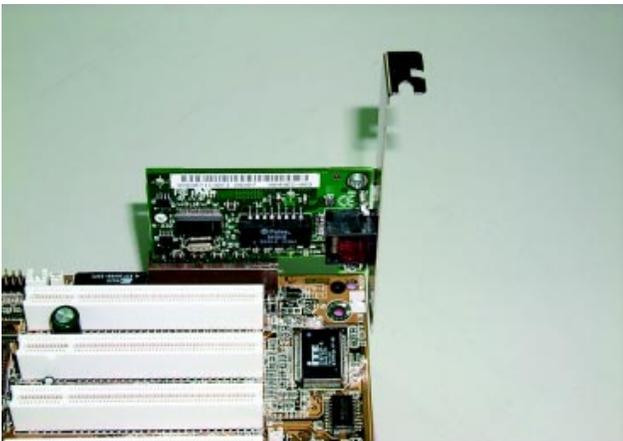

Standard CNR Card

Step 4: Connect ribbon cables, cabinet wires and power supply

Step4-1 : I/O Back Panel Introduction

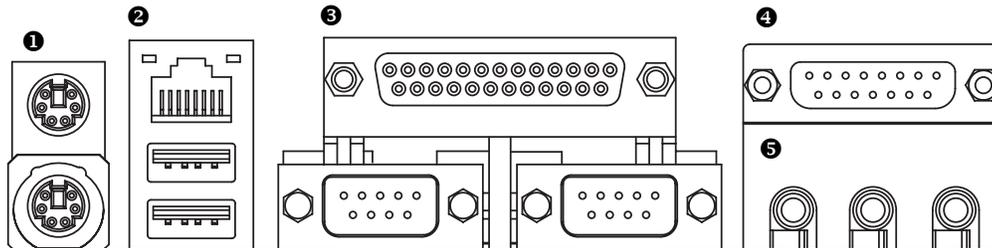

❶ PS/2 Keyboard and PS/2 Mouse Connector

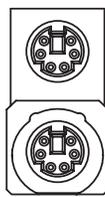

PS/2 Mouse Connector
(6 pin Female)

➤ This connector supports standard PS/2 keyboard and PS/2 mouse.

PS/2 Keyboard Connector
(6 pin Female)

❷ USB / LAN Connector

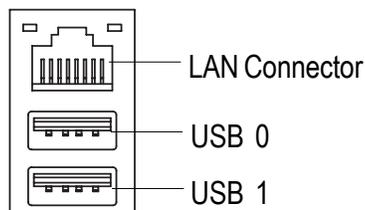

➤ Before you connect your device(s) into USB connector(s), please make sure your device(s) such as USB keyboard, mouse, scanner, zip, speaker...etc. Have a standard USB interface. Also make sure your OS (Win 95 with USB supplement, Win98, Windows 2000, Windows ME, Win NT with SP 6) supports USB controller. If your OS does not support USB controller, please contact OS vendor for possible patch or driver upgrade. For more information please contact your OS or device(s) vendors.

③ Parallel Port and Serial Ports (COMA / COMB)

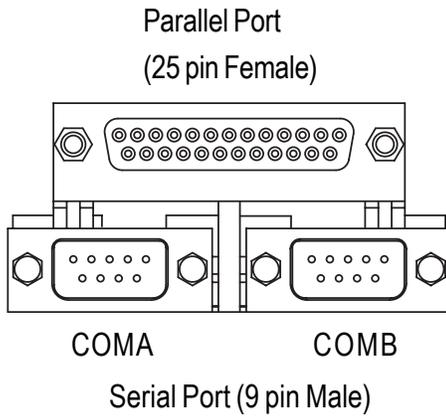

- This connector supports 2 standard COM ports and 1 Parallel port. Device like printer can be connected to Parallel port; mouse and modem etc. can be connected to Serial ports.

④ Game / MIDI Ports

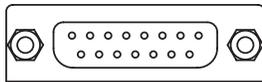

Joystick / MIDI (15 pin Female)

- This connector supports joystick, MIDI keyboard and other relate audio devices.

⑤ Audio Connectors

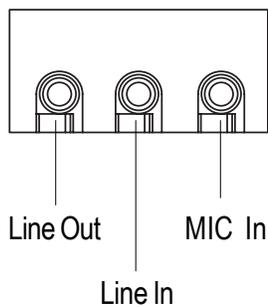

- After install onboard audio driver, you may connect speaker to Line Out jack, microphone to MIC In jack. Device like CD-ROM, walkman etc. can be connected to Line-In jack.

Step 4-2 : Connectors Introduction

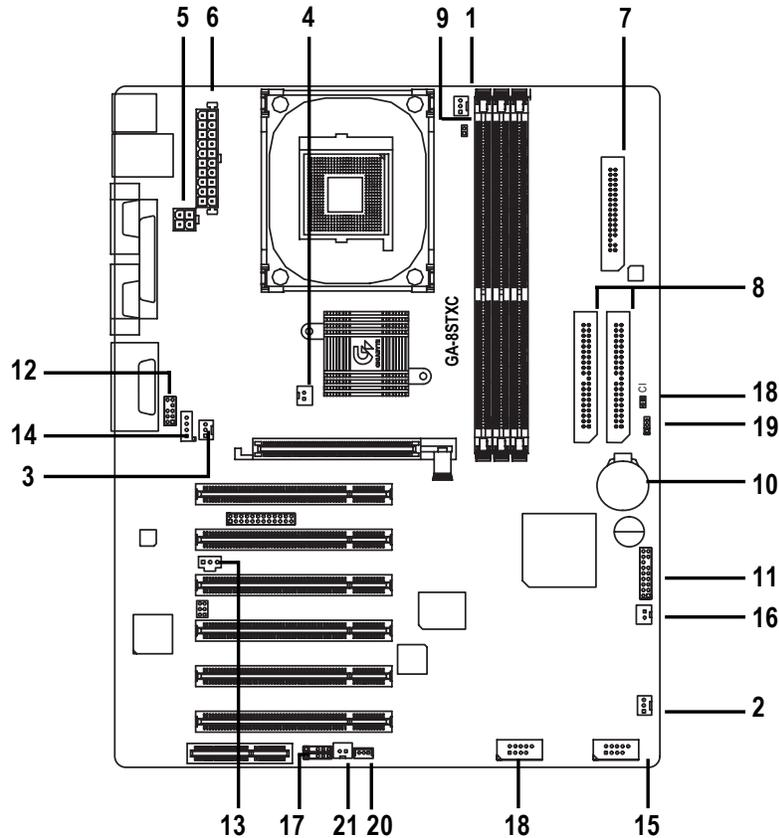

| | |
|---------------------|--------------|
| 1) CPU_FAN | 16) S_IRQ |
| 2) SYS_FAN | 17) IR |
| 3) PWR_FAN | 18) CI |
| 4) NB_FAN | 19) CLR_CMOS |
| 5) ATX_12V | 20) WOL |
| 6) ATX POWER | 21) WOR |
| 7) FDD | |
| 8) IDE1 / IDE2 | |
| 9) DIMM_LED | |
| 10) BAT | |
| 11) F_PANEL | |
| 12) F_AUDIO_I | |
| 13) SPDIF | |
| 14) CD_IN | |
| 15) F_USB1 / F_USB2 | |

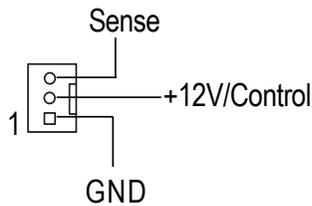
1) CPU_FAN (CPU Fan Connector)

- Please note, a proper installation of the CPU cooler is essential to prevent the CPU from running under abnormal condition or damaged by overheating. The CPU fan connector supports Max. current up to 600 mA.

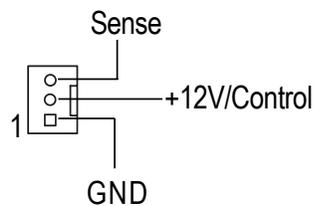
2) SYS_FAN (System Fan Connector)

- This connector allows you to link with the cooling fan on the system case to lower the system temperature.

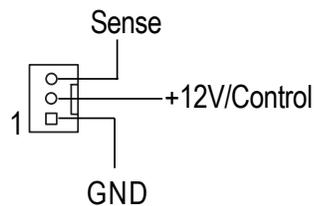
3) PWR_FAN (Power Fan Connector)

- This connector allows you to link with the cooling fan on the system case to lower the power temperature.

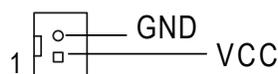
4) NB_FAN (Chip Fan Connector)

- If you installed wrong direction, the Chip Fan will not work. Sometimes will damage the Chip Fan. (Usually black cable is GND)

5) ATX_12V (+12V Power Connector)

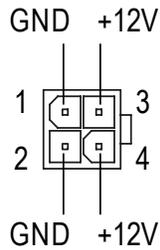

- This connector (ATX +12V) supplies the CPU operation voltage (Vcore). If this "ATX+ 12V connector" is not connected, system cannot boot.

6) ATX POWER (ATX Power Connector)

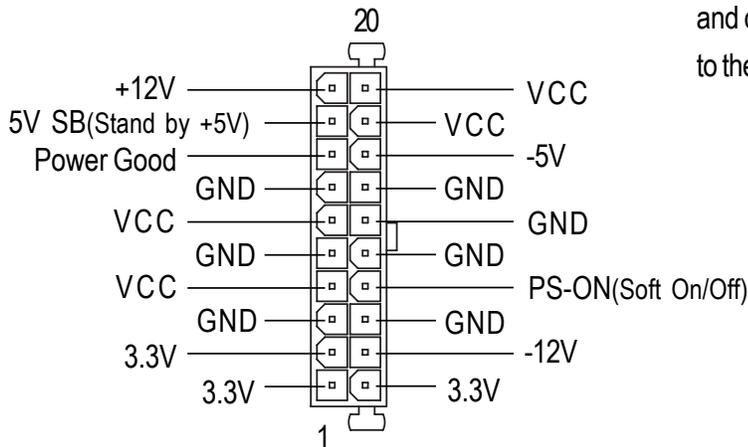

- AC power cord should only be connected to your power supply unit after ATX power cable and other related devices are firmly connected to the motherboard.

7) FDD (Floppy Connector)

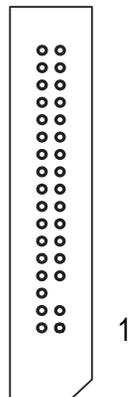

- Please connect the floppy drive ribbon cables to FDD. It supports 360K,12M,1.44M and 2.88M bytes floppy disk types. The red stripe of the ribbon cable must be the same side with the Pin1.

8) IDE1 / IDE2 (IDE1 / IDE2 Connector)

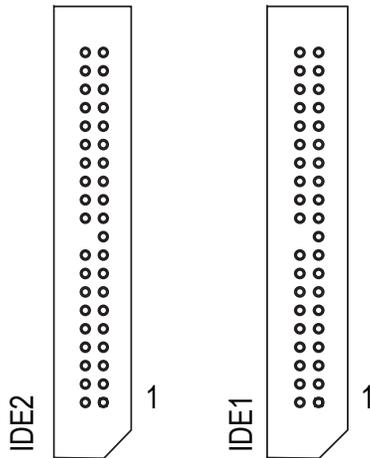

➤ Important Notice:

Please connect first hard disk to IDE1 and connect CD-ROM to IDE2.

The red stripe of the ribbon cable must be the same side with the Pin1.

9) DIMM_LED



- Do not remove memory modules while DIMM LED is on. It might cause short or other unexpected damages due to the 2.5V stand by voltage. Remove memory modules only when STR function is disabled by jumper and AC Power cord is disconnected.

10) BAT (Battery)

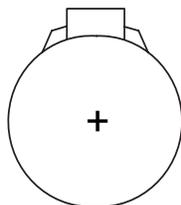

CAUTION

- ❖ Danger of explosion if battery is incorrectly replaced.
- ❖ Replace only with the same or equivalent type recommended by the manufacturer.
- ❖ Dispose of used batteries according to the manufacturer's instructions.

11) F_PANEL (2x9 Pins Connector)

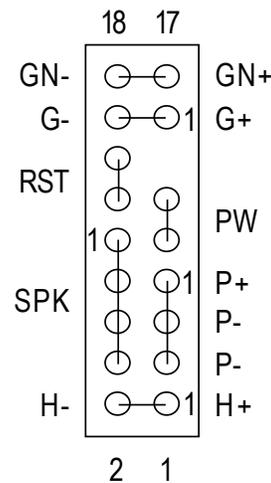

| | |
|------------------------------|---|
| GN (Green Switch) | Open: Normal Operation Close: Entering Green Mode |
| G (Green LED) | Pin 1: LED anode(+) Pin 2: LED cathode(-) |
| H (IDE Hard Disk Active LED) | Pin 1: LED anode(+) Pin 2: LED cathode(-) |
| SPK (Speaker Connector) | Pin 1: VCC(+) Pin 2- Pin 3: NC Pin 4: Data(-) |
| RST (Reset Switch) | Open: Normal Operation Close: Reset Hardware System |
| PW (Soft Power Connector) | Open: Normal Operation Close: Power On/Off |
| P+ / P- / P- (Power LED) | Pin 1: LED anode(+) Pin 2: LED cathode(-) Pin 3: LED cathode(-) |

- Please connect the power LED, PC speaker, reset switch and power switch etc. of your chassis front panel to the F_PANEL connector according to the pin assignment above.

12) F_AUDIO_I (Front Audio Connector)

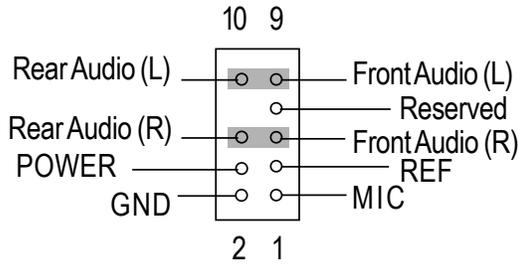

- If you want to use Front Audio connector, you must remove 5-6, 9-10 Jumper.

In order to utilize the front audio header, your chassis must have front audio connector. Also please make sure the pin assignment on the cable is the same as the pin assignment on the MB header. To find out if the chassis you are buying support front audio connector, please contact your dealer.

13) SPDIF (SPDIF)

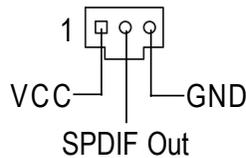

- The SPDIF output is capable of providing digital audio to external speakers or compressed AC3 data to an external Dolby Digital Decoder. Use this feature only when your stereo system has digital input function. 6 Channel output : A "S/PDIF output" connector is available on the motherboard. Please contact your nearest dealer for optional SPDIF cable.

14) CD_IN (CD Audio In Connector)

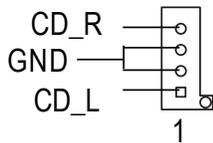

- Connect CD-ROM or DVD-ROM audio out to the connector.

15) F_USB1 / F_USB2 (Front USB Connector)

(F_USB1 & F_USB2 connectors in yellow are for USB 2.0)

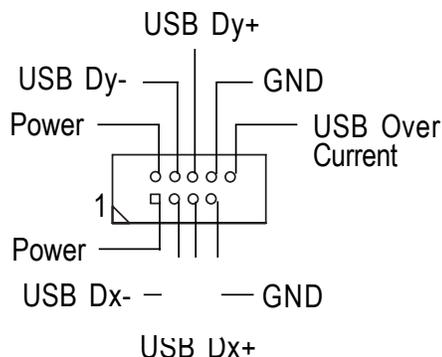

- Be careful with the polarity of the front panel USB connector. Check the pin assignment while you connect the front panel USB cable. Please contact your nearest dealer for optional front panel USB 2.0 cable.

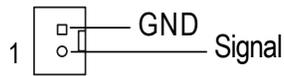
16) S_IRQ (Serial IRQ Connector)

- This connector is for special design, for example: PCMCIA add on card.

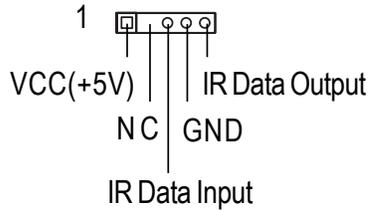
17) IR

- Please make sure that pin 1 on the IR device is align with pin 1 of the connector. To enable the IR function on the board, you are required to purchase an option IR module. For more detail information please contact your nearest dealer for optional IR device.

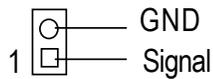
18) CI (CASE OPEN)

- This 2 pin connector allows your system to enable or disable the system alarm if the system case begin remove.

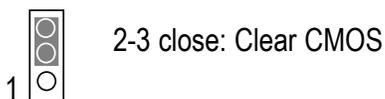
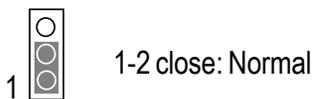
19) CLR_CMOS (Clear CMOS)#

- You may clear the CMOS data to its default values by this jumper. To clear CMOS, temporarily short 1-2 pin.

20) WOL (Wake On Lan)

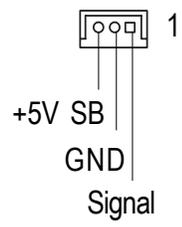

21) WOR (Ring Power On; Internal Modem Card Wake Up)

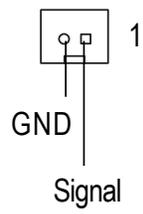

Chapter 3 BIOS Setup

BIOS Setup is an overview of the BIOS Setup Program. The program that allows users to modify the basic system configuration. This type of information is stored in battery-backed CMOS RAM so that it retains the Setup information when the power is turned off.

ENTERING SETUP

Powering ON the computer and pressing immediately will allow you to enter Setup. If you require more advanced BIOS settings, please go to "Advanced BIOS" setting menu. To enter Advanced BIOS setting menu, press "Ctrl+F1" key on the BIOS screen.

CONTROL KEYS

| | |
|----------|---|
| <↑> | Move to previous item |
| <↓> | Move to next item |
| <←> | Move to the item in the left hand |
| <→> | Move to the item in the right hand |
| <Esc> | Main Menu - Quit and not save changes into CMOS Status Page Setup Menu and Option Page Setup Menu - Exit current page and return to Main Menu |
| <+/PgUp> | Increase the numeric value or make changes |
| <-/PgDn> | Decrease the numeric value or make changes |
| <F1> | General help, only for Status Page Setup Menu and Option Page Setup Menu |
| <F2> | Reserved |
| <F3> | Reserved |
| <F4> | Reserved |
| <F5> | Restore the previous CMOS value from CMOS, only for Option Page Setup Menu |
| <F6> | Load the file-safe default CMOS value from BIOS default table |
| <F7> | Load the Optimized Defaults |
| <F8> | Q-Flash function |
| <F9> | Reserved |
| <F10> | Save all the CMOS changes, only for Main Menu |

GETTING HELP

Main Menu

The on-line description of the highlighted setup function is displayed at the bottom of the screen.

Status Page Setup Menu / Option Page Setup Menu

Press F1 to pop up a small help window that describes the appropriate keys to use and the possible selections for the highlighted item. To exit the Help Window press <Esc>.

The Main Menu (For example: BIOS Ver. : F2a)

Once you enter Award BIOS CMOS Setup Utility, the Main Menu (Figure 1) will appear on the screen. The Main Menu allows you to select from eight setup functions and two exit choices. Use arrow keys to select among the items and press <Enter> to accept or enter the sub-menu.

CMOS Setup Utility-Copyright (C) 1984-2002 Award Software

| | |
|-------------------------------|-------------------------|
| ▶Standard CMOS Features | Load Fail-Safe Defaults |
| ▶Advanced BIOS Features | Load Optimized Defaults |
| ▶Integrated Peripherals | Set Supervisor Password |
| ▶Power Management Setup | Set User Password |
| ▶PnP/PCI Configurations | Save & Exit Setup |
| ▶PC Health Status | Exit Without Saving |
| ▶Frequency/Voltage Control | |
| ESC:Quit | ↑↓→←:Select Item |
| F8: Q-Flash | F10:Save & Exit Setup |
| Time, Date, Hard Disk Type... | |

Figure 1: Main Menu

- **Standard CMOS Features**

This setup page includes all the items in standard compatible BIOS.

- **Advanced BIOS Features**

This setup page includes all the items of Award special enhanced features.

- **Integrated Peripherals**
This setup page includes all onboard peripherals.
- **Power Management Setup**
This setup page includes all the items of Green function features.
- **PnP/PCI Configurations**
This setup page includes all the configurations of PCI & PnP ISA resources.
- **PC Health Status**
This setup page is the System auto detect Temperature, voltage, fan, speed.
- **Frequency/Voltage Control**
This setup page is control CPU's clock and frequency ratio.
- **Load Fail-Safe Defaults**
Fail-Safe Defaults indicates the value of the system parameters which the system would be in safe configuration.
- **Load Optimized Defaults**
Optimized Defaults indicates the value of the system parameters which the system would be in best performance configuration.
- **Set Supervisor password**
Change, set, or disable password. It allows you to limit access to the system and Setup, or just to Setup.
- **Set User password**
Change, set, or disable password. It allows you to limit access to the system.
- **Save & Exit Setup**
Save CMOS value settings to CMOS and exit setup.
- **Exit Without Saving**
Abandon all CMOS value changes and exit setup.

Standard CMOS Features

CMOS Setup Utility-Copyright (C) 1984-2002 Award Software

Standard CMOS Features

| | | |
|--|-------------------|--|
| Date (mm:dd:yy) | Fri, May 3 2002 | Item Help |
| Time (hh:mm:ss) | 17:56:23 | Menu Level ► |
| ►IDE Primary Master | None | Change the day, month, year |
| ►IDE Primary Slave | None | |
| ►IDE Secondary Master | None | <Week> |
| ►IDE Secondary Slave | None | Sun. to Sat. |
| Drive A | 1.44M, 3.5 in. | <Month> |
| Drive B | None | Jan. to Dec. |
| Floppy 3 Mode Support | Disabled | <Day> |
| Halt On | All, But Keyboard | 1 to 31 (or maximum allowed in the month) |
| Base Memory | 640K | |
| Extended Memory | 130048K | <Year> |
| Total Memory | 131072K | 1999 to 2098 |
| ↑↓→←: Move Enter:Select +/-/PU/PD:Value F10:Save ESC:Exit F1:General Help F5:Previous Values F6:Fail-Safe Defaults F7:Optimized Defaults | | |

Figure 2: Standard CMOS Features

☞ Date

The date format is <week>, <month>, <day>, <year>.

- Week The week, from Sun to Sat, determined by the BIOS and is display only
- Month The month, Jan. Through Dec.
- Day The day, from 1 to 31 (or the maximum allowed in the month)
- Year The year, from 1999 through 2098

☞ Time

The times format in <hour> <minute> <second>. The time is calculated base on the 24-hour military-time clock. For example, 1 p.m. is 13:00:00.

☞ IDE Primary Master, Slave / IDE Secondary Master, Slave

The category identifies the types of hard disk from drive C to F that has been installed in the computer. There are two types: auto type, and manual type. Manual type is user-definable; Auto type which will automatically detect HDD type.

Note that the specifications of your drive must match with the drive table. The hard disk will not work properly if you enter improper information for this category.

If you select User Type, related information will be asked to enter to the following items. Enter the information directly from the keyboard and press <Enter>. Such information should be provided in the documentation form your hard disk vendor or the system manufacturer.

- ▶▶ CYLS. Number of cylinders
- ▶▶ HEADS Number of heads
- ▶▶ PRECOMP Write precomp
- ▶▶ LANDZONE Landing zone
- ▶▶ SECTORS Number of sectors

If a hard disk has not been installed select NONE and press <Enter>.

☞ Drive A / Drive B

The category identifies the types of floppy disk drive A or drive B that has been installed in the computer.

- ▶▶ None No floppy drive installed
- ▶▶ 360K, 5.25 in. 5.25 inch PC-type standard drive; 360K byte capacity.
- ▶▶ 1.2M, 5.25 in. 5.25 inch AT-type high-density drive; 1.2M byte capacity
(3.5 inch when 3 Mode is Enabled).
- ▶▶ 720K, 3.5 in. 3.5 inch double-sided drive; 720K byte capacity
- ▶▶ 1.44M, 3.5 in. 3.5 inch double-sided drive; 1.44M byte capacity.
- ▶▶ 2.88M, 3.5 in. 3.5 inch double-sided drive; 2.88M byte capacity.

☞ Floppy 3 Mode Support (for Japan Area)

- ▶▶ Disabled Normal Floppy Drive. (Default value)
- ▶▶ Drive A Drive A is 3 mode Floppy Drive.
- ▶▶ Drive B Drive B is 3 mode Floppy Drive.
- ▶▶ Both Drive A & B are 3 mode Floppy Drives.

☞ Halt on

The category determines whether the computer will stop if an error is detected during power up.

- ▶▶ NO Errors The system boot will not stop for any error that may be detected and you will be prompted.
- ▶▶ All Errors Whenever the BIOS detects a non-fatal error the system will be stopped.
- ▶▶ All, But Keyboard The system boot will not stop for a keyboard error; it will stop for all other errors. (Default value)
- ▶▶ All, But Diskette The system boot will not stop for a disk error; it will stop for all other errors.
- ▶▶ All, But Disk/Key The system boot will not stop for a keyboard or disk error; it will stop for all other errors.

☞ Memory

The category is display-only which is determined by POST (Power On Self Test) of the BIOS.

Base Memory

The POST of the BIOS will determine the amount of base (or conventional) memory installed in the system.

The value of the base memory is typically 512 K for systems with 512 K memory installed on the motherboard, or 640 K for systems with 640 K or more memory installed on the motherboard.

Extended Memory

The BIOS determines how much extended memory is present during the POST.

This is the amount of memory located above 1 MB in the CPU's memory address map.

Advanced BIOS Features

CMOS Setup Utility-Copyright (C) 1984-2002 Award Software

Advanced BIOS Features

| | | |
|--|----------|---------------------------------|
| First Boot Device | Floppy | Item Help |
| Second Boot Device | HDD-0 | Menu Level ► |
| Third Boot Device | CDROM | Select Boot Device |
| Boot Up Floppy Seek | Disabled | priority |
| Password Check | Setup | |
| Full Screen logo show | Enabled | |
| | | [Floppy] Boot from floppy |
| | | [LS120] Boot from LS120 |
| | | [HDD-0] Boot from First HDD |
| | | [HDD-1] Boot from second HDD |
| ↑↓→←: Move Enter:Select +/-/PU/PD:Value F10:Save ESC:Exit F1:General Help F5:Previous Values F6:Fail-Safe Defaults F7:Optimized Defaults | | |

Figure 3: Advanced BIOS Features

☞ First / Second / Third Boot Device

- ▶▶ Floppy Select your boot device priority by Floppy.
- ▶▶ LS120 Select your boot device priority by LS120.
- ▶▶ HDD-0~3 Select your boot device priority by HDD-0~3.
- ▶▶ SCSI Select your boot device priority by SCSI.
- ▶▶ CDROM Select your boot device priority by CDROM.
- ▶▶ ZIP Select your boot device priority by ZIP.
- ▶▶ USB-FDD Select your boot device priority by USB-FDD.
- ▶▶ USB-ZIP Select your boot device priority by USB-ZIP.
- ▶▶ USB-CDROM Select your boot device priority by USB-CDROM.
- ▶▶ USB-HDD Select your boot device priority by USB-HDD.
- ▶▶ LAN Select your boot device priority by LAN.
- ▶▶ Disabled Select your boot device priority by Disabled.

☞ **Boot Up Floppy Seek**

During POST, BIOS will determine the floppy disk drive installed is 40 or 80 tracks. 360 K type is 40 tracks 720 K, 1.2 M and 1.44 M are all 80 tracks.

- ▶▶ Enabled BIOS searches for floppy disk drive to determine it is 40 or 80 tracks. Note that BIOS can not tell from 720 K, 1.2 M or 1.44 M drive type as they are all 80tracks.
- ▶▶ Disabled BIOS will not search for the type of floppy disk drive by track number. Note that there will not be any warning message if the drive installed is 360 K. (Default value)

☞ **Password Check**

This feature allows you to limit access to the system and Setup, or just to Setup.

- ▶▶ Setup The system will boot, but access to Setup will be denied if the correct password is not entered at the prompt. (Default value)
- ▶▶ System The system can not boot and can not access to Setup page will be denied if the correct password is not entered at the prompt.

☞ **Full Screen logo show**

- ▶▶ Enabled Fujitsu Siemens logo will be shown during POST. (Default value)
- ▶▶ Disabled Fujitsu Siemens logo will not be shown during POST.

Integrated Peripherals

CMOS Setup Utility-Copyright (C) 1984-2002 Award Software

Integrated Peripherals

| | | |
|---------------------------|----------|-----------------------|
| IDE1 Conductor Cable | Auto | Item Help |
| IDE2 Conductor Cable | Auto | Menu Level ► |
| On-Chip Primary PCI IDE | Enabled | [Auto] |
| On-Chip Secondary PCI IDE | Enabled | Auto-detect IDE |
| AC97 Audio | Enabled | cable type |
| USB Controller | Enabled | |
| USB Legacy Support | Disabled | [ATA66/100] |
| Onboard LAN device | Enabled | Set Conductor cable |
| Init Display First | AGP | to ATA66/100(80-pins) |
| Onboard Serial Port 1 | 3F8/IRQ4 | |
| Onboard Serial Port 2 | 2F8/IRQ3 | [ATA33] |
| UART Mode Select | Normal | Set Conductor cable |
| x UR2 Duplex Mode | Half | to ATA33(40-pins) |
| Onboard Parallel Port | 378/IRQ7 | |
| Parallel Port Mode | SPP | |
| x ECP Mode Use DMA | 3 | |
| Game Port Address | 201 | |
| Midi Port Address | 330 | |
| Midi Port IRQ | 10 | |

↑↓→←: Move Enter:Select +/-/PU/PD:Value F10:Save ESC:Exit F1:General Help
 F5:Previous Values F6:Fail-Safe Defaults F7:Optimized Defaults

Figure 4: Integrated Peripherals

☞ IDE1 Conductor Cable

- ▶▶ Auto Will be automatically detected by BIOS. (Default Value)
- ▶▶ ATA66/100 Set IDE1 Conductor Cable to ATA66/100 (Please make sure your IDE device and cable is compatible with ATA66/100).
- ▶▶ ATA33 Set IDE1 Conductor Cable to ATA33 (Please make sure your IDE device and cable is compatible with ATA33).

☞ IDE2 Conductor Cable

- ▶▶ Auto Will be automatically detected by BIOS. (Default Value)
- ▶▶ ATA66/100 Set IDE2 Conductor Cable to ATA66/100 (Please make sure your IDE device and cable is compatible with ATA66/100).
- ▶▶ ATA33 Set IDE2 Conductor Cable to ATA33 (Please make sure your IDE device and cable is compatible with ATA33).

☞ On-Chip Primary PCI IDE

- ▶▶ Enabled Enable onboard 1st channel IDE port. (Default value)
- ▶▶ Disabled Disable onboard 1st channel IDE port.

☞ On-Chip Secondary PCI IDE

- ▶▶ Enabled Enable onboard 2nd channel IDE port. (Default value)
- ▶▶ Disabled Disable onboard 2nd channel IDE port.

☞ AC97 Audio

- ▶▶ Enabled Enable onboard AC'97 audio function. (Default value)
- ▶▶ Disabled Disable this function.

☞ USB Controller

- ▶▶ Enabled Enable USB Controller. (Default value)
- ▶▶ Disabled Disable USB Controller.

☞ USB Legacy Support

- ▶▶ Enabled Enable USB Legacy Support.
- ▶▶ Disabled Disable USB Legacy Support. (Default value)

☞ Onboard LAN device

- ▶▶ Enabled Realtek LAN is enabled. (Default value)
- ▶▶ Disabled Realtek LAN is disabled.

☞ Init Display First

- ▶▶ AGP Set Init Display First to AGP. (Default value)
- 8PCI Set Display Init First to PCI.

C Onboard Serial Port 1

- ▶▶ Auto BIOS will automatically setup the port 1 address.
- ▶▶ 3F8/IRQ4 Enable onboard Serial port 1 and address is 3F8. (Default value)
- ▶▶ 2F8/IRQ3 Enable onboard Serial port 1 and address is 2F8.
- ▶▶ 3E8/IRQ4 Enable onboard Serial port 1 and address is 3E8.
- ▶▶ 2E8/IRQ3 Enable onboard Serial port 1 and address is 2E8.
- ▶▶ Disabled Disable onboard Serial port 1.

☞ Onboard Serial Port 2

- ▶▶ Auto BIOS will automatically setup the port 2 address.
- ▶▶ 3F8/IRQ4 Enable onboard Serial port 2 and address is 3F8.
- ▶▶ 2F8/IRQ3 Enable onboard Serial port 2 and address is 2F8. (Default value)
- ▶▶ 3E8/IRQ4 Enable onboard Serial port 2 and address is 3E8.
- ▶▶ 2E8/IRQ3 Enable onboard Serial port 2 and address is 2E8.
- ▶▶ Disabled Disable onboard Serial port 2.

☞ UART Mode Select

(This item allows you to determine which Infra Red(IR) function of Onboard I/O chip)

- ▶▶ ASKIR Set onboard I/O chip UART to ASKIR Mode.
- ▶▶ IrDA Set onboard I/O chip UART to IrDA Mode.
- ▶▶ Normal Set onboard I/O chip UART to Normal Mode. (Default Value)

☞ UR2 Duplex Mode

- ▶▶ Half IR Function Duplex Half. (Default Value)
- ▶▶ Full IR Function Duplex Full.

☞ Onboard Parallel port

- ▶▶ 378/IRQ7 Enable onboard LPT port and address is 378/IRQ7. (Default Value)
- ▶▶ 278/IRQ5 Enable onboard LPT port and address is 278/IRQ5.
- ▶▶ Disabled Disable onboard LPT port.
- ▶▶ 3BC/IRQ7 Enable onboard LPT port and address is 3BC/IRQ7.

☞ Parallel Port Mode

- ▶▶ SPP Using Parallel port as Standard Parallel Port. (Default Value)
- ▶▶ EPP Using Parallel port as Enhanced Parallel Port.
- ▶▶ ECP Using Parallel port as Extended Capabilities Port.
- ▶▶ ECP+EPP Using Parallel port as ECP & EPP mode.

☞ ECP Mode Use DMA

- ▶▶ 3 Set ECP Mode Use DMA to 3. (Default Value)
- ▶▶ 1 Set ECP Mode Use DMA to 1.

☞ Game Port Address

- ▶▶ 201 Set Game Port Address to 201. (Default Value)
- ▶▶ 209 Set Game Port Address to 209.
- ▶▶ Disabled Disable this function.

☞ Midi Port Address

- ▶▶ 300 Set Midi Port Address to 300.
- ▶▶ 330 Set Midi Port Address to 330.(Default Value)
- ▶▶ Disabled Disable this function.

☞ Midi Port IRQ

- ▶▶ 5 Set Midi Port IRQ to 5.
- ▶▶ 10 Set Midi Port IRQ to 10. (Default Value)

Power Management Setup

CMOS Setup Utility-Copyright (C) 1984-2002 Award Software

Power Management Setup

| | | |
|--|----------|------------------------|
| ACPI Suspend Type | S1(POS) | Item Help |
| Soft-Off by PWR_BTTN | Off | Menu Level ► |
| System After AC Back | Off | [S1] |
| IRQ [3-7, 9-15], NMI | Enabled | Set suspend type to |
| ModemRingOn/WakeOnLan | Enabled | Power On Suspend under |
| PME Event Wake Up | Disabled | ACPI OS |
| Power On by Keyboard | Password | |
| Power On by Mouse | Disabled | [S3] |
| Resume by Alarm | Disabled | Set suspend type to |
| x Month Alarm | NA | Suspend to RAM under |
| x Day (of Month) | 0 | ACPI OS |
| x Time (hh:nn:ss) | 0 0 0 | |
| Power LED in S1 state | Blinking | |
| ↑↓→←: Move Enter:Select +/-/PU/PD:Value F10:Save ESC:Exit F1:General Help F5:Previous Values F6:Fail-Safe Defaults F7:Optimized Defaults | | |

Figure 5: Power Management Setup

☞ ACPI Suspend Type

- ▶▶ S1(POS) Set ACPI suspend type to S1. (Default Value)
- ▶▶ S3(STR) Set ACPI suspend type to S3.

☞ Soft-off by PWR_BTTN

- ▶▶ Off The user press the power button once, he can turn off the system.
(Default Value)
- ▶▶ Suspend The user press the power button once, then he can enter suspend mode.

☞ System after AC Back

- ▶▶ LastState When AC-power back to the system, the system will return to the Last state
before AC-power off.
- ▶▶ Off When AC-power back to the system, the system will be in "Off" state.
(Default Value)
- ▶▶ On When AC-power back to the system, the system will be in "On" state.

☞ **IRQ [3-7, 9-15], NMI**

- ▶▶ Disabled Disable this function.
- ▶▶ Enabled Enable this function. (Default value)

☞ **ModemRingOn/WakeOnLAN**

- ▶▶ Disabled Disable Modem Ring on/wake on Lan function.
- ▶▶ Enabled Enable Modem Ring on/wake on Lan. (Default Value)

☞ **PME Event Wake Up**

- ▶▶ Disabled Disable this function. (Default Value)
- ▶▶ Enabled Enable PME Event Wake up.

☞ **Power On by Keyboard**

- ▶▶ Password Input password (from 1 to 8 characters) and press Enter to set the Keyboard Power On Password.(Default Value)

☞ **Power On by Mouse**

- ▶▶ Enabled Enable Power On by Mouse function.
- ▶▶ Disabled Disable this function. (Default Value)

☞ **Resume by Alarm**

You can set "Resume by Alarm" item to enabled and key in Data/time to power on system.

- ▶▶ Disabled Disable this function. (Default Value)
- ▶▶ Enabled Enable alarm function to POWER ON system.

If RTC Alarm Lead To Power On is Enabled.

Month Alarm : NA, 1~12

Day (of Month) : 1~31

Time (hh: mm: ss) : (0~23) : (0~59) : (0~59)

☞ **Power LED in S1 state**

- ▶▶ Blinking In standby mode(S1), power LED will blink. (Default Value)
- ▶▶ Dual/Off In standby mode(S1):
 - a. If use single color LED, power LED will turn off.
 - b. If use dual color LED, power LED will turn to another color.

PnP/PCI Configurations

CMOS Setup Utility-Copyright (C) 1984-2002 Award Software

PnP/PCI Configurations

| | | |
|--|------|--------------|
| PCI 4 IRQ Assignment | Auto | Item Help |
| PCI 1/5 IRQ Assignment | Auto | Menu Level ► |
| PCI 2 IRQ Assignment | Auto | |
| PCI 3 IRQ Assignment | Auto | |
| ↑↓→←: Move Enter:Select +/-/PU/PD:Value F10:Save ESC:Exit F1:General Help F5:Previous Values F6:Fail-Safe Defaults F7:Optimized Defaults | | |

Figure 6: PnP/PCI Configurations

☞ PCI 4 IRQ Assignment

- ▶▶ Auto Auto assign IRQ to PCI 4. (Default value)
- ▶▶ 3,4,5,7,9,10,11,12,14,15 Set IRQ 3,4,5,7,9,10,11,12,14,15 to PCI 4.

☞ PCI 1/5 IRQ Assignment

- ▶▶ Auto Auto assign IRQ to PCI 1/5. (Default value)
- ▶▶ 3,4,5,7,9,10,11,12,14,15 Set IRQ 3,4,5,7,9,10,11,12,14,15 to PCI 1/5.

☞ PCI 2 IRQ Assignment

- ▶▶ Auto Auto assign IRQ to PCI 2. (Default value)
- ▶▶ 3,4,5,7,9,10,11,12,14,15 Set IRQ 3,4,5,7,9,10,11,12,14,15 to PCI 2.

☞ PCI 3 IRQ Assignment

- ▶▶ Auto Auto assign IRQ to PCI 3. (Default value)
- ▶▶ 3,4,5,7,9,10,11,12,14,15 Set IRQ 3,4,5,7,9,10,11,12,14,15 to PCI 3.

PC Health Status

CMOS Setup Utility-Copyright (C) 1984-2002 Award Software

PC Health Status

| | | |
|--|----------|-----------|
| VCORE | 1,719 | Item Help |
| VCC18 | 1,776 | |
| +3,3V | 3,232 | |
| +5V | 5,026 | |
| +12V | 11,716 | |
| Current CPU Temperature | 39°C | |
| Current CPU FAN speed | 4336 RPM | |
| CPU Warning Temperature | Disabled | |
| CPU FAN Fail Warning | Disabled | |
| ↑↓→←: Move Enter:Select +/-/PU/PD:Value F10:Save ESC:Exit F1:General Help F5:Previous Values F6:Fail-Safe Defaults F7:Optimized Defaults | | |

Figure 7: PC Health Status

☞ **Current CPU Speed (RPM)**

- ▶▶ Detect CPU/SYSTEM Fan speed status automatically.

☞ **CPU FAN Fail Warning**

- ▶▶ Disabled Fan Warning Function Disable. (Default value)
- ▶▶ Enabled Fan Warning Function Enable.

☞ **CPU Warning Temperature**

- ▶▶ Disabled CPU Temperature Warning function disabled. (Default value)
- ▶▶ 60°C/70°C/80°C/90°C System Warning if CPU Temperature is above

Frequency/Voltage Control

CMOS Setup Utility-Copyright (C) 1984-2002 Award Software

Frequency/Voltage Control

| | | |
|--|-----|--------------|
| CPU Clock Ratio | 10X | Item Help |
| | | Menu Level ► |
| ↑↓→←: Move Enter:Select +/-/PU/PD:Value F10:Save ESC:Exit F1:General Help F5:Previous Values F6:Fail-Safe Defaults F7:Optimized Defaults | | |

Figure 8: Frequency/Voltage Control

🔑 CPU Clock Ratio

This option will not be shown or not be available if you are using a CPU with the locked ratio.

► 10X-24X It's depends on CPU Clock Ratio.

Load Fail-Safe Defaults

CMOS Setup Utility-Copyright (C) 1984-2002 Award Software

| | |
|----------------------------|----------------------------------|
| ▶Standard CMOS Features | Top Performance |
| ▶Advanced Chipset Features | Load Fail-Safe Defaults |
| ▶Integrated Peripherals | Load Optimized Defaults |
| ▶Power Man | Load Fail-Safe Defaults? (Y/N)?Y |
| ▶PnP/PCI C | |
| ▶PC Health Status | Save & Exit Setup |
| ▶Frequency/Voltage Control | Exit Without Saving |
| ESC:Quit | ↑↓→←:Select Item |
| F8: Q-Flash | F10:Save & Exit Setup |
| Load Fail-Safe Defaults | |

Figure 10: Load Fail-Safe Defaults

Load Fail-Safe Defaults

Fail-Safe defaults contain the most appropriate values of the system parameters that allow minimum system performance.

Load Optimized Defaults

CMOS Setup Utility-Copyright (C) 1984-2002 Award Software

| | |
|----------------------------|----------------------------------|
| ▶Standard CMOS Features | Top Performance |
| ▶Advanced BIOS Features | Load Fail-Safe Defaults |
| ▶Integrated Peripherals | Load Optimized Defaults |
| ▶Power M | Load Optimized Defaults? (Y/N)?Y |
| ▶PnP/PCI | |
| ▶PC Health Status | Save & Exit Setup |
| ▶Frequency/Voltage Control | Exit Without Saving |
| ESC:Quit | ↑↓→←:Select Item |
| F8: Q-Flash | F10:Save & Exit Setup |
| Load Optimized Defaults | |

Figure 11: Load Optimized Defaults

Load Optimized Defaults

Selecting this field loads the factory defaults for BIOS and Chipset Features which the system automatically detects.

Set Supervisor/User Password

CMOS Setup Utility-Copyright (C) 1984-2002 Award Software

| | |
|-----------------------------|-------------------------|
| ▶Standard CMOS Features | Top Performance |
| ▶Advanced BIOS Features | Load Fail-Safe Defaults |
| ▶Integrated Peripherals | Load Optimized Defaults |
| ▶Power Management | |
| ▶PnP/PCI Configurations | |
| ▶PC Health Status | Save & Exit Setup |
| ▶Frequency/Voltage Control | Exit Without Saving |
| ESC:Quit | ↑↓→←:Select Item |
| F8: Q-Flash | F10:Save & Exit Setup |
| Change/Set/Disable Password | |

Figure 12: Password Setting

When you select this function, the following message will appear at the center of the screen to assist you in creating a password.

Type the password, up to eight characters, and press <Enter>. You will be asked to confirm the password. Type the password again and press <Enter>. You may also press <Esc> to abort the selection and not enter a password.

To disable password, just press <Enter> when you are prompted to enter password. A message "PASSWORD DISABLED" will appear to confirm the password being disabled. Once the password is disabled, the system will boot and you can enter Setup freely.

The BIOS Setup program allows you to specify two separate passwords:

SUPERVISOR PASSWORD and a USER PASSWORD. When disabled, anyone may access all BIOS Setup program function. When enabled, the Supervisor password is required for entering the BIOS Setup program and having full configuration fields, the User password is required to access only basic items.

If you select "System" at "Password Check" in Advance BIOS Features Menu, you will be prompted for the password every time the system is rebooted or any time you try to enter Setup Menu.

If you select "Setup" at "Password Check" in Advance BIOS Features Menu, you will be prompted only when you try to enter Setup.

Save & Exit Setup

CMOS Setup Utility-Copyright (C) 1984-2002 Award Software

| | |
|----------------------------|-------------------------|
| ▶Standard CMOS Features | Top Performance |
| ▶Advanced BIOS Features | Load Fail-Safe Defaults |
| ▶Integrated Peripherals | Load Optimized Defaults |
| ▶Power Management Setup | Set Supervisor Password |
| ▶PnP/PCI C | |
| ▶PC Health | |
| ▶Frequency/Voltage Control | Exit Without Saving |
| ESC:Quit | ↑↓→←:Select Item |
| F8: Q-Flash | F10:Save & Exit Setup |
| Save Data to CMOS | |

Figure 13: Save & Exit Setup

Type "Y" will quit the Setup Utility and save the user setup value to RTC CMOS.

Type "N" will return to Setup Utility.

Exit Without Saving

CMOS Setup Utility-Copyright (C) 1984-2002 Award Software

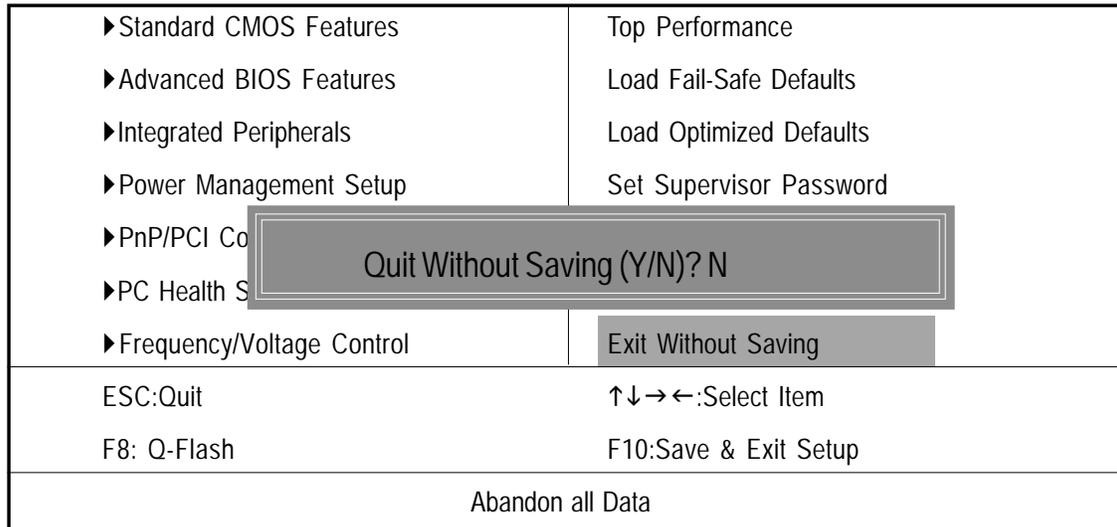

Figure 14: Exit Without Saving

Type "Y" will quit the Setup Utility without saving to RTC CMOS.

Type "N" will return to Setup Utility.