

G7V600-B

System Board User's Manual

935-G7V601-000G
A90300603

Copyright

This publication contains information that is protected by copyright. No part of it may be reproduced in any form or by any means or used to make any transformation/adaptation without the prior written permission from the copyright holders.

This publication is provided for informational purposes only. The manufacturer makes no representations or warranties with respect to the contents or use of this manual and specifically disclaims any express or implied warranties of merchantability or fitness for any particular purpose. The user will assume the entire risk of the use or the results of the use of this document. Further, the manufacturer reserves the right to revise this publication and make changes to its contents at any time, without obligation to notify any person or entity of such revisions or changes.

© 2006. All Rights Reserved.

Trademarks

Product names or trademarks appearing in this manual are for identification purpose only and are the properties of the respective owners.

FCC and DOC Statement on Class B

This equipment has been tested and found to comply with the limits for a Class B digital device, pursuant to Part 15 of the FCC rules. These limits are designed to provide reasonable protection against harmful interference when the equipment is operated in a residential installation. This equipment generates, uses and can radiate radio frequency energy and, if not installed and used in accordance with the instruction manual, may cause harmful interference to radio communications. However, there is no guarantee that interference will not occur in a particular installation. If this equipment does cause harmful interference to radio or television reception, which can be determined by turning the equipment off and on, the user is encouraged to try to correct the interference by one or more of the following measures:

- Reorient or relocate the receiving antenna.
- Increase the separation between the equipment and the receiver.
- Connect the equipment into an outlet on a circuit different from that to which the receiver is connected.
- Consult the dealer or an experienced radio TV technician for help.

Notice:

1. The changes or modifications not expressly approved by the party responsible for compliance could void the user's authority to operate the equipment.
2. Shielded interface cables must be used in order to comply with the emission limits.

Table of Contents

About this Manual.....	5
Warranty.....	5
Static Electricity Precaution.....	6
Safety Measures.....	6
About the Package.....	7
Before Using the System Board.....	7
Chapter 1 - Introduction.....	8
Specifications.....	8
Special Features of the System Board.....	11
Chapter 2 - Hardware Installation.....	15
System Board Layout	15
System Memory.....	16
CPU.....	18
Jumper Settings.....	23
Rear Panel I/O Ports.....	29
I/O Connectors.....	38
Chapter 3 - BIOS Setup.....	56
Award BIOS Setup Utility.....	56
Updating the BIOS.....	96
Chapter 4 - Supported Softwares.....	98
Drivers, Utilities and Software Applications.....	98
Installation Notes.....	114
Appendix A - Enabling Hyper-Threading Technology.....	115
Appendix B - Watchdog Timer.....	118
Appendix C - System Error Messages.....	119
POST Beep.....	119
Error Messages.....	119
Appendix D - Troubleshooting.....	121
Troubleshooting Checklist.....	121

About this Manual

An electronic file of this manual is included in the CD. To view the user's manual in the CD, insert the CD into a CD-ROM drive. The autorun screen (Main Board Utility CD) will appear. Click "User's Manual" on the main menu.

Warranty

1. Warranty does not cover damages or failures that arised from misuse of the product, inability to use the product, unauthorized replacement or alteration of components and product specifications.
2. The warranty is void if the product has been subjected to physical abuse, improper installation, modification, accidents or unauthorized repair of the product.
3. Unless otherwise instructed in this user's manual, the user may not, under any circumstances, attempt to perform service, adjustments or repairs on the product, whether in or out of warranty. It must be returned to the purchase point, factory or authorized service agency for all such work.
4. We will not be liable for any indirect, special, incidental or consequential damages to the product that has been modified or altered.

Static Electricity Precautions

It is quite easy to inadvertently damage your PC, system board, components or devices even before installing them in your system unit. Static electrical discharge can damage computer components without causing any signs of physical damage. You must take extra care in handling them to ensure against electrostatic build-up.

1. To prevent electrostatic build-up, leave the system board in its anti-static bag until you are ready to install it.
2. Wear an antistatic wrist strap.
3. Do all preparation work on a static-free surface.
4. Hold the device only by its edges. Be careful not to touch any of the components, contacts or connections.
5. Avoid touching the pins or contacts on all modules and connectors. Hold modules or connectors by their ends.



Important:

Electrostatic discharge (ESD) can damage your processor, disk drive and other components. Perform the upgrade instruction procedures described at an ESD workstation only. If such a station is not available, you can provide some ESD protection by wearing an antistatic wrist strap and attaching it to a metal part of the system chassis. If a wrist strap is unavailable, establish and maintain contact with the system chassis throughout any procedures requiring ESD protection.

Safety Measures

To avoid damage to the system:

- Use the correct AC input voltage range.

To reduce the risk of electric shock:

- Unplug the power cord before removing the system chassis cover for installation or servicing. After installation or servicing, cover the system chassis before plugging the power cord.

Battery:

- Danger of explosion if battery incorrectly replaced.
- Replace only with the same or equivalent type recommend by the manufacturer.
- Dispose of used batteries according to the battery manufacturer's instructions.

About the Package

The system board package contains the following items. If any of these items are missing or damaged, please contact your dealer or sales representative for assistance.

- ☑ The system board
- ☑ A user's manual
- ☑ One 40-pin IDE cable
- ☑ One FDD cable
- ☑ One Serial ATA data cable
- ☑ One Serial ATA power cable
- ☑ One bracket mounted with 2 USB ports
- ☑ One bracket mounted with 1 COM port
- ☑ One I/O shield
- ☑ One "Main Board Utility" CD

The system board and accessories in the package may not come similar to the information listed above. This may differ in accordance to the sales region or models in which it was sold. For more information about the standard package in your region, please contact your dealer or sales representative.

Before Using the System Board

Before using the system board, prepare basic system components.

If you are installing the system board in a new system, you will need at least the following internal components.

- A CPU
- Memory module
- Storage devices such as hard disk drive, CD-ROM, etc.

You will also need external system peripherals you intend to use which will normally include at least a keyboard, a mouse and a video display monitor.

Chapter I - Introduction

Specifications

Processor	Intel® Pentium® 4 Prescott processor - Hyper-Threading Technology - 800MHz/533MHz system data bus Processor socket: Socket 775
Chipset	Intel® chipset - Intel® 915GV Express chipset - Intel® 82801FB I/O Controller Hub (ICH6)
System Memory	Four 184-pin DDR SDRAM DIMM sockets Supports dual channel (128-bit wide) memory interface Unbuffered PC3200 (DDR400) or PC2700 (DDR333) DDR SDRAM DIMM Supports maximum of 4GB system memory up to 512Mbit technology for x8 and x16 devices, non-ECC memory
BIOS	Award BIOS 4Mbit flash memory
Energy Efficient Design	Supports ACPI specification and OS Directed Power Management Supports ACPI STR (Suspend to RAM) function Wake-On-Events include: - Wake-On-PS/2 Keyboard/Mouse - Wake-On-USB Keyboard/Mouse - Wake-On-Ring - Wake-On-LAN - RTC timer to power-on the system System power management supported CPU stopped clock control Microsoft®/Intel® APM 1.2 compliant Soft Power supported - ACPI v1.0b specification AC power failure recovery
Damage Free Intelligence	Monitors CPU/system temperature and overheat alarm Monitors 1.5V/3.3V/VCCP/VTT voltages and failure alarm Monitors fan speed and failure alarm Read back capability that displays temperature, voltage and fan speed Watchdog timer function

Graphics	<p>Graphics memory</p> <ul style="list-style-type: none"> - Shares 1MB/8MB of the system memory in DOS mode - Uses Dynamic Video Memory Technology (DVMT) in Windows mode <p>Graphics controller</p> <ul style="list-style-type: none"> - Core frequency of 333MHz - 400MHz integrated 24-bit RAMDAC - Analog display up to 2048x1536 @ 85Hz refresh - High quality 3D setup and render engine - Discrete, Triangles, Strips and fans - Hardware Pixel Shader 2.0 - Supports D3D and OGL pixelization rules - Per pixel perspective corrected texture mapping - 533 MegaTexel/sec performance, 266 Mpixels/sec fill rate up to two bilinear textures <p>2D graphics features</p> <ul style="list-style-type: none"> - Optimized 256-bit BLT engine - 32-bit alpha blended cursor - Programmable 3-color transparent cursor <p>3D graphics features</p> <ul style="list-style-type: none"> - Supports maximum 3D resolution: 1600x1200x32 @ 85Hz - Flat and Gouraud shading - 16- and 24-bit Z-buffering and 8-bit Stencil buffering - Vertex and programmable pixel fog and atmospheric effects - Supports Double and triple render buffer
Audio	<p>Realtek ALC655</p> <p>18-bit stereo full-duplex codec with independent variable sampling rate</p> <p>High quality differential CD input</p> <p>True stereo line level outputs</p> <p>S/PDIF-in/out interface</p> <p>5.1-channel audio output</p>
LAN	<p>Marvell 88E8053 Gigabit ethernet controller</p> <p>Supports 10Mbps, 100Mbps and 1Gbps data transmission</p> <p>IEEE 802.3 (10/100Mbps) and IEEE 802.3ab (1Gbps) compliant</p>
Serial ATA	<p>Supports four Serial ATA (SATA) interfaces which are compliant with SATA 1.0 specification (1.5Gbps interface)</p>
IDE	<p>Supports up to UltraDMA 100Mbps hard drives</p> <p>PIO Mode 4 Enhanced IDE (data transfer rate up to 14MB/sec.)</p>

Rear Panel I/O Ports	<ul style="list-style-type: none"> 1 mini-DIN-6 PS/2 mouse port 1 mini-DIN-6 PS/2 keyboard port 1 DB-25 parallel port 1 DB-9 serial port 1 DB-15 VGA port 1 RJ45 LAN port 4 USB 2.0/1.1 ports Mic-in, line-in and line-out
I/O Connectors	<ul style="list-style-type: none"> 2 connectors for 4 additional external USB 2.0/1.1 ports 1 connector for 1 external COM port 1 front audio connector for external line-out and mic-in jacks 1 CD-in internal audio connector 1 S/PDIF-in/out connector 1 connector for IrDA interface 4 Serial ATA connectors 1 40-pin IDE connector 1 floppy connector 1 24-pin ATX power connector 1 4-pin ATX 12V power connector 1 front panel connector 5 fan connectors
Expansion Slots	<ul style="list-style-type: none"> 7 PCI slots 1 PCI Express x1 slot
Compatibility	PCI 2.2 and AC '97 compliant
PCB	<ul style="list-style-type: none"> 4 layers, ATX form factor 30.48cm (12") × 24.4cm (9.6")

Features

WATCHDOG TIMER

The Watchdog Timer function allows your application to regularly “clear” the system at the set time interval. If the system hangs or fails to function, it will reset at the set time interval so that your system will continue to operate.

HYPER-THREADING TECHNOLOGY

The system board supports Intel processors with Hyper-Threading Technology. Enabling the functionality of Hyper-Threading Technology for your computer system requires **ALL** of the following platforms.

Components:

- CPU - an Intel® Pentium® 4 Processor with HT Technology
- Chipset - an Intel® chipset that supports HT Technology
- BIOS - a BIOS that supports HT Technology and has it enabled
- OS - an operating system that includes optimizations for HT Technology

Please refer to Appendix A for information about enabling the functionality of the Hyper-Threading Technology. For more information on Hyper-Threading Technology, go to: www.intel.com/info/hyperthreading.

DDR

Double Data Rate SDRAM (DDR SDRAM) is a type of SDRAM that doubles the data rate through reading and writing at both the rising and falling edge of each clock. This effectively doubles the speed of operation therefore doubling the speed of data transfer.

5.1-CHANNEL AUDIO

The audio jacks at the rear panel will support 6-channel audio only when the audio utility is configured to support this function. The mic-in at the rear will be disabled. Use the front audio's mic-in jack.

S/PDIF

S/PDIF is a standard audio file transfer format that transfers digital audio signals to a device without having to be converted first to an analog format. This prevents the quality of the audio signal from degrading whenever it is converted to analog. S/PDIF is usually found on digital audio equipment such as a DAT machine or audio processing device. The S/PDIF connector on the system board sends surround sound and 3D audio signal outputs to amplifiers and speakers and to digital recording devices like CD recorders.

SERIAL ATA

Serial ATA is a storage interface that is compliant with SATA 1.0 specification. With speed of up to 1.5Gbps, it improves hard drive performance faster than the standard parallel ATA whose data transfer rate is 100MB/s.

IRDA

The system board is equipped with an IrDA connector for wireless connectivity between your computer and peripheral devices. The IRDA (Infrared Data Association) specification supports data transfers of 115K baud at a distance of 1 meter.

USB

The system board supports USB 2.0 and USB 1.1 ports. USB 1.1 supports 12Mb/second bandwidth while USB 2.0 supports 480Mb/second bandwidth providing a marked improvement in device transfer speeds between your computer and a wide range of simultaneously accessible external Plug and Play peripherals.

WAKE-ON-LAN

This feature allows the network to remotely wake up a Soft Power Down (Soft-Off) PC. It is supported via the onboard LAN port or via a PCI LAN card that uses the PCI PME (Power Management Event) signal. However, if your system is in the Suspend mode, you can power-on the system only through an IRQ or DMA interrupt.

**Important:**

The 5VSB power source of your power supply must support $\geq 720\text{mA}$.

WAKE-ON-RING

This feature allows the system that is in the Suspend mode or Soft Power Off mode to wake-up/power-on to respond to calls coming from an external modem or respond to calls from a modem PCI card that uses the PCI PME (Power Management Event) signal to remotely wake up the PC.

**Important:**

If you are using a modem add-in card, the 5VSB power source of your power supply must support a minimum of $\geq 720\text{mA}$.

WAKE-ON-PS/2

This function allows you to use the PS/2 keyboard or PS/2 mouse to power-on the system.

**Important:**

The 5VSB power source of your power supply must support $\geq 720\text{mA}$.

WAKE-ON-USB

This function allows you to use a USB keyboard or USB mouse to wake up a system from the S3 (STR - Suspend To RAM) state.

**Important:**

If you are using the Wake-On-USB Keyboard/Mouse function for 2 USB ports, the 5VSB power source of your power supply must support $\geq 1.5\text{A}$. For 3 or more USB ports, the 5VSB power source of your power supply must support $\geq 2\text{A}$.

RTC TIMER

The RTC installed on the system board allows your system to automatically power-on on the set date and time.

POWER FAILURE RECOVERY

When power returns after an AC power failure, you may choose to either power-on the system manually or let the system power-on automatically.

STR

The system board is designed to meet the ACPI (Advanced Configuration and Power Interface) specification. ACPI has energy saving features that enables PCs to implement Power Management and Plug-and-Play with operating systems that support OS Direct Power Management. Currently, only Windows® 98/2000/ME/XP supports the ACPI function. ACPI when enabled in the Power Management Setup will allow you to use the Suspend to RAM function.

With the Suspend to RAM function enabled, you can power-off the system at once by pressing the power button or selecting “Standby” when you shut down Windows® 98/2000/ME/XP without having to go through the sometimes tiresome process of closing files, applications and operating system. This is because the system is capable of storing all programs and data files during the entire operating session into RAM (Random Access Memory) when it powers-off. The operating session will resume exactly where you left off the next time you power-on the system.

**Important:**

The 5VSB power source of your power supply must support $\geq 1A$.

Chapter 2 - Hardware Installation

System Board Layout

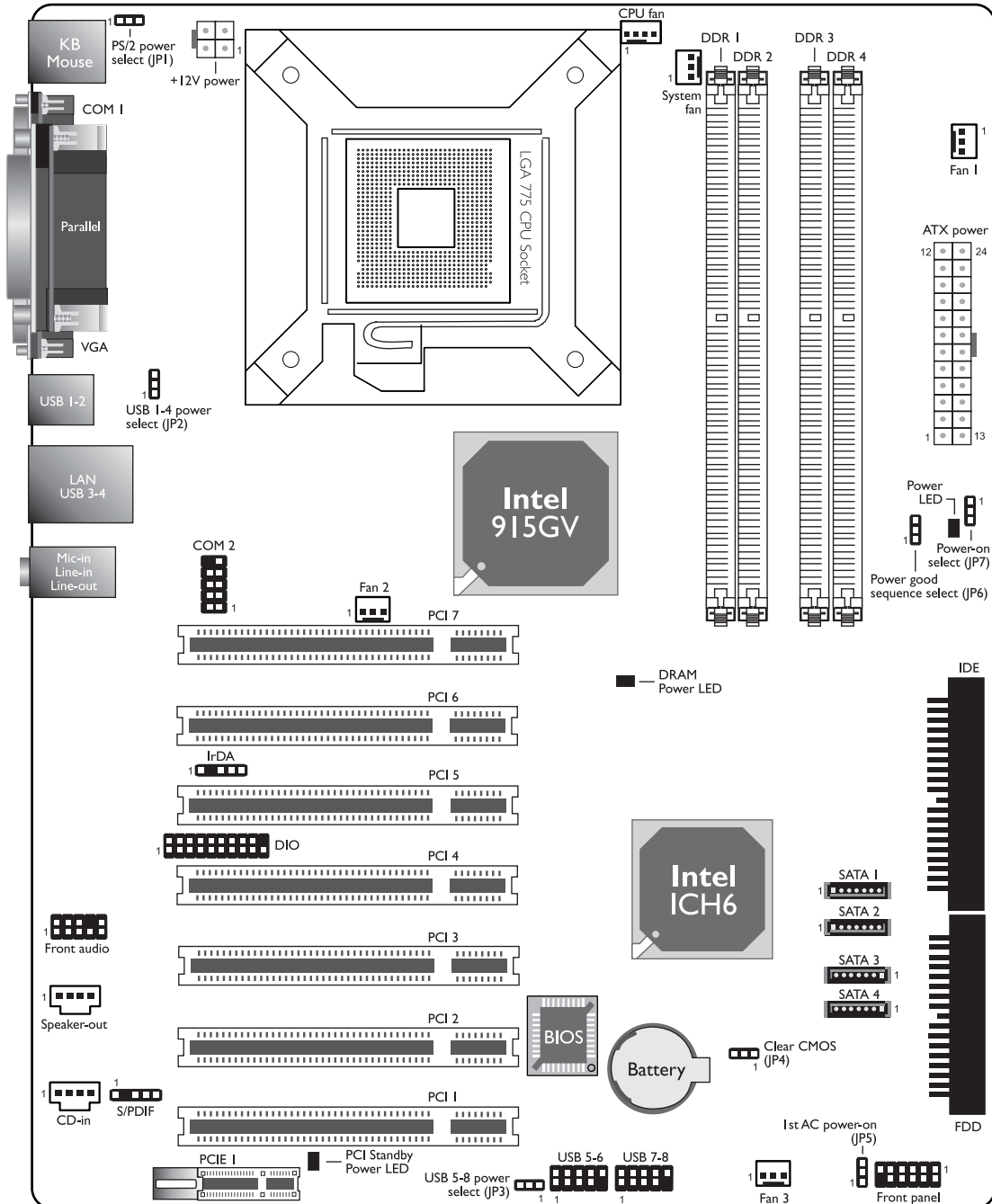

**Warning:**

Electrostatic discharge (ESD) can damage your system board, processor, disk drives, add-in boards, and other components. Perform the upgrade instruction procedures described at an ESD workstation only. If such a station is not available, you can provide some ESD protection by wearing an antistatic wrist strap and attaching it to a metal part of the system chassis. If a wrist strap is unavailable, establish and maintain contact with the system chassis throughout any procedures requiring ESD protection.

System Memory

**Warning:**

When the DRAM Power LED lit red, it indicates that power is present on the DDR sockets. Power-off the PC then unplug the power cord prior to installing any memory modules. Failure to do so will cause severe damage to the motherboard and components.

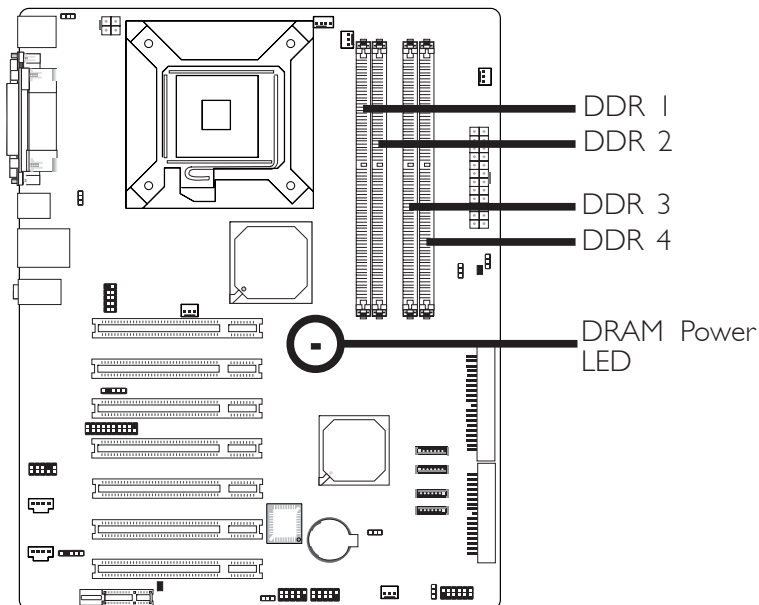

The system board supports DDR SDRAM DIMM. Double Data Rate SDRAM (DDR SDRAM) is a type of SDRAM that doubles the data rate through reading and writing at both the rising and falling edge of each clock. This effectively doubles the speed of operation therefore doubling the speed of data transfer. Refer to chapter 1 (System Memory section) for detailed specification of the memory supported by the system board.

The four DDR DIMM sockets on the system board are divided into 2 channels:

Channel A - DDR 1 and DDR 2

Channel B - DDR 3 and DDR 4

The system board supports the following memory interface.

Single Channel (SC)

Data will be accessed in chunks of 64 bits (8B) from the memory channels.

Dual Channel (DC)

Data will be accessed in chunks of 128 bits from the memory channels. Dual channel provides better system performance because it doubles the data transfer rate.

Single Channel	<ul style="list-style-type: none">• DIMMs are on the same channel.• DIMMs in a channel can be identical or completely different. However, we highly recommend using identical DIMMs.• Not all slots need to be populated.
Dual Channel	<ul style="list-style-type: none">• DIMMs of the same memory configuration are on different channels.

BIOS Setting

Configure the system memory in the Advanced Chipset Features submenu of the BIOS.

Installing the DIMM

A DIMM simply snaps into a DIMM socket on the system board. Pin 1 of the DIMM must correspond with Pin 1 of the socket.

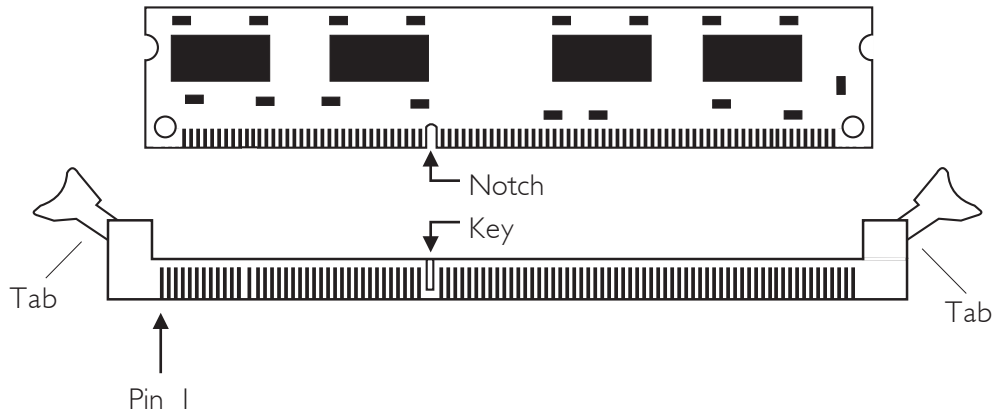

1. Pull the “tabs” which are at the ends of the socket to the side.
2. Position the DIMM above the socket with the “notch” in the module aligned with the “key” on the socket.
3. Seat the module vertically into the socket. Make sure it is completely seated. The tabs will hold the DIMM in place.

CPU

Overview

The system board is equipped with a surface mount LGA 775 socket. This socket is exclusively designed for installing a LGA 775 packaged Prescott CPU.



Important:

- 1. Before you proceed, make sure (1) the LGA775 socket comes with a protective cap, (2) the cap is not damaged and (3) the socket's contact pins are not bent. If the cap is missing or the cap and/or contact pins are damaged, contact your dealer immediately.*
- 2. Make sure to keep the protective cap. RMA requests will be accepted and processed only if the LGA775 socket comes with the protective cap.*

Installing the CPU

1. Make sure the PC and all other peripheral devices connected to it has been powered down.
2. Disconnect all power cords and cables.
3. Locate the LGA 775 CPU socket on the system board.

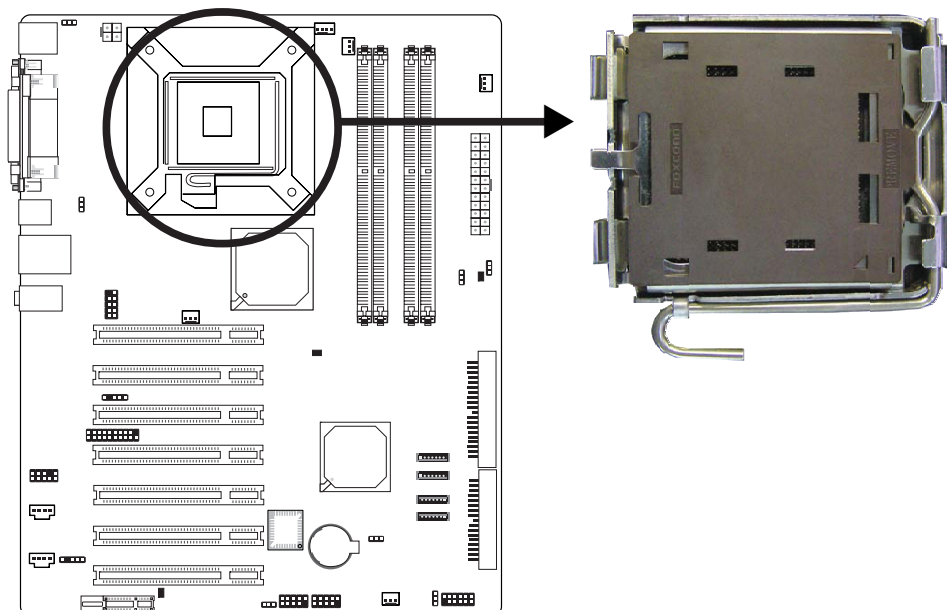

**Important:**

The CPU socket must not come in contact with anything other than the CPU. Avoid unnecessary exposure. Remove the protective cap only when you are about to install the CPU.

4. The CPU socket comes with a cover that is attached with a removable protective cap. The cap is used to protect the CPU socket against dust and harmful particles. Remove the protective cap only when you are about to install the CPU.

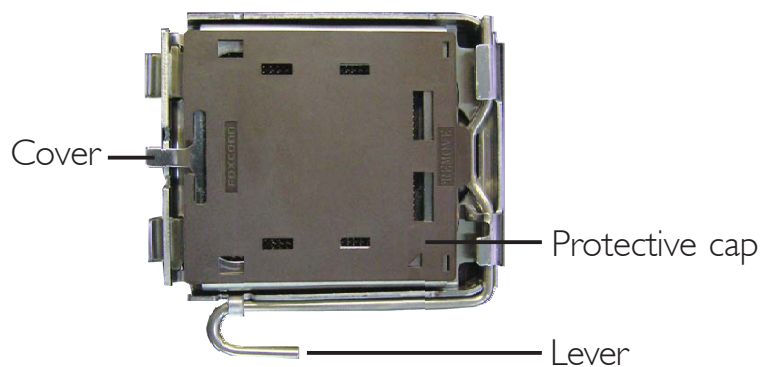

5. Lift the protective cap from the location pointed below to detach the cap from the cover.

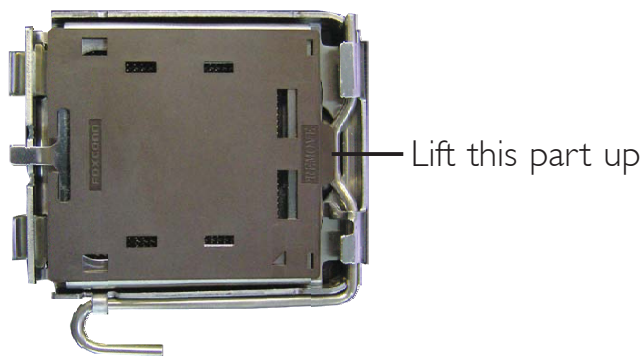

6. Unlock the socket by pushing the lever down, moving it away from the side tab of the socket, then lifting it up.

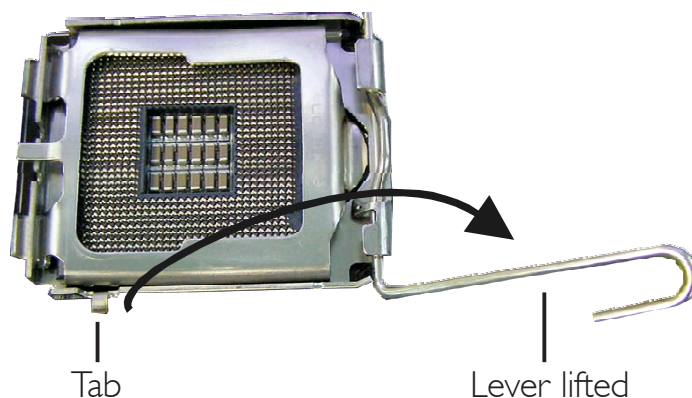

7. Now lift the cover.

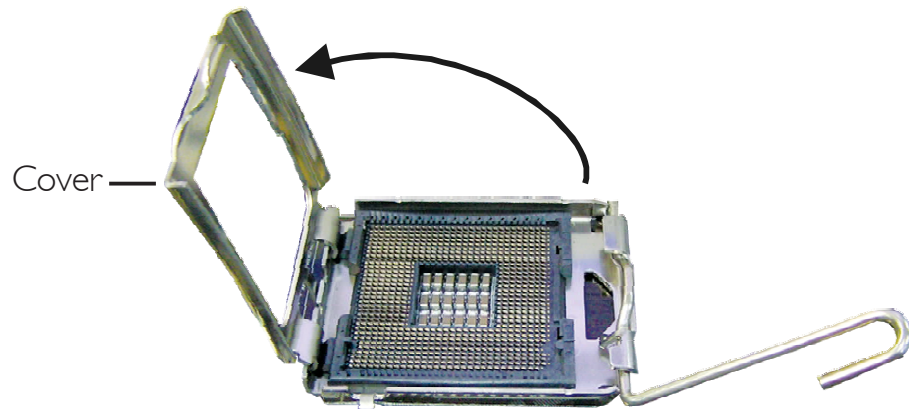

8. Position the CPU above the socket. The gold mark on the CPU must align with pin 1 of the CPU socket.



Important:

Handle the CPU by its edges and avoid touching the pins.

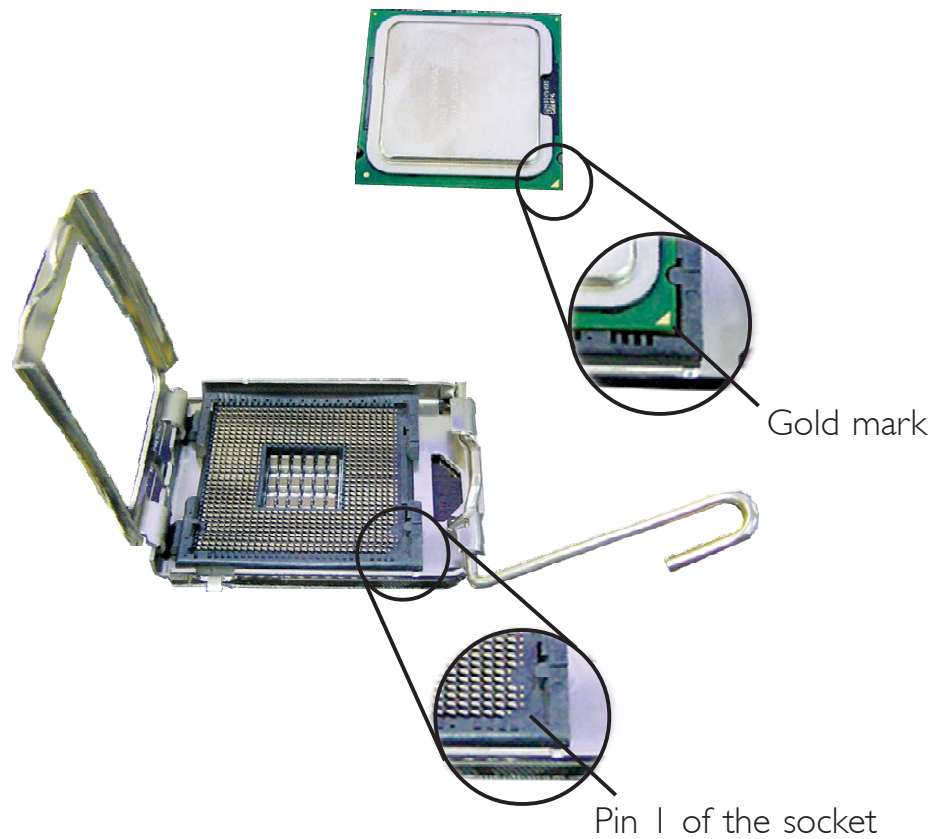

9. Insert the CPU into the socket until it is seated in place. The CPU will fit in only one orientation and can easily be inserted without exerting any force.

**Important:**

Do not force the CPU into the socket. Forcing the CPU into the socket may bend the pins and damage the CPU.

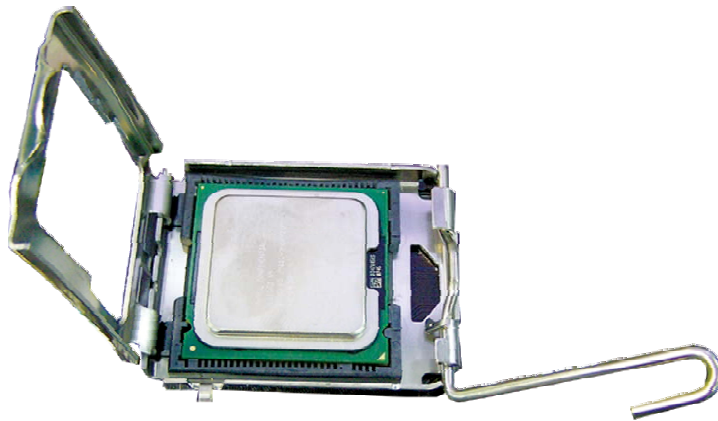

10. Once the CPU is in place, move the cover down.

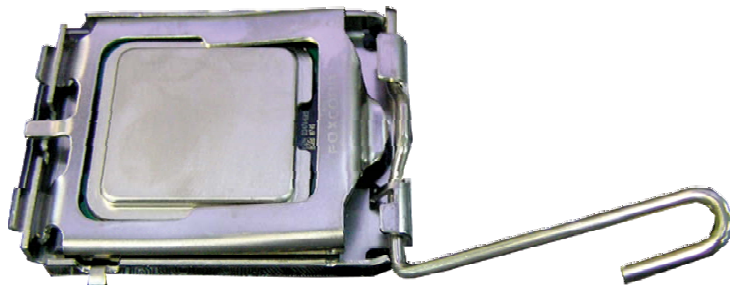

11. Push the lever down to lock the socket. The lever should hook onto the side tab to indicate that the CPU is completely secured in the socket.

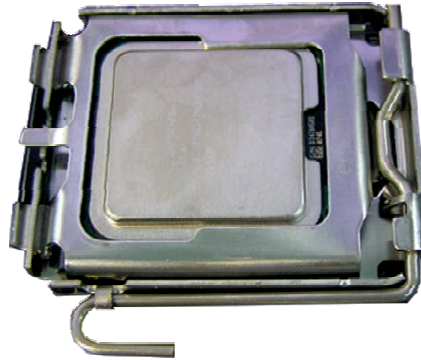

Installing the Fan and Heat Sink

The CPU must be kept cool by using a CPU fan with heat sink. Without sufficient air circulation across the CPU and heat sink, the CPU will overheat damaging both the CPU and system board.



Note:

- Use only certified fan and heat sink.
 - The fan and heat sink package usually contains the fan and heat sink assembly, and an installation guide. If the installation procedure in the installation guide differs from the one in this section, please follow the installation guide in the package.
1. Before you install the fan / heat sink, you must apply a thermal paste onto the top of the CPU. The thermal paste is usually supplied when you purchase the CPU or fan heat sink assembly. Do not spread the paste all over the surface. When you later place the heat sink on top of the CPU, the compound will disperse evenly.

Do not apply the paste if the fan / heat sink already has a patch of thermal paste on its underside. Peel the strip that covers the paste before you place the fan / heat sink on top of the CPU.

- Place the heat sink on top of the CPU. The 4 studs around the heat sink which are used to secure the heat sink onto the system board must match the 4 mounting holes around the socket.

Position each stud so that the groove faces the heat sink then push it down firmly until it clicks into place.



Note:

You will not be able to secure the fan and heat sink assembly in place if the groove is not facing the heat sink.

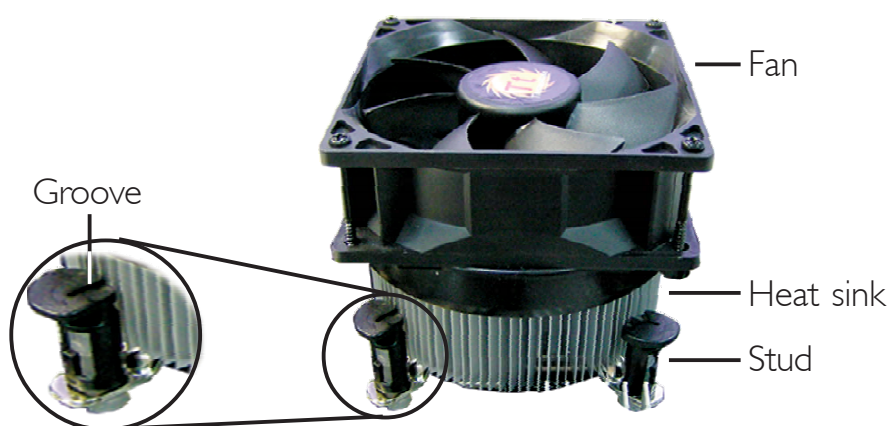
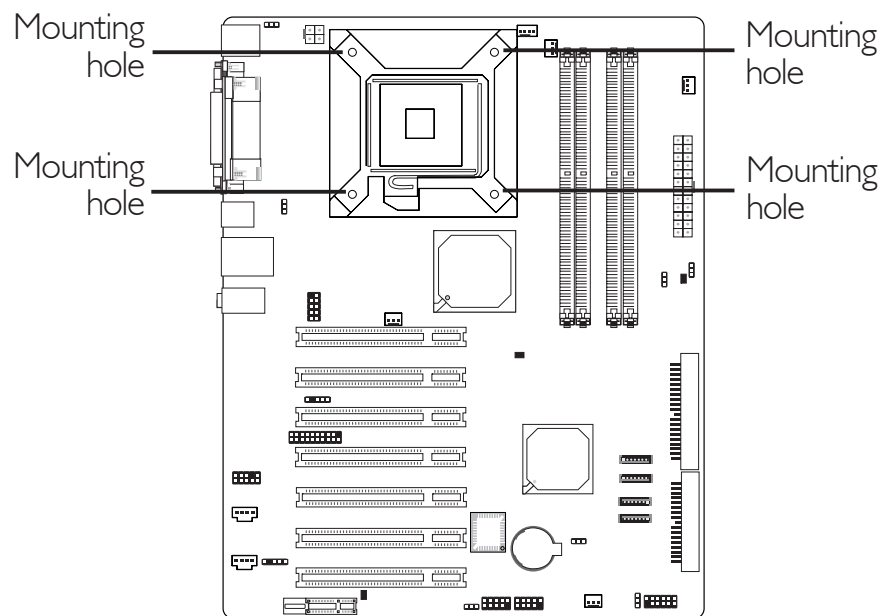

- Connect the CPU fan's cable connector to the CPU fan connector on the system board.

Jumper Settings

Clear CMOS Data

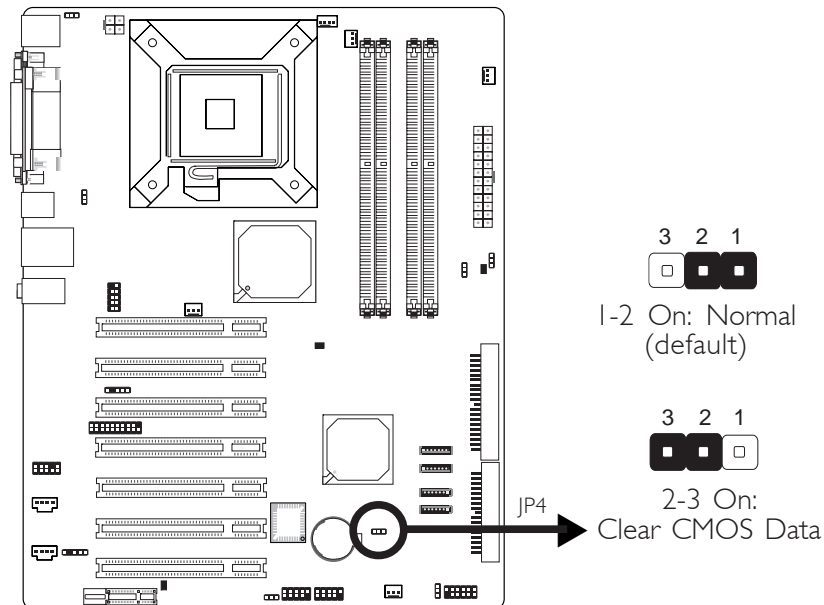

If you encounter the following,

- CMOS data becomes corrupted.*
- You forgot the supervisor or user password.*
- You are unable to boot-up the computer system because the processor's ratio was incorrectly set in the BIOS.*

you can reconfigure the system with the default values stored in the ROM BIOS.

To load the default values stored in the ROM BIOS, please follow the steps below.

1. Power-off the system and unplug the power cord.
2. Set JP4 pins 2 and 3 to On. Wait for a few seconds and set JP4 back to its default setting, pins 1 and 2 On.
3. Now power-on the system.

If your reason for clearing the CMOS data is due to incorrect setting of the processor's ratio in the BIOS, please proceed to step 4.

4. After powering-on the system, press to enter the main menu of the BIOS.
5. Select the Frequency/Voltage Control submenu and press <Enter>.
6. Set the processor's ratio to its default setting or an appropriate ratio. Refer to the Frequency/Voltage Control section in chapter 3 for more information.
7. Press <Esc> to return to the main menu of the BIOS setup utility. Select "Save & Exit Setup" and press <Enter>.
8. Type <Y> and press <Enter>.

PS/2 Power Select

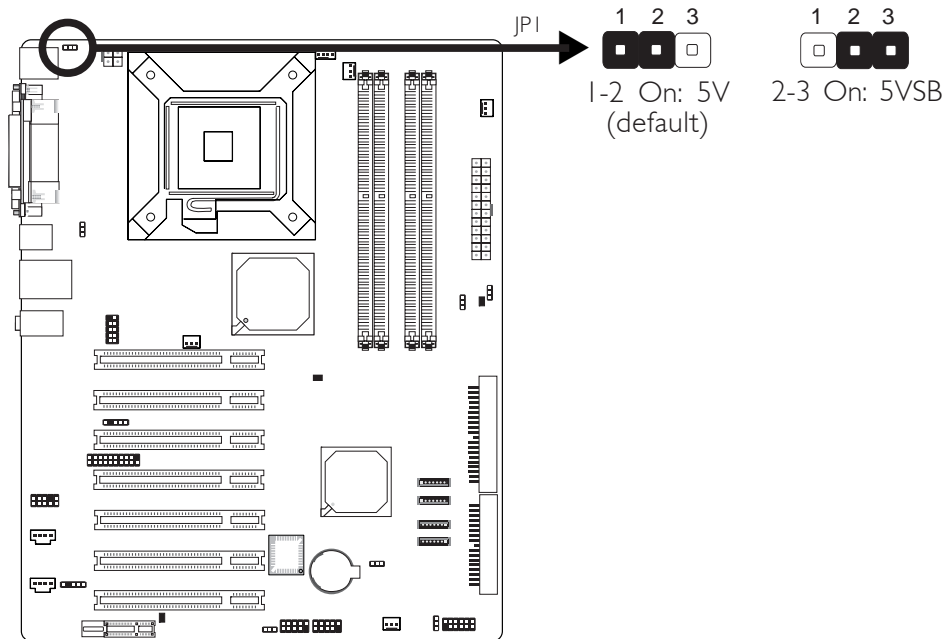

JPI is used to select the power of the PS/2 keyboard/mouse port. Selecting 5VSB will allow you to use the PS/2 keyboard or PS/2 mouse to wake up the system.

BIOS Setting

Configure the PS/2 keyboard/mouse wake up function in the Integrated Peripherals submenu ("Super IO Device" section) of the BIOS. Refer to chapter 3 for more information.



Important:

The 5VSB power source of your power supply must support $\geq 720\text{mA}$.

USB Power Select

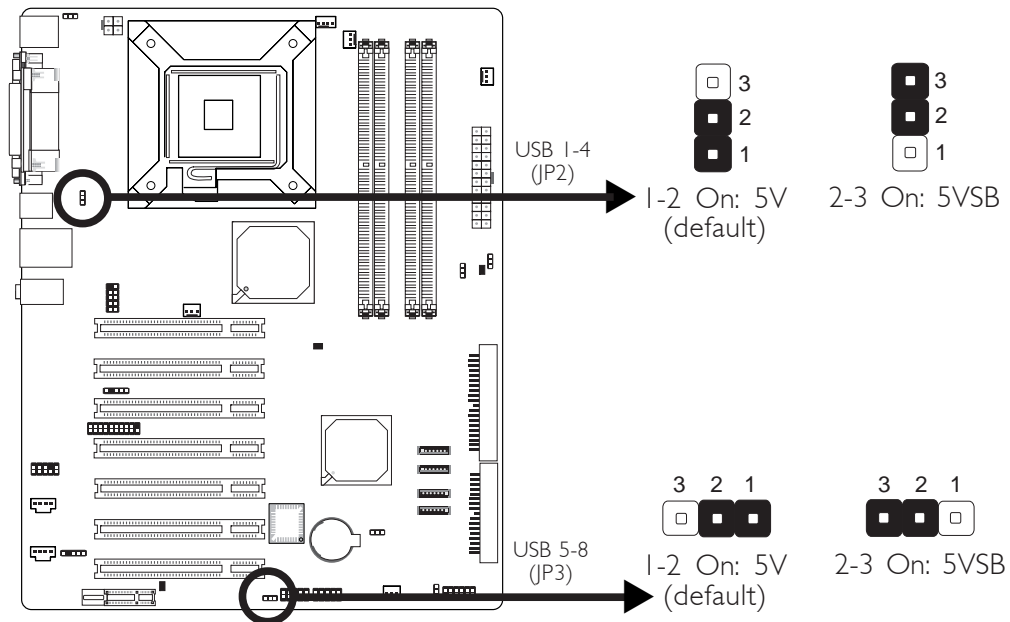

JP2 and JP3 are used to select the power of the USB ports. Selecting 5VSB will allow you to use the USB keyboard or USB mouse to wake up the system.

BIOS Setting

"USB KB Wake-Up From S3" in the Power Management Setup submenu of the BIOS must be set to Enabled. Refer to chapter 3 for more information.

**Important:**

If you are using the Wake-On-USB Keyboard/Mouse function for 2 USB ports, the 5VSB power source of your power supply must support $\geq 1.5A$. For 3 or more USB ports, the 5VSB power source of your power supply must support $\geq 2A$.

Power-on Select

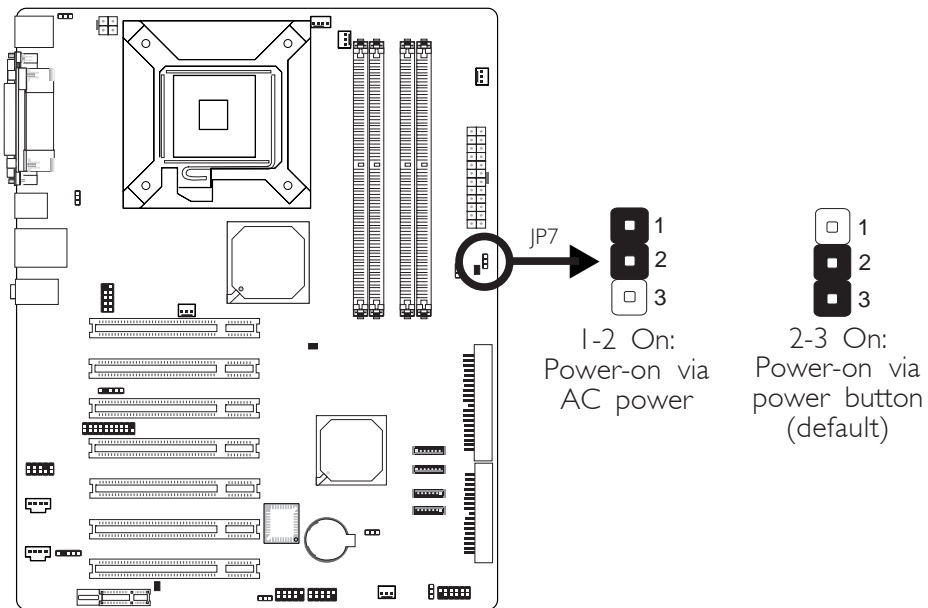

JP7 is used to select the method of powering on the system. If you want the system to power-on whenever AC power comes in, set JP7 pins 1 and 2 to On. If you want to use the power button, set pins 2 and 3 to On.



Important:

If you want the system to automatically power-on when power returns after an AC power failure, you must:

- 1. Set JP7 pins 1 and 2 to On.*
- 2. The PWRON After PWR-Fail field must be set to "On". (Integrated Peripherals submenu, Super I/O Device section of the BIOS).*

1st AC Power-on

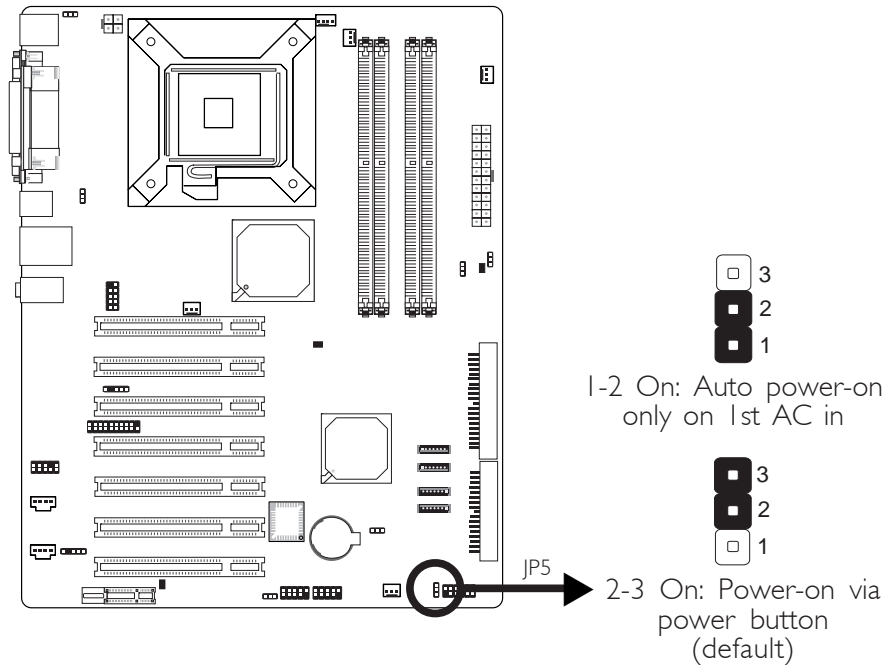

JP5 is used to select the method of powering on the system. Set JP5 to 1-2 On if you want the system to automatically power-on only the first time AC power comes in. If you want to use the power button, set JP5 to 2-3 On.

Power Good Sequence Select

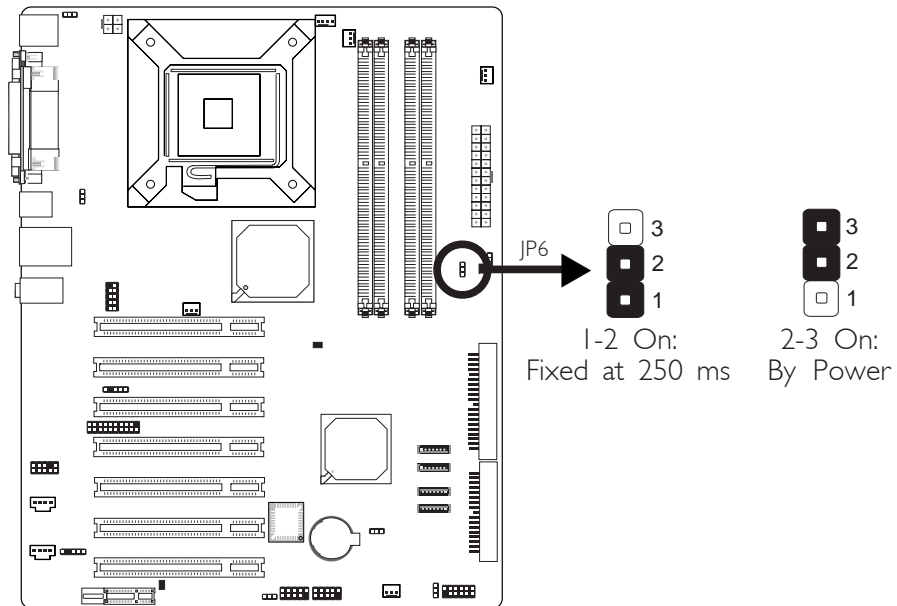

JP6 is used to select the power good sequence.

Rear Panel I/O Ports

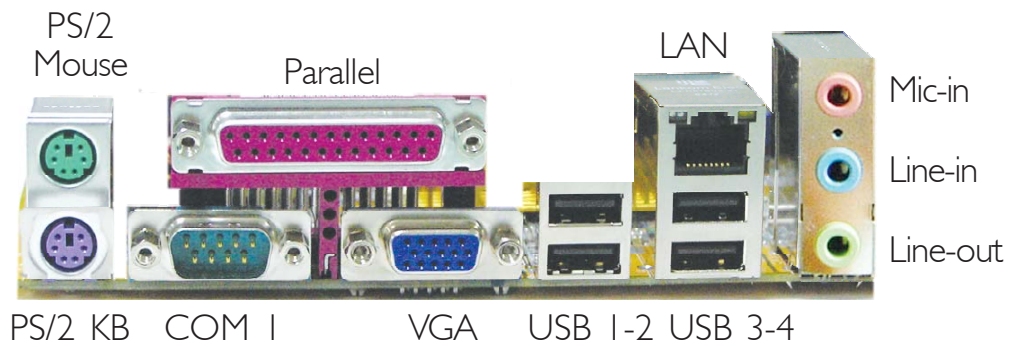

The rear panel I/O ports consist of the following:

- PS/2 mouse port
- PS/2 keyboard port
- Parallel port
- COM port
- VGA port
- USB ports
- LAN port
- Mic-in jack
- Line-in jack
- Line-out jack

PS/2 Mouse and PS/2 Keyboard Ports

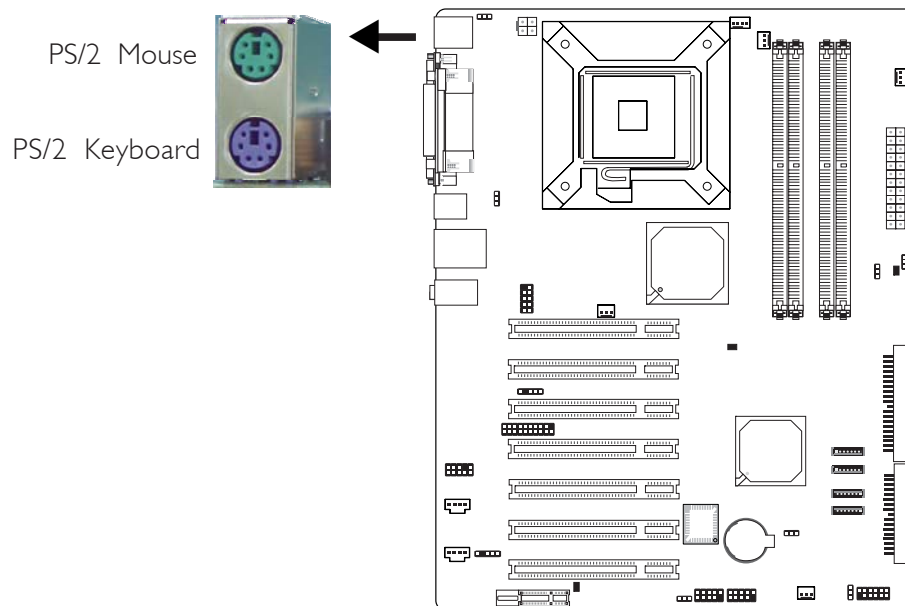

The system board is equipped with an onboard PS/2 mouse (Green) and PS/2 keyboard (Purple) ports - both at location CNI of the system board. The PS/2 mouse port uses IRQ12. If a mouse is not connected to this port, the system will reserve IRQ12 for other expansion cards.



Warning:

Make sure to turn off your computer prior to connecting or disconnecting a mouse or keyboard. Failure to do so may damage the system board.

Wake-On-PS/2 Keyboard/Mouse

The Wake-On-PS/2 Keyboard/Mouse function allows you to use the PS/2 keyboard or PS/2 mouse to power-on the system. To use this function:

- **Jumper Setting:**
JPI must be set to “2-3 On: 5VSB”. Refer to “PS/2 Power Select” in this chapter for more information.
- **BIOS Setting:**
Configure the PS/2 keyboard/mouse wake up function in the Integrated Peripherals submenu (“Super IO Device” section) of the BIOS. Refer to chapter 3 for more information.

Parallel Port

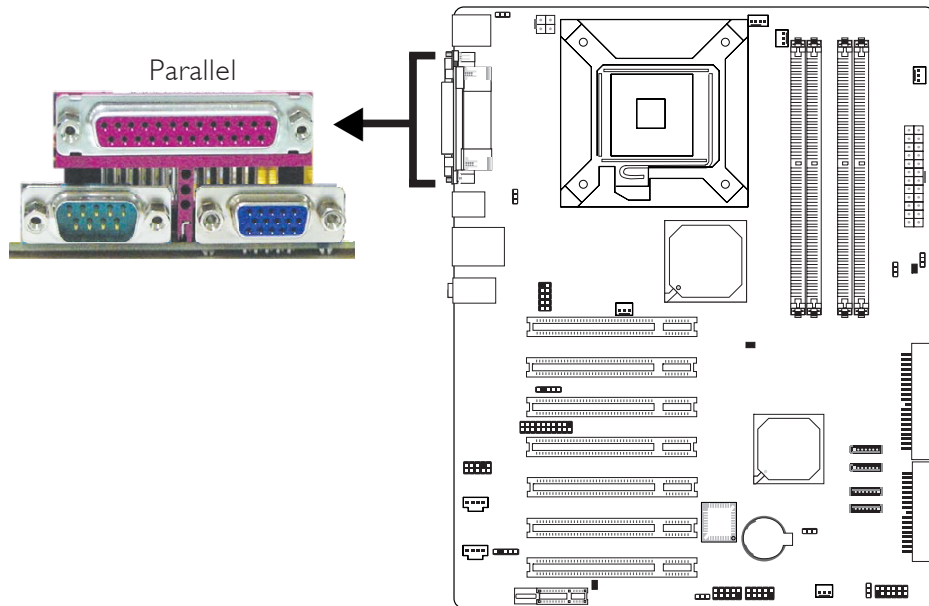

The system board has a standard parallel port (Burgundy) at location CN7 for interfacing your PC to a parallel printer. It supports SPP, ECP and EPP.

Setting	Function
SPP (Standard Parallel Port)	Allows normal speed operation but in one direction only.
ECP (Extended Capabilities Port)	Allows parallel port to operate in bidirectional mode and at a speed faster than the SPP's data transfer rate.
EPP (Enhanced Parallel Port)	Allows bidirectional parallel port operation at maximum speed.

BIOS Setting

Configure the parallel port in the Integrated Peripherals submenu ("Super I/O Device" section) of the BIOS. Refer to chapter 3 for more information.

Serial Port

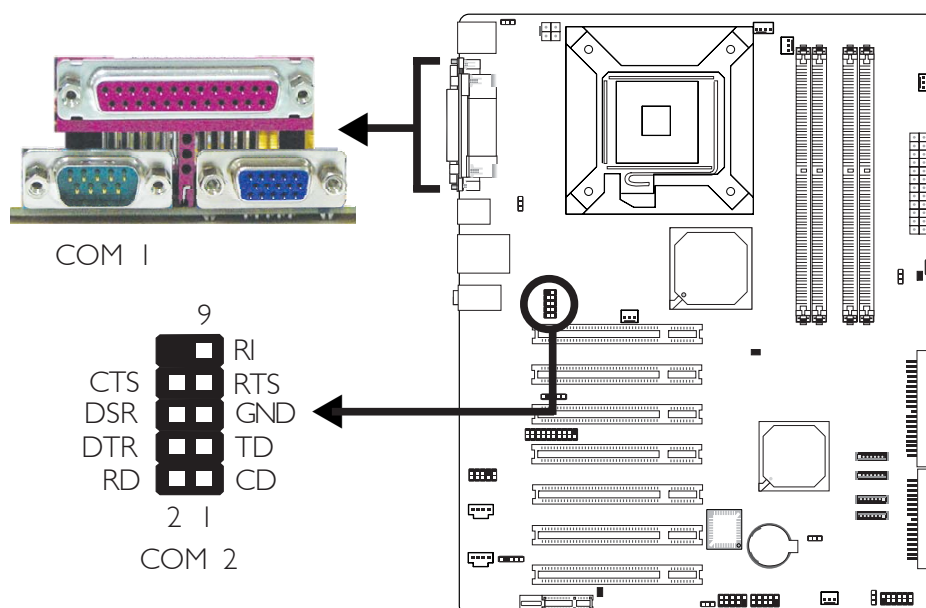

The system board is equipped with an onboard serial port at location CN4 (COM 1). It is also equipped with a 9-pin connector at location J6 (COM 2). These serial ports are RS-232 asynchronous communication ports with 16C550A-compatible UARTs that can be used with modems, serial printers, remote display terminals, and other serial devices.

Your COM port may come mounted on a card-edge bracket. Install the card-edge bracket to an available slot at the rear of the system chassis then insert the connector that is attached to the serial port cable to J6. Make sure the colored stripe on the ribbon cable is aligned with pin 1 of J6.

BIOS Setting

Configure the serial ports in the Integrated Peripherals submenu (“Super I/O Device” section) of the BIOS. Refer to chapter 3 for more information.

VGA Port

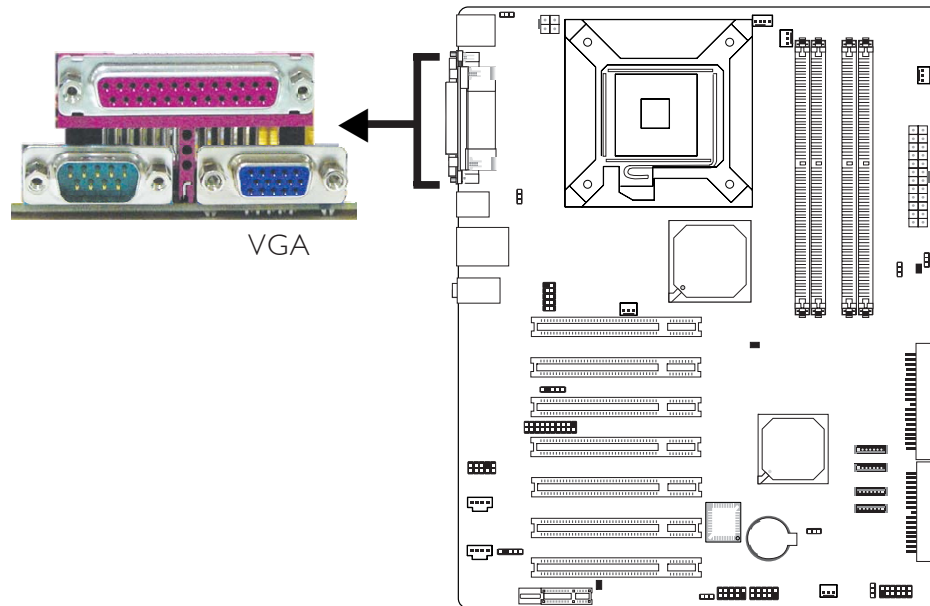

The system board can only be used with an analog video monitor. Connect the monitor's 15-pin D-shell cable connector to the VGA port (Blue) at location CN2. If your monitor supports analog video but does not have a 15-pin D-shell connector, see your monitor dealer for the adapter or optional cable. After you plug the monitor cable into the VGA port, gently tighten the cable screws to hold the connector in place. Some monitors have a switch that chooses between analog and TTL (or digital) operation. If your monitor has such a switch, set it for analog.

BIOS Setting

Configure the onboard VGA in the Advanced Chipset Features submenu of the BIOS. Refer to chapter 3 for more information.

Driver Installation

Install the graphics driver. Refer to chapter 4 for more information.

USB Ports

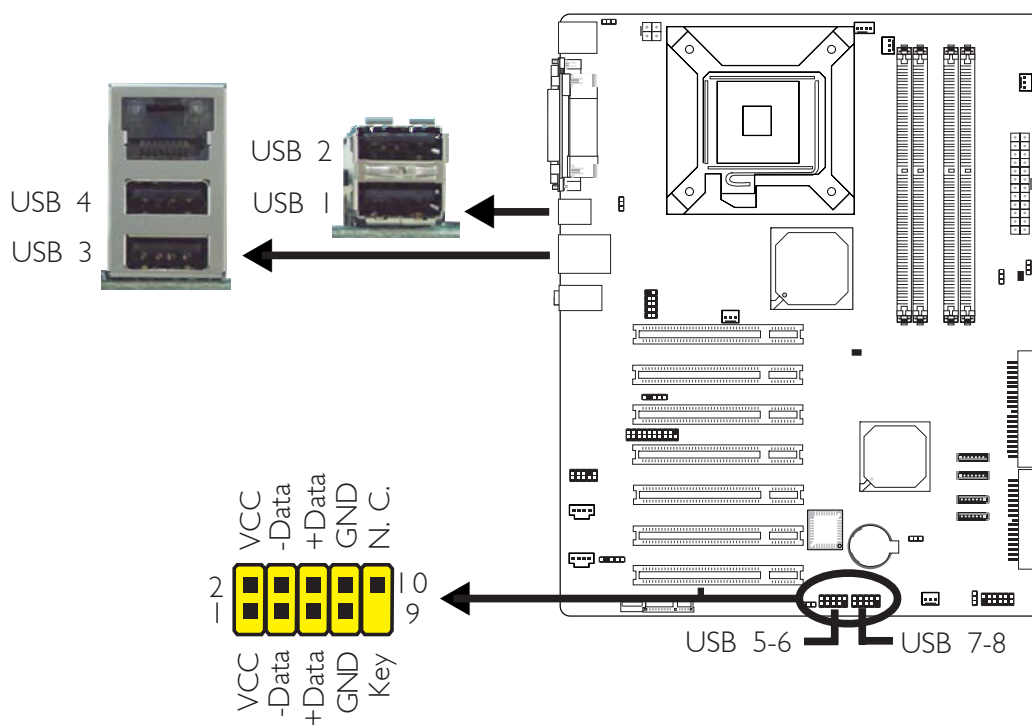

The system board supports 8 USB 2.0/1.1 ports. USB allows data exchange between your computer and a wide range of simultaneously accessible external Plug and Play peripherals.

Four onboard USB 2.0/1.1 ports (Black) are at locations CN6 (USB 1-2) and CN5 (USB 3-4) of the system board.

J10 (USB 5-6) and J11 (USB 7-8) allow you to connect 4 additional USB 2.0/1.1 ports. Your USB ports may come mounted on a card-edge bracket. Install the card-edge bracket to an available slot at the rear of the system chassis then insert the connector that is attached to the USB port cables to J10/J11. Make sure pin 1 of the cable connector is aligned with pin 1 of J10/J11.

BIOS Setting

Configure the onboard USB in the Integrated Peripherals submenu ("Onboard Device" section) of the BIOS. Refer to chapter 3 for more information.

Driver Installation

You may need to install the proper drivers in your operating system to use the USB device. Refer to your operating system's manual or documentation for more information.

Refer to chapter 4 for more information about installing the USB 2.0 driver.

Wake-On-USB Keyboard/Mouse

The Wake-On-USB Keyboard/Mouse function allows you to use a USB device to wake up a system from the S3 (STR - Suspend To RAM) state. To use this function:

- **Jumper Setting:**
JP2 and/or JP3 must be set to "2-3 On: 5VSB". Refer to "USB Power Select" in this chapter for more information.
- **BIOS Setting:**
"USB KB Wake-Up From S3" in the Power Management Setup submenu of the BIOS must be set to Enabled. Refer to chapter 3 for more information.



Important:

If you are using the Wake-On-USB Keyboard/Mouse function for 2 USB ports, the 5VSB power source of your power supply must support $\geq 1.5A$. For 3 or more USB ports, the 5VSB power source of your power supply must support $\geq 2A$.

RJ45 LAN Port

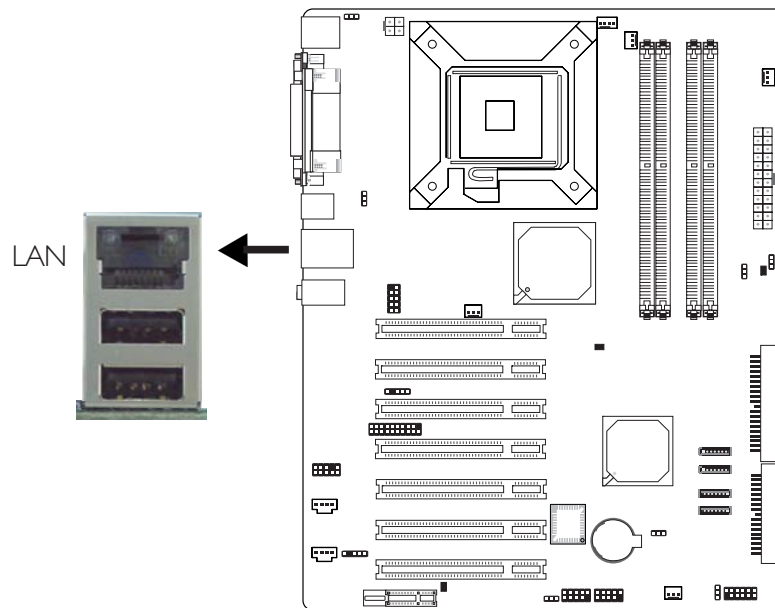

The RJ45 LAN port is at location CN5 of the system board. LAN allows the system board to connect to a local area network by means of a network hub.

BIOS Setting

Configure the onboard LAN in the in the Integrated Peripherals submenu (“Onboard Device” section) of the BIOS. Refer to chapter 3 for more information.

Driver Installation

Install the LAN driver. Refer to chapter 4 for more information.

Audio (Rear Audio and Front Audio)

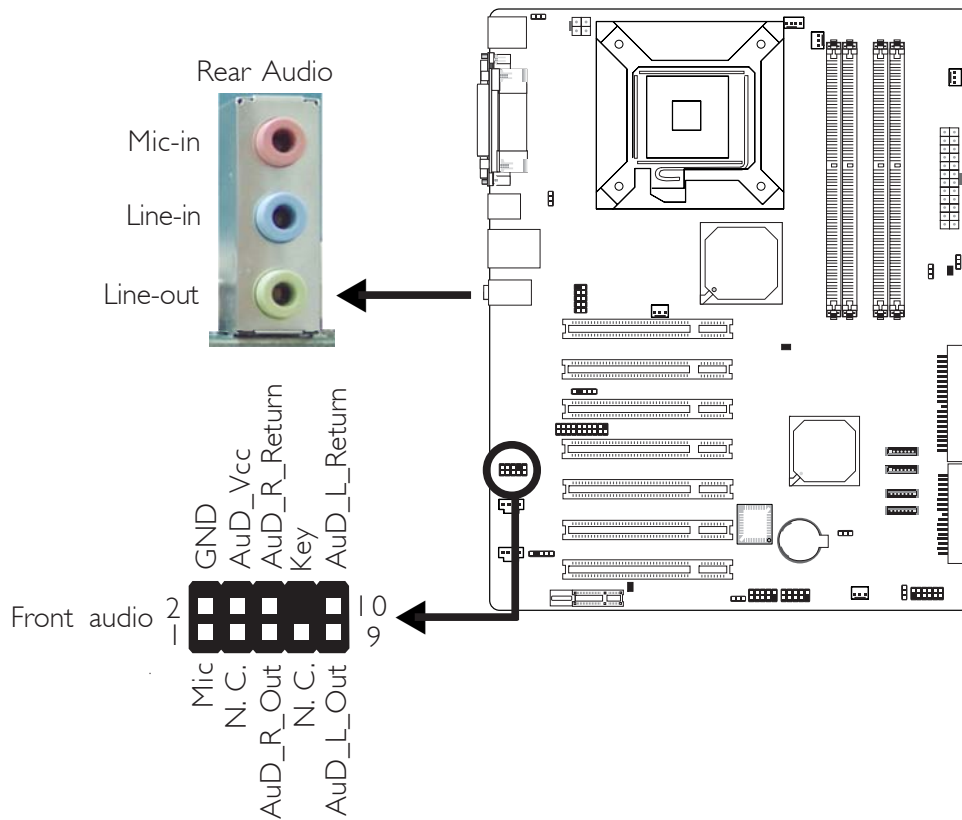

Rear Panel Audio (CN3)

- Mic-in (Pink)**
 In a 2-channel mode, this jack is used to connect an external microphone. In a 4-channel or 6-channel mode, this jack functions as rear right/left speaker out.
- Line-in (Light Blue)**
 In a 2-channel or 4-channel mode, this jack is used to connect any audio devices such as Hi-fi set, CD player, tape player, AM/FM radio tuner, synthesizer, etc. In a 6-channel mode, this jack functions as Center/Subwoofer.
- Line-out (Lime)**
 In a 2-channel mode, this jack is used to connect a headphone or external speakers. In a 4-channel or 6-channel mode, this jack functions as front right/left speaker out.

	2-channel	4-channel	6-channel
Light Blue	Line-in	Line-in	Center/Subwoofer
Lime	Line-out	Front R/L	Front R/L
Pink	Mic-in	Rear R/L	Rear R/L

Front Audio

The front audio connector (J1) allows you to connect to the line-out and mic-in jacks that are at the front panel of your system. Using this connector will disable the rear audio's line-out and mic-in functions.

Remove the jumper caps from pins 5-6 and pins 9-10 of J1 prior to connecting the front audio cable connector. Make sure pin 1 of the cable connector is aligned with pin 1 of J1. If you are not using this connector, make sure to replace the jumper caps back to their original pin locations.

Pins 5-6 and 9-10 short (default)	The front audio is disabled. The rear audio is enabled.
--------------------------------------	------------------------------------------------------------

Pins 5-6 and 9-10 open	The front audio is enabled. The rear audio is disabled.
------------------------	------------------------------------------------------------

Driver Installation

Install the audio driver. An audio software application program will at the same time be installed into your system. Refer to chapter 4 for more information.

I/O Connectors

CD-in Connector

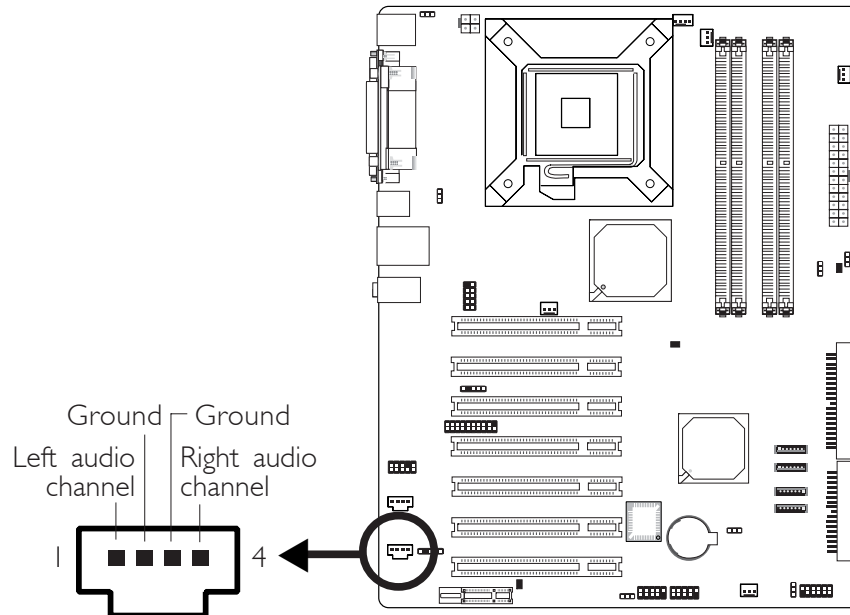

The CD-in connector (J2) is used to receive audio from a CD-ROM drive, TV tuner or MPEG card.

Speaker-out Connector

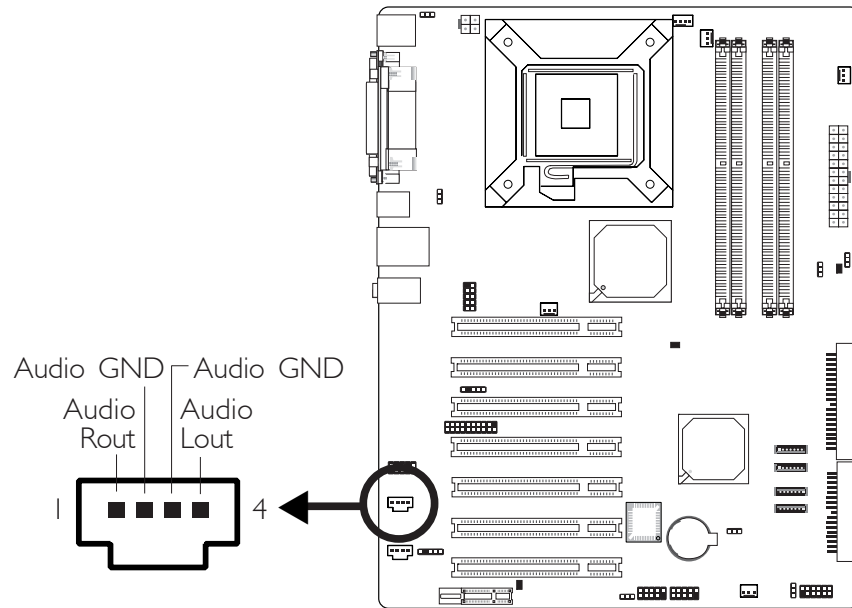

The speaker-out connector (J3) is used to connect external speakers.

S/PDIF Connector

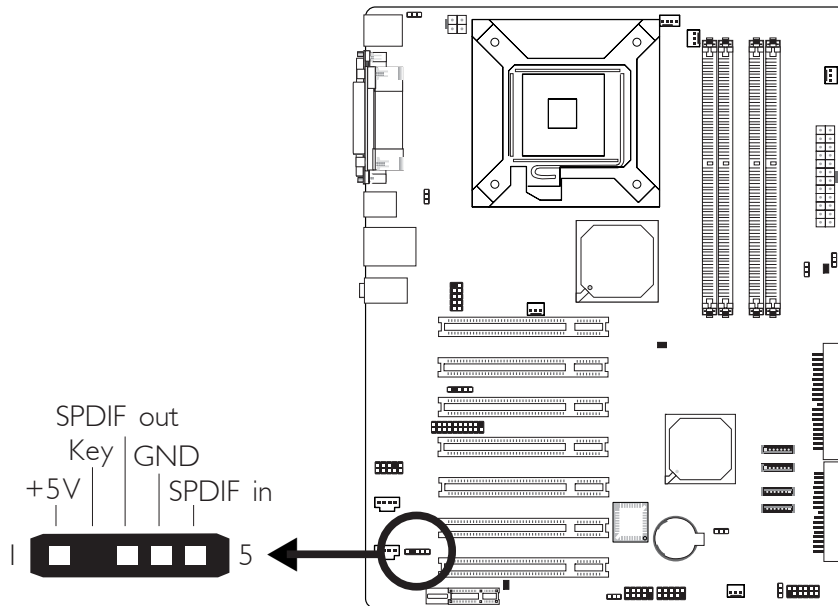

The S/PDIF connector (SPDIF1) is used to connect external S/PDIF ports. Your S/PDIF ports may come mounted on a card-edge bracket. Install the card-edge bracket to an available slot at the rear of the system chassis then insert the audio cable connector to SPDIF1. Make sure pin 1 of the audio cable connector is aligned with pin 1 of SPDIF1.

Floppy Disk Drive Connector

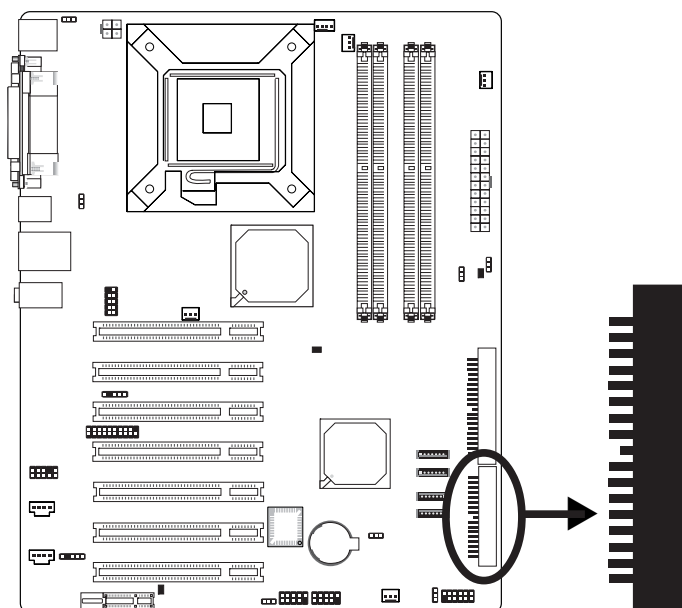

The floppy disk drive connector supports up to two standard floppy disk drives. To prevent improper floppy cable installation, the shrouded floppy disk header has a keying mechanism. The 34-pin connector on the floppy cable can be placed into the header only if pin 1 of the connector is aligned with pin 1 of the header.

Connecting the Floppy Disk Drive Cable

Install one end of the floppy disk drive cable into the shrouded floppy disk header (J21) on the system board and the other end-most connector to the drive you want to designate as Drive A. If you are connecting another drive (Drive B), install the middle connector of the cable to the drive. The colored edge of the daisy chained ribbon cable should be aligned with pin 1 of J21.

BIOS Setting

Enable or disable this function in the Integrated Peripherals submenu ("Super I/O Device" field) of the BIOS. Refer to chapter 3 for more information.

Serial ATA Connectors

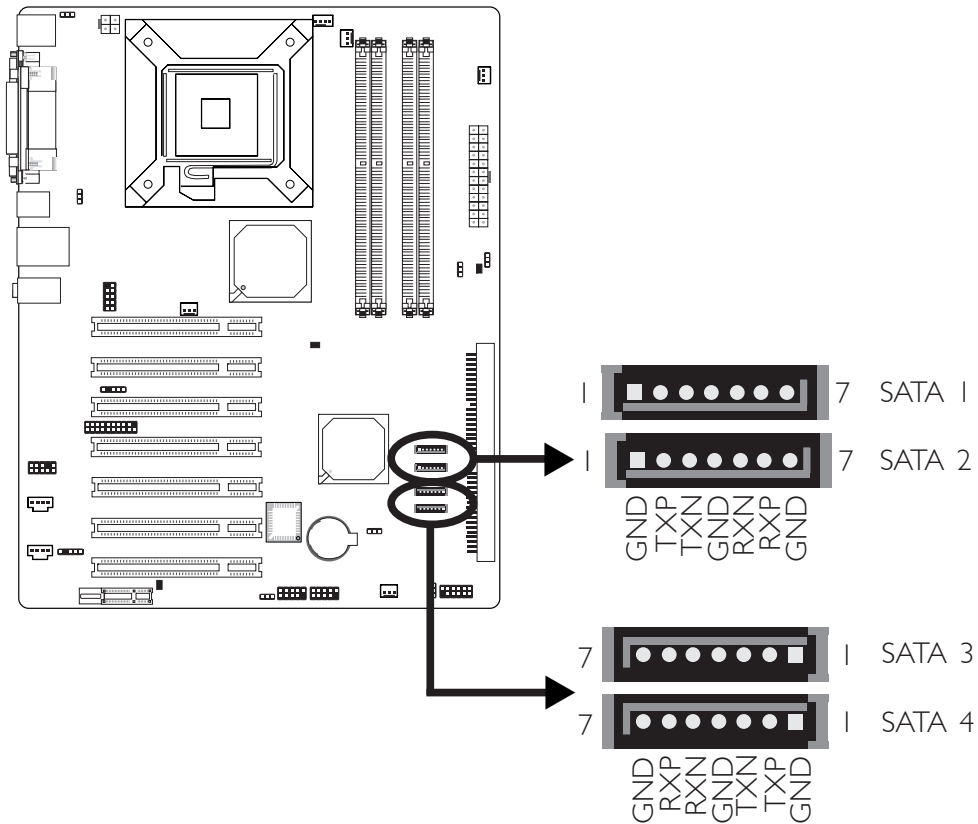

The system board is equipped with four Serial ATA connectors for connecting Serial ATA devices. Connect one end of the Serial ATA cable to SATA 1 (J19), SATA 2 (J18), SATA 3 (J16) or SATA 4 (J17) and the other end to your Serial ATA device.

BIOS Setting

Configure the onboard Serial ATA in the Integrated Peripherals submenu ("OnChip IDE Device" section) of the BIOS. Refer to chapter 3 for more information.

IDE Disk Drive Connectors

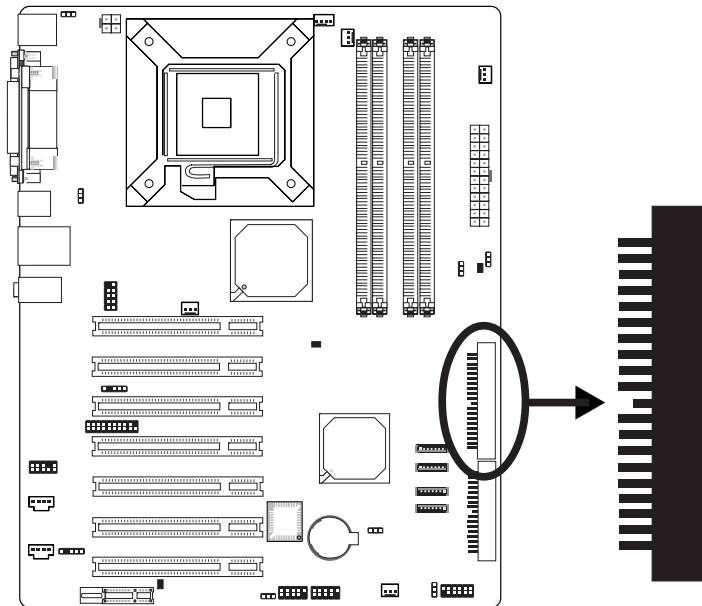

The 90° shrouded PCI IDE header will interface two Enhanced IDE (Integrated Drive Electronics) disk drives. To prevent improper IDE cable installation, the shrouded PCI IDE header has a keying mechanism. The 40-pin connector on the IDE cable can be placed into the header only if pin 1 of the connector is aligned with pin 1 of the header:

The IDE connector supports 2 devices, a Master and a Slave. Use an IDE ribbon cable to connect the drives to the system board. An IDE ribbon cable has 3 connectors on them, one that plugs into an IDE connector on the system board and the other 2 connect to IDE devices. The connector at the end of the cable is for the Master drive and the connector in the middle of the cable is for the Slave drive.

Connecting the IDE Disk Drive Cable

Install one end of the IDE cable into the IDE header (J22) on the system board and the other connectors to the IDE devices.

**Note:**

Refer to your disk drive user's manual for information about selecting proper drive switch settings.

Adding a Second IDE Disk Drive

When using two IDE drives, one must be set as the master and the other as the slave. Follow the instructions provided by the drive manufacturer for setting the jumpers and/or switches on the drives.

The system board supports Enhanced IDE or ATA-2, ATA/33, ATA/66 or ATA/100 hard drives. We recommend that you use hard drives from the same manufacturer. In a few cases, drives from two different manufacturers will not function properly when used together. The problem lies in the hard drives, not the system board.

**Important:**

If you encountered problems while using an ATAPI CD-ROM drive that is set in Master mode, please set the CD-ROM drive to Slave mode. Some ATAPI CD-ROMs may not be recognized and cannot be used if incorrectly set in Master mode.

BIOS Setting

Configure the onboard IDE in the Integrated Peripherals submenu ("OnChip IDE Device" section) of the BIOS. Refer to chapter 3 for more information.

IrDA Connector

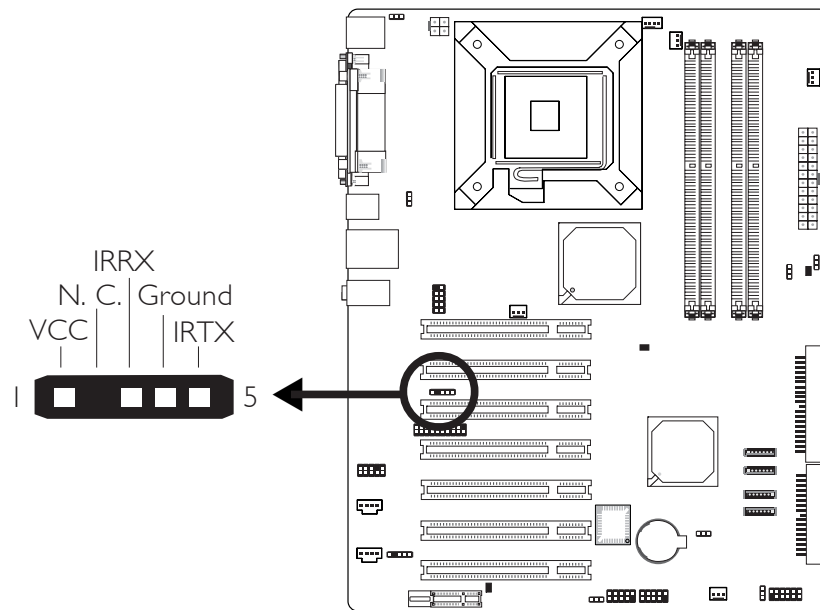

Connect your IrDA cable to connector J5 on the system board.



Note:

The sequence of the pin functions on some IrDA cable may be reversed from the pin function defined on the system board. Make sure to connect the cable to the IrDA connector according to their pin functions.

BIOS Setting

Configure the onboard IrDA in the Integrated Peripherals submenu (“Super I/O Device” section) of the BIOS to the type of IrDA standard supported by your device.

Driver Installation

You may need to install the proper drivers in your operating system to use the IrDA function. Refer to your operating system’s manual or documentation for more information.

Cooling Fan Connectors

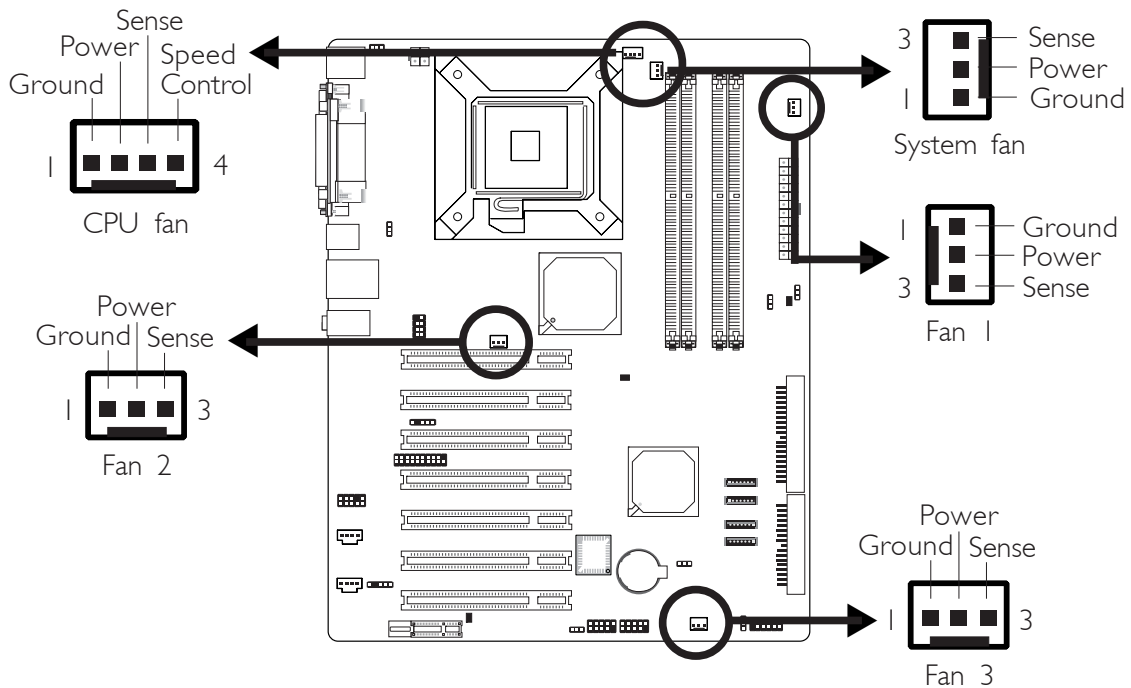

Connect the CPU fan's cable connector to the CPU fan connector (J12) on the system board. The system fan (J13), fan 1 (J23), fan 2 (J8) and fan 3 (J15) connectors are used to connect additional cooling fans. The cooling fans will provide adequate airflow throughout the chassis to prevent overheating the CPU and system board components.

BIOS Setting

The "PC Health Status" submenu of the BIOS will display the current speed of the cooling fans. Refer to chapter 3 for more information.

Power Connectors

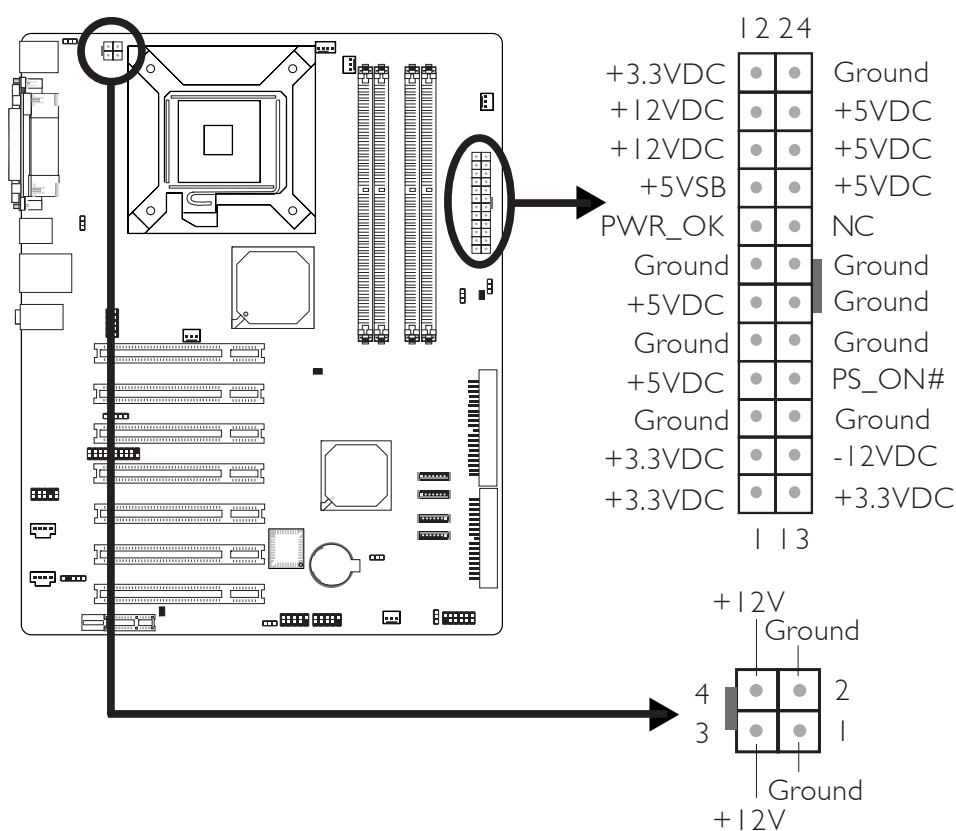

We recommend that you use a power supply that complies with the ATX12V Power Supply Design Guide Version 1.1. An ATX12V power supply has a standard 24-pin ATX main power connector and a 4-pin +12V power connector that must be inserted onto CN8 and P1 connectors respectively.

The 4-pin +12V power connector enables the delivery of more +12VDC current to the processor's Voltage Regulator Module (VRM).

The system board requires a minimum of 300 Watt power supply to operate. Your system configuration (CPU power, amount of memory, add-in cards, peripherals, etc.) may exceed the minimum power requirement. To ensure that adequate power is provided, **we strongly recommend that you use a minimum of 400 Watt (or greater) power supply.**

Power LED, DRAM Power LED and PCI Standby Power LED

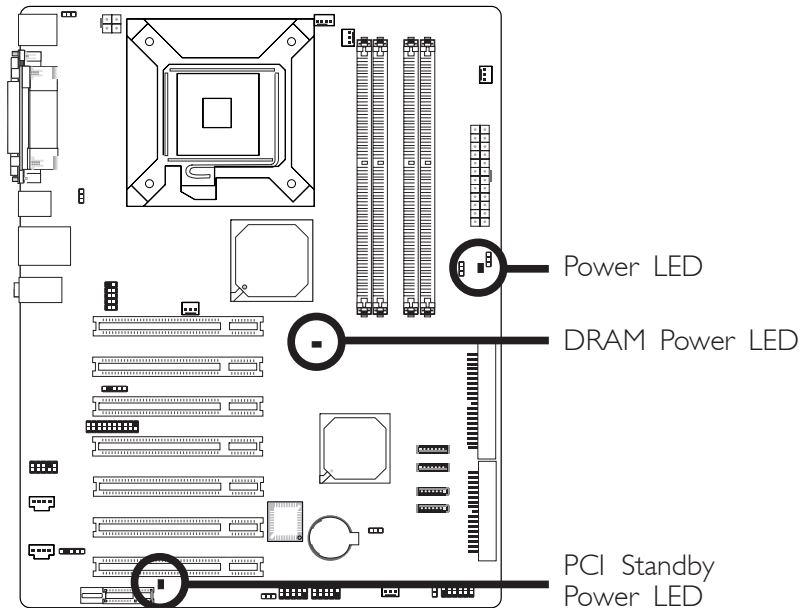

Power LED

This LED will light when the system's power is on.

DRAM Power LED

This LED will turn red when the system's power is on or when it is in the Suspend state (Power On Suspend or Suspend to RAM). It will not light when the system is in the Soft-Off state.

PCI Standby Power LED

This LED will turn red when the system is in the power-on, Soft-Off or Suspend (Power On Suspend or Suspend to RAM) state.

**Important:**

If the DRAM Power LED or PCI Standby Power LED is lighted, you must power-off the system then turn off the power supply's switch or unplug the power cord prior to installing any memory modules or add-in cards.

Front Panel Connectors

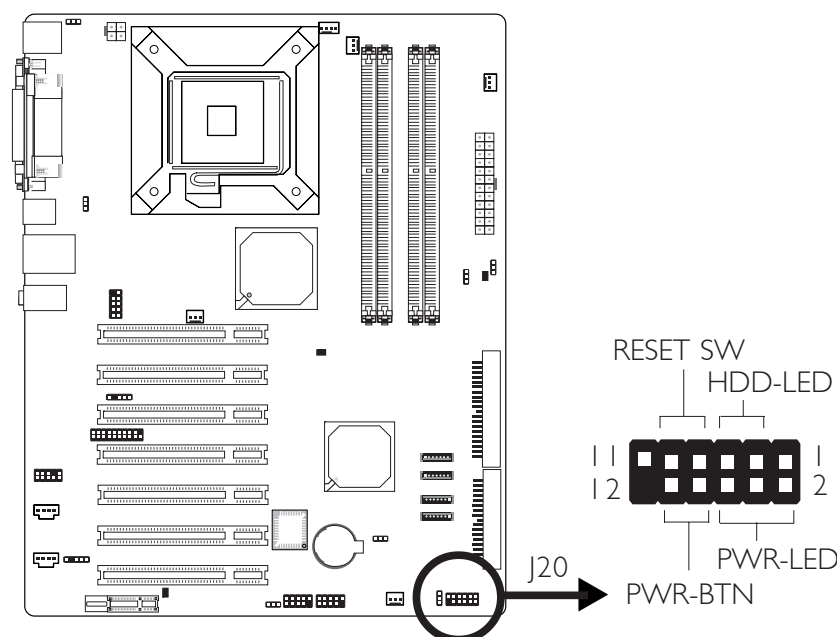

HDD-LED - HDD LED

This LED will light when the hard drive is being accessed.

RESET SW - Reset Switch

This switch allows you to reboot without having to power off the system.

PWR-BTN - Power Switch

This switch is used to power on or off the system.

PWR-LED - Power/Standby LED

When the system's power is on, this LED will light. When the system is in the S1 (POS - Power On Suspend) state, it will blink every second. When the system is in the S3 (STR - Suspend To RAM) state, it will blink every 4 seconds.

	Pin	Pin Assignment		Pin	Pin Assignment
N. C.	1	N. C.	PWR-LED	2	LED Power
				4	LED Power
				6	Signal
HDD-LED	3	HDD Power	PWR-BTN	8	Ground
	5	Signal		10	Signal
RESET SW	7	Ground			
	9	RST Signal			
N. C.	11	N. C.	Key	12	Key

Digital I/O Connector

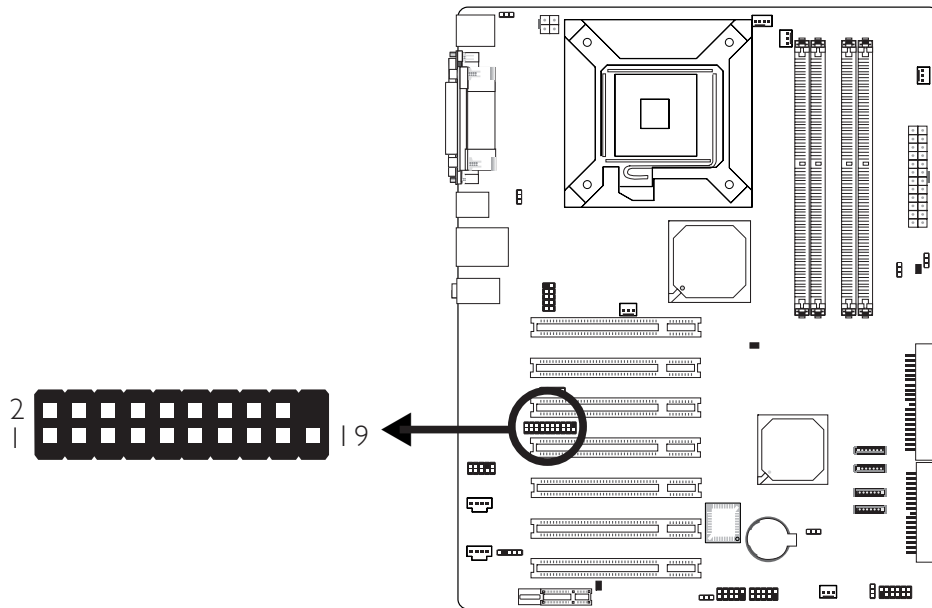

The Digital I/O connector (J24) provides powering-on function of an external device that is connected to this connector.

PCI Express Slot

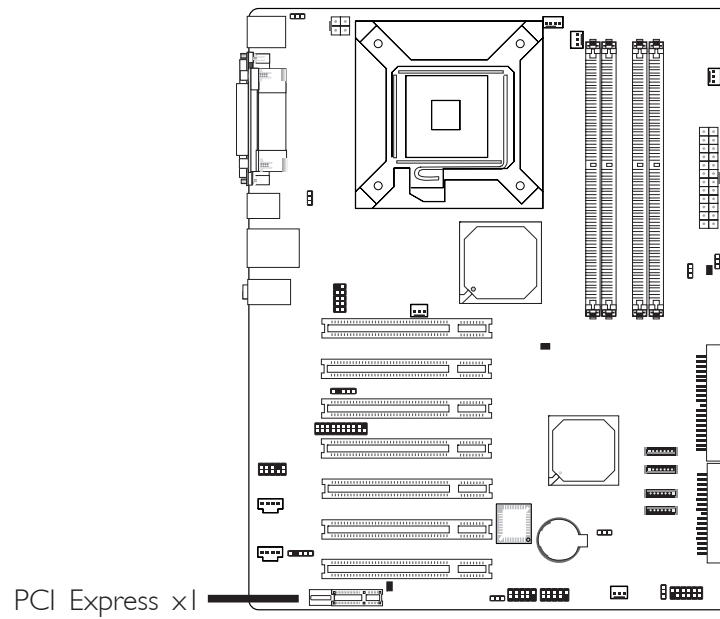

Install PCI Express x1 cards such as network cards or other cards that comply to the PCI Express specifications into the PCI Express x1 slot.

Battery

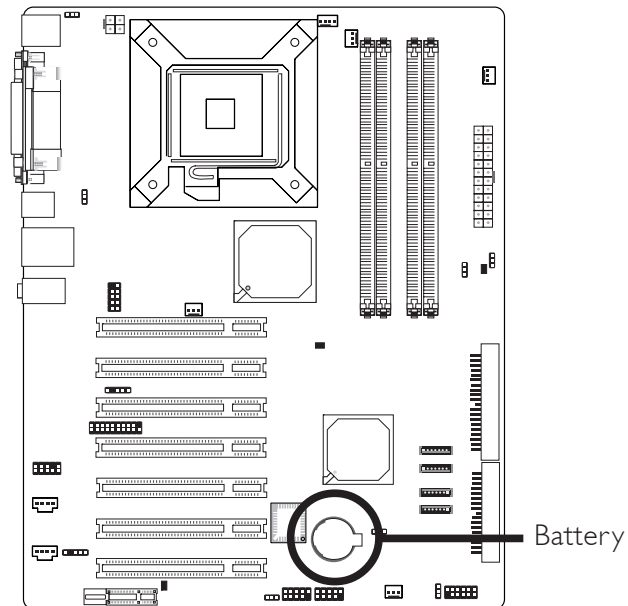

The lithium ion battery powers the real-time clock and CMOS memory. It is an auxiliary source of power when the main power is shut off.

Safety Measures

- Danger of explosion if battery incorrectly replaced.
- Replace only with the same or equivalent type recommend by the manufacturer.
- Dispose of used batteries according to the battery manufacturer's instructions.

Chapter 3 - BIOS Setup

Award BIOS Setup Utility

The Basic Input/Output System (BIOS) is a program that takes care of the basic level of communication between the processor and peripherals. In addition, the BIOS also contains codes for various advanced features found in this system board. This chapter explains the Setup Utility for the Award BIOS.

After you power up the system, the BIOS message appears on the screen and the memory count begins. After the memory test, the following message will appear on the screen:

Press DEL to enter setup

If the message disappears before you respond, restart the system or press the "Reset" button. You may also restart the system by pressing the <Ctrl> <Alt> and keys simultaneously.

When you press , the main menu screen will appear:

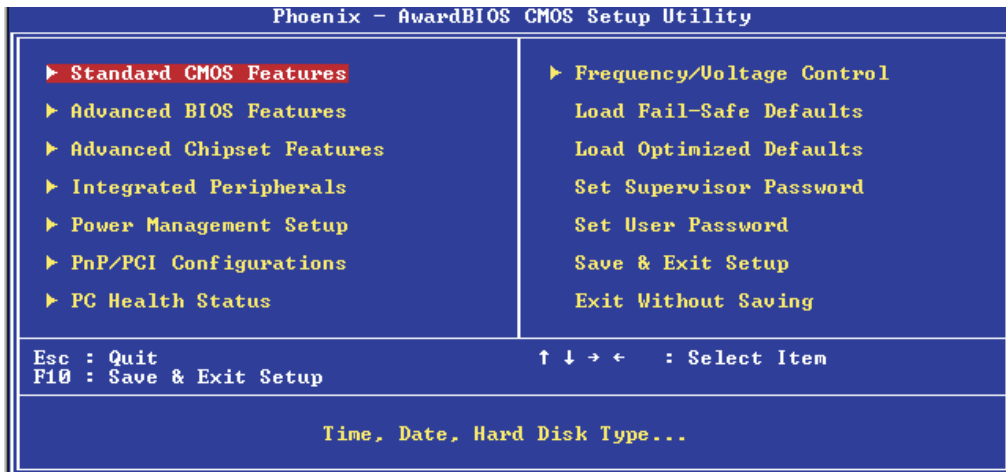

Standard CMOS Features

Use the arrow keys to highlight “Standard CMOS Features” and press <Enter>. A screen similar to the one below will appear:

```

Phoenix - AwardBIOS CMOS Setup Utility
Standard CMOS Features

Date <mm:dd:yy>      Fri, Jan 20 2006
Time <hh:mm:ss>     13 : 3 : 37
Item Help
Menu Level ▶
Change the day, month,
year and century

▶ IDE Channel 0 Master
▶ IDE Channel 0 Slave      None
▶ IDE Channel 1 Master
▶ IDE Channel 1 Slave      None

Drive A              1.44M, 3.5 in.
Drive B              None

Video               EGA/UGA
Halt On             All Errors

Base Memory          1K
Extended Memory     1K
Total Memory        512K

↑↓←→:Move  Enter:Select  +/-/PU/PD:Value  F10:Save  ESC:Exit  F1:General Help
F5: Previous Values  F6: Fail-Safe Defaults  F7: Optimized Defaults

```

The settings on the screen are for reference only. Your version may not be identical to this one.

Date

The date format is <day>, <month>, <date>, <year>. Day displays a day, from Sunday to Saturday. Month displays the month, from January to December. Date displays the date, from 1 to 31. Year displays the year, from 1990 to 2098.

Time

The time format is <hour>, <minute>, <second>. The time is based on the 24-hour military-time clock. For example, 1 p.m. is 13:00:00. Hour displays hours from 00 to 23. Minute displays minutes from 00 to 59. Second displays seconds from 00 to 59.

IDE Channel 0 Master/Slave and IDE Channel 1 Master/Slave

Move the cursor to the “IDE Channel 0 Master”, “IDE Channel 0 Slave”, “IDE Channel 1 Master” or “IDE Channel 1 Slave” field, then press <Enter>.

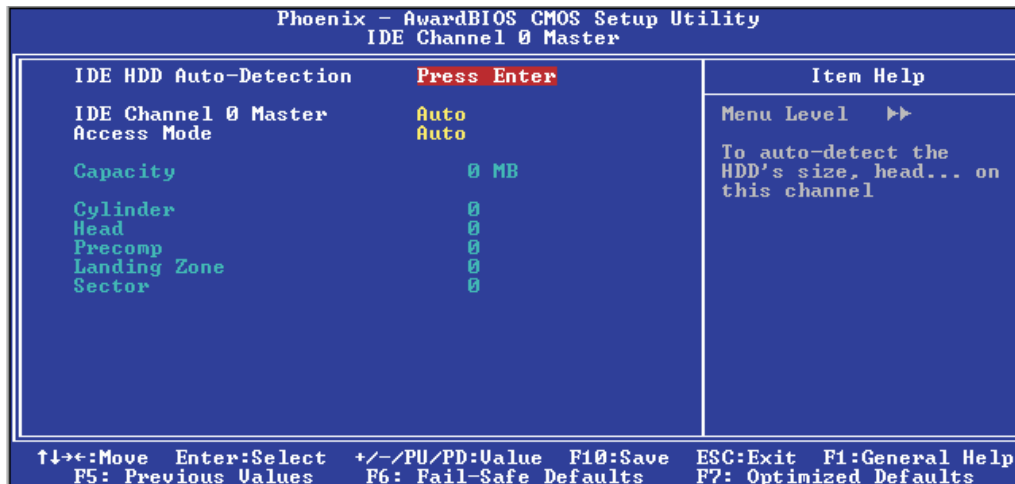

The settings on the screen are for reference only. Your version may not be identical to this one.

IDE HDD Auto Detection

Detects the parameters of the drive. The parameters will automatically be shown on the screen.

IDE Channel 0 Master/Slave and IDE Channel 1 Master/Slave

The drive type information should be included in the documentation from your hard disk vendor. If you select "Auto", the BIOS will auto-detect the HDD & CD-ROM drive at the POST stage and show the IDE for the HDD & CD-ROM drive. If a hard disk has not been installed, select "None".

Access Mode

For hard drives larger than 528MB, you would typically select the LBA type. Certain operating systems require that you select CHS or Large. Please check your operating system's manual or Help desk on which one to select.

Capacity

Displays the approximate capacity of the disk drive. Usually the size is slightly greater than the size of a formatted disk given by a disk checking program.

Cylinder

This field displays the number of cylinders.

Head

This field displays the number of read/write heads.

Precomp

This field displays the number of cylinders at which to change the write timing.

Landing Zone

This field displays the number of cylinders specified as the landing zone for the read/write heads.

Sector

This field displays the number sectors per track.

Drive A and Drive B

These fields identify the types of floppy disk drives installed.

<i>None</i>	No floppy drive is installed
<i>360K, 5.25 in.</i>	5-1/4 in. standard drive; 360KB capacity
<i>1.2M, 5.25 in.</i>	5-1/4 in. AT-type high-density drive; 1.2MB capacity
<i>720K, 3.5 in.</i>	3-1/2 in. double-sided drive; 720KB capacity
<i>1.44M, 3.5 in.</i>	3-1/2 in. double-sided drive; 1.44MB capacity
<i>2.88M, 3.5 in.</i>	3-1/2 in. double-sided drive; 2.88MB capacity

Video

This field selects the type of video adapter used for the primary system monitor. Although secondary monitors are supported, you do not have to select the type. The default setting is EGA/VGA.

<i>EGA/VGA</i>	Enhanced Graphics Adapter/Video Graphics Array. For EGA, VGA, SVGA and PGA monitor adapters.
<i>CGA 40</i>	Color Graphics Adapter. Power up in 40-column mode.
<i>CGA 80</i>	Color Graphics Adapter. Power up in 80-column mode.
<i>Mono</i>	Monochrome adapter. Includes high resolution monochrome adapters.

Halt On

This field determines whether the system will stop if an error is detected during power up. The default setting is All Errors.

<i>No Errors</i>	The system boot will not stop for any errors detected.
<i>All Errors</i>	The system boot will stop whenever the BIOS detects a non-fatal error.
<i>All, But Keyboard</i>	The system boot will not stop for a keyboard error; it will stop for all other errors.
<i>All, But Diskette</i>	The system boot will not stop for a disk error; it will stop for all other errors.
<i>All, But Disk/Key</i>	The system boot will not stop for a disk or keyboard error; it will stop for all other errors.

Base Memory

Displays the amount of base (or conventional) memory installed in the system. The value of the base memory is typically 512K for systems with 512K memory installed on the motherboard or 640K for systems with 640K or more memory installed on the motherboard.

Extended Memory

Displays the amount of extended memory detected during boot-up.

Total Memory

Displays the total memory available in the system.

Advanced BIOS Features

The Advanced BIOS Features allows you to configure your system for basic operation. Some entries are defaults required by the system board, while others, if enabled, will improve the performance of your system or let you set some features according to your preference.

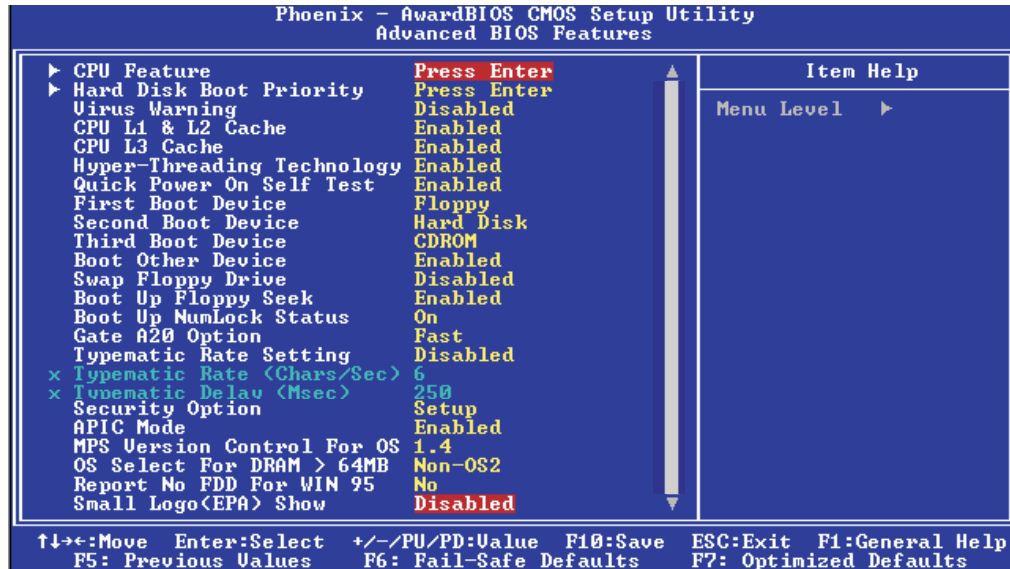

The screen above list all the fields available in the Advanced BIOS Features submenu, for ease of reference in this manual. In the actual CMOS setup, you have to use the scroll bar to view the fields. The settings on the screen are for reference only. Your version may not be identical to this one.

CPU Feature

Move the cursor to this field and press <Enter>. The following screen will appear:

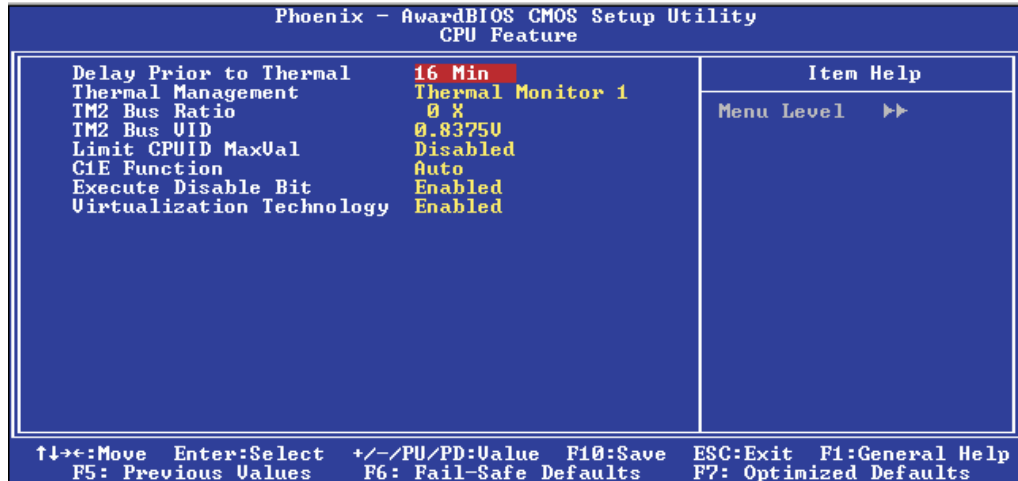

The settings on the screen are for reference only. Your version may not be identical to this one.

Delay Prior To Thermal

This field is used to select the time that would force the CPU to a 50% duty cycle when it exceeds its maximum operating temperature therefore protecting the CPU and the system board from overheating to ensure a safe computing environment..

Thermal Management

Select a “thermal monitor” in this field to enable the CPU's speedstep function. Restart the system then go to the operating system's “Control Panel”. Double-click “Power Options”. The “Power Options Properties” dialog box will appear. In the “Power Schemes” menu, select “Portable/Laptop”. Speedstep reduces the CPU's frequency and voltage in accordance to its load.

- Thermal Monitor 1* On die throttling.
- Thermal Monitor 2* Ratio and VID transition.

TM2 Bus Ratio

This field is used to select the frequency (bus ratio) of the throttled performance state that will be initiated when the on-die sensor turns from cool to hot.

TM2 Bus VID

This field is used to select the voltage of the throttled performance state that will be initiated when the on-die sensor turns from cool to hot.

Limit CPUID MaxVal

The CPUID instruction of some newer CPUs will return a value greater than 3. The default is Disabled because this problem does not exist in the Windows series operating systems. If you are using an operating system other than Windows, this problem may occur. To avoid this problem, enable this field to limit the return value to 3 or lesser than 3.

C1E Function

The options are Auto and Disabled.

Execute Disable Bit

When this field is set to Disabled, it will force the XD feature flag to always return to 0.

Virtualization Technology

When this field is set to Enabled, the VMM can utilize the additional hardware capabilities provided by Vanderpool Technology.

Hard Disk Boot Priority

This field is used to select the boot sequence of the hard drives. Move the cursor to this field then press <Enter>. Use the Up or Down arrow keys to select a device then press <+> to move it up or <-> to move it down the list.



The settings on the screen are for reference only. Your version may not be identical to this one.

Virus Warning

This field protects the boot sector and partition table of your hard disk drive. When this field is enabled, the Award BIOS will monitor the boot sector and partition table of the hard disk drive. If an attempt is made to write to the boot sector or partition table of the hard disk drive, the BIOS will halt the system and an error message will appear:

After seeing the error message, if necessary, you will be able to run an anti-virus program to locate and remove the problem before any damage is done.

Many disk diagnostic programs which attempt to access the boot sector table will cause the warning message to appear. If you are running such a program, we recommend that you first disable this field.

CPU L1 & L2 Cache

These fields speed up the memory access. The default value is enabled. Enable the external cache for better performance.

CPU L3 Cache

This field is used to enable or disable the CPU's L3 cache.

Hyper-Threading Technology (for Intel® Pentium® 4 Processor with Hyper-Threading Technology only)

This field is used to enable the functionality of the Intel® Pentium® 4 Processor with Hyper-Threading Technology and will appear only when using this processor.

Quick Power On Self Test

This field speeds up Power On Self Test (POST) whenever the system is powered on. The BIOS will shorten or skip some check items during POST. To attain the shortest POST time, select "Fast".

First Boot Device, Second Boot Device, Third Boot Device and Boot Other Device

Select the drive to boot first, second and third in the "First Boot Device" "Second Boot Device" and "Third Boot Device" fields respectively. The BIOS will boot the operating system according to the sequence of the drive selected. Set "Boot Other Device" to Enabled if you wish to boot from another device.

Swap Floppy Drive

When this field is enabled and the system is booting from the floppy drive, the system will boot from drive B instead of drive A. When this field is disabled and the system is booting from the floppy drive, the system will boot from drive A. You must have two floppy drives to use this function.

Boot Up Floppy Seek

When enabled, the BIOS will check whether the floppy disk drive installed is 40 or 80 tracks. Note that the BIOS cannot distinguish between 720K, 1.2M, 1.44M and 2.88M drive types as they are all 80 tracks. When disabled, the BIOS will not search for the type of floppy disk drive by track number. Note that there will not be any warning message if the drive installed is 360KB.

Boot Up NumLock Status

This allows you to determine the default state of the numeric keypad. By default, the system boots up with NumLock on wherein the function of the numeric keypad is the number keys. When set to Off, the function of the numeric keypad is the arrow keys.

Gate A20 Option

This entry allows you to select how gate A20 is handled. Gate A20 is a device used to address memory above 1 Mbyte. Initially, gate A20 was handled via the keyboard controller. Today, while keyboards still provide this support, it is more common, and much faster, for the system chipset to provide support for gate A20.

- Fast* The chipset controls Gate A20.
- Normal* A pin in the keyboard controller controls Gate A20.

Typematic Rate Setting

- Disabled* Continually holding down a key on your keyboard will cause the BIOS to report that the key is down.
- Enabled* The BIOS will not only report that the key is down, but will first wait for a moment, and, if the key is still down, it will begin to report that the key has been depressed repeatedly. For example, you would use such a feature to accelerate cursor movements with the arrow keys. You can then select the typematic rate and typematic delay in the “Typematic Rate (Chars/Sec)” and “Typematic Delay (Msec)” fields below.

Typematic Rate (Chars/Sec)

This field allows you to select the rate at which the keys are accelerated.

Typematic Delay (Msec)

This field allows you to select the delay between when the key was first depressed and when the acceleration begins.

Security Option

This field determines when the system will prompt for the password - everytime the system boots or only when you enter the BIOS setup. Set the password in the Set Supervisor/User Password submenu.

- System* The system will not boot and access to Setup will be denied unless the correct password is entered at the prompt.
- Setup* The system will boot, but access to Setup will be denied unless the correct password is entered at the prompt.

APIC Mode

Leave this field in its default setting.

MPS Version Control for OS

This field is used to select the MPS version that the system board is using.

OS Select for DRAM > 64MB

This field allows you to access the memory that is over 64MB in OS/2.

Report No FDD For WIN 95

The options are Yes and No.

Small Logo(EPA) Show

- Enabled* The EPA logo will appear during system boot-up.
- Disabled* The EPA logo will not appear during system boot-up.

Advanced Chipset Features

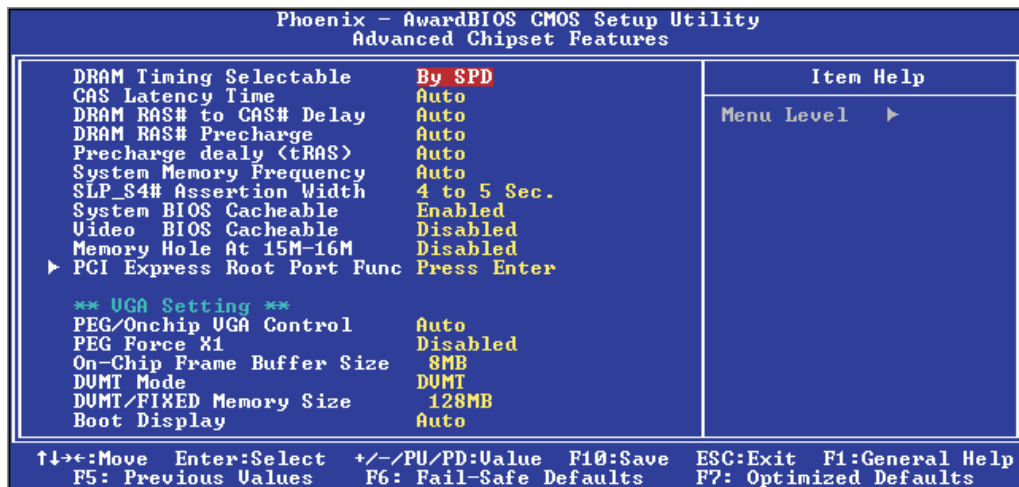

The settings on the screen are for reference only. Your version may not be identical to this one.

This section gives you functions to configure the system based on the specific features of the chipset. The chipset manages bus speeds and access to system memory resources. **These items should not be altered unless necessary.** The default settings have been chosen because they provide the best operating conditions for your system. The only time you might consider making any changes would be if you discovered some incompatibility or that data was being lost while using your system.

DRAM Timing Selectable

This field is used to select the timing of the DRAM.

By SPD The EEPROM on a DIMM has SPD (Serial Presence Detect) data structure that stores information about the module such as the memory type, memory size, memory speed, etc. When this option is selected, the system will run according to the information in the EEPROM. This option is the default setting because it provides the most stable condition for the system. The “CAS Latency Time” to “System Memory Frequency” fields will show the default settings by SPD.

Manual If you want better performance for your system other than the one “by SPD”, select “Manual” then

select the best option in the “CAS Latency Time” to “System Memory Frequency” fields.

CAS Latency Time

This field is used to select the latency between the DRAM read command and the time that the data was received.

DRAM RAS# to CAS# Delay

This field is used to select the latency between the DRAM active command and the read/write command.

DRAM RAS# Precharge

This field is used to select the idle clocks after issuing a precharge command to the DRAM.

Precharge Delay (tRAS)

The options are Auto, 4, 5, 6, 7, 8, 9, 10, 11, 12, 13, 14 and 15.

System Memory Frequency

This field is used to select the memory clock speed of the DIMM.

SLP_S4# Assertion Width

The options are 1 to 2 Sec., 2 to 3 Sec., 3 to 4 Sec. and 4 to 5 Sec.

System BIOS Cacheable

When this field is enabled, accesses to the system BIOS ROM addressed at F0000H-FFFFFFH are cached, provided that the cache controller is enabled. The larger the range of the Cache RAM, the higher the efficiency of the system.

Video BIOS Cacheable

As with caching the system BIOS, enabling the Video BIOS cache will allow access to video BIOS addressed at C0000H to C7FFFH to be cached, if the cache controller is also enabled. The larger the range of the Cache RAM, the faster the video performance.

Memory Hole At 15M-16M

In order to improve system performance, certain space in memory can be reserved for ISA cards. This memory must be mapped into the memory space below 16MB. When enabled, the CPU assumes the 15-16MB memory range is allocated to the hidden ISA address range instead of the actual system DRAM. When disabled, the CPU assumes the 15-16MB address range actually contains DRAM memory. If more than 16MB of system memory is installed, this field must be disabled to provide contiguous system memory.

PCI Express Root Port Func

Move the cursor to this field and press <Enter>. The following screen will appear:

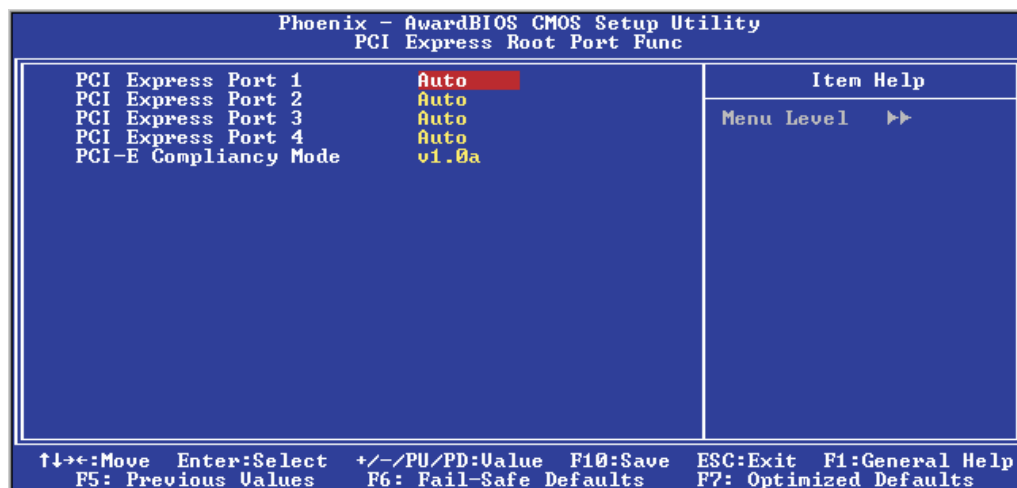

The settings on the screen are for reference only. Your version may not be identical to this one.

PCI Express Port 1 to PCI Express Port 4

These fields are used to enable or disable the PCI Express port function.

PCI-E Compliancy Mode

This field is used to select the mode for the PCI Express add-in card.

PEG/Onchip VGA Control

This field is used to select the graphics controller that will serve as the primary boot device. The options are Auto, Onchip VGA and PEG Port.

PEG Force XI

The options are Enabled and Disabled.

On-Chip Frame Buffer Size

This field is used to select the onboard VGA's frame buffer size that is shared from the system memory.

DVMT Mode

This field shows the current DVMT mode.

DVMT/Fixed Memory Size

This field is used to select the graphics memory size used by DVMT/Fixed mode.

Boot Display

This field is used to select the type of display to use when the system boots.

<i>Auto</i>	The system will automatically detect the display that is available when the system boots.
<i>CRT</i>	Select this option if you want the system to boot the CRT display.
<i>TV</i>	Select this option if you want the system to boot the TV display.
<i>EPP</i>	Select this option if you want the system to boot the EPP display.

Integrated Peripherals

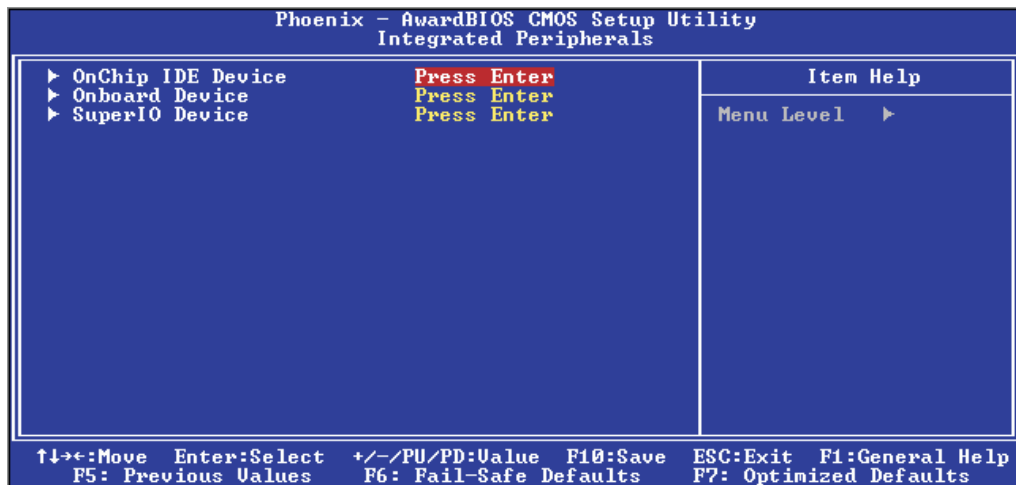

The settings on the screen are for reference only. Your version may not be identical to this one.

OnChip IDE Device

Move the cursor to this field and press <Enter>. The following screen will appear:

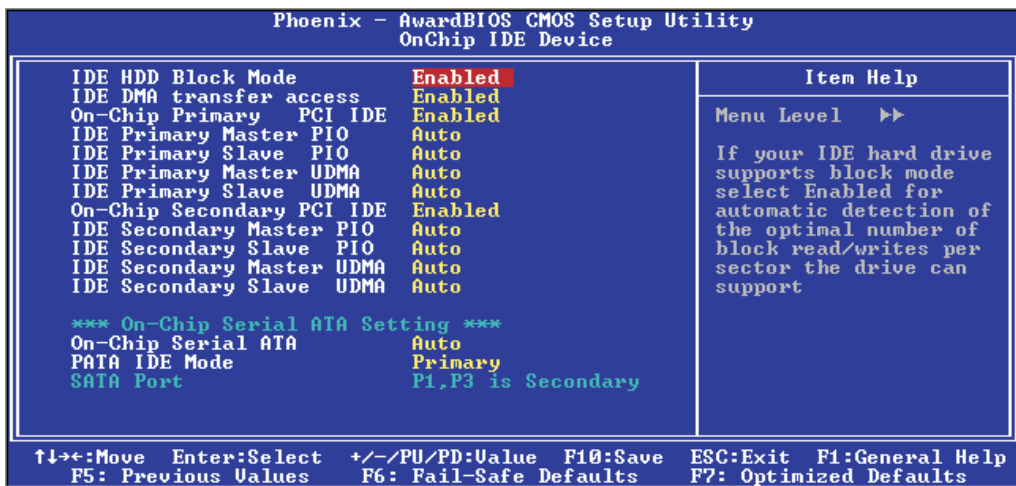

The settings on the screen are for reference only. Your version may not be identical to this one.

IDE HDD Block Mode

- Enabled* The IDE HDD uses the block mode. The system BIOS will check the hard disk drive for the maximum block size the system can transfer. The block size will depend on the type of hard disk drive.
- Disabled* The IDE HDD uses the standard mode.

IDE DMA Transfer Access

This field, when Enabled, will enhance the IDE DMA transfer of an IDE hard disk drive.

On-Chip Primary PCI IDE and On-Chip Secondary PCI IDE

These fields allow you to enable or disable the primary and secondary IDE controller. Select Disabled if you want to add a different hard drive controller.

IDE Primary Master/Slave PIO and IDE Secondary Master/Slave PIO

PIO means Programmed Input/Output. Rather than have the BIOS issue a series of commands to effect a transfer to or from the disk drive, PIO allows the BIOS to tell the controller what it wants and then let the controller and the CPU perform the complete task by themselves. Your system supports five modes, 0 (default) to 4, which primarily differ in timing. When Auto is selected, the BIOS will select the best available mode after checking your drive.

- Auto* The BIOS will automatically set the system according to your hard disk drive's timing.
- Mode 0-4* You can select a mode that matches your hard disk drive's timing. Caution: Do not use the wrong setting or you will have drive errors.

IDE Primary Master/Slave UDMA and IDE Secondary Master/Slave UDMA

These fields allow you to set the Ultra DMA in use. When Auto is selected, the BIOS will select the best available option after checking your hard drive or CD-ROM.

<i>Auto</i>	The BIOS will automatically detect the settings for you.
<i>Disabled</i>	The BIOS will not detect these categories.

On-Chip Serial ATA Setting

On-Chip Serial ATA

<i>Disabled</i>	Disables the onboard SATA.
<i>Auto</i>	The system will detect the existing SATA and IDE drives then automatically set them to the available master/slave mode.
<i>Combined Mode</i>	This option allows you to use both IDE and SATA drives; allowing a maximum of 4 drives - 1 IDE Master, 1 IDE Slave and 2 SATA. You must manually set the SATA and PATA drives' mode in the "PATA IDE Mode" and "SATA Port" fields.
<i>Enhanced Mode</i>	This option allows you to use both IDE and SATA drives; allowing a maximum of 6 drives - 1 IDE Master, 1 IDE Slave and 4 SATA.
<i>SATA Only</i>	This option automatically sets the SATA drives to Primary Master mode. Since the SATA drives are in Master mode, you cannot set the IDE drive to Master mode.

PATA IDE Mode

This field is used to select the function mode for the IDE 1 connector and its relation to the SATA ports.

<i>Primary</i>	IDE 1 serves as Primary Master and Primary Slave channel. SATA 2 and SATA 4 serve as Secondary Master and Secondary Slave channel. SATA 1 and SATA 3 are disabled.
----------------	--------------------------------------------------------------------------------------------------------------------------------------------------------------------

Secondary IDE 1 serves as Secondary Master and Secondary Slave channel. SATA 1 and SATA 3 serve as Primary Master and Primary Slave channel. SATA 2 and SATA 4 are disabled.

SATA Port

If the “PATA IDE Mode” field is set to Primary, this field will show “P1, P3 is Secondary”; meaning SATA 2 and SATA 4 are Secondary.

If the “PATA IDE Mode” field is set to Secondary, this field will show “P0, P2 is Primary”; meaning SATA 1 and SATA 3 are Primary.

Onboard Device

Move the cursor to this field and press <Enter>. The following screen will appear:

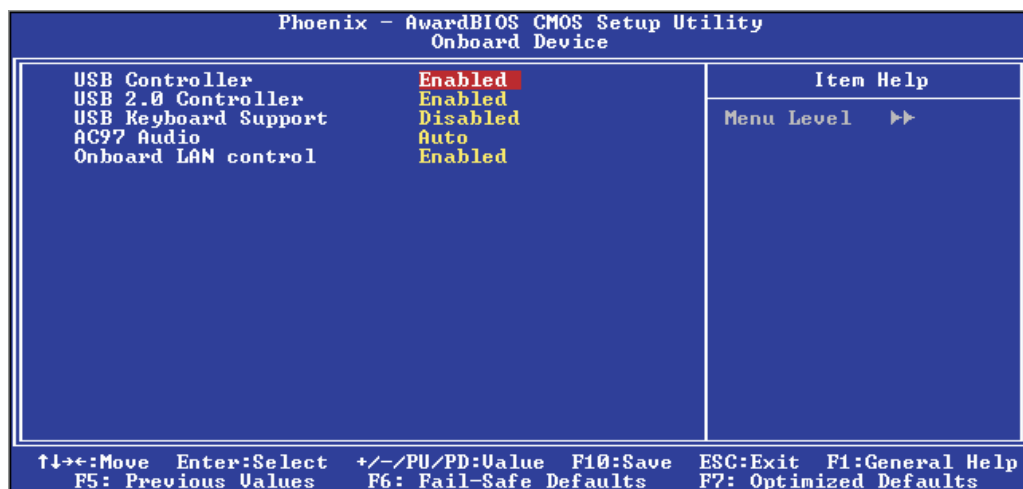

The settings on the screen are for reference only. Your version may not be identical to this one.

USB Controller

Enabled Enables the onboard USB.

Disabled Disables the onboard USB.

USB 2.0 Controller

If you are using a USB 2.0 device, this field must be set to Enabled.

USB Keyboard Support

By default, this field is Disabled. However, if you are using a USB keyboard under DOS, make sure to enable this function.

AC97 Audio

Auto Select this option when using the onboard audio CODEC.

Disabled Select this option when using a PCI sound card.

Onboard LAN Control

This field is used to enable or disable the onboard LAN.

Super IO Device

Move the cursor to this field and press <Enter>. The following screen will appear:

```

Phoenix - AwardBIOS CMOS Setup Utility
SuperIO Device

POWER ON Function      BUTTON ONLY
KB Power ON Password  Enter
Hot Key Power ON      Ctrl-F1
Onboard FDC Controller Enabled
Onboard Serial Port 1 3F8/IRQ4
Onboard Serial Port 2 2F8/IRQ3
UART Mode Select      Normal
RxD , TxD Active      Hi,Lo
IR Transmission Delay Enabled
UR2 Duplex Mode       Half
Use IR Pins           IR-Rx2Tx2
Onboard Parallel Port 378/IRQ7
Parallel Port Mode    SPP
EPP Mode Select       EPP1.7
ECP Mode Use DMA      3
PWRON After PWR-Fail Off

Item Help
Menu Level  >>

↑↓←→:Move  Enter:Select  +/-/PU/PD:Value  F10:Save  ESC:Exit  F1:General Help
F5: Previous Values  F6: Fail-Safe Defaults  F7: Optimized Defaults

```

The settings on the screen are for reference only. Your version may not be identical to this one.

Power On Function

This field allows you to use the keyboard or PS/2 mouse to power-on the system.

- Button only* Default setting. Uses the power button to power on the system.
- Password* When this option is selected, set the password you would like to use to power-on the system in the “KB Power On Password” field.
- Hot Key* When this option is selected, select the function key you would like to use to power-on the system in the “Hot Key Power On” field.
- Mouse Move* When this option is selected, move the mouse to power-on the system.
- Mouse Click* When this option is selected, click the mouse button to power-on the system.
- Any Key* Press any key to power-on the system.
- Keyboard 98* When this option is selected, press the “wake up” key of the Windows® 98 compatible keyboard to power-on the system.

KB Power On Password

Move the cursor to this field and press <Enter>. Enter your password. You can enter up to 5 characters. Type in exactly the same password to confirm, then press <Enter>.

The power button will not function once a keyboard password has been set in this field. You must type the correct password to power-on the system. If you forgot the password, power-off the system and remove the battery. Wait for a few seconds and install it back before powering-on the system.

Hot Key Power On

This field is used to select a function key that you would like to use to power-on the system.

Onboard FDC Controller

Enabled Enables the onboard floppy disk controller.

Disabled Disables the onboard floppy disk controller.

Onboard Serial Port 1 and Onboard Serial Port 2

Auto The system will automatically select an I/O address for the onboard serial port 1 and serial port 2.

3F8/IRQ4, 2F8/IRQ3, 3E8/IRQ4, 2E8/IRQ3 Allows you to manually select an I/O address for the onboard serial port 1 and serial port 2.

Disabled Disables the onboard serial port 1 and/or serial port 2.

UART Mode Select

This field is used to select the type of IrDA standard supported by your IrDA device. For better transmission of data, your IrDA peripheral device must be within a 30° angle and within a distance of 1 meter.

RxD, TxD Active

The options are Hi, Lo; Lo, Hi; Lo, Lo; and Hi, Hi.

IR Transmission Delay

If this field is Enabled, transmission of data will be slower. This is recommended when you encounter transmission problem with your device. The options are: Enabled and Disabled.

UR2 Duplex Mode

- Half* Data is completely transmitted before receiving data.
- Full* Transmits and receives data simultaneously.

Use IR Pins

The options are IR-Rx2Tx2 and Rx2Tx2D2.

Onboard Parallel Port

- 378/IRQ7, 3BC/IRQ7, 278/IRQ5* Selects the I/O address and IRQ for the onboard parallel port.
- Disabled* Disables the onboard parallel port.

Parallel Port Mode

The options are SPP, EPP, ECP and ECP+EPP. These apply to a standard specification and will depend on the type and speed of your device. Refer to your peripheral's manual for the best option.

SPP

Allows normal speed operation but in one direction only.

“ECP (Extended Capabilities Port)”

Allows parallel port to operate in bidirectional mode and at a speed faster than the normal mode's data transfer rate.

“EPP (Enhanced Parallel Port)”

Allows bidirectional parallel port operation at maximum speed.

EPP Mode Select

This field is used to select the EPP mode.

ECP Mode Use DMA

This is used to select a DMA channel of the parallel port.

PWRON After PWR-Fail

- Off* When power returns after an AC power failure, the system's power is off. You must press the Power button to power-on the system.
- On* When power returns after an AC power failure, the system will automatically power-on.
- Former-Sts* When power returns after an AC power failure, the system will return to the state where you left off before power failure occurs. If the system's power is off when AC power failure occurs, it will remain off when power returns. If the system's power is on when AC power failure occurs, the system will power-on when power returns.

Power Management Setup

The Power Management Setup allows you to configure your system to most effectively save energy.

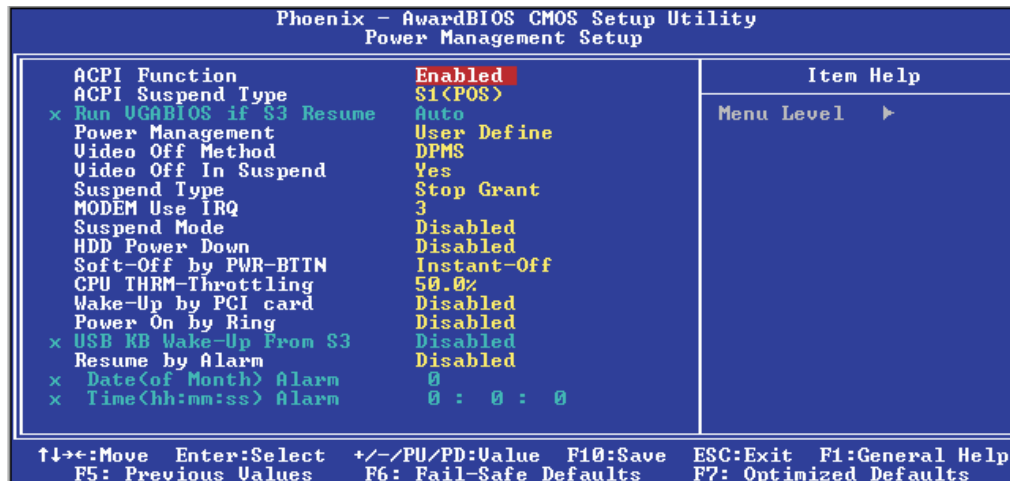

The settings on the screen are for reference only. Your version may not be identical to this one.

ACPI Function

This function should be enabled only in operating systems that support ACPI. Currently, only Windows® 2000/ME/XP supports this function. If you want to use the Suspend to RAM function, make sure this field is enabled then select “S3(STR)” in the “ACPI Suspend Type” field.

ACPI Suspend Type

This field is used to select the type of Suspend mode.

- S1(POS) Enables the Power On Suspend function.
- S3(STR) Enables the Suspend to RAM function.

Run VGABIOS if S3 Resume

When this field is set to Auto, the system will initialize the VGA BIOS when it wakes up from the S3 state. This can be configured only if the “ACPI Suspend Type” field is set to “S3(STR)”.

Power Management

This field allows you to select the type (or degree) of power saving by changing the length of idle time that elapses before the Suspend mode and HDD Power Down fields are activated.

<i>Min Saving</i>	Minimum power saving time for the Suspend Mode (1 hour) and HDD Power Down (15 min.)
<i>Max Saving</i>	Maximum power saving time for the. Suspend Mode and HDD Power Down = 1 min.
<i>User Define</i>	Allows you to set the power saving time in the "Suspend Mode" and "HDD Power Down" fields.

Video Off Method

This determines the manner in which the monitor is blanked.

<i>V/H SYNC + Blank</i>	This selection will cause the system to turn off the vertical and horizontal synchronization ports and write blanks to the video buffer.
<i>Blank Screen</i>	This option only writes blanks to the video buffer.
<i>DPMS</i>	Initializes display power management signaling. Use this option if your video board supports it.

Video Off In Suspend

This field is used to activate the video off feature when the system enters the Suspend mode. The options are Yes and No.

Suspend Type

The options are Stop Grant and PwrOn Suspend.

MODEM Use IRQ

This field is used to set an IRQ channel for the modem installed in your system.

Suspend Mode

This is selectable only when the Power Management field is set to User Define. When the system enters the Suspend mode according to the power saving time selected, the CPU and onboard peripherals will be shut off.

HDD Power Down

This is selectable only when the Power Management field is set to User Define. When the system enters the HDD Power Down mode according to the power saving time selected, the hard disk drive will be powered down while all other devices remain active.

Soft-Off by PWR-BTTN

This field allows you to select the method of powering off your system.

Delay 4 Sec. Regardless of whether the Power Management function is enabled or disabled, if the power button is pushed and released in less than 4 sec, the system enters the Suspend mode. The purpose of this function is to prevent the system from powering off in case you accidentally “hit” or pushed the power button. Push and release again in less than 4 sec to restore. Pushing the power button for more than 4 seconds will power off the system.

Instant-Off Pressing and then releasing the power button at once will immediately power off your system.

CPU Thermal-Throttling

Thermal throttling regulates the thermal environment by alternating between running the processor at full speed and placing the processor in a sleep state whenever the upper limits of the thermal envelop are reached.

Wake-Up By PCI Card

Enabled This field should be set to Enabled only if your PCI card such as LAN card or modem card uses the PCI PME (Power Management Event) signal to remotely wake up the system. Access to the LAN card or PCI card will cause the system to wake up. Refer to the card's documentation for more information.

Disabled The system will not wake up despite access to the PCI card.

Power On By Ring

Set this field to Enabled to use the modem ring-on function. This will allow your system to power-on to respond to calls coming from an external modem.

USB KB Wake-Up From S3

This field, when enabled, allows you to use a USB keyboard to wake up a system that is in the S3 (STR - Suspend To RAM) state. This can be configured only if the "ACPI Suspend Type" field is set to "S3(STR)".

Resume By Alarm

Enabled When Enabled, you can set the date and time you would like the Soft Power Down (Soft-Off) PC to power-on in the "Date (of Month) Alarm" and "Time (hh:mm:ss) Alarm" fields. However, if the system is being accessed by incoming calls or the network (Resume On Ring/LAN) prior to the date and time set in these fields, the system will give priority to the incoming calls or network.

Disabled Disables the automatic power-on function. (default)

Date (of Month) Alarm

0 The system will power-on everyday according to the time set in the "Time (hh:mm:ss) Alarm" field.

1-31 Select a date you would like the system to power-on. The system will power-on on the set date, and time set in the "Time (hh:mm:ss) Alarm" field.

Time (hh:mm:ss) Alarm

This is used to set the time you would like the system to power-on. If you want the system to power-on everyday as set in the “Date (of Month) Alarm” field, the time set in this field must be later than the time of the RTC set in the Standard CMOS Features submenu.

PnP/PCI Configurations

This section describes configuring the PCI bus system. It covers some very technical items and it is strongly recommended that only experienced users should make any changes to the default settings.

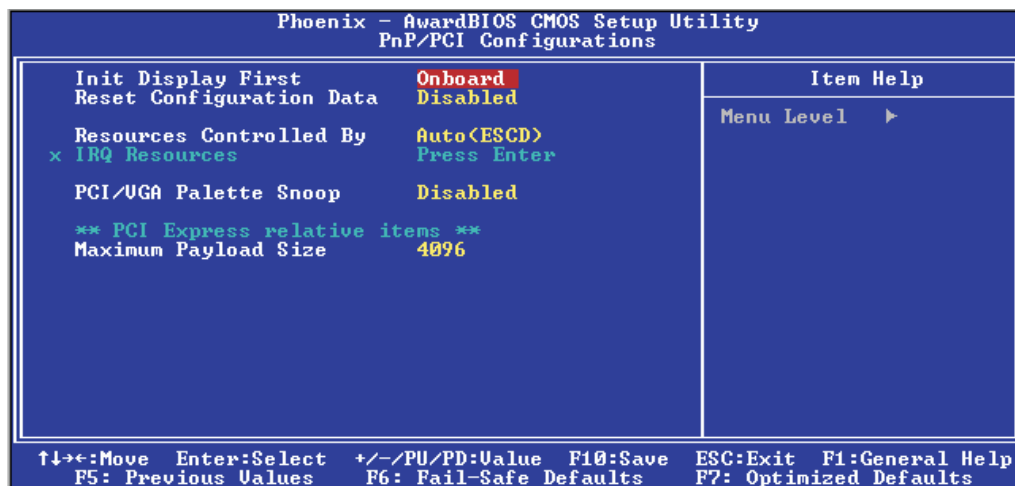

The settings on the screen are for reference only. Your version may not be identical to this one.

Init Display First

This field is used to select whether to initialize the onboard VGA, PCI Express or PCI first when the system boots.

- Onboard* When the system boots, it will first initialize the onboard VGA.
- PCIEx* When the system boots, it will first initialize the PCI Express x16 graphics card.
- PCI Slot* When the system boots, it will first initialize PCI.

Reset Configuration Data

- Enabled* The BIOS will reset the Extended System Configuration Data (ESCD) once automatically. It will then recreate a new set of configuration data.
- Disabled* The BIOS will not reset the configuration data.

Resources Controlled By

The Award Plug and Play BIOS has the capability to automatically configure all of the boot and Plug and Play compatible devices.

- Auto* The system will automatically detect the settings for you.
- Manual* Choose the specific IRQ in the “IRQ Resources” field respectively.

IRQ Resources

Move the cursor to this field and press <Enter>. This field is used to set each system interrupt to either Reserved or PCI Device.

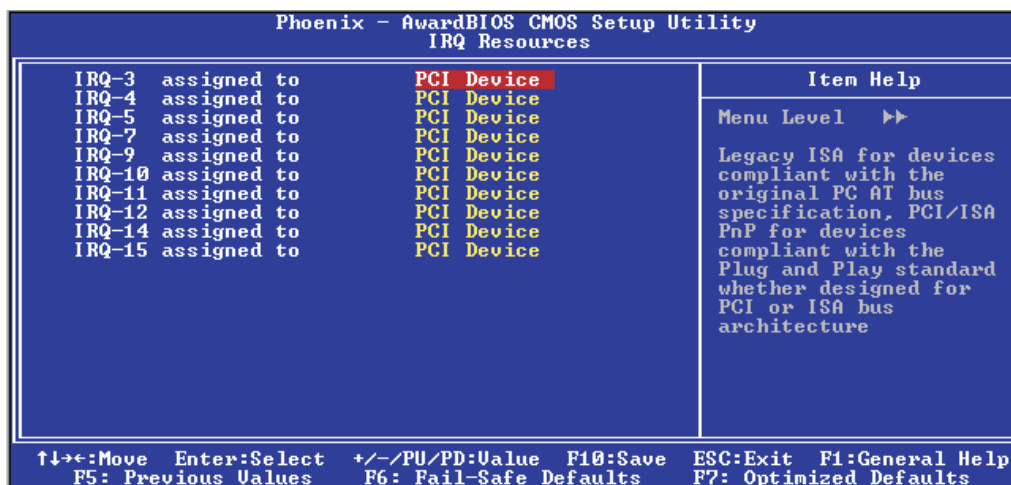

The settings on the screen are for reference only. Your version may not be identical to this one.

PCI/VGA Palette Snoop

This field determines whether the MPEG ISA/VESA VGA cards can work with PCI/VGA or not. The default value is Disabled.

- Enabled* MPEG ISA/VESA VGA cards work with PCI/VGA.
- Disabled* MPEG ISA/VESA VGA cards does not work with PCI/VGA.

Maximum Payload Size

This field is used to select the maximum TLP payload size of the PCI Express devices. The unit is byte.

PC Health Status

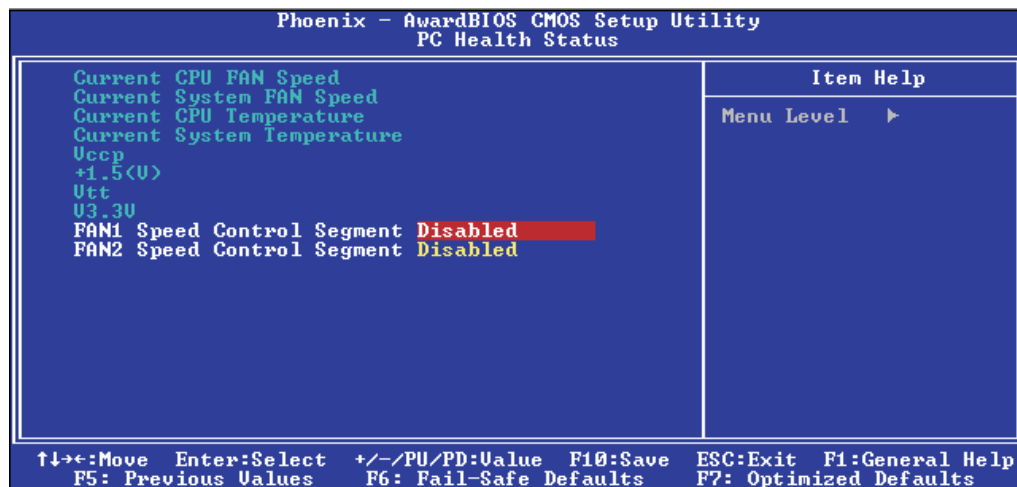

The settings on the screen are for reference only. Your version may not be identical to this one.

Current CPU Fan Speed to V3.3V

These fields will show the fan speed, temperature and output voltage of the monitored devices or components.

Fan1 Speed Control Segment

This field is used to select the CPU temperature that will allow the CPU fan to rotate at full speed. The system will automatically adjust the CPU fan's speed according to the temperature.

Fan2 Speed Control Segment

This field is used to select the system's temperature that will allow the system fan to rotate at full speed. The system will automatically adjust the system fan's speed according to the temperature.

**Note:**

The onboard hardware monitor function is capable of detecting "system health" conditions but if you want a warning message to pop-up or a warning alarm to sound when an abnormal condition occurs, you must install the Hardware Monitor utility. This utility is included in the CD that came with the system board. Refer to the Hardware Monitor section in chapter 4 for more information.

Frequency/Voltage Control

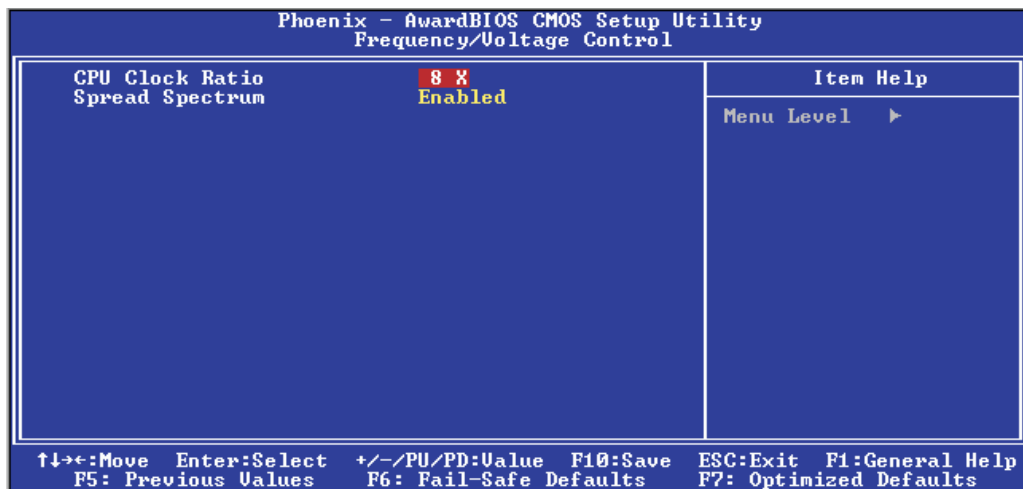

The settings on the screen are for reference only. Your version may not be identical to this one.

CPU Clock Ratio

This field is used to select the CPU's frequency ratio.



Important:

The frequency ratio of some processors may have been locked by the manufacturer. If you are using this kind of processor, setting a frequency ratio for the processor will have no effect. The system will instead use its factory default ratio.

Spread Spectrum

Leave this field in its default setting. Do not alter this setting unless advised by an engineer or technician.

Load Fail-Safe Defaults

The “Load Fail-Safe Defaults” option loads the troubleshooting default values permanently stored in the ROM chips. These settings are not optimal and turn off all high performance features. You should use these values only if you have hardware problems. Highlight this option in the main menu and press <Enter>.

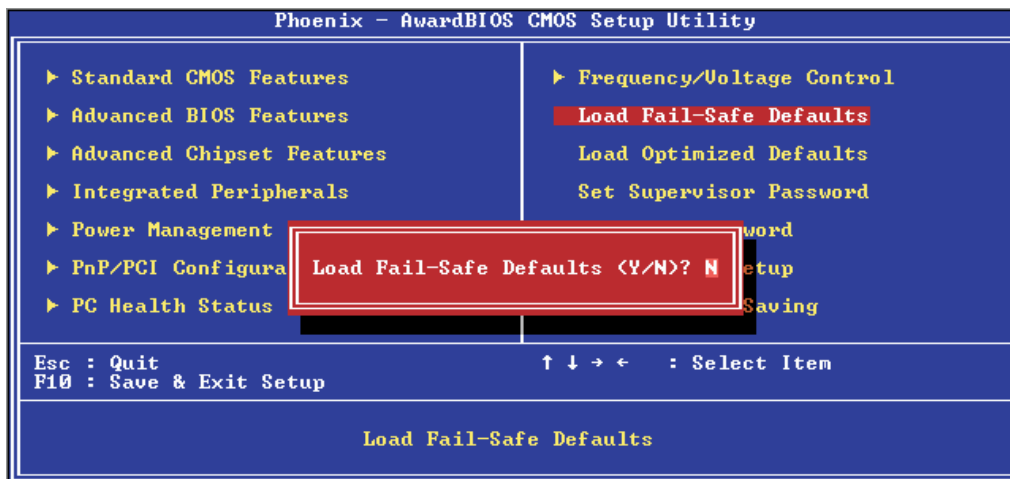

If you want to proceed, type <Y> and press <Enter>. The default settings will be loaded.

Set Supervisor Password

If you want to protect your system and setup from unauthorized entry, set a supervisor's password with the "System" option selected in the Advanced BIOS Features. If you want to protect access to setup only, but not your system, set a supervisor's password with the "Setup" option selected in the Advanced BIOS Features. You will not be prompted for a password when you cold boot the system.

Use the arrow keys to highlight "Set Supervisor Password" and press <Enter>.

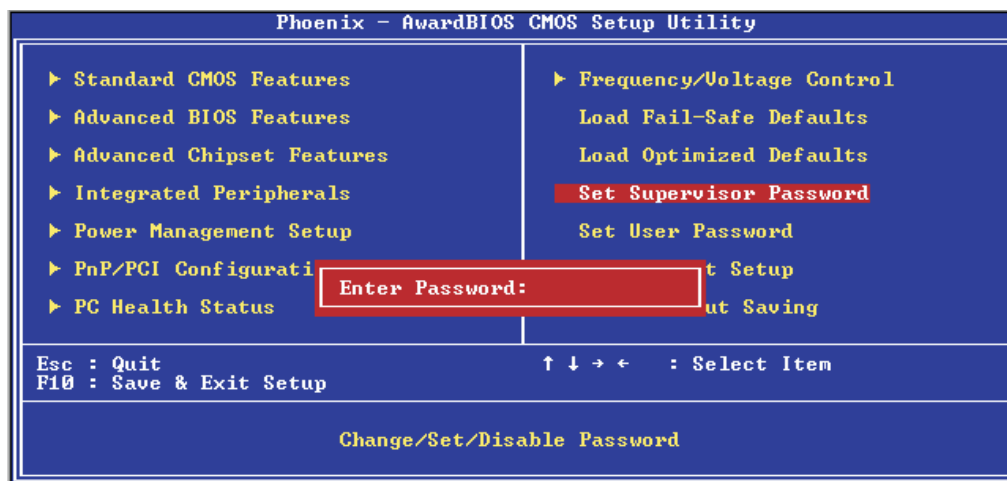

Type in the password. You are limited to eight characters. When done, the message below will appear:

Confirm Password:

You are asked to verify the password. Type in exactly the same password. If you type in a wrong password, you will be prompted to enter the correct password again. To delete or disable the password function, highlight "Set Supervisor Password" and press <Enter>, instead of typing in a new password. Press the <Esc> key to return to the main menu.

Set User Password

If you want another user to have access only to your system but not to setup, set a user's password with the "System" option selected in the Advanced BIOS Features. If you want a user to enter a password when trying to access setup, set a user's password with the "Setup" option selected in the Advanced BIOS Features.

Using user's password to enter Setup allows a user to access only "Set User Password" that appears in the main menu screen. Access to all other options is denied.

Use the arrow keys to highlight "Set User Password" and press <Enter>.

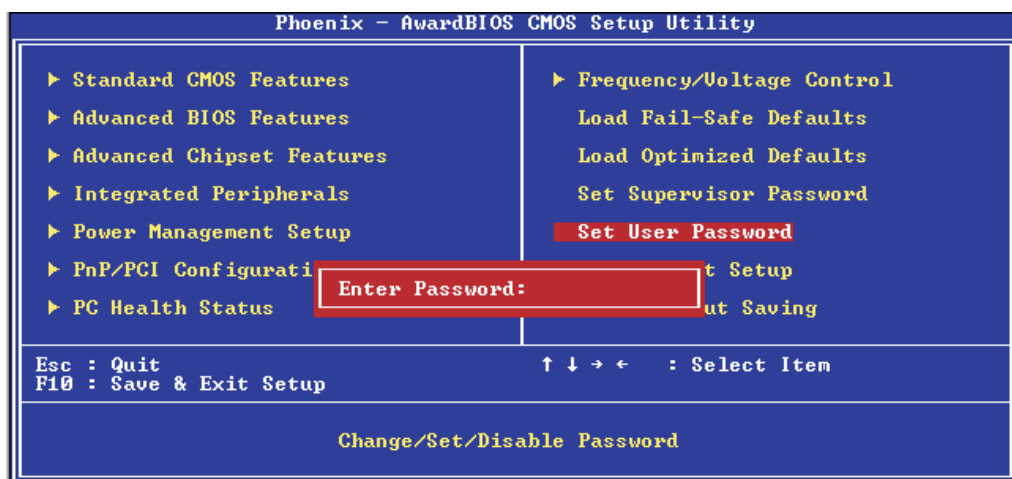

Type in the password. You are limited to eight characters. When done, the message below will appear:

Confirm Password:

You are asked to verify the password. Type in exactly the same password. If you type in a wrong password, you will be prompted to enter the correct password again. To delete or disable the password function, highlight "Set User Password" and press <Enter>, instead of typing in a new password. Press the <Esc> key to return to the main menu.

Exit Without Saving

When you do not want to save the changes you have made, highlight “Exit Without Saving” and press <Enter>.

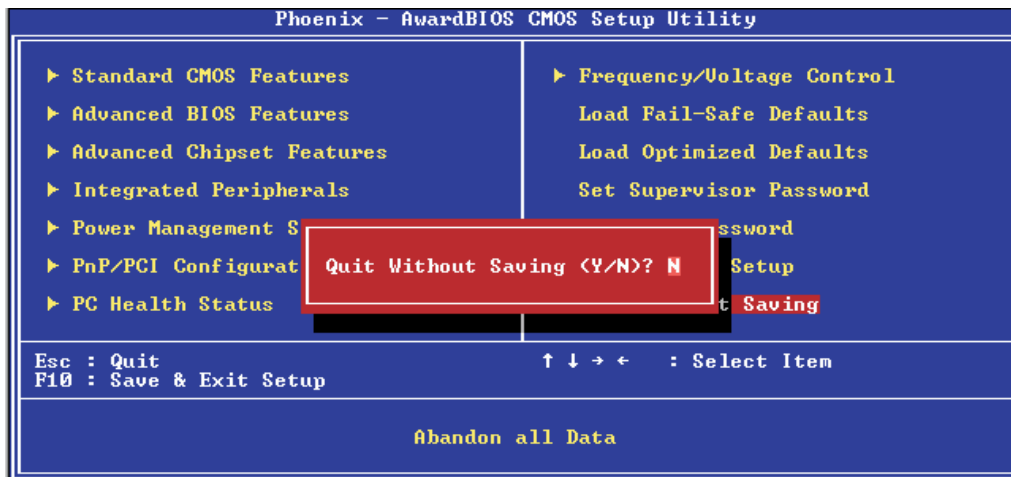

Type “Y” and press <Enter>. The system will reboot and you will once again see the initial diagnostics on the screen. If you wish to make any changes to the setup, press <Ctrl> <Alt> <Esc> simultaneously or after memory testing is done.

Updating the BIOS

To update the BIOS, you will need the new BIOS file and a flash utility, AWDFLASH.EXE. You can download them from DFI's web site or contact technical support or your sales representative.

1. Save the new BIOS file along with the flash utility AWDFLASH.EXE to a floppy disk.
2. Reboot the system and enter the Award BIOS Setup Utility to set the first boot drive to "Floppy".
3. Save the setting and reboot the system.
4. After the system booted from the floppy disk, execute the flash utility by typing AWDFLASH.EXE. The following screen will appear:

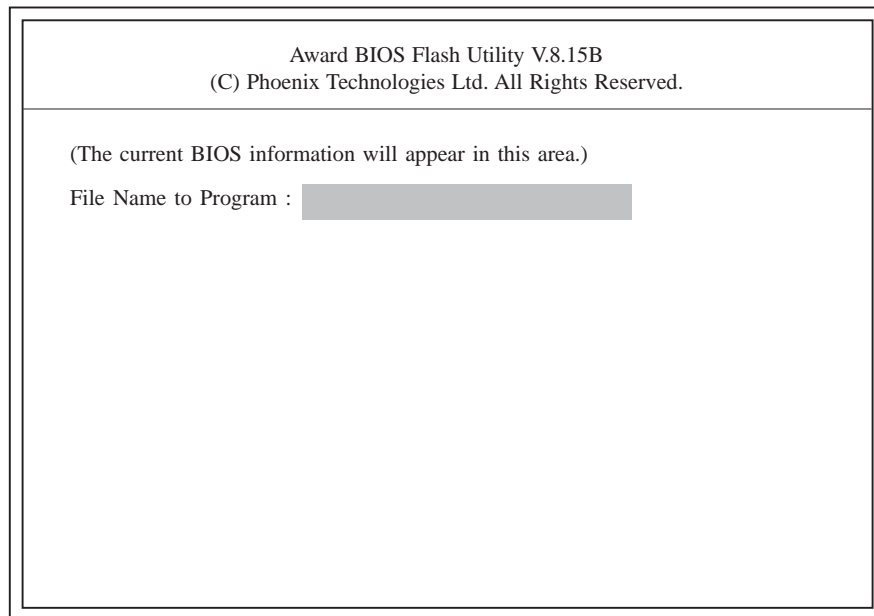

5. Type the new BIOS file name onto the gray area that is next to "File Name to Program" then press <Enter>.

6. The following will appear:

Do You Want to Save BIOS (Y/N)

This question refers to the current existing BIOS in your system. We recommend that you save the current BIOS and its flash utility; just in case you need to reinstall the BIOS. To save the current BIOS, press <Y> then enter the file name of the current BIOS. Otherwise, press <N>.

7. The following will then appear:

Press "Y" to Program or "N" to Exit

8. Press <Y> to flash the new BIOS.

Chapter 4 - Supported Software

Drivers, Utilities and Software Applications

The CD that came with the system board contains drivers, utilities and software applications required to enhance the performance of the system board.

Insert the CD into a CD-ROM drive. The autorun screen (Main Board Utility CD) will appear. If after inserting the CD, "Autorun" did not automatically start (which is, the Mainboard Utility CD screen did not appear), please go directly to the root directory of the CD and double-click "Setup".



Intel Chipset Software Installation Utility

The Intel Chipset Software Installation Utility is used for updating Windows® INF files so that the Intel chipset can be recognized and configured properly in the system.

To install the utility, click “Intel Chipset Software Installation Utility” on the main menu.

1. The installation wizard will extract the files needed to install the utility. After all files have been extracted, click Next.

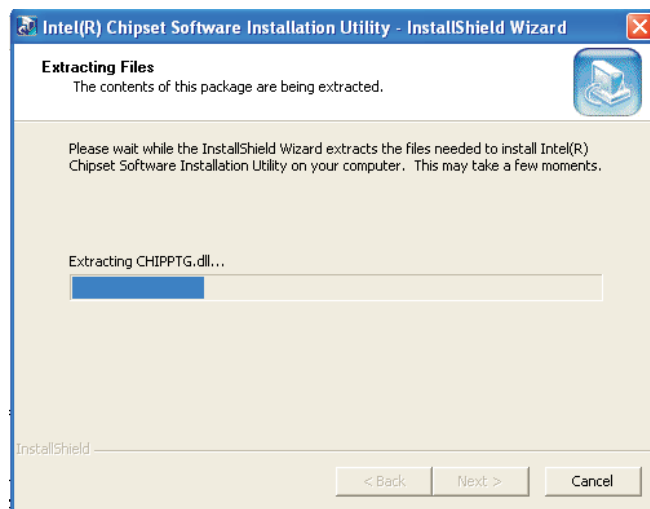

2. Setup is now ready to install the utility. Click Next.

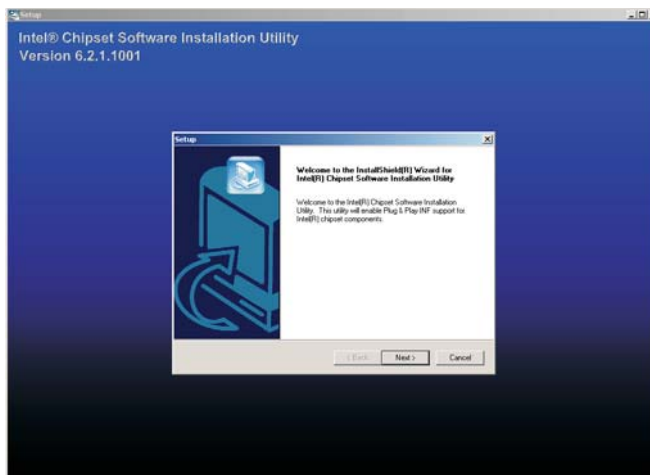

Supported Software

3. Read the license agreement then click Yes.

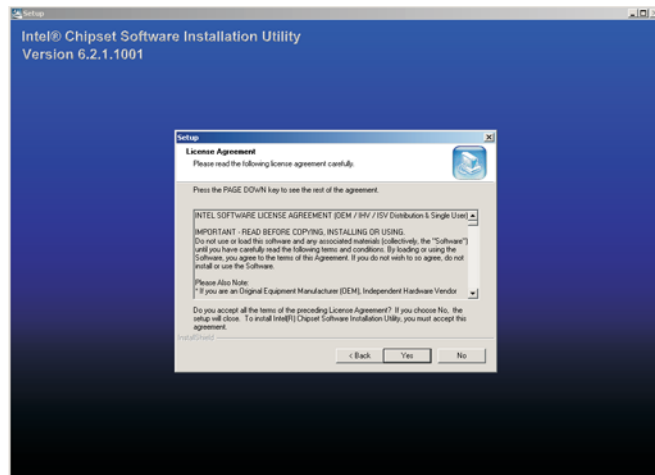

4. Go through the readme document to view system requirements and installation information then click Next.

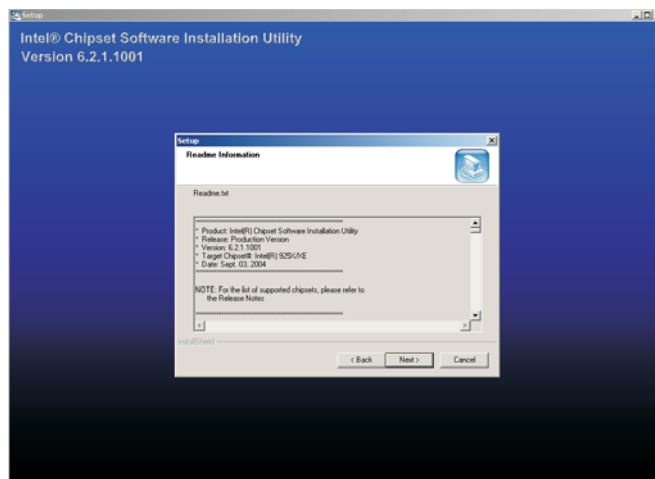

5. Setup will now install the files for the utility.

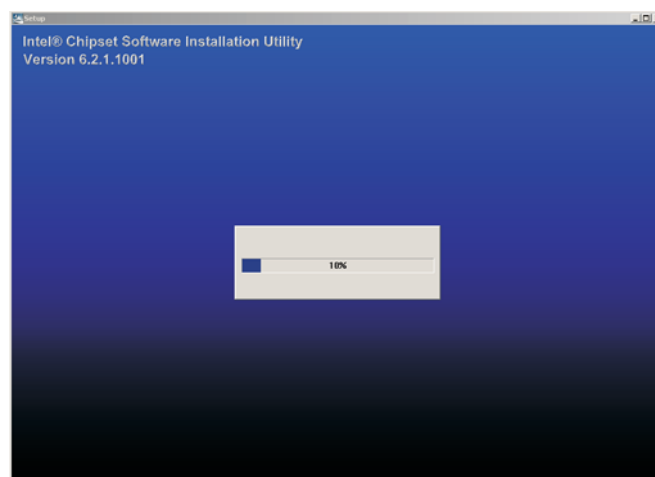

6. Follow the prompts on the screen to complete installation.
7. Click “Yes, I want to restart my computer now” then click Finish.

Restarting the system will allow the utility to take effect.

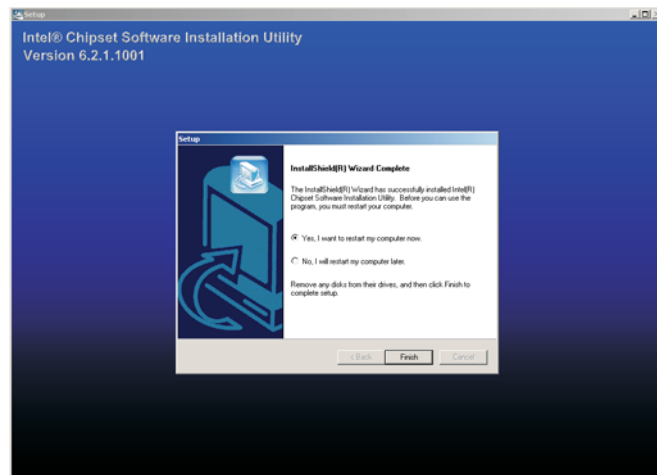

Audio Drivers

To install the driver, click “Audio Drivers” on the main menu.

1. The installation wizard will extract the files needed to install AC97 audio.

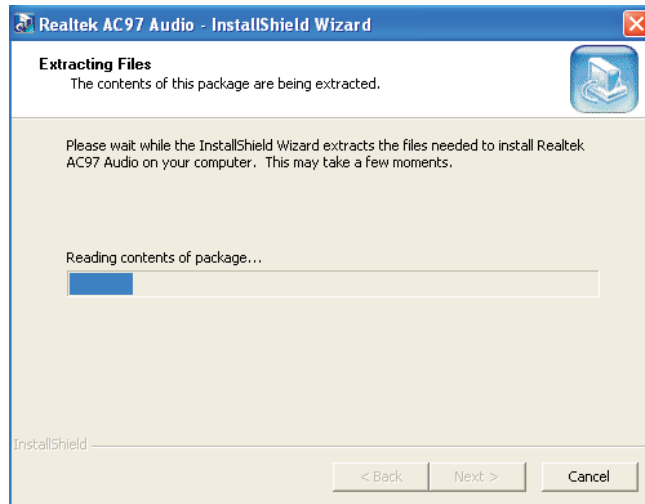

2. Setup is now ready to install AC97 audio. Click Next. Setup will install the files for the driver.



3. Click “Yes, I want to restart my computer now” then click Finish.

Restarting the system will allow the new software installation to take effect.

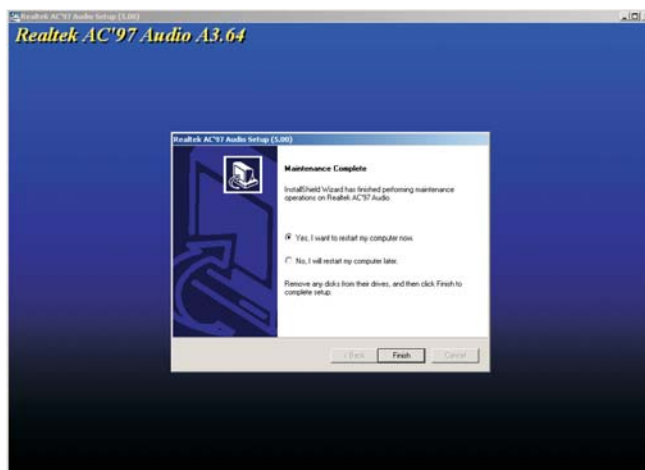

Intel Graphics Drivers

To install the driver, click “Intel Graphics Drivers” on the main menu.

1. Setup is now ready to install the Intel Graphics Media Accelerator driver. Click Next.

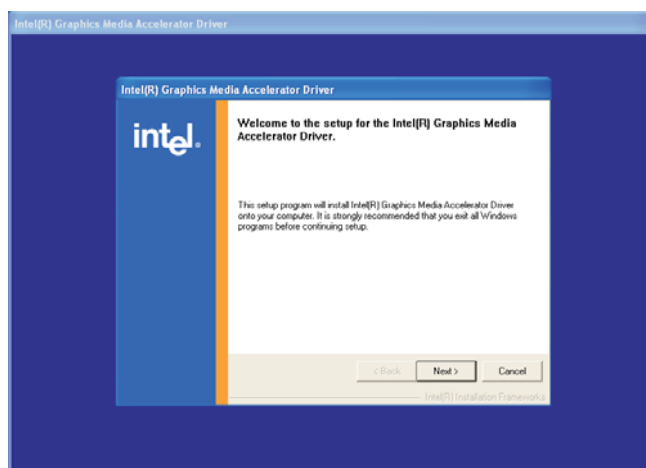

2. Read the license agreement then click Yes.

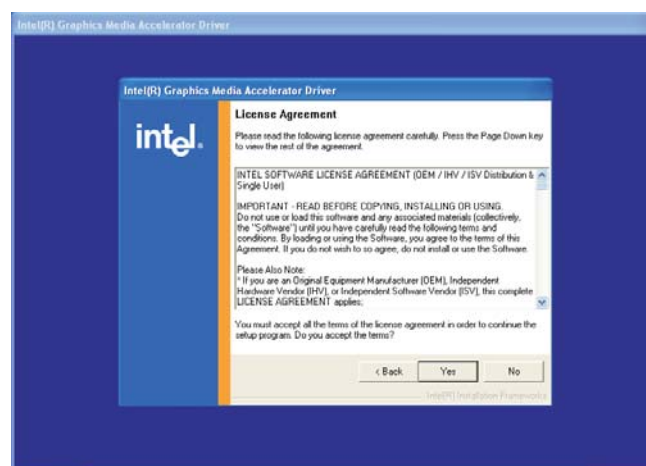

3. Follow the prompts on the screen to complete installation.
4. Click “Yes, I want to restart my computer now” then click Finish.

Restarting the system will allow the driver to take effect.

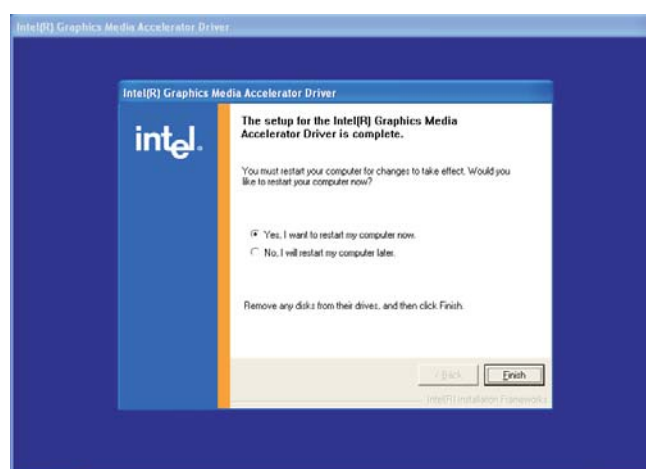

LAN Drivers

To install the driver, click “LAN Drivers” on the main menu.

1. The Marvell Miniport Driver Setup is now preparing the InstallShield Wizard.

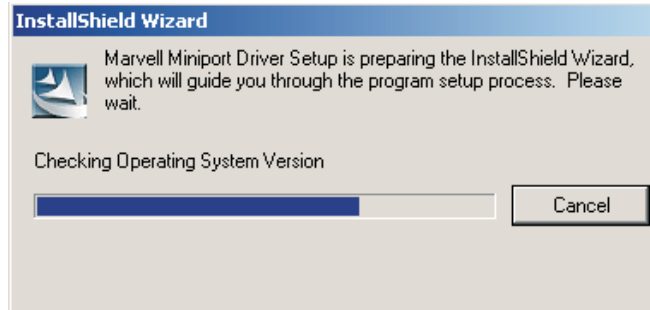

2. Setup is now ready to install the driver. Click Next.



3. Click Install to begin installation.

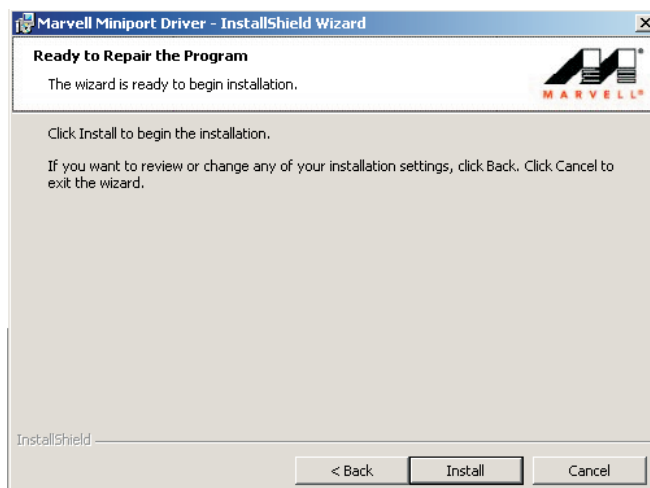

- The driver is currently being installed.

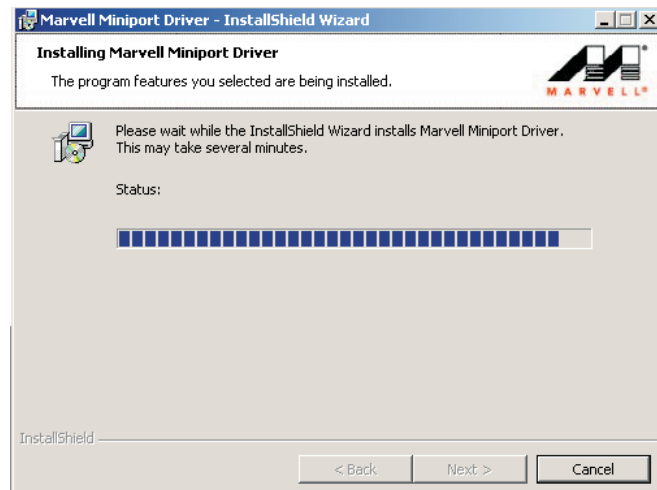

- Click Finish.
- Reboot the system for the driver to take effect.

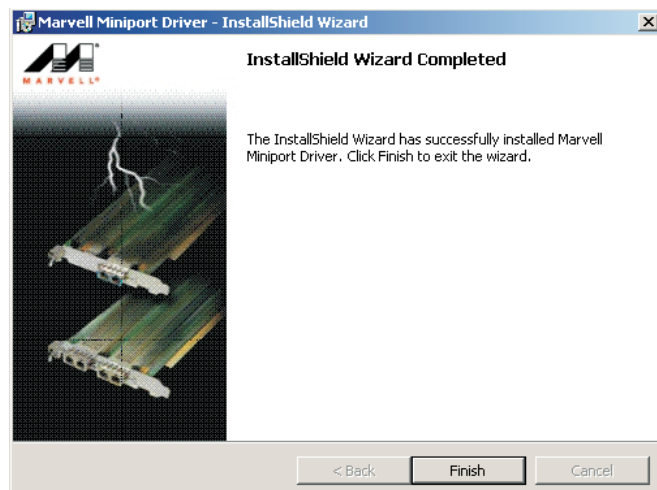

MyGuard H/W Monitor

The MyGuard H/W Monitor utility is capable of monitoring the system's temperature, fan speed, voltage, etc. and allows you to manually set a range (Highest and Lowest Limit) to the items being monitored. If the settings/values are over or under the set range, a warning message will pop-up. The utility can also be configured so that a beeping alarm will sound whenever an error occurs. We recommend that you use the "Default Setting" which is the ideal setting that would keep the system in good working condition.

To install the utility, click "MyGuard H/W Monitor" on the main menu.

1. Select the appropriate option then click Next.

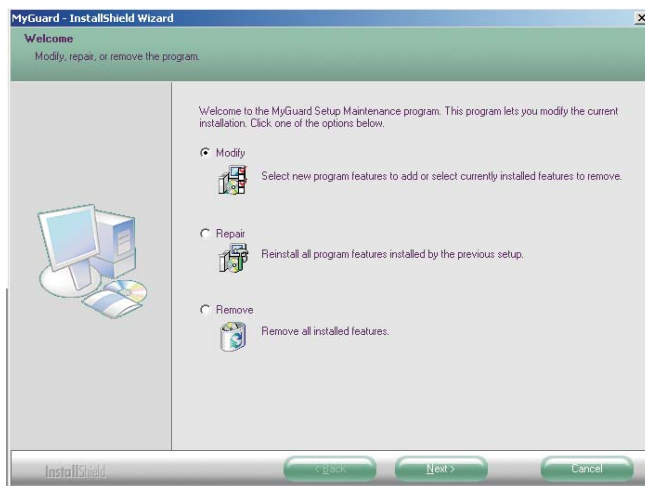

2. Select the features you want to install then click Next.

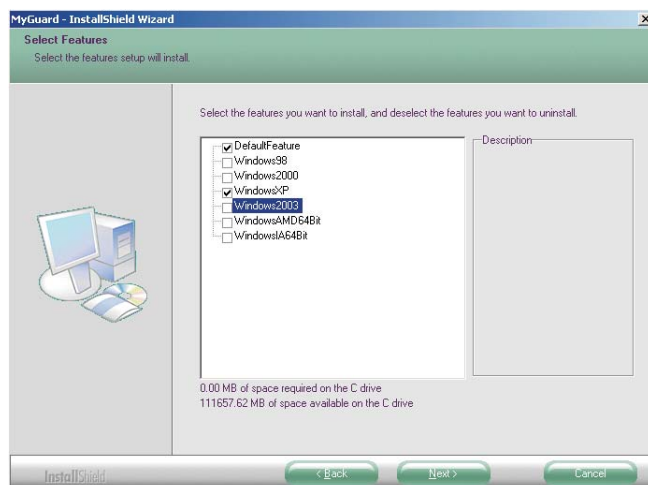

5. Click Finish to exit the wizard.

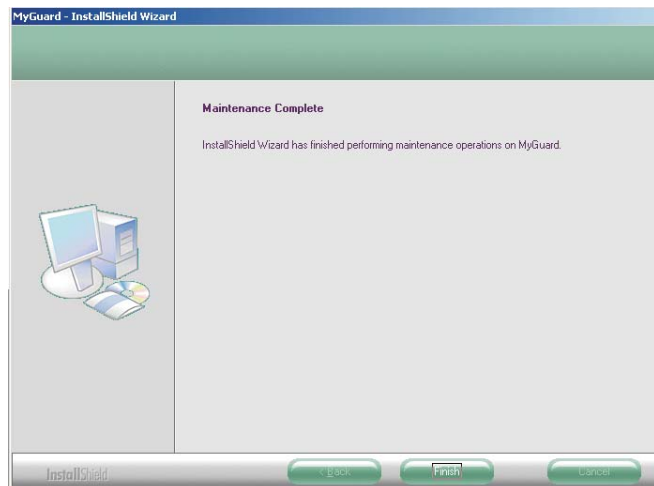

Microsoft DirectX 9.0C Driver

To install, click “Microsoft DirectX 9.0C Driver” on the main menu.

1. Read the license agreement then click “I accept the agreement”. Click Next.

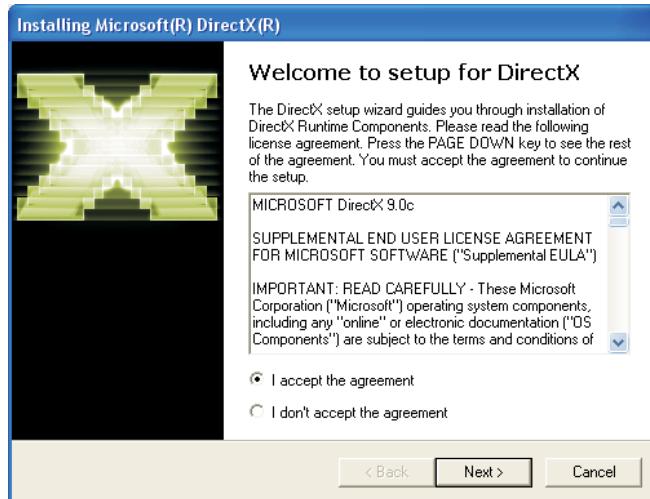

2. You are now ready to install DirectX 9.0C. Click Next.

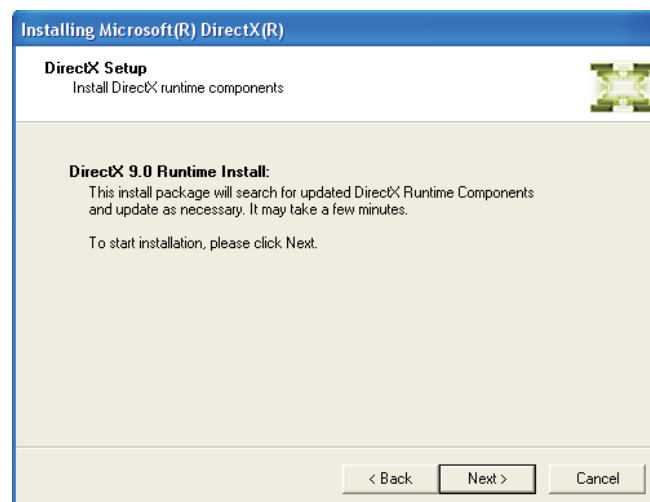

3. Click Finish. Reboot the system for DirectX to take effect.

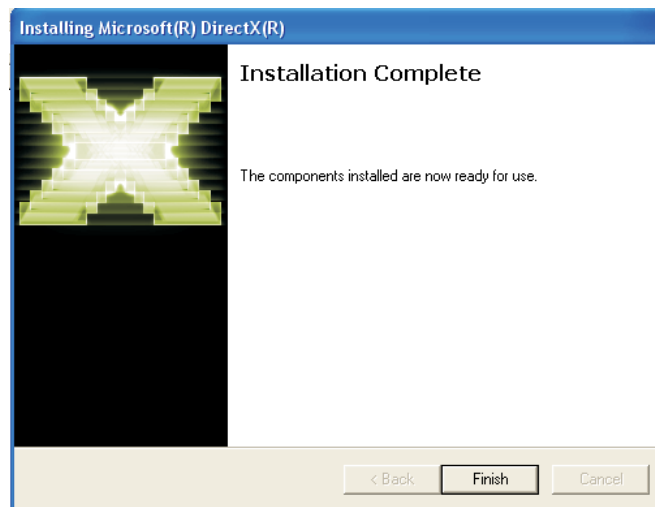

Intel USB 2.0 Drivers

The Intel chipset does not support USB 2.0 drivers for Windows® 98 SE and Windows® ME.

Windows® XP

If your Windows® XP CD already includes Service Pack 1, the USB 2.0 driver will automatically install when you install the operating system. If the CD does not include Service Pack 1, it is available for download at Microsoft's Windows Update website.

Windows® 2000

If your Windows® 2000 CD already includes Service Pack 4, the USB 2.0 driver will automatically install when you install the operating system. If the CD does not include Service Pack 4, it is available for download at Microsoft's Windows Update website.

Installation Notes

1. "Autorun" ONLY supports the Windows® 2000 and Windows® XP operating systems. If after inserting the CD, "Autorun" did not automatically start (which is, the Main Board Utility CD screen did not appear), please go directly to the root directory of the CD and double-click "Setup".
2. All steps or procedures to install software drivers are subject to change without notice as the softwares are occasionally updated. Please go to DFI's web site at "<http://www.dfi.com/support1/download2.asp>" for the latest version of the drivers or software applications.

Appendix A - Enabling Hyper-Threading Technology

Enabling Hyper-Threading Technology

To enable the functionality of the Hyper-Threading Technology, please follow the requirements and steps below. Basically, the following presumes that you have already installed an Intel® Pentium® 4 Processor with Hyper-Threading Technology.

1. The system requires a minimum of 300 Watt ATX 12V power supply.
2. Aside from installing a CPU fan on the Intel® Pentium® 4 Processor with Hyper-Threading Technology, make sure to install cooling fans. The system requires adequate airflow throughout the chassis to prevent overheating the processor.
3. The “CPU Hyper-Threading” field in the Advanced BIOS Features submenu of the Award BIOS setup will appear. Make sure this field is set to Enabled.
4. Currently, only Windows® XP supports the Hyper-Threading Technology. If this OS has been previously installed, you must **REINSTALL** it.
5. After installing Windows® XP, please check the following to ensure that the operating system has been properly installed.
 - a. Click Start, point to Settings then click Control Panel.
 - b. Double-click the System icon. The System Properties dialog box will appear.

- c. Click the General tab. The processor shown under Computer should resemble the one shown below.

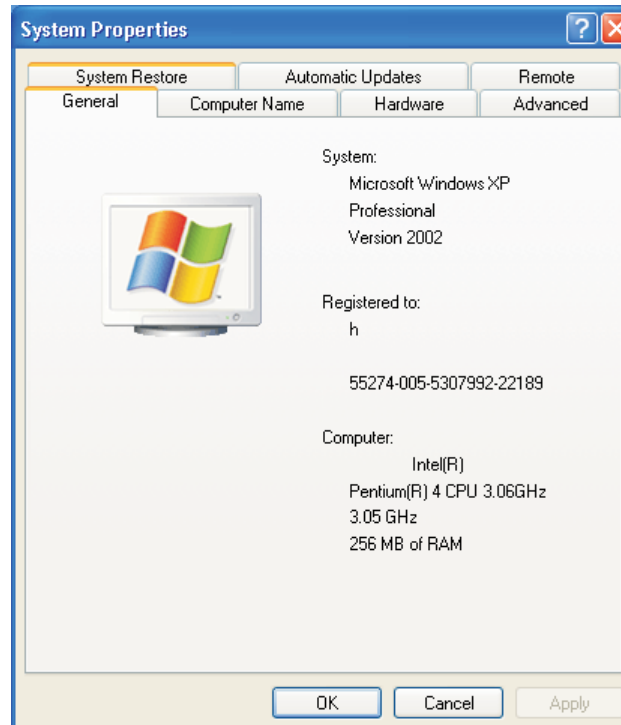

- d. Now click the Hardware tab then click Device Manager. The items shown under Computer and Processors should resemble the ones shown below.

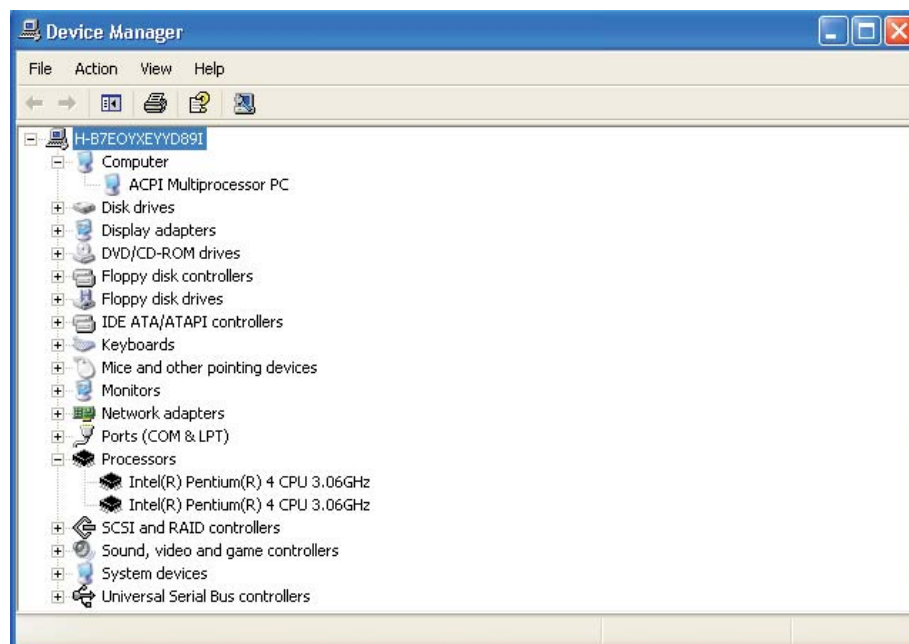

Enabling Hyper-Threading Technology

- e. Lastly, press the <Ctrl> <Alt> and keys simultaneously. The Windows Task Manager dialog box will appear. Click the Performance tab. The diagram under CPU Usage History should resemble the one shown below.

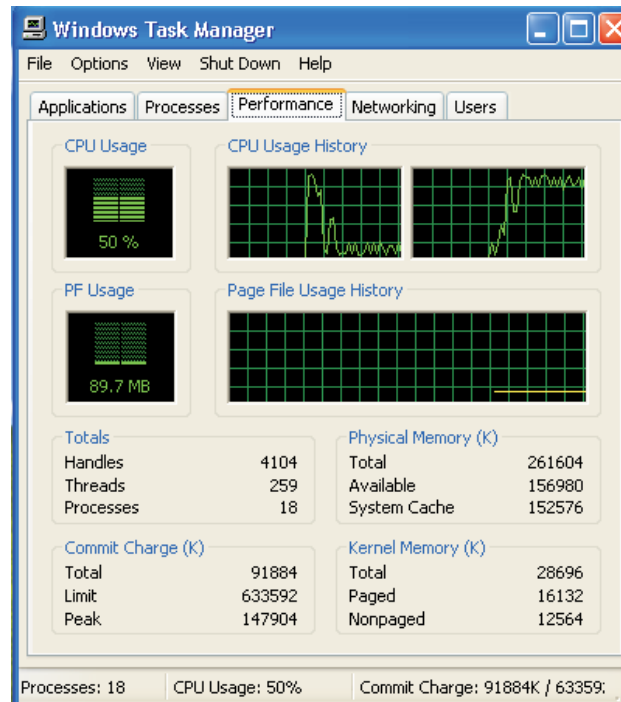

Appendix B - Watchdog Timer

Watchdog Timer

The following parameters are references for setting the time interval of the Watchdog Timer function. The system will regularly be “cleared” according to the set time interval. If the system hangs or fails to function, it will also reset according to the time interval so that your system will continue to operate.

```
mov dx,02e <Enter>
mov al,87 <Enter>
out dx,al <Enter>
out dx,al <Enter>
mov dx,02e <Enter>
mov al,07 <Enter>
out dx,al <Enter>
inc dx <Enter>
inc al <Enter>
out dx,al <Enter>
dec dx <Enter>
mov al,f6 <Enter>
out dx,al <Enter>
inc dx <Enter>
mov al,xy <Enter>
out dx,al <Enter>
```

“XY” is the Watchdog Time count value for the “00h to “FFh” range wherein the time can be set from 0 sec. to 255 sec.

Appendix C - System Error Message

When the BIOS encounters an error that requires the user to correct something, either a beep code will sound or a message will be displayed in a box in the middle of the screen and the message, PRESS F1 TO CONTINUE, CTRL-ALT-ESC or DEL TO ENTER SETUP, will be shown in the information box at the bottom. Enter Setup to correct the error.

POST Beep

There are two kinds of beep codes in the BIOS. One code indicates that a video error has occurred and the BIOS cannot initialize the video screen to display any additional information. This beep code consists of a single long beep followed by three short beeps. The other code indicates that a DRAM error has occurred. This beep code consists of a single long beep.

Error Messages

One or more of the following messages may be displayed if the BIOS detects an error during the POST. This list indicates the error messages for all Awards BIOSes:

CMOS BATTERY HAS FAILED

The CMOS battery is no longer functional. It should be replaced.



Caution:

Danger of explosion if battery incorrectly replaced. Replace only with the same or equivalent type recommended by the manufacturer. Dispose of used batteries according to the battery manufacturer's instructions.

CMOS CHECKSUM ERROR

Checksum of CMOS is incorrect. This can indicate that CMOS has become corrupt. This error may have been caused by a weak battery. Check the battery and replace if necessary.

DISPLAY SWITCH IS SET INCORRECTLY

The display switch on the motherboard can be set to either monochrome or color. This indicates the switch is set to a different

setting than indicated in Setup. Determine which setting is correct, either turn off the system and change the jumper or enter Setup and change the VIDEO selection.

FLOPPY DISK(S) fail (80)

Unable to reset floppy subsystem.

FLOPPY DISK(S) fail (40)

Floppy type mismatch.

Hard Disk(s) fail (80)

HDD reset failed.

Hard Disk(s) fail (40)

HDD controller diagnostics failed.

Hard Disk(s) fail (20)

HDD initialization error.

Hard Disk(s) fail (10)

Unable to recalibrate fixed disk.

Hard Disk(s) fail (08)

Sector Verify failed.

Keyboard is locked out - Unlock the key

The BIOS detects that the keyboard is locked. Keyboard controller is pulled low.

Keyboard error or no keyboard present

Cannot initialize the keyboard. Make sure the keyboard is attached correctly and no keys are being pressed during the boot.

Manufacturing POST loop

System will repeat POST procedure infinitely while the keyboard controller is pull low. This is also used for the M/B burn in test at the factory.

BIOS ROM checksum error - System halted

The checksum of ROM address F0000H-FFFFFFH is bad.

Memory test fail

The BIOS reports memory test fail if the memory has error(s).

Appendix D - Troubleshooting

Troubleshooting Checklist

This chapter of the manual is designed to help you with problems that you may encounter with your personal computer. To efficiently troubleshoot your system, treat each problem individually. This is to ensure an accurate diagnosis of the problem in case a problem has multiple causes.

Some of the most common things to check when you encounter problems while using your system are listed below.

1. The power switch of each peripheral device is turned on.
2. All cables and power cords are tightly connected.
3. The electrical outlet to which your peripheral devices are connected is working. Test the outlet by plugging in a lamp or other electrical device.
4. The monitor is turned on.
5. The display's brightness and contrast controls are adjusted properly.
6. All add-in boards in the expansion slots are seated securely.
7. Any add-in board you have installed is designed for your system and is set up correctly.

Monitor/Display

If the display screen remains dark after the system is turned on:

1. Make sure that the monitor's power switch is on.
2. Check that one end of the monitor's power cord is properly attached to the monitor and the other end is plugged into a working AC outlet. If necessary, try another outlet.
3. Check that the video input cable is properly attached to the monitor and the system's display adapter.
4. Adjust the brightness of the display by turning the monitor's brightness control knob.

The picture seems to be constantly moving.

1. The monitor has lost its vertical sync. Adjust the monitor's vertical sync.
2. Move away any objects, such as another monitor or fan, that may be creating a magnetic field around the display.
3. Make sure your video card's output frequencies are supported by this monitor.

The screen seems to be constantly wavering.

1. If the monitor is close to another monitor, the adjacent monitor may need to be turned off. Fluorescent lights adjacent to the monitor may also cause screen wavering.

Power Supply

When the computer is turned on, nothing happens.

1. Check that one end of the AC power cord is plugged into a live outlet and the other end properly plugged into the back of the system.
2. Make sure that the voltage selection switch on the back panel is set for the correct type of voltage you are using.
3. The power cord may have a "short" or "open". Inspect the cord and install a new one if necessary.

Floppy Drive

The computer cannot access the floppy drive.

1. The floppy diskette may not be formatted. Format the diskette and try again.
2. The diskette may be write-protected. Use a diskette that is not write-protected.
3. You may be writing to the wrong drive. Check the path statement to make sure you are writing to the targeted drive.
4. There is not enough space left on the diskette. Use another diskette with adequate storage space.

Hard Drive

Hard disk failure.

1. Make sure the correct drive type for the hard disk drive has been entered in the BIOS.
2. If the system is configured with two hard drives, make sure the bootable (first) hard drive is configured as Master and the second hard drive is configured as Slave. The master hard drive must have an active/bootable partition.

Excessively long formatting period.

1. If your hard drive takes an excessively long period of time to format, it is likely a cable connection problem. However, if your hard drive has a large capacity, it will take a longer time to format.

Parallel Port

The parallel printer doesn't respond when you try to print.

1. Make sure that your printer is turned on and that the printer is on-line.
2. Make sure your software is configured for the right type of printer attached.
3. Verify that the onboard LPT port's I/O address and IRQ settings are configured correctly.
4. Verify that the attached device works by attaching it to a parallel port that is working and configured correctly. If it works, the printer can be assumed to be in good condition. If the printer remains inoperative, replace the printer cable and try again.

Serial Port

The serial device (modem, printer) doesn't output anything or is outputting garbled characters.

1. Make sure that the serial device's power is turned on and that the device is on-line.
2. Verify that the device is plugged into the correct serial port on the rear of the computer.
3. Verify that the attached serial device works by attaching it to a serial port that is working and configured correctly. If the serial device does not work, either the cable or the serial device has a problem. If the serial device works, the problem may be due to the onboard I/O or the address setting.
4. Make sure the COM settings and I/O address are configured correctly.

Keyboard

Nothing happens when a key on the keyboard was pressed.

1. Make sure the keyboard is properly connected.
2. Make sure there are no objects resting on the keyboard and that no keys are pressed during the booting process.

System Board

1. Make sure the add-in card is seated securely in the expansion slot. If the add-in card is loose, power off the system, re-install the card and power up the system.
2. Check the jumper settings to ensure that the jumpers are properly set.
3. Verify that all memory modules are seated securely into the memory sockets.
4. Make sure the memory modules are in the correct locations.
5. If the board fails to function, place the board on a flat surface and seat all socketed components. Gently press each component into the socket.
6. If you made changes to the BIOS settings, re-enter setup and load the BIOS defaults.