

G7B630-B/N/NR

System Board User's Manual

935-G7B632-350G
I03000740

Copyright

This publication contains information that is protected by copyright. No part of it may be reproduced in any form or by any means or used to make any transformation/adaptation without the prior written permission from the copyright holders.

This publication is provided for informational purposes only. The manufacturer makes no representations or warranties with respect to the contents or use of this manual and specifically disclaims any express or implied warranties of merchantability or fitness for any particular purpose. The user will assume the entire risk of the use or the results of the use of this document. Further, the manufacturer reserves the right to revise this publication and make changes to its contents at any time, without obligation to notify any person or entity of such revisions or changes.

© 2007. All Rights Reserved.

Trademarks

Product names or trademarks appearing in this manual are for identification purpose only and are the properties of the respective owners.

FCC and DOC Statement on Class B

This equipment has been tested and found to comply with the limits for a Class B digital device, pursuant to Part 15 of the FCC rules. These limits are designed to provide reasonable protection against harmful interference when the equipment is operated in a residential installation. This equipment generates, uses and can radiate radio frequency energy and, if not installed and used in accordance with the instruction manual, may cause harmful interference to radio communications. However, there is no guarantee that interference will not occur in a particular installation. If this equipment does cause harmful interference to radio or television reception, which can be determined by turning the equipment off and on, the user is encouraged to try to correct the interference by one or more of the following measures:

- Reorient or relocate the receiving antenna.
- Increase the separation between the equipment and the receiver.
- Connect the equipment into an outlet on a circuit different from that to which the receiver is connected.
- Consult the dealer or an experienced radio TV technician for help.

Notice:

1. The changes or modifications not expressly approved by the party responsible for compliance could void the user's authority to operate the equipment.
2. Shielded interface cables must be used in order to comply with the emission limits.

Table of Contents

About this Manual.....	5
Warranty.....	5
Static Electricity Precaution.....	6
Safety Measures.....	6
About the Package.....	7
Before Using the System Board.....	7
Chapter 1 - Introduction.....	8
Specifications.....	8
Special Features of the System Board.....	11
Chapter 2 - Hardware Installation.....	15
System Board Layout	15
System Memory.....	18
CPU.....	22
Jumper Settings.....	28
Rear Panel I/O Ports.....	34
I/O Connectors.....	45
Chapter 3 - BIOS Setup.....	61
Award BIOS Setup Utility.....	61
Intel RAID BIOS.....	100
Updating the BIOS.....	101
Chapter 4 - Supported Softwares.....	103
Drivers, Utilities and Software Applications.....	103
Installation Notes.....	118
Chapter 5 - RAID.....	119
RAID Levels.....	119
Settings.....	120
Appendix A - Enabling Hyper-Threading Technology.....	126
Appendix B - System Error Messages.....	129
Appendix C - Troubleshooting.....	131
Appendix D - Watchdog Sample Code.....	135

About this Manual

An electronic file of this manual is included in the CD. To view the user's manual in the CD, insert the CD into a CD-ROM drive. The autorun screen (Main Board Utility CD) will appear. Click "User's Manual" on the main menu.

Warranty

1. Warranty does not cover damages or failures that arised from misuse of the product, inability to use the product, unauthorized replacement or alteration of components and product specifications.
2. The warranty is void if the product has been subjected to physical abuse, improper installation, modification, accidents or unauthorized repair of the product.
3. Unless otherwise instructed in this user's manual, the user may not, under any circumstances, attempt to perform service, adjustments or repairs on the product, whether in or out of warranty. It must be returned to the purchase point, factory or authorized service agency for all such work.
4. We will not be liable for any indirect, special, incidental or consequential damages to the product that has been modified or altered.

Static Electricity Precautions

It is quite easy to inadvertently damage your PC, system board, components or devices even before installing them in your system unit. Static electrical discharge can damage computer components without causing any signs of physical damage. You must take extra care in handling them to ensure against electrostatic build-up.

1. To prevent electrostatic build-up, leave the system board in its anti-static bag until you are ready to install it.
2. Wear an antistatic wrist strap.
3. Do all preparation work on a static-free surface.
4. Hold the device only by its edges. Be careful not to touch any of the components, contacts or connections.
5. Avoid touching the pins or contacts on all modules and connectors. Hold modules or connectors by their ends.



Important:

Electrostatic discharge (ESD) can damage your processor, disk drive and other components. Perform the upgrade instruction procedures described at an ESD workstation only. If such a station is not available, you can provide some ESD protection by wearing an antistatic wrist strap and attaching it to a metal part of the system chassis. If a wrist strap is unavailable, establish and maintain contact with the system chassis throughout any procedures requiring ESD protection.

Safety Measures

To avoid damage to the system:

- Use the correct AC input voltage range.

To reduce the risk of electric shock:

- Unplug the power cord before removing the system chassis cover for installation or servicing. After installation or servicing, cover the system chassis before plugging the power cord.

Battery:

- Danger of explosion if battery incorrectly replaced.
- Replace only with the same or equivalent type recommend by the manufacturer.
- Dispose of used batteries according to local ordinance.

About the Package

The system board package contains the following items. If any of these items are missing or damaged, please contact your dealer or sales representative for assistance.

- ☑ The system board
- ☑ One IDE cable
- ☑ One FDD cable
- ☑ Two Serial ATA data cables
- ☑ Two Serial ATA power cables
- ☑ One bracket mounted with a serial port
- ☑ One bracket mounted with a 1394 port (G7B630-NR and G7B630-N)
- ☑ Two USB port cables
- ☑ One "Main Board Utility" CD
- ☑ One RAID driver floppy diskette (G7B630-NR only)
- ☑ One I/O shield
- ☑ One QR (Quick Reference)

The system board and accessories in the package may not come similar to the information listed above. This may differ in accordance to the sales region or models in which it was sold. For more information about the standard package in your region, please contact your dealer or sales representative.

Before Using the System Board

Before using the system board, prepare basic system components.

If you are installing the system board in a new system, you will need at least the following internal components.

- A CPU
- Memory module
- Storage devices such as hard disk drive, CD-ROM, etc.

You will also need external system peripherals you intend to use which will normally include at least a keyboard, a mouse and a video display monitor.

Chapter 1 - Introduction

Specifications

Processor	<ul style="list-style-type: none">• LGA 775 socket for:<ul style="list-style-type: none">- Intel® Core™2 Quad, Intel® Core™2 Duo (Conroe family), Intel® Pentium® D, Intel® Pentium® 4 or Intel® Celeron, Intel® Celeron D• Supports Intel Enhanced Memory 64 Technology (EMT64T)• Supports Enhanced Intel SpeedStep Technology (EIST)• Supports Intel Hyper-Threading Technology• Supports 1066/800/533MHz FSB
Chipset	<ul style="list-style-type: none">• Intel® chipset<ul style="list-style-type: none">- Northbridge: Intel® Q965 Express chipset- Southbridge: Intel® ICH8 (G7B630-B and G7B630-N) Intel® ICH8DO (G7B630-NR)
System Memory	<ul style="list-style-type: none">• Four 240-pin DDR2 DIMM sockets• Supports DDR2 533, DDR2 667 and DDR2 800 DIMMs• Supports dual channel (128-bit wide) memory interface• Supports up to 8GB system memory• Supports non-ECC unbuffered DIMMs
Expansion Slot	<ul style="list-style-type: none">• 1 PCI Express x16 slot• 2 PCI Express x1 slots• 4 PCI slots
Graphics	<ul style="list-style-type: none">• Built-in Intel Graphics Media Accelerator 3000
Audio	<ul style="list-style-type: none">• Realtek ALC262 High Definition audio CODEC• 2-channel audio output• 1 stereo DAC supports 16/20/24-bit PCM format with 44.1/48/96/192KHz sample rate• 2 stereo ADCs support 16/20-bit PCM format with 44.1/48/96/192KHz sample rate• S/PDIF-in/out interface
LAN	<ul style="list-style-type: none">• G7B630-B - Marvell 88E8056 PCI Express Gigabit Ethernet controller• G7B630-N and G7B630-NR - Intel 82566DM and Marvell 88E8056 PCI Express Gigabit Ethernet controllers• Supports 10Mbps, 100Mbps and 1Gbps data transmission• IEEE 802.3 (10/100Mbps) and IEEE 802.3ab (1Gbps) compliant
Serial ATA	<ul style="list-style-type: none">• Supports SATA (Serial ATA) interfaces which are compliant with SATA 1.0 specification• G7B630-NR<ul style="list-style-type: none">- 6 Serial ATA ports- SATA speed up to 3Gb/s- RAID 0, RAID 1, RAID 5 and RAID 10• G7B630-B and G7B630-N<ul style="list-style-type: none">- 4 Serial ATA ports- SATA speed up to 3Gb/s

IDE	<ul style="list-style-type: none"> • JMicron JMB368 PCI Express to PATA host controller • Supports up to 2 UltraDMA 133Mbps IDE devices
IEEE 1394 (G7B630-N/NR)	<ul style="list-style-type: none"> • VIA VT6307 • Supports two 100/200/400 Mb/sec ports
Rear I/O	<ul style="list-style-type: none"> • 1 mini-DIN-6 PS/2 mouse port • 1 mini-DIN-6 PS/2 keyboard port • 1 DB-25 parallel port • 1 DB-9 serial port • 1 DB-15 VGA port • 1 RJ45 LAN port (G7B630-B) • 2 RJ45 LAN ports (G7B630-N and G7B630-NR) • 4 USB 2.0/1.1 ports • Mic-in, line-in and line-out jacks
I/O Connectors	<ul style="list-style-type: none"> • 3 connectors for 6 additional external USB 2.0/1.1 ports • 2 connectors for external IEEE 1394 ports (G7B630-N and G7B630-NR) • 1 connector for an external COM 2 port • 1 Digital I/O connector • 1 front audio connector for line-out and mic-in jacks • 1 CD-in internal audio connector • 1 S/PDIF-in/out connector • 1 connector for IrDA interface • 6 Serial ATA connectors (G7B630-NR) • 4 Serial ATA connectors (G7B630-B and G7B630-N) • 1 40-pin IDE connector • 1 floppy connector • 1 24-pin ATX power connector • 1 4-pin 12V power connector • 1 chassis open connector • 1 front panel connector • 3 4-wire fan connectors
BIOS	<ul style="list-style-type: none"> • Award BIOS • 8Mbit SPI flash memory
Energy Efficient Design	<ul style="list-style-type: none"> • Supports ACPI specification and OS Directed Power Management • Supports ACPI STR (Suspend to RAM) function • Wake-On-Events include: <ul style="list-style-type: none"> - Wake-On-PS/2 Keyboard/Mouse - Wake-On-USB Keyboard/Mouse - Wake-On-LAN - Wake-On-Ring - RTC timer to power-on the system • System power management supported • CPU stopped clock control • Microsoft®/Intel® APM 1.2 compliant • Soft Power supported - ACPI v2.0 specification • AC power failure recovery

1

Introduction

Damage Free Intelligence

- Monitors CPU/system temperature and overheat alarm
- Monitors Vcore/VCC3/VBAT/3VSB/12V/1.25V/1.8V/5V voltages and failure alarm
- Monitors CPU/2nd/system fan speed
- Read back capability that displays temperature, voltage and fan speed
- Watchdog Timer function

Temperature

- Operating: 0°C to 60°C
- Non-operating: -40°C to 85°C

Humidity

- Operating: 10% to 90%

PCB

- 4 layers, ATX form factor
- 30.5cm (12") x 24.4cm (9.6")

Features

WATCHDOG TIMER

The Watchdog Timer function allows your application to regularly “clear” the system at the set time interval. If the system hangs or fails to function, it will reset at the set time interval so that your system will continue to operate.

HYPER-THREADING TECHNOLOGY

The system board supports Intel processors with Hyper-Threading Technology. Enabling the functionality of Hyper-Threading Technology for your computer system requires **ALL** of the following platforms.

Components:

- CPU - an Intel® Pentium® 4 Processor with HT Technology
- Chipset - an Intel® chipset that supports HT Technology
- BIOS - a BIOS that supports HT Technology and has it enabled
- OS - an operating system that includes optimizations for HT Technology

Please refer to Appendix A for information about enabling the functionality of the Hyper-Threading Technology. For more information on Hyper-Threading Technology, go to: www.intel.com/info/hyperthreading.

DDR2

DDR2 is a higher performance DDR technology whose data transfer rate delivers bandwidth of 4.3 GB per second and beyond. That is twice the speed of the conventional DDR without increasing its power consumption. DDR2 SDRAM modules work at 1.8V supply compared to 2.6V memory voltage for DDR modules. DDR2 also incorporates new innovations such as the On-Die Termination (ODT) as well as larger 4-bit pre-fetch against DDR which fetches 2 bits per clock cycle.

GRAPHICS

The graphics engine of the built-in Intel® Graphics Media Accelerator 3000 consists of a scalable array of symmetric processing components known as execution units (EUs) which can be programmed to dynamically process graphics or media data alike. Execution units support dynamic load balancing, multi-threading, and multi-functional data processing, resulting in increased performance to enable a more compelling gaming and visual experience.

S/PDIF

S/PDIF is a standard audio file transfer format that transfers digital audio signals to a device without having to be converted first to an analog format. This prevents the quality of the audio signal from degrading whenever it is converted to analog. S/PDIF is usually found on digital audio equipment such as a DAT machine or audio processing device. The S/PDIF connector on the system board sends surround sound and 3D audio signal outputs to amplifiers and speakers and to digital recording devices like CD recorders.

SERIAL ATA

Serial ATA is a storage interface that is compliant with SATA 1.0 specification. With speed of up to 3Gb/s, it improves hard drive performance faster than the standard parallel ATA whose data transfer rate is 100MB/s. G7B630-NR allows configuring RAID on Serial ATA drives. It supports RAID 0, RAID 1, RAID 5 and RAID 10.

IDE

The JMicron JMB368 chip supports up to two UltraDMA 133Mbps IDE devices.

GIGABIT LAN

The Intel 82566DM and Marvell 88E8056 PCI Express Gigabit Ethernet controllers support up to 1Gbps data transmission.

IEEE 1394

IEEE 1394 is fully compliant with the 1394 OHCI (Open Host Controller Interface) 1.1 specification. It supports up to 63 devices that can run simultaneously on a system. 1394 is a fast external bus standard that supports data transfer rates of up to 400Mbps. In addition to its high speed, it also supports isochronous data transfer which is ideal for video devices that need to transfer high levels of data in real-time. 1394 supports both Plug-and-Play and hot plugging.

IRDA

The system board is equipped with an IrDA connector for wireless connectivity between your computer and peripheral devices. The IRDA (Infrared Data Association) specification supports data transfers up to 115Kbps baud rate speed.

USB

The system board supports USB 2.0 and USB 1.1 ports. USB 1.1 supports 12Mb/second bandwidth while USB 2.0 supports 480Mb/second bandwidth providing a marked improvement in device transfer speeds between your computer and a wide range of simultaneously accessible external Plug and Play peripherals.

WAKE-ON-RING

This feature allows the system that is in the Suspend mode or Soft Power Off mode to wake-up/power-on to respond to calls coming from an external modem or respond to calls from a modem PCI card that uses the PCI PME (Power Management Event) signal to remotely wake up the PC.

**Important:**

The 5V_standby power source of your power supply must support $\geq 720\text{mA}$.

WAKE-ON-LAN

This feature allows the network to remotely wake up a Soft Power Down (Soft-Off) PC. It is supported via the onboard LAN port or via a PCI LAN card that uses the PCI PME (Power Management Event) signal. However, if your system is in the Suspend mode, you can power-on the system only through an IRQ or DMA interrupt.

**Important:**

The 5V_standby power source of your power supply must support $\geq 720\text{mA}$.

WAKE-ON-PS/2

This function allows you to use the PS/2 keyboard or PS/2 mouse to power-on the system.

**Important:**

The 5V_standby power source of your power supply must support $\geq 720\text{mA}$.

WAKE-ON-USB

This function allows you to use a USB keyboard or USB mouse to wake up a system from the S3 (STR - Suspend To RAM) state.

**Important:**

If you are using the Wake-On-USB Keyboard/Mouse function for 2 USB ports, the 5V_standby power source of your power supply must support $\geq 1.5A$. For 3 or more USB ports, the 5V_standby power source of your power supply must support $\geq 2A$.

RTC TIMER

The RTC installed on the system board allows your system to automatically power-on on the set date and time.

ACPI STR

The system board is designed to meet the ACPI (Advanced Configuration and Power Interface) specification. ACPI has energy saving features that enables PCs to implement Power Management and Plug-and-Play with operating systems that support OS Direct Power Management. Currently, only Windows® 2000/XP supports the ACPI function. ACPI when enabled in the Power Management Setup will allow you to use the Suspend to RAM function.

With the Suspend to RAM function enabled, you can power-off the system at once by pressing the power button or selecting “Standby” when you shut down Windows® 2000/XP without having to go through the sometimes tiresome process of closing files, applications and operating system. This is because the system is capable of storing all programs and data files during the entire operating session into RAM (Random Access Memory) when it powers-off. The operating session will resume exactly where you left off the next time you power-on the system.

**Important:**

The 5V_standby power source of your power supply must support $\geq 720mA$.

POWER FAILURE RECOVERY

When power returns after an AC power failure, you may choose to either power-on the system manually or let the system power-on automatically.

Chapter 2 - Hardware Installation

System Board Layout

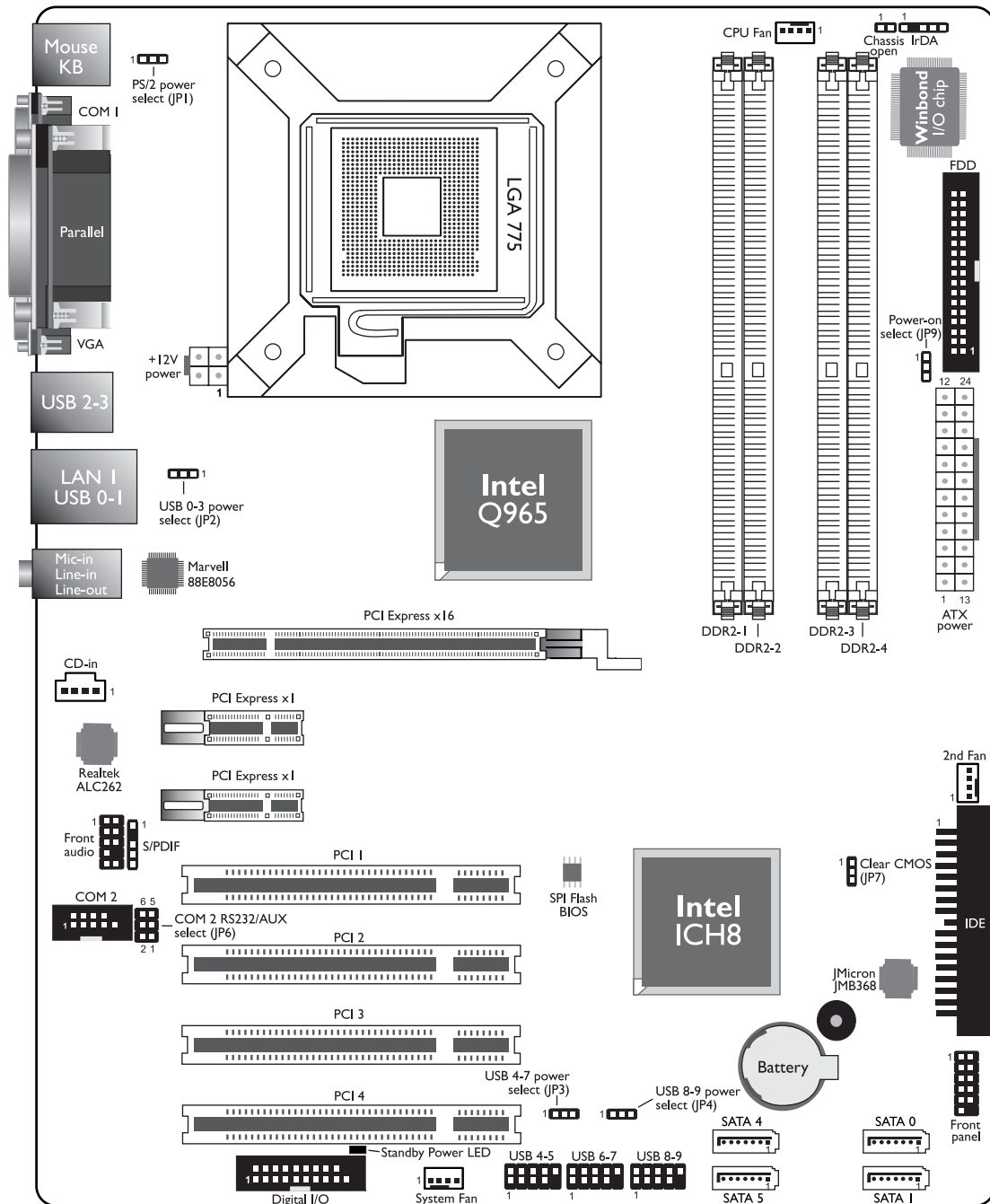

G7B630-B

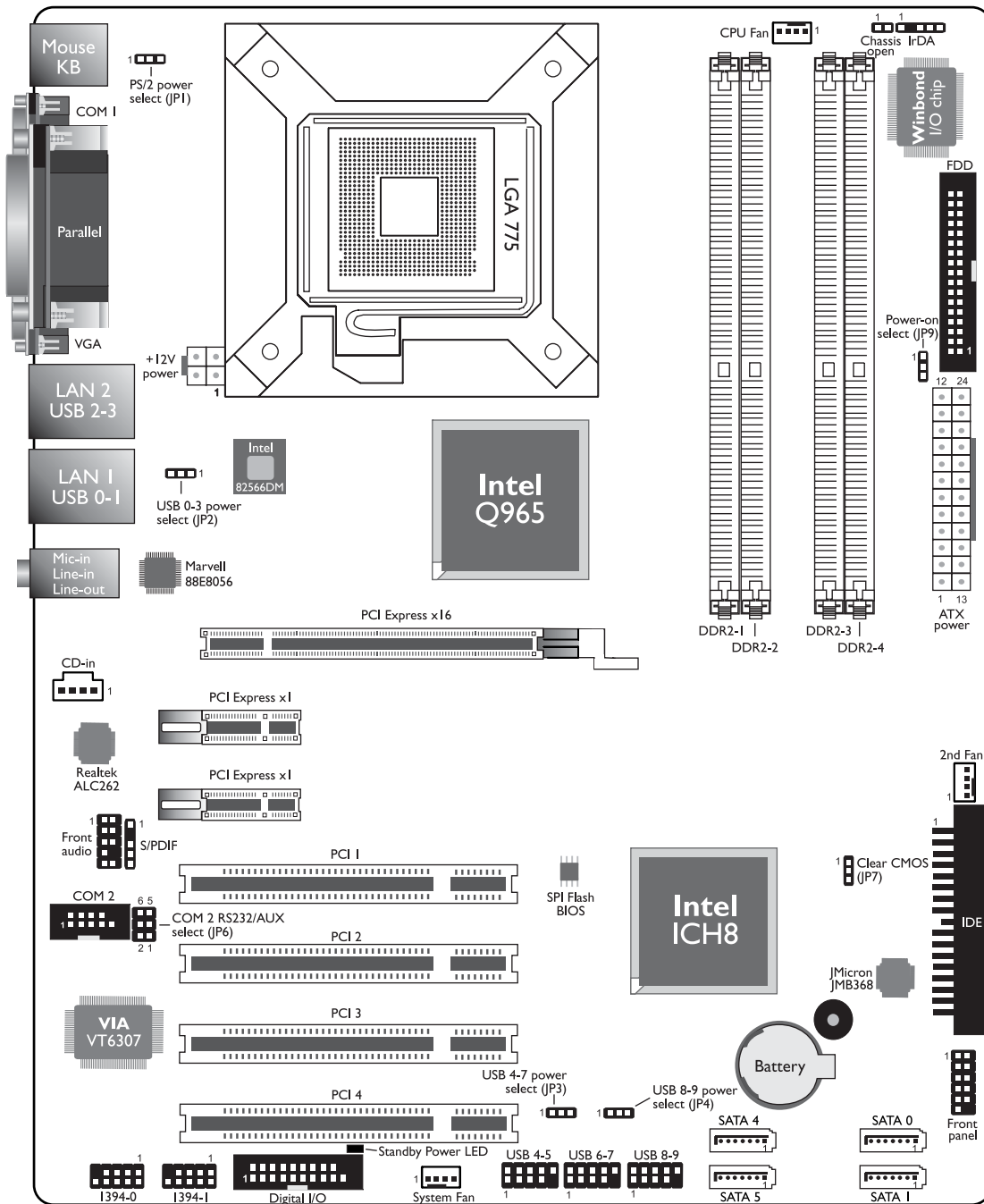

G7B630-N

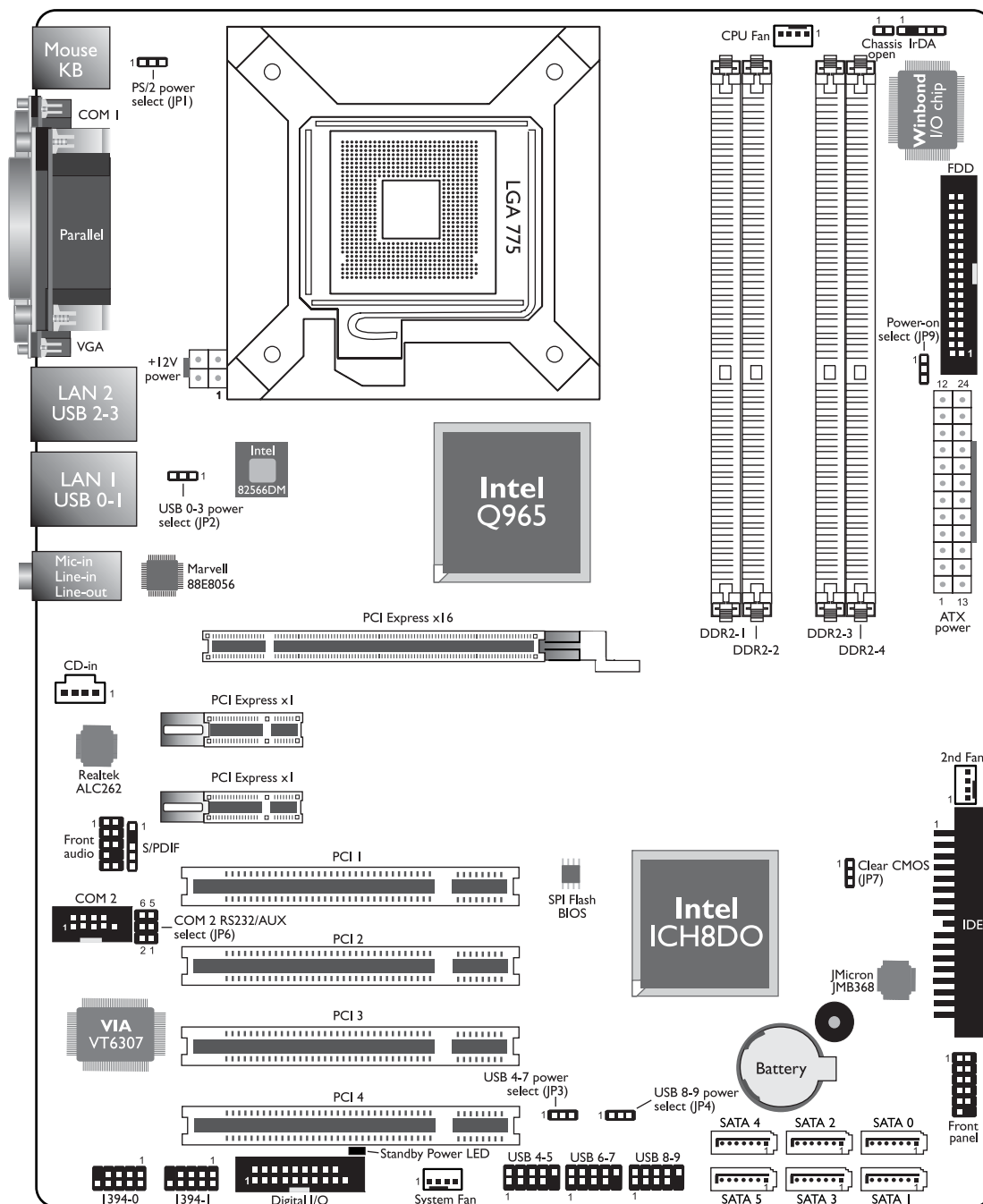

G7B630-NR



Note:

The illustrations on the following pages are based on the G7B630-NR system board.

**Warning:**

Electrostatic discharge (ESD) can damage your system board, processor, disk drives, add-in boards, and other components. Perform the upgrade instruction procedures described at an ESD workstation only. If such a station is not available, you can provide some ESD protection by wearing an antistatic wrist strap and attaching it to a metal part of the system chassis. If a wrist strap is unavailable, establish and maintain contact with the system chassis throughout any procedures requiring ESD protection.

System Memory

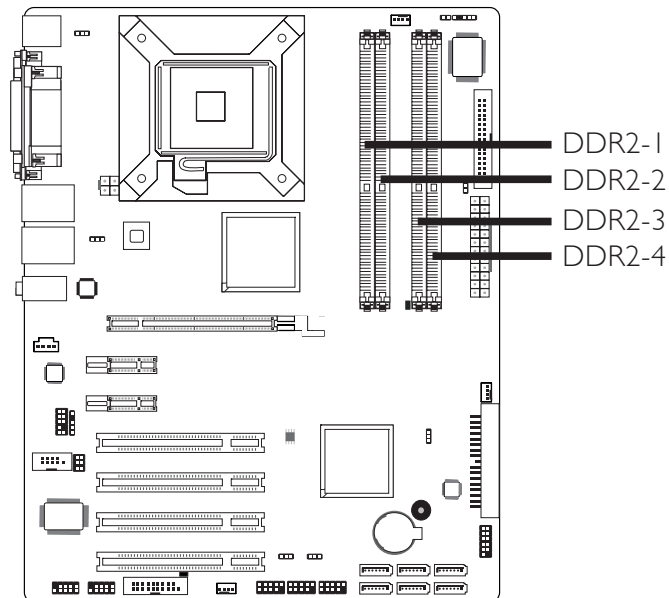

The system board supports 240-pin DDR2 DIMM sockets. The four DDR2 DIMM sockets on the system board are divided into 2 channels:

- Channel A - DDR2-1 and DDR2-3
- Channel B - DDR2-2 and DDR2-4

The system board supports the following memory interface.

Single Channel (SC)

Data will be accessed in chunks of 64 bits (8B) from the memory channels.

Dual Channel (DC)

Data will be accessed in chunks of 128 bits from the memory channels. Dual channel provides better system performance because it doubles the data transfer rate.

Single Channel	<ul style="list-style-type: none">• DIMMs are on the same channel.• DIMMs in a channel can be identical or completely different. However, we highly recommend using identical DIMMs.• Not all slots need to be populated.
Dual Channel	<ul style="list-style-type: none">• DIMMs of the same memory configuration are on different channels.

Installing the DIM Module

1. Make sure the PC and all other peripheral devices connected to it has been powered down.
2. Disconnect all power cords and cables.
3. Locate the DDR2 socket on the system board.
4. Push the “ejector tabs” which are at the ends of the socket to the side.

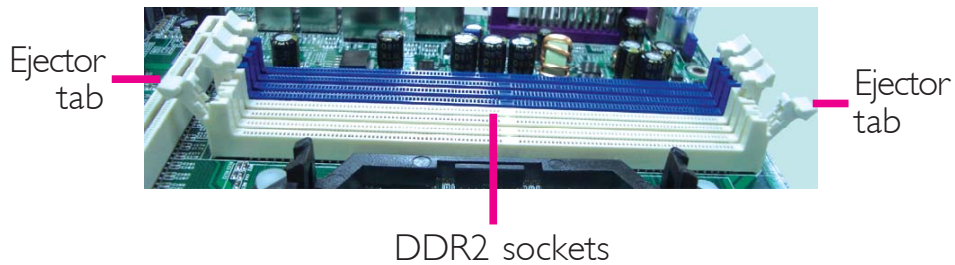

5. Note how the module is keyed to the socket.

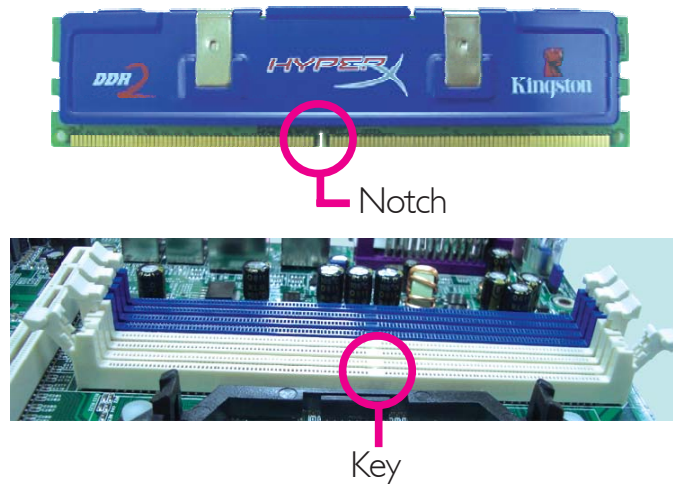

6. Grasping the module by its edges, position the module above the socket with the “notch” in the module aligned with the “key” on the socket. The keying mechanism ensures the module can be plugged into the socket in only one way.



7. Seat the module vertically, pressing it down firmly until it is completely seated in the socket.



8. The ejector tabs at the ends of the socket will automatically snap into the locked position to hold the module in place.



CPU

Overview

The system board is equipped with a surface mount LGA 775 socket. This socket is exclusively designed for installing a LGA 775 packaged Intel CPU.

**Important:**

1. Before you proceed, make sure (1) the LGA775 socket comes with a protective cap, (2) the cap is not damaged and (3) the socket's contact pins are not bent. If the cap is missing or the cap and/or contact pins are damaged, contact your dealer immediately.
2. Make sure to keep the protective cap. RMA requests will be accepted and processed only if the LGA775 socket comes with the protective cap.

Installing the CPU

1. Make sure the PC and all other peripheral devices connected to it has been powered down.
2. Disconnect all power cords and cables.
3. Locate the LGA 775 CPU socket on the system board.

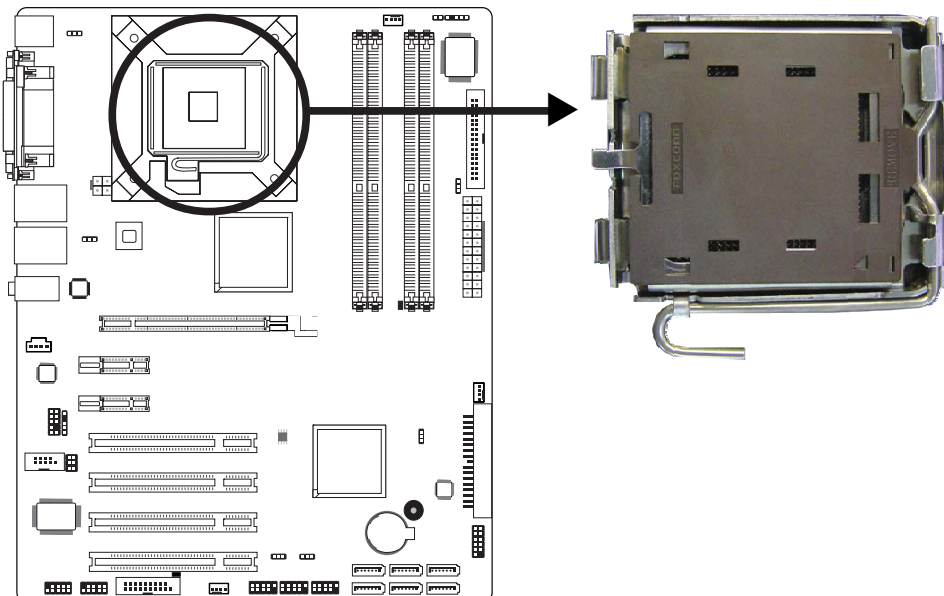

**Important:**

The CPU socket must not come in contact with anything other than the CPU. Avoid unnecessary exposure. Remove the protective cap only when you are about to install the CPU.

- The CPU socket comes with a cover that is attached with a removable protective cap. The cap is used to protect the CPU socket against dust and harmful particles. Remove the protective cap only when you are about to install the CPU.

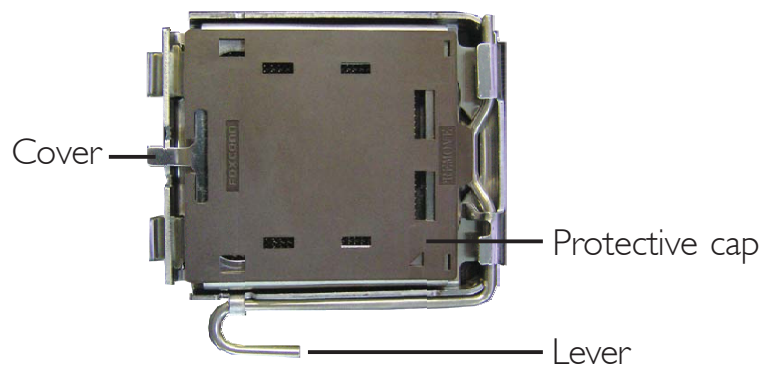

- Lift the protective cap from the location pointed below to detach the cap from the cover:

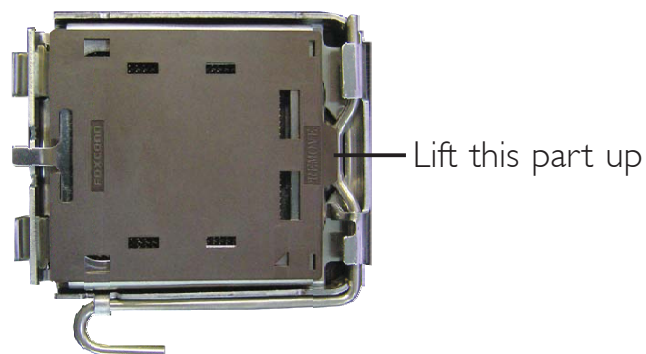

- Unlock the socket by pushing the lever down, moving it away from the side tab of the socket, then lifting it up.

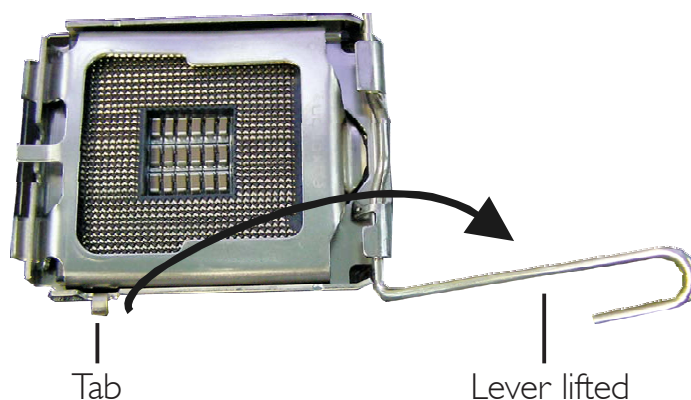

7. Now lift the cover:

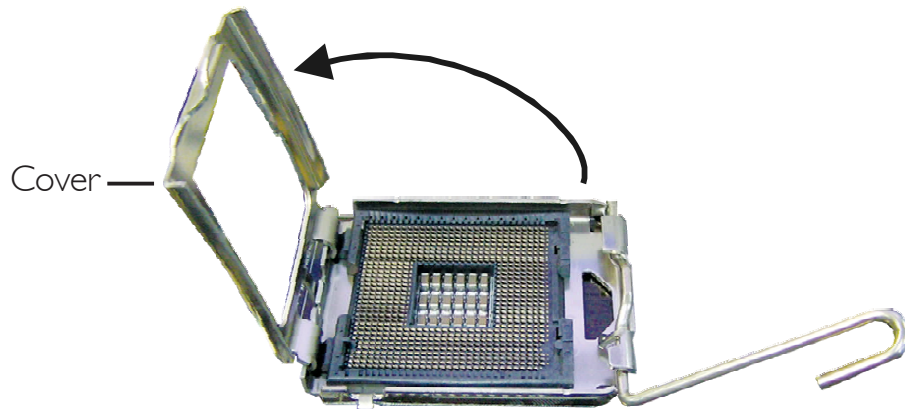

8. Position the CPU above the socket. The gold mark on the CPU must align with pin 1 of the CPU socket.

**Important:**

Handle the CPU by its edges and avoid touching the pins.

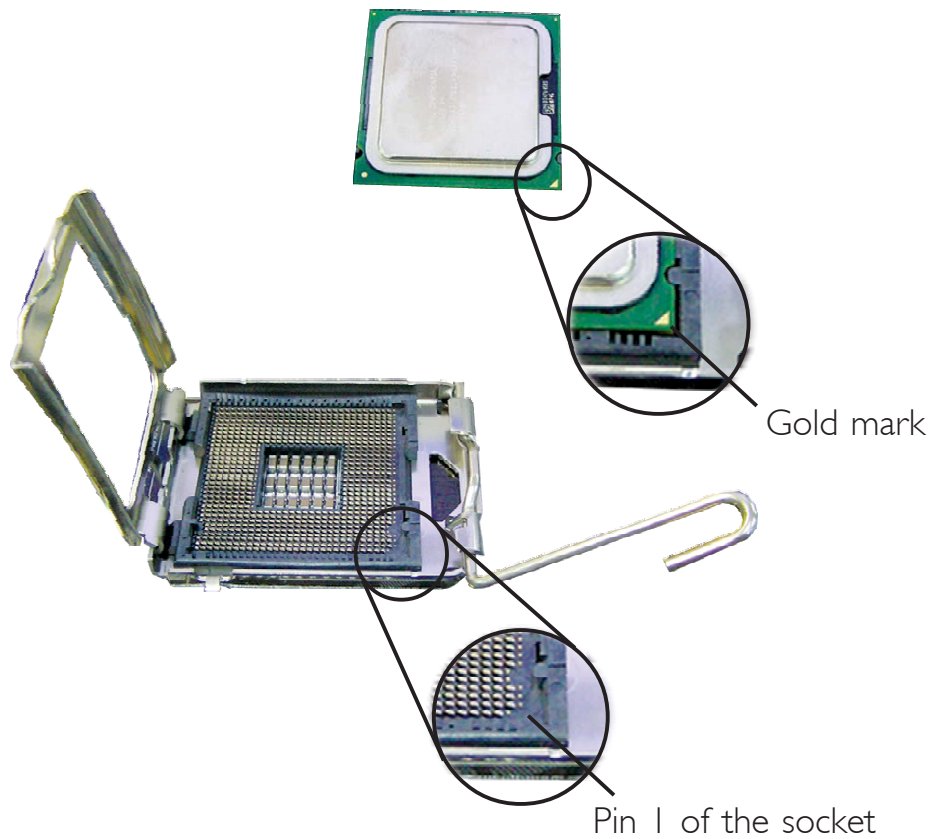

9. Insert the CPU into the socket until it is seated in place. The CPU will fit in only one orientation and can easily be inserted without exerting any force.

**Important:**

Do not force the CPU into the socket. Forcing the CPU into the socket may bend the pins and damage the CPU.

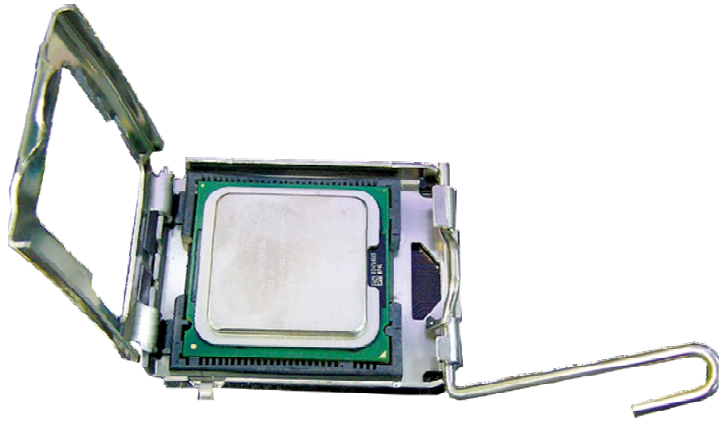

10. Once the CPU is in place, move the cover down.

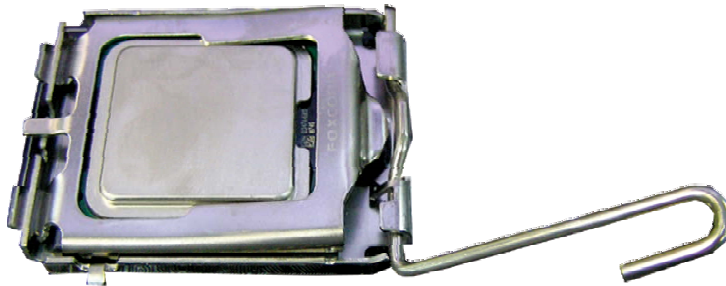

11. Push the lever down to lock the socket. The lever should hook onto the side tab to indicate that the CPU is completely secured in the socket.

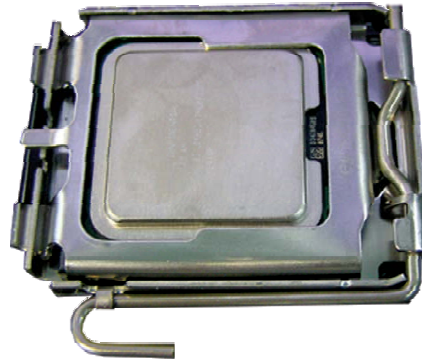

Installing the Fan and Heat Sink

The CPU must be kept cool by using a CPU fan with heat sink. Without sufficient air circulation across the CPU and heat sink, the CPU will overheat damaging both the CPU and system board.



Note:

- Use only certified fan and heat sink.
 - The fan and heat sink package usually contains the fan and heat sink assembly, and an installation guide. If the installation procedure in the installation guide differs from the one in this section, please follow the installation guide in the package.
1. Before you install the fan / heat sink, you must apply a thermal paste onto the top of the CPU. The thermal paste is usually supplied when you purchase the CPU or fan heat sink assembly. Do not spread the paste all over the surface. When you later place the heat sink on top of the CPU, the compound will disperse evenly.

Do not apply the paste if the fan / heat sink already has a patch of thermal paste on its underside. Peel the strip that covers the paste before you place the fan / heat sink on top of the CPU.

- Place the heat sink on top of the CPU. The 4 studs around the heat sink which are used to secure the heat sink onto the system board must match the 4 mounting holes around the socket.

Position each stud so that the groove faces the heat sink then push it down firmly until it clicks into place.



Note:

You will not be able to secure the fan and heat sink assembly in place if the groove is not facing the heat sink.

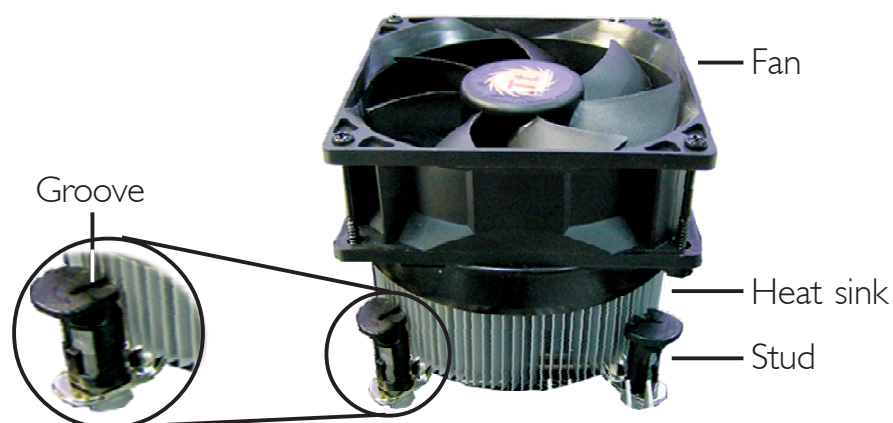
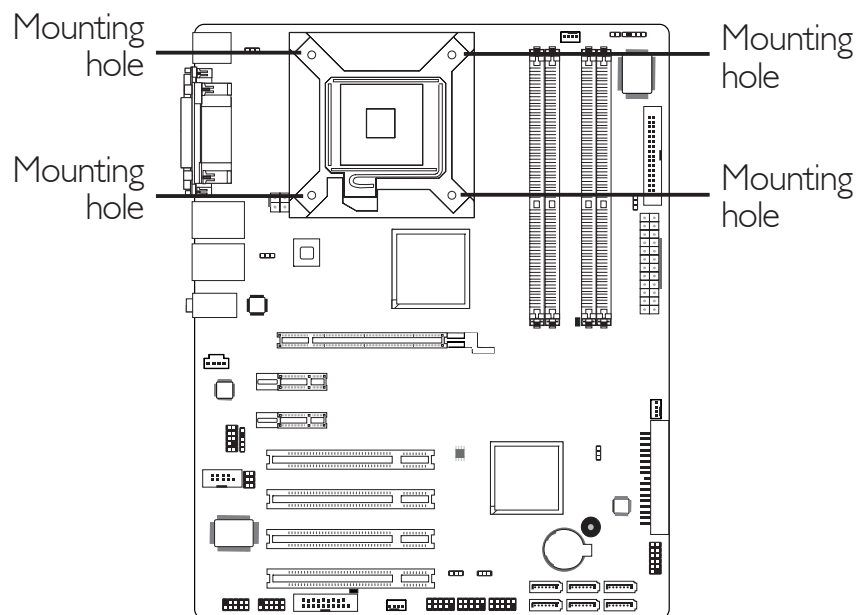

- Connect the CPU fan's cable connector to the CPU fan connector on the system board.

Jumper Settings

Clear CMOS Data

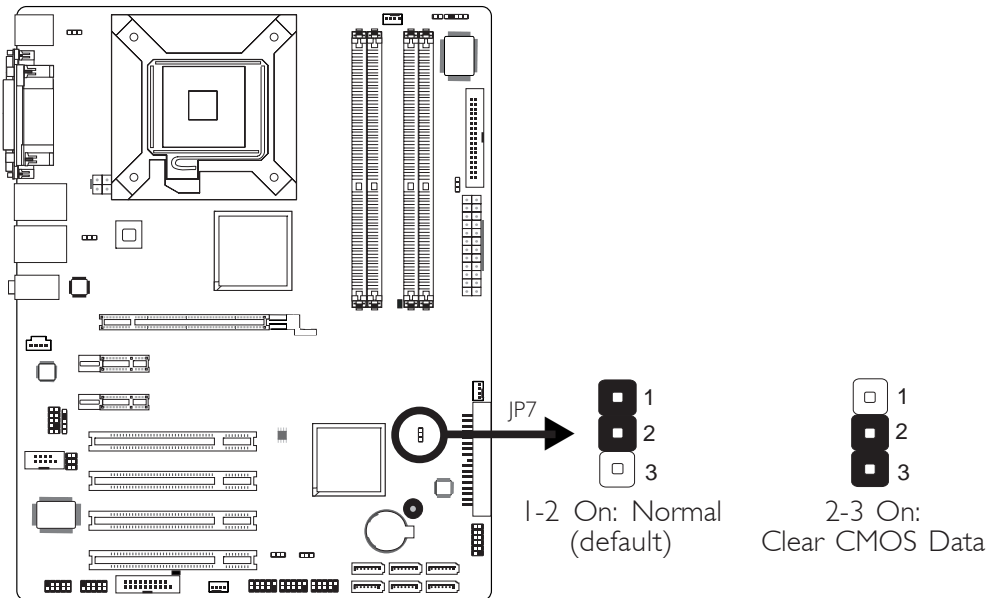

If you encounter the following,

- CMOS data becomes corrupted.*
- You forgot the supervisor or user password.*
- You are unable to boot-up the computer system because the processor's ratio was incorrectly set in the BIOS.*

you can reconfigure the system with the default values stored in the ROM BIOS.

To load the default values stored in the ROM BIOS, please follow the steps below.

- Power-off the system and unplug the power cord.
- Set JP7 pins 2 and 3 to On. Wait for a few seconds and set JP7 back to its default setting, pins 1 and 2 On.
- Now plug the power cord and power-on the system.

If your reason for clearing the CMOS data is due to incorrect setting of the processor's ratio in the BIOS, please proceed to step 4.

4. After powering-on the system, press to enter the main menu of the BIOS.
5. Select the Frequency/Voltage Control submenu then press <Enter>.
6. Set the processor's ratio to its default setting or an appropriate clock ratio. Refer to the Frequency/Voltage Control section in chapter 3 for more information.
7. Press <Esc> to return to the main menu of the BIOS setup utility. Select "Save & Exit Setup" and press <Enter>.
8. Type <Y> and press <Enter>.

PS/2 Power Select

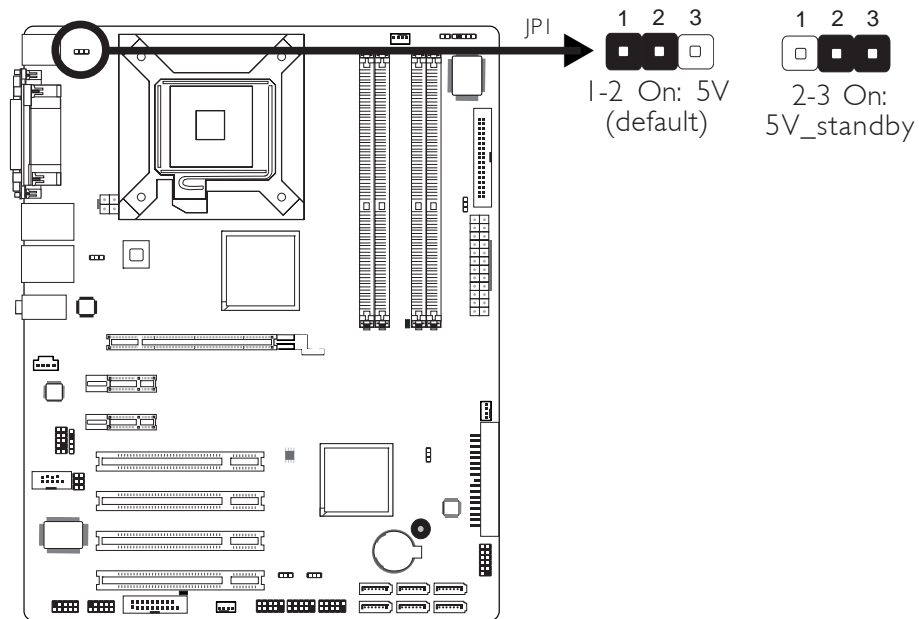

JPI is used to select the power of the PS/2 keyboard/mouse port. Selecting 5V_standby will allow you to use the PS/2 keyboard or PS/2 mouse to wake up the system.

BIOS Setting

Configure the PS/2 keyboard/mouse wake up function in the Integrated Peripherals submenu ("Super IO Device" section) of the BIOS. Refer to chapter 3 for more information.

**Important:**

The 5V_standby power source of your power supply must support $\geq 720\text{mA}$.

USB Power Select

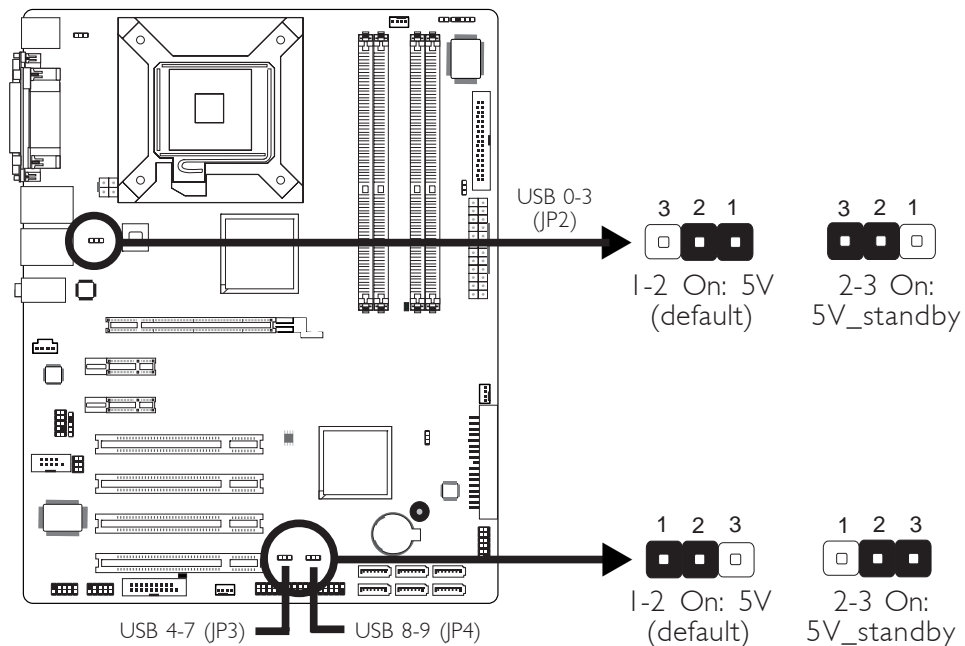

JP2, JP3 and JP4 are used to select the power of the USB ports. Selecting 5V_standby will allow you to use the USB keyboard or USB mouse to wake up the system.

BIOS Setting

“USB KB Wake-Up From S3” in the Power Management Setup submenu of the BIOS must be set to Enabled. Refer to chapter 3 for more information.



Important:

If you are using the Wake-On-USB Keyboard/Mouse function for 2 USB ports, the 5V_standby power source of your power supply must support $\geq 1.5A$. For 3 or more USB ports, the 5V_standby power source of your power supply must support $\geq 2A$.

COM 2 RS232/AUX Select

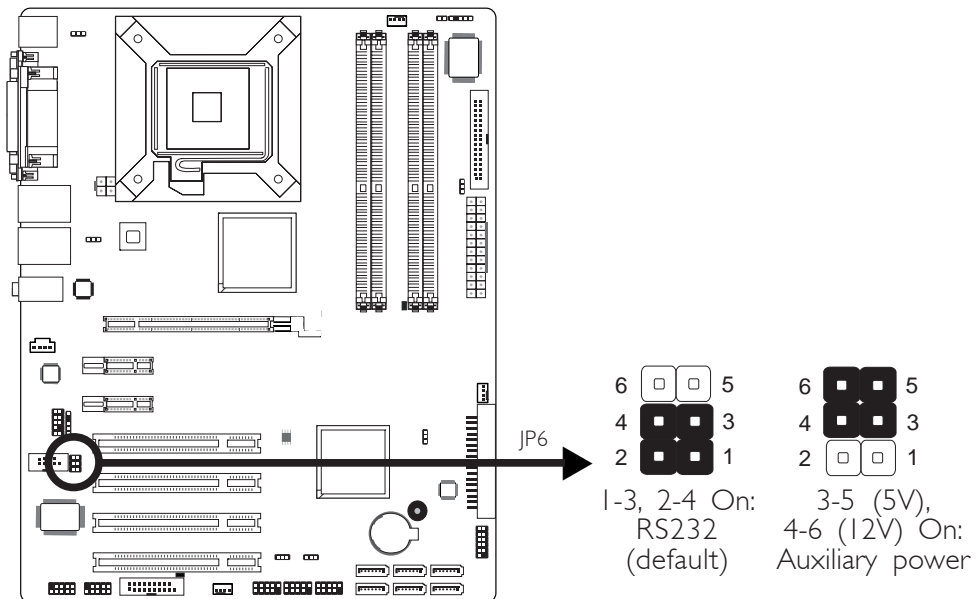

COM 2 is an RS-232 port. If the serial device connected to this port requires 5V/12V power from the system board, set JP6 pins 3-5 and 4-6 to On. Otherwise, leave this jumper's setting at 1-3, 2-4 On.

The table below list the pin assignment of JP6.

1	MRI2-	2	MDCD2-
3	X_MRI2-	4	X_MDCD2-
5	Vcc	6	+12V

Power-on Select

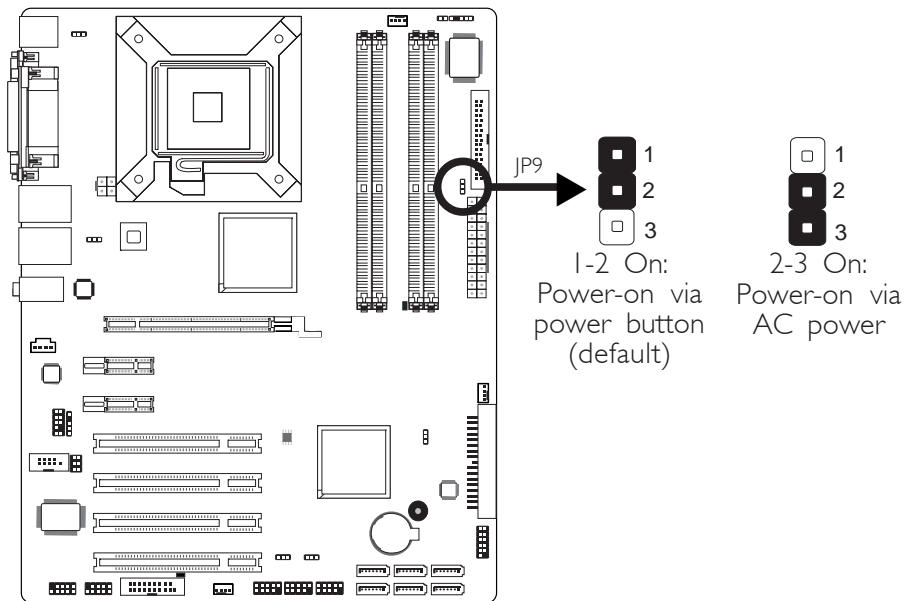

JP9 is used to select the method of powering on the system. If you want the system to power-on whenever AC power comes in, set JP9 pins 2 and 3 to On. If you want to use the power button, set pins 1 and 2 to On.

Rear Panel I/O Ports

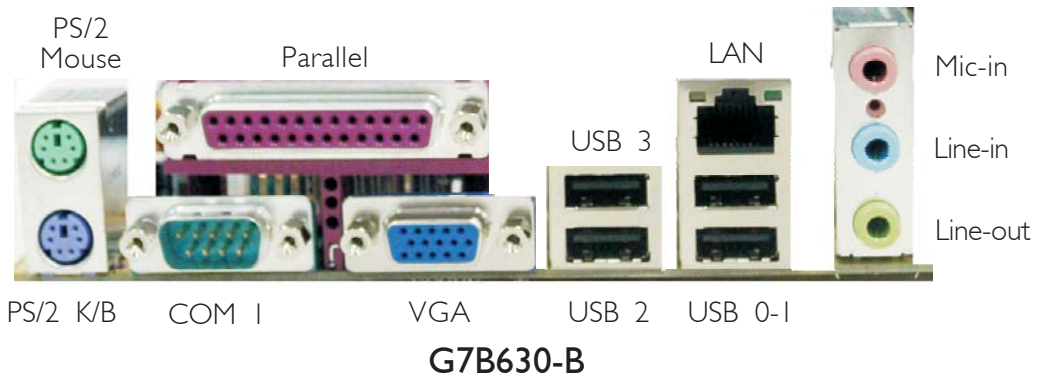
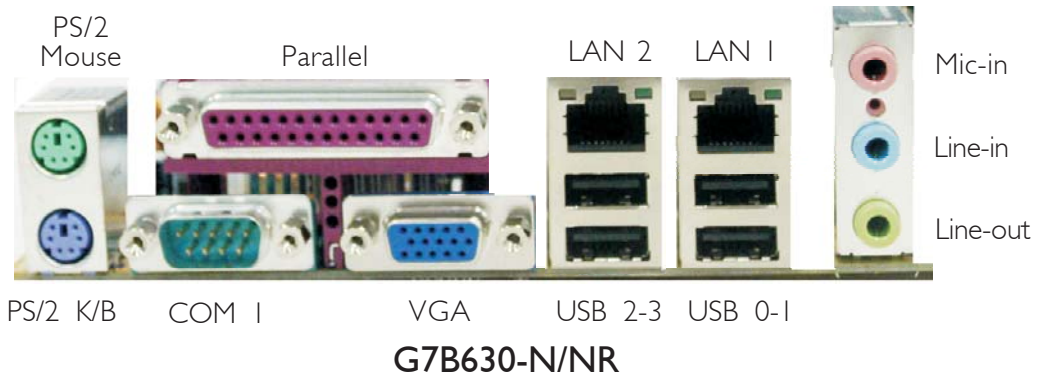

PS/2 Mouse and PS/2 Keyboard Ports

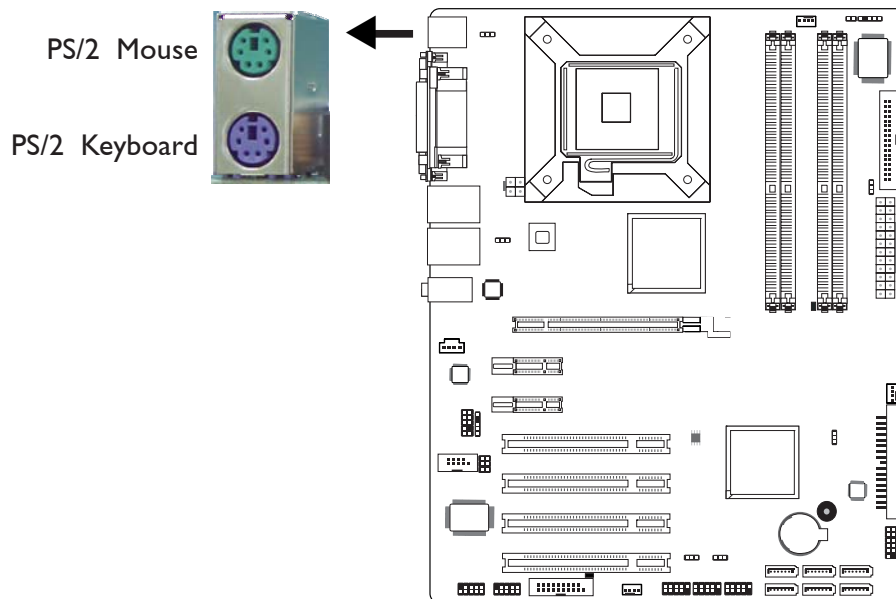

The system board is equipped with an onboard PS/2 mouse (Green) and PS/2 keyboard (Purple) ports - both at location CNI1 of the system board. The PS/2 mouse port uses IRQ12. If a mouse is not connected to this port, the system will reserve IRQ12 for other expansion cards.



Warning:

Make sure to turn off your computer prior to connecting or disconnecting a mouse or keyboard. Failure to do so may damage the system board.

Wake-On-PS/2 Keyboard/Mouse

The Wake-On-PS/2 Keyboard/Mouse function allows you to use the PS/2 keyboard or PS/2 mouse to power-on the system. To use this function:

- **Jumper Setting:**
JPI must be set to "2-3 On: 5V_standby". Refer to "PS/2 Power Select" in this chapter for more information.

- **BIOS Setting:**
Configure the PS/2 wake up function in the Integrated Peripherals submenu (“Super IO Device” section) of the BIOS. Refer to chapter 3 for more information.

**Important:**

The 5V_standby power source of your power supply must support $\geq 720\text{mA}$.

Parallel Port

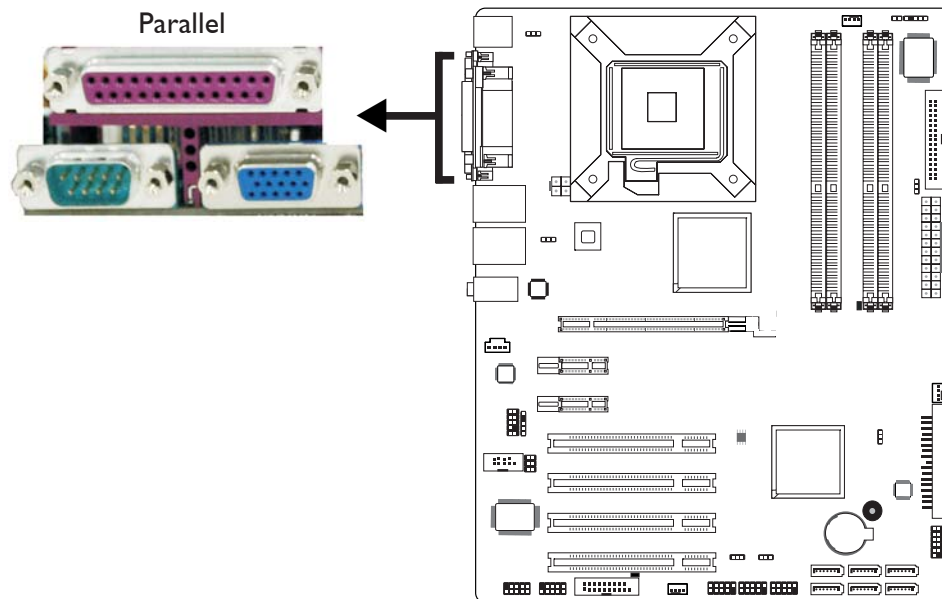

The system board has a standard parallel port (Burgundy) at location CN7 for interfacing your PC to a parallel printer. It supports SPP, ECP and EPP.

Setting	Function
SPP (Standard Parallel Port)	Allows normal speed operation but in one direction only.
ECP (Extended Capabilities Port)	Allows parallel port to operate in bidirectional mode and at a speed faster than the SPP's data transfer rate.
EPP (Enhanced Parallel Port)	Allows bidirectional parallel port operation at maximum speed.

BIOS Setting

Configure the parallel port in the Integrated Peripherals submenu ("Super IO Device" section) of the BIOS. Refer to chapter 3 for more information.

Serial Ports

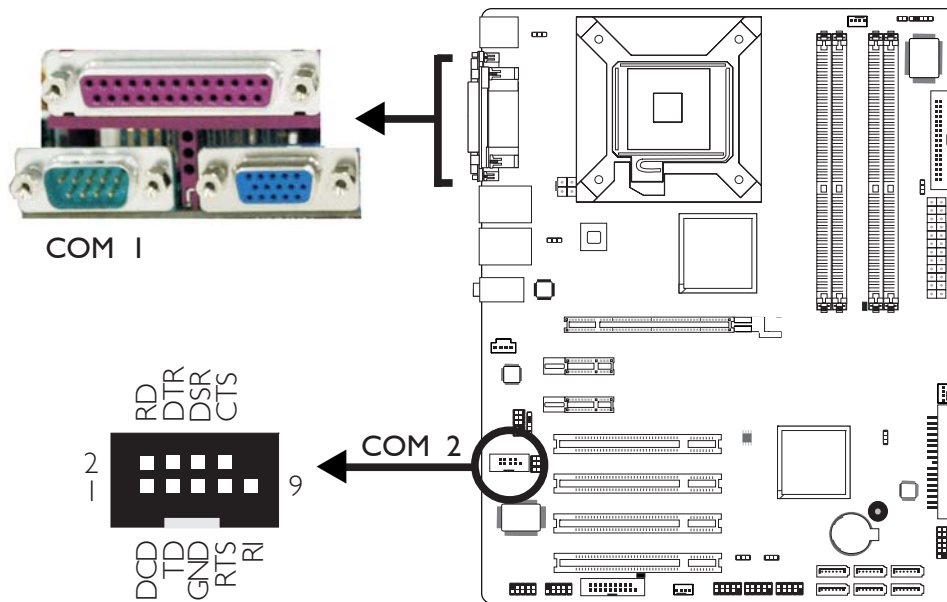

The system board is equipped with an onboard serial port (COM 1) at location CN4. It is also equipped with a 9-pin connector at location J4 (COM 2). The serial ports are RS-232 asynchronous communication ports with 16C550A-compatible UARTs that can be used with modems, serial printers, remote display terminals, and other serial devices.

To connect COM 2, please refer to the following description. The serial port may be mounted on a card-edge bracket. Install the card-edge bracket to an available slot at the rear of the system chassis then insert the cable connector to J4. Make sure the colored stripe on the ribbon cable is aligned with pin 1 of J4.

Jumper Setting

Use JP6 to configure COM 2. Refer to “COM 2 RS232/AUX Select” in this chapter for more information.

BIOS Setting

Configure the serial ports in the Integrated Peripherals submenu (“Super IO Device” section) of the BIOS. Refer to chapter 3 for more information.

VGA Port

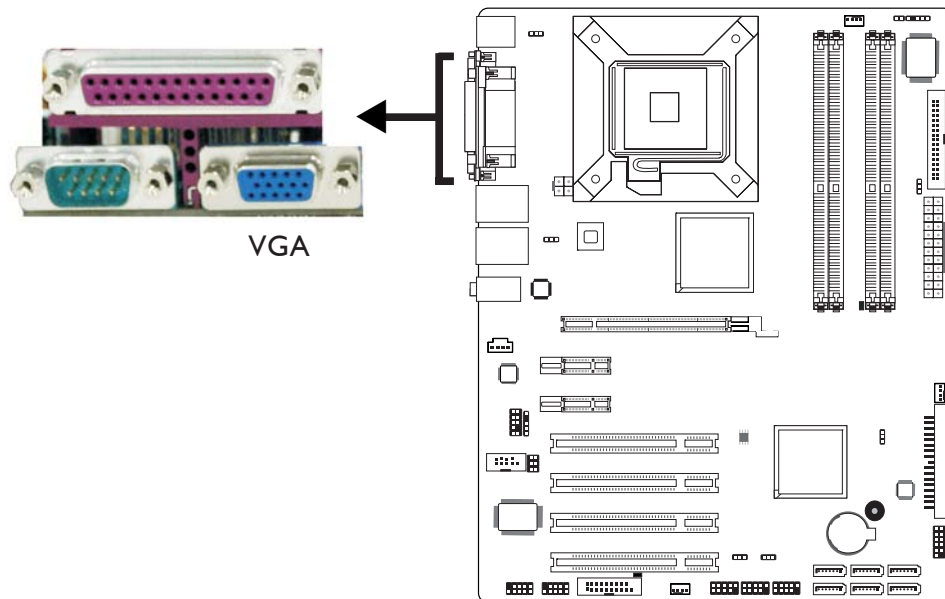

The VGA port is used for connecting a VGA monitor. Connect the monitor's 15-pin D-shell cable connector to the VGA port (Blue) at location CN2. After you plug the monitor's cable connector into the VGA port, gently tighten the cable screws to hold the connector in place.

BIOS Setting

Configure the onboard VGA in the Advanced Chipset Features submenu of the BIOS. Refer to chapter 3 for more information.

Driver Installation

Install the graphics driver. Refer to chapter 4 for more information.

RJ45 Fast-Ethernet Port

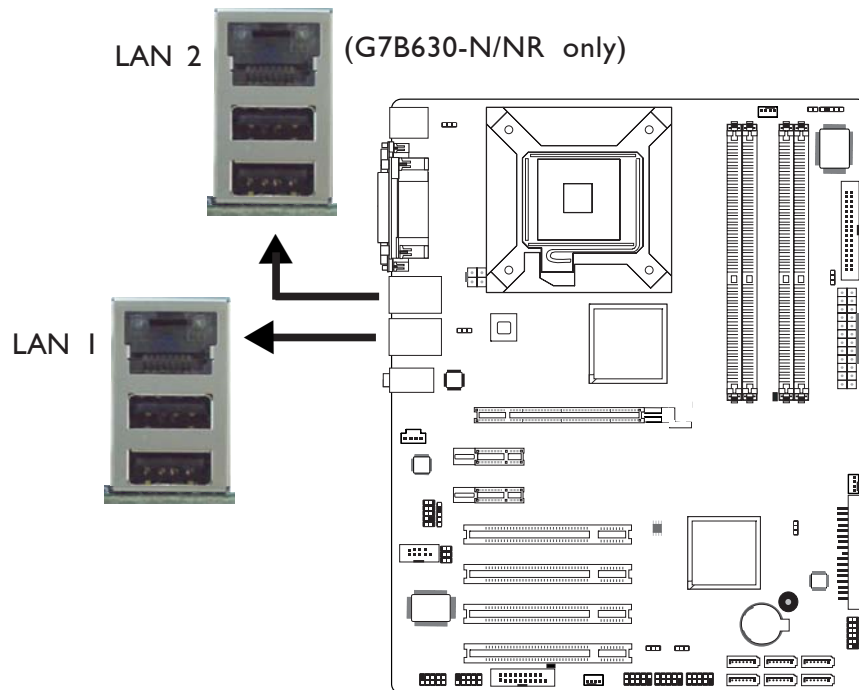

The dual LAN ports allow the G7B630-N/NR system board to connect to a local area network by means of a network hub. The Intel 82566DM PCIE Gigabit chip controls LAN 2 and the Marvell 88E8056 PCIE Gigabit chip controls LAN 1.

G7B630-B is only equipped with the LAN 1 port.

BIOS Setting

Configure the onboard LAN in the Integrated Peripherals submenu (“Onboard Device” section) of the BIOS. Refer to chapter 3 for more information.

Driver Installation

Install the LAN drivers. Refer to chapter 4 for more information.

Universal Serial Bus Connectors

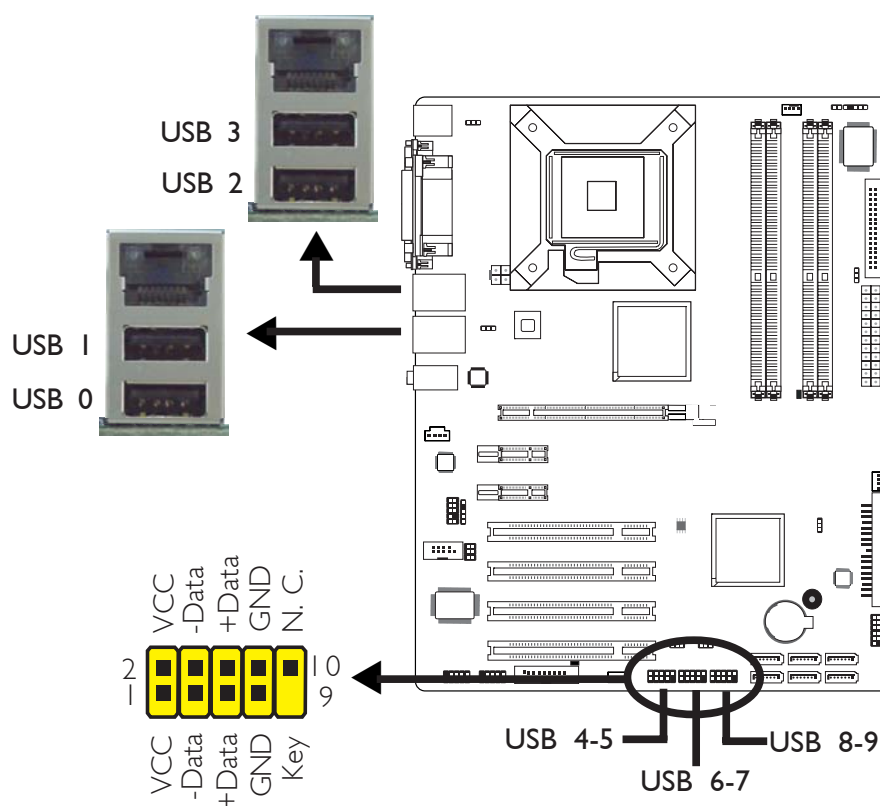

The system board supports 10 USB 2.0/1.1 ports. USB allows data exchange between your computer and a wide range of simultaneously accessible external Plug and Play peripherals.

Four onboard USB 2.0/1.1 ports (Black) are at locations CN5 (USB 2-3) and CN6 (USB 0-1) of the system board.

The J9 (USB 4-5), J10 (USB 6-7) and J11 (USB 8-9) connectors allow you to connect 6 additional USB 2.0/1.1 ports. The additional USB ports may be mounted on a card-edge bracket. Install the card-edge bracket to an available slot at the rear of the system chassis then insert the connector that is attached to the USB port cables to J9, J10 and/or J11.

BIOS Setting

Configure the onboard USB in the Integrated Peripherals submenu ("USB Device Setting" section) of the BIOS. Refer to chapter 3 for more information.

Driver Installation

You may need to install the proper drivers in your operating system to use the USB device. Refer to your operating system's manual or documentation for more information.

Refer to chapter 4 for more information about installing the USB 2.0 driver.

Wake-On-USB Keyboard/Mouse

The Wake-On-USB Keyboard/Mouse function allows you to use a USB keyboard or USB mouse to wake up a system from the S3 (STR - Suspend To RAM) state. To use this function:

- **Jumper Setting:**
JP2, JP3 and/or JP4 must be set to "2-3 On: 5V_standby". Refer to "USB Power Select" in this chapter for more information.
- **BIOS Setting:**
"USB KB Wake-Up From S3" in the Power Management Setup submenu of the BIOS must be set to Enabled. Refer to chapter 3 for more information.



Important:

If you are using the Wake-On-USB Keyboard/Mouse function for 2 USB ports, the 5V_standby power source of your power supply must support $\geq 1.5A$. For 3 or more USB ports, the 5V_standby power source of your power supply must support $\geq 2A$.

Audio

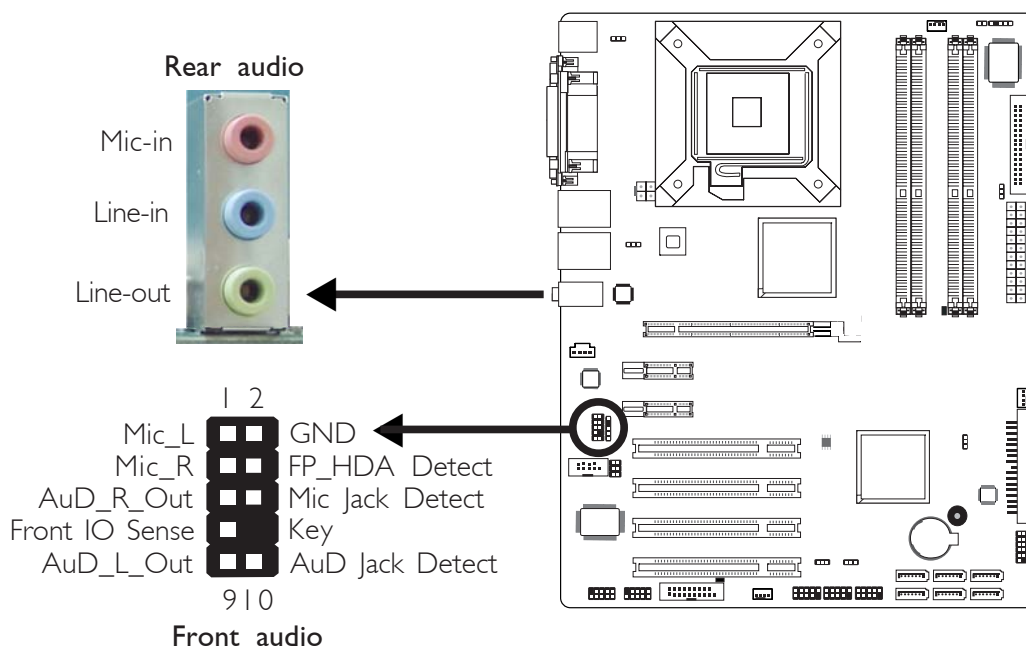

Rear Audio

The system board is equipped with 3 audio jacks at location CN10. A jack is a one-hole connecting interface for inserting a plug.

- **Mic-in Jack (Pink)**
This jack is used to connect an external microphone.
- **Line-in Jack (Light Blue)**
This jack is used to connect any audio devices such as Hi-fi set, CD player, tape player, AM/FM radio tuner, synthesizer, etc.
- **Line-out Jack (Lime)**
This jack is used to connect a headphone or external speakers.

2

Hardware Installation

Driver Installation

Install the audio driver. Refer to chapter 4 for more information.

I/O Connectors

CD-in Internal Audio Connector

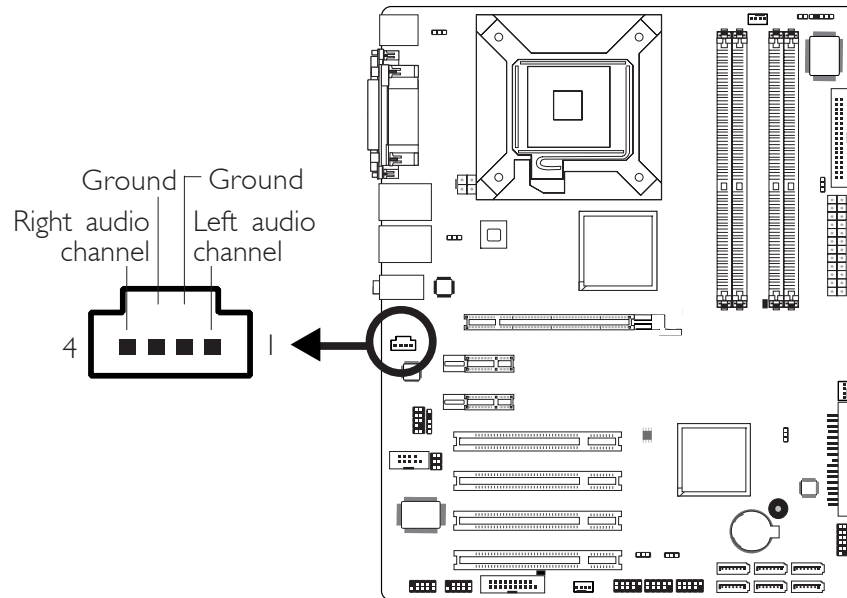

The CD-in connector (J15) is used to receive audio from a CD-ROM drive, TV tuner or MPEG card.

S/PDIF-in/out Connector

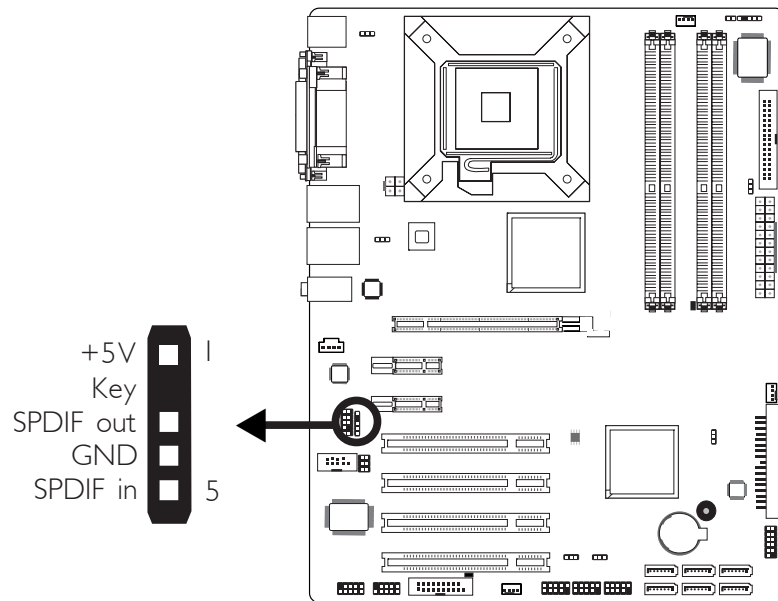

The S/PDIF-in/out connector (J7) is used to connect an external S/PDIF port. Your S/PDIF port may be mounted on a card-edge bracket. Install the card-edge bracket to an available slot at the rear of the system chassis then connect the audio cable connector to J7. Make sure pin 1 of the audio cable connector is aligned with pin 1 of J7.

IEEE 1394 Connectors (G7B630-N/NR)

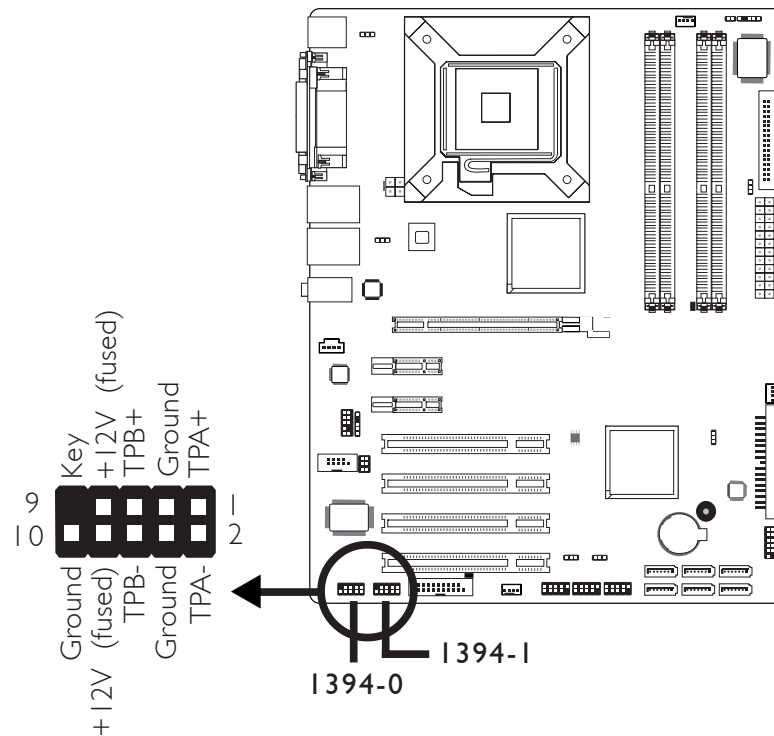

The system board is equipped with two IEEE 1394 connectors at locations J2 (1394-0) and J5 (1394-1) for connecting external 1394 ports. The 1394 ports may come mounted on a card-edge bracket. Install the card-edge bracket to an available slot at the rear of the system chassis then insert the connector that is attached to the 1394 port cables to J2 or J5. Make sure pin 1 of the cable connector is aligned with pin 1 of the J2 or J5.

Digital I/O Connector

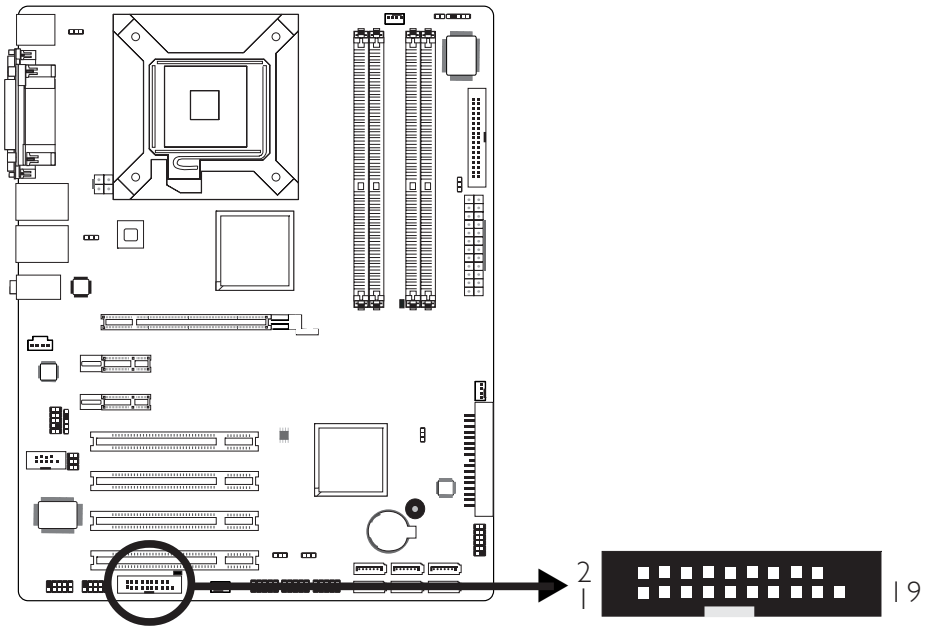

The Digital I/O connector (J6) provides powering-on function to an external device that is connected to this connector. The Digital I/O bus provides 8-bit write and 8-bit read.

Digital I/O Connector

Pins	Function	Pins	Function
1	GND	2	+12V
3	DIO7	4	+12V
5	DIO6	6	GND
7	DIO5	8	VCC
9	DIO4	10	VCC
11	DIO3	12	GND
13	DIO2	14	V_5P0_STBY
15	DIO1	16	V_5P0_STBY
17	DIO0	18	GND
19	GND		

Floppy Disk Drive Connector

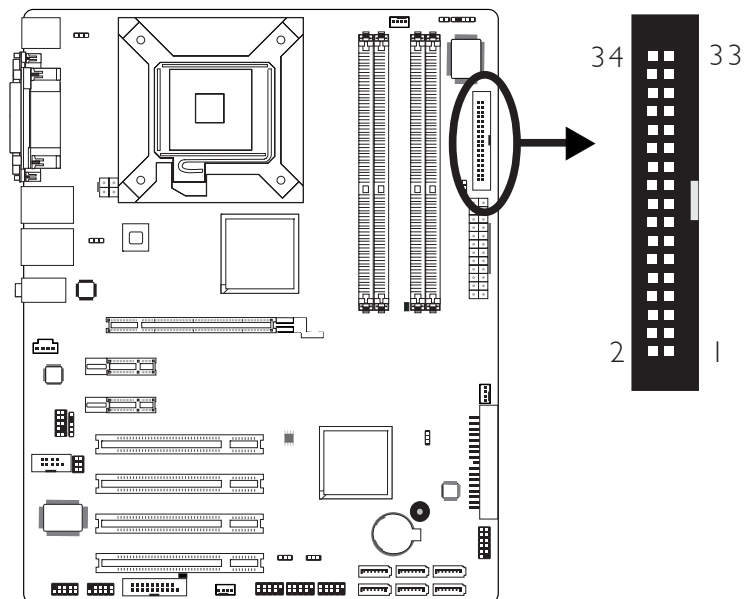

The floppy disk drive connector supports a standard floppy disk drive. To prevent improper floppy cable installation, the floppy disk header has a keying mechanism. The 34-pin connector on the floppy cable can be placed into the header only if pin 1 of the connector is aligned with pin 1 of the header.

Connecting the Floppy Disk Drive Cable

Install one end of the floppy disk drive cable into the shrouded floppy disk header (J17) on the system board and the other end-most connector to the floppy drive. The colored edge of the daisy chained ribbon cable should be aligned with pin 1 of J17.

BIOS Setting

Enable or disable this function in the Integrated Peripherals submenu (“Super IO Device” section) of the BIOS. Refer to chapter 3 for more information.

Serial ATA Connectors

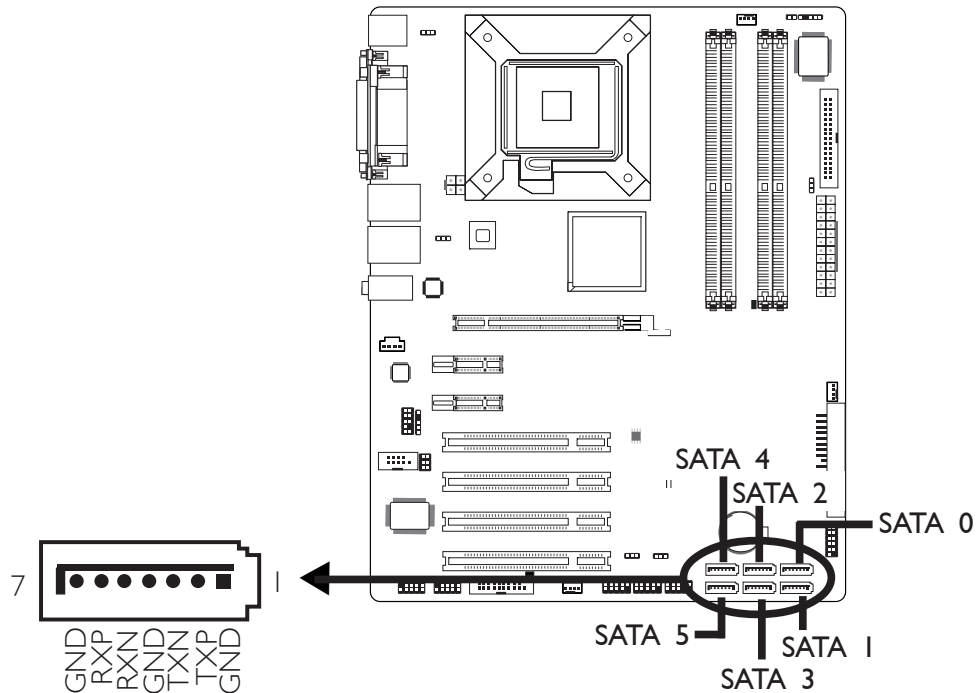

- G7B630-NR
 - 6 Serial ATA ports (SATA 0/1/2/3/4/5)
 - SATA speed up to 3Gb/s
 - RAID 0, RAID 1, RAID 5 and RAID 10
- G7B630-B and G7B630-N
 - 4 Serial ATA ports (SATA 0/1/4/5)
 - SATA speed up to 3Gb/s

Connecting Serial ATA Cables

Connect one end of the Serial ATA cable to J25 (SATA 4), J23 (SATA 2), J21 (SATA 0), J24 (SATA 3) or J26 (SATA 5) connector and the other end to your Serial ATA device.

BIOS Setting

Configure Serial ATA in the Integrated Peripherals submenu ("OnChip IDE Device" section) of the BIOS. Refer to chapter 3 for more information.

Configuring RAID

The system board allows configuring RAID on Serial ATA drives. Refer to chapter 5 for steps in configuring RAID.

IDE Disk Drive Connector

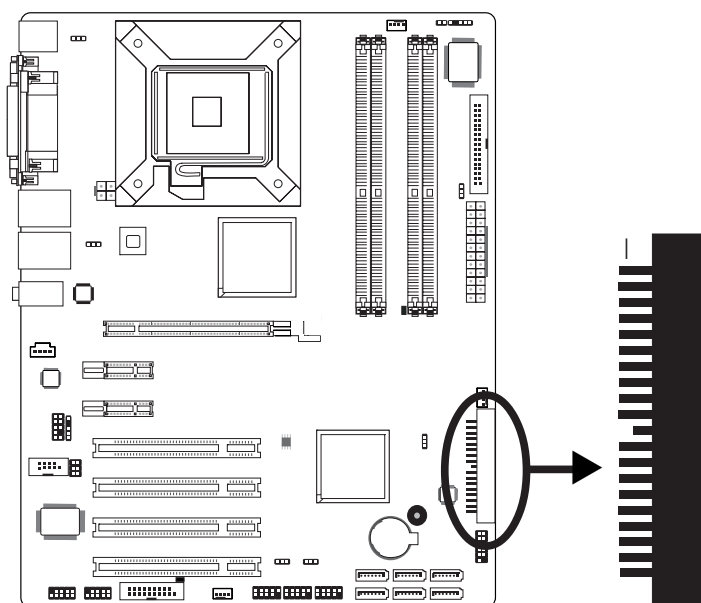

The 90° shrouded PCI IDE header will interface two Enhanced IDE (Integrated Drive Electronics) disk drives. To prevent improper IDE cable installation, the shrouded PCI IDE header has a keying mechanism. The 40-pin connector on the IDE cable can be placed into the header only if pin 1 of the connector is aligned with pin 1 of the header:

Connecting the IDE Disk Drive Cable

The IDE connector supports 2 devices, a Master and a Slave. Use an IDE ribbon cable to connect the drives to the system board. An IDE ribbon cable has 3 connectors on them, one that plugs into an IDE connector on the system board and the other 2 connect to IDE devices. The connector at the end of the cable is for the Master drive and the connector in the middle of the cable is for the Slave drive.

Install one end of the IDE cable into the IDE header on the system board and the other connectors to the IDE devices.

Adding a Second IDE Disk Drive

When using two IDE drives, one must be set as the master and the other as the slave. Follow the instructions provided by the drive manufacturer for setting the jumpers and/or switches on the drives.

The system board supports Enhanced IDE or ATA-2, ATA/33, ATA/66, ATA/100 and ATA/133 hard drives. We recommend that you use hard drives from the same manufacturer. In a few cases, drives from two different manufacturers will not function properly when used together. The problem lies in the hard drives, not the system board.

**Important:**

If you encountered problems while using an ATAPI CD-ROM drive that is set in Master mode, please set the CD-ROM drive to Slave mode. Some ATAPI CD-ROMs may not be recognized and cannot be used if incorrectly set in Master mode.

BIOS Setting

Configure the onboard IDE in the Integrated Peripherals submenu (“OnChip IDE Device” section) of the BIOS. Refer to chapter 3 for more information.

IrDA Connector

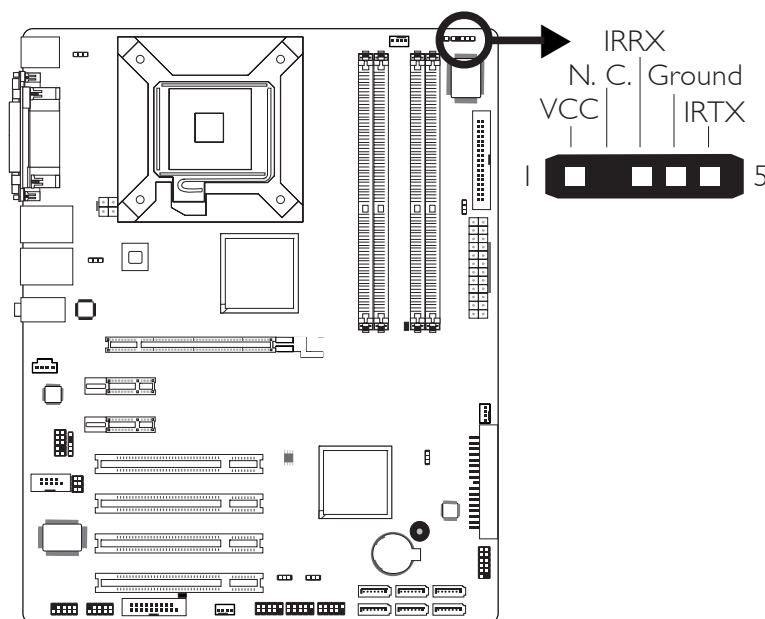

Connect the cable connector from your IrDA module to J14 on the system board.



Note:

The sequence of the pin functions on some IrDA cable may be reversed from the pin function defined on the system board. Make sure to connect the cable to the IrDA connector according to their pin functions.

BIOS Setting

Configure IrDA in the Integrated Peripherals submenu ("Super IO Device" section) of the BIOS. Refer to chapter 3 for more information.

Driver Installation

You may need to install the proper drivers in your operating system to use the IrDA function. Refer to your operating system's manual or documentation for more information.

Cooling Fan Connectors

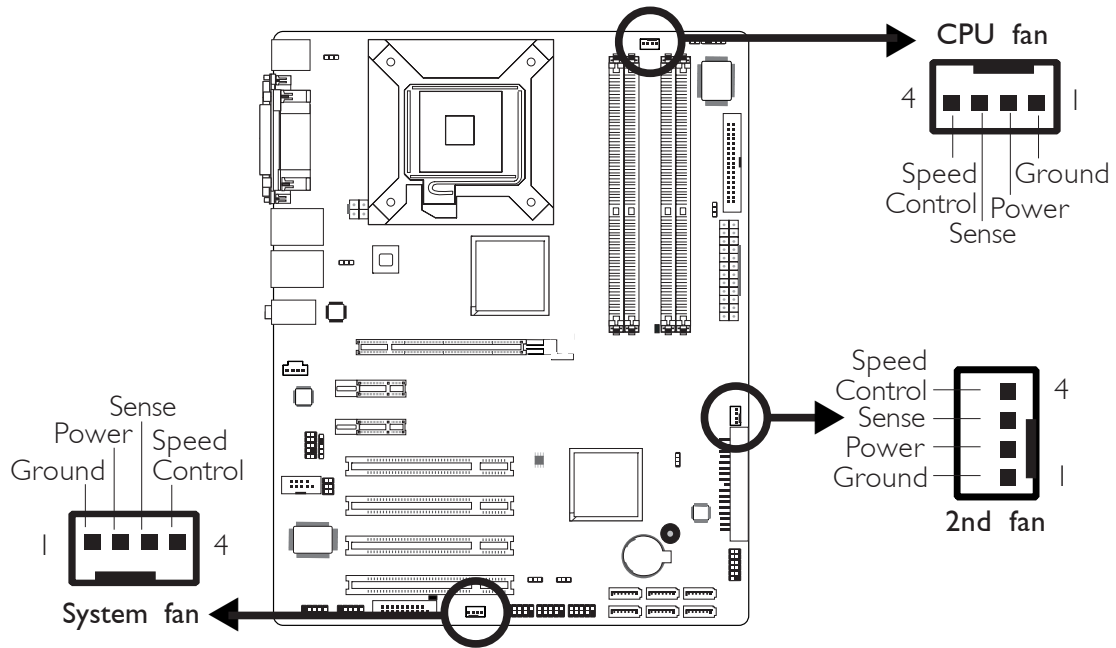

Connect the CPU fan's cable connector to the CPU fan connector (J12) on the system board. The system fan connector (J8) and 2nd fan connector (J18) are used to connect additional cooling fans. The cooling fans will provide adequate airflow throughout the chassis to prevent overheating the CPU and system board components.

BIOS Setting

The "PC Health Status" submenu of the BIOS will display the current speed of the cooling fans. Refer to chapter 3 for more information.

Chassis Open Connector

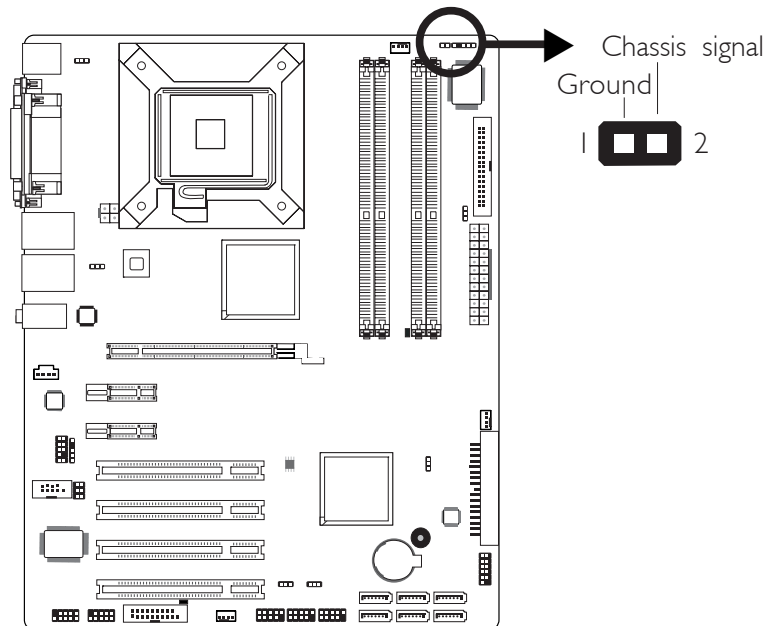

The system board supports the chassis intrusion detection function. Connect the chassis intrusion sensor cable from the chassis to J13. Whenever a chassis component has been removed, the sensor sends signal to J13 alerting you of a chassis intrusion event. To disable this function, place a jumper cap over J13.

Hardware Monitor for Windows

Install the “Hardware Monitor for Windows” utility. By default, the chassis intrusion detection function is disabled. When enabled, a warning message will appear when the chassis is open. The utility can also be configured so that a beeping alarm will sound when the chassis is open. Refer to the “Hardware Monitor for Windows” section in chapter 4 for more information.

Power Connectors

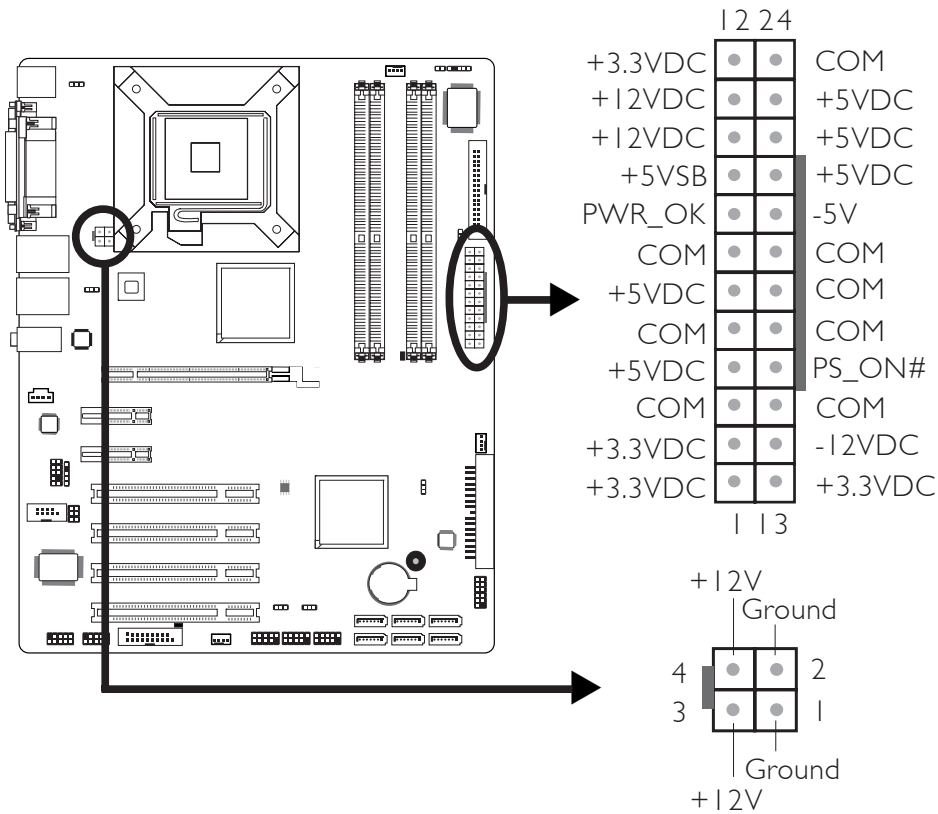

Use a power supply that complies with the ATX12V Power Supply Design Guide Version 1.1. An ATX12V power supply has a standard 24-pin ATX main power connector and a 4-pin +12V power connector that must be inserted onto CN8 and CN3 connectors respectively.

The 4-pin +12V power connector enables the delivery of more +12VDC current to the processor's Voltage Regulator Module (VRM).

The system board requires a minimum of 300 Watt power supply to operate. Your system configuration (CPU power, amount of memory, add-in cards, peripherals, etc.) may exceed the minimum power requirement. To ensure that adequate power is provided, we strongly recommend that you use a minimum of 400 Watt (or greater) power supply.

Standby Power LED

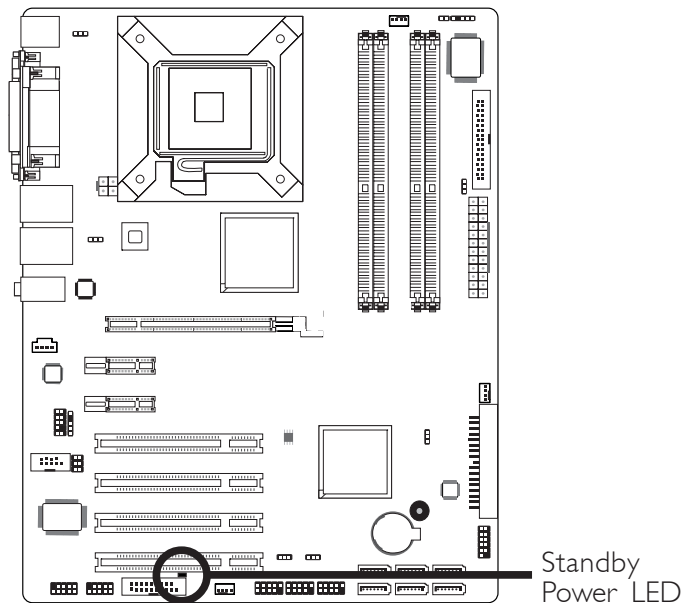

Standby Power LED

This LED will light when the system is in the standby mode.



Important:

If the Standby Power LED is lighted, you must power-off the system then turn off the power supply's switch or unplug the power cord prior to installing any add-in cards.

Front Panel Connectors

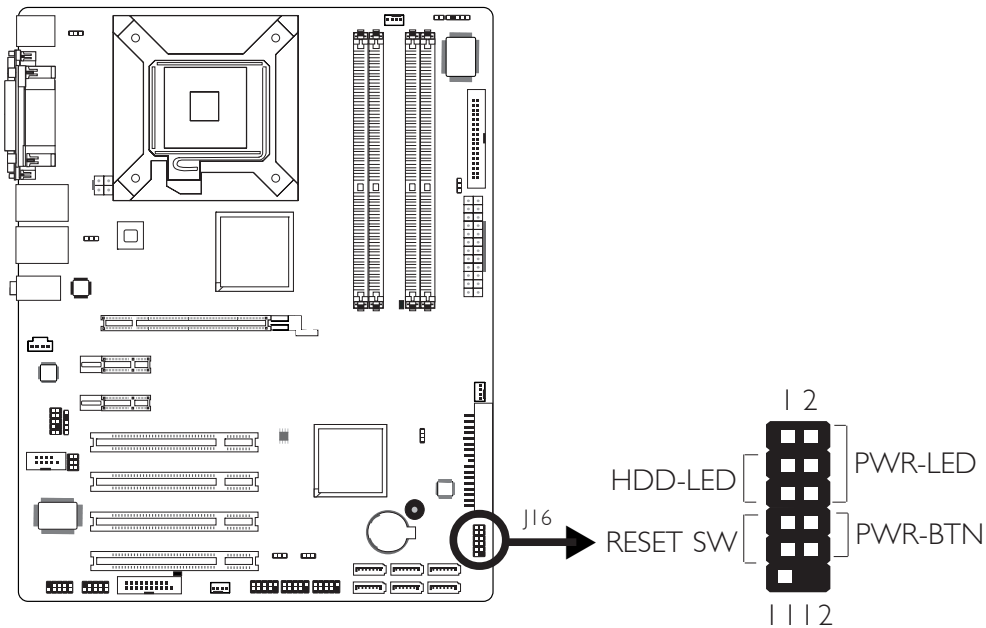
**HDD-LED - HDD LED**

This LED will light when the hard drive is being accessed.

RESET SW - Reset Switch

This switch allows you to reboot without having to power off the system.

PWR-BTN - Power Switch

This switch is used to power on or off the system.

PWR-LED - Power/Standby LED

When the system's power is on, this LED will light. When the system is in the S1 (POS - Power On Suspend) state, it will blink every second. When the system is in the S3 (STR - Suspend To RAM) state, it will blink every 4 seconds.

	Pin	Pin Assignment		Pin	Pin Assignment
N. C.	1	N. C.	PWR-LED	2	LED Power
				4	LED Power
				6	Signal
HDD-LED	3	HDD Power	PWR-BTN	8	3V_DUAL
	5	Signal		10	Signal
RESET SW	7	Ground			
	9	RST Signal			
N. C.	11	N. C.	Key	12	Key

PCI Express Slots

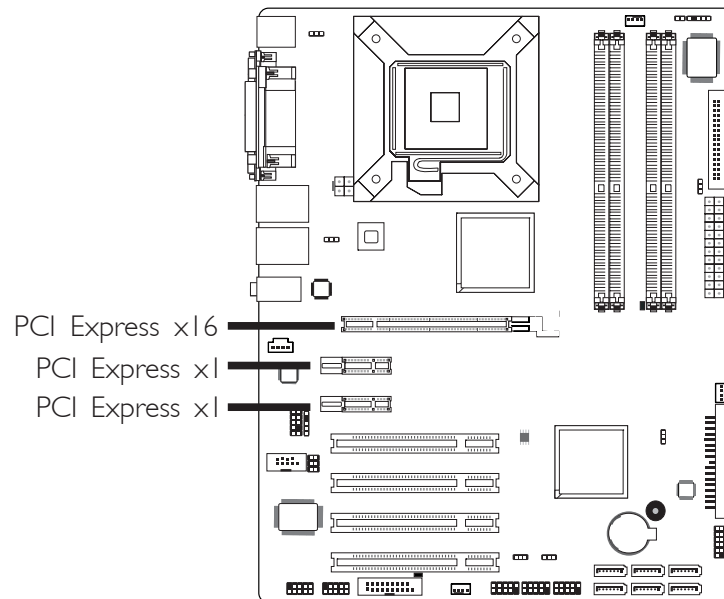

PCI Express x16

Install PCI Express x16 graphics card, that comply to the PCI Express specifications, into the PCI Express x16 slot. To install a graphics card into the x16 slot, align the graphics card above the slot then press it down firmly until it is completely seated in the slot. The retaining clip of the slot will automatically hold the graphics card in place.

PCI Express x1

Install PCI Express x1 cards such as network cards or other cards that comply to the PCI Express specifications into the PCI Express x1 slot.

Battery

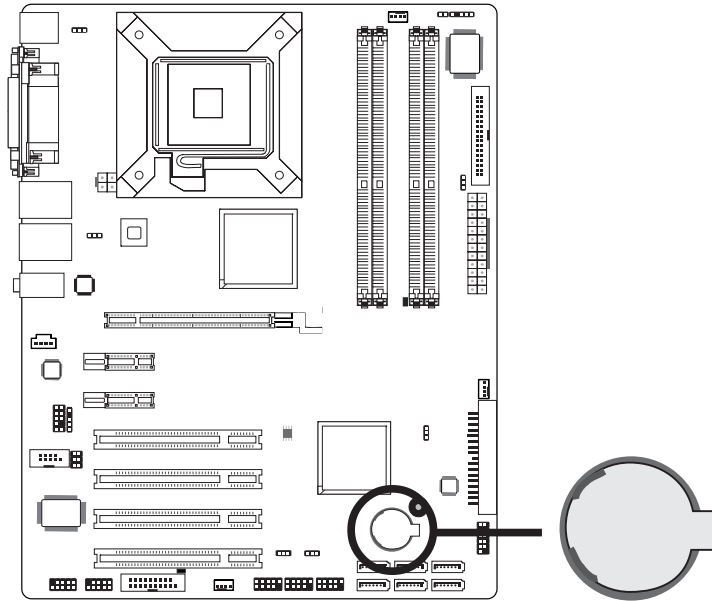

The lithium ion battery powers the real-time clock and CMOS memory. It is an auxiliary source of power when the main power is shut off.

Safety Measures

- Danger of explosion if battery incorrectly replaced.
- Replace only with the same or equivalent type recommend by the manufacturer.
- Dispose of used batteries according to local ordinance.

Chapter 3 - BIOS Setup

Award BIOS Setup Utility

The Basic Input/Output System (BIOS) is a program that takes care of the basic level of communication between the processor and peripherals. In addition, the BIOS also contains codes for various advanced features found in this system board. This chapter explains the Setup Utility for the Award BIOS.

After you power up the system, the BIOS message appears on the screen and the memory count begins. After the memory test, the following message will appear on the screen:

Press DEL to enter setup

If the message disappears before you respond, restart the system or press the "Reset" button. You may also restart the system by pressing the <Ctrl> <Alt> and keys simultaneously.

When you press , the main menu screen will appear:

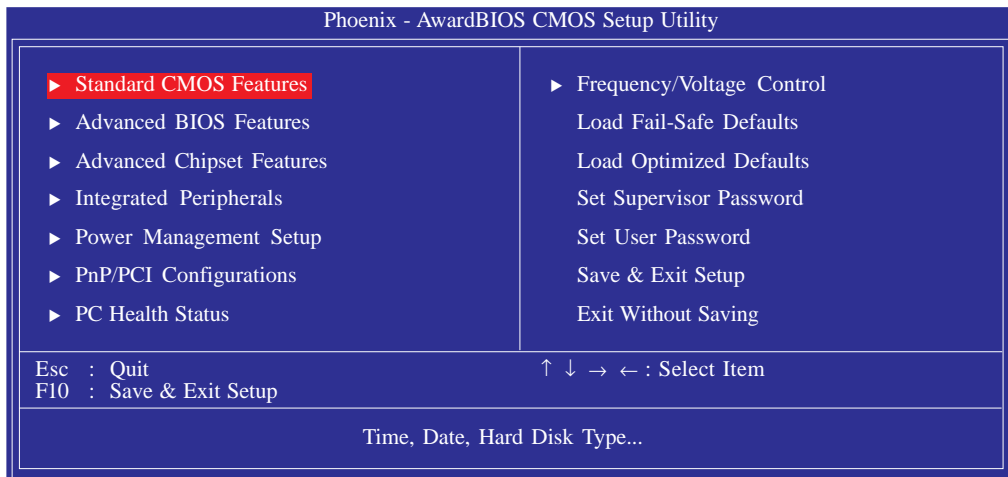

Standard CMOS Features

Use the arrow keys to highlight “Standard CMOS Features” and press <Enter>. A screen similar to the one below will appear:

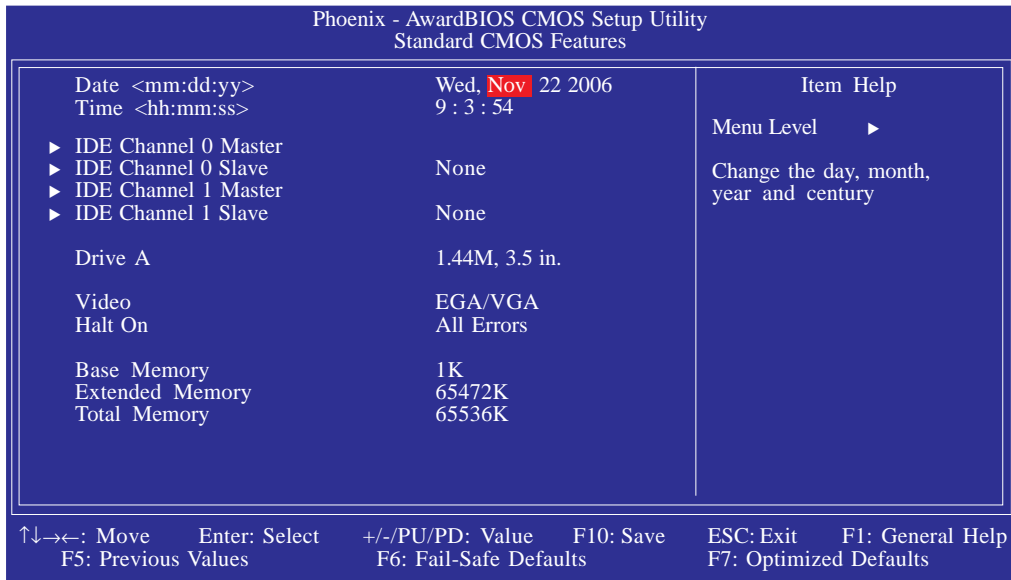

The settings on the screen are for reference only. Your version may not be identical to this one.

Date

The date format is <day>, <month>, <date>, <year>. Day displays a day, from Sunday to Saturday. Month displays the month, from January to December. Date displays the date, from 1 to 31. Year displays the year, from 1999 to 2099.

Time

The time format is <hour>, <minute>, <second>. The time is based on the 24-hour military-time clock. For example, 1 p.m. is 13:00:00. Hour displays hours from 00 to 23. Minute displays minutes from 00 to 59. Second displays seconds from 00 to 59.

IDE Channel 0 Master, IDE Channel 0 Slave, IDE Channel 1 Master and IDE Channel 1 Slave

To configure the IDE drives, move the cursor to a field then press <Enter>. The following screen will appear:

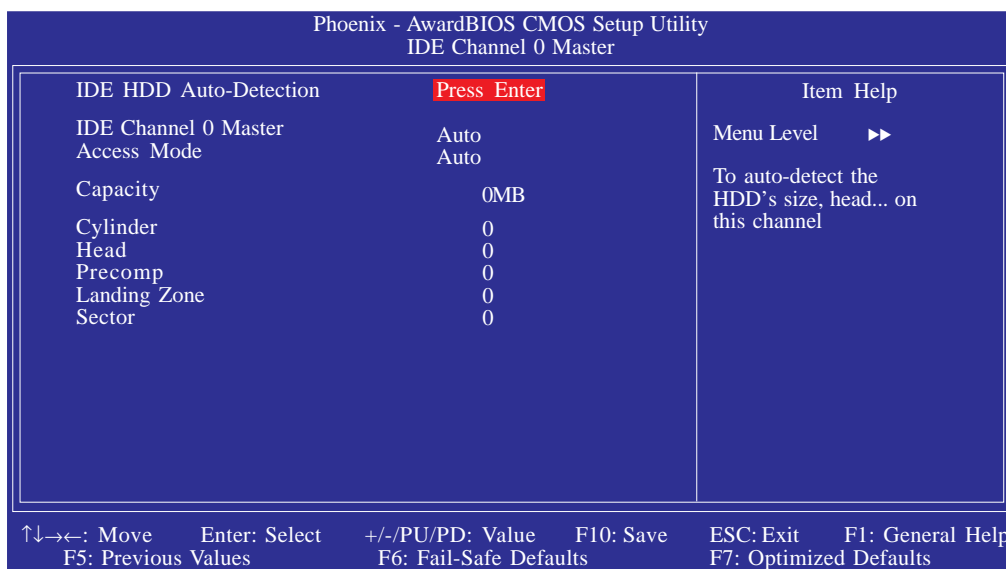

The settings on the screen are for reference only. Your version may not be identical to this one.

IDE HDD Auto-Detection

Detects the parameters of the drive. The parameters will automatically be shown on the screen.

IDE Channel 0 Master/Slave and IDE Channel 1 Master/Slave

If you select "Auto", the BIOS will auto-detect the HDD & CD-ROM drive at the POST stage and show the IDE for the HDD & CD-ROM drive. If a hard disk has not been installed, select "None".

Access Mode

For hard drives larger than 528MB, you would typically select the LBA type. Certain operating systems require that you select CHS or Large. Please check your operating system's manual or Help desk on which one to select.

Capacity

Displays the approximate capacity of the disk drive. Usually the size is slightly greater than the size of a formatted disk given by a disk checking program.

Cylinder

This field displays the number of cylinders.

Head

This field displays the number of read/write heads.

Precomp

This field displays the number of cylinders at which to change the write timing.

Landing Zone

This field displays the number of cylinders specified as the landing zone for the read/write heads.

Sector

This field displays the number sectors per track.

Drive A

This field identifies the type of floppy disk drive installed.

<i>None</i>	No floppy drive is installed
<i>360K, 5.25 in.</i>	5-1/4 in. standard drive; 360KB capacity
<i>1.2M, 5.25 in.</i>	5-1/4 in. AT-type high-density drive; 1.2MB capacity
<i>720K, 3.5 in.</i>	3-1/2 in. double-sided drive; 720KB capacity
<i>1.44M, 3.5 in.</i>	3-1/2 in. double-sided drive; 1.44MB capacity
<i>2.88M, 3.5 in.</i>	3-1/2 in. double-sided drive; 2.88MB capacity

Video

This field selects the type of video adapter used for the primary system monitor. Although secondary monitors are supported, you do not have to select the type. The default setting is EGA/VGA.

<i>EGA/VGA</i>	Enhanced Graphics Adapter/Video Graphics Array. For EGA, VGA, SVGA and PGA monitor adapters.
<i>CGA 40</i>	Color Graphics Adapter. Power up in 40-column mode.
<i>CGA 80</i>	Color Graphics Adapter. Power up in 80-column mode.
<i>Mono</i>	Monochrome adapter. Includes high resolution monochrome adapters.

Halt On

This field determines whether the system will stop if an error is detected during power up. The default setting is All Errors.

<i>No Errors</i>	The system boot will not stop for any errors detected.
<i>All Errors</i>	The system boot will stop whenever the BIOS detects a non-fatal error.
<i>All, But Keyboard</i>	The system boot will not stop for a keyboard error; it will stop for all other errors.
<i>All, But Diskette</i>	The system boot will not stop for a disk error; it will stop for all other errors.
<i>All, But Disk/Key</i>	The system boot will not stop for a disk or keyboard error; it will stop for all other errors.

Base Memory

Displays the amount of base (or conventional) memory installed in the system. The value of the base memory is typically 512K for systems with 512K memory installed on the motherboard or 640K for systems with 640K or more memory installed on the motherboard.

Extended Memory

Displays the amount of extended memory detected during boot-up.

Total Memory

Displays the total memory available in the system.

Advanced BIOS Features

The Advanced BIOS Features allows you to configure your system for basic operation. Some entries are defaults required by the system board, while others, if enabled, will improve the performance of your system or let you set some features according to your preference.

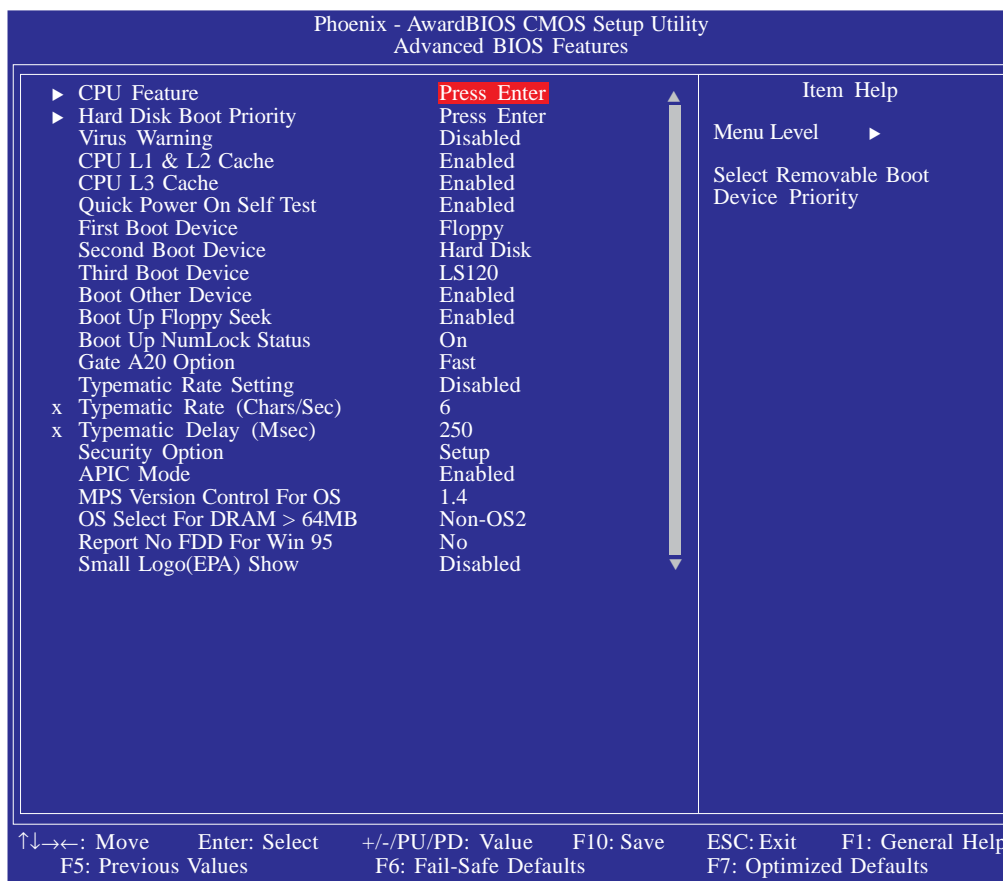

The screen above list all the fields available in the Advanced BIOS Features submenu, for ease of reference in this manual. In the actual CMOS setup, you have to use the scroll bar to view the fields. The settings on the screen are for reference only. Your version may not be identical to this one.

CPU Feature

This field is used to configure the CPU that is installed on the system board. Move the cursor to this field then press <Enter>.

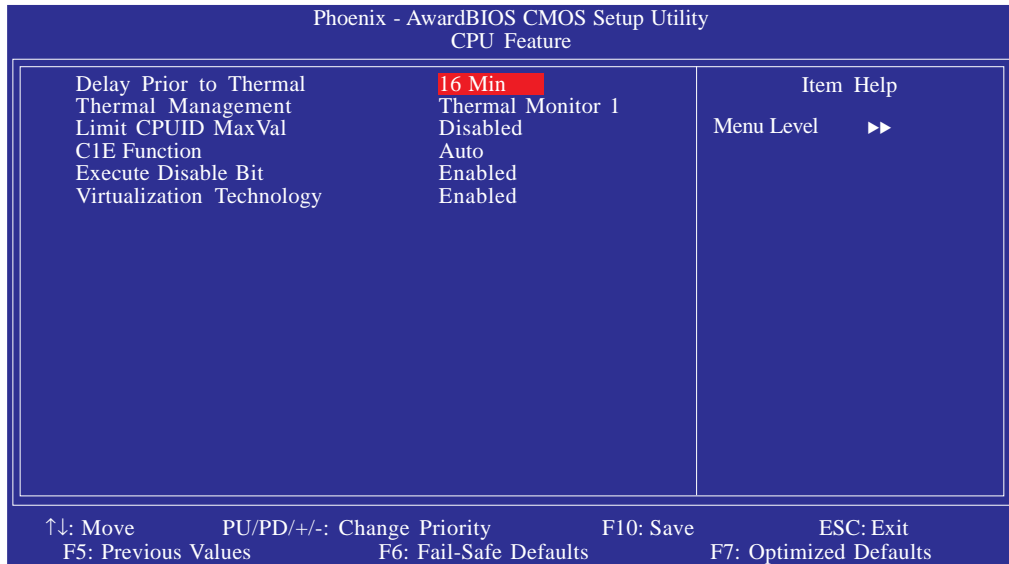

The settings on the screen are for reference only. Your version may not be identical to this one.

Delay Prior To Thermal

This field is used to select the time that would force the CPU to a 50% duty cycle when it exceeds its maximum operating temperature therefore protecting the CPU and the system board from overheating to ensure a safe computing environment.

Thermal Management

Select a “thermal monitor” in this field to enable the CPU's speedstep function. Restart the system then go to the operating system's “Control Panel”. Double-click “Power Options”. The “Power Options Properties” dialog box will appear. In the “Power Schemes” menu, select “Portable/Laptop”. Speedstep reduces the CPU's frequency and voltage in accordance to its load.

- Thermal Monitor 1* On die throttling.
- Thermal Monitor 2* Ratio and VID transition.

Limit CPUID MaxVal

The CPUID instruction of some newer CPUs will return a value greater than 3. Problems will occur only in certain operating systems. The default is Disabled because this problem does not exist in the Windows series operating systems. If you are using an operating system other than Windows, this problem may occur. To avoid this problem, enable this field to limit the return value to 3 or lesser than 3.

CIE Function

The options are Auto and Disabled.

Execute Disable Bit

When this field is set to Disabled, it will force the XD feature flag to always return to 0.

Virtualization Technology

When this field is set to Enabled, the VMM can utilize the additional hardware capabilities provided by Vanderpool Technology.

Hard Disk Boot Priority

This field is used to select the boot sequence of the hard drives. Move the cursor to this field then press <Enter>. Use the Up or Down arrow keys to select a device then press <+> to move it up or <-> to move it down the list.

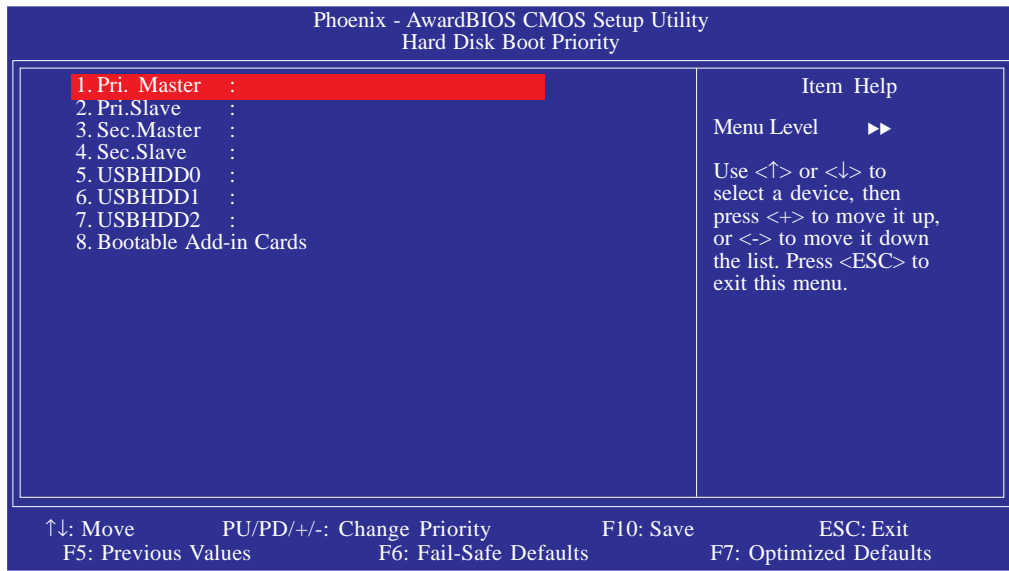

The settings on the screen are for reference only. Your version may not be identical to this one.

Virus Warning

This field protects the boot sector and partition table of your hard disk drive. When this field is enabled, the Award BIOS will monitor the boot sector and partition table of the hard disk drive. If an attempt is made to write to the boot sector or partition table of the hard disk drive, the BIOS will halt the system and an error message will appear:

After seeing the error message, if necessary, you will be able to run an anti-virus program to locate and remove the problem before any damage is done.

Many disk diagnostic programs which attempt to access the boot sector table will cause the warning message to appear. If you are running such a program, we recommend that you first disable this field. Also, disable this field if you are installing or running certain operating systems like Windows® 2000/XP or the operating system may not install nor work.

CPU L1 and L2 Cache

This field is used to speed up the memory access. Enable the external cache for better performance.

CPU L3 Cache

This field is used to enable or disable the CPU's L3 cache.

Quick Power On Self Test

This field speeds up Power On Self Test (POST) after you power on the system. When Enabled, the BIOS will shorten or skip some check items during POST.

First Boot Device, Second Boot Device, Third Boot Device and Boot Other Device

Select the drive to boot first, second and third in the "First Boot Device" "Second Boot Device" and "Third Boot Device" fields respectively. The BIOS will boot the operating system according to the sequence of the drive selected. Set "Boot Other Device" to Enabled if you wish to boot from another device.

Boot Up Floppy Seek

When enabled, the BIOS will check whether the floppy disk drive installed is 40 or 80 tracks. Note that the BIOS cannot distinguish between 720K, 1.2M, 1.44M and 2.88M drive types as they are all 80 tracks. When disabled, the BIOS will not search for the type of floppy disk drive by track number. Note that there will not be any warning message if the drive installed is 360KB.

Boot Up NumLock Status

This allows you to determine the default state of the numeric keypad. By default, the system boots up with NumLock on wherein the function of the numeric keypad is the number keys. When set to Off, the function of the numeric keypad is the arrow keys.

Gate A20 Option

This entry allows you to select how gate A20 is handled. Gate A20 is a device used to address memory above 1 Mbyte. Initially, gate A20 was handled via the keyboard controller. Today, while keyboards still provide this support, it is more common, and much faster, for the system chipset to provide support for gate A20.

Typematic Rate Setting

Disabled Continually holding down a key on your keyboard will cause the BIOS to report that the key is down.

Enabled The BIOS will not only report that the key is down, but will first wait for a moment, and, if the key is still down, it will begin to report that the key has been depressed repeatedly. For example, you would use such a feature to accelerate cursor movements with the arrow keys. You can then select the typematic rate and typematic delay in the “Typematic Rate (Chars/Sec)” and “Typematic Delay (Msec)” fields below.

Typematic Rate (Chars/Sec)

This field allows you to select the rate at which the keys are accelerated.

Typematic Delay (Msec)

This field allows you to select the delay between when the key was first depressed and when the acceleration begins.

Security Option

This field determines when the system will prompt for the password - everytime the system boots or only when you enter the BIOS setup. Set the password in the Set Supervisor/User Password submenu.

System The system will not boot and access to Setup will be denied unless the correct password is entered at the prompt.

Setup The system will boot, but access to Setup will be denied unless the correct password is entered at the prompt.

APIC Mode

Leave this field in its default setting.

MPS Version Control for OS

This field is used to select the MPS version used by the system.

OS Select for DRAM > 64MB

This field allows you to access the memory that is over 64MB in OS/2. The options are: Non-OS2 and OS2.

Report No FDD For WIN 95

The options are Yes and No.

Small Logo(EPA) Show

Enabled The EPA logo will appear during system boot-up.

Disabled The EPA logo will not appear during system boot-up.

Advanced Chipset Features

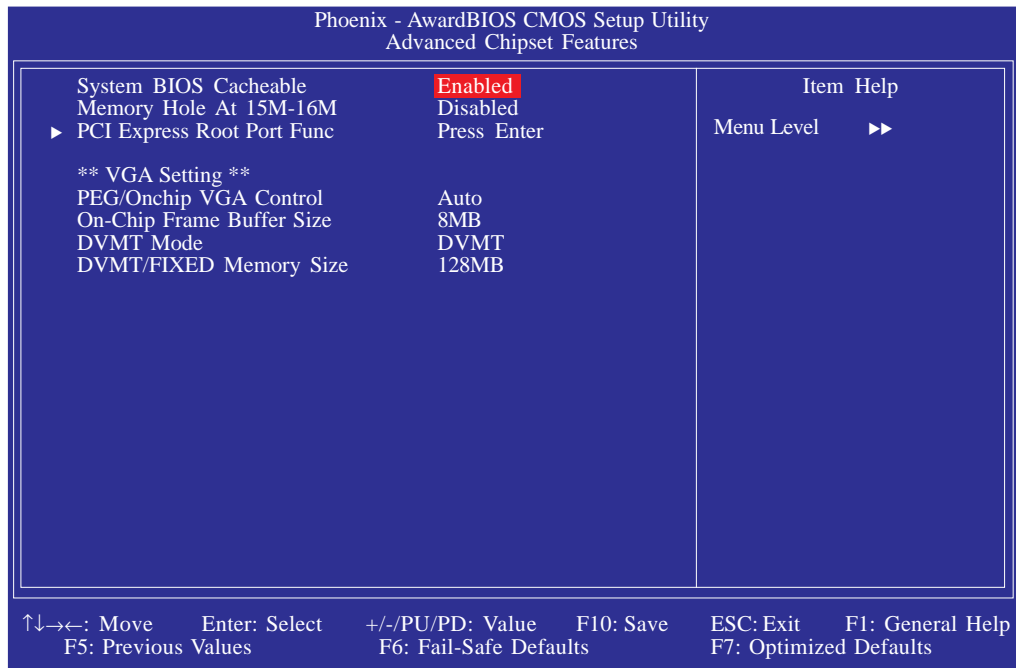

The settings on the screen are for reference only. Your version may not be identical to this one.

This section gives you functions to configure the system based on the specific features of the chipset. The chipset manages bus speeds and access to system memory resources. **These items should not be altered unless necessary.** The default settings have been chosen because they provide the best operating conditions for your system. The only time you might consider making any changes would be if you discovered some incompatibility or that data was being lost while using your system.

System BIOS Cacheable

When this field is enabled, accesses to the system BIOS ROM addressed at F0000H-FFFFFH are cached, provided that the cache controller is enabled. The larger the range of the Cache RAM, the higher the efficiency of the system.

Memory Hole At 15M-16M

In order to improve system performance, certain space in memory can be reserved for ISA cards. This memory must be mapped into the memory space below 16MB. When enabled, the CPU assumes the 15-16MB memory range is allocated to the hidden ISA address range instead of the actual system DRAM. When disabled, the CPU assumes the 15-16MB address range actually contains DRAM memory. If more than 16MB of system memory is installed, this field must be disabled to provide contiguous system memory.

PCI Express Root Port Func

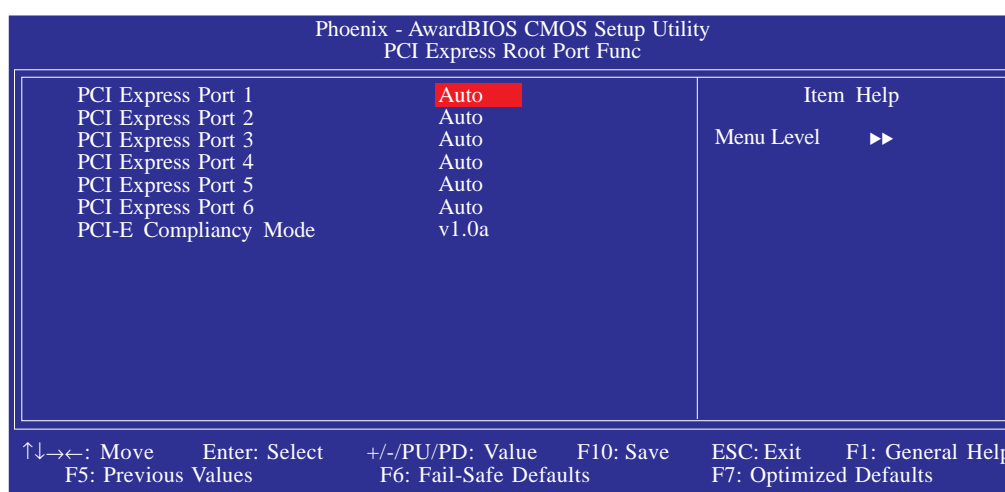

The settings on the screen are for reference only. Your version may not be identical to this one.

PCI Express Port 1 to PCI Express Port 6

These fields are used to enable or disable the PCI Express port function.

PCI-E Compliancy Mode

This field is used to select the mode for the PCI Express add-in card.

PEG/Onchip VGA Control

This field is used to select the graphics controller that will serve as the primary boot device.

On-Chip Frame Buffer Size

This field is used to select the onboard VGA's frame buffer size that is shared from the system memory.

DVMT Mode

This field shows the current DVMT mode.

DVMT/FIXED Memory Size

This field is used to select the graphics memory size used by DVMT/Fixed mode.

Integrated Peripherals

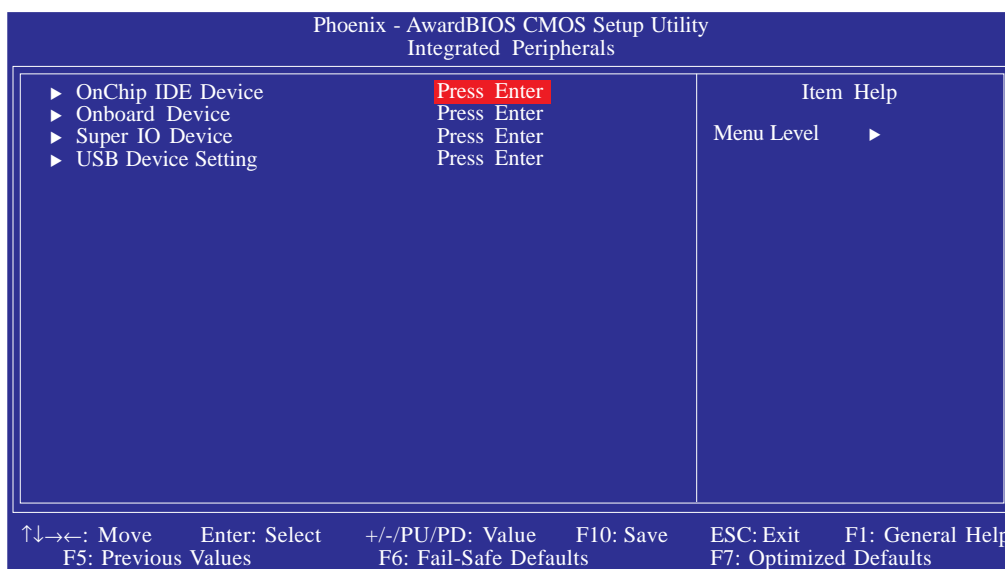

The settings on the screen are for reference only. Your version may not be identical to this one.

OnChip IDE Device

Move the cursor to this field and press <Enter>. The following screen will appear:

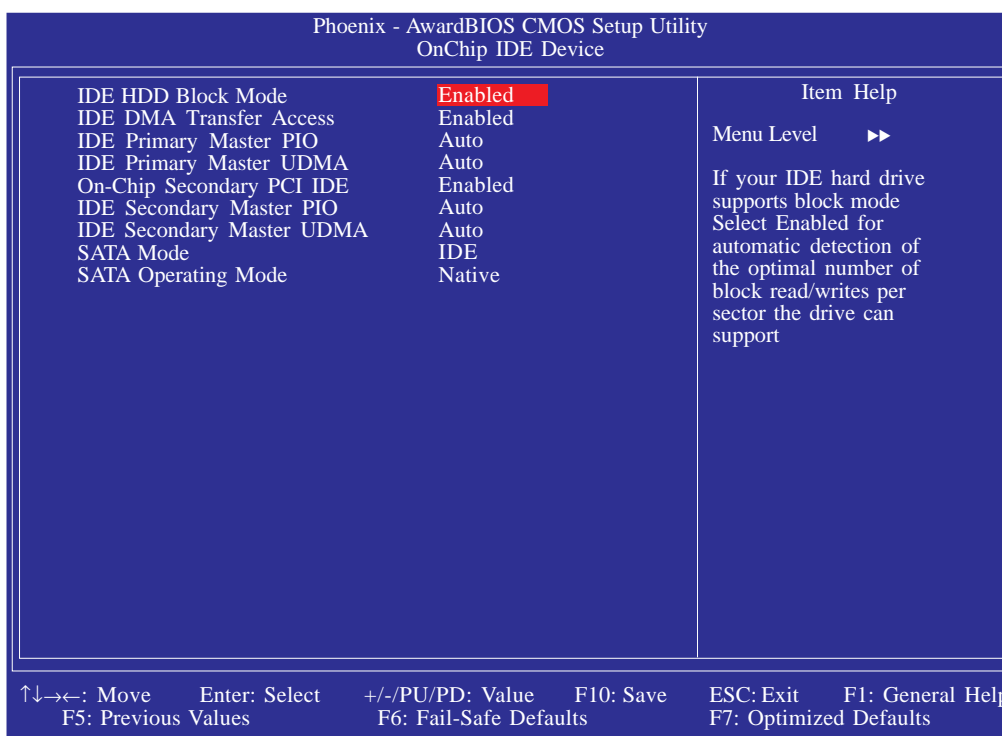

The settings on the screen are for reference only. Your version may not be identical to this one.

IDE HDD Block Mode

Enabled The IDE HDD uses the block mode. The system BIOS will check the hard disk drive for the maximum block size the system can transfer. The block size will depend on the type of hard disk drive.

Disabled The IDE HDD uses the standard mode.

IDE DMA Transfer Access

This field is used to enable or disable the DMA transfer function of an IDE hard drive.

IDE Primary Master PIO and IDE Secondary Master PIO

PIO means Programmed Input/Output. Rather than have the BIOS issue a series of commands to effect a transfer to or from the disk drive, PIO allows the BIOS to tell the controller what it wants and then let the controller and the CPU perform the complete task by themselves. Your system supports five modes, 0 (default) to 4, which primarily differ in timing. When Auto is selected, the BIOS will select the best available mode after checking your drive.

Auto The BIOS will automatically set the system according to your hard disk drive's timing.

Mode 0-4 You can select a mode that matches your hard disk drive's timing. Caution: Do not use the wrong setting or you will have drive errors.

IDE Primary Master UDMA and IDE Secondary Master UDMA

These fields allow you to set the Ultra DMA in use. When Auto is selected, the BIOS will select the best available option after checking your hard drive or CD-ROM.

- | | |
|-----------------|--|
| <i>Auto</i> | The BIOS will automatically detect the settings for you. |
| <i>Disabled</i> | The BIOS will not detect these categories. |

On-Chip Secondary PCI IDE

This field is used to enable or disable the secondary PCI IDE.

SATA Mode

- | | |
|-------------|--|
| <i>IDE</i> | This option configures the Serial ATA drives in IDE mode. |
| <i>RAID</i> | This option enables the RAID function for Serial ATA drives. |
| <i>AHCI</i> | This option configures the Serial ATA drives in AHCI mode. |

SATA Operating Mode

The options are Native and Compatibility.

Onboard Device

Move the cursor to this field and press <Enter>. The following screen will appear:

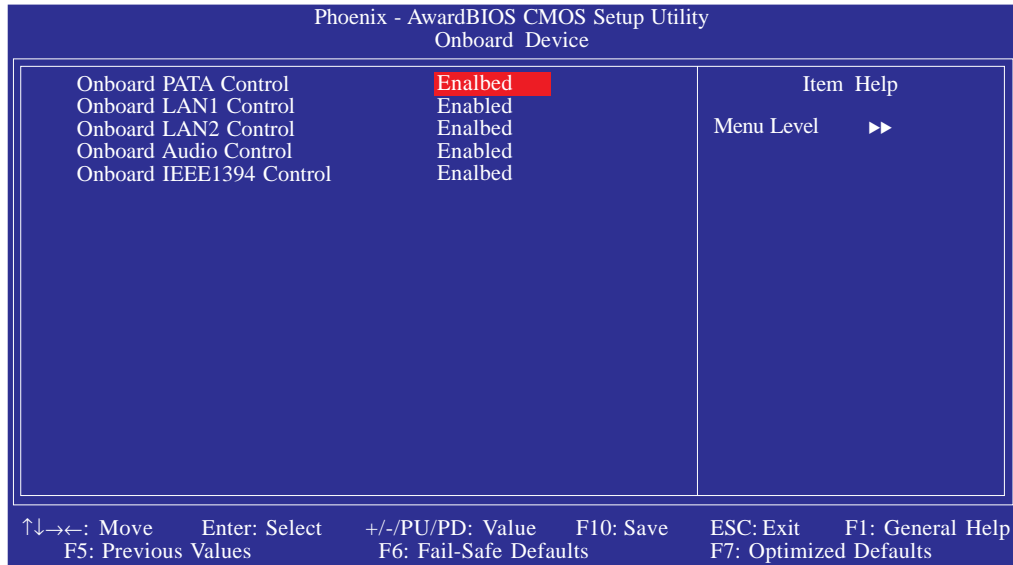

The settings on the screen are for reference only. Your version may not be identical to this one.

Onboard PATA Control

This field is used to enable or disable the onboard Parallel ATA.

Onboard LAN 1 Control

This field is used to enable or disable the onboard LAN 1.

Onboard LAN 2 Control

This field is used to enable or disable the onboard LAN 2.

Onboard Audio Control

This field is used to enable or disable the onboard audio.

Onboard IEEE 1394 Control

This field is used to enable or disable the onboard IEEE 1394.

Super IO Device

Move the cursor to this field and press <Enter>. The following screen will appear:

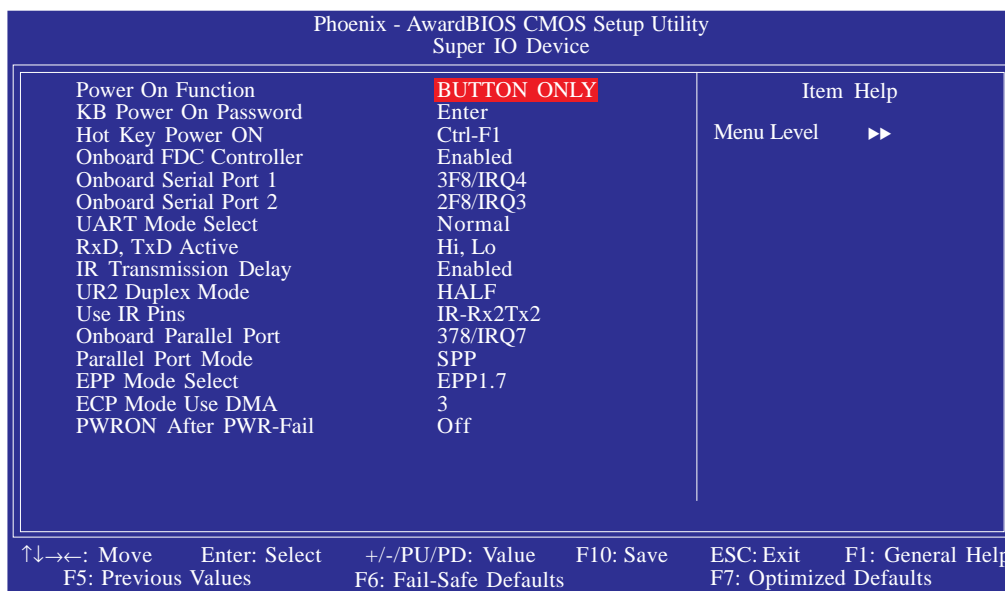

The settings on the screen are for reference only. Your version may not be identical to this one.

Power On Function

This field allows you to use the PS/2 keyboard or PS/2 mouse to power-on the system.

- Button only* Default setting. Uses the power button to power on the system.
- Password* When this option is selected, set the password you would like to use to power-on the system in the “KB Power On Password” field.
- Hot Key* When this option is selected, select the function key you would like to use to power-on the system in the “Hot Key Power On” field.
- Mouse Left* When this option is selected, double-click the left button of the mouse to power-on the system.
- Mouse Right* When this option is selected, double-click the right button of the mouse to power-on the system.
- Any Key* Press any key to power-on the system.
- Keyboard 98* When this option is selected, press the “wake up” key of the Windows® 98 compatible keyboard to power-on the system.

KB Power On Password

Move the cursor to this field and press <Enter>. Enter your password. You can enter up to 5 characters. Type in exactly the same password to confirm, then press <Enter>.

The power button will not function once a keyboard password has been set in this field. You must type the correct password to power-on the system. If you forgot the password, power-off the system and remove the battery. Wait for a few seconds and install it back before powering-on the system.

Hot Key Power On

This field is used to select a function key that you would like to use to power-on the system.

Onboard FDC Controller

- Enabled* Enables the onboard floppy disk controller.
- Disabled* Disables the onboard floppy disk controller.

Onboard Serial Port 1 and Onboard Serial Port 2

- Auto* The system will automatically select an I/O address for the onboard serial port 1 and serial port 2.
- 3F8/IRQ4, 2F8/IRQ3, 3E8/IRQ4, 2E8/IRQ3* Allows you to manually select an I/O address for the onboard serial port 1 and serial port 2.
- Disabled* Disables the onboard serial port 1 and/or serial port 2.

UART Mode Select

This field is used to select the type of IrDA standard supported by your IrDA device. For better transmission of data, your IrDA peripheral device must be within a 30° angle and within a distance of 1 meter.

RxD, TxD Active

The options are Hi, Lo; Lo, Hi; Lo, Lo; and Hi, Hi.

IR Transmission Delay

If this field is Enabled, transmission of data will be slower. This is recommended when you encounter transmission problem with your device. The options are: Enabled and Disabled.

UR2 Duplex Mode

<i>Half</i>	Data is completely transmitted before receiving data.
<i>Full</i>	Transmits and receives data simultaneously.

Use IR Pins

The options are IR-Rx2Tx2 and RxD2TxD2.

Onboard Parallel Port

<i>378//IRQ7, 3BC//IRQ7, 278//IRQ5</i>	Selects the I/O address and IRQ of the onboard parallel port.
<i>Disabled</i>	Disables the onboard parallel port.

Parallel Port Mode

The options are SPP, EPP, ECP and ECP+EPP. These apply to a standard specification and will depend on the type and speed of your device. Refer to your peripheral's manual for the best option.

SPP

Allows normal speed operation but in one direction only.

“ECP (Extended Capabilities Port)”

Allows parallel port to operate in bidirectional mode and at a speed faster than the normal mode's data transfer rate.

“EPP (Enhanced Parallel Port)”

Allows bidirectional parallel port operation at maximum speed.

EPP Mode Select

This field is used to select the EPP mode.

ECP Mode Use DMA

This field is used to select the parallel port's DMA channel.

PWRON After PWR-Fail

<i>Off</i>	When power returns after an AC power failure, the system's power is off. You must press the Power button to power-on the system.
<i>On</i>	When power returns after an AC power failure, the system will automatically power-on.
<i>Former-Sts</i>	When power returns after an AC power failure, the system will return to the state where you left off before power failure occurs. If the system's power is off when AC power failure occurs, it will remain off when power returns. If the system's power is on when AC power failure occurs, the system will power-on when power returns.

USB Device Setting

Move the cursor to this field and press <Enter>. The following screen will appear:

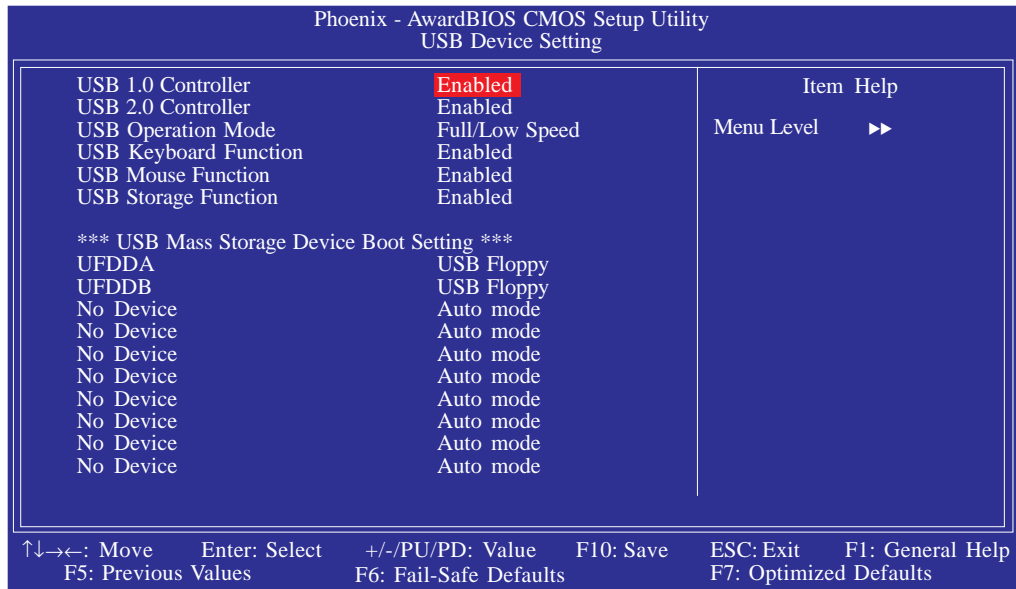

The settings on the screen are for reference only. Your version may not be identical to this one.

USB 1.0 Controller

This field is used to enable or disable the Universal Host Controller Interface (USB 1.0).

USB 2.0 Controller

This field is used to enable or disable the Enhanced Host Controller Interface (USB 2.0).

USB Operation Mode

This field is used to select the USB's operation mode. The options are Full/Low Speed and High Speed.

USB Keyboard Function

Due to the limited space of the BIOS ROM, the support for legacy USB keyboard (in DOS mode) is by default set to Disabled. With more BIOS ROM space available, it will be able to support more advanced features as well as provide compatibility to a wide variety of peripheral devices.

If a PS/2 keyboard is not available and you need to use a USB keyboard to install Windows (installation is performed in DOS mode) or run any program under DOS, set this field to Enabled.

USB Mouse Function

Due to the limited space of the BIOS ROM, the support for legacy USB mouse (in DOS mode) is by default set to Disabled. With more BIOS ROM space available, it will be able to support more advanced features as well as provide compatibility to a wide variety of peripheral devices.

If a PS/2 mouse is not available and you need to use a USB mouse to install Windows (installation is performed in DOS mode) or run any program under DOS, set this field to Enabled.

USB Storage Function

This field is used to enable or disable the support for legacy USB mass storage.

USB Mass Storage Device Boot Setting

<i>Auto Mode</i>	The system will automatically boot according to the type detected by USB MSD.
<i>FDD Mode</i>	USB MSD will boot as a floppy disk drive.
<i>HDD Mode</i>	USB MSD will boot as a hard disk drive.

Power Management Setup

The Power Management Setup allows you to configure your system to most effectively save energy.

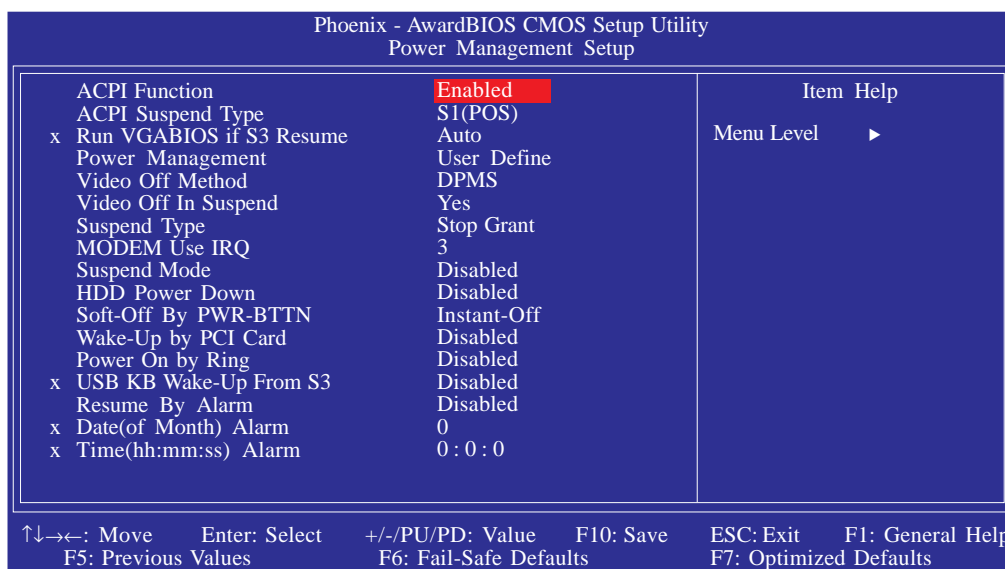

The settings on the screen are for reference only. Your version may not be identical to this one.

ACPI Function

This function should be enabled only in operating systems that support ACPI. Currently, only Windows® 98/2000/ME/XP supports this function. If you want to use the Suspend to RAM function, make sure this field is enabled then select “S3(STR)” in the “ACPI Suspend Type” field.

ACPI Suspend Type

This field is used to select the type of Suspend mode.

- S1(POS) Enables the Power On Suspend function.
- S3(STR) Enables the Suspend to RAM function.

Run VGABIOS if S3 Resume

When this field is set to Auto, the system will initialize the VGA BIOS when it wakes up from the S3 state. This can be configured only if the “ACPI Suspend Type” field is set to “S3(STR)”.

Power Management

This field allows you to select the type (or degree) of power saving by changing the length of idle time that elapses before the “Suspend Mode” field is activated.

<i>Min Saving</i>	Minimum power saving time for Suspend mode = 1 hr.
<i>Max Saving</i>	Maximum power saving time for Suspend mode = 1 min.
<i>User Define</i>	Allows you to set the power saving time in the “Suspend Mode” field.

Video Off Method

This determines the manner in which the monitor is blanked.

<i>V/H SYNC + Blank</i>	This will cause the system to turn off the vertical and horizontal synchronization ports and write blanks to the video buffer.
<i>Blank Screen</i>	This only writes blanks to the video buffer.
<i>DPMS Support</i>	Initializes display power management signaling. Select this if your video board supports it.

Video Off In Suspend

This field is used to activate the video off feature when the system enters the Suspend mode.

Suspend Type

The options are Stop Grant and PwrOn Suspend.

MODEM Use IRQ

This field is used to set an IRQ channel for the modem installed in your system.

Suspend Mode

When the system enters the Suspend mode, the CPU and onboard peripherals will be shut off.

HDD Power Down

This is selectable only when the Power Management field is set to User Define. When the system enters the HDD Power Down mode according to the power saving time selected, the hard disk drive will be powered down while all other devices remain active.

Soft-Off by PWR-BTTN

This field allows you to select the method of powering off your system.

Delay 4 Sec. Regardless of whether the Power Management function is enabled or disabled, if the power button is pushed and released in less than 4 sec, the system enters the Suspend mode. The purpose of this function is to prevent the system from powering off in case you accidentally “hit” or pushed the power button. Push and release again in less than 4 sec to restore. Pushing the power button for more than 4 seconds will power off the system.

Instant-Off Pressing and then releasing the power button at once will immediately power off your system.

Wake-Up By PCI Card

Enabled This field should be set to Enabled only if your PCI card such as LAN card or modem card uses the PCI PME (Power Management Event) signal to remotely wake up the system. Access to the LAN card or PCI card will cause the system to wake up. Refer to the card’s documentation for more information.

Disabled The system will not wake up despite access to the PCI card.

Power On By Ring

When this field is set to Enabled, the system will power-on to respond to calls coming from a modem.

USB KB Wake-Up From S3

This field, when enabled, allows you to use a USB keyboard or USB mouse to wake up a system that is in the S3 (STR - Suspend To RAM) state. This can be configured only if the “ACPI Suspend Type” field is set to “S3(STR)”.

Resume By Alarm

Enabled When Enabled, you can set the date and time you would like the Soft Power Down (Soft-Off) PC to power-on in the “Date (of Month) Alarm” and “Time (hh:mm:ss) Alarm” fields. However, if the system is being accessed by incoming calls or the network (Resume On Ring/LAN) prior to the date and time set in these fields, the system will give priority to the incoming calls or network.

Disabled Disables the automatic power-on function. (default)

Date (of Month) Alarm

0 The system will power-on everyday according to the time set in the “Time (hh:mm:ss) Alarm” field.

1-31 Select a date you would like the system to power-on. The system will power-on on the set date, and time set in the “Time (hh:mm:ss) Alarm” field.

Time (hh:mm:ss) Alarm

This is used to set the time you would like the system to power-on. If you want the system to power-on everyday as set in the “Date (of Month) Alarm” field, the time set in this field must be later than the time of the RTC set in the Standard CMOS Features submenu.

PnP/PCI Configurations

This section shows how to configure the PCI bus system. It covers some very technical items and it is strongly recommended that only experienced users should make any changes to the default settings.

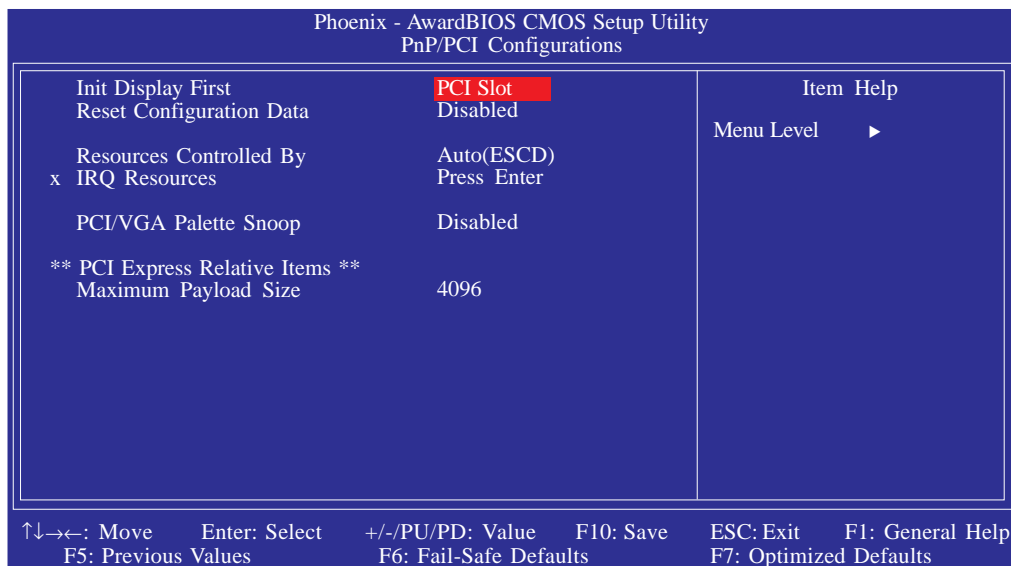

The settings on the screen are for reference only. Your version may not be identical to this one.

Init Display First

<i>PCIEx</i>	When the system boots, it will first initialize PCI Express.
<i>Onboard</i>	When the system boots, it will first initialize the onboard VGA.
<i>PCI Slot</i>	When the system boots, it will first initialize PCI.

Reset Configuration Data

<i>Enabled</i>	The BIOS will reset the Extended System Configuration Data (ESCD) once automatically. It will then recreate a new set of configuration data.
<i>Disabled</i>	The BIOS will not reset the configuration data.

Resources Controlled By

The Award Plug and Play BIOS has the capability to automatically configure all of the boot and Plug and Play compatible devices.

- Auto* The system will automatically detect the settings for you.
- Manual* Choose the specific IRQ and DMA in the “IRQ Resources” and “DMA Resources” field respectively.

IRQ Resources

Move the cursor to this field and press <Enter>. Set each system interrupt to either PCI/ISA PnP or Legacy ISA.

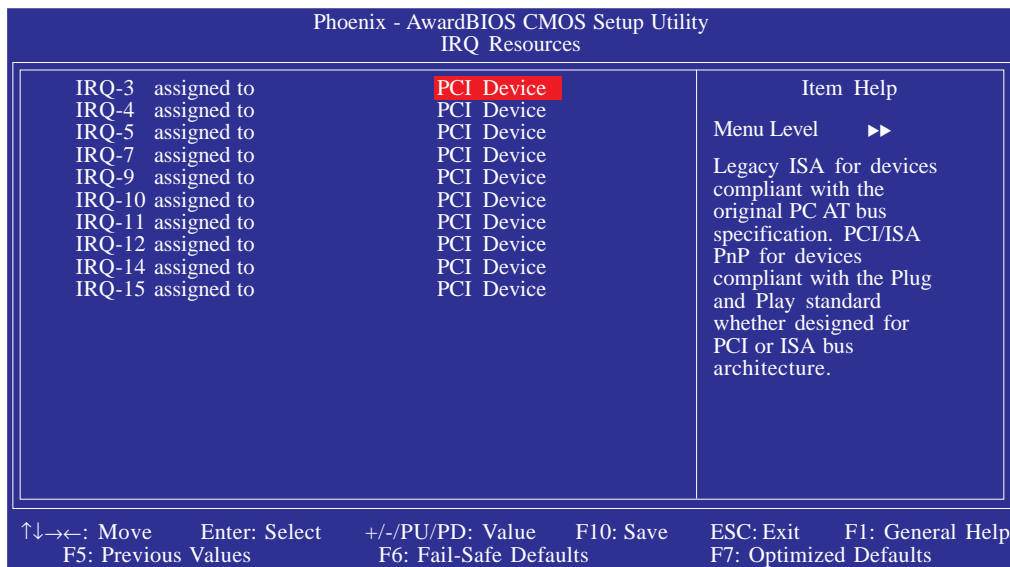

The settings on the screen are for reference only. Your version may not be identical to this one.

PCI/VGA Palette Snoop

This field determines whether the MPEG ISA/VESA VGA cards can work with PCI/VGA or not. The default value is Disabled.

- Enabled* MPEG ISA/VESA VGA cards work with PCI/VGA.
- Disabled* MPEG ISA/VESA VGA cards does not work with PCI/VGA.

Maximum Payload Size

This field is used to select the maximum TLP payload size of the PCI Express devices. The unit is byte.

PC Health Status

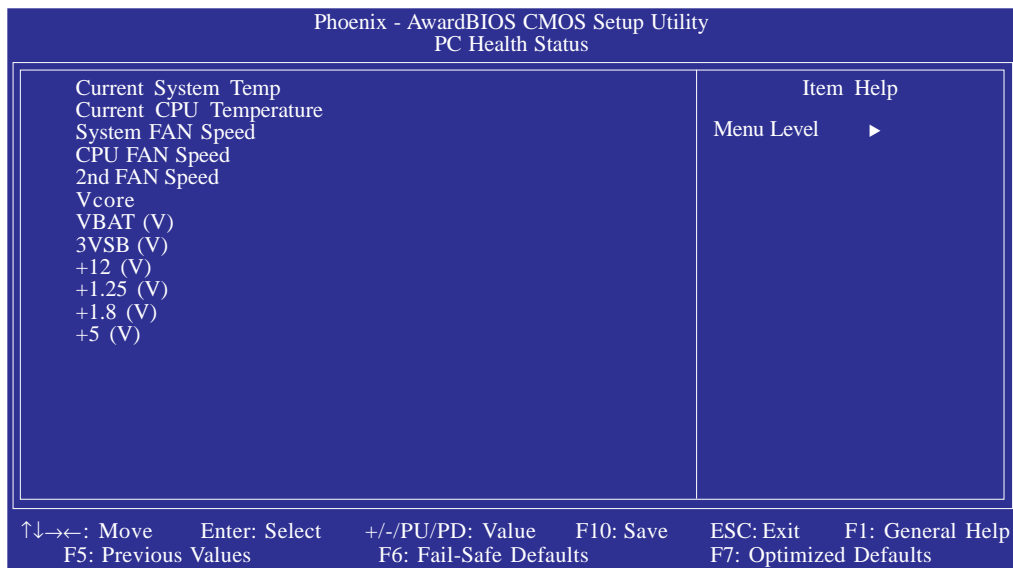

The settings on the screen are for reference only. Your version may not be identical to this one.

Current System Temp, Current CPU Temperature, System Fan Speed, CPU Fan Speed and 2nd Fan Speed

These fields will show the internal temperature of the system, current temperature of the CPU, and the current fan speed of the cooling fans in RPM (Revolutions Per Minute).

Vcore

This field will show the detected voltage of the processor.

VBAT(V) to +5 (V)

These fields will show the output voltage of the power supply.

Frequency/Voltage Control

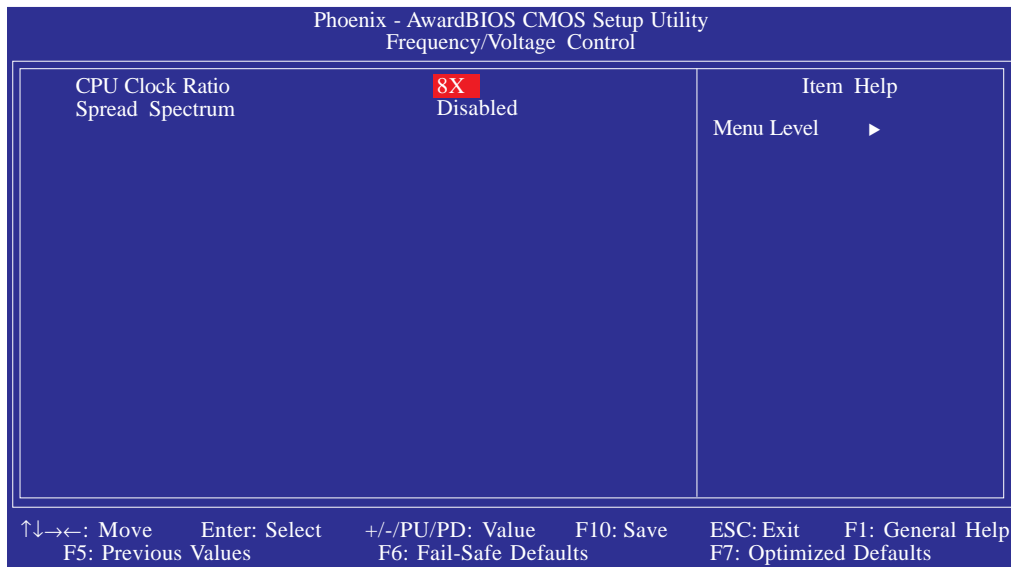

The settings on the screen are for reference only. Your version may not be identical to this one.

CPU Clock Ratio

This field is used to select the CPU's frequency ratio.

Spread Spectrum

Leave this field in its default setting. Do not alter this setting unless advised by an engineer or technician.

Load Fail-Safe Defaults

The “Load Fail-Safe Defaults” option loads the troubleshooting default values permanently stored in the ROM chips. These settings are not optimal and turn off all high performance features. You should use these values only if you have hardware problems. Highlight this option in the main menu and press <Enter>.

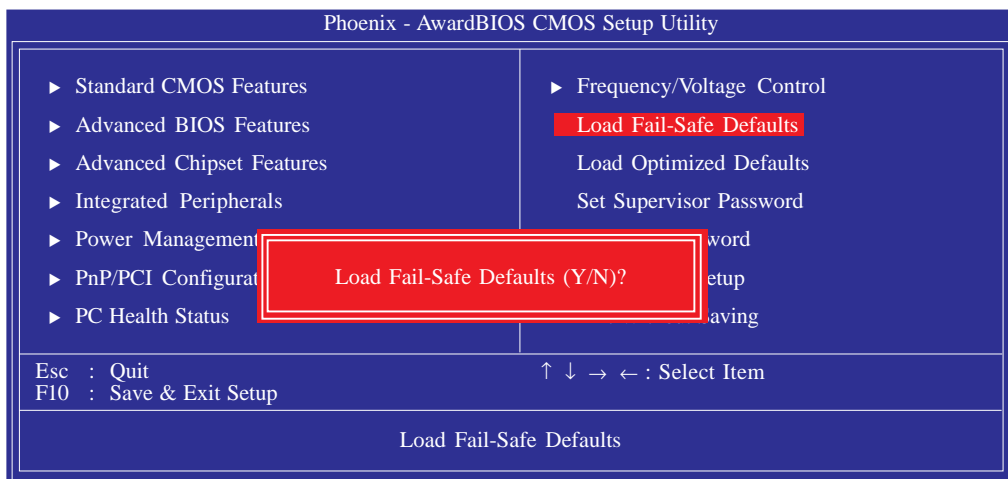

If you want to proceed, type <Y> and press <Enter>. The default settings will be loaded.

Load Optimized Defaults

The “Load Optimized Defaults” option loads optimized settings from the BIOS ROM. Use the default values as standard values for your system. Highlight this option in the main menu and press <Enter>.

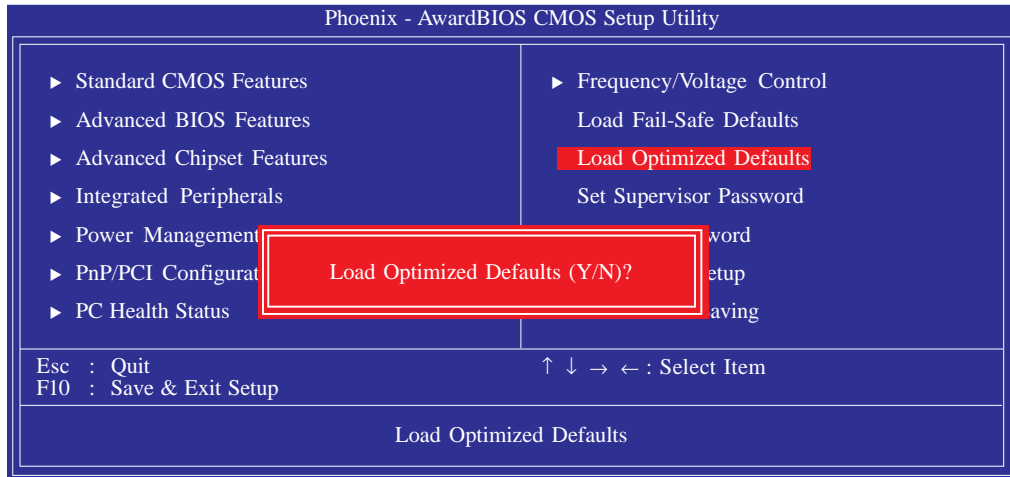

Type <Y> and press <Enter> to load the Setup default values.

Set Supervisor Password

If you want to protect your system and setup from unauthorized entry, set a supervisor's password with the "System" option selected in the Advanced BIOS Features. If you want to protect access to setup only, but not your system, set a supervisor's password with the "Setup" option selected in the Advanced BIOS Features. You will not be prompted for a password when you cold boot the system.

Use the arrow keys to highlight "Set Supervisor Password" and press <Enter>.

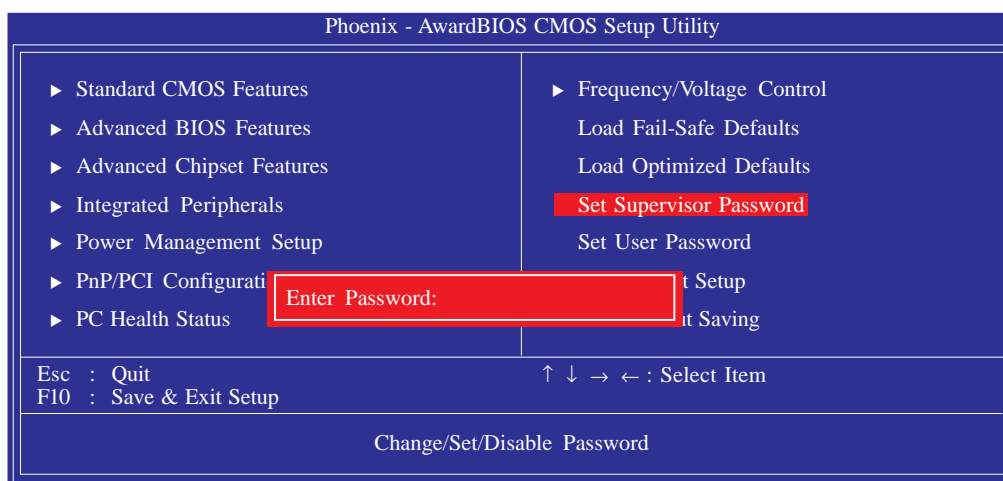

Type in the password. You are limited to eight characters. When done, the message below will appear:

Confirm Password:

You are asked to verify the password. Type in exactly the same password. If you type in a wrong password, you will be prompted to enter the correct password again. To delete or disable the password function, highlight "Set Supervisor Password" and press <Enter>, instead of typing in a new password. Press the <Esc> key to return to the main menu.

Set User Password

If you want another user to have access only to your system but not to setup, set a user's password with the "System" option selected in the Advanced BIOS Features. If you want a user to enter a password when trying to access setup, set a user's password with the "Setup" option selected in the Advanced BIOS Features.

Using user's password to enter Setup allows a user to access only "Set User Password" that appears in the main menu screen. Access to all other options is denied.

Use the arrow keys to highlight "Set User Password" and press <Enter>.

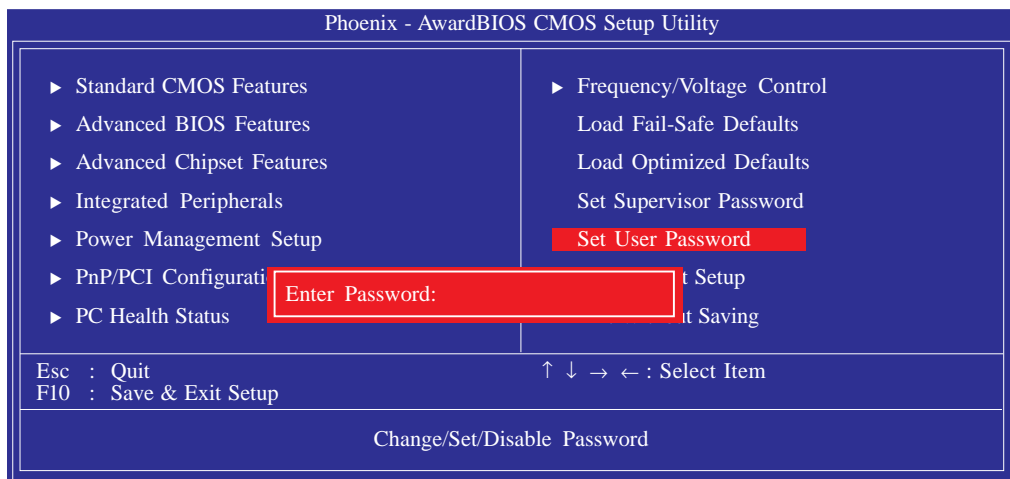

Type in the password. You are limited to eight characters. When done, the message below will appear:

Confirm Password:

You are asked to verify the password. Type in exactly the same password. If you type in a wrong password, you will be prompted to enter the correct password again. To delete or disable the password function, highlight "Set User Password" and press <Enter>, instead of typing in a new password. Press the <Esc> key to return to the main menu.

Save & Exit Setup

When all the changes have been made, highlight “Save & Exit Setup” and press <Enter>.

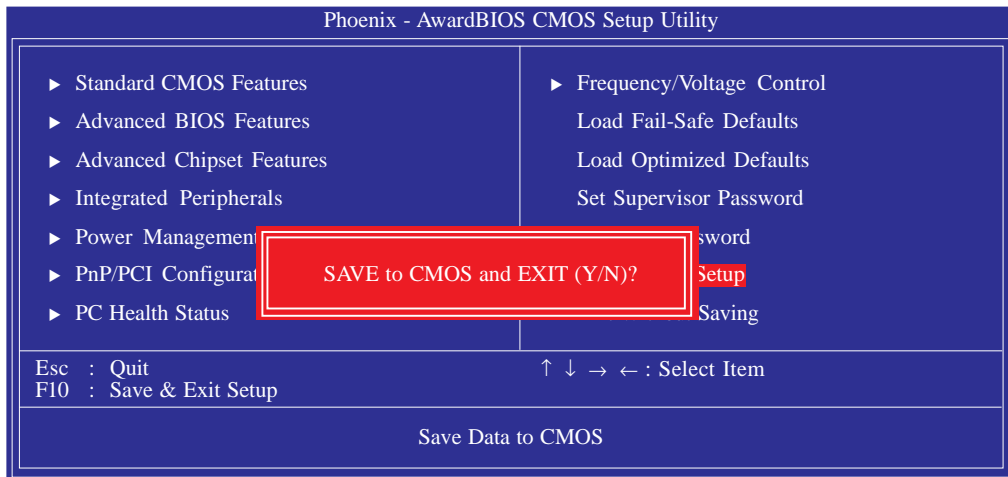

Type “Y” and press <Enter>. The modifications you have made will be written into the CMOS memory, and the system will reboot. You will once again see the initial diagnostics on the screen. If you wish to make additional changes to the setup, press <Ctrl> <Alt> <Esc> simultaneously or after memory testing is done.

Exit Without Saving

When you do not want to save the changes you have made, highlight “Exit Without Saving” and press <Enter>.

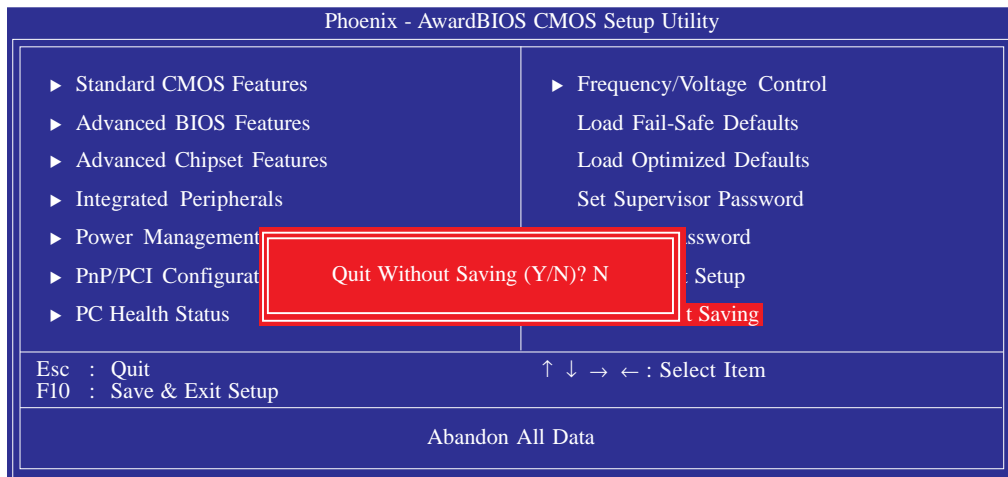

Type “Y” and press <Enter>. The system will reboot and you will once again see the initial diagnostics on the screen. If you wish to make any changes to the setup, press <Ctrl> <Alt> <Esc> simultaneously or after memory testing is done.

Intel RAID BIOS

The Intel ICH8DO chip allows configuring RAID on Serial ATA drives. It supports RAID 0, RAID 1, RAID 5 and RAID 10.

When the system powers-up and all drives have been detected, the Intel BIOS status message screen will appear. Press the <Ctrl> and <I> keys simultaneously to enter the utility. The utility allows you to build a RAID system on Serial ATA drives.



Important:

Before creating RAID, make sure you have installed the Serial ATA drives and connected the data cables otherwise you won't be able to enter the RAID BIOS utility.

Refer to chapter 5 for steps in configuring RAID.

Updating the BIOS

To update the BIOS, you will need the new BIOS file and a flash utility, AWDFLASH.EXE. Please contact technical support or your sales representative for the files.

1. Save the new BIOS file along with the flash utility AWDFLASH.EXE to a floppy disk.
2. Reboot the system and enter the Award BIOS Setup Utility to set the first boot drive to “Floppy”.
3. Save the setting and reboot the system.
4. After the system booted from the floppy disk, execute the flash utility by typing AWDFLASH.EXE. The following screen will appear:

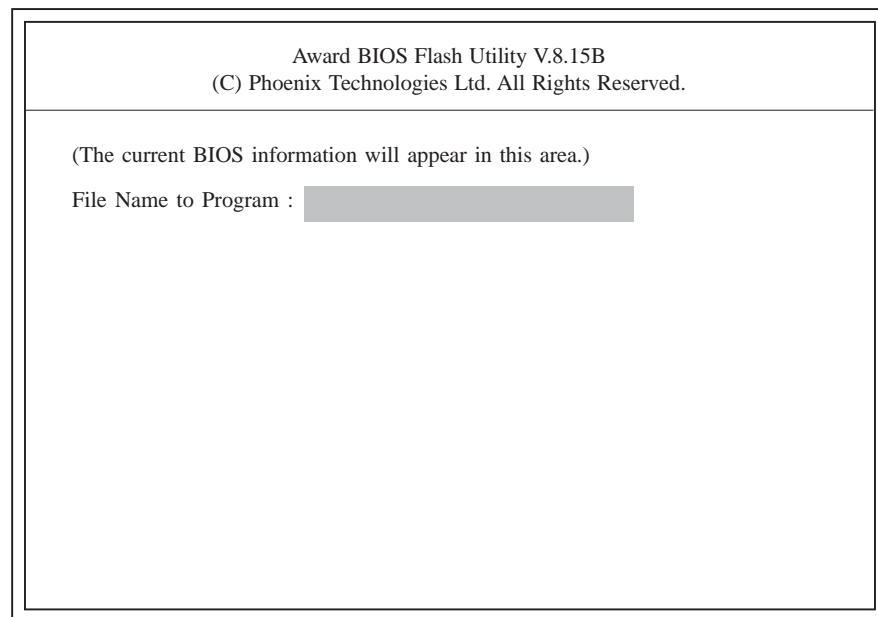

5. Type the new BIOS file name onto the gray area that is next to “File Name to Program” then press <Enter>.

6. The following will appear:

Do You Want to Save BIOS (Y/N)

This question refers to the current existing BIOS in your system. We recommend that you save the current BIOS and its flash utility; just in case you need to reinstall the BIOS. To save the current BIOS, press <Y> then enter the file name of the current BIOS. Otherwise, press <N>.

7. The following will then appear:

Press "Y" to Program or "N" to Exit

8. Press <Y> to flash the new BIOS.

Chapter 4 - Supported Software

Drivers, Utilities and Software Applications

The CD that came with the system board contains drivers, utilities and software applications required to enhance the performance of the system board.

Insert the CD into a CD-ROM drive. The autorun screen (Mainboard Utility CD) will appear. If after inserting the CD, "Autorun" did not automatically start (which is, the Mainboard Utility CD screen did not appear), please go directly to the root directory of the CD and double-click "Setup".



Intel Chipset Software Installation Utility

The Intel Chipset Software Installation Utility is used for updating Windows® INF files so that the Intel chipset can be recognized and configured properly in the system.

To install the utility, click “Intel Chipset Software Installation Utility” on the main menu.

1. The installation wizard will extract the files needed to install the utility. After all files have been extracted, click Next.

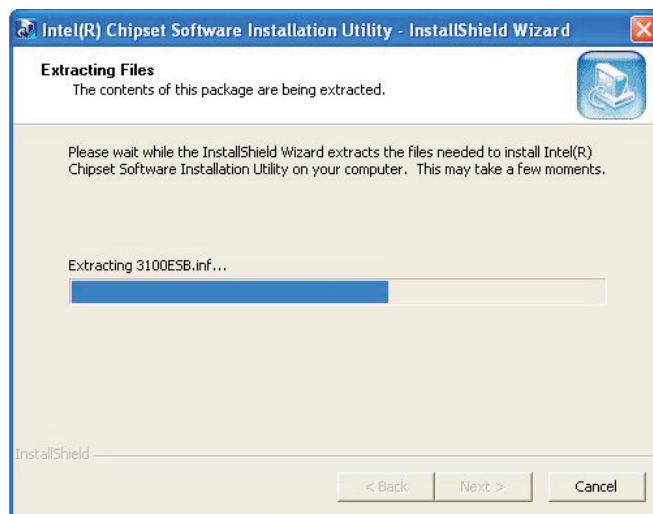

2. Setup is now ready to install the utility. Click Next.

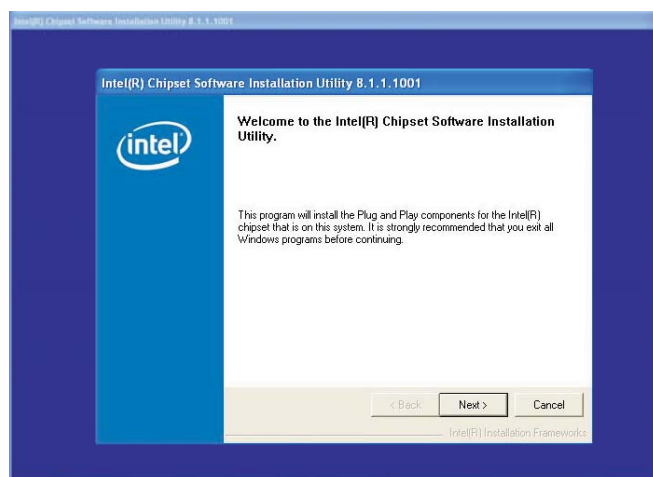

3. Read the license agreement then click Yes.

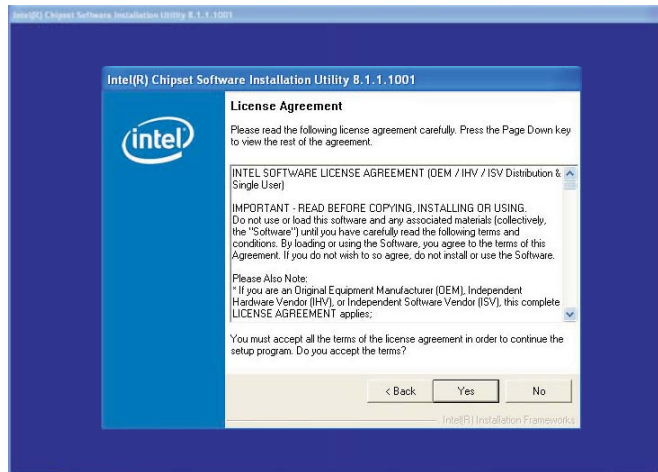

4. Go through the readme document for more installation tips then click Next.

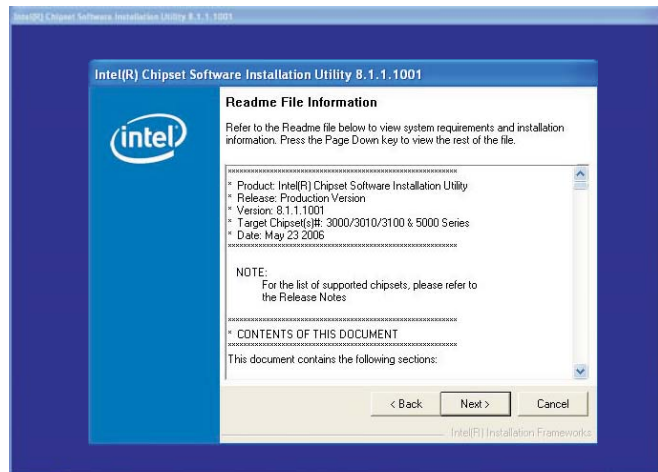

5. Click Finish to exit setup.

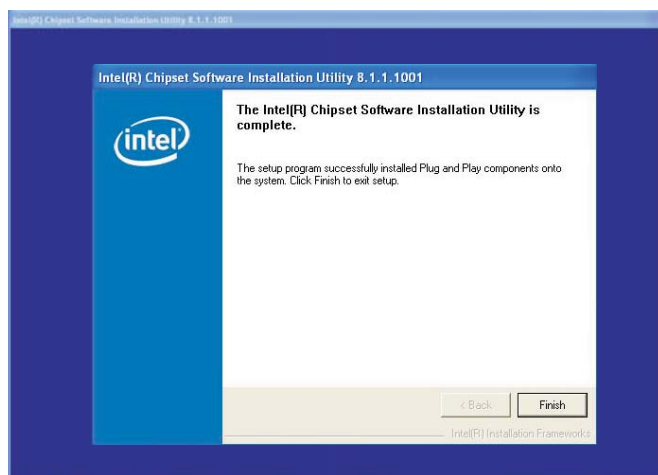

Intel Graphics Drivers

To install the driver, click “Intel Graphics Drivers” on the main menu.

1. Setup is now ready to install the graphics driver. Click Next.

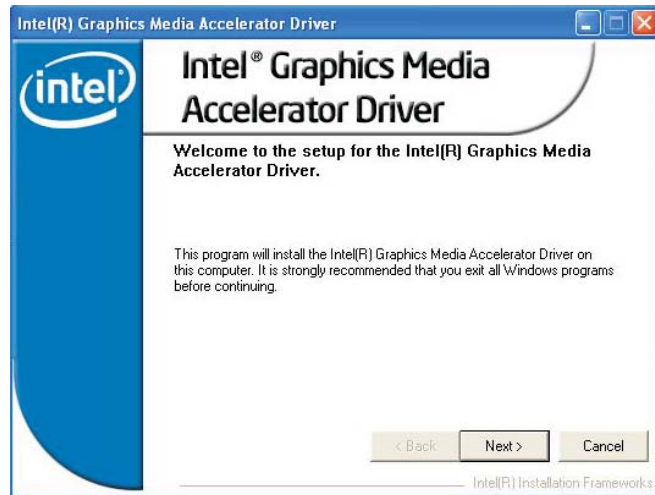

2. Read the license agreement then click Yes.

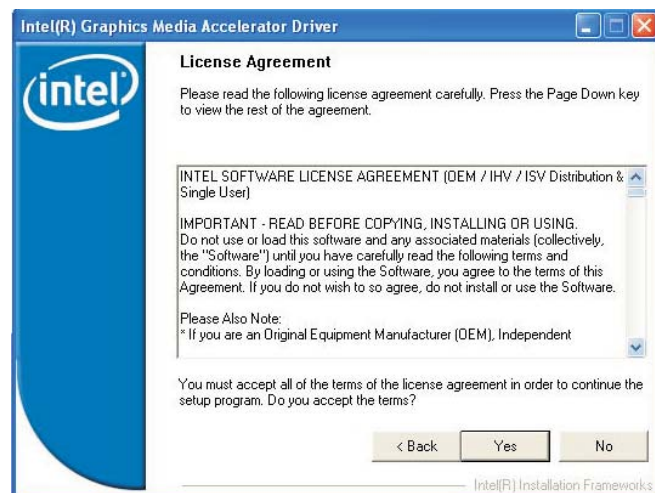

3. Go through the readme document for more installation tips then click Next.

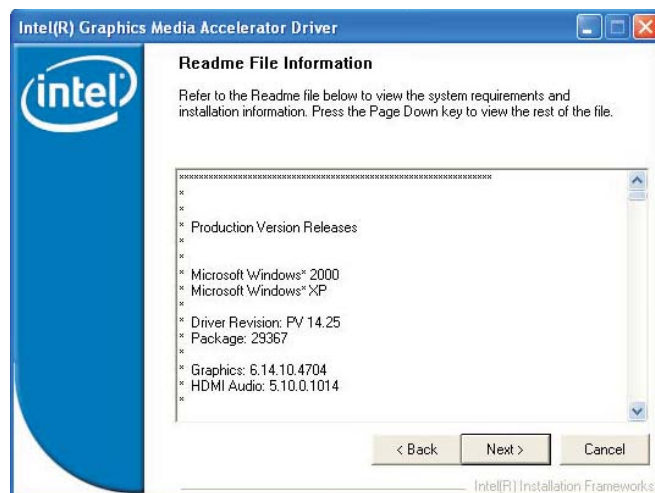

4. Setup is currently installing the driver.

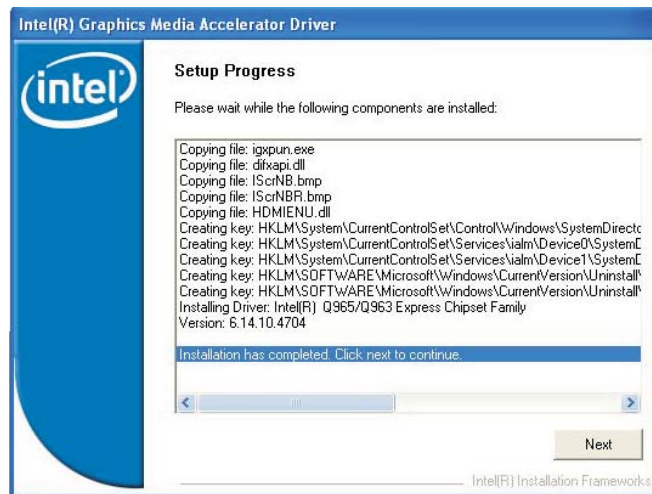

5. Click "Yes, I want to restart this computer now." then click Finish.

Restarting the system will allow the new software installation to take effect.

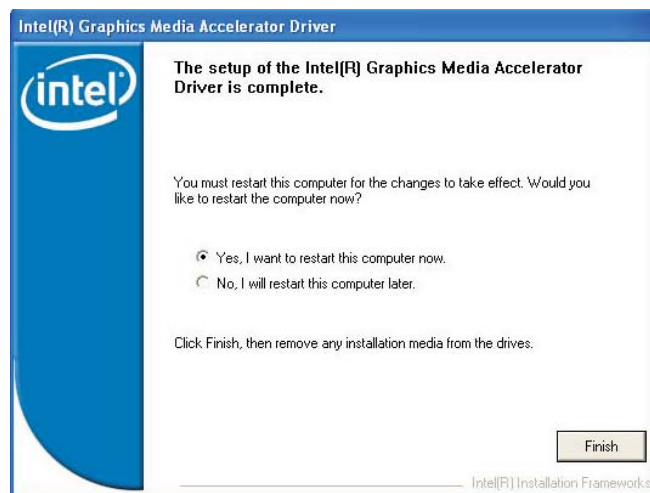

Audio Drivers

To install the driver, click “Audio Drivers” on the main menu.

1. Setup is now ready to install the driver. Click Next.



2. The installation wizard will extract the files needed to install AC97 audio. After all files have been extracted, click Next.



3. Setup is currently updating the system.

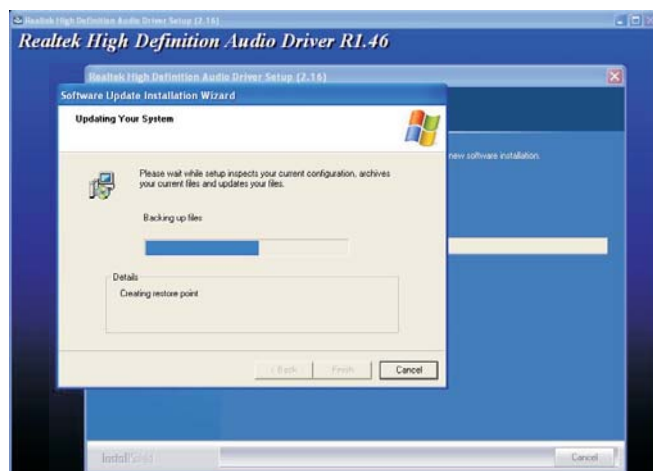

4. Select the appropriate option then click Next.



5. Follow the prompts on the screen to complete installation.
6. Click “Yes, I want to restart my computer now” then click Finish.

Restarting the system will allow the new software installation to take effect.



Intel LAN Drivers

To install the driver, click “Intel LAN Drivers” on the main menu.

1. The installation menu will appear. Click View Release Notes for more information about the driver or click Install Drivers to begin the installation.

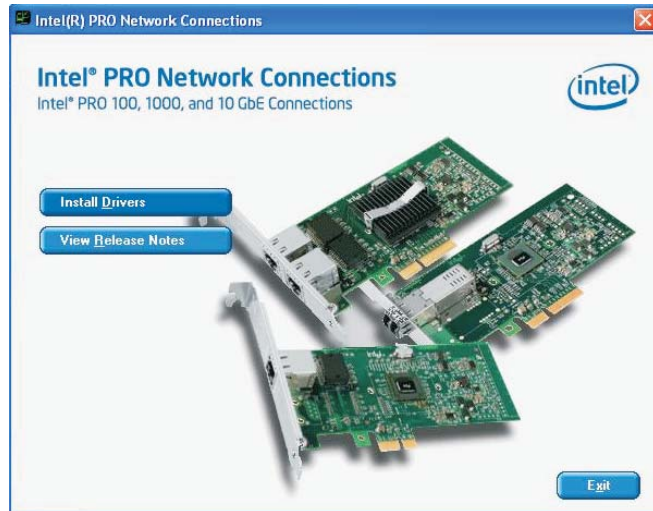

2. You are now ready to install the driver. Click Next.



3. Read the license agreement then click “I accept the terms in the license agreement”. Click Next.

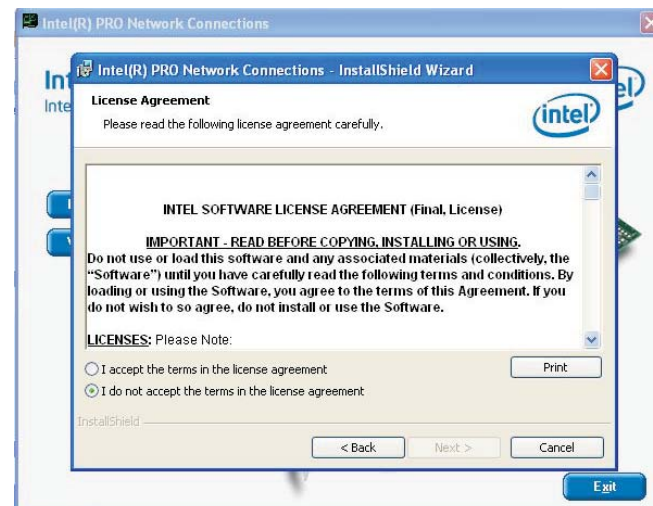

4. Select the type of setup then click Next.

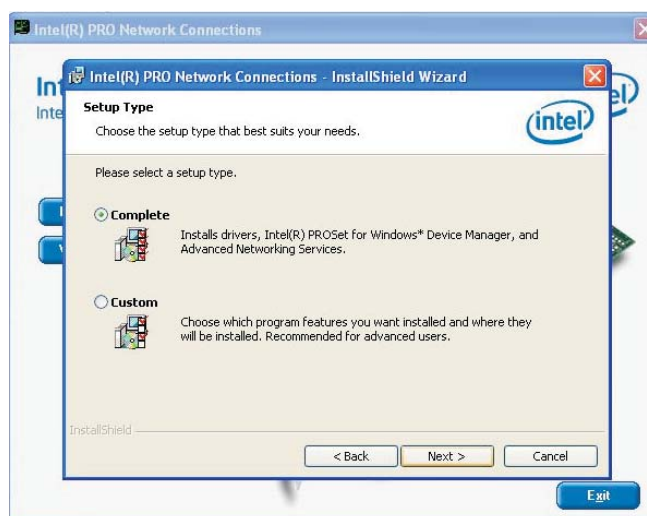

5. Click Install to begin the installation.

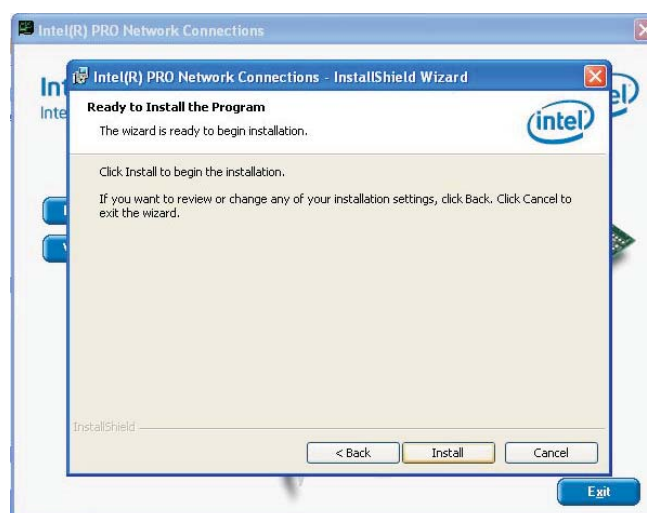

6. Click Finish to exit setup.



Marvell LAN Drivers

To install the driver, click “Marvell LAN Drivers” on the main menu.

1. The installation wizard will extract the files needed to install the driver.



2. Read the license agreement then click “I accept the terms in the license agreement”. Click Next.



3. Click Install to begin the installation.

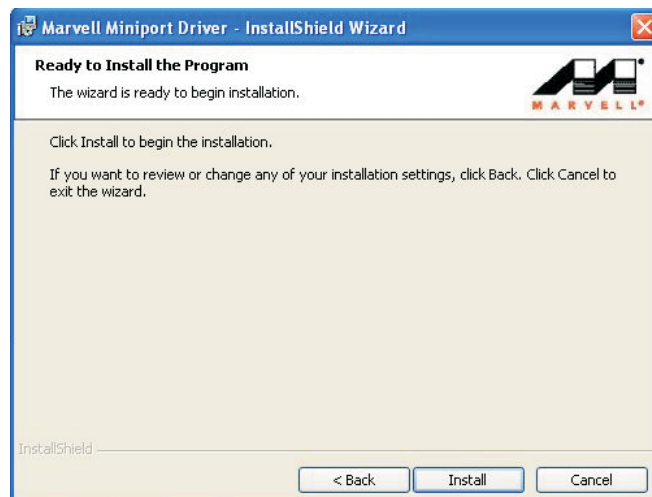

4. Setup is currently installing the driver.

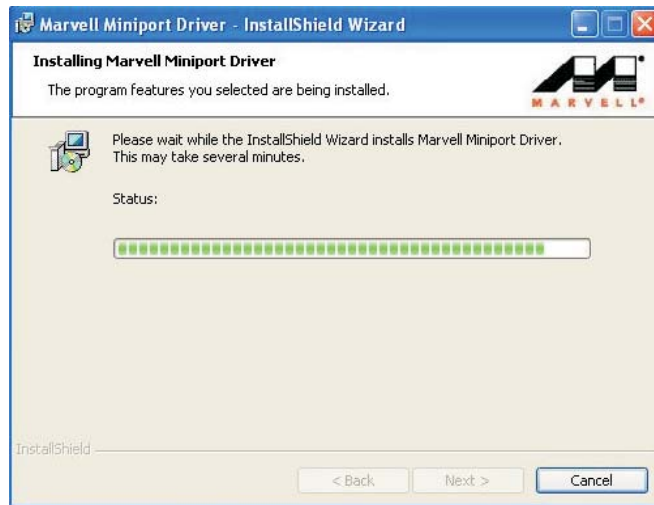

5. After completing installation, click Finish to exit setup.

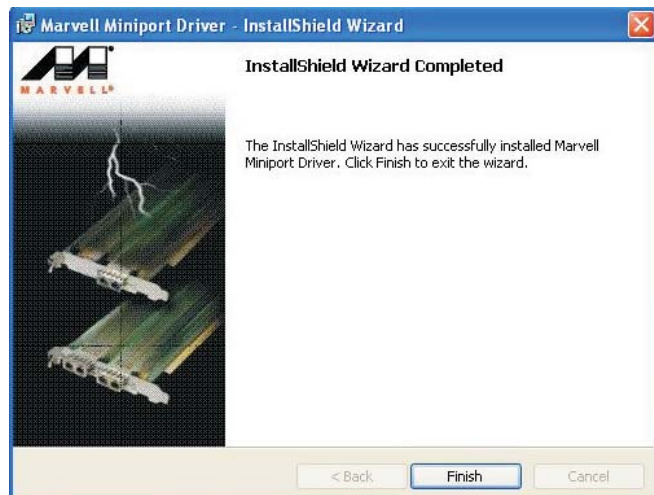

Hardware Monitor for Windows

The system board comes with the Hardware Monitor for Windows utility. This utility is capable of monitoring the system's temperature, fan speed, voltage, etc. and allows you to manually set a range (Highest and Lowest Limit) to the items being monitored. If the settings/values are over or under the set range, a warning message will pop-up. The utility can also be configured so that a beeping alarm will sound whenever an error occurs. We recommend that you use the "Default Setting" which is the ideal setting that would keep the system in good working condition.

To install, click "Hardware Monitor for Windows" on the main menu.

1. Setup is now preparing the installation wizard.

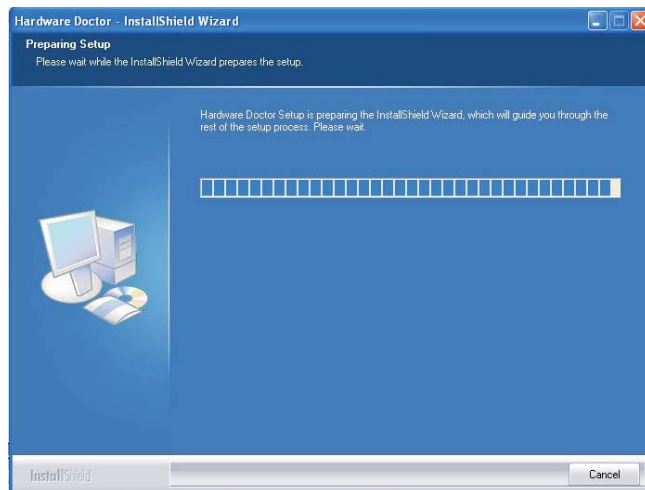

2. Setup is now ready to install the utility. Click Next.

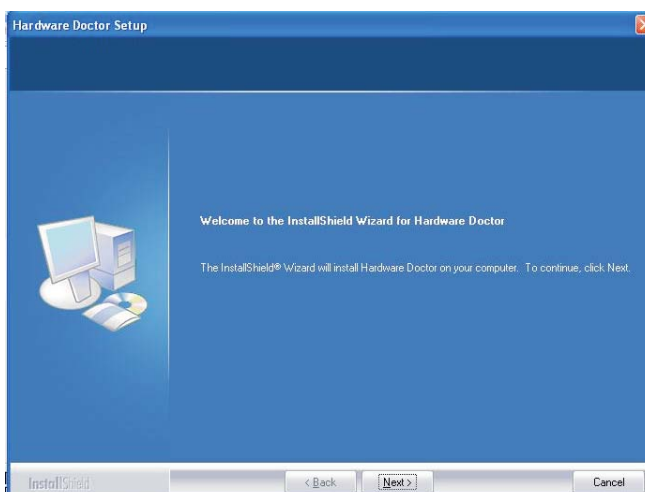

3. Click Next to install or click Browse to select another folder.

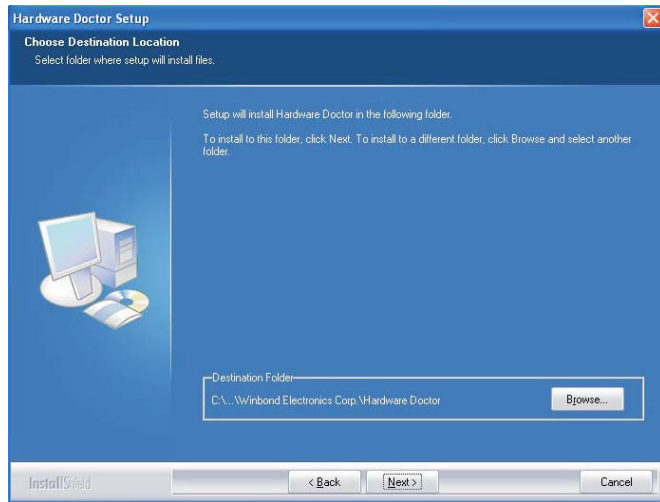

4. Click Next to add the program icon to the Program Folder.

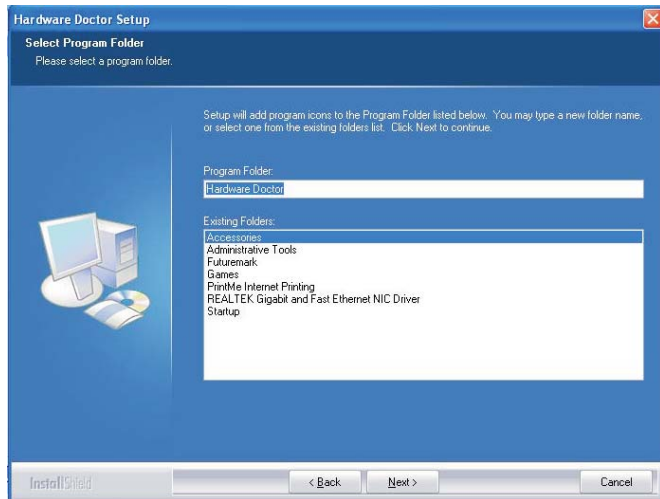

5. Hardware Doctor is configuring the new software installation.

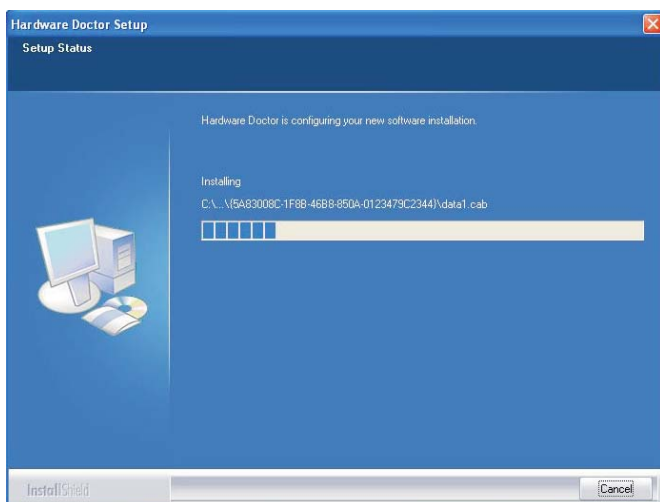

6. Click Yes if you want to create a Hardware Doctor shortcut at your desktop.



7. Click "Yes, I want to restart my computer now" then click Finish.

Restarting the system will allow the driver to take effect.

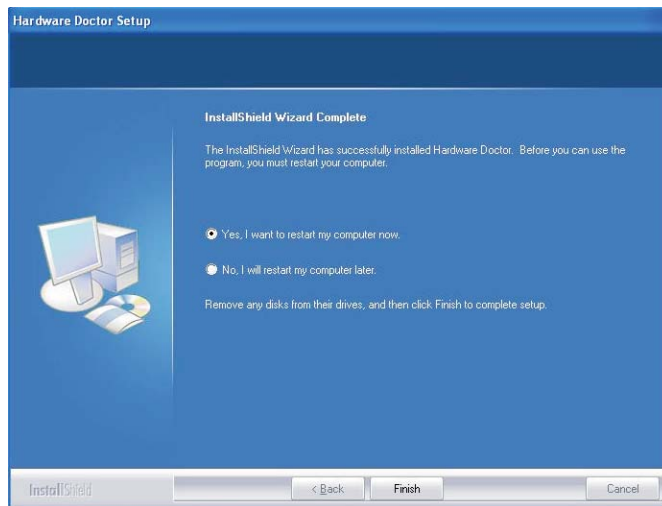

Microsoft DirectX 9.0C Driver

To install, click “Microsoft DirectX 9.0C Driver” on the main menu.

1. Click “I accept the agreement” then click Next.

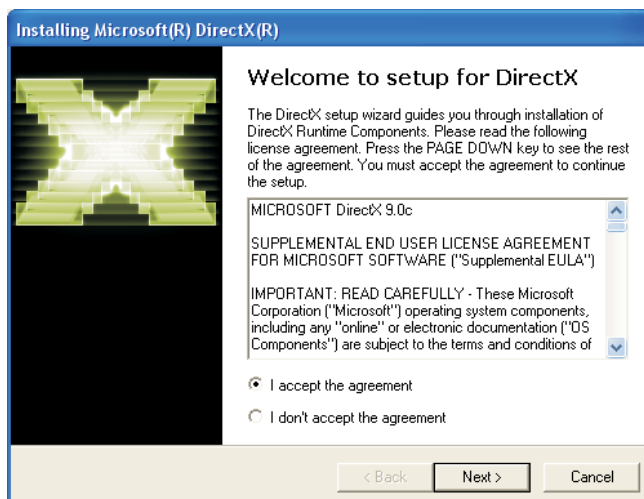

2. You are now ready to install DirectX. Click Next.

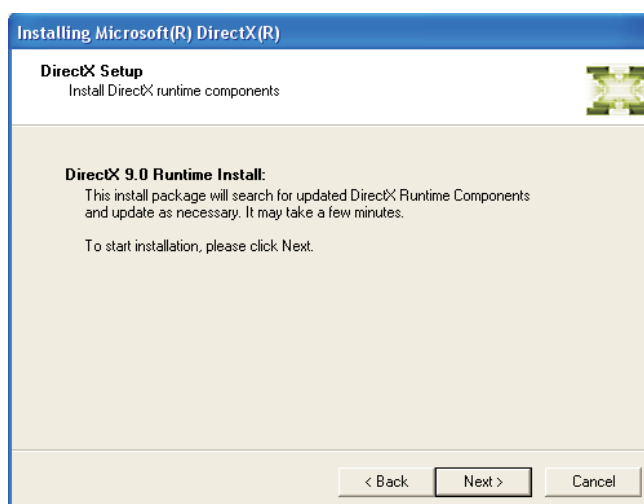

3. Click Finish. Reboot the system for DirectX to take effect.

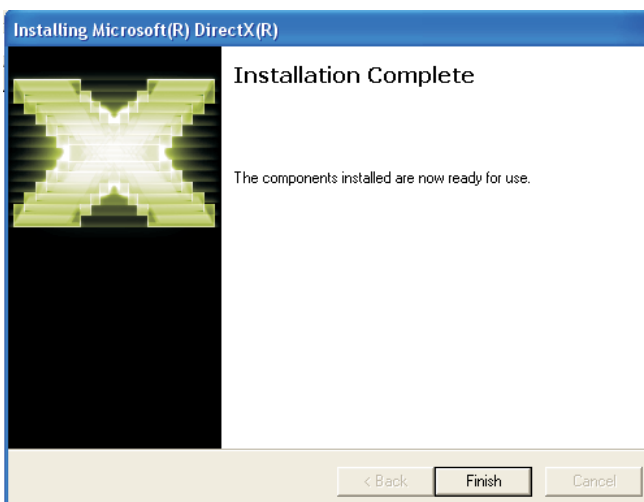

USB 2.0 Drivers

The chipset does not support USB 2.0 drivers for Windows® 98 SE and Windows® ME.

Windows® XP

If your Windows® XP CD already includes Service Pack 1, the USB 2.0 driver will automatically install when you install the operating system. If the CD does not include Service Pack 1, it is available for download at Microsoft's Windows Update website.

Windows® 2000

If your Windows® 2000 CD already includes Service Pack 4, the USB 2.0 driver will automatically install when you install the operating system. If the CD does not include Service Pack 4, it is available for download at Microsoft's Windows Update website.

Installation Notes

1. "Autorun" ONLY supports the Windows® 2000 and Windows® XP operating systems. If after inserting the CD, "Autorun" did not automatically start (which is, the Main Board Utility CD screen did not appear), please go directly to the root directory of the CD and double-click "Setup".
2. The drivers for Windows® XP Professional x64 Edition are also included in the CD however "Autorun" is not supported for this operating system. Therefore you must manually install the drivers from the respective folders of each driver.
3. All steps or procedures to install software drivers are subject to change without notice as the softwares are occasionally updated. Please contact technical support or your sales representative for the latest version of the drivers or software applications.

Chapter 5 - RAID (G7B630-NR only)

The Intel ICH8DO chip allows configuring RAID on Serial ATA drives. It supports RAID 0, RAID 1, RAID 5 and RAID 10.

RAID Levels

RAID 0 (Striped Disk Array without Fault Tolerance)

RAID 0 uses two new identical hard disk drives to read and write data in parallel, interleaved stacks. Data is divided into stripes and each stripe is written alternately between two disk drives. This improves the I/O performance of the drives at different channel; however it is not fault tolerant. A failed disk will result in data loss in the disk array.

RAID 1 (Mirroring Disk Array with Fault Tolerance)

RAID 1 copies and maintains an identical image of the data from one drive to the other drive. If a drive fails to function, the disk array management software directs all applications to the other drive since it contains a complete copy of the drive's data. This enhances data protection and increases fault tolerance to the entire system. Use two new drives or an existing drive and a new drive but the size of the new drive must be the same or larger than the existing drive.

RAID 5

RAID 5 stripes data and parity information across hard drives. It is fault tolerant and provides better hard drive performance and more storage capacity.

RAID 10 (Striping and Mirroring)

RAID 10 is a combination of data striping and data mirroring providing the benefits of both RAID 0 and RAID 1. Use four new drives or an existing drive and three new drives for this configuration.

Settings

To enable the RAID function, the following settings are required.

1. Connect the Serial ATA drives.
2. Configure Serial ATA in the Award BIOS.
3. Configure RAID in the Intel RAID BIOS.
4. Install the RAID driver during OS installation.
5. Install the Intel Matrix Storage Manager

Step 1: Connect the Serial ATA Drives

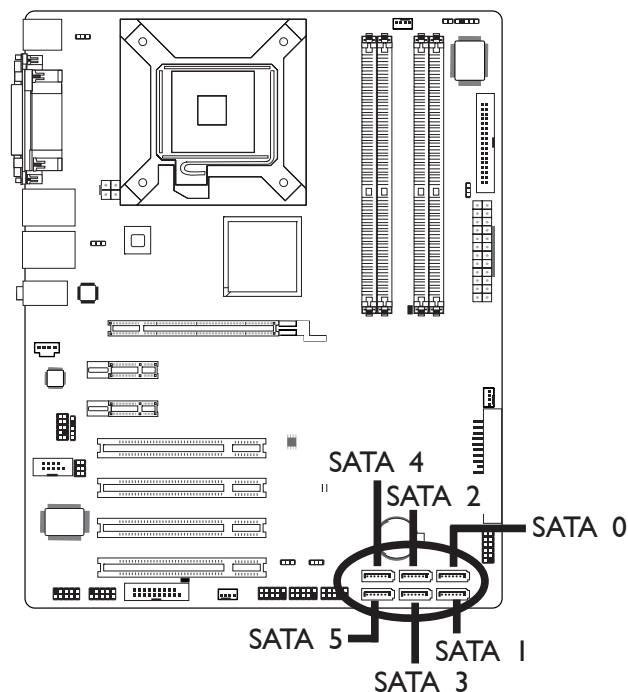

Refer to chapter 2 for details on connecting the Serial ATA drives.



Important:

1. Make sure you have installed the Serial ATA drives and connected the data cables otherwise you won't be able to enter the RAID BIOS utility.
2. Treat the cables with extreme caution especially while creating RAID. A damaged cable will ruin the entire installation process and operating system. The system will not boot and you will lose all data in the hard drives. Please give special attention to this warning because there is no way of recovering back the data.

Step 2: Configure Serial ATA in the Award BIOS

1. Power-on the system then press to enter the main menu of the Award BIOS.
2. Select the Integrated Peripherals submenu - OnChip IDE Device section of the BIOS to configure SATA.

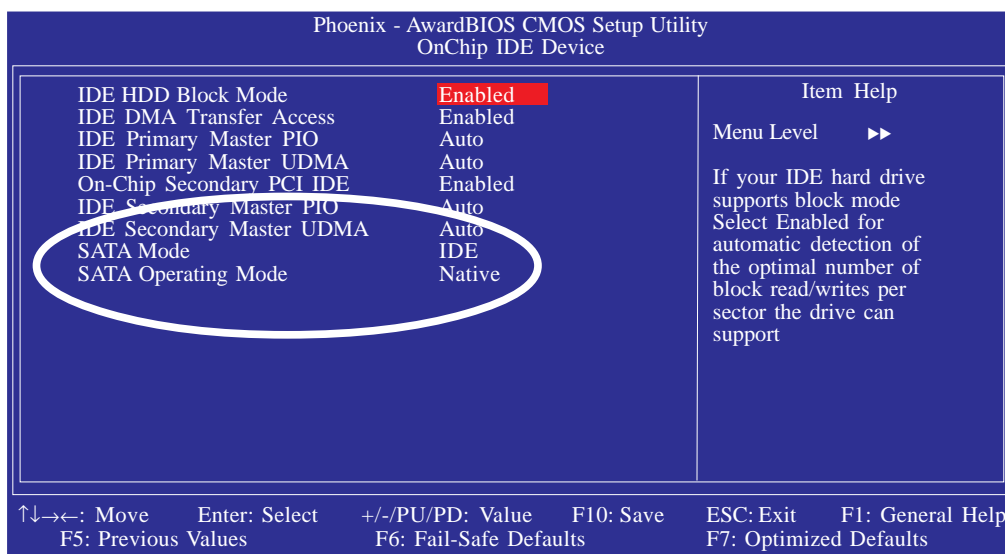

The settings on the screen are for reference only. Your version may not be identical to this one.

3. Press <Esc> to return to the main menu of the BIOS setup utility. Select "Save & Exit Setup" then press <Enter>.
4. Type <Y> and press <Enter>.
5. Reboot the system.

Step 3: Configure RAID in the Intel RAID BIOS

When the system powers-up and all drives have been detected, the Intel BIOS status message screen will appear. Press the <Ctrl> and <I> keys simultaneously to enter the utility. The utility allows you to build a RAID system on Serial ATA drives.

Step 4: Install the RAID Driver During OS Installation

The RAID driver must be installed during the Windows® XP or Windows® 2000 installation using the F6 installation method. This is required in order to install the operating system onto a hard drive or RAID volume when in RAID mode or onto a hard drive when in AHCI mode.

1. Start Windows Setup by booting from the installation CD.
2. Press <F6> when prompted in the status line with the 'Press F6 if you need to install a third party SCSI or RAID driver' message.
3. Press <S> to "Specify Additional Device".
4. At this point you will be prompted to insert a floppy disk containing the RAID driver. Insert the provided RAID driver diskette.
5. Locate for the drive where you inserted the diskette then select RAID or AHCI controller that corresponds to your BIOS setup. Press <Enter> to confirm.

You have successfully installed the driver. However you must continue installing the OS. Leave the floppy disk in the floppy drive until the system reboots itself because Windows setup will need to copy the files again from the floppy disk to the Windows installation folders. After Windows setup has copied these files again, remove the floppy diskette so that Windows setup can reboot as needed.

Step 5: Install the Intel Matrix Storage Manager

The Intel Matrix Storage Manager can be installed from within Windows. It allows RAID volume management (create, delete, migrate) from within the operating system. It will also display useful SATA device and RAID volume information. The user interface, tray icon service and monitor service allow you to monitor the current status of the RAID volume and/or SATA drives. It enables enhanced performance and power management for the storage subsystem.

To install the utility, insert the provided CD into a CD-ROM drive. Click “Intel Matrix Storage Manager” on the main menu.

1. The installation wizard will extract the files needed to install the driver:

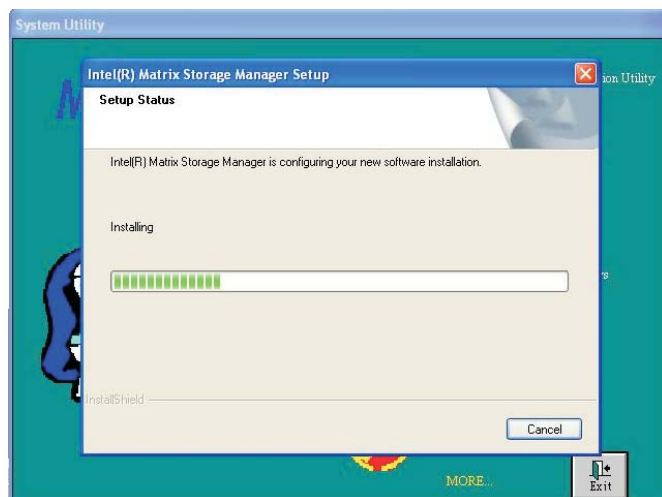

2. Intel Matrix Storage Manager is configuring your new software installation.

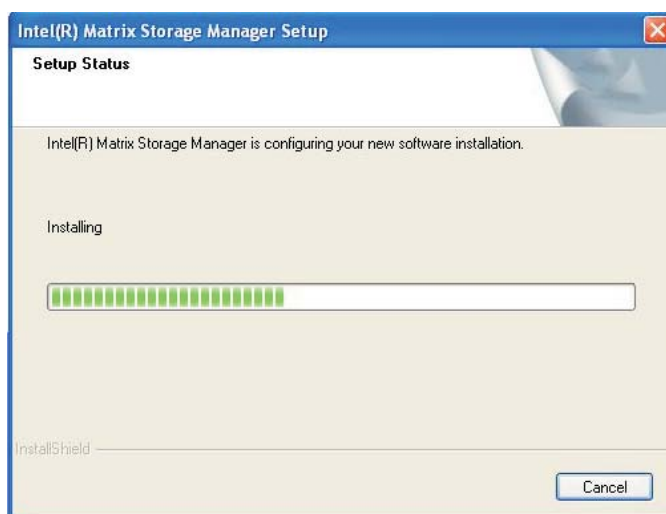

3. Setup is now ready to install the driver. Click Next.

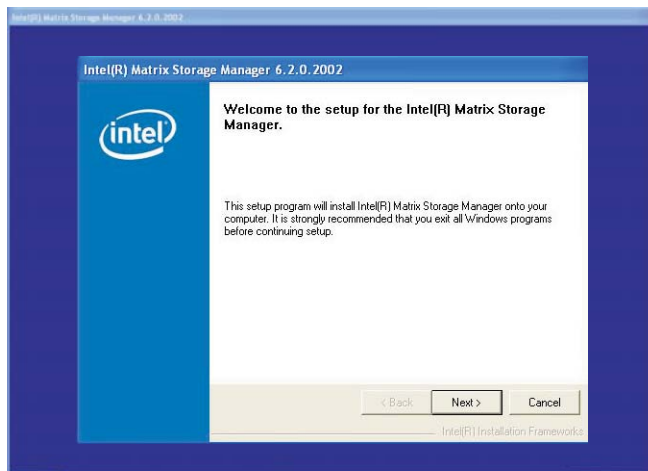

4. Read the important installation notes then click Next.

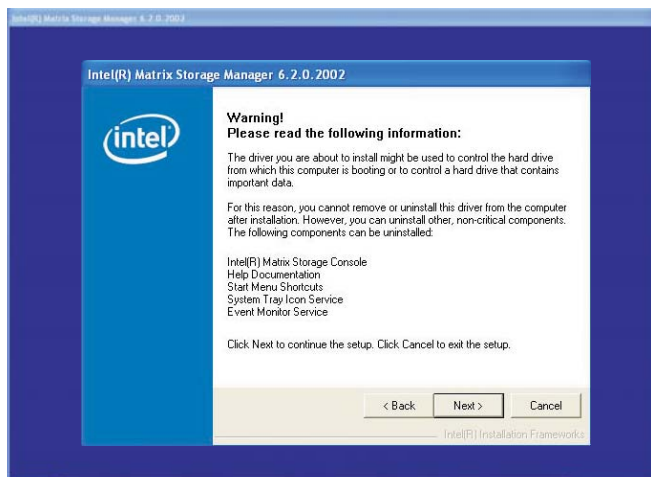

5. Read the license agreement then click Yes.

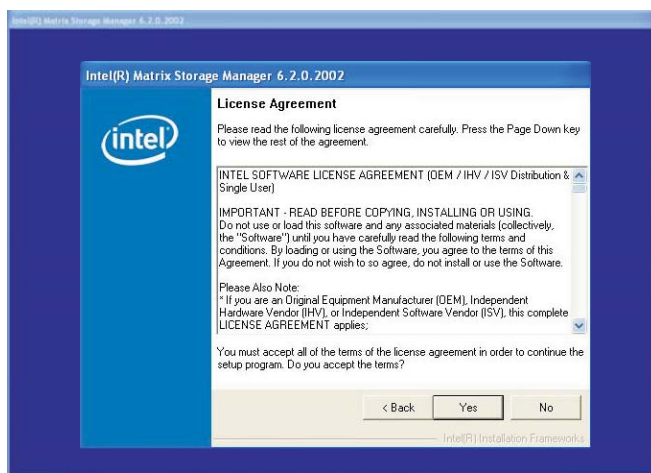

6. Go through the readme document to view system requirements and installation information then click Next.
7. Follow the prompts on the screen to complete installation.

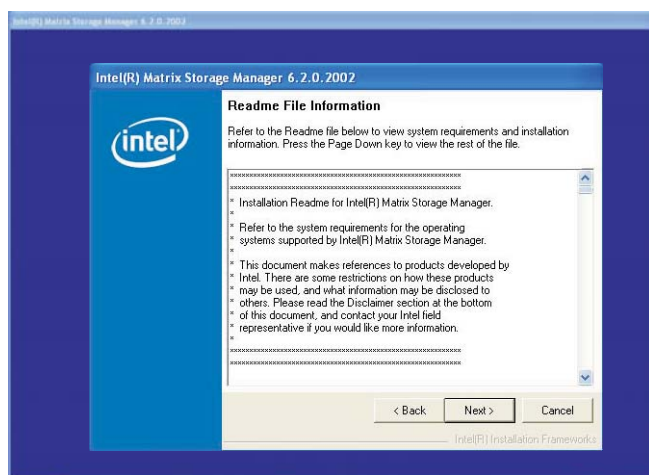

Appendix A - Enabling Hyper-Threading Technology

Enabling Hyper-Threading Technology

To enable the functionality of the Hyper-Threading Technology, please follow the requirements and steps below. Basically, the following presumes that you have already installed an Intel® Pentium® 4 Processor with Hyper-Threading Technology.

1. The system requires a minimum of 300 Watt ATX 12V power supply.
2. Aside from installing a CPU fan on the Intel® Pentium® 4 Processor with Hyper-Threading Technology, make sure to install cooling fans. The system requires adequate airflow throughout the chassis to prevent overheating the processor.
3. The “CPU Hyper-Threading” field in the Advanced BIOS Features submenu of the Award BIOS setup will appear. Make sure this field is set to Enabled.
4. Currently, only Windows® XP supports the Hyper-Threading Technology. If this OS has been previously installed, you must **REINSTALL** it.
5. After installing Windows® XP, please check the following to ensure that the operating system has been properly installed.
 - a. Click Start, point to Settings then click Control Panel.
 - b. Double-click the System icon. The System Properties dialog box will appear.

Enabling Hyper-Threading Technology

- c. Click the General tab. The processor shown under Computer should resemble the one shown below.



- d. Now click the Hardware tab then click Device Manager. The items shown under Computer and Processors should resemble the ones shown below.

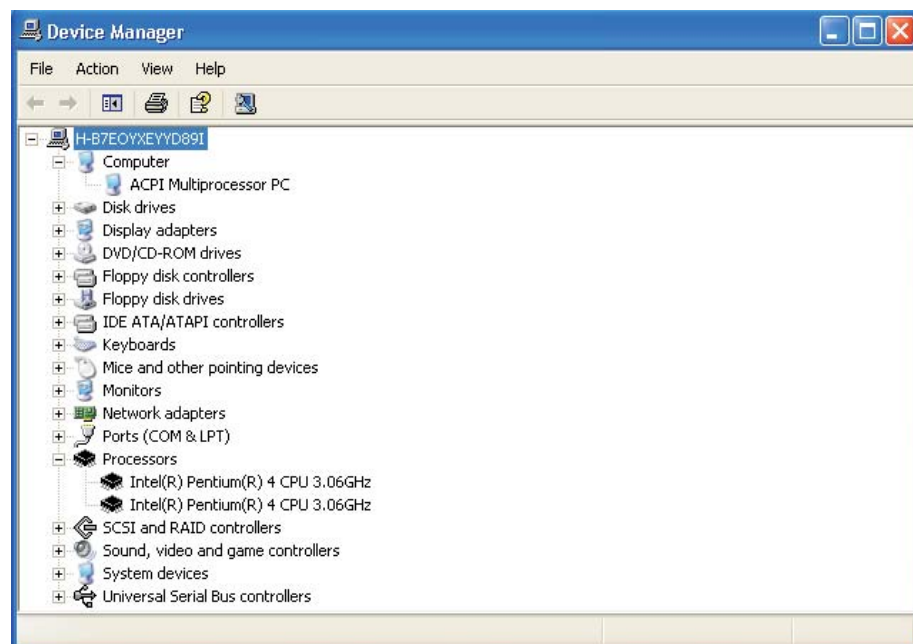

- e. Lastly, press the <Ctrl> <Alt> and keys simultaneously. The Windows Task Manager dialog box will appear. Click the Performance tab. The diagram under CPU Usage History should resemble the one shown below.

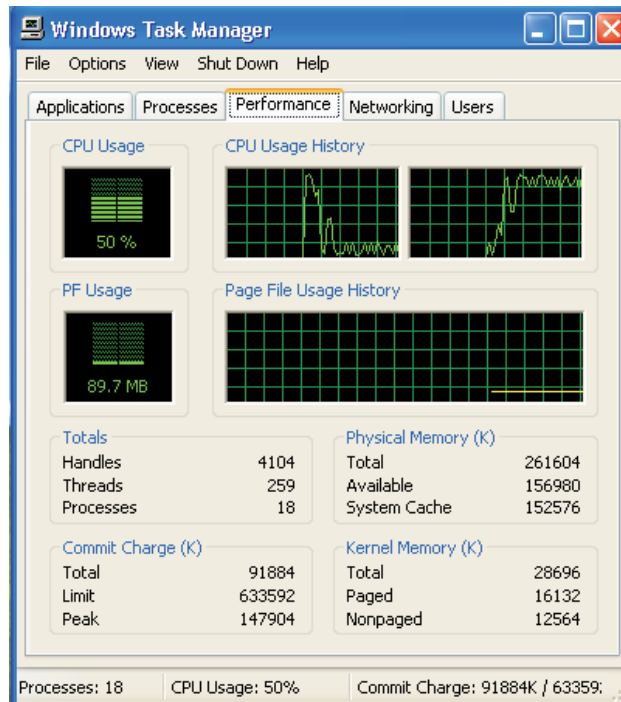

Appendix B - System Error Message

When the BIOS encounters an error that requires the user to correct something, either a beep code will sound or a message will be displayed in a box in the middle of the screen and the message, PRESS F1 TO CONTINUE, CTRL-ALT-ESC or DEL TO ENTER SETUP, will be shown in the information box at the bottom. Enter Setup to correct the error.

Error Messages

One or more of the following messages may be displayed if the BIOS detects an error during the POST. This list indicates the error messages for all Awards BIOSes:

CMOS BATTERY HAS FAILED

The CMOS battery is no longer functional. It should be replaced.



Caution:

Danger of explosion if battery incorrectly replaced. Replace only with the same or equivalent type recommended by the manufacturer. Dispose of used batteries according to the battery manufacturer's instructions.

CMOS CHECKSUM ERROR

Checksum of CMOS is incorrect. This can indicate that CMOS has become corrupt. This error may have been caused by a weak battery. Check the battery and replace if necessary.

DISPLAY SWITCH IS SET INCORRECTLY

The display switch on the motherboard can be set to either monochrome or color. This indicates the switch is set to a different setting than indicated in Setup. Determine which setting is correct, either turn off the system and change the jumper or enter Setup and change the VIDEO selection.

FLOPPY DISK(S) fail (80)

Unable to reset floppy subsystem.

FLOPPY DISK(S) fail (40)

Floppy type mismatch.

Hard Disk(s) fail (80)

HDD reset failed.

Hard Disk(s) fail (40)

HDD controller diagnostics failed.

Hard Disk(s) fail (20)

HDD initialization error.

Hard Disk(s) fail (10)

Unable to recalibrate fixed disk.

Hard Disk(s) fail (08)

Sector Verify failed.

Keyboard is locked out - Unlock the key

The BIOS detects that the keyboard is locked. Keyboard controller is pulled low.

Keyboard error or no keyboard present

Cannot initialize the keyboard. Make sure the keyboard is attached correctly and no keys are being pressed during the boot.

Manufacturing POST loop

System will repeat POST procedure infinitely while the keyboard controller is pull low. This is also used for the M/B burn in test at the factory.

BIOS ROM checksum error - System halted

The checksum of ROM address F0000H-FFFFFFH is bad.

Memory test fail

The BIOS reports memory test fail if the memory has error(s).

Appendix C - Troubleshooting

Troubleshooting Checklist

This chapter of the manual is designed to help you with problems that you may encounter with your personal computer. To efficiently troubleshoot your system, treat each problem individually. This is to ensure an accurate diagnosis of the problem in case a problem has multiple causes.

Some of the most common things to check when you encounter problems while using your system are listed below.

1. The power switch of each peripheral device is turned on.
2. All cables and power cords are tightly connected.
3. The electrical outlet to which your peripheral devices are connected is working. Test the outlet by plugging in a lamp or other electrical device.
4. The monitor is turned on.
5. The display's brightness and contrast controls are adjusted properly.
6. All add-in boards in the expansion slots are seated securely.
7. Any add-in board you have installed is designed for your system and is set up correctly.

Monitor/Display

If the display screen remains dark after the system is turned on:

1. Make sure that the monitor's power switch is on.
2. Check that one end of the monitor's power cord is properly attached to the monitor and the other end is plugged into a working AC outlet. If necessary, try another outlet.
3. Check that the video input cable is properly attached to the monitor and the system's display adapter.
4. Adjust the brightness of the display by turning the monitor's brightness control knob.

The picture seems to be constantly moving.

1. The monitor has lost its vertical sync. Adjust the monitor's vertical sync.
2. Move away any objects, such as another monitor or fan, that may be creating a magnetic field around the display.
3. Make sure your video card's output frequencies are supported by this monitor.

The screen seems to be constantly wavering.

1. If the monitor is close to another monitor, the adjacent monitor may need to be turned off. Fluorescent lights adjacent to the monitor may also cause screen wavering.

Power Supply

When the computer is turned on, nothing happens.

1. Check that one end of the AC power cord is plugged into a live outlet and the other end properly plugged into the back of the system.
2. Make sure that the voltage selection switch on the back panel is set for the correct type of voltage you are using.
3. The power cord may have a "short" or "open". Inspect the cord and install a new one if necessary.

Floppy Drive

The computer cannot access the floppy drive.

1. The floppy diskette may not be formatted. Format the diskette and try again.
2. The diskette may be write-protected. Use a diskette that is not write-protected.
3. You may be writing to the wrong drive. Check the path statement to make sure you are writing to the targeted drive.
4. There is not enough space left on the diskette. Use another diskette with adequate storage space.

Hard Drive

Hard disk failure.

1. Make sure the correct drive type for the hard disk drive has been entered in the BIOS.
2. If the system is configured with two hard drives, make sure the bootable (first) hard drive is configured as Master and the second hard drive is configured as Slave. The master hard drive must have an active/bootable partition.

Excessively long formatting period.

If your hard drive takes an excessively long period of time to format, it is likely a cable connection problem. However, if your hard drive has a large capacity, it will take a longer time to format.

Parallel Port

The parallel printer doesn't respond when you try to print.

1. Make sure that your printer is turned on and that the printer is on-line.
2. Make sure your software is configured for the right type of printer attached.
3. Verify that the onboard LPT port's I/O address and IRQ settings are configured correctly.
4. Verify that the attached device works by attaching it to a parallel port that is working and configured correctly. If it works, the printer can be assumed to be in good condition. If the printer remains inoperative, replace the printer cable and try again.

Serial Port

The serial device (modem, printer) doesn't output anything or is outputting garbled characters.

1. Make sure that the serial device's power is turned on and that the device is on-line.
2. Verify that the device is plugged into the correct serial port on the rear of the computer.

3. Verify that the attached serial device works by attaching it to a serial port that is working and configured correctly. If the serial device does not work, either the cable or the serial device has a problem. If the serial device works, the problem may be due to the onboard I/O or the address setting.
4. Make sure the COM settings and I/O address are configured correctly.

Keyboard

Nothing happens when a key on the keyboard was pressed.

1. Make sure the keyboard is properly connected.
2. Make sure there are no objects resting on the keyboard and that no keys are pressed during the booting process.

System Board

1. Make sure the add-in card is seated securely in the expansion slot. If the add-in card is loose, power off the system, re-install the card and power up the system.
2. Check the jumper settings to ensure that the jumpers are properly set.
3. Verify that all memory modules are seated securely into the memory sockets.
4. Make sure the memory modules are in the correct locations.
5. If the board fails to function, place the board on a flat surface and seat all socketed components. Gently press each component into the socket.
6. If you made changes to the BIOS settings, re-enter setup and load the BIOS defaults.

Appendix D - Watchdog Sample Code

;Software programming example:

```
;-----  
;(1)Enter Superio Configuration mode  
;-----  
MOV    DX,2Eh  
MOV    AL,87h  
OUT    DX,AL  
MOV    AL,01h  
OUT    DX,AL  
MOV    AL,55h  
OUT    DX,AL  
MOV    AL,55h  
OUT    DX,AL  
;-----  
;(2) Configuration Logical Device 7,register CR72 & CR73  
; (Watch Dog Timer enable & Time-Out Value Register)  
;-----  
MOV    DX,2Eh  
MOV    AL,07h    ;Ready to Program Logical Device  
OUT    DX,AL  
  
MOV    DX,2Fh  
MOV    AL,07h    ;Select Logical Device 7  
OUT    DX,AL  
  
MOV    DX,2Eh  
MOV    AL,72h    ;Select CR72  
OUT    DX,AL  
  
MOV    DX,2Fh  
IN     AL,DX  
OR     AL,40h    ;Set CR72[Bit:6]=1, WDT output through KRST  
                     enable  
OUT    DX,AL
```

D

Watchdog Sample Code.....

```
MOV    DX,2Eh
MOV    AL,73h    ;Select CR73 (Watch Dog Timer Time-Out Value
                ;Register)
OUT    DX,AL

MOV    DX,2Fh
MOV    AL,02h    ;Set CR73 value = 02h => Watch Dog Time = 2
                ;(unit:Min)
OUT    DX,AL

;-----
;(3) Exit extended function mode
;-----
MOV    DX,2Eh
MOV    AL,02h
OUT    DX,AL

MOV    DX,2Fh
MOV    AL,02h
OUT    DX,AL
```