

# **G5M300-P**

## **Rev. A+ System Board User's Manual**

935-G5M301-000  
A83300438

## Copyright

This publication contains information that is protected by copyright. No part of it may be reproduced in any form or by any means or used to make any transformation/adaptation without the prior written permission from the copyright holders.

This publication is provided for informational purposes only. The manufacturer makes no representations or warranties with respect to the contents or use of this manual and specifically disclaims any express or implied warranties of merchantability or fitness for any particular purpose. The user will assume the entire risk of the use or the results of the use of this document. Further, the manufacturer reserves the right to revise this publication and make changes to its contents at any time, without obligation to notify any person or entity of such revisions or changes.

© 2004. All Rights Reserved.

## Trademarks

Windows® 98, Windows® 98 SE, Windows® ME, Windows® 2000, Windows NT® 4.0 and Windows® XP are registered trademarks of Microsoft Corporation. Intel®, Pentium® M and Celeron® M are registered trademarks of Intel Corporation. Award is a registered trademark of Award Software, Inc. Other trademarks and registered trademarks of products appearing in this manual are the properties of their respective holders.

## Caution

To avoid damage to the system:

- Use the correct AC input voltage range.

To reduce the risk of electric shock:

- Unplug the power cord before removing the system chassis cover for installation or servicing. After installation or servicing, cover the system chassis before plugging the power cord.

Battery:

- Danger of explosion if battery incorrectly replaced.
- Replace only with the same or equivalent type recommend by the manufacturer.
- Dispose of used batteries according to the battery manufacturer's instructions.

## **FCC and DOC Statement on Class B**

This equipment has been tested and found to comply with the limits for a Class B digital device, pursuant to Part 15 of the FCC rules. These limits are designed to provide reasonable protection against harmful interference when the equipment is operated in a residential installation. This equipment generates, uses and can radiate radio frequency energy and, if not installed and used in accordance with the instruction manual, may cause harmful interference to radio communications. However, there is no guarantee that interference will not occur in a particular installation. If this equipment does cause harmful interference to radio or television reception, which can be determined by turning the equipment off and on, the user is encouraged to try to correct the interference by one or more of the following measures:

- Reorient or relocate the receiving antenna.
- Increase the separation between the equipment and the receiver.
- Connect the equipment into an outlet on a circuit different from that to which the receiver is connected.
- Consult the dealer or an experienced radio TV technician for help.

Notice:

1. The changes or modifications not expressly approved by the party responsible for compliance could void the user's authority to operate the equipment.
2. Shielded interface cables must be used in order to comply with the emission limits.

## Notice

An electronic file of this manual is included in the CD. To view the user's manual in the CD, insert the CD into a CD-ROM drive. The autorun screen (Main Board Utility CD) will appear. Click "User's Manual" on the main menu.

# Table of Contents

## Chapter 1 - Introduction

1.1	Features.....	7
1.2	Special Features of the System Board.....	11
1.3	Package Checklist.....	15

## Chapter 2 - Hardware Installation

2.1	System Board Layout .....	16
2.2	System Memory.....	17
2.3	CPU.....	19
2.4	Jumper Settings.....	23
2.5	Rear Panel I/O Ports.....	33
2.6	I/O Connectors.....	46

## Chapter 3 - BIOS Setup

3.1	Award BIOS Setup Utility.....	60
3.2	Intel RAID BIOS Setting Utility.....	100
3.3	Updating the BIOS.....	101

## Chapter 4 - Supported Softwares

4.1	Drivers, Utilities and Software Applications.....	103
4.2	Installation Notes.....	114

## Appendix A - Watchdog Timer

A.1 Watchdog Timer.....	115
-------------------------	-----

## Appendix B - System Error Messages

B.1 POST Beep.....	116
B.2 Error Messages.....	116

## Appendix C - Troubleshooting

C.1 Troubleshooting Checklist.....	118
------------------------------------	-----

# Chapter 1 - Introduction

---

## 1.1 Features

### Processor

- Intel® Pentium® M / Celeron® M processor
  - 400MHz system bus
  - Supports 64-bit host data bus and 32-bit addressing
- Processor socket: mPGA479M

### Chipset

- Intel® 855GME chipset
  - Intel® 855GME Graphics Memory Controller Hub (GMCH)
  - Intel® 6300ESB I/O Controller Hub

### System Memory

- Two 184-pin DDR SDRAM DIMM sockets
- 2.5V unbuffered PC1600 (DDR200), PC2100 (DDR266) or PC2700 (DDR333) DDR SDRAM DIMM with ECC support
- Supports 128Mbit, 256Mbit and 512Mbit technologies providing maximum capacity of 1GB with x16 devices and up to 2GB with high density 512Mbit technology

### BIOS

- Award BIOS
- Supports SCSI sequential boot-up
- Supports DMI 2.0 function
- 4Mbit flash memory

### Energy Efficient Design

- Supports ACPI specification and OS Directed Power Management
- Supports ACPI STR (Suspend to RAM) function
- Wake-On-Events include:
  - Wake-On-PS/2 Keyboard/Mouse
  - Wake-On-USB Keyboard
  - Wake-On-LAN
  - Wake-On-Ring
  - RTC timer to power-on the system
- System power management supported

- CPU stopped clock control
- Hardware supports SMI green mode
- Microsoft®/Intel® APM 1.2 compliant
- Soft Power supported - ACPI v1.0a specification
- AC power failure recovery

### Damage Free Intelligence

- Monitors CPU/system temperature and overheat alarm
- Monitors 5VSB(V)/VBAT(V)/1.5V/3.3V/5V/12V/CPU(V) voltages and failure alarm
- Monitors CPU/chassis/2nd fan speed and failure alarm
- Read back capability that displays temperature, voltage and fan speed
- Watchdog timer function

### Onboard Graphics Features

- Up to 64MB of dynamic video memory allocation
- Display core frequency at 250MHz (default)
- Render core frequency at 250MHz (default)
- Intel® Dual-Frequency Graphics Technology
- 2D graphics engine
  - Optimized 128-bit BLT engine
  - 32-bit Alpha Blended cursor
  - 8-bit, 16-bit and 32-bit color
- 3D graphics engine
  - Enhanced Hardware Binning Instruction Set
  - Bi-Cubic Filtering
  - Linear Gamma Blending for Video Mixer Rendering (VMR)
  - Video Mixer Rendering (VMR)
  - 3D setup and render engine
  - DirectX and OpenGL pixelization rules
  - 266-MegaTexel/s peak performance
  - 16- and 24-bit Z-buffering; 16- and 24-bit W-buffering
  - Optimal 3D resolution
  - Double and triple render buffer
- Graphics Power Management
  - Dynamic Frequency Switching
  - Memory Self-Refresh During C3
  - Intel® Display Power Saving Technology



### Display

- Dedicated LFP (Local Flat Panel) interface
  - Supports data format up to 24-bpp
- Analog display
  - 350MHz integrated 24-bit RAMDAC
  - Pixel resolution up to 1600x1200 at 85Hz and up to 2048x1536 at 75Hz

### LFP (Local Flat Panel) LVDS Interface

- Single- or dual-channel LVDS panel supports up to UXGA panel resolution with frequency range from 25MHz to 112MHz (single/dual channel)
- Integrated PWM interface for LCD backlight inverter control

### Onboard Audio Features

- Realtek ALC202A 2-channel audio
- 18-bit stereo full-duplex codec with independent variable sampling rate
- DirectSound 3D™ compatible
- S/PDIF-out interface
- Speaker-out jack supports 2W amplifier providing better audio quality to the headphone or speakers

### Onboard LAN Features

- RTL8105 Gigabit ethernet controller
- Supports 10Mbps, 100Mbps and 1Gbps data transmission
- IEEE 802.3 (10/100Mbps) and IEEE 802.3ab (1Gbps) compliant

### Serial ATA Interface with RAID

- Supports two SATA (Serial ATA) interfaces which are compliant with SATA 1.0 specification (1.5Gbps interface)
- Supports RAID 0 and RAID 1

### IDE Interface

- Supports up to UltraDMA 100Mbps hard drives
- PIO Mode 4 Enhanced IDE (data transfer rate up to 14MB/sec.)

### IEEE 1394 Interface

- VIA VT6307
- Supports two 100/200/400 Mb/sec ports

### Accelerated Graphics Port (A.G.P.)

- Supports 1.5V AGP 4x data transfers and 2x/4x fast write protocol (3.3V AGP card is not supported)
- AGP 2.0 compliant

### Rear Panel I/O Ports

- 1 mini-DIN-6 PS/2 mouse port
- 1 mini-DIN-6 PS/2 keyboard port
- 1 DB-25 parallel port
- 1 DB-9 serial port
- 1 DB-15 VGA port
- 1 IEEE 1394 port
- 1 RJ45 LAN port
- 4 USB 2.0/1.1 ports
- Mic-in, line-in and speaker-out

### I/O Connectors

- 3 connectors for 3 external serial ports
- 1 connector for 1 external IEEE 1394 port
- 1 LCD brightness control connector
- 1 LVDS LCD panel connector
- 1 LCD power connector
- 1 front audio connector for speaker-out and mic-in jacks
- 1 CD-in internal audio connector
- 1 S/PDIF-out connector
- 1 connector for IrDA interface
- 2 Serial ATA connectors
- 2 40-pin IDE connectors
- 1 floppy connector
- 1 ATX power supply connector
- 1 front panel connector
- 3 fan connectors

### Expansion Slots

- 1 AGP 4x slot
- 1 PCI-X slot
- 2 PCI slots

### Compatibility

- PCI 2.2, Intel AGP 2.0, PCI-X 2.2 and AC '97 compliant

### PCB

- 4 layers, microATX form factor
- 24.4cm (9.61") x 23cm (9.06")

## I.2 Special Features of the System Board

### Watchdog Timer

The Watchdog Timer function allows your application to regularly “clear” the system at the set time interval. If the system hangs or fails to function, it will reset at the set time interval so that your system will continue to operate.

### DDR

Double Data Rate SDRAM (DDR SDRAM) is a type of SDRAM that doubles the data rate through reading and writing at both the rising and falling edge of each clock. This effectively doubles the speed of operation therefore doubling the speed of data transfer.

### S/PDIF

S/PDIF is a standard audio file transfer format that transfers digital audio signals to a device without having to be converted first to an analog format. This prevents the quality of the audio signal from degrading whenever it is converted to analog. S/PDIF is usually found on digital audio equipment such as a DAT machine or audio processing device. The S/PDIF connector on the system board sends surround sound and 3D audio signal outputs to amplifiers and speakers and to digital recording devices like CD recorders.

### Serial ATA Interface with RAID

Serial ATA is a storage interface that is compliant with SATA 1.0 specification. With speed of up to 1.5Gbps, it improves hard drive performance faster than the standard parallel ATA whose data transfer rate is 100MB/s. The system board allows configuring RAID on Serial ATA drives. It supports RAID 0 and RAID 1.

### IEEE 1394 Interface

IEEE 1394 is fully compliant with the 1394 OHCI (Open Host Controller Interface) 1.1 specification. It supports up to 63 devices that can run simultaneously on a system. 1394 is a fast external bus standard that supports data transfer rates of up to 400Mbps. In addition to its high speed, it also supports isochronous data transfer which is ideal for video devices that need to transfer high levels of data in real-time. 1394 supports both Plug-and-Play and hot plugging.

### IrDA Interface

The system board is equipped with an IrDA connector for wireless connectivity between your computer and peripheral devices. The IRDA (Infrared Data Association) specification supports data transfers of 115K baud at a distance of 1 meter.

### USB Ports

The system board supports USB 2.0 and USB 1.1 ports. USB 1.1 supports 12Mb/second bandwidth while USB 2.0 supports 480Mb/second bandwidth providing a marked improvement in device transfer speeds between your computer and a wide range of simultaneously accessible external Plug and Play peripherals.

### AGP (Accelerated Graphics Port)

AGP is an interface designed to support high performance 3D graphics cards. It utilizes a dedicated pipeline to access system memory for texturing, z-buffering and alpha blending. The AGP slot supports AGP 4x (1.5V) with up to 1066MB/sec. bandwidth for 3D graphics applications. AGP in this system board will deliver faster and better graphics to your PC.

### Dual Function Power Button

Depending on the setting in the “Soft-Off By PWR-BTTN” field of the Power Management Setup, this switch will allow the system to enter the Soft-Off or Suspend mode.

## Wake-On-Ring

This feature allows the system that is in the Suspend mode or Soft Power Off mode to wake-up/power-on to respond to calls coming from an external modem or respond to calls from a modem PCI card that uses the PCI PME (Power Management Event) signal to remotely wake up the PC.



**Important:**

*If you are using a modem add-in card, the 5VSB power source of your power supply must support a minimum of  $\geq 720\text{mA}$ .*

## Wake-On-LAN

This feature allows the network to remotely wake up a Soft Power Down (Soft-Off) PC. It is supported via the onboard LAN port or via a PCI LAN card that uses the PCI PME (Power Management Event) signal. However, if your system is in the Suspend mode, you can power-on the system only through an IRQ or DMA interrupt.



**Important:**

*The 5VSB power source of your power supply must support  $\geq 720\text{mA}$ .*

## Wake-On-PS/2 Keyboard/Mouse

This function allows you to use the PS/2 keyboard or PS/2 mouse to power-on the system.



**Important:**

*The 5VSB power source of your power supply must support  $\geq 720\text{mA}$ .*

## Wake-On-USB Keyboard

This function allows you to use a USB keyboard to wake up a system from the S3 (STR - Suspend To RAM) state.



### Important:

- *If you are using the Wake-On-USB Keyboard function for 2 USB ports, the 5VSB power source of your power supply must support  $\geq 1.5A$ .*
- *If you are using the Wake-On-USB Keyboard function for 3 or more USB ports, the 5VSB power source of your power supply must support  $\geq 2A$ .*

## RTC Timer to Power-on the System

The RTC installed on the system board allows your system to automatically power-on on the set date and time.

## ACPI STR

The system board is designed to meet the ACPI (Advanced Configuration and Power Interface) specification. ACPI has energy saving features that enables PCs to implement Power Management and Plug-and-Play with operating systems that support OS Direct Power Management. Currently, only Windows® 98/2000/ME/XP supports the ACPI function. ACPI when enabled in the Power Management Setup will allow you to use the Suspend to RAM function.

With the Suspend to RAM function enabled, you can power-off the system at once by pressing the power button or selecting “Standby” when you shut down Windows® 98/2000/ME/XP without having to go through the sometimes tiresome process of closing files, applications and operating system. This is because the system is capable of storing all programs and data files during the entire operating session into RAM (Random Access Memory) when it powers-off. The operating session will resume exactly where you left off the next time you power-on the system.



### Important:

*The 5VSB power source of your power supply must support  $\geq 1A$ .*

### Virus Protection

Most viruses today destroy data stored in hard drives. The system board is designed to protect the boot sector and partition table of your hard disk drive.

## I.3 Package Checklist

The system board package contains the following items:

- The system board
- A user's manual
- One IDE cable
- One floppy cable
- Two Serial ATA data cables
- One Serial ATA power cable
- One "Main Board Utility" CD
- One Intel RAID driver diskette
- One I/O shield
- One CPU fan and heat sink assembly

If any of these items are missing or damaged, please contact your dealer or sales representative for assistance.

# Chapter 2 - Hardware Installation

## 2.1 System Board Layout

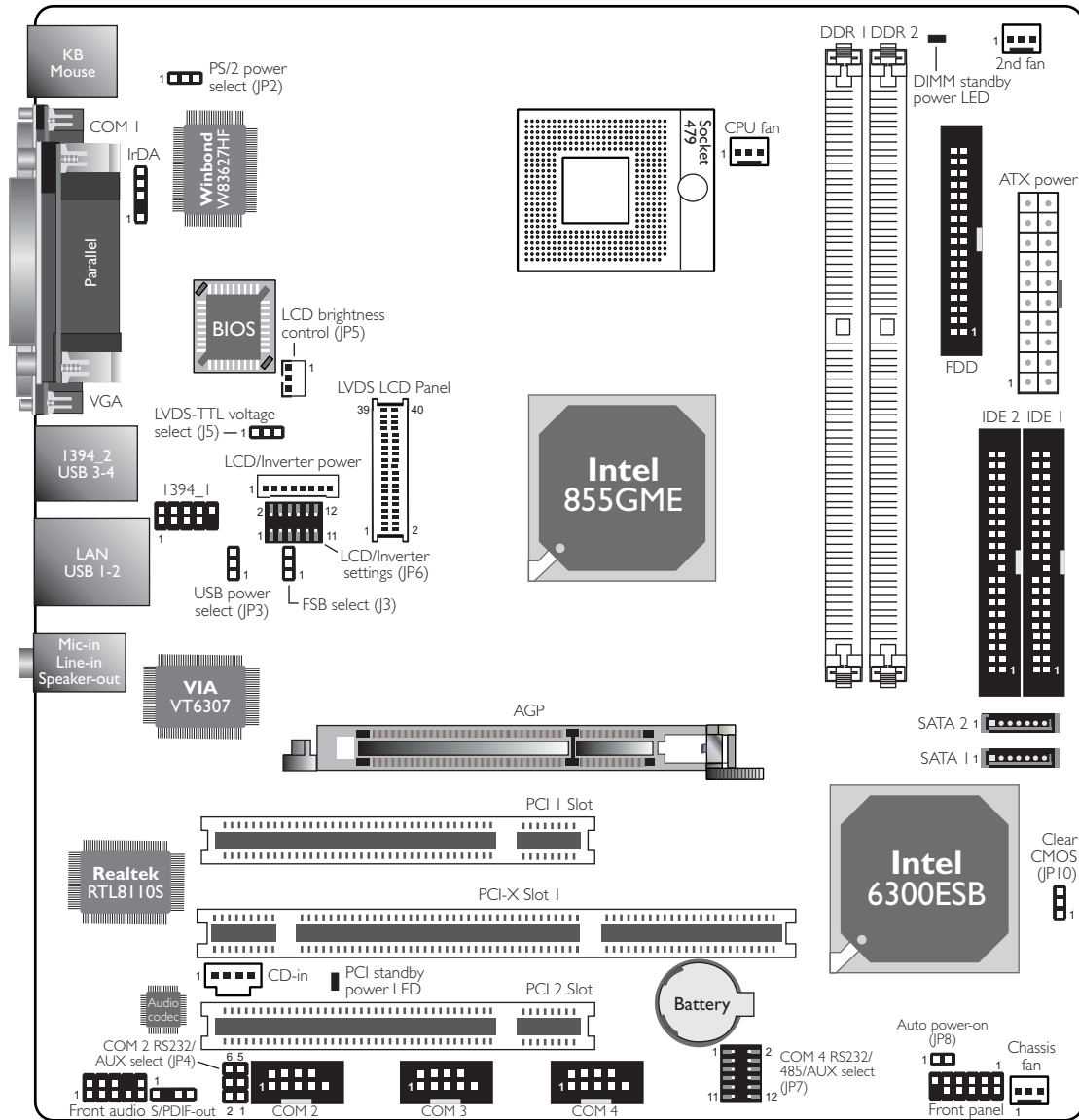



**Warning:**

Electrostatic discharge (ESD) can damage your system board, processor, disk drives, add-in boards, and other components. Perform the upgrade instruction procedures described at an ESD workstation only. If such a station is not available, you can provide some ESD protection by wearing an antistatic wrist strap and attaching it to a metal part of the system chassis. If a wrist strap is unavailable, establish and maintain contact with the system chassis throughout any procedures requiring ESD protection.

## 2.2 System Memory

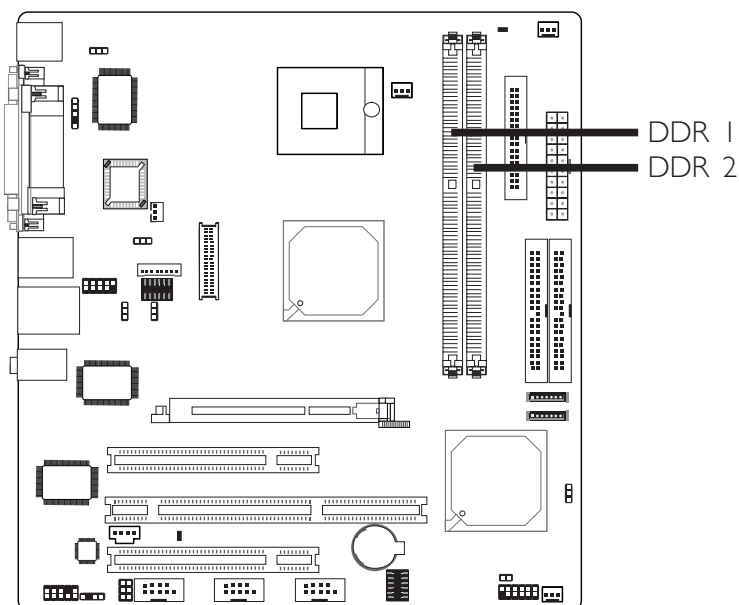

The system board supports DDR SDRAM DIMM. Double Data Rate SDRAM (DDR SDRAM) is a type of SDRAM that doubles the data rate through reading and writing at both the rising and falling edge of each clock. This effectively doubles the speed of operation therefore doubling the speed of data transfer.

### BIOS Setting

Configure the system memory in the Advanced Chipset Features submenu of the BIOS.

### 2.2.1 Installing the DIM Module

A DIM module simply snaps into a DIMM socket on the system board. Pin 1 of the DIM module must correspond with Pin 1 of the socket.

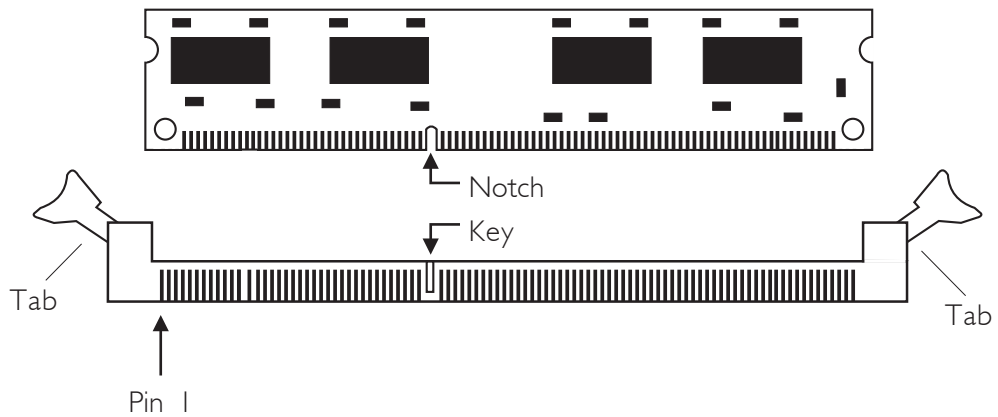

1. Pull the “tabs” which are at the ends of the socket to the side.
2. Position the DIMM above the socket with the “notch” in the module aligned with the “key” on the socket.
3. Seat the module vertically into the socket. Make sure it is completely seated. The tabs will hold the DIMM in place.

## 2.3 CPU

### 2.3.1 Overview

The system board is equipped with a surface mount mPGA479M (Socket 479) CPU socket. This socket is exclusively designed for installing an Intel® Pentium® M / Celeron® M processor.

### 2.3.2 Installing the CPU

1. Make sure the PC and all other peripheral devices connected to it has been powered down.
2. Disconnect all power cords and cables.
3. Locate the 479-pin CPU socket on the system board.

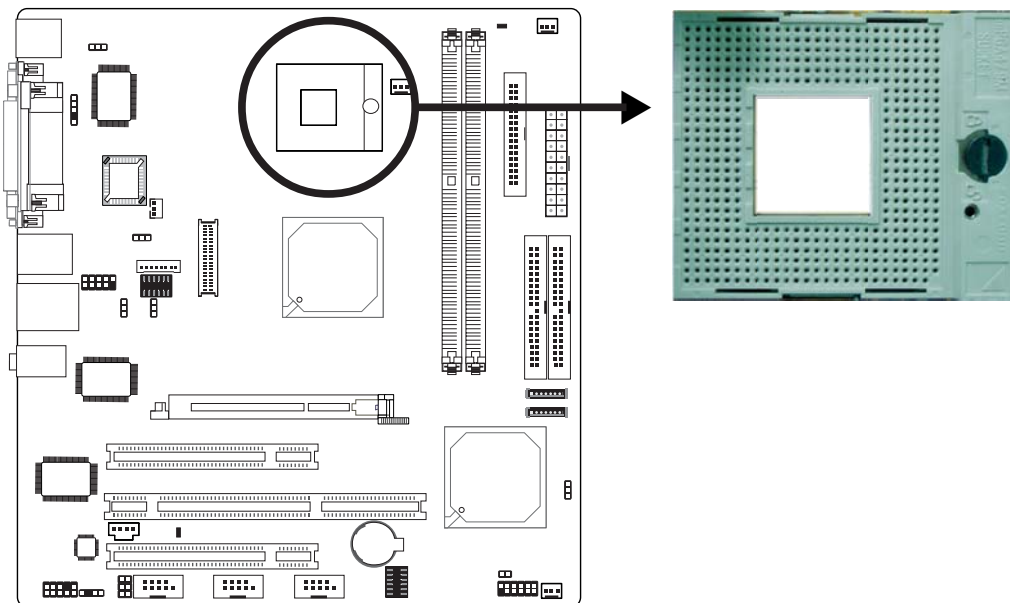

4. Use a screwdriver to turn the screw to its unlock position.

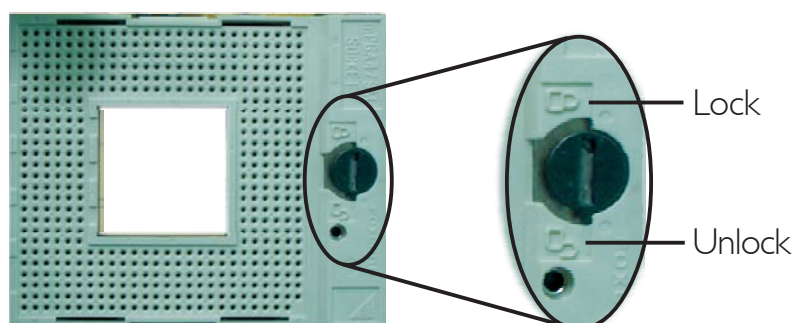

5. Position the CPU above the socket. The gold triangular mark on the CPU must align with pin 1 of the CPU socket.

**Important:**

*Handle the CPU by its edges and avoid touching the pins.*

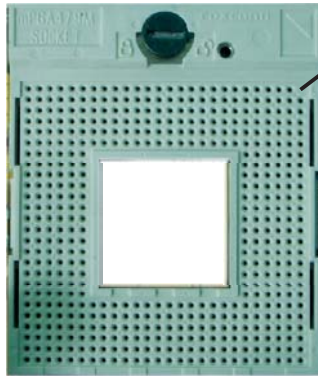

Pin 1 of the socket



Gold triangular mark

6. Insert the CPU into the socket until it is seated in place. The CPU will fit in only one orientation and can easily be inserted without exerting any force. Use a screwdriver to turn the screw to its lock position.

**Important:**

*Do not force the CPU into the socket. Forcing the CPU into the socket may bend the pins and damage the CPU.*

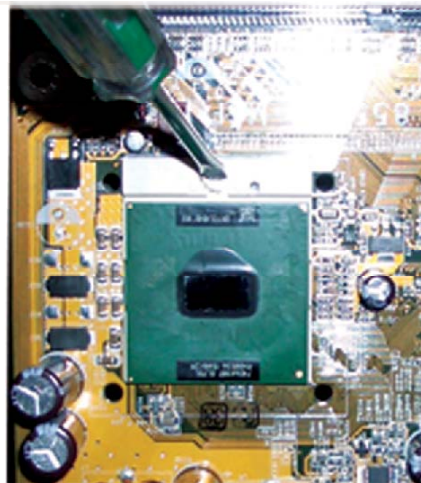

### 2.3.3 Installing the Fan and Heat Sink

The CPU must be kept cool by using a CPU fan with heat sink. Without sufficient air circulation across the CPU and heat sink, the CPU will overheat damaging both the CPU and system board.



**Note:**

- Use only the fan and heat sink assembly included in the system board package.
- The fan and heat sink package contains the fan and heat sink assembly, and a retention module base.

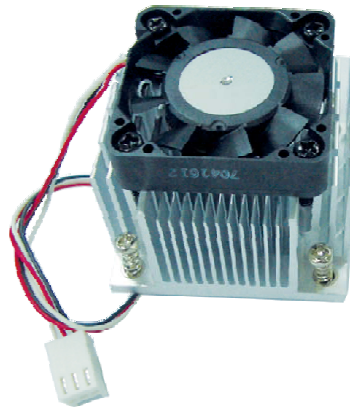

CPU fan and  
heat sink assembly

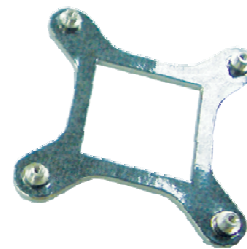

Retention  
module base

- Match and insert the screw holes of the retention module base to the mounting holes around the CPU socket from the bottom through the top of the system board.

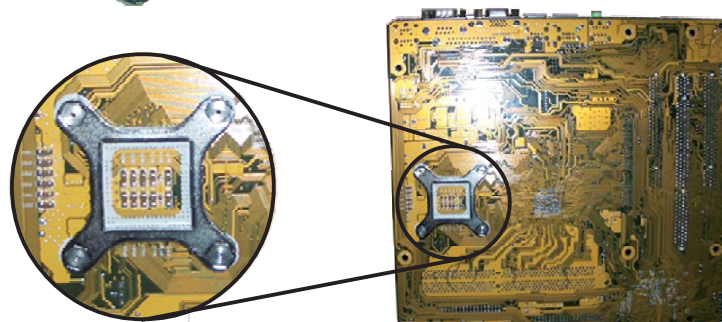
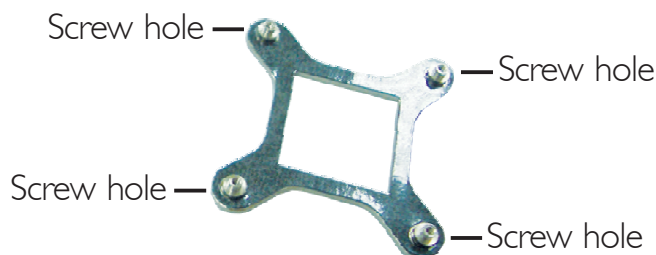

Bottom view of the system board

2. Place the heat sink on top of the CPU. The 4 screws around the heat sink must match the screw holes of the retention module base. Refer to the figure below for the correct position of the heat sink. This is important so that the fan / heat sink will provide adequate cooling to the components of the system board.

Turn each Phillips head screw half way down first to initially stabilize the heat sink onto the system board, then finally tighten each screw.



**Important:**

*Do not turn the first screw all the way down followed by the next and so on. This is to avoid imbalance which might cause cracks or fractures to the CPU and/or heat sink assembly.*

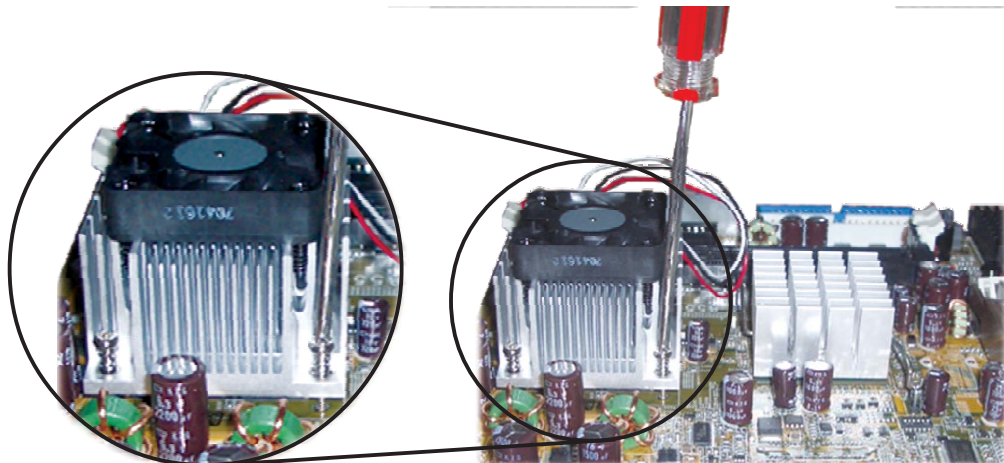

## 2.4 Jumper Settings

### 2.4.1 Clear CMOS Data

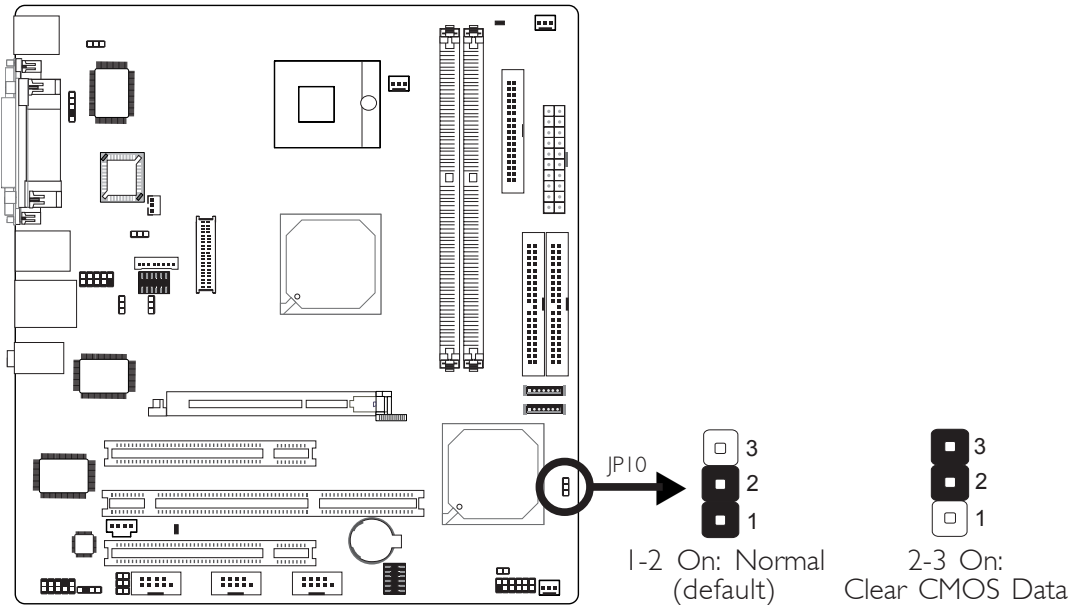

If you encounter the following,

- a) CMOS data becomes corrupted.
- b) You forgot the supervisor or user password.

you can reconfigure the system with the default values stored in the ROM BIOS.

To load the default values stored in the ROM BIOS, please follow the steps below.

1. Power-off the system and unplug the power cord.
2. Set JPI0 pins 2 and 3 to On. Wait for a few seconds and set JPI0 back to its default setting, pins 1 and 2 On.
3. Now plug the power cord and power-on the system.

## 2.4.2 PS/2 Power Select

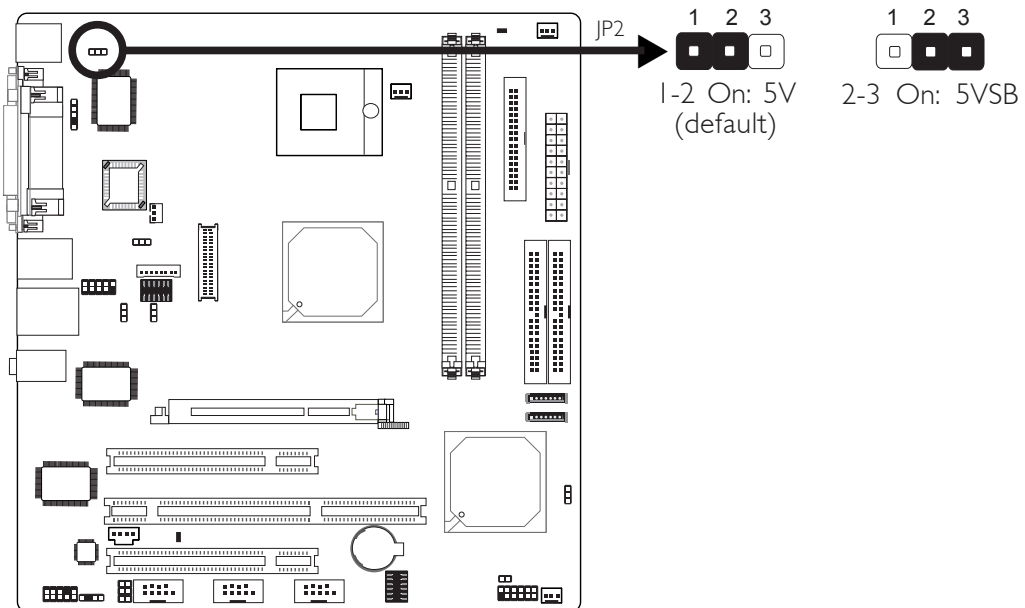

JP2 is used to select the power of the PS/2 keyboard/mouse port. Selecting 5VSB will allow you to use the PS/2 keyboard or PS/2 mouse to wake up the system.

### BIOS Setting

Configure the PS/2 keyboard/mouse wake up function in the Integrated Peripherals submenu (“Super IO Device” section) of the BIOS. Refer to chapter 3 for more information.

**Important:**

*The 5VSB power source of your power supply must support  $\geq 720\text{mA}$ .*



### 2.4.3 USB Power Select

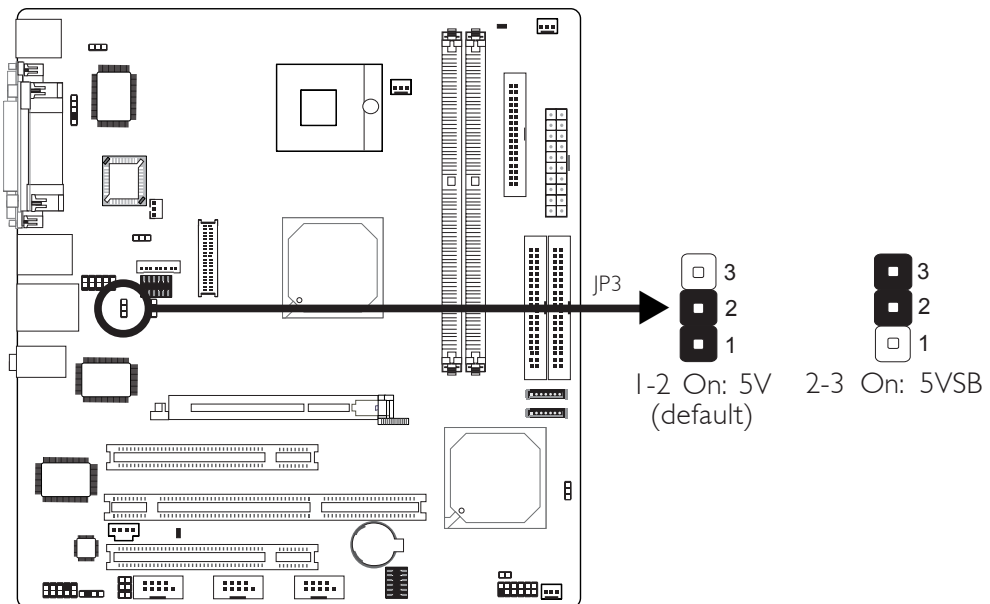

JP3 is used to select the power of the USB ports. Selecting 5VSB will allow you to use the USB keyboard or USB mouse to wake up the system.

#### BIOS Setting

“USB KB Wake-Up From S3” in the Power Management Setup submenu of the BIOS must be set to Enabled. Refer to chapter 3 for more information.



#### Important:

- If you are using the Wake-On-USB Keyboard/Mouse function for 2 USB ports, the 5VSB power source of your power supply must support  $\geq 1.5A$ .
- If you are using the Wake-On-USB Keyboard/Mouse function for 3 or more USB ports, the 5VSB power source of your power supply must support  $\geq 2A$ .

## 2.4.4 LCD/Inverter Settings

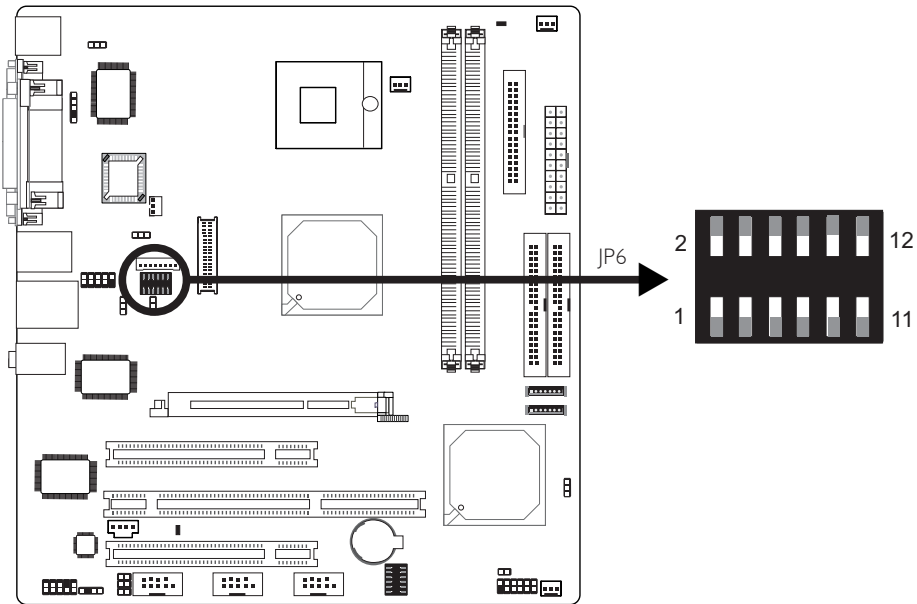

JP6 is used to select the power supplied to the LCD panel and to select the inverter's on/off level.

#### LCD Panel Power Select

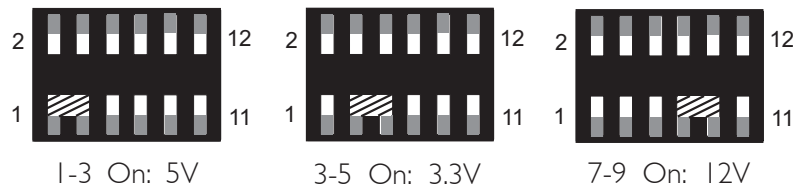

#### Inverter On/Off Level Select

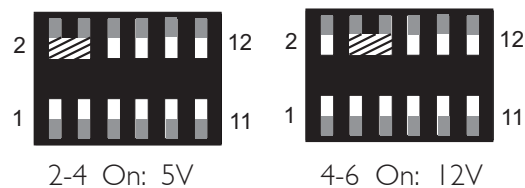

#### Important:

Before powering-on the system, make sure JP6's setting matches the LCD panel's specification. Selecting the incorrect voltage will seriously damage the LCD panel.

### 2.4.5 LCD Brightness Control (Voltage Level Adjust)

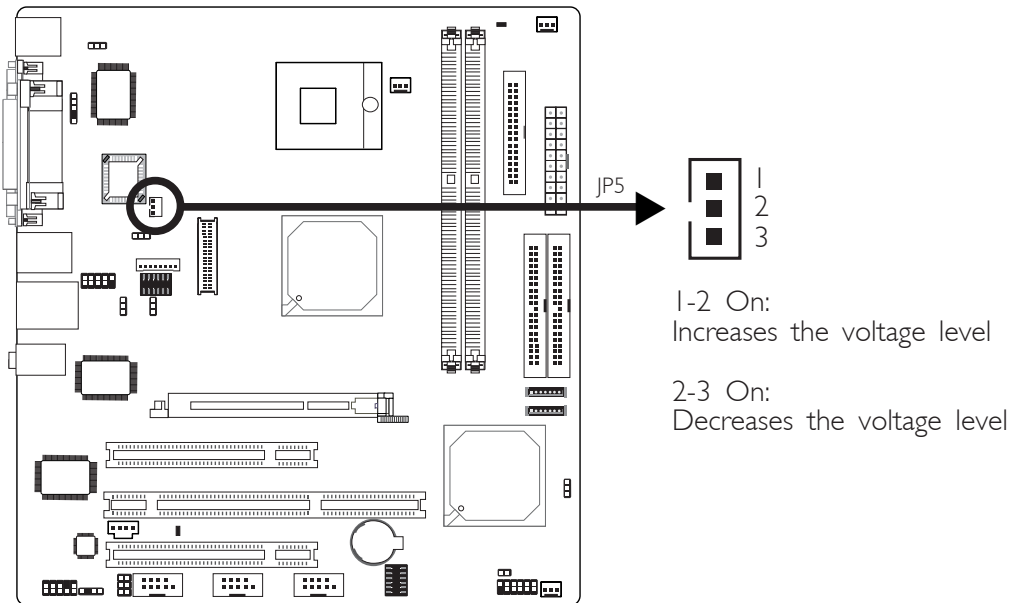

Use JP5 to connect to the LCD Brightness Control button of the LCD Display Panel. It is used to adjust the brightness of the LCD Display Panel. Increasing or decreasing the voltage to control the LCD panel's brightness varies among Inverters. You must refer to the Inverter's specification to make the appropriate adjustment to the brightness of the LCD panel.

## 2.4.6 COM 4 RS232/RS485/AUX Select

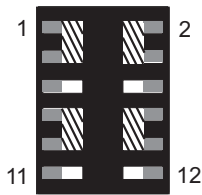
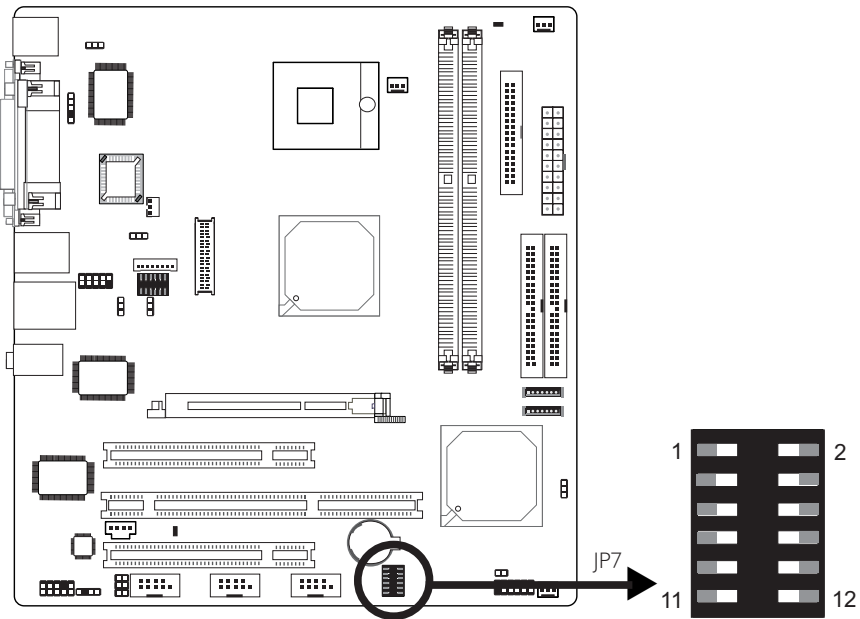

1-3, 2-4, 7-9, 8-10 On:  
RS232  
(default)

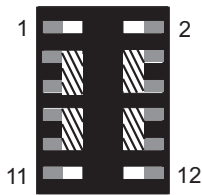

3-5, 4-6, 7-9, 8-10 On:  
RS485

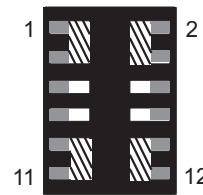

1-3, 2-4, 9-11 (12V),  
10-12 (5V) On:  
Auxiliary power

JP7 is used to set COM 4 to RS-232 or RS-485. If the serial device connected to this port requires 5V/12V power from the system board, set JP7 pins 1-3, 2-4, 9-11 and 10-12 to On. This setting automatically sets COM 4 at RS-232.

## 2.4.7 COM 2 RS232/AUX Select

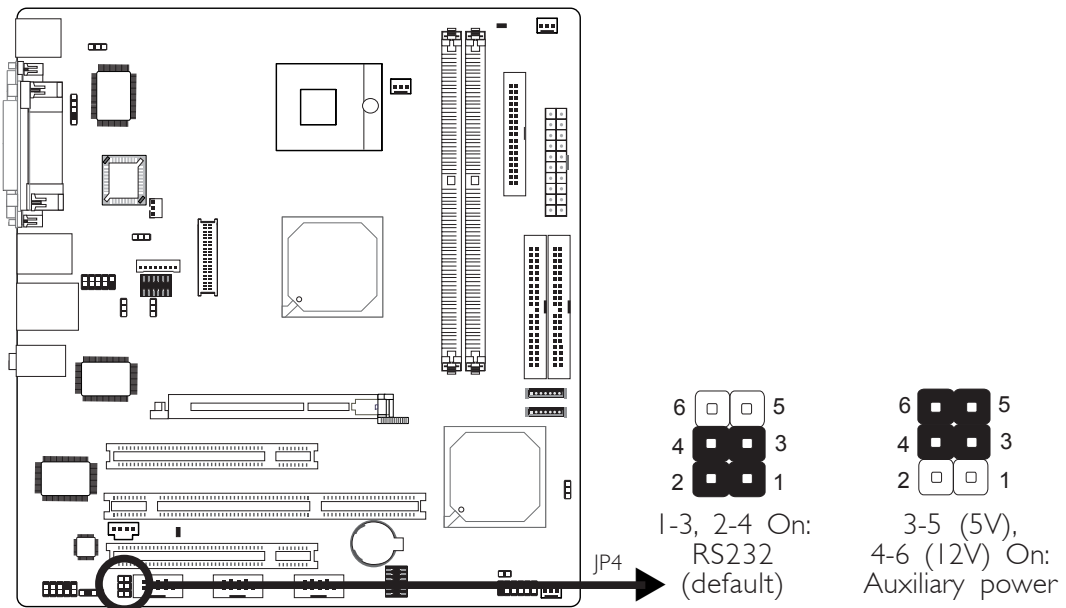

COM 2 is an RS-232 port. If the serial device connected to this port requires 5V/12V power from the system board, set JP4 pins 3-5 and 4-6 to On. Otherwise, leave this jumper's setting at 1-3, 2-4 On.

## 2.4.8 Auto Power-on

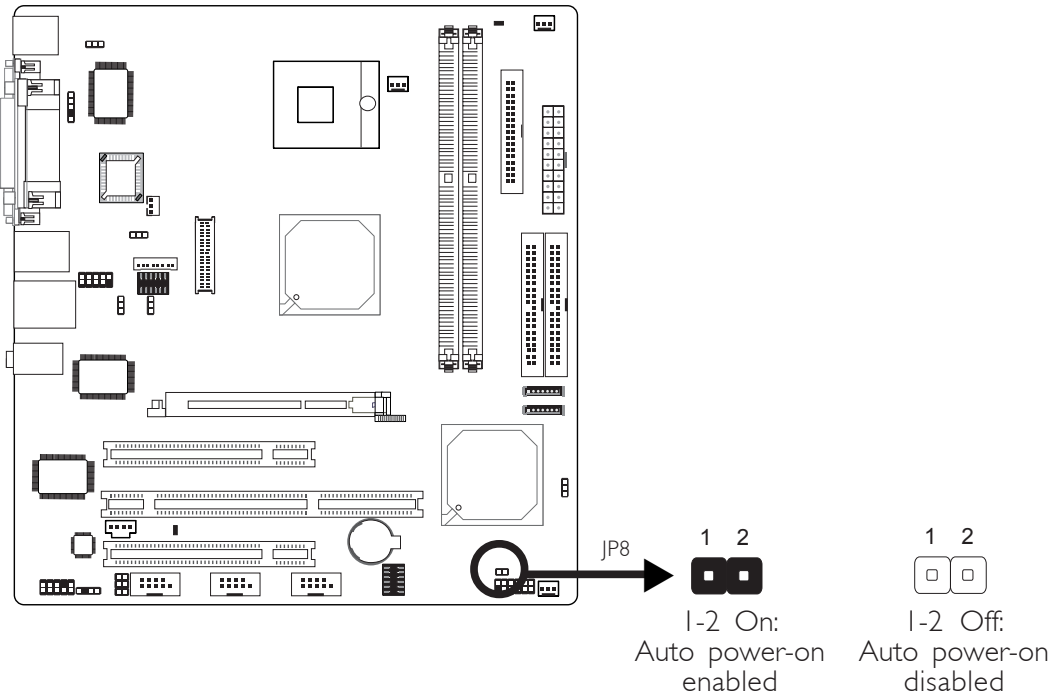

If you want the system to automatically power-on once AC power comes in, set JP8 pins 1 and 2 to On.

### 2.4.9 LVDS to TTL Voltage Select

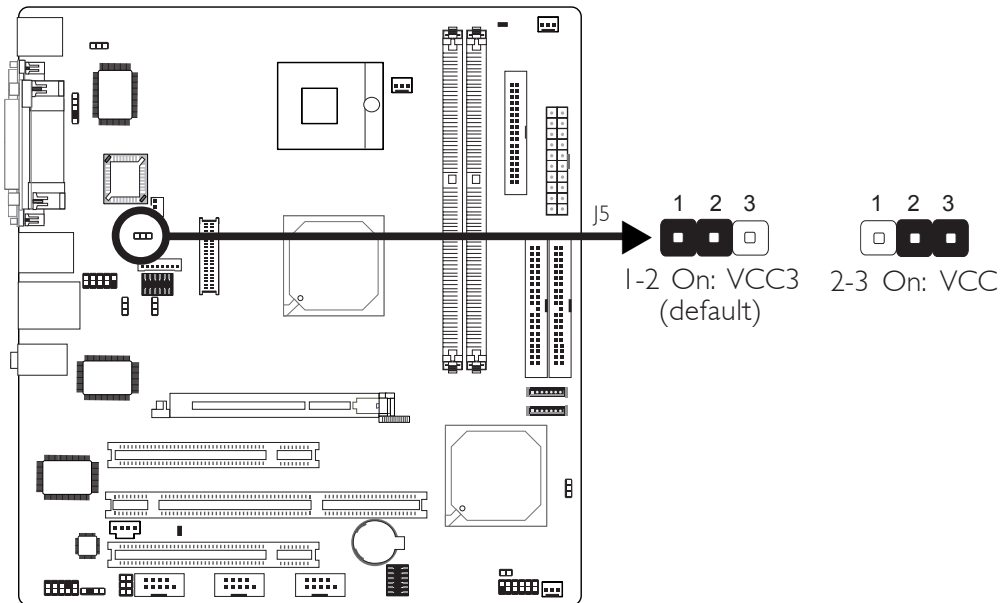

If your system is installed with a LVDS-to-TTL daughterboard, use J5 to select the voltage supplied to the TTL daughterboard.

## 2.4.10 CPU FSB Select

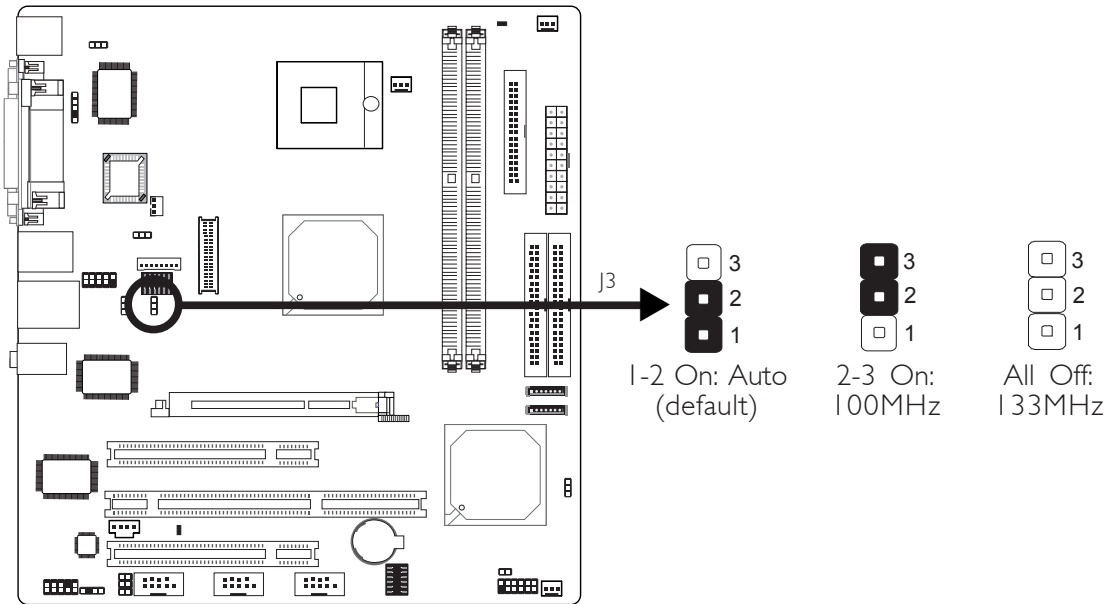

J3 is used to select the front side bus of the CPU installed on the system board. The default setting is Auto. The system will run according to the front side bus of the CPU installed on the system board. You can also set the FSB fixed at 400MHz (100MHz) or 533MHz (133MHz).

**Important:**

- *If you are using a CPU whose frequency has been locked by the manufacturer, overclocking will have no effect.*
- *Overclocking may result to the CPU's or system's instability and are not guaranteed to provide better system performance. If you are unable to boot your system due to overclocking, make sure to set this jumper back to its default settings.*



## 2.5 Rear Panel I/O Ports

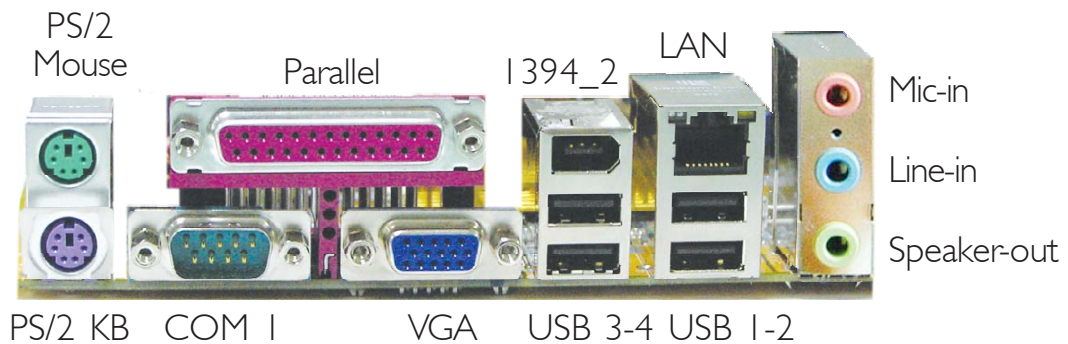

The rear panel I/O ports consist of the following:

- PS/2 mouse port
- PS/2 keyboard port
- Parallel port
- COM 1 port
- VGA port
- I394\_2 port
- LAN port
- USB ports
- Mic-in jack
- Line-in jack
- Speaker-out jack

### 2.5.1 PS/2 Mouse and PS/2 Keyboard Ports

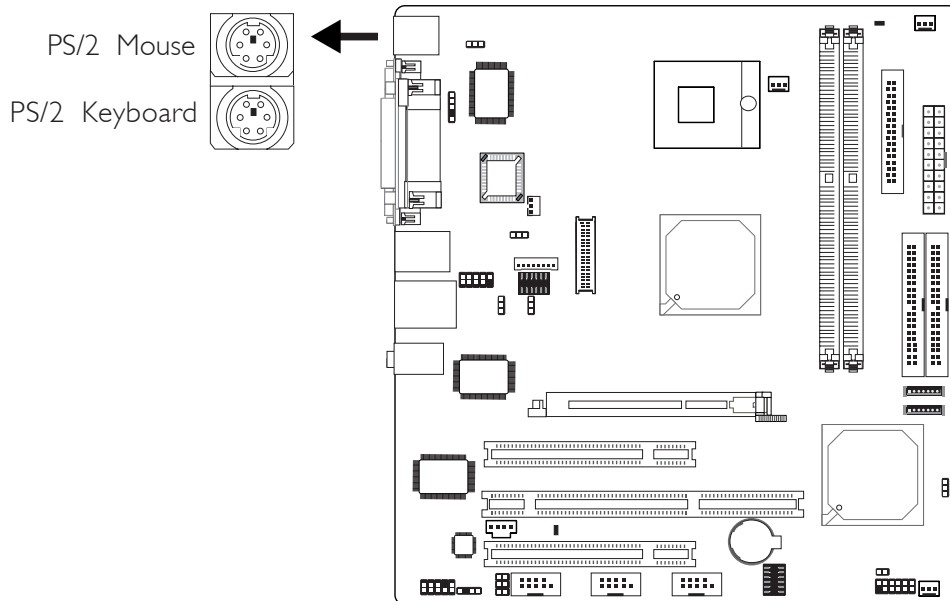

The system board is equipped with an onboard PS/2 mouse (Green) and PS/2 keyboard (Purple) ports - both at location CN1 of the system board. The PS/2 mouse port uses IRQ12. If a mouse is not connected to this port, the system will reserve IRQ12 for other expansion cards.



#### **Warning:**

*Make sure to turn off your computer prior to connecting or disconnecting a mouse or keyboard. Failure to do so may damage the system board.*

#### Wake-On-PS/2 Keyboard/Mouse

The Wake-On-PS/2 Keyboard/Mouse function allows you to use the PS/2 keyboard or PS/2 mouse to power-on the system. To use this function:

- **Jumper Setting:**  
JP2 must be set to "2-3 On: 5VSB". Refer to "PS/2 Power Select" in this chapter for more information.

- **BIOS Setting:**

Configure the PS/2 wake up function in the Integrated Peripherals submenu (“Super IO Device” section) of the BIOS. Refer to chapter 3 for more information.



**Important:**

*The 5VSB power source of your power supply must support  $\geq 720\text{mA}$ .*

## 2.5.2 Serial Ports

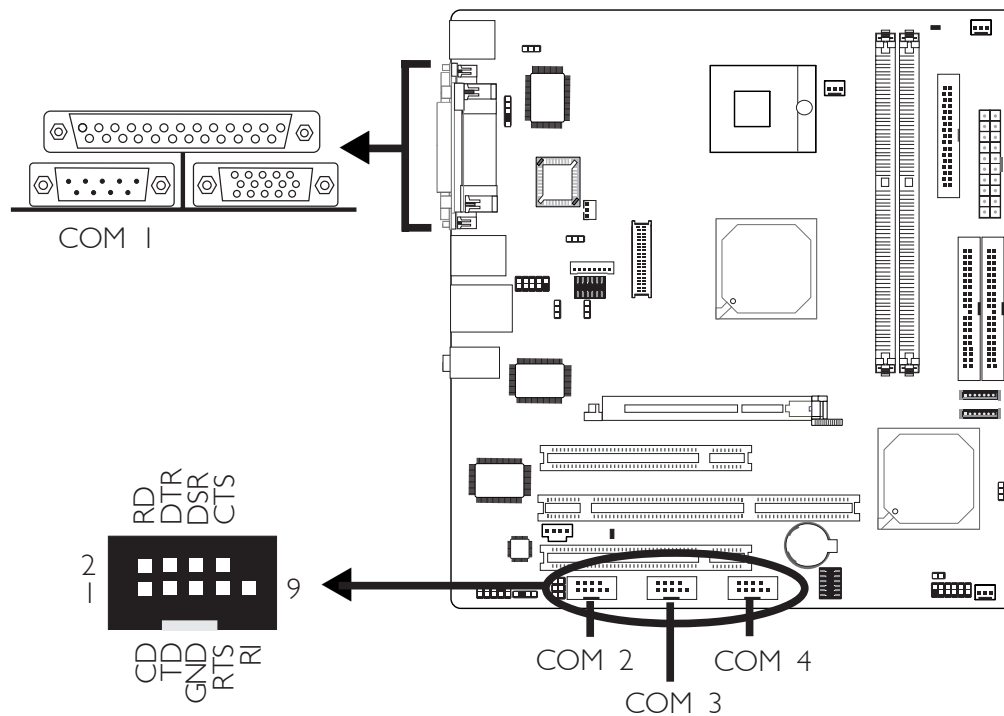

The system board is equipped with an onboard serial port at location CN4 (COM 1). It is also equipped with three 9-pin connectors at locations J6 (COM 2), J7 (COM 3) and J8 (COM 4). These serial ports are RS-232 and/or RS-485 (COM 4 only) asynchronous communication ports with 16C550A-compatible UARTs that can be used with modems, serial printers, remote display terminals, and other serial devices.

To connect COM 2, COM 3 and/or COM 4, please refer to the following description. The serial ports may be mounted on a card-edge bracket. Install the card-edge bracket to the system chassis then insert the cable connector to J6, J7 or J8. Make sure the colored stripe on the ribbon cable is aligned with pin 1 of J6, J7 or J8.

**Important:**

*If the LCD Display Panel that is connected to the LVDS LCD Panel connector supports touch screen, DO NOT connect a serial device to COM 3 because the touch screen function is internally connected to COM 3.*

### Jumper Setting

If the serial device connected to COM 2 and/or COM 4 requires auxiliary power from the system board, set JP4 and/or JP7 appropriately. Refer to “COM 2 RS232/AUX Select” and “COM 4 RS232/RS485/AUX Select” in this chapter for more information.

### BIOS Setting

Configure the serial ports in the Integrated Peripherals submenu (“Super IO Device” section) of the BIOS. Refer to chapter 3 for more information.

## 2.5.3 Parallel Port

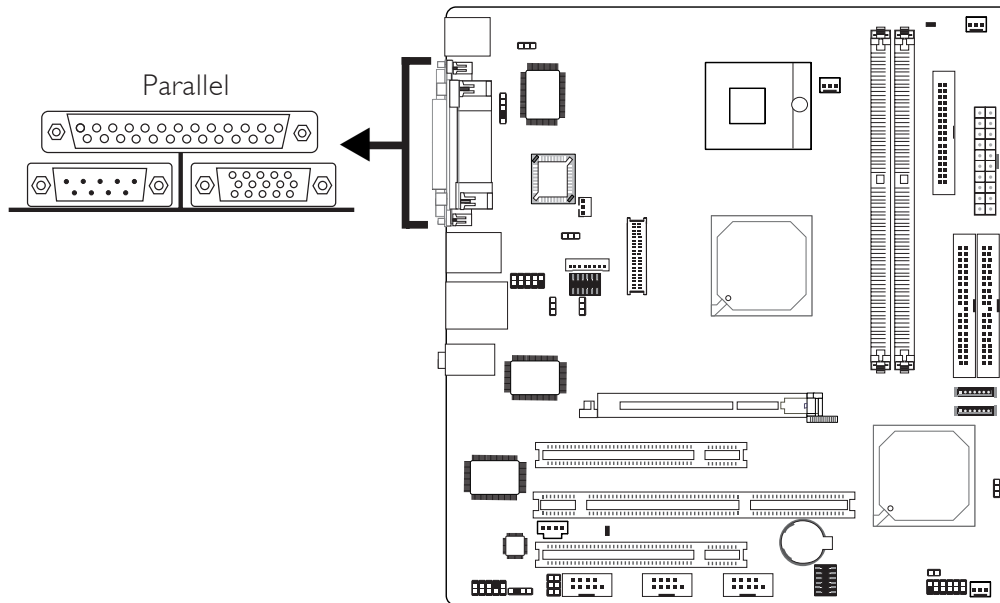

The system board has a standard parallel port (Burgundy) at location CN7 for interfacing your PC to a parallel printer. It supports SPP, ECP and EPP.

Setting	Function
SPP (Standard Parallel Port)	Allows normal speed operation but in one direction only.
ECP (Extended Capabilities Port)	Allows parallel port to operate in bidirectional mode and at a speed faster than the SPP's data transfer rate.
EPP (Enhanced Parallel Port)	Allows bidirectional parallel port operation at maximum speed.

### BIOS Setting

Select the parallel port's mode in the Integrated Peripherals submenu ("Super IO Device" section) of the BIOS. Refer to chapter 3 for more information.

## 2.5.4 VGA Port

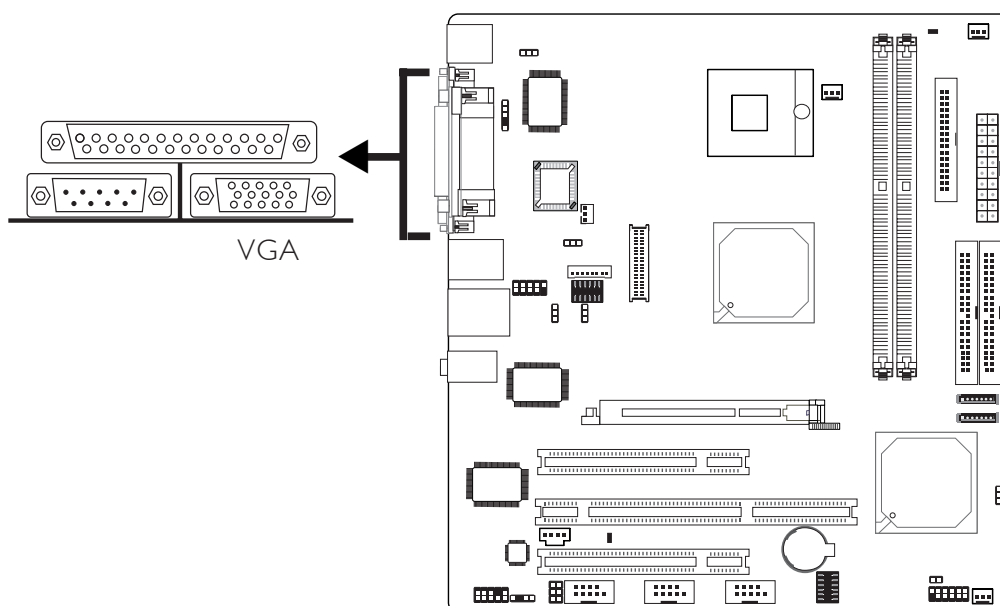

The system board can only be used with an analog video monitor. Connect the monitor's 15-pin D-shell cable connector to the VGA port (Blue) at location CN2. If your monitor supports analog video but does not have a 15-pin D-shell connector, see your monitor dealer for the adapter or optional cable. After you plug the monitor cable into the VGA port, gently tighten the cable screws to hold the connector in place. Some monitors have a switch that chooses between analog and TTL (or digital) operation. If your monitor has such a switch, set it for analog.

### BIOS Setting

Configure the onboard VGA in the Advanced Chipset Features submenu of the BIOS.

### Driver Installation

Install the "Intel Graphics Drivers". Refer to chapter 4 for more information.

## 2.5.5 IEEE 1394

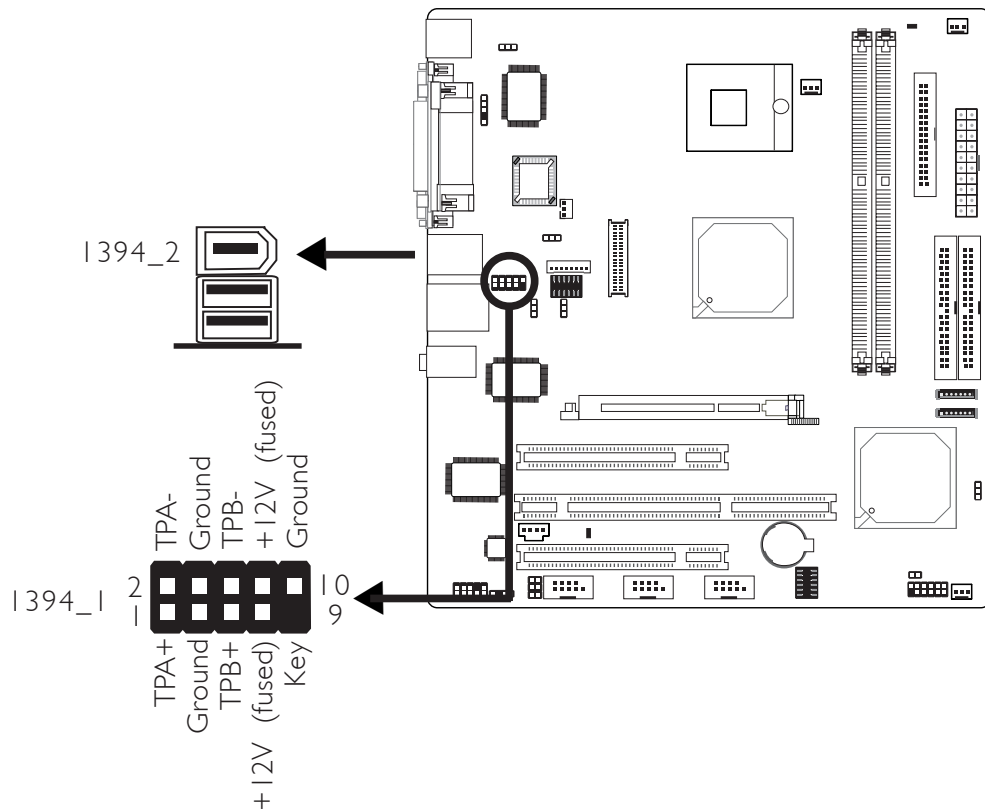

The system board is equipped with an onboard IEEE 1394 port at location CN6 (IEEE 1394\_2) of the system board.

It is also equipped with an IEEE 1394 connector at location I394\_1 for connecting an additional 1394 device. The 1394 port may come mounted on a card-edge bracket. Install the card-edge bracket to the system chassis then insert the connector that is attached to the 1394 port cable to I394\_1. Make sure pin 1 of the cable connector is aligned with pin 1 of the I394\_1. You can now connect an IEEE 1394 device to the port.



## 2.5.6 RJ45 Fast-Ethernet Port

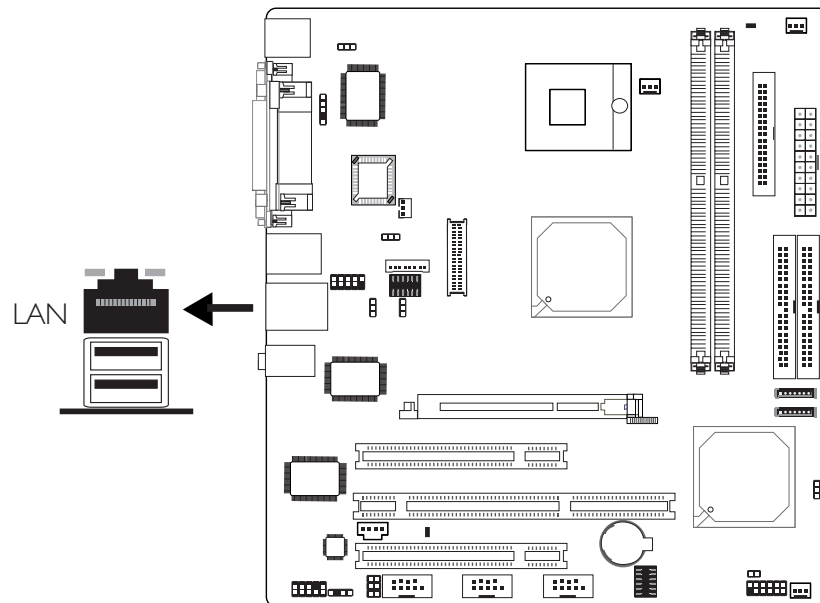

The system board is equipped with an onboard RJ45 LAN port at location CN5. This port allows the system board to connect to a local area network by means of a network hub.

### BIOS Setting

Enable or disable the onboard LAN in the Integrated Peripherals submenu (“Onboard Device” section) of the BIOS. Refer to chapter 3 for more information.

### Driver Installation

Install the “LAN Drivers”. Refer to chapter 4 for more information.

## 2.5.7 Universal Serial Bus Connectors

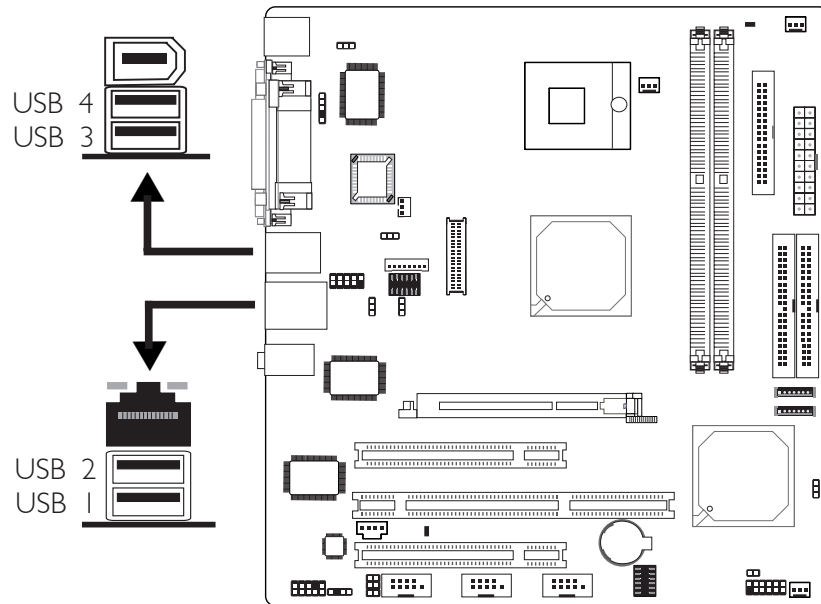

The system board supports 4 onboard USB 2.0/1.1 ports (Black) at locations CN5 and CN6 for USB 1-2 and USB 3-4 respectively.

USB allows data exchange between your computer and a wide range of simultaneously accessible external Plug and Play peripherals.

### BIOS Setting

Configure the onboard USB in the Integrated Peripherals submenu (“Onboard Device” section) of the BIOS. Refer to chapter 3 for more information.

### Driver Installation

You may need to install the proper drivers in your operating system to use the USB device. Refer to your operating system’s manual or documentation for more information.

If you are using a USB 2.0 device, install the “Intel USB 2.0 Drivers”. Refer to chapter 4 for more information.

### Wake-On-USB Keyboard/Mouse

The Wake-On-USB Keyboard/Mouse function allows you to use a USB keyboard or USB mouse to wake up a system from the S3 (STR - Suspend To RAM) state. To use this function:

- **Jumper Setting:**  
JP3 must be set to “2-3 On: 5VSB”. Refer to “USB Power Select” in this chapter for more information.
- **BIOS Setting:**  
“USB KB Wake-Up From S3” in the Power Management Setup submenu of the BIOS must be set to Enabled. Refer to chapter 3 for more information.



#### **Important:**

- *If you are using the Wake-On-USB Keyboard/Mouse function for 2 USB ports, the 5VSB power source of your power supply must support  $\geq 1.5A$ .*
- *If you are using the Wake-On-USB Keyboard/Mouse function for 3 or more USB ports, the 5VSB power source of your power supply must support  $\geq 2A$ .*

## 2.5.8 Audio (Rear Audio and Front Audio)

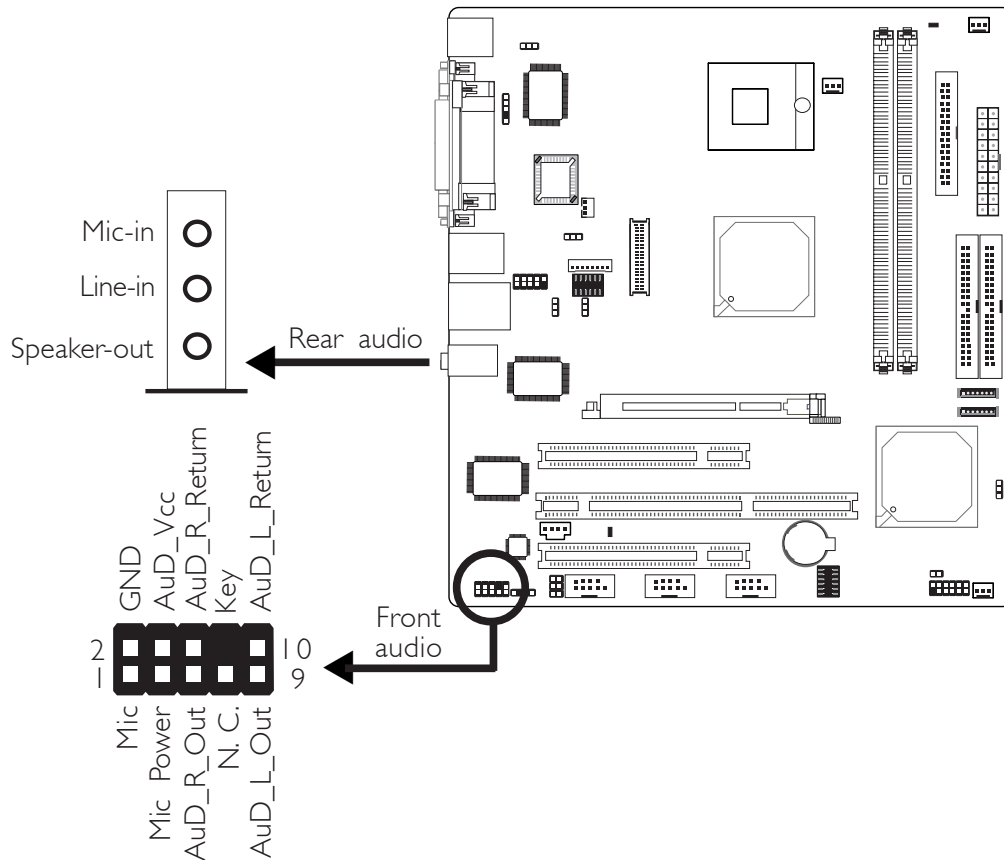
**Rear Audio**

The system board is equipped with 3 audio jacks at location CN3. A jack is a one-hole connecting interface for inserting a plug.

**Mic-in Jack (Pink)**

This jack is used to connect an external microphone.

**Line-in Jack (Light Blue)**

This jack is used to connect any audio devices such as Hi-fi set, CD player, tape player, AM/FM radio tuner, synthesizer, etc.

**Speaker-out Jack (Lime)**

This amplified jack is used to connect external speakers for audio output from the system board.

## Front Audio

The front audio connector (J1) allows you to connect to the line-out and mic-in jacks that are at the front panel of your system. Using the line-out and mic-in jacks will disable the rear audio's line-out and mic-in functions.

Remove the jumper caps from pins 5-6 and pins 9-10 of J1 prior to connecting the front audio cable connector. Make sure pin 1 of the cable connector is aligned with pin 1 of J1. If you are not using this connector, make sure to replace the jumper caps back to their original pin locations.

Pins 5-6 and 9-10 short (default)	The front audio is disabled. The rear audio is enabled.
Pins 5-6 and 9-10 open	The front audio is enabled. The rear audio is disabled.

## Driver Installation

Install the "Audio Drivers". Refer to chapter 4 for more information.

## 2.6 I/O Connectors

### 2.6.1 CD-in Internal Audio Connector

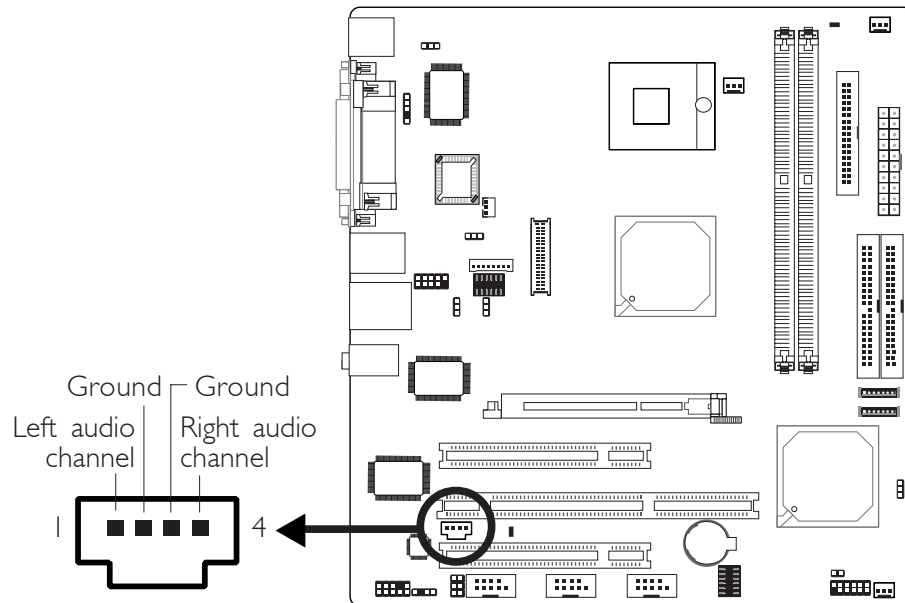

The CD-in connector is used to receive audio from a CD-ROM drive, TV tuner or MPEG card.

## 2.6.2 S/PDIF-out Connector

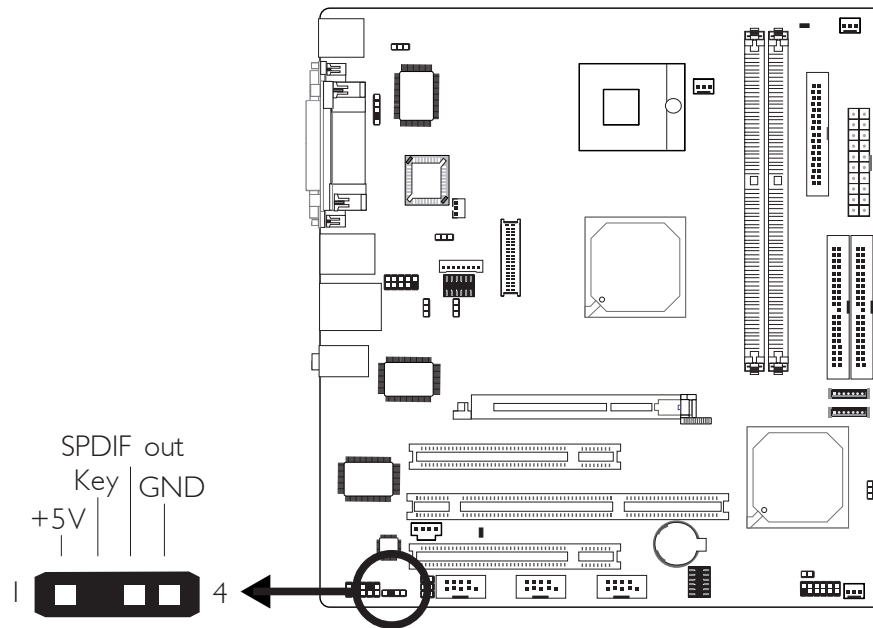

The S/PDIF-out connector is used to connect an external S/PDIF-out port. Your S/PDIF-out port may be mounted on a card-edge bracket. Install the card-edge bracket to the system chassis then connect the audio cable connector to SPDIF1. Make sure pin 1 of the audio cable connector is aligned with pin 1 of SPDIF1.

### 2.6.3 LVDS LCD Panel Connector and LCD/Inverter Power Connector

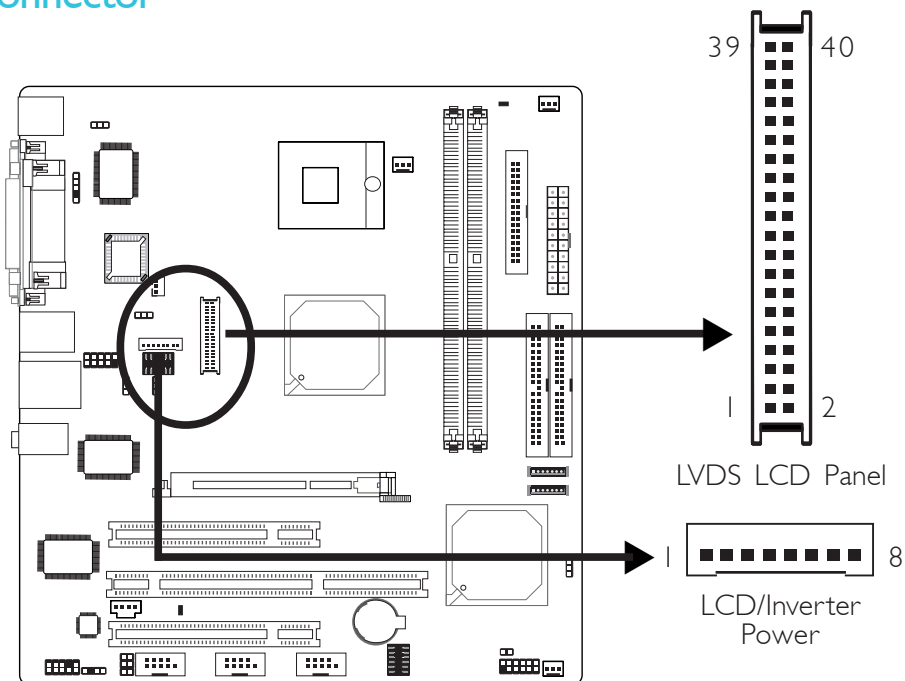

The system board allows you to connect a LCD Display Panel by means of the LVDS LCD panel connector (CN9) and the LCD/ Inverter power connector (CN8). These connectors transmit video signals and power from the system board to the LCD Display Panel. Refer to the next page for the pin functions of these connectors.

#### Jumper Settings

Refer to the “Jumper Settings” section in this chapter for settings relevant to the LCD panel.



## LVDS LCD Panel Connector

Pins	Function	Pins	Function
1	GND	2	GND
3	LVDS_Out3+	4	LVDS_Out7+
5	LVDS_Out3-	6	LVDS_Out7-
7	GND	8	GND
9	LVDS_Out2+	10	LVDS_Out6+
11	LVDS_Out2-	12	LVDS_Out6-
13	GND	14	GND
15	LVDS_Out1+	16	LVDS_Out5+
17	LVDS_Out1-	18	LVDS_Out5-
19	GND	20	GND
21	LVDS_Out0+	22	LVDS_Out4+
23	LVDS_Out0-	24	LVDS_Out4-
25	GND	26	GND
27	LVDS_CLK1+	28	LVDS_CLK2+
29	LVDS_CLK1-	30	LVDS_CLK2-
31	GND	32	GND
33	COM3_DTR	34	COM3_TD
35	COM3_RTS	36	COM3_RI
37	COM3_RD	38	COM3_DSR
39	COM3_CTS	40	COM3_DCD

## LCD/Inverter Power Connector

Pins	Function	Pins	Function
1	+12V	5	Panel Power
2	+12V	6	Panel Inverter Brightness Voltage Control
3	Panel Backlight On/Off Control	7	GND
4	+3.3V/+5V	8	GND

**Note:**

Jumper J5 is used to select the voltage supplied to the TTL daughterboard. Pin 4 of the LCD/Inverter power connector will depend on the voltage selected on J5.

## 2.6.4 Floppy Disk Drive Connector

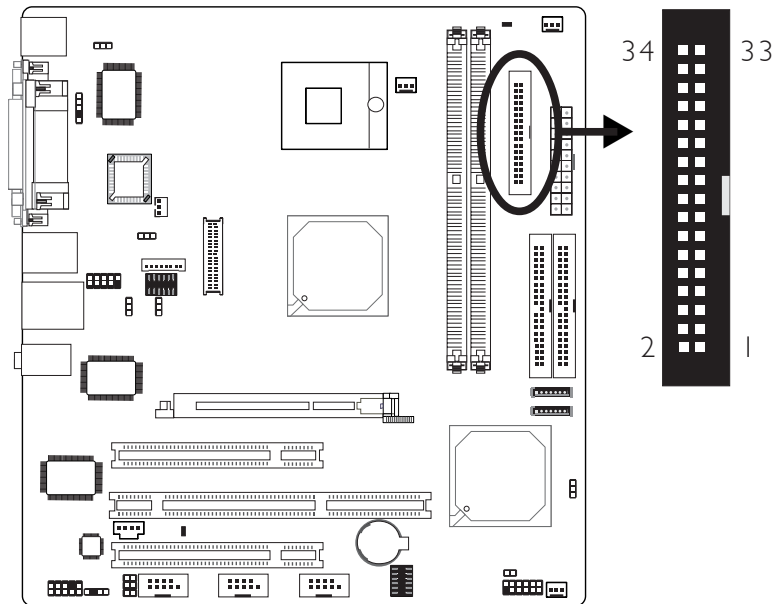

The system board is equipped with a shrouded floppy disk drive connector for connecting a standard floppy disk drive. To prevent improper floppy cable installation, the shrouded floppy disk header has a keying mechanism. The 34-pin connector on the floppy cable can be placed into the header only if pin 1 of the connector is aligned with pin 1 of the header.

### Connecting the Floppy Disk Drive Cable

Install one end of the floppy disk drive cable into the shrouded floppy disk header (J13) on the system board and the other end-most connector to the floppy drive. The colored edge of the daisy chained ribbon cable should be aligned with pin 1 of J13.

### BIOS Setting

Enable or disable this function in the Integrated Peripherals submenu (“Super IO Device” field) of the BIOS. Refer to chapter 3 for more information.

## 2.6.5 Serial ATA Connectors

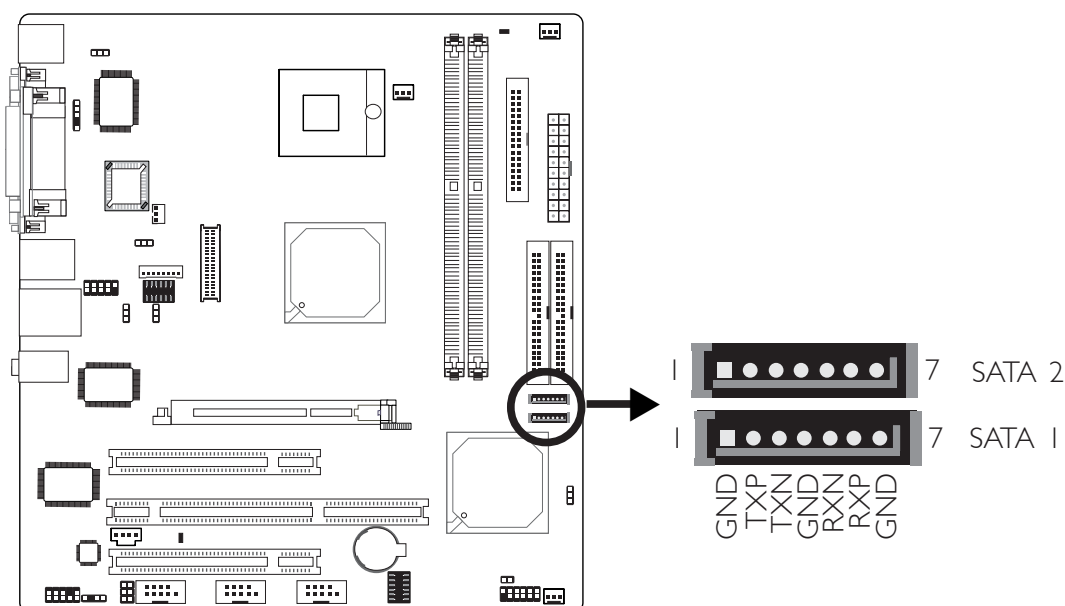

The system board is equipped with two Serial ATA connectors for connecting Serial ATA devices. Connect one end of the Serial ATA cable to J15 (SATA 1) or J14 (SATA 2) and the other end to your Serial ATA device.

### Configuring RAID on Serial ATA Drives

The Intel 6300ESB south bridge chip allows configuring RAID on Serial ATA drives. It supports RAID 0 and RAID 1. The following must be set accordingly.

1. Set the "On-Chip Serial ATA" field to "Enhanced Mode". (Integrated Peripherals submenu - OnChip IDE Device" section of the Award BIOS.)
2. Set the "SATA Mode" field to "RAID". (Integrated Peripherals submenu - OnChip IDE Device" section of the Award BIOS.)
3. Reboot the PC.
4. When the system powers-up, press the <Ctrl> and <I> keys simultaneously to run the Intel RAID BIOS Setting Utility. The utility is used to configure the Serial ATA drives to RAID 0 or RAID 1.

# 2

## Hardware Installation

5. Install the Intel 6300ESB RAID driver:

For steps 1 to 4, refer to chapter 3 for more information. For step 5, refer to chapter 4 for more information.

## 2.6.6 IDE Disk Drive Connectors

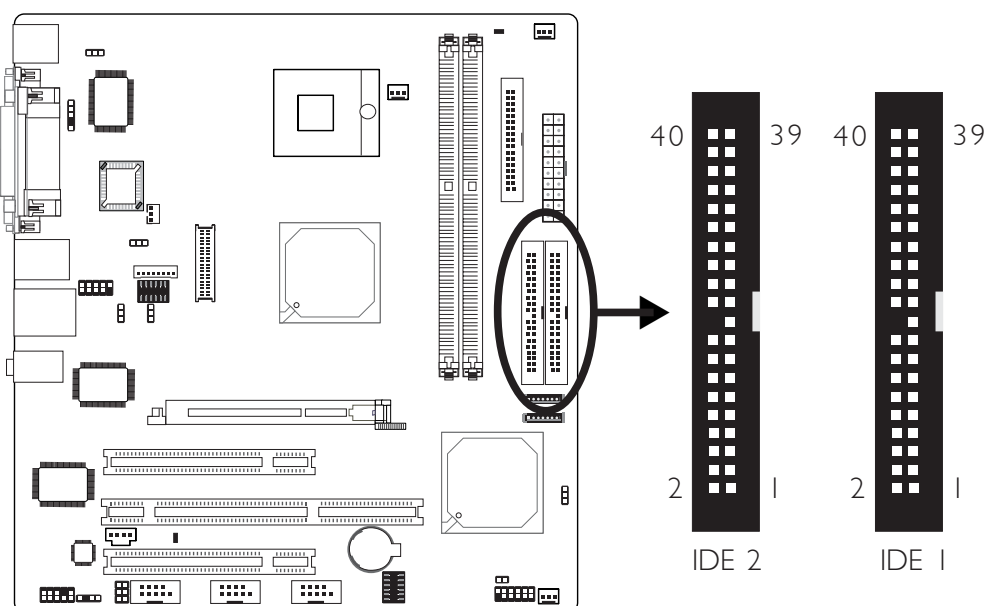

The system board is equipped with two shrouded PCI IDE headers that will interface four Enhanced IDE (Integrated Drive Electronics) disk drives. To prevent improper IDE cable installation, each shrouded PCI IDE header has a keying mechanism. The 40-pin connector on the IDE cable can be placed into the header only if pin 1 of the connector is aligned with pin 1 of the header.

Each IDE connector supports 2 devices, a Master and a Slave. Use an IDE ribbon cable to connect the drives to the system board. An IDE ribbon cable has 3 connectors on them, one that plugs into an IDE connector on the system board and the other 2 connect to IDE devices. The connector at the end of the cable is for the Master drive and the connector in the middle of the cable is for the Slave drive.

### Connecting the IDE Disk Drive Cable

Install one end of the IDE cable into the IDE 1 header on the system board and the other connectors to the IDE devices.

If you are adding a third or fourth IDE device, use another IDE cable and install one end of the cable into the IDE 2 header on the system board and the other connectors to the IDE devices.

### Adding a Second IDE Disk Drive

When using two IDE drives, one must be set as the master and the other as the slave. Follow the instructions provided by the drive manufacturer for setting the jumpers and/or switches on the drives.

The system board supports Enhanced IDE or ATA-2, ATA/33, ATA/66 and ATA/100 hard drives. We recommend that you use hard drives from the same manufacturer. In a few cases, drives from two different manufacturers will not function properly when used together. The problem lies in the hard drives, not the system board.



**Important:**

*If you encountered problems while using an ATAPI CD-ROM drive that is set in Master mode, please set the CD-ROM drive to Slave mode. Some ATAPI CD-ROMs may not be recognized and cannot be used if incorrectly set in Master mode.*

### BIOS Setting

Enable or disable the onboard IDE in the Integrated Peripherals submenu (“OnChip IDE Device” section) of the BIOS. Refer to chapter 3 for more information.

## 2.6.7 IrDA Connector

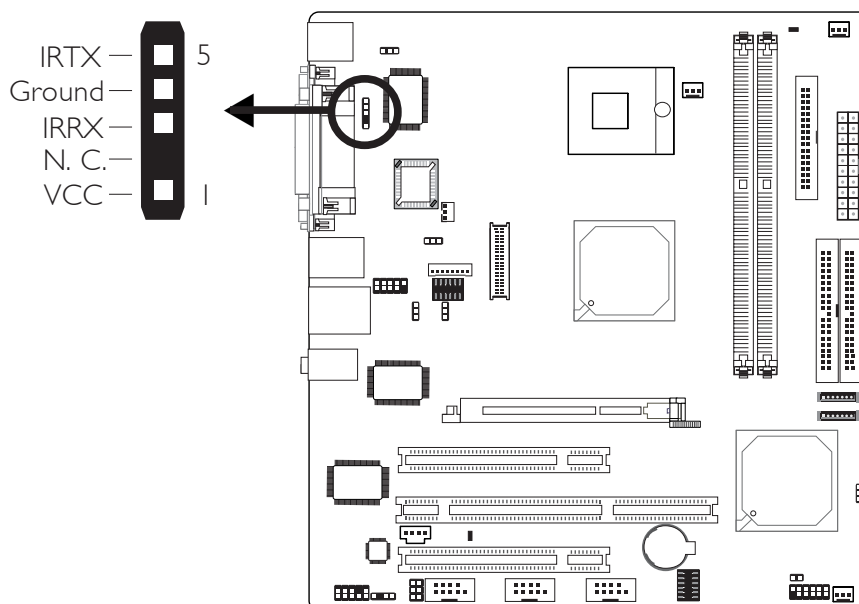

Connect your IrDA cable to connector J2 on the system board.



**Note:**

*The sequence of the pin functions on some IrDA cable may be reversed from the pin function defined on the system board. Make sure to connect the cable to the IrDA connector according to their pin functions.*

### BIOS Setting

Configure the onboard IrDA in the Integrated Peripherals submenu (“Super IO Device” section) of the BIOS to the type of IrDA standard supported by your device.

### Driver Installation

You may need to install the proper drivers in your operating system to use the IrDA function. Refer to your operating system’s manual or documentation for more information.

## 2.6.8 Cooling Fan Connectors

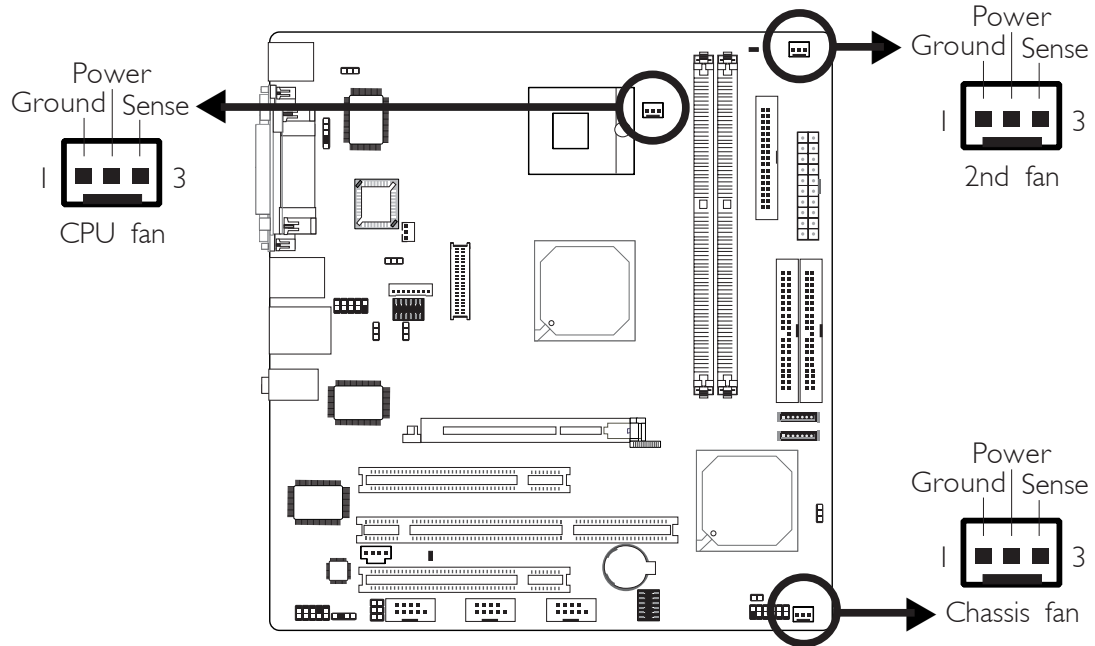

Connect the CPU fan's cable connector to the CPU fan connector (J9) on the system board. The 2nd fan (J16) and chassis fan (J17) connectors are used to connect additional cooling fans. The cooling fans will provide adequate airflow throughout the chassis to prevent overheating the CPU and system board components.

### BIOS Setting

The "PC Health Status" submenu of the BIOS will display the current speed of the cooling fans. Refer to chapter 3 for more information.



## 2.6.9 Power Connectors

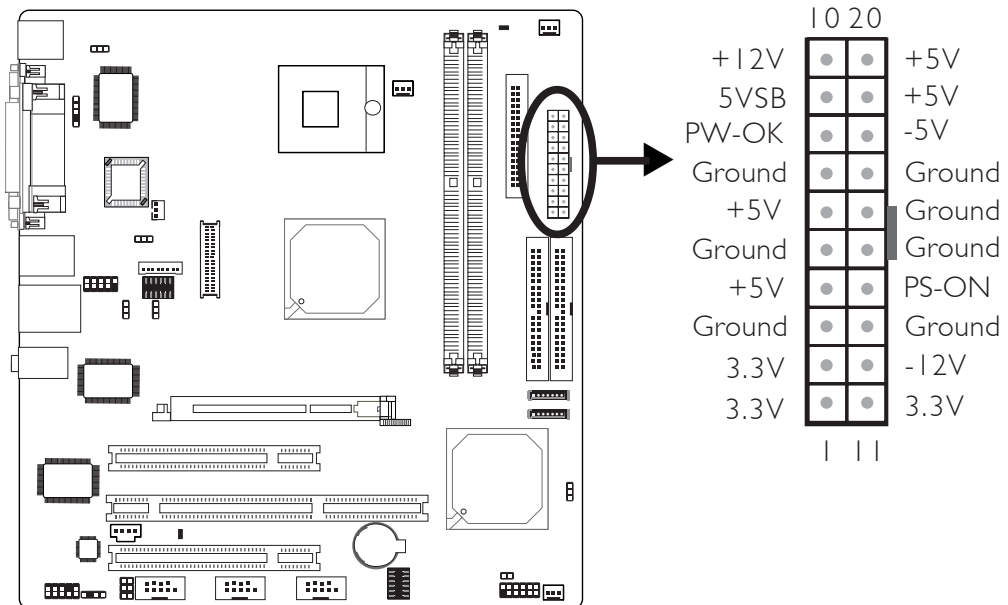

Use a power supply that complies with the ATX12V Power Supply Design Guide Version 1.1. An ATX12V power supply has a standard 20-pin ATX main power connector that must be inserted onto the P2 connector:

The system board requires a minimum of 150 Watt power supply to operate. Your system configuration (amount of memory, add-in cards, peripherals, etc.) may exceed the minimum power requirement. To ensure that adequate power is provided, use a 250 Watt (or greater) power supply.

## 2.6.10 DIMM and PCI Standby Power LEDs

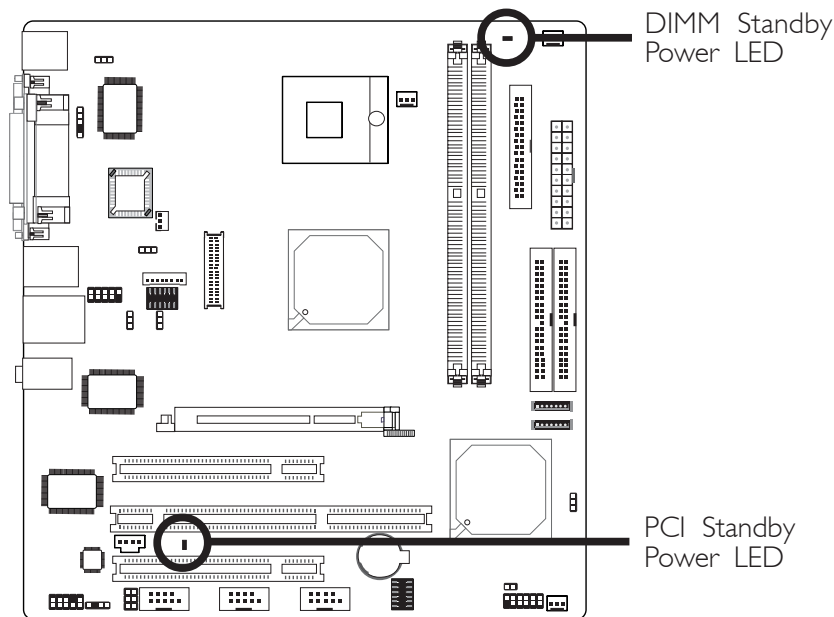

### DIMM Standby Power LED

This LED will turn red when the system's power is on or when it is in the Suspend state (Power On Suspend or Suspend to RAM). It will not light when the system is in the Soft-Off state.

### PCI Standby Power LED

This LED will turn red when the system is in the power-on, Soft-Off or Suspend (Power On Suspend or Suspend to RAM) state.



**Important:**

*If the DIMM Standby Power LED or PCI Standby Power LED is lighted, you must power-off the system then turn off the power supply's switch or unplug the power cord prior to installing any memory modules or add-in cards.*

## 2.6.11 Front Panel Connectors

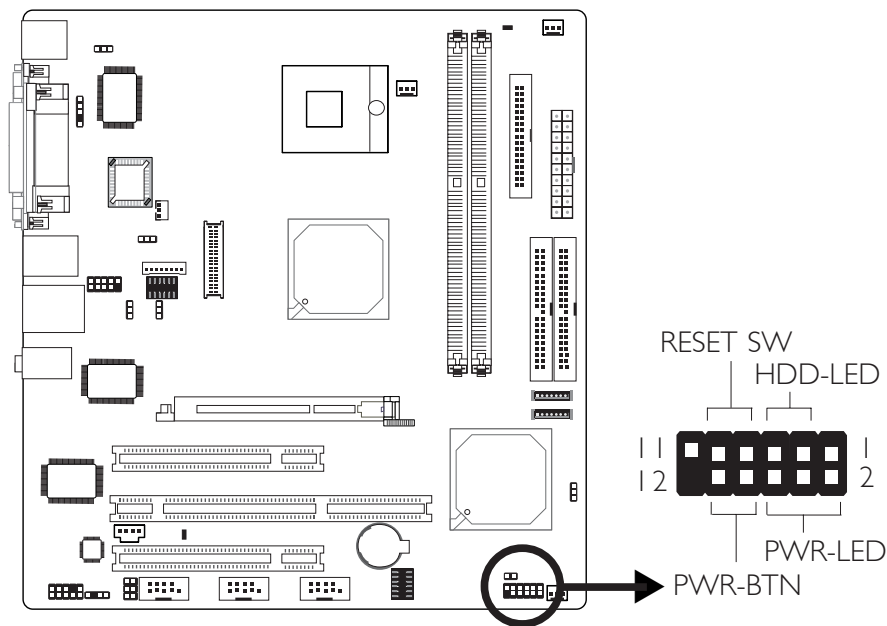

### HDD-LED - HDD LED

This LED will light when the hard drive is being accessed.

### RESET SW - Reset Switch

This switch allows you to reboot without having to power off the system.

### PWR-BTN - Power Switch

This switch is used to power on or off the system.

### PWR-LED - Power/Standby LED

When the system's power is on, this LED will light. When the system is in the S1 (POS - Power On Suspend) state, it will blink every second. When the system is in the S3 (STR - Suspend To RAM) state, it will blink every 4 seconds.

	Pin	Pin Assignment		Pin	Pin Assignment
N. C.	1	N. C.	<b>PWR-LED</b>	2	LED Power
				4	LED Power
				6	Signal
<b>HDD-LED</b>	3	HDD Power	<b>PWR-BTN</b>	8	PWR-BTN Power
	5	Signal		10	Signal
<b>RESET SW</b>	7	Ground			
	9	RST Signal			
N. C.	11	N. C.	<b>Key</b>	12	Key

## Chapter 3 - BIOS Setup

---

### 3.1 Award BIOS Setup Utility

The Basic Input/Output System (BIOS) is a program that takes care of the basic level of communication between the processor and peripherals. In addition, the BIOS also contains codes for various advanced features found in this system board. This chapter explains the Setup Utility for the Award BIOS.

After you power up the system, the BIOS message appears on the screen and the memory count begins. After the memory test, the following message will appear on the screen:

Press DEL to enter setup

If the message disappears before you respond, restart the system or press the "Reset" button. You may also restart the system by pressing the <Ctrl> <Alt> and <Del> keys simultaneously.

When you press <Del>, the main menu screen will appear:

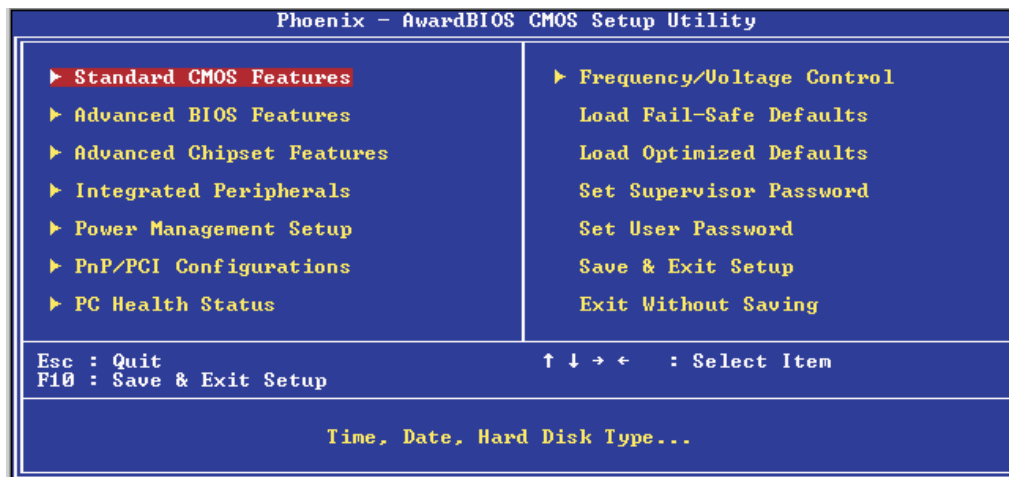

### 3.1.1 Standard CMOS Features

Use the arrow keys to highlight “Standard CMOS Features” and press <Enter>. A screen similar to the one below will appear:

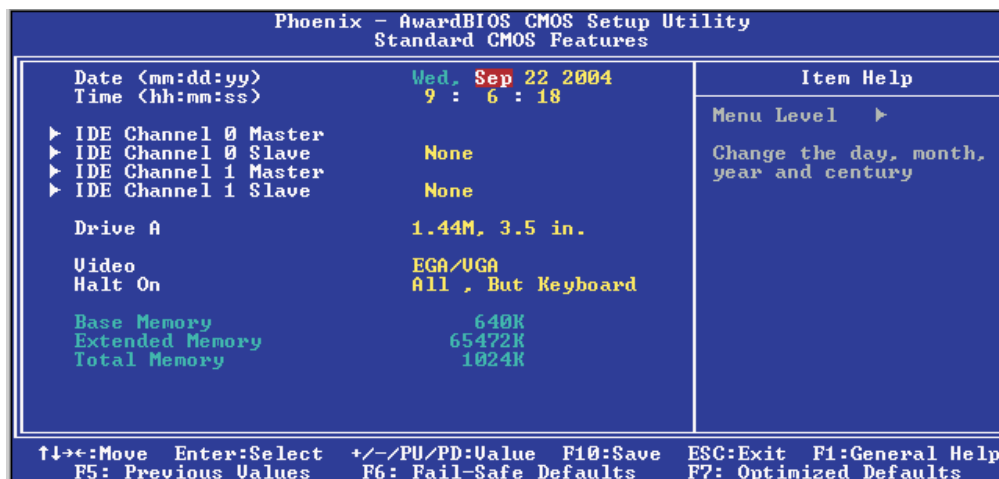

The settings on the screen are for reference only. Your version may not be identical to this one.

#### 3.1.1.1 Date

The date format is <day>, <month>, <date>, <year>. Day displays a day, from Sunday to Saturday. Month displays the month, from January to December. Date displays the date, from 1 to 31. Year displays the year, from 1999 to 2099.

#### 3.1.1.2 Time

The time format is <hour>, <minute>, <second>. The time is based on the 24-hour military-time clock. For example, 1 p.m. is 13:00:00. Hour displays hours from 00 to 23. Minute displays minutes from 00 to 59. Second displays seconds from 00 to 59.

### 3.1.1.3 IDE Channel 0 Master, IDE Channel 0 Slave, IDE Channel 1 Master and IDE Channel 1 Slave

Move the cursor to the “IDE Channel 0 Master”, “IDE Channel 0 Slave”, “IDE Channel 1 Master” or “IDE Channel 1 Slave” field, then press <Enter>.



**Note:**

The fields in this section will vary in accordance to the settings in “On-Chip Serial ATA Setting” (“OnChip IDE Device” section) of the Integrated Peripherals submenu.

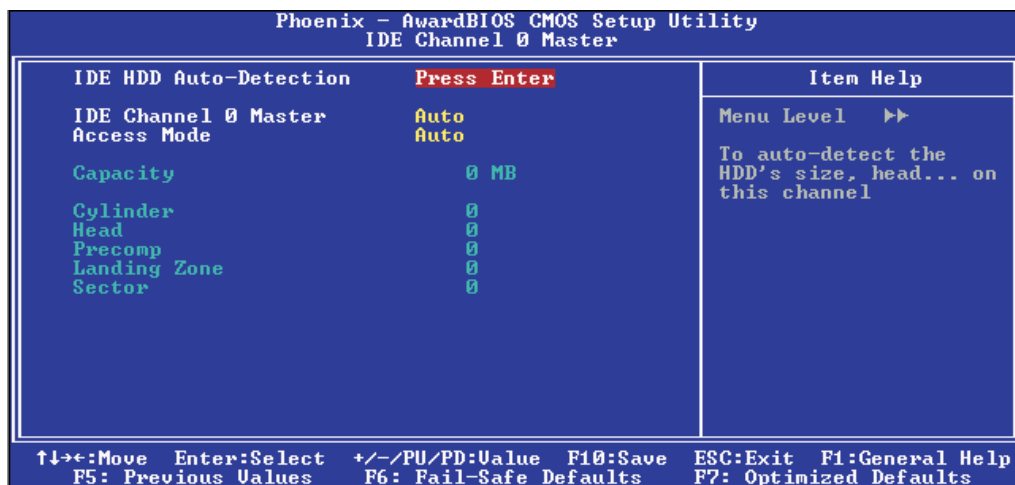

The settings on the screen are for reference only. Your version may not be identical to this one.

#### IDE HDD Auto Detection

Detects the parameters of the drive. The parameters will automatically be shown on the screen.

#### IDE Channel 0 Master/Slave and IDE Channel 1 Master/Slave

The drive type information should be included in the documentation from your hard disk vendor. If you select “Auto”, the BIOS will auto-detect the HDD & CD-ROM drive at the POST stage and show the IDE for the HDD & CD-ROM drive. If a hard disk has not been installed, select “None”.

### Access Mode

For hard drives larger than 528MB, you would typically select the LBA type. Certain operating systems require that you select Normal or Large. Please check your operating system's manual or Help desk on which one to select.

### Capacity

Displays the approximate capacity of the disk drive. Usually the size is slightly greater than the size of a formatted disk given by a disk checking program.

### Cylinder

This field displays the number of cylinders.

### Head

This field displays the number of read/write heads.

### Precomp

This field displays the number of cylinders at which to change the write timing.

### Landing Zone

This field displays the number of cylinders specified as the landing zone for the read/write heads.

### Sector

This field displays the number sectors per track.

#### 3.1.1.4 Drive A

This field identifies the type of floppy disk drive installed.

<i>None</i>	No floppy drive is installed
<i>360K, 5.25 in.</i>	5-1/4 in. standard drive; 360KB capacity
<i>1.2M, 5.25 in.</i>	5-1/4 in. AT-type high-density drive; 1.2MB capacity
<i>720K, 3.5 in.</i>	3-1/2 in. double-sided drive; 720KB capacity
<i>1.44M, 3.5 in.</i>	3-1/2 in. double-sided drive; 1.44MB capacity
<i>2.88M, 3.5 in.</i>	3-1/2 in. double-sided drive; 2.88MB capacity

### 3.1.1.5 Video

This field selects the type of video adapter used for the primary system monitor. Although secondary monitors are supported, you do not have to select the type. The default setting is EGA/VGA.

<i>EGA/VGA</i>	Enhanced Graphics Adapter/Video Graphics Array. For EGA, VGA, SVGA and PGA monitor adapters.
<i>CGA 40</i>	Color Graphics Adapter. Power up in 40-column mode.
<i>CGA 80</i>	Color Graphics Adapter. Power up in 80-column mode.
<i>Mono</i>	Monochrome adapter. Includes high resolution monochrome adapters.

### 3.1.1.6 Halt On

This field determines whether the system will stop if an error is detected during power up. The default setting is All Errors.

<i>No Errors</i>	The system boot will not stop for any errors detected.
<i>All Errors</i>	The system boot will stop whenever the BIOS detects a non-fatal error.
<i>All, But Keyboard</i>	The system boot will not stop for a keyboard error; it will stop for all other errors.
<i>All, But Diskette</i>	The system boot will not stop for a disk error; it will stop for all other errors.
<i>All, But Disk/Key</i>	The system boot will not stop for a disk or keyboard error; it will stop for all other errors.

### 3.1.1.7 Base Memory

Displays the amount of base (or conventional) memory installed in the system. The value of the base memory is typically 512K for systems with 512K memory installed on the motherboard or 640K for systems with 640K or more memory installed on the motherboard.



#### 3.1.1.8 Extended Memory

Displays the amount of extended memory detected during boot-up.

#### 3.1.1.9 Total Memory

Displays the total memory available in the system.

### 3.1.2 Advanced BIOS Features

The Advanced BIOS Features allows you to configure your system for basic operation. Some entries are defaults required by the system board, while others, if enabled, will improve the performance of your system or let you set some features according to your preference.

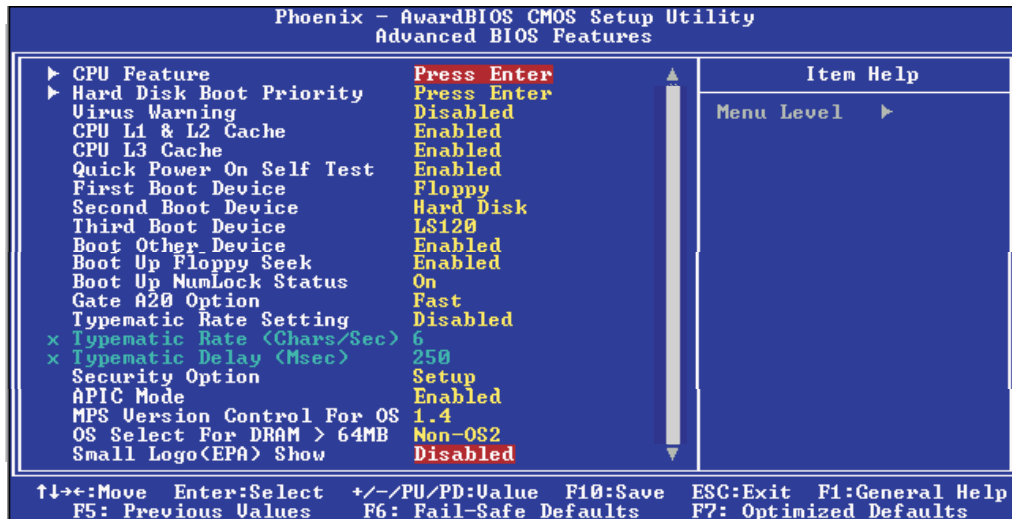

The settings on the screen are for reference only. Your version may not be identical to this one.

### 3.1.2.1 CPU Feature

Move the cursor to this field and press <Enter>. The following screen will appear:

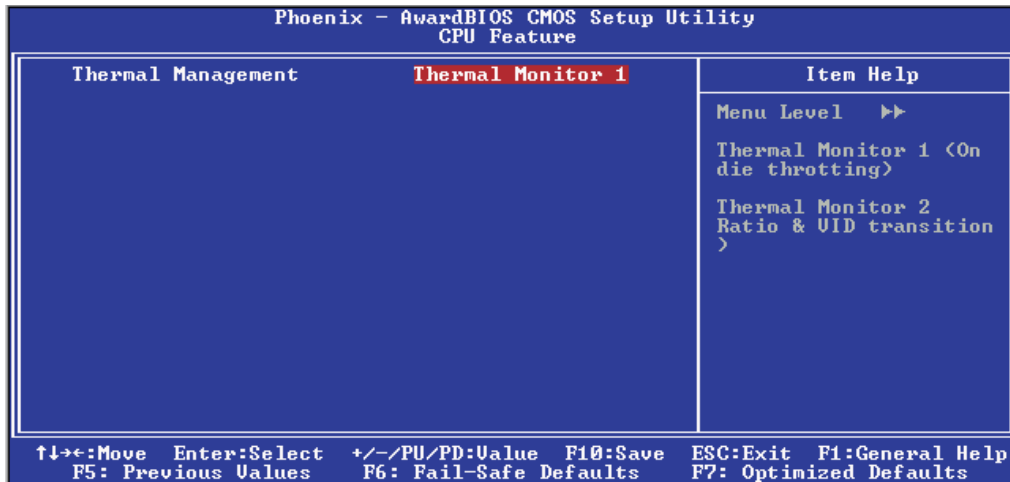

The settings on the screen are for reference only. Your version may not be identical to this one.

### Thermal Management

<i>Thermal Monitor 1</i>	On-die throttling
<i>Thermal Monitor 2</i>	Ratio and VID transition

### 3.1.2.2 Hard Disk Boot Priority

This field is used to select the boot sequence of the hard drives. Move the cursor to this field then press <Enter>. Use the Up or Down arrow keys to select a device then press <+> to move it up or <-> to move it down the list.

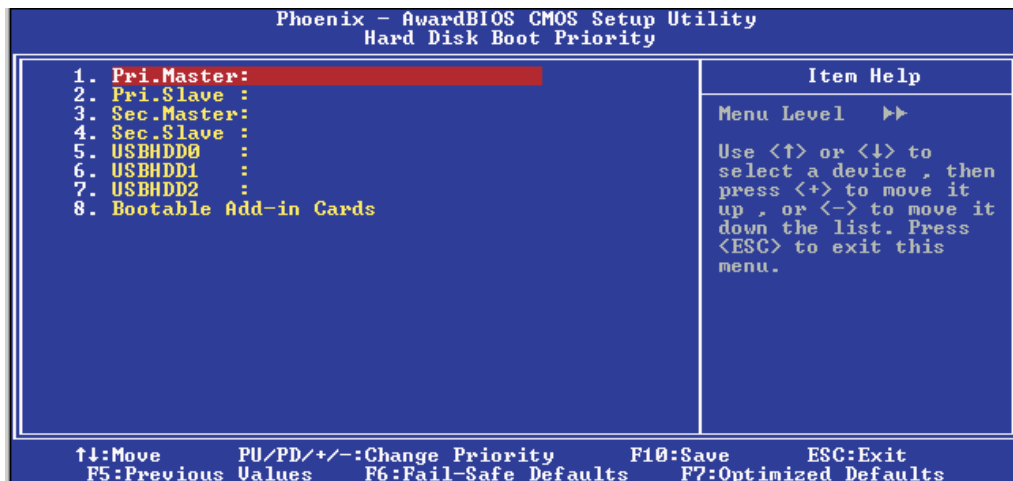

The settings on the screen are for reference only. Your version may not be identical to this one.

### 3.1.2.3 Virus Warning

This field protects the boot sector and partition table of your hard disk drive. When this field is enabled, the Award BIOS will monitor the boot sector and partition table of the hard disk drive. If an attempt is made to write to the boot sector or partition table of the hard disk drive, the BIOS will halt the system and an error message will appear.

After seeing the error message, if necessary, you will be able to run an anti-virus program to locate and remove the problem before any damage is done.

Many disk diagnostic programs which attempt to access the boot sector table will cause the warning message to appear. If you are running such a program, we recommend that you first disable this field.

### 3.1.2.4 CPU L1 and L2 Cache

This field is used to speed up the memory access. Enable the external cache for better performance.

### 3.1.2.5 CPU L3 Cache

This field is used to enable or disable the CPU's L3 cache.

### 3.1.2.6 Quick Power On Self Test

This field speeds up Power On Self Test (POST) after you power on the system. When Enabled, the BIOS will shorten or skip some check items during POST.

### 3.1.2.7 First Boot Device, Second Boot Device, Third Boot Device and Boot Other Device

Select the drive to boot first, second and third in the "First Boot Device" "Second Boot Device" and "Third Boot Device" fields respectively. The BIOS will boot the operating system according to the sequence of the drive selected. Set "Boot Other Device" to Enabled if you wish to boot from another device.

### 3.1.2.8 Boot Up Floppy Seek

When enabled, the BIOS will check whether the floppy disk drive installed is 40 or 80 tracks. Note that the BIOS cannot distinguish between 720K, 1.2M, 1.44M and 2.88M drive types as they are all 80 tracks. When disabled, the BIOS will not search for the type of floppy disk drive by track number. Note that there will not be any warning message if the drive installed is 360KB.

### 3.1.2.9 Boot Up NumLock Status

This allows you to determine the default state of the numeric keypad. By default, the system boots up with NumLock on wherein the function of the numeric keypad is the number keys. When set to Off, the function of the numeric keypad is the arrow keys.

### 3.1.2.10 Gate A20 Option

This field allows you to select how gate A20 is handled. Gate A20 is a device used to address memory above 1 Mbyte. Initially, gate A20 was handled via the keyboard controller. Today, while keyboards still provide this support, it is more common, and much faster, for the system chipset to provide support for gate A20. A20 refers to the first 64KB of extended memory.

- Fast*      The chipset controls Gate A20.
- Normal*    A pin in the keyboard controller controls Gate A20.

### 3.1.2.11 Typematic Rate Setting

- Disabled*    Continually holding down a key on your keyboard will cause the BIOS to report that the key is down.
- Enabled*     The BIOS will not only report that the key is down, but will first wait for a moment, and, if the key is still down, it will begin to report that the key has been depressed repeatedly. For example, you would use such a feature to accelerate cursor movements with the arrow keys. You can then select the typematic rate and typematic delay in the “Typematic Rate (Chars/Sec)” and “Typematic Delay (Msec)” fields below.

### 3.1.2.12 Typematic Rate (Chars/Sec)

This field allows you to select the rate at which the keys are accelerated.

### 3.1.2.13 Typematic Delay (Msec)

This field allows you to select the delay between when the key was first depressed and when the acceleration begins.

#### 3.1.2.14 Security Option

This field determines when the system will prompt for the password - everytime the system boots or only when you enter the BIOS setup. Set the password in the Set Supervisor/User Password submenu.

*System* The system will not boot and access to Setup will be denied unless the correct password is entered at the prompt.

*Setup* The system will boot, but access to Setup will be denied unless the correct password is entered at the prompt.

#### 3.1.2.15 APIC Mode

Leave this field in its default setting.

#### 3.1.2.16 MPS Version Control for OS

This field is used to select the MPS version that the system board is using.

#### 3.1.2.17 OS Select for DRAM > 64MB

This field allows you to access the memory that is over 64MB in OS/2. The options are: Non-OS2 and OS2.

#### 3.1.2.18 Small Logo(EPA) Show

*Enabled* The EPA logo will appear during system boot-up.

*Disabled* The EPA logo will not appear during system boot-up.

### 3.1.3 Advanced Chipset Features

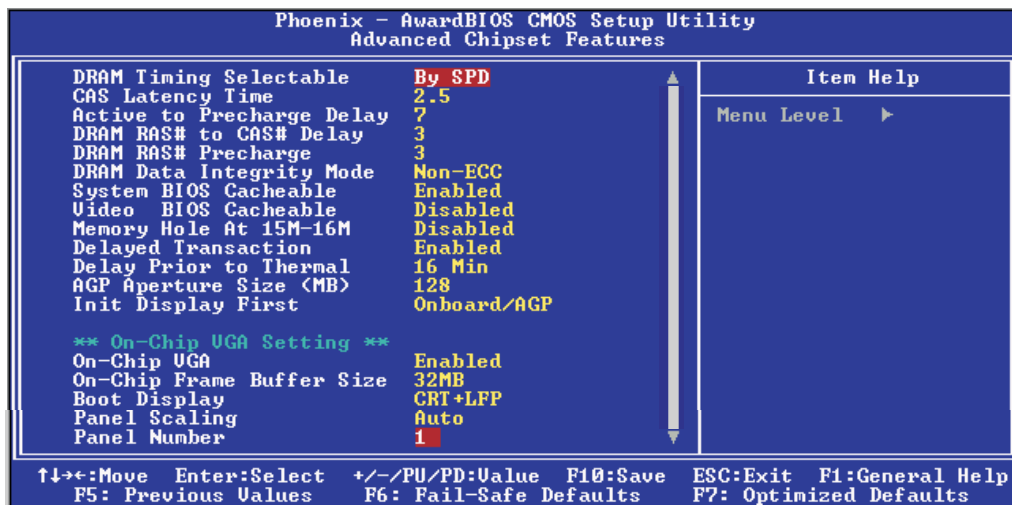

The settings on the screen are for reference only. Your version may not be identical to this one.

This section gives you functions to configure the system based on the specific features of the chipset. The chipset manages bus speeds and access to system memory resources. **These items should not be altered unless necessary.** The default settings have been chosen because they provide the best operating conditions for your system. The only time you might consider making any changes would be if you discovered some incompatibility or that data was being lost while using your system.

#### 3.1.3.1 DRAM Timing Selectable

This field is used to select the timing of the DRAM.

**By SPD**      The EEPROM on a DIMM has SPD (Serial Presence Detect) data structure that stores information about the module such as the memory type, memory size, memory speed, etc. When this option is selected, the system will run according to the information in the EEPROM. This option is the default setting because it provides the most stable condition for the system. The “CAS Latency Time” and “Active to Precharge Delay” fields will show the default settings by SPD.



*Manual* If you want better performance for your system other than the one “by SPD”, select “Manual” then select the best option in the “CAS Latency Time” and “Active to Precharge Delay” fields.

### 3.1.3.2 CAS Latency Time

This field is used to select the local memory clock periods.

### 3.1.3.3 Active to Precharge Delay

The options are 5, 6 and 7.

### 3.1.3.4 DRAM RAS# to CAS# Delay

The options are 2 and 3.

### 3.1.3.5 DRAM RAS# Precharge

This field controls RAS# precharge (in local memory clocks).

### 3.1.3.6 DRAM Data Integrity Mode

The ECC (Error Checking and Correction) function is supported only in x72 (72-bit) PC SDRAM DIMMs. If you are using x64 (64-bit) PC SDRAM DIMMs, set this field to Non-ECC.

*Non-ECC* Uses x64 PC SDRAM DIMM.

*ECC* This option allows the system to recover from memory failure. It detects single-bit and multiple-bit errors, then automatically corrects single-bit error.

### 3.1.3.7 System BIOS Cacheable

When this field is enabled, accesses to the system BIOS ROM addressed at F0000H-FFFFFH are cached, provided that the cache controller is enabled. The larger the range of the Cache RAM, the higher the efficiency of the system.

### 3.1.3.8 Video BIOS Cacheable

As with caching the system BIOS, enabling the Video BIOS cache will allow access to video BIOS addressed at C0000H to C7FFFH to be cached, if the cache controller is also enabled. The larger the range of the Cache RAM, the faster the video performance.

### 3.1.3.9 Memory Hole At 15M-16M

In order to improve system performance, certain space in memory can be reserved for ISA cards. This memory must be mapped into the memory space below 16MB. When enabled, the CPU assumes the 15-16MB memory range is allocated to the hidden ISA address range instead of the actual system DRAM. When disabled, the CPU assumes the 15-16MB address range actually contains DRAM memory. If more than 16MB of system memory is installed, this field must be disabled to provide contiguous system memory.

### 3.1.3.10 Delayed Transaction

When enabled, this function frees up the PCI bus for other PCI masters during the PCI-to-ISA transactions. This allows PCI and ISA buses to be used more efficiently and prevents degradation of performance on the PCI bus when ISA accesses are made.

### 3.1.3.11 Delay Prior To Thermal

This field is used to select the time that would force the CPU to a 50% duty cycle when it exceeds its maximum operating temperature therefore protecting the CPU and the system board from overheating to ensure a safe computing environment.

### 3.1.3.12 AGP Aperture Size (MB)

This field is used to select the size of the system RAM that can be allocated to the AGP for graphics purposes. Aperture refers to a portion of the PCI memory address range that is dedicated for the graphics memory address space. Host cycles that hit the aperture range are forwarded to the AGP without any translation.

### 3.1.3.13 Init Display First

This field is used to select whether to initialize the onboard VGA, AGP or PCI first when the system boots.

*Onboard/AGP* When the system boots, it will first initialize the onboard VGA or AGP.

*PCI Slot* When the system boots, it will first initialize PCI.

### 3.1.3.14 On-Chip VGA

This field is used to enable or disable the onboard VGA.

### 3.1.3.15 On-Chip Frame Buffer Size

This field is used to select the frame buffer size.

### 3.1.3.16 Boot Display

This field is used to select the type of display to use when the system boots.

*EFP* Select this option if you want the system to boot the EFP display.

*CRT* Select this option if you want the system to boot the CRT display.

*LFP* Select this option if you want the system to boot the LCD flat panel display.

*CRT+LFP* Select this option if you want the system to boot both the CRT and LCD flat panel display.

### 3.1.3.17 Panel Scaling

This options are Auto, On and Off.

### 3.1.3.18 Panel Number

- Panel 1* 640x480, one channel LVDS (A0-A2) for 18-bit panels
- Panel 2* 800x600, one channel LVDS (A0-A2) for 18-bit panels
- Panel 3* 1024x768, one channel LVDS (A0-A2) for 18-bit panels
- Panel 4* 1280x1024, two channel LVDS (A0-A3, B0-B3) for 48-bit panels

If you are using one of the standard panels shown above, select the appropriate option according to the type of panel that you are using. Otherwise, please contact your dealer or sales representative for a custom-made BIOS that will suit the panel that you are using.

### 3.1.4 Integrated Peripherals

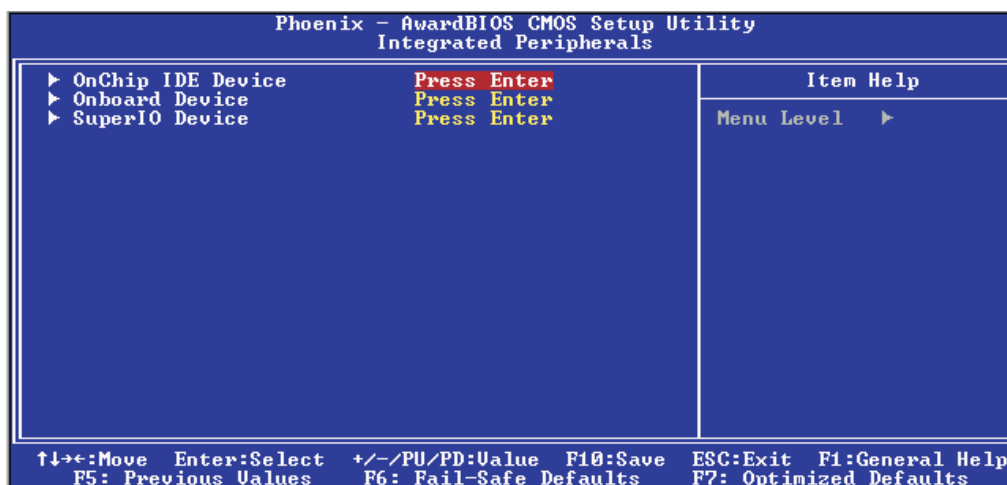

The settings on the screen are for reference only. Your version may not be identical to this one.

#### 3.1.4.1 OnChip IDE Device

Move the cursor to this field and press <Enter>. The following screen will appear:

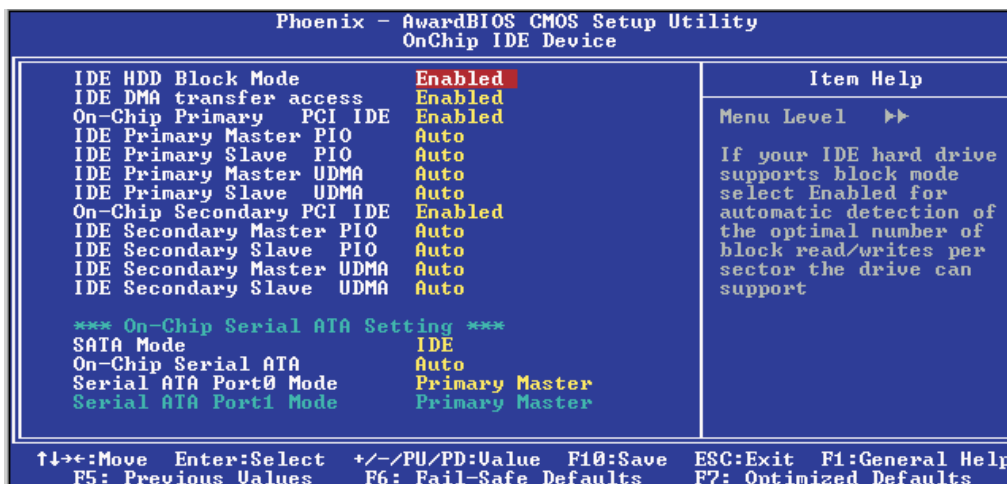

The settings on the screen are for reference only. Your version may not be identical to this one.

### IDE HDD Block Mode

*Enabled* The IDE HDD uses the block mode. The system BIOS will check the hard disk drive for the maximum block size the system can transfer. The block size will depend on the type of hard disk drive.

*Disabled* The IDE HDD uses the standard mode.

### IDE DMA Transfer Access

This field is used to enable or disable the DMA transfer function of an IDE hard drive.

### On-Chip Primary PCI IDE and On-Chip Secondary PCI IDE

These fields allow you to enable or disable the primary and secondary IDE controller. The default is Enabled. Select Disabled if you want to add a different hard drive controller.

### IDE Primary Master/Slave PIO and IDE Secondary Master PIO

PIO means Programmed Input/Output. Rather than have the BIOS issue a series of commands to effect a transfer to or from the disk drive, PIO allows the BIOS to tell the controller what it wants and then let the controller and the CPU perform the complete task by themselves. Your system supports five modes, 0 (default) to 4, which primarily differ in timing. When Auto is selected, the BIOS will select the best available mode after checking your drive.

*Auto* The BIOS will automatically set the system according to your hard disk drive's timing.

*Mode 0-4* You can select a mode that matches your hard disk drive's timing. Caution: Do not use the wrong setting or you will have drive errors.

## IDE Primary Master/Slave UDMA and IDE Secondary Master UDMA

These fields allow you to set the Ultra DMA in use. When Auto is selected, the BIOS will select the best available option after checking your hard drive or CD-ROM.

<i>Auto</i>	The BIOS will automatically detect the settings for you.
<i>Disabled</i>	The BIOS will not detect these categories.

## On-Chip Serial ATA Setting

This section is used to configure the serial ATA drives.

### SATA Mode

<i>IDE</i>	This option configures the Serial ATA drives in IDE mode.
<i>RAID</i>	This option enables the RAID function for Serial ATA drives.

### On-Chip Serial ATA

<i>Disabled</i>	Disables the onboard SATA.
<i>Auto</i>	The system will detect the existing SATA and IDE drives then automatically set them to the available master/slave mode.
<i>Combined Mode</i>	This option allows you to use both IDE and SATA drives; allowing a maximum of 4 drives. You must manually set the SATA drives' master/slave mode in the "Serial ATA Port0 Mode" and "Serial ATA Port1 Mode" fields.
<i>Enhanced Mode</i>	This option allows you to use both IDE and SATA drives; allowing a maximum of 6 drives.
<i>SATA Only</i>	This option automatically sets the SATA drives to Primary Master and Secondary Master modes. Since both drives are in master mode, you cannot set the IDE drives to Master mode. The "Serial ATA Port0 Mode" and "Serial ATA Port1 Mode" fields will not be configurable.

### Serial ATA Port0 Mode and Serial ATA Port1 Mode

These fields are used to select the master/slave mode of the Serial ATA drives. Make sure they do not conflict with the settings of the IDE hard drives.

#### 3.1.4.2 Onboard Device

Move the cursor to this field and press <Enter>. The following screen will appear:

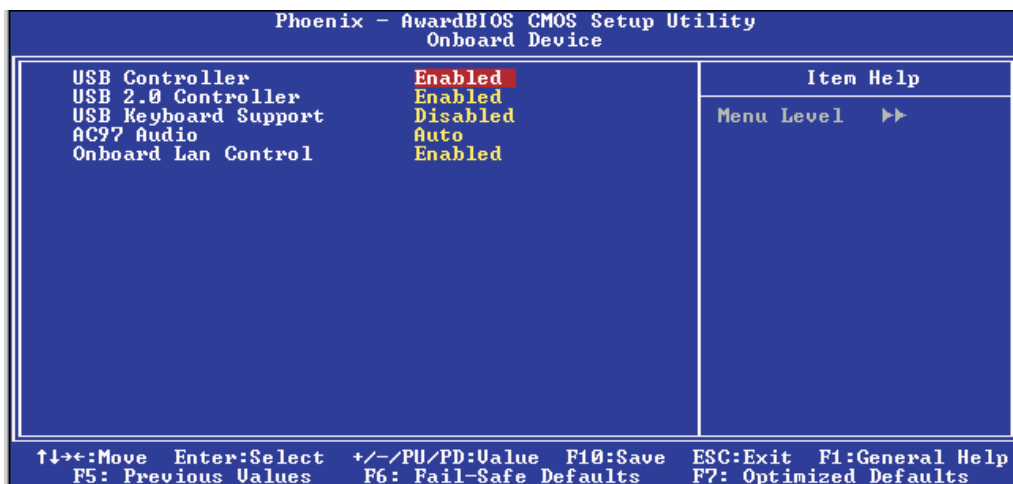

The settings on the screen are for reference only. Your version may not be identical to this one.

### USB Controller

This field is used to enable or disable the USB ports.

#### USB 2.0 Controller

If you are using USB 2.0, this field must be set to Enabled.

#### USB Keyboard Support

If you are using a USB keyboard under DOS, set this field to Enabled.



### AC97 Audio

- Auto*            Select this option when using the onboard audio CODEC.
- Disabled*        Select this option when using a PCI sound card.

### Onboard LAN Control

This field is used to enable or disable the onboard LAN.

## 3.1.4.3 Super IO Device

Move the cursor to this field and press <Enter>. The following screen will appear:



The screen above list all the fields available in the Super IO Device submenu, for ease of reference in this manual. In the actual CMOS setup, you have to use the scroll bar to view the fields. The settings on the screen are for reference only. Your version may not be identical to this one.

## Power On Function

This field allows you to use the keyboard or PS/2 mouse to power-on the system.

- Button only* Default setting. Uses the power button to power on the system.
- Password* When this option is selected, set the password you would like to use to power-on the system in the “KB Power On Password” field.
- Hot Key* When this option is selected, select the function key you would like to use to power-on the system in the “Hot Key Power On” field.
- Mouse Left* When this option is selected, double-click the left button of the mouse to power-on the system.
- Mouse Right* When this option is selected, double-click the right button of the mouse to power-on the system.
- Any Key* Press any key to power-on the system.
- Keyboard 98* When this option is selected, press the “wake up” key of the Windows® 98 compatible keyboard to power-on the system.

### KB Power On Password

Move the cursor to this field and press <Enter>. Enter your password. You can enter up to 5 characters. Type in exactly the same password to confirm, then press <Enter>.

The power button will not function once a keyboard password has been set in this field. You must type the correct password to power-on the system. If you forgot the password, power-off the system and remove the battery. Wait for a few seconds and install it back before powering-on the system.

### Hot Key Power On

This field is used to select a function key that you would like to use to power-on the system.

### Onboard FDC Controller

- Enabled* Enables the onboard floppy disk controller.
- Disabled* Disables the onboard floppy disk controller.

### UART Mode Select

This field is used to select the type of IrDA standard supported by your IrDA device. For better transmission of data, your IrDA peripheral device must be within a 30° angle and within a distance of 1 meter.

### RxD, TxD Active

The options are Hi, Lo; Lo, Hi; Lo, Lo; and Hi, Hi.

### IR Transmission Delay

If this field is Enabled, transmission of data will be slower. This is recommended when you encounter transmission problem with your device. The options are: Enabled and Disabled.

### UR2 Duplex Mode

- Half* Data is completely transmitted before receiving data.
- Full* Transmits and receives data simultaneously.

### Use IR Pins

The options are IR-Rx2Tx2 and RxD2TxD2.

### Onboard Parallel Port

*378//IRQ7, 3BC//IRQ7, 278//IRQ5* Selects the I/O address and IRQ for the onboard parallel port.

*Disabled* Disables the onboard parallel port.

### Parallel Port Mode

The options are SPP, EPP, ECP and ECP+EPP. These apply to standard specifications and will depend on the type and speed of your device. Refer to your peripheral's manual for the best option.

#### **SPP**

Allows normal speed operation but in one direction only.

#### **“ECP (Extended Capabilities Port)”**

Allows parallel port to operate in bidirectional mode and at a speed faster than the normal mode's data transfer rate.

#### **“EPP (Enhanced Parallel Port)”**

Allows bidirectional parallel port operation at maximum speed.

### EPP Mode Select

This field is used to select the EPP mode.

### ECP Mode Use DMA

This field is used to select the DMA channel used for the parallel port.

### PWRON After PWR-Fail

- Off* When power returns after an AC power failure, the system's power is off. You must press the Power button to power-on the system.
- On* When power returns after an AC power failure, the system will automatically power-on.
- Former-Sts* When power returns after an AC power failure, the system will return to the state where you left off before power failure occurs. If the system's power is off when AC power failure occurs, it will remain off when power returns. If the system's power is on when AC power failure occurs, the system will power-on when power returns.

### Serial Port 1, Serial Port 2, Serial Port 3 and Serial Port 4

- Auto* The system will automatically select an I/O address for the onboard serial port 1, 2, 3 or 4.
- 3F8/IRQ4, 2F8/IRQ3, 3E8/IRQ4, 2E8/IRQ3* Allows you to manually select an I/O address for the onboard serial port 1, 2, 3 or 4.
- Disabled* Disables the onboard serial port 1, 2, 3 or 4..

### Serial Port 3 Use IRQ and Serial Port 4 Use IRQ

These fields are used to select an IRQ for the onboard serial port 3 and serial port 4.

### 3.1.5 Power Management Setup

The Power Management Setup allows you to configure your system to most effectively save energy.

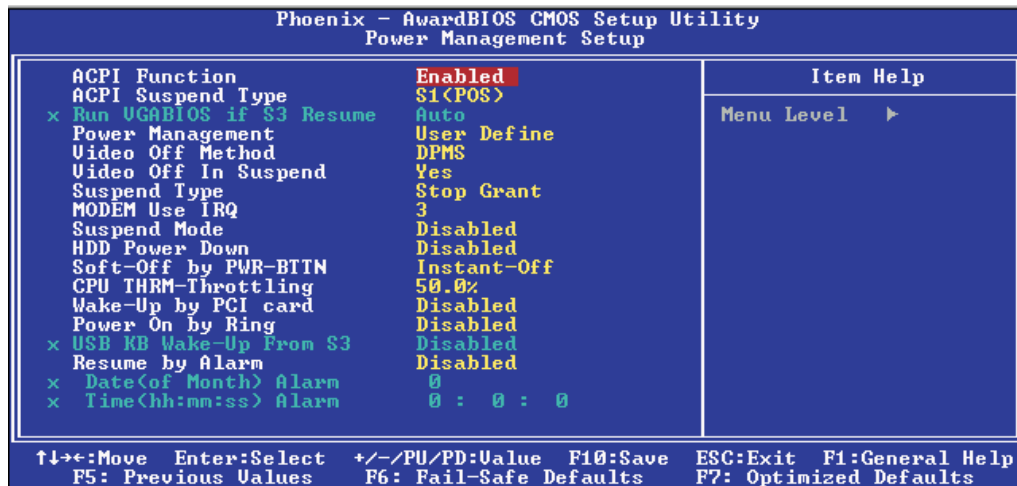

The settings on the screen are for reference only. Your version may not be identical to this one.

#### 3.1.5.1 ACPI Function

This function should be enabled only in operating systems that support ACPI. Currently, only Windows® 98/2000/ME/XP supports this function. If you want to use the Suspend to RAM function, make sure this field is enabled then select "S3(STR)" in the "ACPI Suspend Type" field.

#### 3.1.5.2 ACPI Suspend Type

This field is used to select the type of Suspend mode.

- S1(POS) Enables the Power On Suspend function.
- S3(STR) Enables the Suspend to RAM function.

### 3.1.5.3 Run VGABIOS if S3 Resume

When this field is set to Auto, the system will initialize the VGA BIOS when it wakes up from the S3 state. This can be configured only if the “ACPI Suspend Type” field is set to “S3(STR)”.

### 3.1.5.4 Power Management

This field allows you to select the type (or degree) of power saving by changing the length of idle time that elapses before the “Suspend Mode” field is activated.

<i>Min Saving</i>	Minimum power saving time for Suspend mode = 1 hr.
<i>Max Saving</i>	Maximum power saving time for Suspend mode = 1 min.
<i>User Define</i>	Allows you to set the power saving time in the “Suspend Mode” field.

### 3.1.5.5 Video Off Method

This determines the manner in which the monitor is blanked.

<i>VIH SYNC + Blank</i>	This will cause the system to turn off the vertical and horizontal synchronization ports and write blanks to the video buffer.
<i>Blank Screen</i>	This only writes blanks to the video buffer.
<i>DPMS Support</i>	Initializes display power management signaling. Select this if your video board supports it.

### 3.1.5.6 Video Off In Suspend

This field is used to activate the video off feature when the system enters the Suspend mode.

### 3.1.5.7 Suspend Type

The options are Stop Grant and PwrOn Suspend.

### 3.1.5.8 MODEM Use IRQ

This field is used to set an IRQ channel for the modem installed in your system.

### 3.1.5.9 Suspend Mode

When the system enters the Suspend mode, the CPU and onboard peripherals will be shut off.

### 3.1.5.10 HDD Power Down

This is selectable only when the Power Management field is set to User Define. When the system enters the HDD Power Down mode according to the power saving time selected, the hard disk drive will be powered down while all other devices remain active.

### 3.1.5.11 Soft-Off by PWR-BTTN

This field allows you to select the method of powering off your system.

*Delay 4 Sec.* Regardless of whether the Power Management function is enabled or disabled, if the power button is pushed and released in less than 4 sec, the system enters the Suspend mode. The purpose of this function is to prevent the system from powering off in case you accidentally “hit” or pushed the power button. Push and release again in less than 4 sec to restore. Pushing the power button for more than 4 seconds will power off the system.

*Instant-Off* Pressing and then releasing the power button at once will immediately power off your system.

### 3.1.5.12 CPU Thermal-Throttling

Thermal throttling regulates the thermal environment by alternating between running the processor at full speed and placing the processor in a sleep state whenever the upper limits of the thermal envelop are reached.



### 3.1.5.13 Wake-Up By PCI Card

*Enabled* This field should be set to Enabled only if your PCI card such as LAN card or modem card uses the PCI PME (Power Management Event) signal to remotely wake up the system. Access to the LAN card or PCI card will cause the system to wake up. Refer to the card's documentation for more information.

*Disabled* The system will not wake up despite access to the PCI card.

### 3.1.5.14 Power On By Ring

Set this field to Enabled to use the modem ring-on function. This will allow your system to power-on to respond to calls coming from an external modem.

### 3.1.5.15 USB KB Wake-Up From S3

This field, when enabled, allows you to use a USB keyboard or USB mouse to wake up a system that is in the S3 (STR - Suspend To RAM) state. This can be configured only if the "ACPI Suspend Type" field is set to "S3(STR)".

### 3.1.5.16 Resume By Alarm

*Enabled* When Enabled, you can set the date and time you would like the Soft Power Down (Soft-Off) PC to power-on in the "Date (of Month) Alarm" and "Time (hh:mm:ss) Alarm" fields. However, if the system is being accessed by incoming calls or the network (Resume On Ring/LAN) prior to the date and time set in these fields, the system will give priority to the incoming calls or network.

*Disabled* Disables the automatic power-on function. (default)

### 3.1.5.17 Date (of Month) Alarm

- 0 The system will power-on everyday according to the time set in the “Time (hh:mm:ss) Alarm” field.
- 1-31 Select a date you would like the system to power-on. The system will power-on on the set date, and time set in the “Time (hh:mm:ss) Alarm” field.

### 3.1.5.18 Time (hh:mm:ss) Alarm

This is used to set the time you would like the system to power-on. If you want the system to power-on everyday as set in the “Date (of Month) Alarm” field, the time set in this field must be later than the time of the RTC set in the Standard CMOS Features submenu.

### 3.1.6 PnP/PCI Configurations

This section shows how to configure the PCI bus system. It covers some very technical items and it is strongly recommended that only experienced users should make any changes to the default settings.

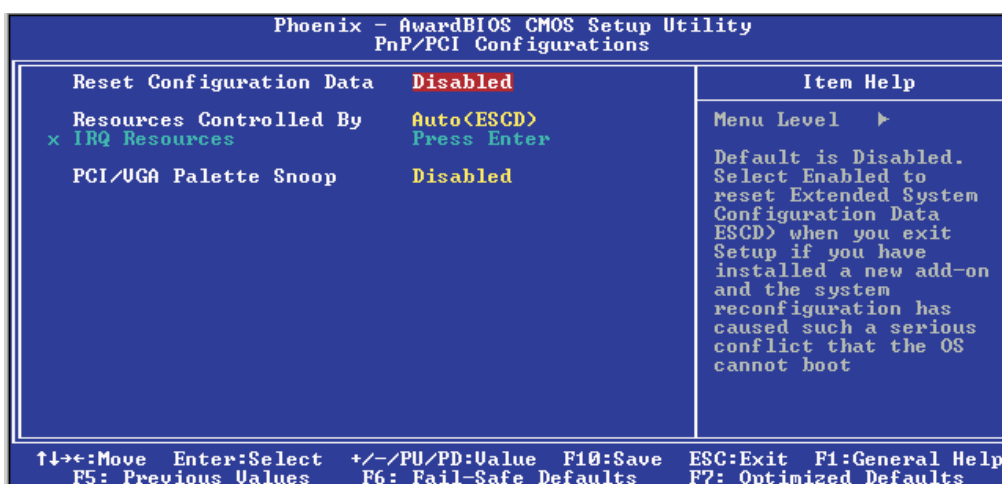

The settings on the screen are for reference only. Your version may not be identical to this one.

#### 3.1.6.1 Reset Configuration Data

*Enabled* The BIOS will reset the Extended System Configuration Data (ESCD) once automatically. It will then recreate a new set of configuration data.

*Disabled* The BIOS will not reset the configuration data.

#### 3.1.6.2 Resources Controlled By

The Award Plug and Play BIOS has the capability to automatically configure all of the boot and Plug and Play compatible devices.

*Auto(ESCD)* The system will automatically detect the settings for you.

*Manual* Choose the specific IRQ resources in the "IRQ Resources" field.

### 3.1.6.3 IRQ Resources

Move the cursor to this field and press <Enter>. The “IRQ-3” to “IRQ-15” fields will appear. Set each system interrupt to either PCI Device or Reserved.

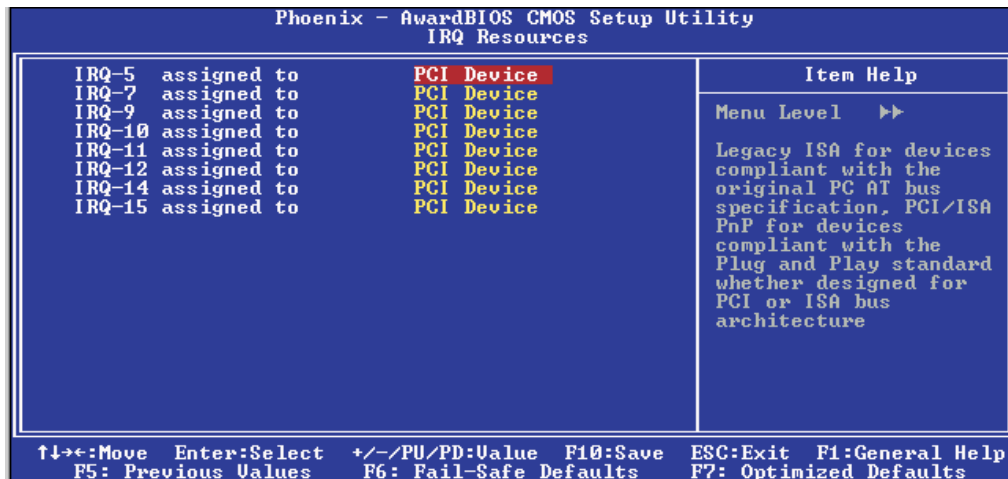

The settings on the screen are for reference only. Your version may not be identical to this one.

### 3.1.6.4 PCI/VGA Palette Snoop

This field determines whether the MPEG ISA/VESA VGA cards can work with PCI/VGA or not. The default value is Disabled.

- Enabled*    MPEG ISA/VESA VGA cards work with PCI/VGA.
- Disabled*    MPEG ISA/VESA VGA cards does not work with PCI/VGA.

### 3.1.7 PC Health Status

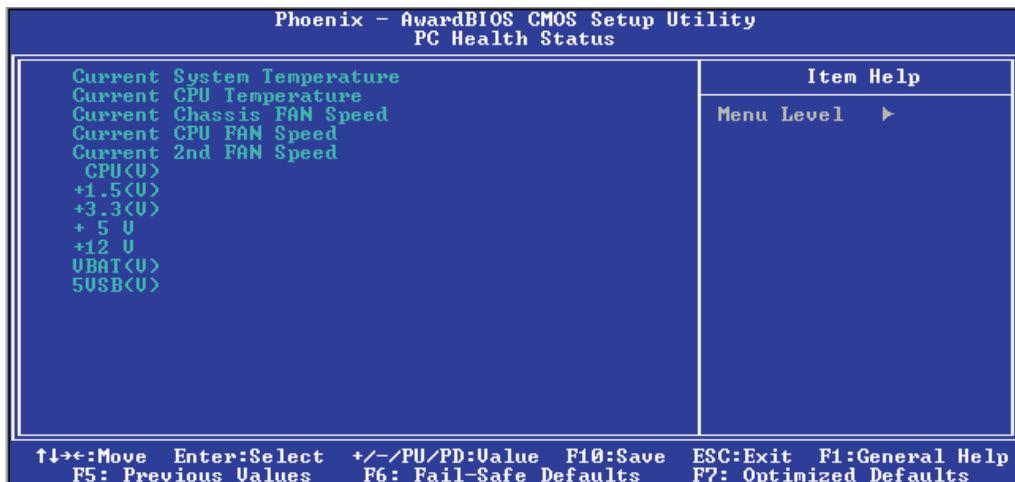

The settings on the screen are for reference only. Your version may not be identical to this one.

#### 3.1.7.1 Current System Temperature, Current CPU Temperature, Current Chassis Fan Speed, Current CPU Fan Speed and Current 2nd Fan Speed

These fields will show the internal temperature of the system, current temperature of the CPU, and the current fan speed of the cooling fans in RPM (Revolutions Per Minute).

#### 3.1.7.2 CPU(V)

This field will show the detected voltage of the processor.

#### 3.1.7.3 +1.5V(V), +3.3V(V), +5V(V), +12V(V), VBAT(V) and 5VSB(V)

These fields show the output voltage of the power supply.

### 3.1.8 Frequency/Voltage Control

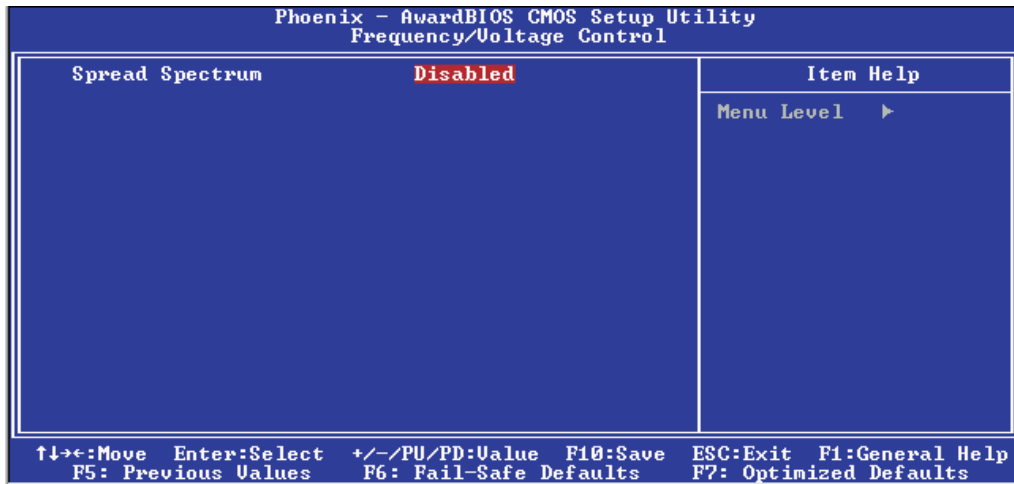

The settings on the screen are for reference only. Your version may not be identical to this one.

#### 3.1.8.1 Spread Spectrum

Leave this field in its default setting. Do not alter this setting unless advised by an engineer or technician.

### 3.1.9 Load Fail-Safe Defaults

The “Load Fail-Safe Defaults” option loads the troubleshooting default values permanently stored in the ROM chips. These settings are not optimal and turn off all high performance features. You should use these values only if you have hardware problems. Highlight this option in the main menu and press <Enter>.

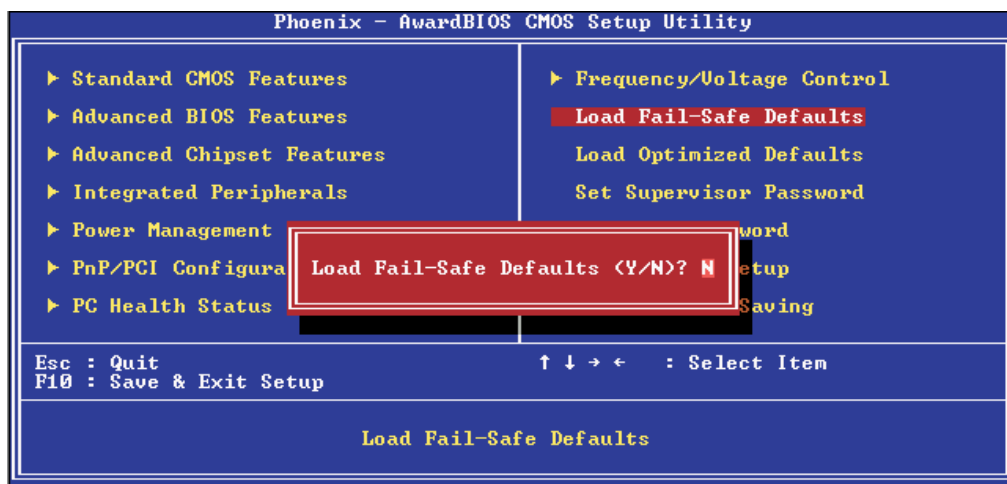

If you want to proceed, type <Y> and press <Enter>. The default settings will be loaded.

### 3.1.10 Load Optimized Defaults

The “Load Optimized Defaults” option loads optimized settings from the BIOS ROM. Use the default values as standard values for your system. Highlight this option in the main menu and press <Enter>.

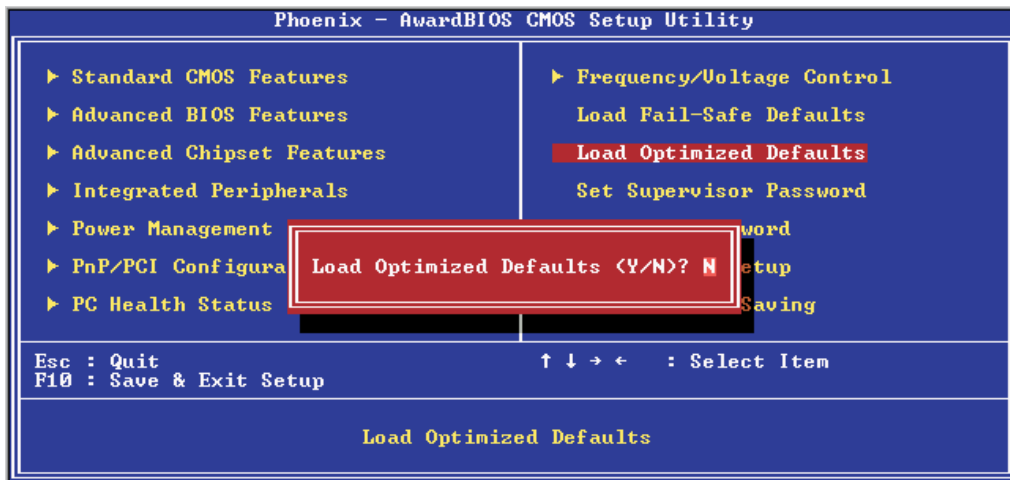

Type <Y> and press <Enter> to load the Setup default values.



### 3.1.11 Set Supervisor Password

If you want to protect your system and setup from unauthorized entry, set a supervisor's password with the "System" option selected in the Advanced BIOS Features. If you want to protect access to setup only, but not your system, set a supervisor's password with the "Setup" option selected in the Advanced BIOS Features. You will not be prompted for a password when you cold boot the system.

Use the arrow keys to highlight "Set Supervisor Password" and press <Enter>.

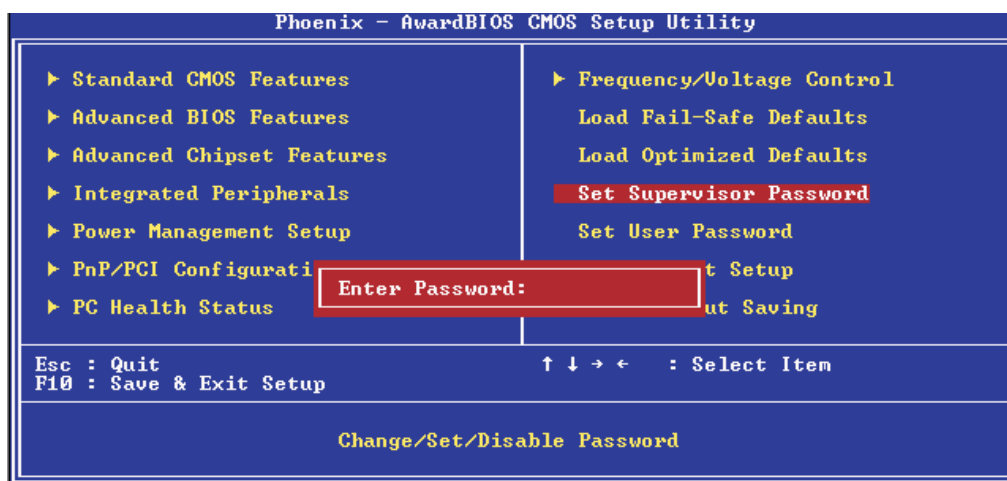

Type in the password. You are limited to eight characters. When done, the message below will appear:

Confirm Password:

You are asked to verify the password. Type in exactly the same password. If you type in a wrong password, you will be prompted to enter the correct password again. To delete or disable the password function, highlight "Set Supervisor Password" and press <Enter>, instead of typing in a new password. Press the <Esc> key to return to the main menu.

### 3.1.12 Set User Password

If you want another user to have access only to your system but not to setup, set a user's password with the "System" option selected in the Advanced BIOS Features. If you want a user to enter a password when trying to access setup, set a user's password with the "Setup" option selected in the Advanced BIOS Features.

Using user's password to enter Setup allows a user to access only "Set User Password" that appears in the main menu screen. Access to all other options is denied.

Use the arrow keys to highlight "Set User Password" and press <Enter>.

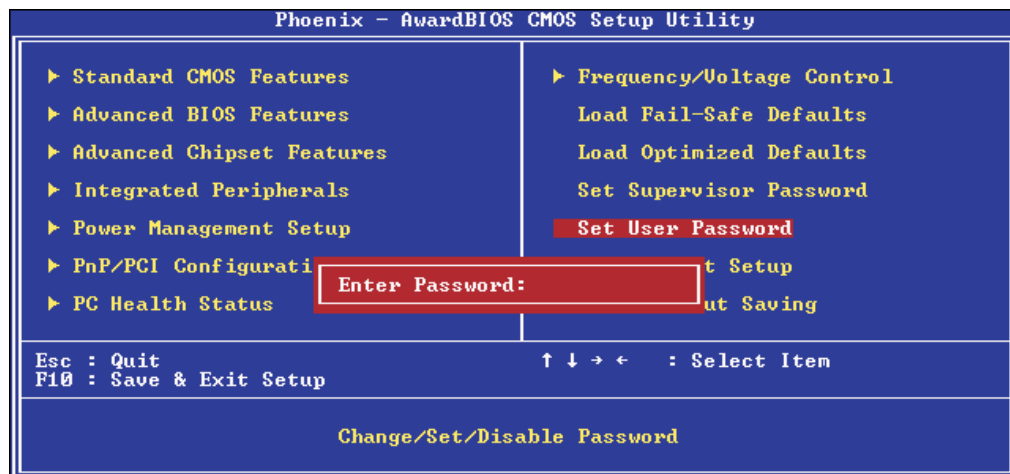

Type in the password. You are limited to eight characters. When done, the message below will appear:

Confirm Password:

You are asked to verify the password. Type in exactly the same password. If you type in a wrong password, you will be prompted to enter the correct password again. To delete or disable the password function, highlight "Set User Password" and press <Enter>, instead of typing in a new password. Press the <Esc> key to return to the main menu.

### 3.1.13 Save & Exit Setup

When all the changes have been made, highlight “Save & Exit Setup” and press <Enter>.

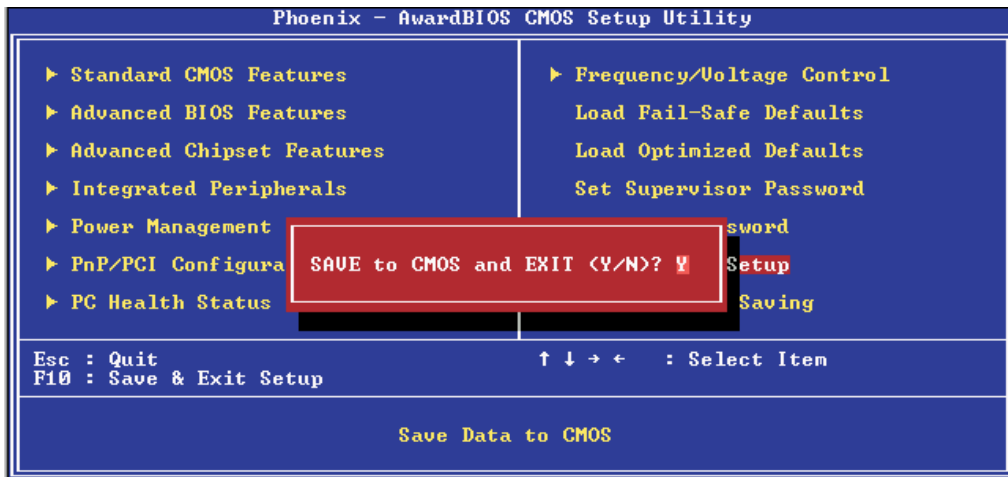

Type “Y” and press <Enter>. The modifications you have made will be written into the CMOS memory, and the system will reboot. You will once again see the initial diagnostics on the screen. If you wish to make additional changes to the setup, press <Ctrl> <Alt> <Esc> simultaneously or <Del> after memory testing is done.

### 3.1.14 Exit Without Saving

When you do not want to save the changes you have made, highlight “Exit Without Saving” and press <Enter>.

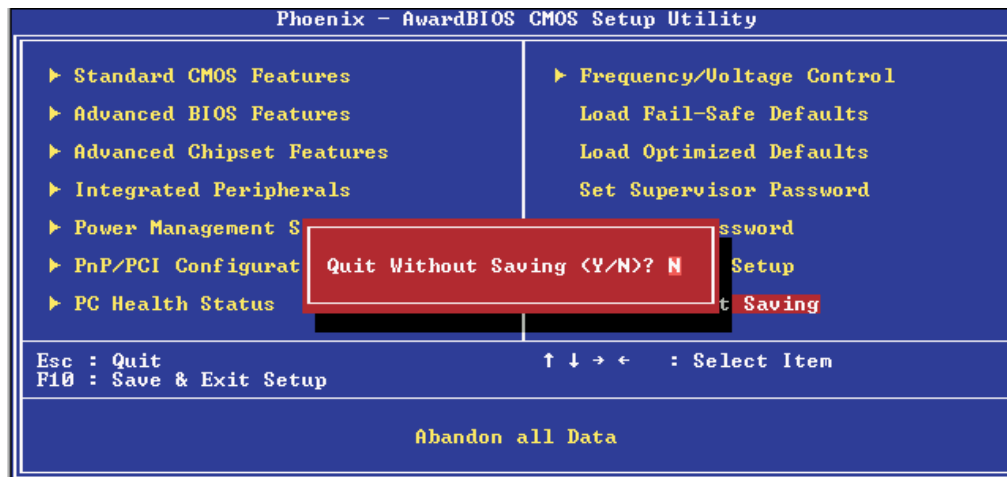

Type “Y” and press <Enter>. The system will reboot and you will once again see the initial diagnostics on the screen. If you wish to make any changes to the setup, press <Ctrl> <Alt> <Esc> simultaneously or <Del> after memory testing is done.

## 3.2 Intel RAID BIOS Setting Utility

The Intel RAID BIOS Setting Utility is used to configure and manage RAID on Serial ATA drives.



#### Important:

*Before you run the Intel RAID BIOS Setting Utility, make sure the Serial ATA settings in the Integrated Peripherals submenu (“OnChip IDE Device” section) of the Award BIOS is configured properly.*

After you power up the system and all hard disk drives have been detected, the Intel RAID BIOS status message screen will appear. Press the <Ctrl> and <I> keys simultaneously to enter the utility. The utility allows you to build a RAID system with Windows® XP or Windows® 2000 installed on a RAID 0 or RAID 1 Volume using two Serial ATA (SATA) hard drives.

### 3.3 Updating the BIOS

To update the BIOS, you will need the new BIOS file and a flash utility, AWDFLASH.EXE. Please contact technical support or your sales representative for the files.

1. Save the new BIOS file along with the flash utility AWDFLASH.EXE to a floppy disk.
2. Reboot the system and enter the Award BIOS Setup Utility to set the first boot drive to "Floppy".
3. Save the setting and reboot the system.
4. After the system booted from the floppy disk, execute the flash utility by typing AWDFLASH.EXE. The following screen will appear:

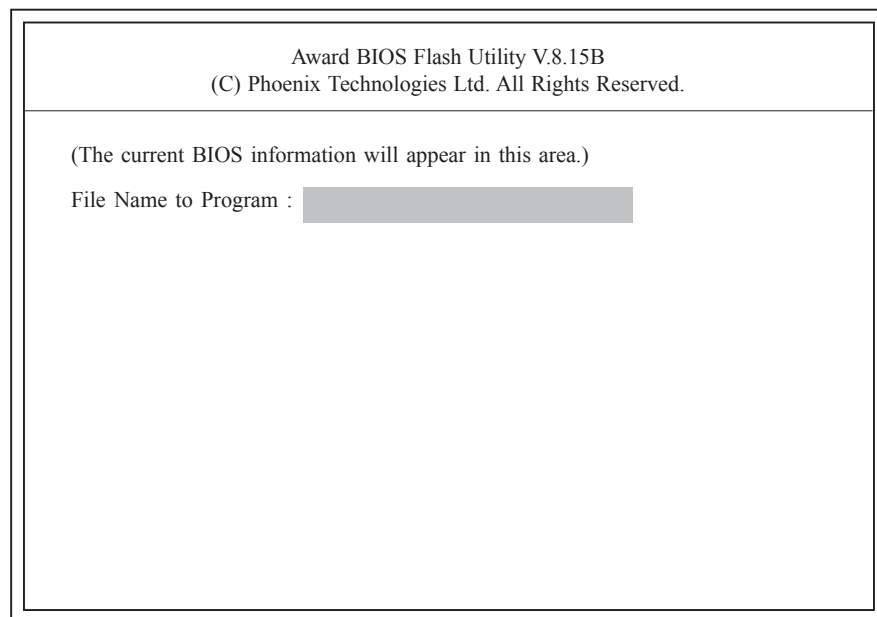

5. Type the new BIOS file name onto the gray area that is next to "File Name to Program" then press <Enter>.

6. The following will appear:

Do You Want to Save BIOS (Y/N)

This question refers to the current existing BIOS in your system. We recommend that you save the current BIOS and its flash utility; just in case you need to reinstall the BIOS. To save the current BIOS, press <Y> then enter the file name of the current BIOS. Otherwise, press <N>.

7. The following will then appear:

Press "Y" to Program or "N" to Exit

8. Press <Y> to flash the new BIOS.

## Chapter 4 - Supported Software

---

### 4.1 Drivers, Utilities and Software Applications

The CD that came with the system board contains drivers, utilities and software applications required to enhance the performance of the system board.

Insert the CD into a CD-ROM drive. The autorun screen (Main Board Utility CD) will appear. If after inserting the CD, "Autorun" did not automatically start (which is, the Mainboard Utility CD screen did not appear), please go directly to the root directory of the CD and double-click "Setup".

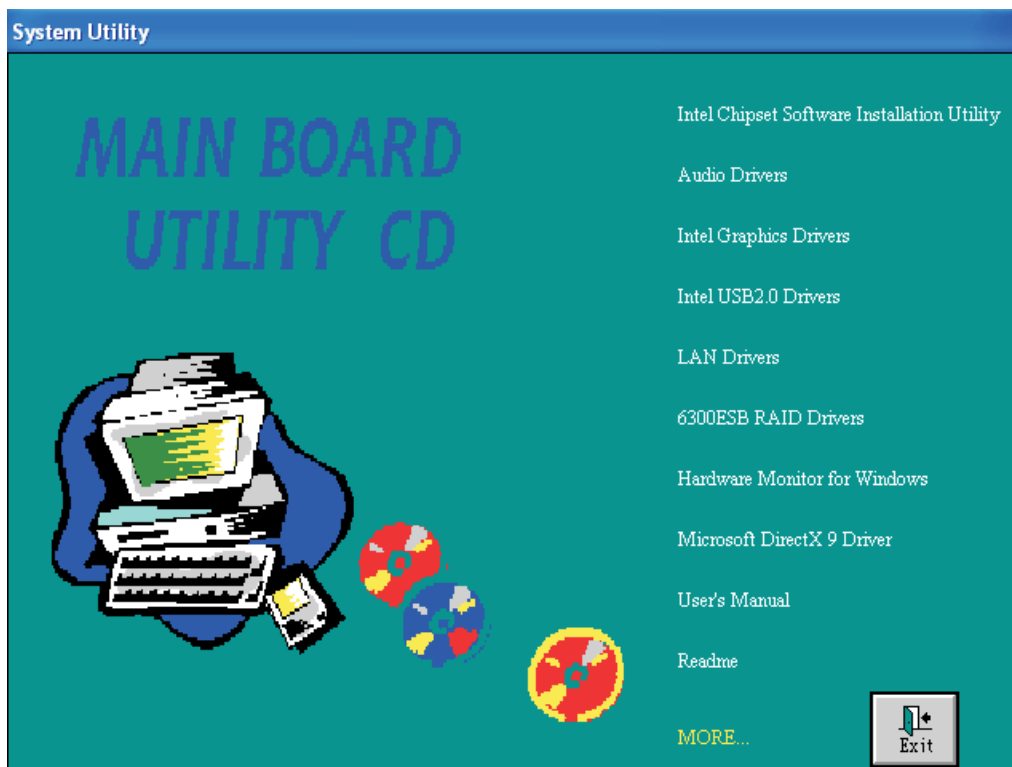

### 4.1.1 Intel Chipset Software Installation Utility

The Intel Chipset Software Installation Utility is used for updating Windows® 98SE/2000/ME/XP's INF files so that the Intel chipset can be recognized and configured properly in the system.

To install the utility, please follow the steps below.

1. Click “Intel Chipset Software Installation Utility” on the main menu. The following screen will appear:

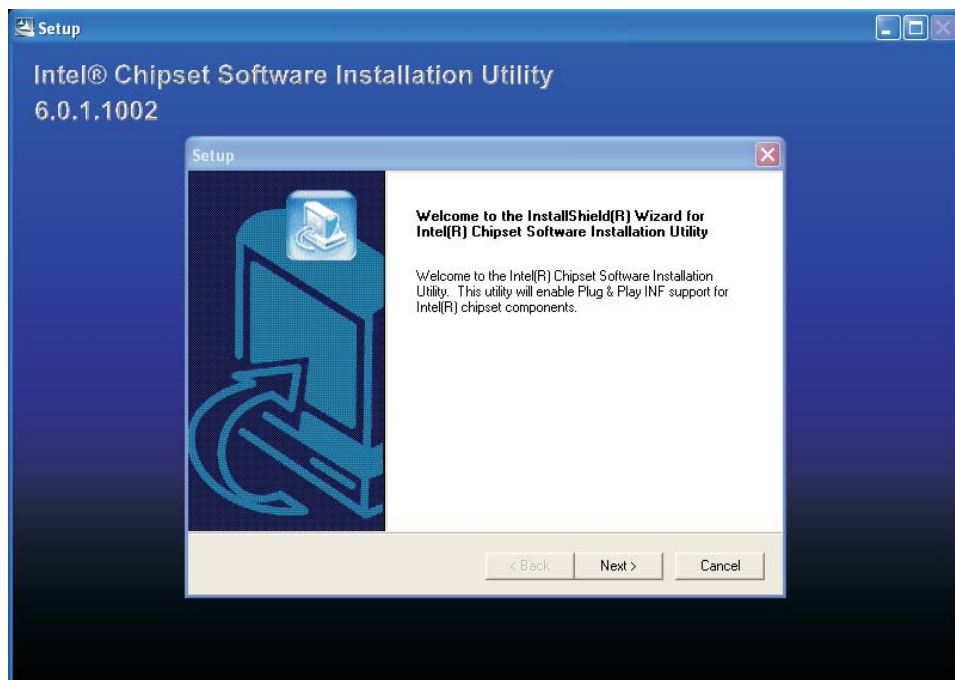

2. Follow the prompts on the screen to complete installation.
3. Reboot the system for the utility to take effect.



## 4.1.2 Audio Drivers

The Realtek audio drivers are supported in the following operating systems: Windows® 98SE, Windows® ME, Windows NT® 4.0, Windows® 2000 and Windows® XP.

To install the driver, please follow the steps below.

1. Click “Audio Drivers” on the main menu. The following screen will appear:

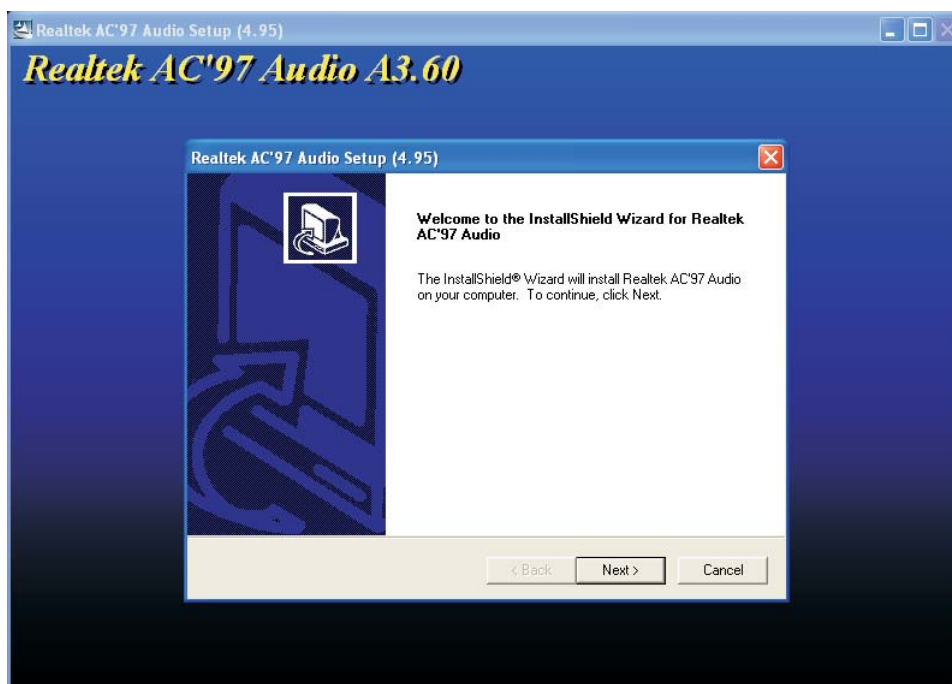

2. Follow the prompts on the screen to complete installation.
3. Reboot the system for the driver to take effect.

### 4.1.3 Intel Graphics Drivers

To install the driver, please follow the steps below.

1. Click “Intel Graphics Drivers” on the main menu. The following screen will appear:

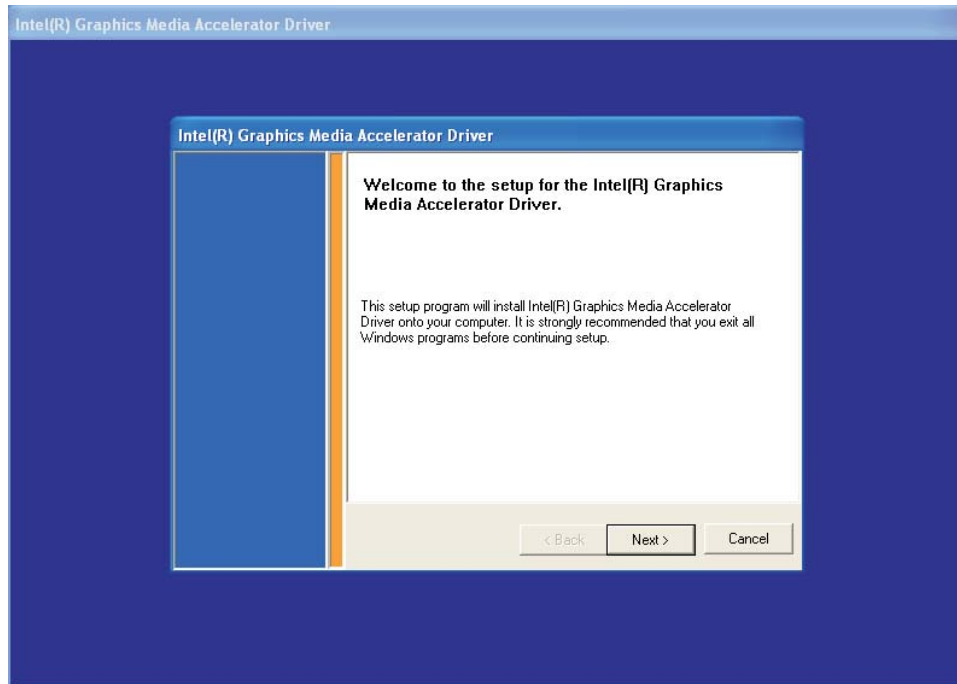

2. Follow the prompts on the screen to complete installation.
3. Reboot the system for the driver to take effect.

#### 4.1.4 Intel USB 2.0 Drivers

If you are using a USB 2.0 device, you must install the USB 2.0 driver. The drivers are supported in the following operating systems: Windows® 98 SE, Windows® ME and Windows® 2000.

To install the driver, please follow the steps below.

1. Click “Intel USB 2.0 Drivers” on the main menu. If you are using Windows® 98 SE or Windows® ME, the following screen will appear:

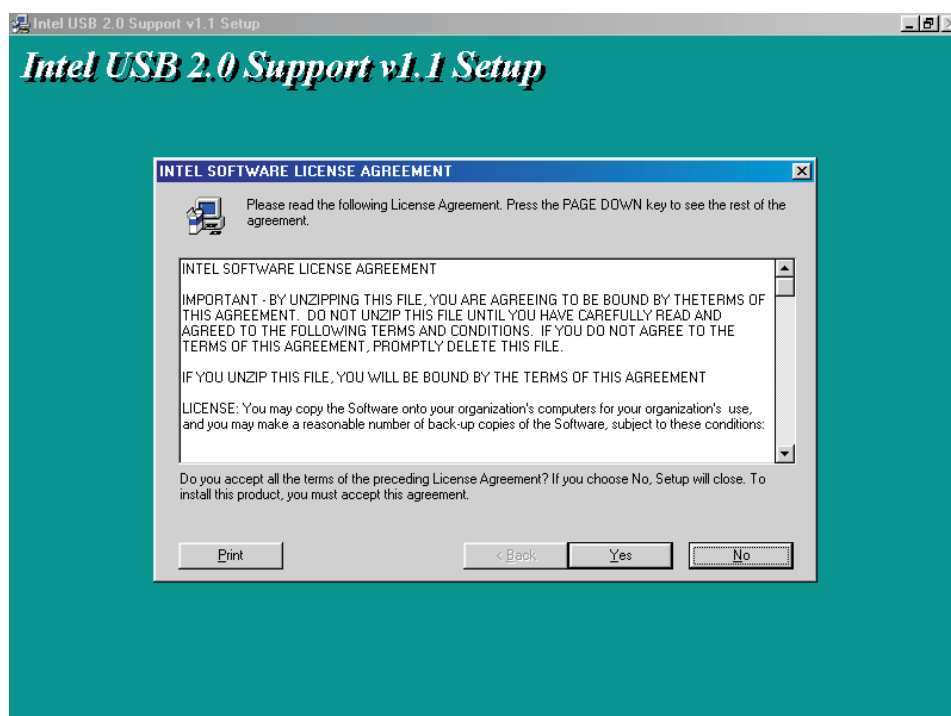

Windows® 2000 does not support auto-installation of the USB 2.0 driver. When you click “Intel USB 2.0 Drivers”, a “readme” screen will appear:

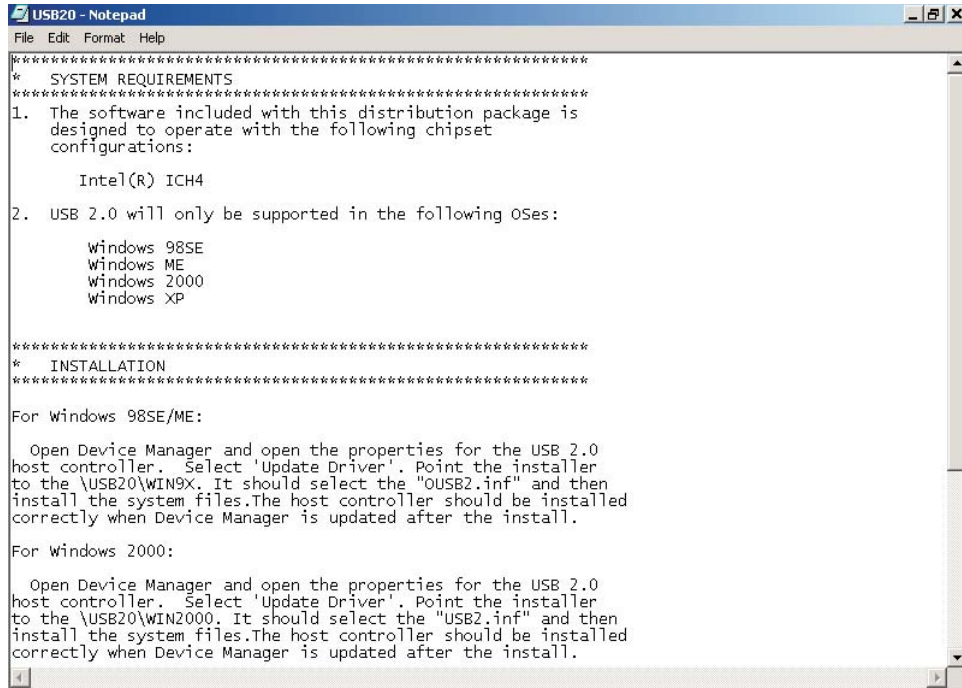

```
USB20 - Notepad
File Edit Format Help
*****
* SYSTEM REQUIREMENTS
*****
1. The software included with this distribution package is
   designed to operate with the following chipset
   configurations:

       Intel(R) ICH4

2. USB 2.0 will only be supported in the following OSes:

       Windows 98SE
       Windows ME
       Windows 2000
       Windows XP

*****
* INSTALLATION
*****
For Windows 98SE/ME:

   Open Device Manager and open the properties for the USB 2.0
   host controller. Select 'Update Driver'. Point the installer
   to the \USB20\WIN9X. It should select the "OUSB2.inf" and then
   install the system files. The host controller should be installed
   correctly when Device Manager is updated after the install.

For Windows 2000:

   Open Device Manager and open the properties for the USB 2.0
   host controller. Select 'Update Driver'. Point the installer
   to the \USB20\WIN2000. It should select the "USB2.inf" and then
   install the system files. The host controller should be installed
   correctly when Device Manager is updated after the install.
```

2. Follow the installation instructions shown on the screen.
3. Reboot the system for the driver to take effect.



**Important:**

*If you are using Windows® XP, you must install the Windows Service Pack 1 USB 2.0 driver which comes available after you have installed the operating system.*

### 4.1.5 LAN Drivers

To install the driver, please follow the steps below.

1. Click “LAN Drivers” on the main menu. The following screen will appear:

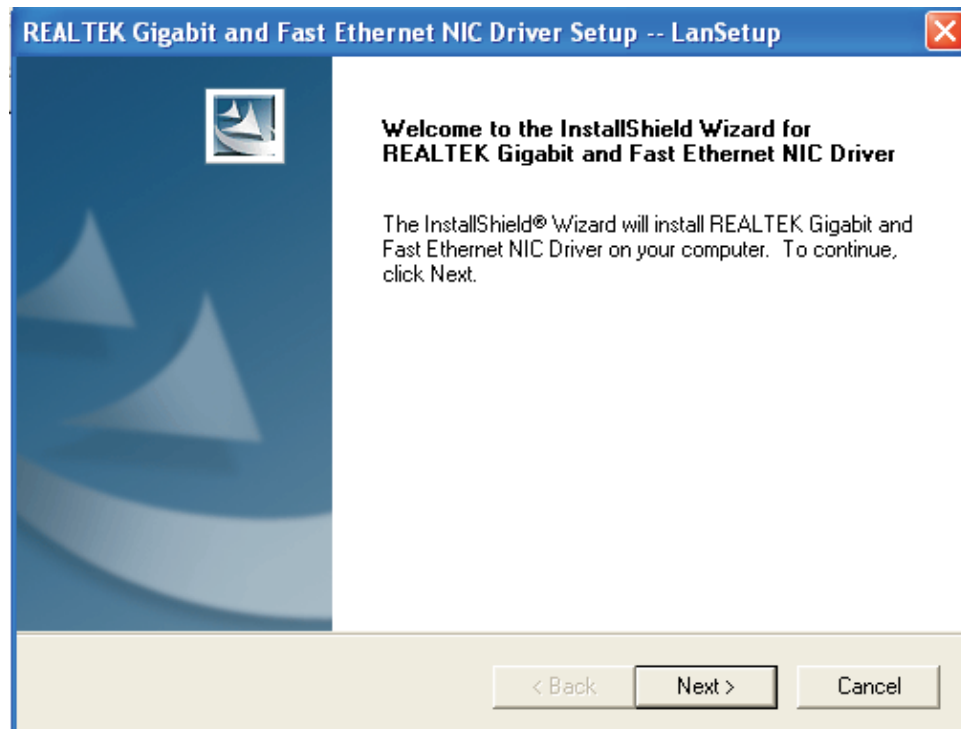

2. Follow the prompts on the screen to complete installation.
3. Reboot the system for the driver to take effect.

### 4.1.6 RAID Configuration and 6300ESB RAID Drivers

The following describes the steps on configuring RAID.

1. Set the “On-Chip Serial ATA” field to “Enhanced Mode”. (Integrated Peripherals submenu - OnChip IDE Device” section of the Award BIOS.)
2. Set the “SATA Mode” field to “RAID”. (Integrated Peripherals submenu - OnChip IDE Device” section of the Award BIOS.)
3. Reboot the PC.
4. When the system powers-up, press the <Ctrl> and <I> keys simultaneously to run the Intel RAID BIOS Setting Utility. The utility is used to configure the Serial ATA drives to RAID 0 or RAID 1.
5. Install the Intel 6300ESB RAID driver:

If you are in the process of installing Windows® XP or Windows® 2000 on RAID configured Serial ATA drives, you will need the provided Intel RAID floppy diskette. If you are installing the driver on existing Windows® XP or Windows® 2000, install the “6300ESB RAID Drivers” that is in the provided CD.

#### Installing the RAID Driver While Installing Windows® XP or Windows® 2000

The steps below will instruct you on installing the 6300ESB RAID driver while in the process of installing Windows® XP or Windows® 2000 on a RAID 0 or RAID 1 Volume Serial ATA drives.

1. Start Windows Setup by booting from the installation CD.
2. Press <F6> when prompted at the beginning of Windows setup.
3. Press <S> to select “Specify Additional Device”.
4. At this point you should be prompted to insert a floppy disk containing the 6300ESB RAID driver. Insert the provided floppy diskette.

5. Select “Intel® 6300ESB SATA RAID Controller” from the list then press <Enter>.
6. The next screen should confirm that you have selected the Intel(r) RAID controller. Press <Enter> again to continue.
7. Finish the Windows installation. Leave the floppy disk in the floppy drive until the system reboots itself. Windows setup will need to copy the files from the floppy disk again after the RAID volume is formatted, then Windows setup starts copying files.

### Installing the RAID Driver Under Existing Windows® XP or Windows® 2000

To install:

1. Click “6300ESB RAID Drivers” on the main menu. The following screen will appear:



2. Follow the installation instructions shown on the screen.
3. Reboot the system for the driver to take effect.

### 4.1.7 Hardware Monitor for Windows

Hardware Monitor for Windows is capable of monitoring the system's hardware conditions such as the temperature of the CPU and system, voltage, and speed of the cooling fans. It also allows you to manually set a range to the items being monitored. If the values are over or under the set range, a warning message will pop-up. The utility can also be configured so that a beeping alarm will sound whenever an error occurs. We recommend that you use the "Default Setting" which is the ideal setting that would keep the system in good working condition.

**Note:**

*Use this utility only in Windows® 98SE, Windows® ME, Windows® 2000, Windows NT® 4.0 or Windows® XP operating system.*

To install the utility, please follow the steps below.

1. Click "Hardware Monitor for Windows" on the main menu. The screen below will appear:

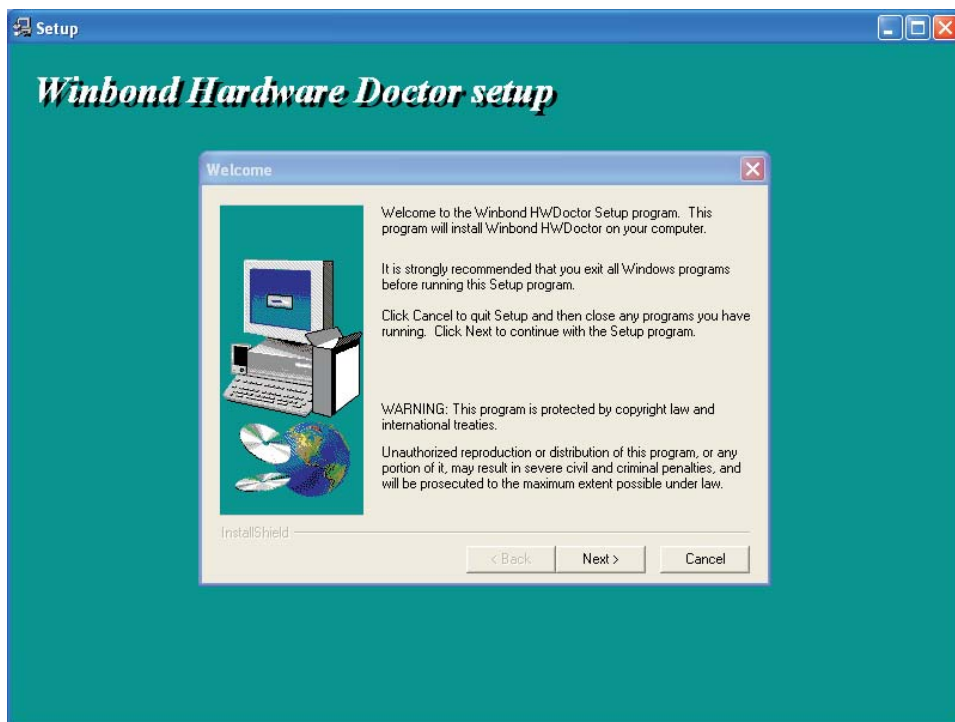

2. Follow the prompts on the screen to complete installation.
3. Restart the system.



### 4.1.8 Microsoft DirectX 9 Driver

To install, please follow the steps below.

1. Click “Microsoft DirectX 9 Driver” on the main menu. The following screen will appear:

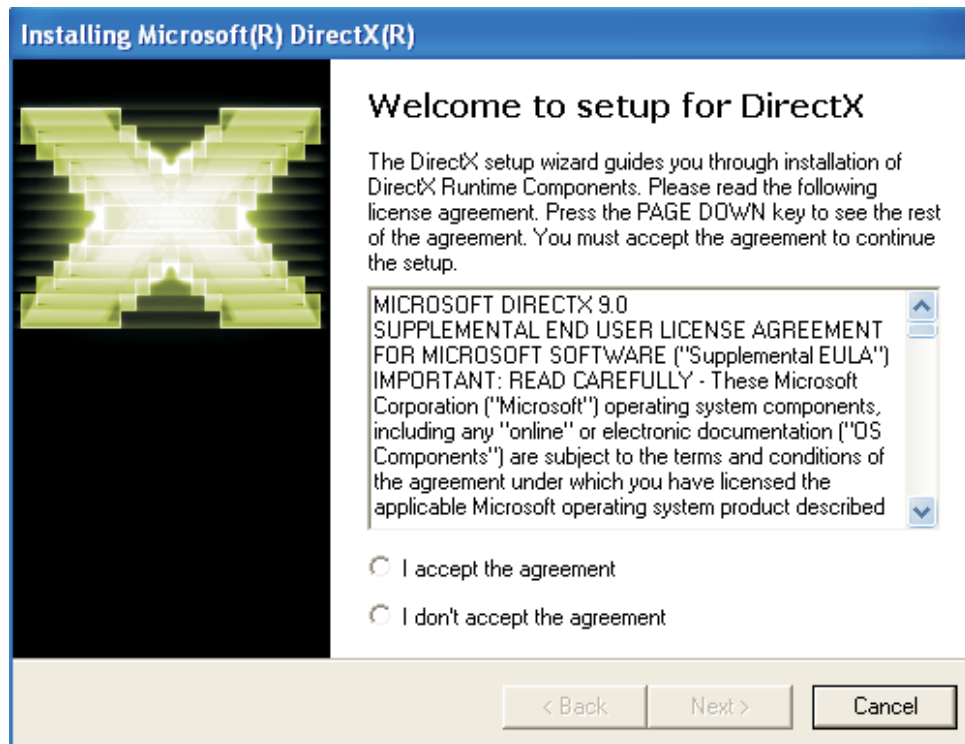

2. Click “I accept the agreement” then click “Next”.
3. Follow the prompts on the screen to complete installation.
4. Reboot the system for the driver to take effect.

## 4.2 Installation Notes

1. "Autorun" ONLY supports the Windows® 98 SE, Windows® ME, Windows® 2000, Windows NT® 4.0 and Windows® XP operating systems. If after inserting the CD, "Autorun" did not automatically start (which is, the Main Board Utility CD screen did not appear), please go directly to the root directory of the CD and double-click "Setup".
2. All steps or procedures to install software drivers are subject to change without notice as the softwares are occasionally updated. Please contact technical support or your sales representative for the latest version of the drivers or software applications.

## Appendix A - Watchdog Timer

---

### A.1 Watchdog Timer

The following parameters are references for setting the time interval of the Watchdog Timer function. The system will regularly be “cleared” according to the set time interval. If the system hangs or fails to function, it will also reset according to the time interval so that your system will continue to operate.

```
mov dx,02e <Enter>
mov al,87 <Enter>
out dx,al <Enter>
out dx,al <Enter>
mov dx,02e <Enter>
mov al,07 <Enter>
out dx,al <Enter>
inc dx <Enter>
inc al <Enter>
out dx,al <Enter>
dec dx <Enter>
mov al,f6 <Enter>
out dx,al <Enter>
inc dx <Enter>
mov al,xy <Enter>
out dx,al <Enter>
```

“XY” is the Watchdog Time count value for the “00h to “FFh” range wherein the time can be set from 0 sec. to 255 sec.

## Appendix B - System Error Message

---

When the BIOS encounters an error that requires the user to correct something, either a beep code will sound or a message will be displayed in a box in the middle of the screen and the message, PRESS F1 TO CONTINUE, CTRL-ALT-ESC or DEL TO ENTER SETUP, will be shown in the information box at the bottom. Enter Setup to correct the error.

### B.1 POST Beep

There are two kinds of beep codes in the BIOS. One code indicates that a video error has occurred and the BIOS cannot initialize the video screen to display any additional information. This beep code consists of a single long beep followed by three short beeps. The other code indicates that a DRAM error has occurred. This beep code consists of a single long beep.

### B.2 Error Messages

One or more of the following messages may be displayed if the BIOS detects an error during the POST. This list indicates the error messages for all Awards BIOSes:

#### CMOS BATTERY HAS FAILED

The CMOS battery is no longer functional. It should be replaced.



**Caution:**

*Danger of explosion if battery incorrectly replaced. Replace only with the same or equivalent type recommended by the manufacturer. Dispose of used batteries according to the battery manufacturer's instructions.*

#### CMOS CHECKSUM ERROR

Checksum of CMOS is incorrect. This can indicate that CMOS has become corrupt. This error may have been caused by a weak battery. Check the battery and replace if necessary.

#### DISPLAY SWITCH IS SET INCORRECTLY

The display switch on the motherboard can be set to either monochrome or color. This indicates the switch is set to a different

setting than indicated in Setup. Determine which setting is correct, either turn off the system and change the jumper or enter Setup and change the VIDEO selection.

**FLOPPY DISK(S) fail (80)**

Unable to reset floppy subsystem.

**FLOPPY DISK(S) fail (40)**

Floppy type mismatch.

**Hard Disk(s) fail (80)**

HDD reset failed.

**Hard Disk(s) fail (40)**

HDD controller diagnostics failed.

**Hard Disk(s) fail (20)**

HDD initialization error.

**Hard Disk(s) fail (10)**

Unable to recalibrate fixed disk.

**Hard Disk(s) fail (08)**

Sector Verify failed.

**Keyboard is locked out - Unlock the key**

The BIOS detects that the keyboard is locked. Keyboard controller is pulled low.

**Keyboard error or no keyboard present**

Cannot initialize the keyboard. Make sure the keyboard is attached correctly and no keys are being pressed during the boot.

**Manufacturing POST loop**

System will repeat POST procedure infinitely while the keyboard controller is pull low. This is also used for the M/B burn in test at the factory.

**BIOS ROM checksum error - System halted**

The checksum of ROM address F0000H-FFFFFH is bad.

**Memory test fail**

The BIOS reports memory test fail if the memory has error(s).

## Appendix C - Troubleshooting

---

### C.1 Troubleshooting Checklist

This chapter of the manual is designed to help you with problems that you may encounter with your personal computer. To efficiently troubleshoot your system, treat each problem individually. This is to ensure an accurate diagnosis of the problem in case a problem has multiple causes.

Some of the most common things to check when you encounter problems while using your system are listed below.

1. The power switch of each peripheral device is turned on.
2. All cables and power cords are tightly connected.
3. The electrical outlet to which your peripheral devices are connected is working. Test the outlet by plugging in a lamp or other electrical device.
4. The monitor is turned on.
5. The display's brightness and contrast controls are adjusted properly.
6. All add-in boards in the expansion slots are seated securely.
7. Any add-in board you have installed is designed for your system and is set up correctly.

#### Monitor/Display

**If the display screen remains dark after the system is turned on:**

1. Make sure that the monitor's power switch is on.
2. Check that one end of the monitor's power cord is properly attached to the monitor and the other end is plugged into a working AC outlet. If necessary, try another outlet.
3. Check that the video input cable is properly attached to the monitor and the system's display adapter.
4. Adjust the brightness of the display by turning the monitor's brightness control knob.

**The picture seems to be constantly moving.**

1. The monitor has lost its vertical sync. Adjust the monitor's vertical sync.
2. Move away any objects, such as another monitor or fan, that may be creating a magnetic field around the display.
3. Make sure your video card's output frequencies are supported by this monitor.

**The screen seems to be constantly wavering.**

1. If the monitor is close to another monitor, the adjacent monitor may need to be turned off. Fluorescent lights adjacent to the monitor may also cause screen wavering.

**Power Supply**

**When the computer is turned on, nothing happens.**

1. Check that one end of the AC power cord is plugged into a live outlet and the other end properly plugged into the back of the system.
2. Make sure that the voltage selection switch on the back panel is set for the correct type of voltage you are using.
3. The power cord may have a "short" or "open". Inspect the cord and install a new one if necessary.

**Floppy Drive**

**The computer cannot access the floppy drive.**

1. The floppy diskette may not be formatted. Format the diskette and try again.
2. The diskette may be write-protected. Use a diskette that is not write-protected.
3. You may be writing to the wrong drive. Check the path statement to make sure you are writing to the targeted drive.
4. There is not enough space left on the diskette. Use another diskette with adequate storage space.

## Hard Drive

### Hard disk failure.

1. Make sure the correct drive type for the hard disk drive has been entered in the BIOS.
2. If the system is configured with two hard drives, make sure the bootable (first) hard drive is configured as Master and the second hard drive is configured as Slave. The master hard drive must have an active/bootable partition.

### Excessively long formatting period.

1. If your hard drive takes an excessively long period of time to format, it is likely a cable connection problem. However, if your hard drive has a large capacity, it will take a longer time to format.

## Parallel Port

### The parallel printer doesn't respond when you try to print.

1. Make sure that your printer is turned on and that the printer is on-line.
2. Make sure your software is configured for the right type of printer attached.
3. Verify that the onboard LPT port's I/O address and IRQ settings are configured correctly.
4. Verify that the attached device works by attaching it to a parallel port that is working and configured correctly. If it works, the printer can be assumed to be in good condition. If the printer remains inoperative, replace the printer cable and try again.



## Serial Port

The serial device (modem, printer) doesn't output anything or is outputting garbled characters.

1. Make sure that the serial device's power is turned on and that the device is on-line.
2. Verify that the device is plugged into the correct serial port on the rear of the computer.
3. Verify that the attached serial device works by attaching it to a serial port that is working and configured correctly. If the serial device does not work, either the cable or the serial device has a problem. If the serial device works, the problem may be due to the onboard I/O or the address setting.
4. Make sure the COM settings and I/O address are configured correctly.

## Keyboard

Nothing happens when a key on the keyboard was pressed.

1. Make sure the keyboard is properly connected.
2. Make sure there are no objects resting on the keyboard and that no keys are pressed during the booting process.

## System Board

1. Make sure the add-in card is seated securely in the expansion slot. If the add-in card is loose, power off the system, re-install the card and power up the system.
2. Check the jumper settings to ensure that the jumpers are properly set.
3. Verify that all memory modules are seated securely into the memory sockets.
4. Make sure the memory modules are in the correct locations.
5. If the board fails to function, place the board on a flat surface and seat all socketed components. Gently press each component into the socket.
6. If you made changes to the BIOS settings, re-enter setup and load the BIOS defaults.