

FCC Information and Copyright

This equipment has been tested and found to comply with the limits of a Class B digital device, pursuant to Part 15 of the FCC Rules. These limits are designed to provide reasonable protection against harmful interference in a residential installation. This equipment generates, uses, and can radiate radio frequency energy and, if not installed and used in accordance with the instructions, may cause harmful interference to radio communications. There is no guarantee that interference will not occur in a particular installation.

The vendor makes no representations or warranties with respect to the contents here and specially disclaims any implied warranties of merchantability or fitness for any purpose. Further the vendor reserves the right to revise this publication and to make changes to the contents here without obligation to notify any party beforehand.

Duplication of this publication, in part or in whole, is not allowed without first obtaining the vendor's approval in writing.

The content of this user's manual is subject to be changed without notice and we will not be responsible for any mistakes found in this user's manual. All the brand and product names are trademarks of their respective companies.

Table of Contents

Chapter 1: Introduction	1
1.1 Before You Start	1
1.2 Package Checklist	1
1.3 Motherboard Features	2
1.4 Rear Panel Connectors	3
1.5 Motherboard Layout	4
Chapter 2: Hardware Installation	5
2.1 Installing Central Processing Unit (CPU)	5
2.2 FAN Headers	7
2.3 Installing System Memory	8
2.4 Connectors and Slots	10
Chapter 3: Headers & Jumpers Setup	12
3.1 How to Setup Jumpers	12
3.2 Detail Settings	12
Chapter 4: Useful Help	17
4.1 Driver Installation Note	17
4.2 Software	18
4.3 Extra Information	23
4.4 AMI BIOS Beep Code	25
4.5 Troubleshooting	26
Appendix: SPEC In Other Languages	28
German	28
French	30
Italian	32
Spanish	34
Portuguese	36
Polish	38
Russian	40
Arabic	42
Japanese	44

CHAPTER 1: INTRODUCTION

1.1 BEFORE YOU START

Thank you for choosing our product. Before you start installing the motherboard, please make sure you follow the instructions below:

- Prepare a dry and stable working environment with sufficient lighting.
- Always disconnect the computer from power outlet before operation.
- Before you take the motherboard out from anti-static bag, ground yourself properly by touching any safely grounded appliance, or use grounded wrist strap to remove the static charge.
- Avoid touching the components on motherboard or the rear side of the board unless necessary. Hold the board on the edge, do not try to bend or flex the board.
- Do not leave any unfastened small parts inside the case after installation. Loose parts will cause short circuits which may damage the equipment.
- Keep the computer from dangerous area, such as heat source, humid air and water.

1.2 PACKAGE CHECKLIST

- ✚ IDE Cable X 1
- ✚ Serial ATA Cable X 1
- ✚ Rear I/O Panel for ATX Case X 1
- ✚ Installation Guide X 1
- ✚ Fully Setup Driver CD X 1 (full version manual files inside)
- ✚ FDD Cable X 1 (optional)
- ✚ USB 2.0 Cable X1 (optional)
- ✚ Serial ATA Power Cable X 1 (optional)

Note: The package contents may be different due to area or your motherboard version.

1.3 MOTHERBOARD FEATURES

SPEC		
CPU	LGA 775 Intel Core2Quad / Core2Duo / Pentium Dual-Core / Celeron Dual-Core / Celeron 4xx processor (Maximum Watt: 95W)	Supports Hyper-Threading / Execute Disable Bit / Enhanced Intel SpeedStep® / Intel Architecture-64 / Extended Memory 64 Technology / Virtualization Technology
FSB	Support 800 / 1066 / 1333 MHz	
Chipset	Intel G31 Intel ICH7	
Super I/O	ITE 8718F Provides the most commonly used legacy Super I/O functionality. Low Pin Count Interface	Environment Control initiatives, Hardware Monitor Controller Fan Speed Controller ITE's "Smart Guardian" function
Main Memory	DIMM Slots x 2 Each DIMM supports 256MB / 512MB / 1GB / 2GB DDR2 Max Memory Capacity 4GB	Dual Channel Mode DDR2 memory module Supports DDR2 800/667 Registered DIMM and ECC DIMM is not supported
Graphics	GMA 3100	Max Shared Video Memory is 256MB
IDE	Integrated IDE Controller	Ultra DMA 33 / 66 / 100 Bus Master Mode supports PIO Mode 0~4
SATA 2	Integrated Serial ATA Controller	Data transfer rates up to 3.0 Gb/s. SATA Version 2.0 specification compliant
LAN	Realtek RTL 8111DL	10 / 100 Mb/s / 1Gb/s auto negotiation Half / Full duplex capability
Sound Codec	ALC662	5.1 channels audio out High Definition Audio
Slots	PCI slot x2 PCI Express x 16 slot x1	Supports PCI expansion cards Supports PCI-E x16 expansion cards
On Board Connector	Floppy Connector x1 Serial port Connector (Optional) x1 IDE Connector x1	Each connector supports 2 Floppy drives Connects to RS-232 Port Each connector supports 2 IDE device

SPEC			
	SATA Connector	x4	Each connector supports 1 SATA devices
	Front Panel Connector	x1	Supports front panel facilities
	Front Audio Connector	x1	Supports front panel audio function
	CPU Fan Header	x1	CPU Fan power supply (with Smart Fan function)
	System Fan Header	x1	System Fan Power supply
	Clear CMOS Header	x1	Restore CMOS data to factory default
	USB Connector	x2	Each connector supports 2 front panel USB ports
	Power Connector (24pin)	x1	Connects to Power supply
	Power Connector (4pin)	x1	Connects to Power supply
Back Panel I/O	PS/2 Keyboard	x1	Connects to PS/2 Keyboard
	PS/2 Mouse	x1	Connects to PS/2 Mouse
	Serial Port	x1	Provide RS-232 Serial connection
	Printer Port	x1	Provide 1 connection for printer
	VGA port	x1	Connects to monitor.
	LAN port	x1	Connects to RJ-45 ethernet cable
	USB Port	x4	Connects to USB devices
	Audio Jack	x3	Provide Audio-In/Out and microphone connection
Board Size	190 (W) x 244 (L) mm		
OS Support	Windows 2000 / XP / Vista 32 / Vista 64		Biostar reserves the right to add or remove support for any OS with or without notice

1.4 REAR PANEL CONNECTORS

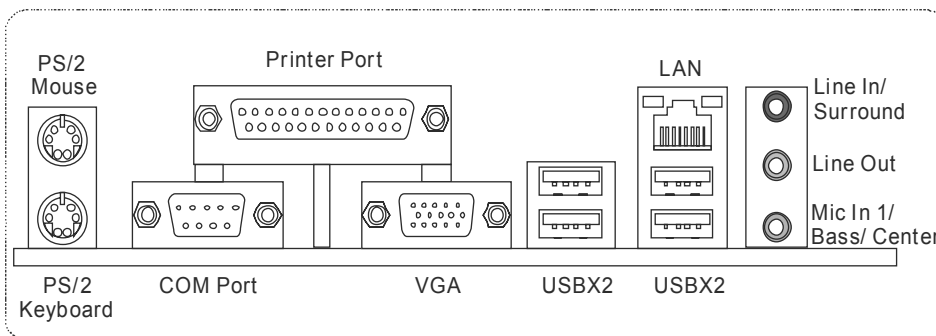

1.5 MOTHERBOARD LAYOUT

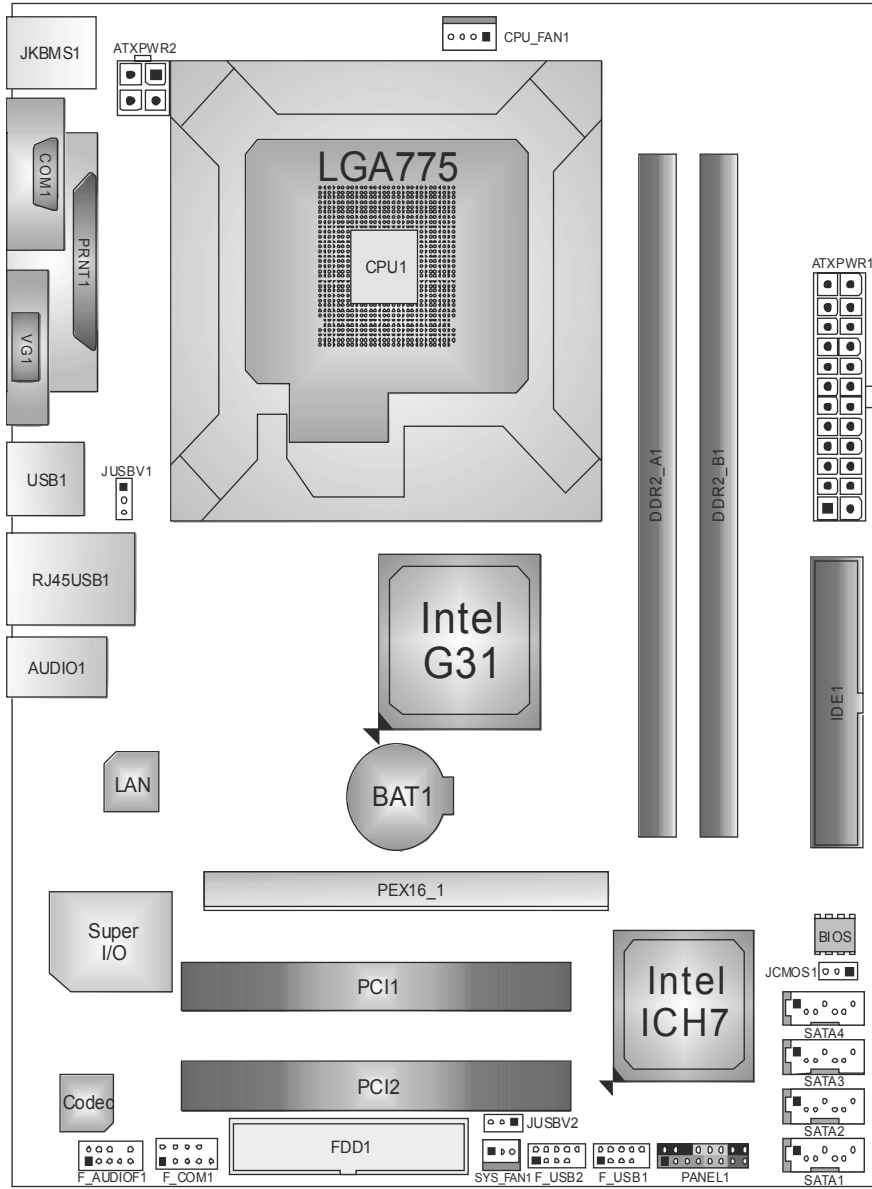

Note: ■ represents the 1st pin.

CHAPTER 2: HARDWARE INSTALLATION

2.1 INSTALLING CENTRAL PROCESSING UNIT (CPU)

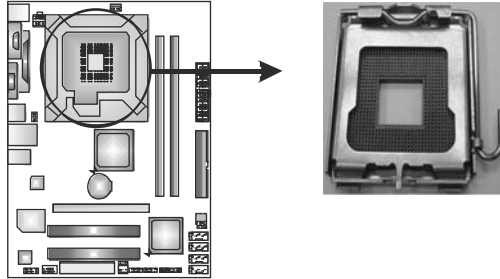

Special Notice:

Remove Pin Cap before installation, and make good preservation for future use. When the CPU is removed, cover the Pin Cap on the empty socket to ensure pin legs won't be damaged.

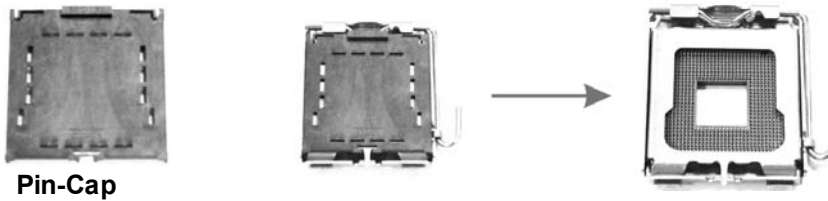

Step 1: Pull the socket locking lever out from the socket and then raise the lever up to a 90-degree angle.

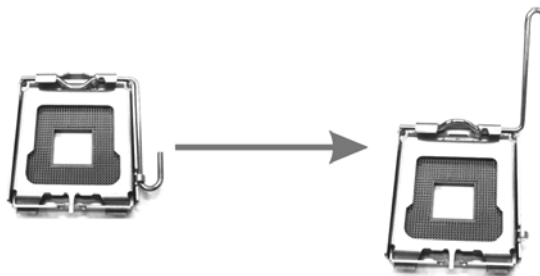

Motherboard Manual

Step 2: Look for the triangular cut edge on socket, and the golden dot on CPU should point forwards this triangular cut edge. The CPU will fit only in the correct orientation.

Step 2-1:

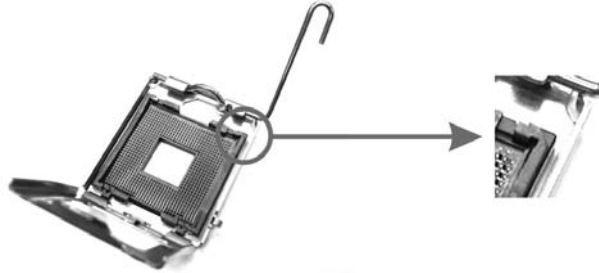

Step 2-2:

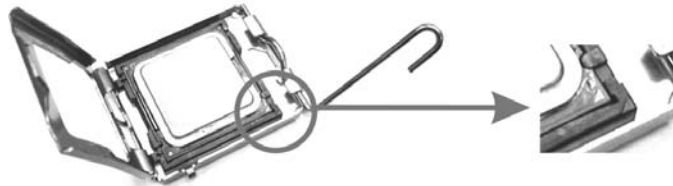

Step 3: Hold the CPU down firmly, and then lower the lever to locked position to complete the installation.



Step 4: Put the CPU Fan and heatsink assembly on the CPU and buckle it on the retention frame. Connect the CPU FAN power cable into the JCFAN1. This completes the installation.

2.2 FAN HEADERS

These fan headers support cooling-fans built in the computer. The fan cable and connector may be different according to the fan manufacturer. Connect the fan cable to the connector while matching the black wire to pin#1.

CPU_FAN1: CPU Fan Header

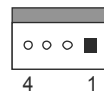
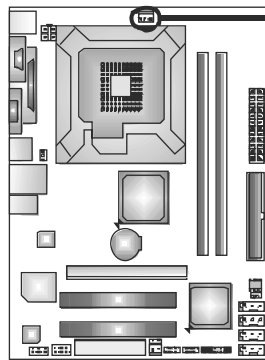

Pin	Assignment
1	Ground
2	Power
3	FAN RPM rate sense
4	Smart Fan Control

SYS_FAN1: System Fan Header

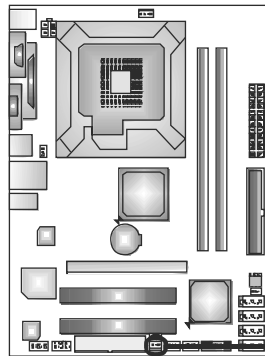

Pin	Assignment
1	Ground
2	Power
3	FAN RPM rate sense

Note:

SYS_FAN1 supports 3-pin head connector; CPU_FAN, 4-pin head one. When connecting with wires onto connectors, please note that the red wire is the positive and should be connected to pin#2, and the black wire is Ground and should be connected to GND.

2.3 INSTALLING SYSTEM MEMORY

A. DDR2 module

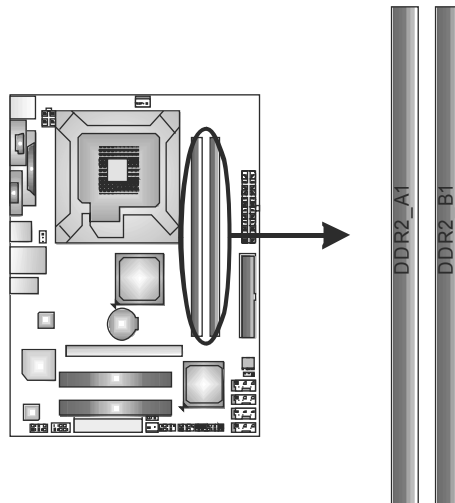

1. Unlock a DIMM slot by pressing the retaining clips outward. Align a DIMM on the slot so that the notch on the DIMM matches the break on the Slot.

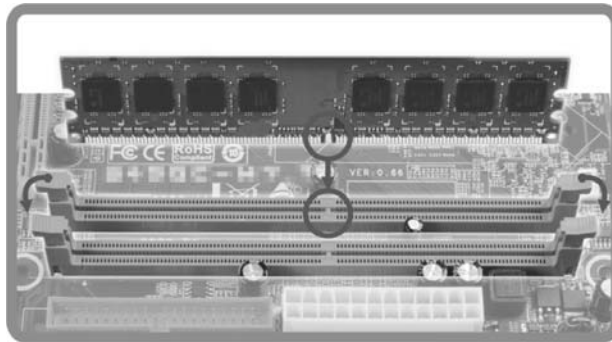

2. Insert the DIMM vertically and firmly into the slot until the retaining chip snap back in place and the DIMM is properly seated.

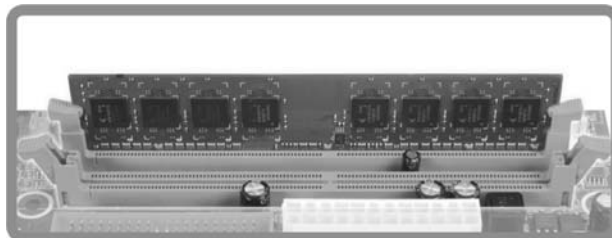

B. Memory Capacity

DIMM Socket Location	DDR2 Module	Total Memory Size
DDR2_A1	256MB/512MB/1GB/2GB	Max is 4GB.
DDR2_B1	256MB/512MB/1GB/2GB	

C. Dual Channel Memory Installation

Please refer to the following requirements to activate Dual Channel function:

Install memory module of the same density in pairs, shown in the table.

Dual Channel Status	DDR2_A1	DDR2_B1
Disabled	O	X
Disabled	X	O
Enabled	O	O

(O means memory installed, X means memory not installed.)

The DRAM bus width of the memory module must be the same(x8 or x16)

2.4 CONNECTORS AND SLOTS

FDD1: Floppy Disk Connector

The motherboard provides a standard floppy disk connector that supports 360K, 720K, 1.2M, 1.44M and 2.88M floppy disk types. This connector supports the provided floppy drive ribbon cables.

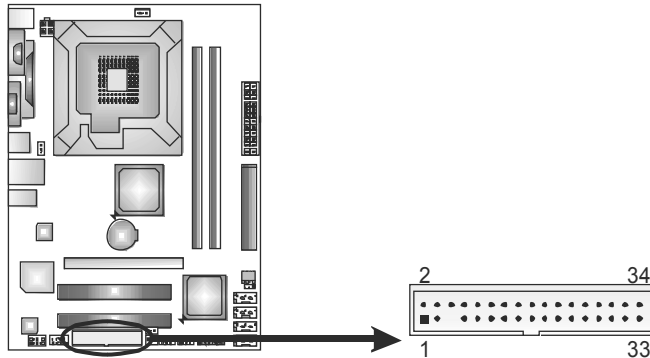

IDE1: IDE/ATAPI Connector

The motherboard has a 32-bit Enhanced PCI IDE Controller that provides PIO Mode 0~4, Bus Master, and Ultra DMA 33/66/100 functionality.

The IDE connector can connect a master and a slave drive, so you can connect up to two drives.

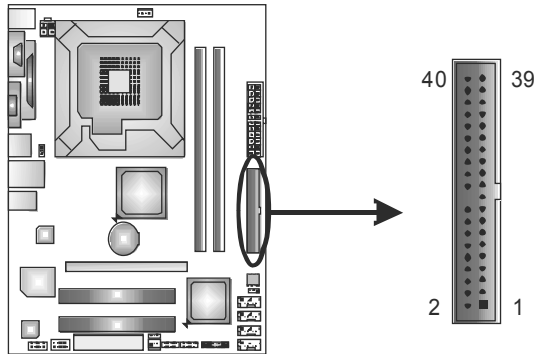

PEX16_1: PCI-Express x16 Slot

- PCI-Express 1.0a compliant.
- Maximum theoretical realized bandwidth of 4GB/s simultaneously per direction, for an aggregate of 8GB/s totally.
- PCI-Express supports a raw bit-rate of 2.5Gb/s on the data pins.
- 2X bandwidth over the traditional PCI architecture.

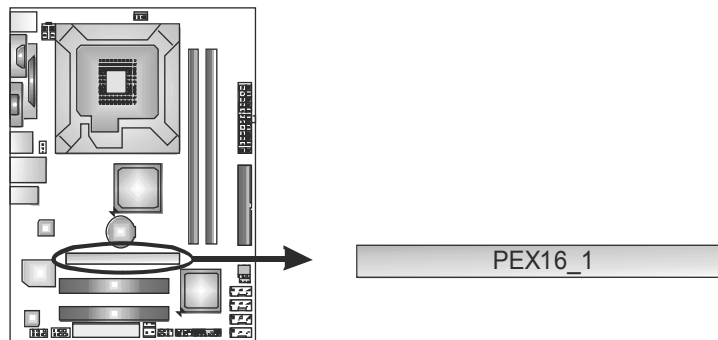

PCI1/PCI2: Peripheral Component Interconnect Slots

This motherboard is equipped with 2 standard PCI slots. PCI stands for Peripheral Component Interconnect, and it is a bus standard for expansion cards. This PCI slot is designated as 32 bits.

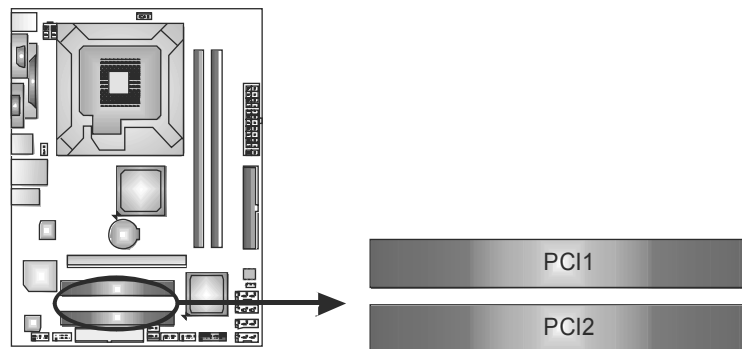

CHAPTER 3: HEADERS & JUMPERS SETUP

3.1 HOW TO SETUP JUMPERS

The illustration shows how to set up jumpers. When the jumper cap is placed on pins, the jumper is “close”, if not, that means the jumper is “open”.



Pin opened



Pin closed



Pin1-2 closed

3.2 DETAIL SETTINGS

PANEL1: Front Panel Header

This 16-pin connector includes Power-on, Reset, HDD LED, Power LED, and speaker connection. It allows user to connect the PC case’s front panel switch functions.

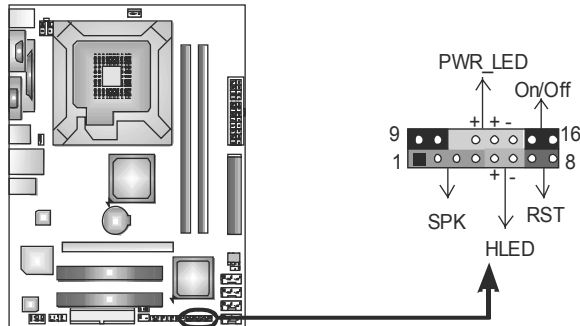

Pin	Assignment	Function	Pin	Assignment	Function
1	+5V	Speaker Connector	9	N/A	N/A
2	N/A		10	N/A	N/A
3	N/A		11	N/A	N/A
4	Speaker	Hard drive LED	12	Power LED (+)	Power LED
5	HDD LED (+)		13	Power LED (+)	
6	HDD LED (-)		14	Power LED (-)	
7	Ground	Reset button	15	Power button	Power-on button
8	Reset control		16	Ground	

ATXPWR1: ATX Power Source Connector

This connector allows user to connect 24-pin power connector on the ATX power supply.

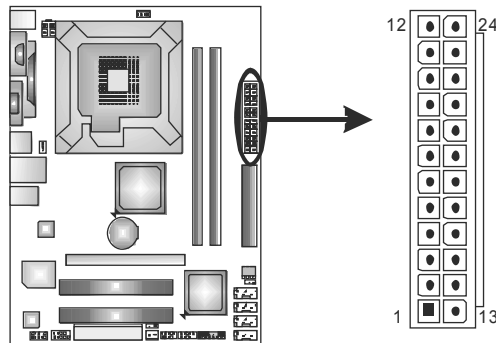

Pin	Assignment	Pin	Assignment
13	+3.3V	1	+3.3V
14	-12V	2	+3.3V
15	Ground	3	Ground
16	PS_ON	4	+5V
17	Ground	5	Ground
18	Ground	6	+5V
19	Ground	7	Ground
20	NC	8	PW_OK
21	+5V	9	Standby Voltage+5V
22	+5V	10	+12V
23	+5V	11	+12V
24	Ground	12	+3.3V

ATXPWR2: ATX Power Source Connector

By connecting this connector, it will provide +12V to CPU power circuit.

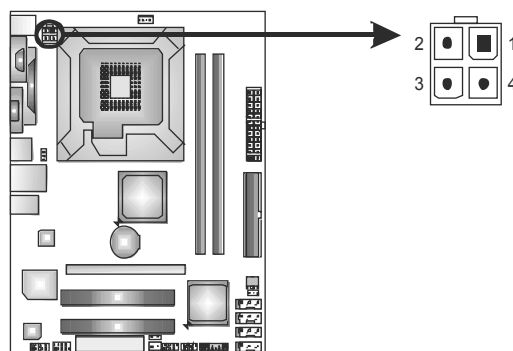

Pin	Assignment
1	+12V
2	+12V
3	Ground
4	Ground

Note:

Before power on the system, please make sure that both ATXPWR1 and ATXPWR2 connectors have been plugged-in.

F_USB1/F_USB2: Headers for USB 2.0 Ports at Front Panel

This motherboard provides 2 USB 2.0 headers, which allow user to connect additional USB cable on the PC front panel, and also can be connected with internal USB devices, like USB card reader.

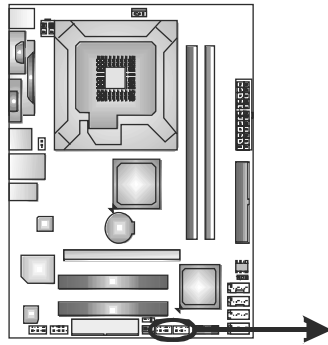

Pin	Assignment
1	+5V (fused)
2	+5V (fused)
3	USB-
4	USB-
5	USB+
6	USB+
7	Ground
8	Ground
9	Key
10	NC

F_AUDIOF1: Front Panel Audio Header

This header allows user to connect the front audio output cable with the PC front panel. This header allows only HD audio front panel connector; AC'97 connector is not acceptable.

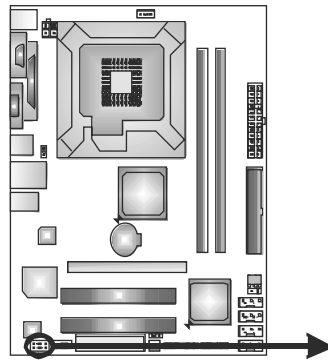

Pin	Assignment
1	Mic Left in
2	Ground
3	Mic Right in
4	GPIO
5	Right line in
6	Jack Sense
7	Front Sense
8	Key
9	Left line in
10	Jack Sense

JCMOS1: Clear CMOS Header

Placing the jumper on pin2-3 allows user to restore the BIOS safe setting and the CMOS data, please carefully follow the procedures to avoid damaging the motherboard.

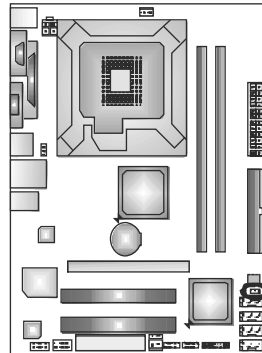

Pin 1-2 Close:
Normal Operation
(Default).



Pin 2-3 Close:
Clear CMOS data.

※ Clear CMOS Procedures:

1. Remove AC power line.
2. Set the jumper to "Pin 2-3 close".
3. Wait for five seconds.
4. Set the jumper to "Pin 1-2 close".
5. Power on the AC.
6. Reset your desired password or clear the CMOS data.

SATA1~SATA4: Serial ATA Connectors

The motherboard has a PCI to SATA Controller with 4channels SATA interface, it satisfies the SATA 2.0 spec and with transfer rate of 3Gb/s.

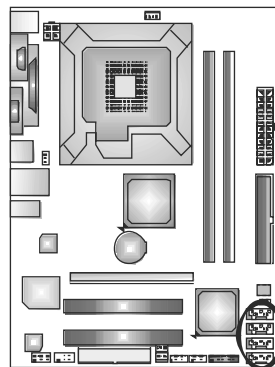

SATA4
SATA3
SATA2
SATA1



Pin	Assignment
1	Ground
2	TX+
3	TX-
4	Ground
5	RX-
6	RX+
7	Ground

JUSBV1/JUSBV2: Power Source Headers for USB Ports

Pin 1-2 Close:

JUSBV1: +5V for USB ports at USB1/RJ45USB1.

JUSBV2: +5V for USB ports at F_USB1/F_USB2.

Pin 2-3 Close:

JUSBV1: +5V STB for USB ports at USB1/RJ45USB1.

JUSBV2: +5V STB for USB ports at F_USB1/F_USB2.

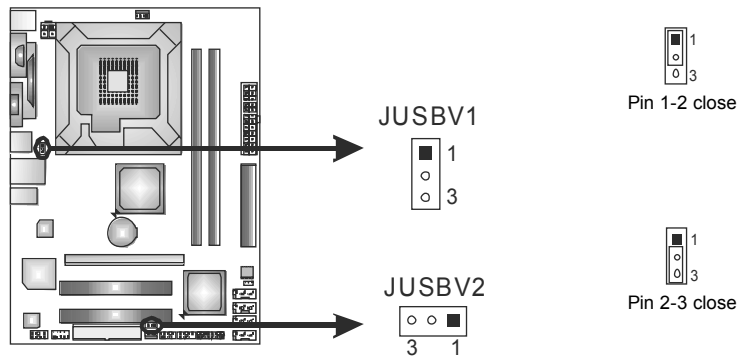

F_COM1: Serial port Connector (Optional)

The motherboard has a Serial Port Connector for connecting RS-232 Port.

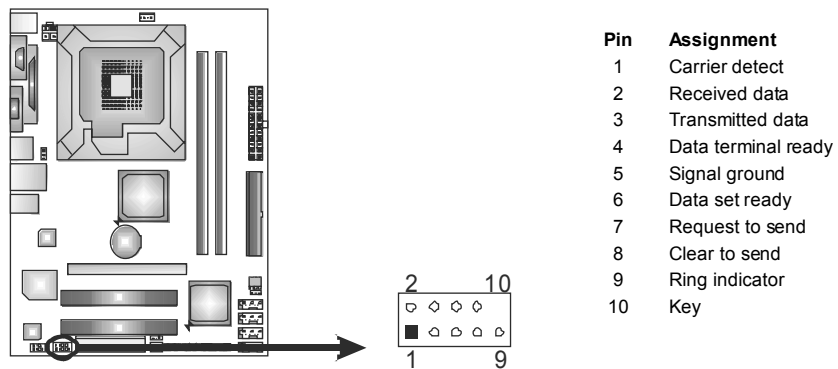

CHAPTER 4: USEFUL HELP

4.1 DRIVER INSTALLATION NOTE

After you installed your operating system, please insert the Fully Setup Driver CD into your optical drive and install the driver for better system performance.

You will see the following window after you insert the CD



The setup guide will auto detect your motherboard and operating system.

Note:

If this window didn't show up after you insert the Driver CD, please use file browser to locate and execute the file **SETUP.EXE** under your optical drive.

A. Driver Installation

To install the driver, please click on the Driver icon. The setup guide will list the compatible driver for your motherboard and operating system. Click on each device driver to launch the installation program.

B. Software Installation

To install the software, please click on the Software icon. The setup guide will list the software available for your system, click on each software title to launch the installation program.

C. Manual

Aside from the paperback manual, we also provide manual in the Driver CD. Click on the Manual icon to browse for available manual.

Note:

You will need Acrobat Reader to open the manual file. Please download the latest version of Acrobat Reader software from

<http://www.adobe.com/products/acrobat/readstep2.html>

4.2 SOFTWARE

Installing Software

1. Insert the Setup CD to the optical drive. The drivers installation program would appear if the Autorun function has been enabled.
2. Select **Software Installation**, and then click on the respective software title.
3. Follow the on-screen instructions to complete the installation.

Launching Software

After the installation process, you will see the software icon “eHOT Line” / “BIOS Update” appears on the desktop. Double-click the icon to launch the utility.

eHot-Line (Optional)

eHot-Line is a convenient utility that helps you to contact with our Tech-Support system. This utility will collect the system information which is useful for analyzing the problem you may have encountered, and then send these information to our tech-support department to help you fix the problem.

 Before you use this utility, please set Outlook Express as your default e-mail client application program.

*represents important information that you must provide. Without this information, you may not be able to send out the mail.

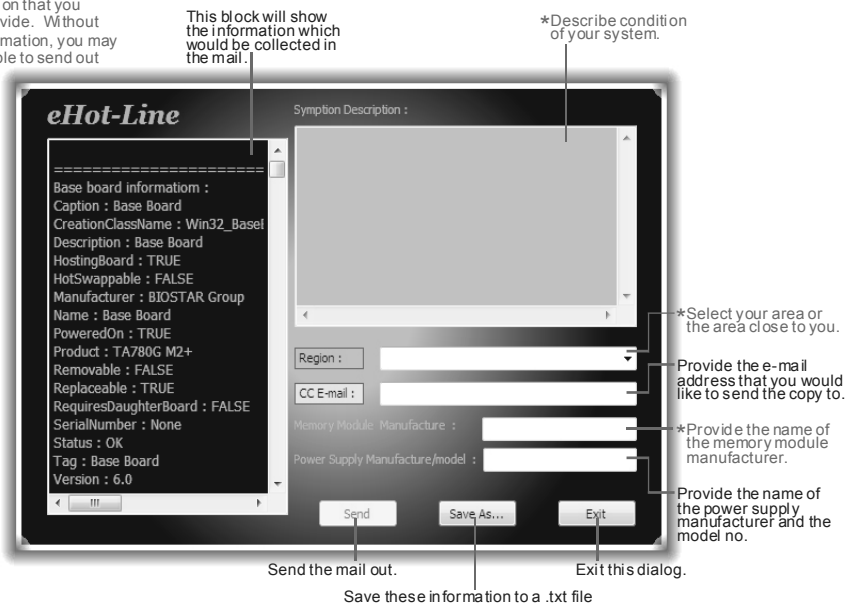

The screenshot shows the eHot-Line utility window. On the left, there is a list of system information under the heading "Base board information :". On the right, there is a "Symptom Description :" text area. Below these are several input fields: "Region :", "CC E-mail :", "Memory Module Manufacture :", and "Power Supply Manufacture/model :". At the bottom, there are three buttons: "Send", "Save As...", and "Exit".

Annotations for the screenshot:

- "This block will show the information which would be collected in the mail." points to the system information list.
- "*Describe condition of your system." points to the Symptom Description text area.
- "*Select your area or the area close to you." points to the Region dropdown menu.
- "Provide the e-mail address that you would like to send the copy to." points to the CC E-mail input field.
- "*Provide the name of the memory module manufacturer." points to the Memory Module Manufacture input field.
- "Provide the name of the power supply manufacturer and the model no." points to the Power Supply Manufacture/model input field.
- "Send the mail out." points to the Send button.
- "Save these information to a .txt file" points to the Save As... button.
- "Exit this dialog." points to the Exit button.

After filling up this information, click **“Send”** to send the mail out. A warning dialog would appear asking for your confirmation; click **“Send”** to confirm or **“Do Not Send”** to cancel.



If you want to save this information to a .txt file, click **“Save As...”** and then you will see a saving dialog appears asking you to enter file name.

Enter the file name and then click **“Save”**. Your system information will be saved to a .txt file.

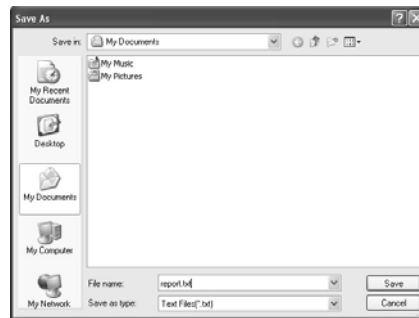

```

report - Notepad
File Edit Format View Help
=====
Base Board Information :
Caption : Base Board
CreationTime : win32_baseboard
Description : Base Board
Manufacturer : TRU
Motherboard : TRU
Name : Base Board
PowerOn : TRUE
Product : TP35D2-A7
SerialNumber :
Tag : Base Board
Version :
=====
BIOS Information :
Caption : Phoenix - AwardBIOS v6.00PG
CurrentLanguage : nUS1508850-1
Description : Phoenix - AwardBIOS v6.00PG
InstallLanguages : 3
Manufacturer : Phoenix Technologies, LTD
Name : Phoenix - AwardBIOS v6.00PG
ReleaseDate : 20071205000000.00000000
SerialNumber : 000
SMBIOSVersion : 4.00 PG
SMBIOSVersion : 3
SMBIOSVersion : 3
SMBIOSVersion : TRUE
SoftwareElementID : phoenix - AwardBIOS v6.00PG
Status : OK
VendorIdentifier : phoenix
Version : 0616 = A1304E31

```

Open the saved .txt file, you will see your system information including motherboard/BIOS/CPU/video/device/OS information. This information is also concluded in the sent mail.



We will not share customer’s data with any other third parties, so please feel free to provide your system information while using eHot-Line service.



If you are not using Outlook Express as your default e-mail client application, you may need to save the system information to a .txt file and send the file to our tech support with other e-mail application. Go to the following web <http://www.biostar.com.tw/app/en-us/about/contact.php> for getting our contact information.

BIOS Update

BIOS Update is a convenient utility which allows you to update your motherboard BIOS under Windows system.

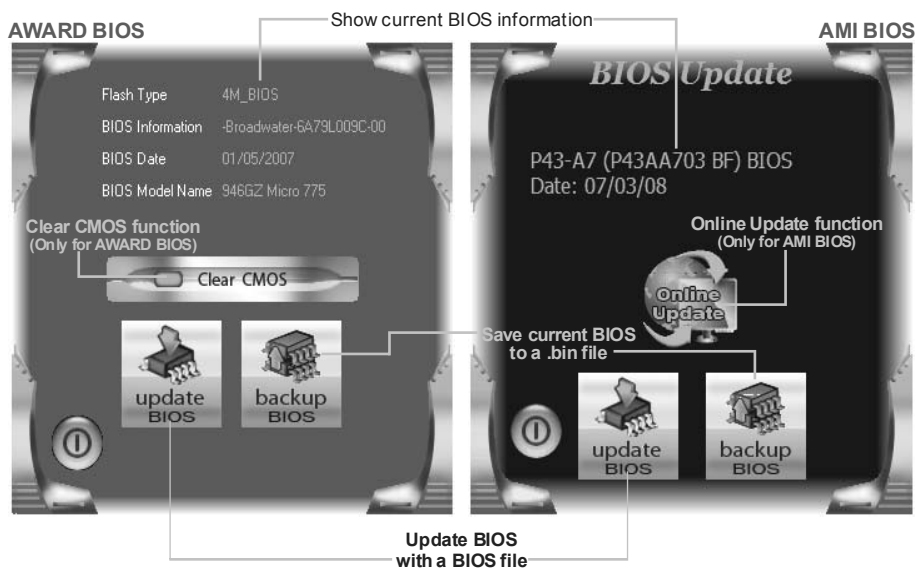

<Backup BIOS>

Once click on this button, the saving dialog will show. Choose the position to save file and enter file name. (We recommend that the file name should be English/number and no longer than 7 characters.) Then click **Save**.

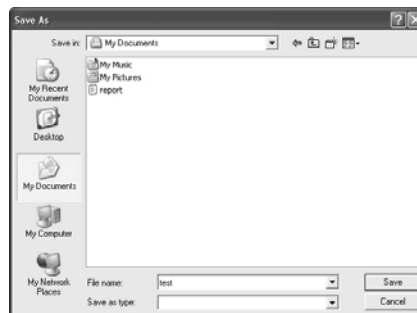

After the saving process, finish dialog will show. Click on **OK** to complete the BIOS Backup procedure.

<Update BIOS>

Before doing this, please download the proper BIOS file from the website.

For AWARD BIOS, update BIOS procedure should be run with Clear CMOS function, so please check on Clear CMOS first.

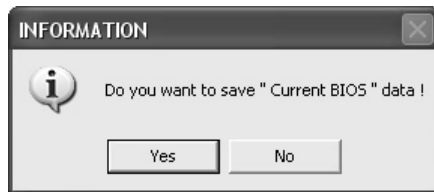

Then click Update BIOS button, a dialog will show for asking you backup current BIOS. Click **Yes** for BIOS backup and refer to the Backup BIOS procedure; or click **No** to skip this procedure.

After the BIOS Backup procedure, the open dialog will show for requesting the BIOS file which is going to be updated. Please choose the proper BIOS file for updating, then click on **Open**.

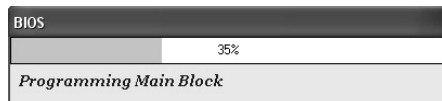
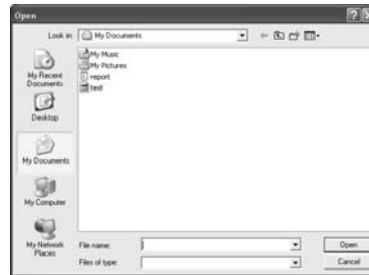

The utility will update BIOS with the proper BIOS file, and this process may take minutes. Please do not open any other applications during this process.

After the BIOS Update process, click on **OK** to restart the system.

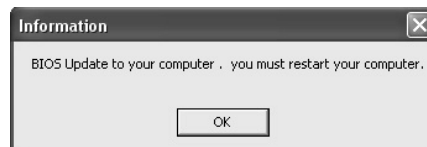

While the system boots up and the full screen logo shows, press  <Delete> key to enter BIOS setup.

In the BIOS setup, use the **Load Optimized Defaults** function and then **Save and Exit Setup** to exit BIOS setup. BIOS Update is completed.

<Online Update> (for AMI BIOS only)

Automatically download and update the latest BIOS via internet; **make sure that the computer is connected to the internet before using this function.**

After clicking on the **Online Update** button, the utility will search for the latest BIOS from internet. If there is a new BIOS version, the utility will ask you to download it. Click **Yes** to proceed.

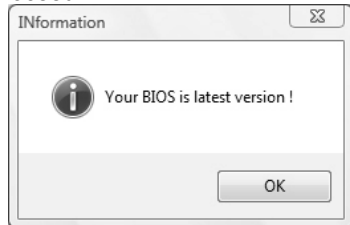
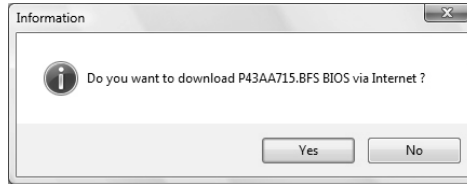

If there is no other newer BIOS version, the utility will also tell you that your BIOS has been the latest version.

Download completes; the utility will ask you to program (update) the BIOS. Click **Yes** to proceed.

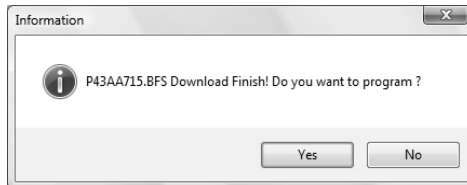

The programming procedure may take minutes, **please do not make any operation during the programming process.**

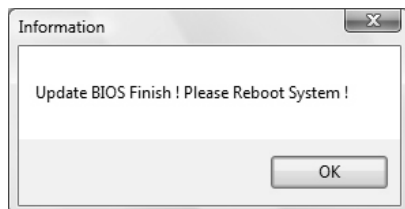

After the updating process, the utility will ask you to reboot the system. Click **OK** to reboot.

While the system boots up and the full screen logo shows, press  <Delete> key to enter BIOS setup.

In the BIOS setup, use the **Load Optimized Defaults** function and then **Save and Exit Setup** to exit BIOS setup. Online Update is completed.



All the information and content above about the T-Series software are subject to be changed without notice. For better performance, the software is being continuously updated. The information and pictures described above are for your reference only. The actual information and settings on board may be slightly different from this manual.

4.3 EXTRA INFORMATION

CPU Overheated

If the system shutdown automatically after power on system for seconds, that means the CPU protection function has been activated.

When the CPU is over heated, the motherboard will shutdown automatically to avoid a damage of the CPU, and the system may not power on again.

In this case, please double check:

1. The CPU cooler surface is placed evenly with the CPU surface.
2. CPU fan is rotated normally.
3. CPU fan speed is fulfilling with the CPU speed.

After confirmed, please follow steps below to relief the CPU protection function.

1. Remove the power cord from power supply for seconds.
2. Wait for seconds.
3. Plug in the power cord and boot up the system.

Or you can:

1. Clear the CMOS data.
(See "Close CMOS Header: JCMOS1" section)
2. Wait for seconds.
3. Power on the system again.

BIO-Flasher

BIO-Flasher is a BIOS flashing utility providing you an easy and simple way to update your BIOS via USB pen drive or floppy disk.

The BIO-Flasher is built in the BIOS chip. To enter the utility, **press <F12> during the Power-On Self Tests (POST)** procedure while booting up.

Updating BIOS with BIO-Flasher

1. Go to the website to download the latest BIOS file for the motherboard.
2. Then, save the BIOS file into a USB pen drive or a floppy disk.
3. Insert the USB pen drive or the floppy disk that contains the BIOS file to the USB port or the floppy disk drive.
4. Power on or reset the computer and then press **<F12>** during the **POST** process. A select dialog as the picture on the right appears. Select the device contains the BIOS file and press **<Enter>** to enter the utility.

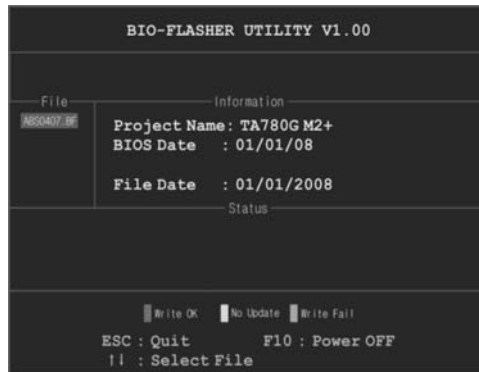

5. The utility will show the BIOS files and their respective information. Select the proper BIOS file and press **<Enter>** then **<Y>** to perform the BIOS update process.

6. After the update process, the utility will ask you to reboot the system. Press **<Y>** to proceed. BIOS update completes.



- This utility only allows storage device with FAT32/16 format and single partition.
- Shutting down or resetting the system while updating the BIOS will lead to system boot failure.

4.4 AMI BIOS BEEP CODE

Boot Block Beep Codes

Number of Beeps	Description
1	No media present. (Insert diskette in floppy drive A:)
2	"AMIBOOT.ROM" file not found in root directory of diskette in A:
3	Insert next diskette if multiple diskettes are used for recovery
4	Flash Programming successful
5	File read error
7	No Flash EPROM detected
10	Flash Erase error
11	Flash Program error
12	"AMIBOOT.ROM" file size error
13	BIOS ROM image mismatch (file layout does not match image present in flash device)

POST BIOS Beep Codes

Number of Beeps	Description
1	Memory refresh timer error
3	Base memory read/write test error
6	Keyboard controller BAT command failed
7	General exception error (processor exception interrupt error)
8	Display memory error (system video adapter)

Troubleshooting POST BIOS Beep Codes

Number of Beeps	Troubleshooting Action
1, 3	Reseat the memory, or replace with known good modules.
6, 7	<p>Fatal error indicating a serious problem with the system. Consult your system manufacturer. Before declaring the motherboard beyond all hope, eliminate the possibility of interference by a malfunctioning add-in card. Remove all expansion cards except the video adapter.</p> <ul style="list-style-type: none"> ● If beep codes are generated when all other expansion cards are absent, consult your system manufacturer's technical support. ● If beep codes are not generated when all other expansion cards are absent, one of the add-in cards is causing the malfunction. Insert the cards back into the system one at a time until the problem happens again. This will reveal the malfunctioning card.
8	If the system video adapter is an add-in card, replace or reseat the video adapter. If the video adapter is an integrated part of the system board, the board may be faulty.

4.5 TROUBLESHOOTING

Probable	Solution
<ol style="list-style-type: none"> 1. There is no power in the system. Power LED does not shine; the fan of the power supply does not work 2. Indicator light on keyboard does not shine. 	<ol style="list-style-type: none"> 1. Make sure power cable is securely plugged in. 2. Replace cable. 3. Contact technical support.
<p>System is inoperative. Keyboard lights are on, power indicator lights are lit, and hard drives are running.</p>	<p>Using even pressure on both ends of the DIMM, press down firmly until the module snaps into place.</p>
<p>System does not boot from a hard disk drive, but can be booted from optical drive.</p>	<ol style="list-style-type: none"> 1. Check cable running from disk to disk controller board. Make sure both ends are securely plugged in; check the drive type in the standard CMOS setup. 2. Backing up the hard drive is extremely important. All hard disks are capable of breaking down at any time.
<p>System only boots from an optical drive. Hard disks can be read, applications can be used, but system fails to boot from a hard disk.</p>	<ol style="list-style-type: none"> 1. Back up data and applications files. 2. Reformat the hard drive. Re-install applications and data using backup disks.
<p>Screen message shows "Invalid Configuration" or "CMOS Failure."</p>	<p>Review system's equipment. Make sure correct information is in setup.</p>
<p>System cannot boot after user installs a second hard drive.</p>	<ol style="list-style-type: none"> 1. Set master/slave jumpers correctly. 2. Run SETUP program and select correct drive types. Call the drive manufacturers for compatibility with other drives.

This page is intentionally left blank.

APPENDIX: SPEC IN OTHER LANGUAGES

GERMAN

<i>Spezifikationen</i>		
CPU	LGA 775 Intel Core2Quad / Core2Duo / Pentium Dual-Core / Celeron Dual-Core / Celeron 4xx Prozessoren (Maximales Watt: 95W)	Unterstützt Hyper-Threading / Execute Disable Bit / Enhanced Intel SpeedStep® / Intel Architecture-64 / Extended Memory 64 Technology / Virtualization Technology
FSB	800 / 1066 / 1333 MHz	
Chipsatz	Intel G31 Intel ICH7	
Super E/A	ITE 8718F Bietet die häufig verwendeten alten Super E/A-Funktionen. Low Pin Count-Schnittstelle	Umgebungskontrolle, Hardware-Überwachung Lüfterdrehzahl-Controller/-Überwachung "Smart Guardian"-Funktion von ITE
Arbeitsspeicher	DDR2 DIMM-Steckplätze x 2 Jeder DIMM unterstützt 256MB / 512MB / 1GB / 2GB DDR2. Max. 4GB Arbeitsspeicher	Dual-Kanal DDR2 Speichermodul Unterstützt DDR2 800/667 registrierte DIMMs. ECC DIMMs werden nicht unterstützt.
Grafik	GMA 3100	Max. 256MB gemeinsam benutzter Videospeicher
IDE	Integrierter IDE-Controller	Ultra DMA 33 / 66 / 100 Bus Master-Modus Unterstützt PIO-Modus 0~4,
SATA	Integrierter Serial ATA-Controller	Datentransferrate bis zu 3.0Gb/s Konform mit der SATA-Spezifikation Version 2.0.
LAN	Realtek RTL 8111DL	10 / 100 Mb/s / 1Gb/s Auto-Negotiation Halb-/ Vollduplex-Funktion
HD Audio-Unterstützung	ALC662	Unterstützt High-Definition Audio 5.1-Kanal-Audioausgabe

Spezifikationen			
Steckplätze	PCI-Steckplatz	x2	
	PCI Express x16 Steckplatz	x1	
Onboard-Anschluss	Diskettenlaufwerkanschluss	x1	Jeder Anschluss unterstützt 2 Diskettenlaufwerke
	Serieller Anschluss (fakultativ)	x1	
	IDE-Anschluss	x1	Jeder Anschluss unterstützt 2 IDE-Laufwerke
	SATA-Anschluss	x4	Jeder Anschluss unterstützt 1 SATA-Laufwerk
	Fronttafelanschluss	x1	Unterstützt die Fronttafel-Funktionen
	Front-Audioanschluss	x1	Unterstützt die Fronttafel-Audioanschlussfunktion
	CPU-Lüfter-Sockel	x1	CPU-Lüfterstromversorgungsanschluss (mit Smart Fan-Funktion)
	System-Lüfter-Sockel	x1	System-Lüfter-Stromversorgungsanschluss
	"CMOS löschen"-Sockel	x1	
	USB-Anschluss	x2	Jeder Anschluss unterstützt 2 Fronttafel-USB-Anschlüsse
Stromanschluss (24-polig)	x1		
Stromanschluss (4-polig)	x1		
Rückseiten-E/A	PS/2-Tastatur	x1	
	PS/2-Maus	x1	
	Serieller Anschluss	x1	
	Druckeranschluss	x1	
	VGA-Anschluss	x1	
	LAN-Anschluss	x1	
	USB-Anschluss	x4	
Audioanschluss	x3		
Platinengröße	190 mm (B) X 244 mm (L)		
OS-Unterstützung	Windows 2000 / XP / Vista 32 / Vista 64	Biostar behält sich das Recht vor, ohne Ankündigung die Unterstützung für ein Betriebssystem hinzuzufügen oder zu entfernen.	

FRENCH

SPEC		
UC	LGA 775 Processeurs Intel Core2Quad / Core2Duo / Pentium Dual-Core / Celeron Dual-Core / Celeron 4xx (Watt maximum : 95W)	Prend en charge les technologies Hyper-Threading / d'exécution de bit de désactivation / Intel SpeedStep® optimisée/ d'architecture Intel 64 / de mémoire étendue 64 / de virtualisation
Bus frontal	800 / 1066 / 1333 MHz	
Chipset	Intel G31 Intel ICH7	
Super E/S	ITE 8718F Fournit la fonctionnalité de Super E/S patrimoniales la plus utilisée. Interface à faible compte de broches	Initiatives de contrôle environnementales, Moniteur de matériel Contrôleur /moniteur de vitesse de ventilateur Fonction "Gardien intelligent" de l'ITE
Mémoire principale	Fentes DDR2 DIMM x 2 Chaque DIMM prend en charge des DDR2 de 256Mo / 512Mo / 1Go / 2Go Capacité mémoire maximale de 4Go	Module de mémoire DDR2 à mode à double voie Prend en charge la DDR2 800/667 Les DIMM à registres et DIMM avec code correcteurs d'erreurs ne sont pas prises en charge
Graphiques	GMA 3100	Mémoire vidéo partagée maximale de 256 Mo
IDE	Contrôleur IDE intégré	Mode principale de Bus Ultra DMA 33 / 66 / 100 Prend en charge le mode PIO 0~4,
SATA	Contrôleur Serial ATA intégré	Taux de transfert jusqu'à 3.0Go/s. Conforme à la spécification SATA Version 2.0
LAN	Realtek RTL 8111DL	10 / 100 Mb/s / 1Gb/s négociation automatique Half / Full duplex capability
Prise en charge audio HD	ALC662	Prise en charge de l'audio haute définition Sortie audio à 5.1 voies
Fentes	Fente PCI x2 Fente PCI Express x16 x1	
Connecteur embarqué	Connecteur de disquette x1 Port série (optionnel) x1 Connecteur IDE x1	Chaque connector prend en charge 2 lecteurs de disquettes Chaque connecteur prend en charge 2 périphériques IDE

SPEC			
	Connecteur SATA	x4	Chaque connecteur prend en charge 1 périphérique SATA
	Connecteur du panneau avant	x1	Prend en charge les équipements du panneau avant
	Connecteur Audio du panneau avant	x1	Prend en charge la fonction audio du panneau avant
	Embase de ventilateur UC	x1	Alimentation électrique du ventilateur UC (avec fonction de ventilateur intelligent)
	Embase de ventilateur système	x1	Alimentation électrique du ventilateur système
	Embase d'effacement CMOS	x1	
	Connecteur USB	x2	Chaque connecteur prend en charge 2 ports USB de panneau avant
	Connecteur d'alimentation (24 broches)	x1	
	Connecteur d'alimentation (4 broches)	x1	
E/S du panneau arrière	Clavier PS/2	x1	
	Souris PS/2	x1	
	Port série	x1	
	Port d'imprimante	x1	
	Port VGA	x1	
	Port LAN	x1	
	Port USB	x4	
	Fiche audio	x3	
Dimensions de la carte	190 mm (l) X 244 mm (H)		
Support SE	Windows 2000 / XP / Vista 32 / Vista 64		Biostar se réserve le droit d'ajouter ou de supprimer le support de SE avec ou sans préavis.

ITALIAN

SPECIFICA		
CPU	LGA 775 Processore Intel Core2Quad / Core2Duo /Pentium Dual-Core / Celeron Dual-Core / Celeron 4xx (Watt massimo: 95W)	Supporto di Hyper-Threading / Execute Disable Bit / Enhanced Intel SpeedStep® / Architettura Intel 64 / Tecnologia Extended Memory 64 / Tecnologia Virtualization
FSB	800 / 1066 / 1333 MHz	
Chipset	Intel G31 Intel ICH7	
Super I/O	ITE 8718F Fornisce le funzionalità legacy Super I/O usate più comunemente. Interfaccia LPC (Low Pin Count)	Funzioni di controllo dell'ambiente: Monitoraggio hardware Controller / Monitoraggio velocità ventolina Funzione "Smart Guardian" di ITE
Memoria principale	Alloggi DIMM DDR2 x 2 Ciascun DIMM supporta DDR2 256MB / 512MB / 1GB / 2GB Capacità massima della memoria 4GB	Modulo di memoria DDR2 a canale doppio Supporto di DDR2 800/667 DIMM registrati e DIMM ECC non sono supportati
Grafica	GMA 3100	La memoria video condivisa massima è di 256MB
IDE	Controller IDE integrato	Modalità Bus Master Ultra DMA 33 / 66 / 100 Supporto modalità PIO Mode 0-4
SATA	Controller Serial ATA integrato	Velocità di trasferimento dei dati fino a 3.0Gb/s. Compatibile specifiche SATA Versione 2.0.
LAN	Realtek RTL 8111DL	Negoziazione automatica 10 / 100 Mb/s / 1Gb/s Capacità Half / Full Duplex
Supporto audio HD	ALC662	Supporto audio High-Definition (HD) Uscita audio 5.1 canali
Alloggi	Alloggio PCI x2 Alloggio PCI Express x16 x1	
Connettori su scheda	Connettore floppy x1 Porta seriale (facoltativo) x1	Ciascun connettore supporta 2 unità Floppy

SPECIFICA			
	Connettore IDE	x1	Ciascun connettore supporta 2 unità IDE
	Connettore SATA	x4	Ciascun connettore supporta 1 unità SATA
	Connettore pannello frontale	x1	Supporta i servizi del pannello frontale
	Connettore audio frontale	x1	Supporta la funzione audio pannello frontale
	Collettore ventolina CPU	x1	Alimentazione ventolina CPU (con funzione Smart Fan)
	Collettore ventolina sistema	x1	Alimentazione ventolina di sistema
	Collettore cancellazione CMOS	x1	
	Connettore USB	x2	Ciascun connettore supporta 2 porte USB pannello frontale
	Connettore alimentazione (24 pin)	x1	
	Connettore alimentazione (4 pin)	x1	
I/O pannello posteriore	Tastiera PS/2	x1	
	Mouse PS/2	x1	
	Porta seriale	x1	
	Porta stampante	x1	
	Porta VGA	x1	
	Porta LAN	x1	
	Porta USB	x4	
	Connettore audio	x3	
Dimensioni scheda	190 mm (larghezza) x 244 mm (altezza)		
Sistemi operativi supportati	Windows 2000 / XP / Vista 32 / Vista 64		Biostar si riserva il diritto di aggiungere o rimuovere il supporto di qualsiasi sistema operativo senza preavviso.

SPANISH

Especificación		
CPU	LGA 775 Procesador Intel Core2Quad / Core2Duo / Pentium Dual-Core / Celeron Dual-Core / Celeron 4xx (Vatio máximo: 95W)	Admite Hyper-Threading / Bit de deshabilitación de ejecución / Intel SpeedStep® Mejorado / Intel Architecture-64 / Tecnología Extended Memory 64 / Tecnología de virtualización
FSB	800 / 1066 / 1333 MHz	
Conjunto de chips	Intel G31 Intel ICH7	
Súper E/S	ITE 8718F Le ofrece las funcionalidades heredadas de uso más común Súper E/S. Interfaz de cuenta Low Pin	Iniciativas de control de entorno, Monitor hardware Controlador/monitor de velocidad de ventilador Función "Guardia inteligente" de ITE
Memoria principal	Ranuras DIMM DDR2 x 2 Cada DIMM admite DDR de 256MB / 512MB / 1GB / 2GB Capacidad máxima de memoria de 4GB	Módulo de memoria DDR2 de canal Doble Admite DDR2 de 800/667 No admite DIMM registrados o DIMM compatibles con ECC
Gráficos	GMA 3100	Memoria máxima de vídeo compartida de 256MB
IDE	Controlador IDE integrado	Modo bus maestro Ultra DMA 33 / 66 / 100 Soporte los Modos PIO 0~4,
SATA	Controlador ATA Serie Integrado	Tasas de transferencia de hasta 3.0 Gb/s. Compatible con la versión SATA 2.0.
Red Local	Realtek RTL 8111DL	Negociación de 10 / 100 Mb/s / 1Gb/s Funciones Half / Full dúplex
Soporte de sonido HD	ALC662	Soporte de sonido de Alta Definición Salida de sonido de 5.1 canales
Ranuras	Ranura PCI X2 Ranura PCI Express x16 X1	
Conectores en placa	Conector disco flexible X1	Cada conector soporta 2 unidades de disco flexible
	Puerto serie (opcional) X1	
	Conector IDE X1	Cada conector soporta 2 dispositivos IDE

Especificación			
	Conector SATA	X4	Cada conector soporta 1 dispositivos SATA
	Conector de panel frontal	X1	Soporta instalaciones en el panel frontal
	Conector de sonido frontal	X1	Soporta funciones de sonido en el panel frontal
	Cabecera de ventilador de CPU	X1	Fuente de alimentación de ventilador de CPU (con función Smart Fan)
	Cabecera de ventilador de sistema	X1	Fuente de alimentación de ventilador de sistema
	Cabecera de borrado de CMOS	X1	
	Conector USB	X2	Cada conector soporta 2 puertos USB frontales
	Conector de alimentación (24 patillas)	X1	
	Conector de alimentación (4 patillas)	X1	
Panel trasero de E/S	Teclado PS/2	X1	
	Ratón PS/2	X1	
	Puerto serie	X1	
	Puerto de impresora	X1	
	Puerto VGA	X1	
	Puerto de red local	X1	
	Puerto USB	X4	
	Conector de sonido	X3	
Tamaño de la placa	190 mm. (A) X 244 Mm. (H)		
Soporte de sistema operativo	Windows 2000 / XP / Vista 32 / Vista 64		Biostar se reserva el derecho de añadir o retirar el soporte de cualquier SO con o sin aviso previo.

PORTUGUESE

ESPECIFICAÇÕES		
CPU	LGA 775 Processador Intel Core2Quad / Core2Duo / Pentium Dual-Core / Celeron Dual-Core / Celeron 4xx (Watt máximo: 95W)	Suporta as tecnologias Hyper-Threading / Execute Disable Bit / Enhanced Intel SpeedStep® / Intel Architecture -64 / Extended Memory 64 / Virtualization
FSB	800 / 1066 / 1333 MHz	
Chipset	Intel G31 Intel ICH7	
Especificação do Super I/O	ITE 8718F Proporciona as funcionalidades mais utilizadas em termos da especificação Super I/O. Interface LPC (Low Pin Count).	Iniciativas para controlo do ambiente Monitorização do hardware Controlador/Monitor da velocidade da ventoinha Função "Smart Guardian" da ITE
Memória principal	Ranuras DIMM DDR2 x 2 Cada módulo DIMM suporta uma memória DDR2 de 256 MB / 512 MB / 1GB / 2GB Capacidade máxima de memória: 4 GB	Módulo de memória DDR2 de canal duplo Suporta módulos DDR2 800/667 Os módulos DIMM registados e os DIMM ECC não são suportados
Placa gráfica	GMA 3100	Memória de vídeo máxima partilhada: 256 MB
IDE	Controlador IDE integrado	Modo Bus master Ultra DMA 33 / 66 / 100 Suporta o modo PIO 0~4,
SATA	Controlador Serial ATA integrado	Velocidades de transmissão de dados até 3.0 Gb/s. Compatibilidade com a especificação SATA versão 2.0.
LAN	Realtek RTL 8111DL	Auto negociação de 10 / 100 Mb/s / 1Gb/s Capacidade semi/full-duplex
Suporte para áudio de alta definição	ALC662	Suporta a especificação High-Definition Audio Saída de áudio de 5.1 canais
Ranuras	Ranura PCI x2 Ranura PCI Express x16 x1	

ESPECIFICAÇÕES				
Conectores na placa	Conector da unidade de disquetes	x1	Cada conector suporta 2 unidades de disquetes	
	Porta série (opcional)	x1		
	Conector IDE	x1		Cada conector suporta 2 dispositivos IDE
	Conector SATA	x4		Cada conector suporta 1 dispositivo SATA
	Conector do painel frontal	x1		Para suporte de várias funções no painel frontal
	Conector de áudio frontal	x1		Suporta a função de áudio no painel frontal
	Conector da ventoinha da CPU	x1		Alimentação da ventoinha da CPU (com a função Smart Fan)
	Conector da ventoinha do sistema	x1		Alimentação da ventoinha do sistema
	Conector para limpeza do CMOS	x1		
	Conector USB	x2		Cada conector suporta 2 portas USB no painel frontal
	Conector de alimentação (24 pinos)	x1		
Conector de alimentação (4 pinos)	x1			
Entradas/S aídas no painel traseiro	Teclado PS/2	x1		
	Rato PS/2	x1		
	Porta série	x1		
	Porta para impressora	x1		
	Porta VGA	x1		
	Porta LAN	x1		
	Porta USB	x4		
Tomada de áudio	x3			
Tamanho da placa	190 mm (L) X 244 mm (A)			
Sistemas operativos suportados	Windows 2000 / XP / Vista 32 / Vista 64		A Biostar reserva-se o direito de adicionar ou remover suporte para qualquer sistema operativo com ou sem aviso prévio.	

POLISH

<i>SPEC</i>		
Procesor	LGA 775 Procesor Intel Core2Quad / Core2Duo /Pentium Dual-Core / Celeron Dual-Core / Celeron 4xx (Maksymalny Watt: 95W)	Obsługa Hyper-Threading / Execute Disable Bit / Enhanced Intel SpeedStep® / Intel Architecture-64 / Extended Memory 64 Technology / Virtualization Technology
FSB	800 / 1066 / 1333 MHz	
Chipset	Intel G31 Intel ICH7	
Pamięć główna	Gniazda DDR2 DIMM x 2 Każde gniazdo DIMM obsługuje moduły 256MB / 512MB / 1GB / 2GB Maks. wielkość pamięci 4GB	Moduł pamięci DDR2 z trybem podwójnego kanału Obsługa DDR2 800/667 Brak obsługi Registered DIMM oraz ECC DIMM
Grafika	GMA 3100	Maks. wielkość współdzielonej pamięci video wynosi 256MB
Super I/O	ITE 8718F Zapewnia najbardziej powszechne funkcje Super I/O. Interfejs Low Pin Count	Funkcje kontroli warunków pracy, Monitor H/W Kontroler/Monitor prędkości wentylatora Funkcja ITE "Smart Guardian"
IDE	Zintegrowany kontroler IDE	Ultra DMA 33 / 66 / 100 Tryb Bus Master obsługa PIO tryb 0~4,
SATA	Zintegrowany kontroler Serial ATA	Transfer danych do 3.0 Gb/s. Zgodność ze specyfikacją SATA w wersji 2.0.
LAN	Realtek RTL 8111DL	10 / 100 Mb/s / 1Gb/s z automatyczną negocjacją szybkości Działanie w trybie półwiznego / pełnego duplexu
Obsługa audio HD	ALC662	Obsługa High-Definition Audio 5.1 kanałowe wyjście audio
Gniazda	Gniazdo PCI x2 Gniazdo PCI Express x16 x1	
Złącza wbudowane	Złącze napędu dyskietek x1 Port szeregowy (Dowolny) x1	Każde złącze obsługuje 2 napędy dyskietek

SPEC			
	Złącze IDE	x1	Każde złącze obsługuje 2 urządzenia IDE
	Złącze SATA	x4	Każde złącze obsługuje 1 urządzenie SATA
	Złącze panela przedniego	x1	Obsługa elementów panela przedniego
	Przednie złącze audio	x1	Obsługa funkcji audio na panelu przednim
	Złącze główkowe wentylatora procesora	x1	Zasilanie wentylatora procesora (z funkcją Smart Fan)
	Złącze główkowe wentylatora systemowego	x1	Zasilanie wentylatora systemowego
	Złącze główkowe kasowania CMOS	x1	
	Złącze USB	x2	Każde złącze obsługuje 2 porty USB na panelu przednim
	Złącze zasilania (24 pinowe)	x1	
	Złącze zasilania (4 pinowe)	x1	
Back Panel I/O	Klawiatura PS/2	x1	
	Mysz PS/2	x1	
	Port szeregowy	x1	
	Port drukarki	x1	
	Port VGA	x1	
	Port LAN	x1	
	Port USB	x4	
	Gniazdo audio	x3	
Wymiary płyty	190 mm (S) X 244 mm (W)		
Obsługa systemu operacyjnego	Windows 2000 / XP / Vista 32 / Vista 64		Biostar zastrzega sobie prawo dodawania lub odwoływania obsługi dowolnego systemu operacyjnego bez powiadomienia.

RUSSIAN

СПЕЦ		
CPU (центральный процессор)	LGA 775 Процессор Intel Core2Quad / Core2Duo / Pentium Dual-Core / Celeron Dual-Core / Celeron 4xx (Максимальный ватт: 95W)	Поддержка технологий Hyper-Threading / Execute Disable Bit / Enhanced Intel SpeedStep® / Intel Architecture-64 / Extended Memory 64 Technology / технологии виртуализация
FSB	800 / 1066 / 1333 МГц	
Набор микросхем	Intel G31 Intel ICH7	
Основная память	Слоты DDR2 DIMM x 2 Каждый модуль DIMM поддерживает 256 МБ / 512МБ / 1ГБ / 2ГБ DDR2 Максимальная ёмкость памяти 4ГБ	Модуль памяти с двухканальным режимом DDR2 Поддержка DDR2 800/667 Не поддерживает зарегистрированные модули DIMM and ECC DIMM
Графика	GMA 3100	Максимальная совместно используемая видео память составляет 256 МБ
Super I/O	ITE 8718F Обеспечивает наиболее используемые действующие функциональные возможности Super I/O. Интерфейс с низким количеством выводов	Инициативы по охране окружающей среды, Аппаратный монитор Регулятор скорости вентилятора/ монитор Функция ITE "Smart Guardian" (Интеллектуальная защита)
IDE	Встроенное устройство управления встроенными интерфейсами устройств	Режим "хозяина" шины Ultra DMA 33 / 66 / 100 Поддержка режима PIO 0~4,
SATA	Встроенное последовательное устройство управления ATA	скорость передачи данных до 3.0 гигабит/с. Соответствие спецификации SATA версия 2.0.
Локальная сеть	Realtek RTL 8111DL	Автоматическое согласование 10 / 100 / 1000 Мб/с Частичная / полная дуплексная способность
Звуковая поддержка жесткого диска	ALC662	Звуковая поддержка High-Definition 5.1канальный звуковой выход
Слоты	Слот PCI x2 Слот PCI Express x16 x1	
Встроенный разъём	Разъём НГМД x1 Последовательный порт (опционно) x1 Разъём IDE x1	Каждый разъём поддерживает 2 накопителя на гибких магнитных дисках Каждый разъём поддерживает 2 встроенных интерфейса накопителей

СПЕЦ			
	Разъём SATA	x4	Каждый разъём поддерживает 1 устройство SATA
	Разъём на лицевой панели	x1	Поддержка устройств на лицевой панели
	Входной звуковой разъём	x1	Поддержка звуковых функций на лицевой панели
	Контактирующее приспособление вентилятора центрального процессора	x1	Источник питания для вентилятора центрального процессора (с функцией интеллектуального вентилятора)
	Контактирующее приспособление вентилятора системы	x2	Источник питания для вентилятора системы
	Открытое контактирующее приспособление CMOS	x1	
	USB-разъём	x2	Каждый разъём поддерживает 2 USB-порта на лицевой панели
	Разъём питания (24 вывод)	x1	
	Разъём питания (4 вывод)	x1	
Задняя панель средств ввода-вывода	Клавиатура PS/2	x1	
	Мышь PS/2	x1	
	Последовательный порт	x1	
	Порт подключения принтера	x1	
	Порт VGA	x1	
	Порт LAN	x1	
	USB-порт	x4	
	Гнездо для подключения наушников	x3	
Размер панели	190 мм (Ш) X 244 мм (В)		
Поддержка OS	Windows 2000 / XP / Vista 32 / Vista 64		Biostar сохраняет за собой право добавлять или удалять средства обеспечения для OS с или без предварительного уведомления.

ARABIC

للمواصفات		
Hyper-Threading / Execute Disable Bit / Enhanced Intel SpeedStep® / Intel Architecture-64 / Extended Memory 64 Technology / Virtualization Technology	LGA 775 Intel Core2Quad / Core2Duo معالجات /Pentium Dual-Core / Celeron Dual-Core / تتردد يصل إلى Celeron 4xx (95: قصوى واط)	وحدة المعالجة المركزية
	ميجا هرتز 800 / 1066 / 1333 تردد	النقل الأمامي الجانبي
	Intel G31 Intel ICH7	مجموعة الشرائح
مزدوجة القناة DDR2 وحدة ذاكرة سعت 800/667 ميجا بايت DDR2 تدعم الذاكرة من نوع ECC وذلك التي لا تتوافق مع DIMM لا تدعم رقائق الذاكرة	قحمة DDR2 DIMM عدد 2 سعة DDR2 تدعم ذاكرة من نوع DIMM كل قحمة ميجا بايت 2 و 1 جيجا بايت 256/512 سعة ذاكرة قصوى 4 جيجا بايت	الذاكرة الرئيسية
	GMA 3100	بطاقة الرسومات
وسائل التحكم في البيئة: مراقب لمعرفة حالة الأجهزة مراقب في سرعة المروحة من ITE "Smart Guardian" وظيفة	ITE 8718F الأكثر استخداماً Super I/O ووظيفة Low Pin Count Interface تدعم تقنية	Super I/O
وضع رئيسي Ultra DMA 33 / 66 / 100 نقل بتقنية PIO Mode 0~4 دعم وضع	متكامل IDE متحكم	منفذ IDE
جيجابت/ثانية 3.0 نقل البيانات بسرعات تصل إلى 2.0 الإصدار SATA مطابقة للمواصفات	متكامل Serial ATA متحكم	SATA
تعارض تلقائي 100/10 ميجا بايت / ثانية و 1 جيجا بت/ثانية إمكانية النقل المزدوج الكامل/القصفي	Realtek RTL 8111DL	شبكة داخلية
تدعم تقنية الصوت عالي التعريف من 5.1 قنوات لخرج الصوت	ALC662	دعم الصوت عالي التعريف

المواصفات			
	عدد 2 عدد 1	قحة PCI قحة PCI Express x16	القحات
يدعم محركين للأقرص المرنة يدعم كل منفذ اثنين من أجهزة IDE يدعم كل منفذ واحد من أجهزة SATA يدعم تجهيزات اللوحة الامامية يدعم وظيفة الصوت باللوحة الامامية Smart Fan توصيل الطاقة لمروحة وحدة المعالجة مع وظيفة توصيل الطاقة لمروحة النظام باللوحة الامامية USB يدعم كل منفذ قحتي	عدد 1 عدد 1 عدد 4 عدد 1 عدد 1 عدد 1 عدد 1 عدد 2 عدد 1 عدد 1	منفذ محرك أقراص مرنة منفذ تناسلي (اختياري) منفذ IDE منفذ SATA منفذ اللوحة الامامية منفذ الصوت الأممي وصلة مروحة وحدة المعالجة المركزية وصلة مروحة النظام وصلة مسح CMOS منفذ USB منفذ توصيل الطاقة (24بيوس) منفذ توصيل الطاقة (4بيبيس)	المنفذ على سطح اللوحة
	عدد 1 عدد 1 عدد عدد 1 عدد 1 عدد 4 عدد 3	لوحة مفاتيح PS/2 ماوس PS/2 منفذ تناسلي منفذ طابعة منفذ VGA منفذ شبكة اتصال محلية منافذ USB مقيس صوت	منفذ دخل/خرج اللوحة الخلفية
		190 مم (عرض) X 244 مم (ارتفاع)	حجم اللوحة
بحقها في اضافة أو إزالة الدعم لأي نظام تشغيل بإخطار أو بدون Biostar حفظ إخطار .		Windows 2000 / XP / Vista 32 / Vista 64	دعم أنظمة التشغيل

JAPANESE

仕様		
CPU	LGA 775 Intel Core2Quad / Core2Duo / Pentium Dual-Core / Celeron Dual-Core / Celeron 4xx processor (最高のワット: 95W)	Hyper-Threading / Execute Disable Bit / Enhanced Intel SpeedStep® / Intel Architecture-64 / Extended Memory 64 Technology / Virtualization Technologyをサ ポートします
FSB	800 / 1066 / 1333 MHz	
チップセット	Intel G31 Intel ICH7	
メインメモリ	DDR2 DIMMスロット x 2 各DIMMは 256MB / 512MB / 1GB / 2GB DDR2をサポート 最大メモリ容量4GB	デュアル チャンネルモードDDR2 メモリモジュール DDR2 800/667をサポート 登録済みDIMMとECC DIMMはサポートされません
グラフィック ス	GMA 3100	最大の共有ビデオメモリは256MBです
Super I/O	ITE 8718F もっとも一般に使用されるレガシーSuper I/O 機能を採用しています。 低ピンカウントインターフェイス	環境コントロールイニシアチブ、 H/Wモニター ファン速度コントローラ/ モニター ITEの「スマートガーディアン」機能
IDE	統合IDEコントローラ	Ultra DMA 33 / 66 / 100バスマスタモード PIO Mode 0~4のサポート、
SATA	統合シリアルATAコントローラ	最高3.0 Gb/秒のデータ転送速度 SATAバージョン2.0仕様標準。
LAN	Realtek RTL 8111DL	10 / 100 / 1000 Mb/秒のオートネゴシエーション 半/全二重機能
HDオーディ オのサポート	ALC662	ハイデフィニションオーディオのサポート 5.1 チャンネルオーディオアウト

仕様			
スロット	PCIスロット	x2	
	PCI Express x16スロット	x1	
オンボードコネクタ	フロッピーコネクタ	x1	各コネクタは2つのフロッピードライブをサポートします
	シリアルポート (任意)	x1	
	IDEコネクタ	x1	各コネクタは2つのIDEデバイスをサポートします
	SATAコネクタ	x4	各コネクタは1つのSATAデバイスをサポートします
	フロントパネルコネクタ	x1	フロントパネル機能をサポートします
	フロントオーディオコネクタ	x1	フロントパネルオーディオ機能をサポートします
	CPUファンヘッダ	x1	CPUファン電源装置(スマートファン機能を搭載)
	システムファンヘッダ	x1	システムファン電源装置
	CMOSクリアヘッダ	x1	
	USBコネクタ	x2	各コネクタは2つのフロントパネルUSBポートをサポートします
	電源コネクタ(24ピン)	x1	
	電源コネクタ(4ピン)	x1	
背面パネル I/O	PS/2キーボード	x1	
	PS/2マウス	x1	
	シリアルポート	x1	
	プリンタポート	x1	
	VGAポート	x1	
	LANポート	x1	
	USBポート	x4	
	オーディオジャック	x3	
ボードサイズ	190 mm (幅) X 244 mm (高さ)		
OSサポート	Windows 2000 / XP / Vista 32 / Vista 64		Biostarは事前のサポートなしにOSサポートを追加または削除する権利を留保します。

2009/02/13