

## **FCC Information and Copyright**

This equipment has been tested and found to comply with the limits of a Class B digital device, pursuant to Part 15 of the FCC Rules. These limits are designed to provide reasonable protection against harmful interference in a residential installation. This equipment generates, uses, and can radiate radio frequency energy and, if not installed and used in accordance with the instructions, may cause harmful interference to radio communications. There is no guarantee that interference will not occur in a particular installation.

The vendor makes no representations or warranties with respect to the contents here and specially disclaims any implied warranties of merchantability or fitness for any purpose. Further the vendor reserves the right to revise this publication and to make changes to the contents here without obligation to notify any party beforehand.

Duplication of this publication, in part or in whole, is not allowed without first obtaining the vendor's approval in writing.

The content of this user's manual is subject to be changed without notice and we will not be responsible for any mistakes found in this user's manual. All the brand and product names are trademarks of their respective companies.

---

---

## Table of Contents

---

---

<b>Chapter 1: Introduction</b> .....	<b>1</b>
<b>1.1 Before You Start</b> .....	1
<b>1.2 Package Checklist</b> .....	1
<b>1.3 Motherboard Features</b> .....	2
<b>1.4 Rear Panel Connectors</b> .....	3
<b>1.5 Motherboard Layout</b> .....	4
<b>Chapter 2: Hardware Installation</b> .....	<b>5</b>
<b>2.1 Installing Central Processing Unit (CPU)</b> .....	5
<b>2.2 FAN Headers</b> .....	7
<b>2.3 Installing System Memory</b> .....	8
<b>2.4 Connectors and Slots</b> .....	10
<b>Chapter 3: Headers &amp; Jumpers Setup</b> .....	<b>12</b>
<b>3.1 How to Setup Jumpers</b> .....	12
<b>3.2 Detail Settings</b> .....	12
<b>Chapter 4: Useful Help</b> .....	<b>18</b>
<b>4.1 Driver Installation Note</b> .....	18
<b>4.2 AMI BIOS Beep Code</b> .....	19
<b>4.3 Extra Information</b> .....	20
<b>4.4 Troubleshooting</b> .....	22
<b>Appendencies: SPEC In Other Language</b> .....	<b>24</b>
<b>German</b> .....	24
<b>France</b> .....	26
<b>Italian</b> .....	28
<b>Spanish</b> .....	30
<b>Portuguese</b> .....	32
<b>Polish</b> .....	34
<b>Russian</b> .....	36
<b>Arabic</b> .....	38
<b>Japanese</b> .....	40

---

---

## **CHAPTER 1: INTRODUCTION**

### **1.1 BEFORE YOU START**

Thank you for choosing our product. Before you start installing the motherboard, please make sure you follow the instructions below:

- Prepare a dry and stable working environment with sufficient lighting.
- Always disconnect the computer from power outlet before operation.
- Before you take the motherboard out from anti-static bag, ground yourself properly by touching any safely grounded appliance, or use grounded wrist strap to remove the static charge.
- Avoid touching the components on motherboard or the rear side of the board unless necessary. Hold the board on the edge, do not try to bend or flex the board.
- Do not leave any unfastened small parts inside the case after installation. Loose parts will cause short circuits which may damage the equipment.
- Keep the computer from dangerous area, such as heat source, humid air and water.

### **1.2 PACKAGE CHECKLIST**

- ✦ HDD Cable X 1
- ✦ Serial ATA Cable X 1
- ✦ User's Manual X 1
- ✦ Fully Setup Driver CD X 1
- ✦ Rear I/O Panel for ATX Case X 1
- ✦ FDD Cable X 1 (optional)
- ✦ USB 2.0 Cable X1 (optional)
- ✦ S/PDIF Cable X 1 (optional)
- ✦ Serial ATA Power Cable X 1 (optional)

**Note:** The package contents may differ by area or your motherboard version.

### 1.3 MOTHERBOARD FEATURES

SPEC		
CPU	LGA 775 Intel Core2Duo / Core2Quad / Celeron 4xx processor	Supports Hyper-Threading / Execute Disable Bit / Enhanced Intel SpeedStep® / Intel Architecture-64 / Extended Memory 64 Technology / Virtualization Technology
FSB	Support 533 / 800 / 1066 / 1333 MHz	
Chipset	Intel G31 Intel ICH7	
SuperI/O	ITE 8712F Provides the most commonly used legacy Super I/O functionality Low Pin Count Interface	Environment Control initiatives, Hardware Monitor Controller Fan Speed Controller ITE's "Smart Guardian" function
Main Memory	DIMM Slots x 2 Each DIMM supports 256MB / 512MB / 1GB / 2GB DDR2 Max Memory Capacity 4GB	Dual Channel Mode DDR2 memory module Supports DDR2 800/667 Supports DDR2 533 (with FSB 533/1066 CPU) Registered DIMM and ECC DIMM is not supported
Graphics	GMA 3100	Max Shared Video Memory is 256MB
IDE	Integrated IDE Controller	Ultra DMA 33 / 66 / 100 Bus Master Mode supports PIO Mode 0~4
SATA 2	Integrated Serial ATA Controller	Data transfer rates up to 3.0 Gb/s. SATA Version 2.0 specification compliant
LAN	Realtek RTL 8101E / 8102E / 8111C (optional)	10 / 100 Mb/s / 1Gb/s auto negotiation (Gigabit bandwidth is for Realtek RTL 8111C only) Half / Full duplex capability
Sound Codec	ALC662	5.1 channels audio out High Definition Audio
Slots	PCI slot x2 PCI Express x 16 slot x1 PCI Express x 1 slot x1	Supports PCI expansion cards Supports PCI-E x16 expansion cards Supports PCI-E x1 expansion cards
On Board Connector	Floppy connector x1 Printer Port Connector x1 IDE Connector x1 SATA Connector x4	Each connector supports 2 Floppy drives Each connector supports 1 Printer port Each connector supports 2 IDE device Each connector supports 1 SATA devices

SPEC			
	Front Panel Connector	x1	Supports front panel facilities
	Front Audio Connector	x1	Supports front panel audio function
	CD-in Connector	x1	Supports CD audio-in function
	S/PDIF out connector	x1	Supports digital audio out function
	CPU Fan header	x1	CPU Fan power supply (with Smart Fan function)
	System Fan header	x1	System Fan Power supply
	Clear CMOS header	x1	Restore CMOS data to factory default
	USB connector	x2	Each connector supports 2 front panel USB ports
	Power Connector (24pin)	x1	Connects to Power supply
	Power Connector (4pin)	x1	Connects to Power supply
Back Panel I/O	PS/2 Keyboard	x1	Connects to PS/2 Keyboard
	PS/2 Mouse	x1	Connects to PS/2 Mouse
	Serial Port	x1	Provide RS-232 Serial connection
	VGA port	x1	Connect to D-SUB monitor
	LAN port	x1	Connect to RJ-45 ethernet cable
	USB Port	x4	Connect to USB devices
	Audio Jack	x3	Provide Audio-In/Out and microphone connection
Board Size	195 (W) x 244 (L) mm		
OS Support	Windows 2000 / XP / VISTA		Biostar Reserves the right to add or remove support for any OS with or without notice

### 1.4 REAR PANEL CONNECTORS

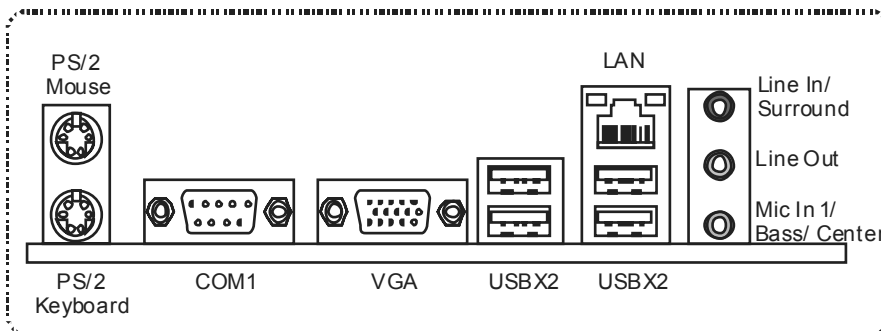

Since the audio chip supports High Definition Audio Specification, the function of each audio jack can be defined by software. The input / output function of each audio jack listed above represents the default setting. However, when connecting external microphone to the audio port, please use the Line In (blue) and Mic In (Pink) audio jack.

### 1.5 MOTHERBOARD LAYOUT

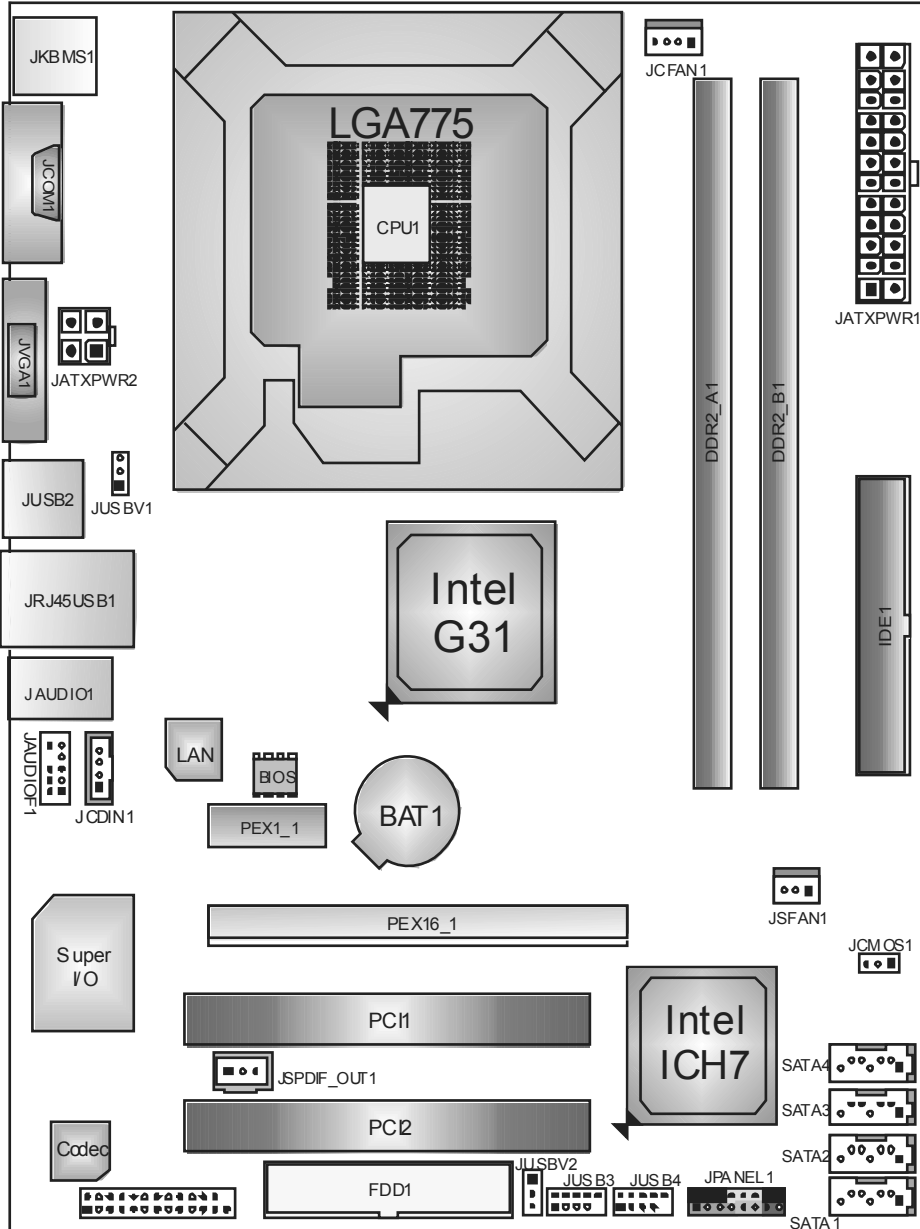

**Note:** ■ represents the 1<sup>st</sup> pin.

---

---

## CHAPTER 2: HARDWARE INSTALLATION

### 2.1 INSTALLING CENTRAL PROCESSING UNIT (CPU)

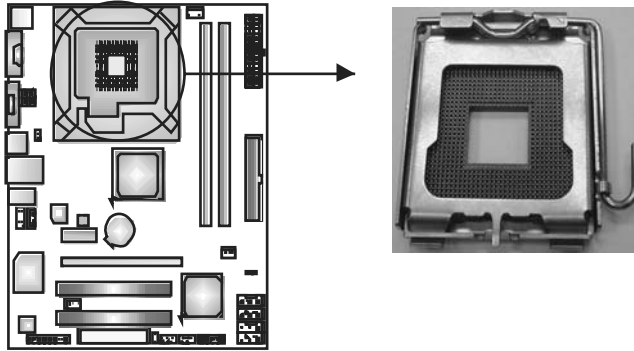

#### *Special Notice*

Remove Pin Cap before installation, and make good preservation for future use. When the CPU is removed, cover the Pin Cap on the empty socket to ensure pin legs won't be damaged.

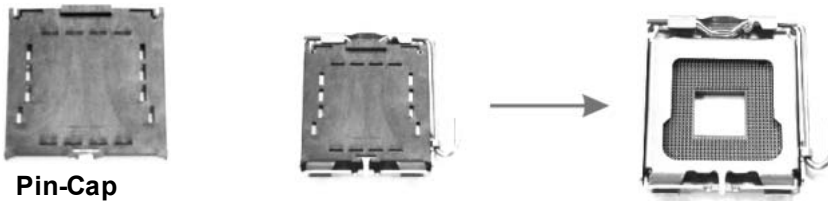

**Pin-Cap**

**Step 1:** Pull the socket locking lever out from the socket and then raise the lever up to a 90-degree angle.

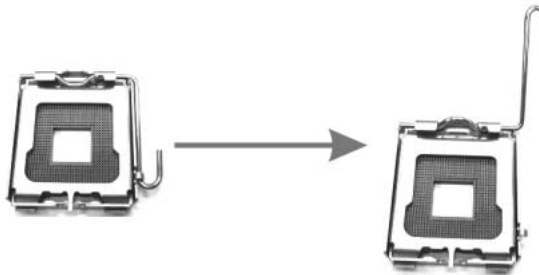

## Motherboard Manual

---

**Step 2:** Look for the triangular cut edge on socket, and the golden dot on CPU should point forwards this triangular cut edge. The CPU will fit only in the correct orientation.

*Step 2-1:*

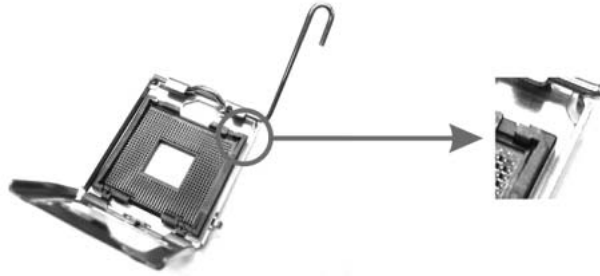

*Step 2-2:*

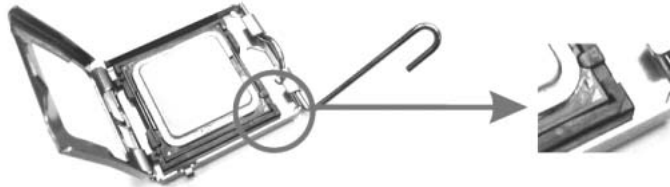

**Step 3:** Hold the CPU down firmly, and then lower the lever to locked position to complete the installation.



**Step 4:** Put the CPU Fan and heatsink assembly on the CPU and buckle it on the retention frame. Connect the CPU FAN power cable into the JCFAN1. This completes the installation.



## 2.2 FAN HEADERS

These fan headers support cooling-fans built in the computer. The fan cable and connector may be different according to the fan manufacturer. Connect the fan cable to the connector while matching the black wire to pin#1.

### JCFAN1: CPU Fan Header

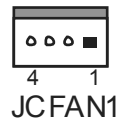
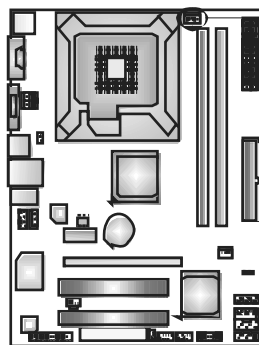

Pin	Assignment
1	Ground
2	Power
3	FAN RPM rate sense
4	Smart Fan Control

### JSFAN1: System Fan Header

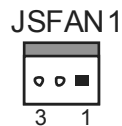
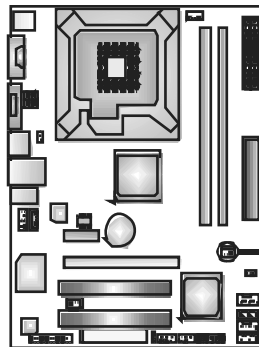

Pin	Assignment
1	Ground
2	+12V
3	FAN RPM rate sense

**Note:**

The JCFAN1 support 4-pin header connector and JSFAN1 support 3-pin header connector. When connecting with wires onto connectors, please note that the red wire is the positive and should be connected to pin#2, and the black wire is Ground and should be connected to GND.

## 2.3 INSTALLING SYSTEM MEMORY

### A. DDR2 module

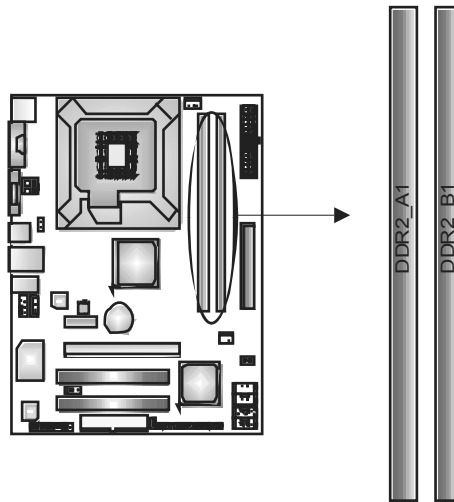

1. Unlock a DIMM slot by pressing the retaining clips outward. Align a DIMM on the slot such that the notch on the DIMM matches the break on the Slot.

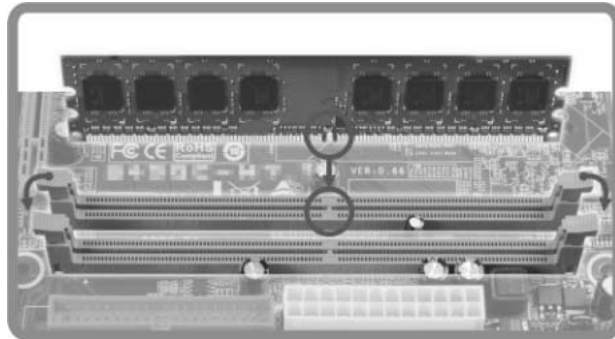

2. Insert the DIMM vertically and firmly into the slot until the retaining chip snap back in place and the DIMM is properly seated.

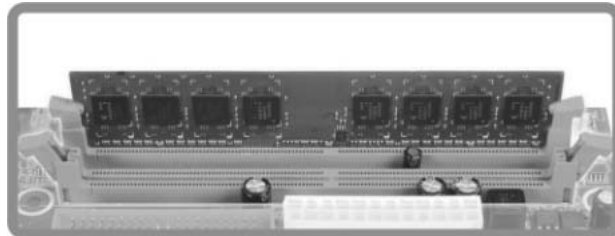

### B. Memory Capacity

DIMM Socket Location	DDR2 Module	Total Memory Size
DDR2_A1	256MB/512MB/1GB/2GB	Max is 4B.
DDR2_B1	256MB/512MB/1GB/2GB	

### C. Dual Channel Memory Installation

To trigger the Dual Channel function of the motherboard, the memory module must meet the following requirements:

Install memory module of the same density in pairs, shown in the following table.

Dual Channel Status	DDR2_A1	DDR2_B1
Disabled	O	X
Disabled	X	O
Enabled	O	O

(O means memory installed, X means memory not installed.)

The DRAM bus width of the memory module must be the same(x8 or x16)

### D. FSB Supporting Table

According to the FSB frequency of the installed CPU, the motherboard could support DDR2 533/667/800 modules. Please refer to the table below to find out the proper RAM module that fits the FSB of the installed CPU.

FSB of CPU \ DDR2 Module	FSB 533	FSB 800	FSB 1066	FSB1333
DDR2 533	O	X	O	X
DDR2 667	O	O	O	O
DDR2 800	O	O	O	O

(O means supported, X means not supported.)

## 2.4 CONNECTORS AND SLOTS

### FDD1: Floppy Disk Connector

The motherboard provides a standard floppy disk connector that supports 360K, 720K, 1.2M, 1.44M and 2.88M floppy disk types. This connector supports the provided floppy drive ribbon cables.

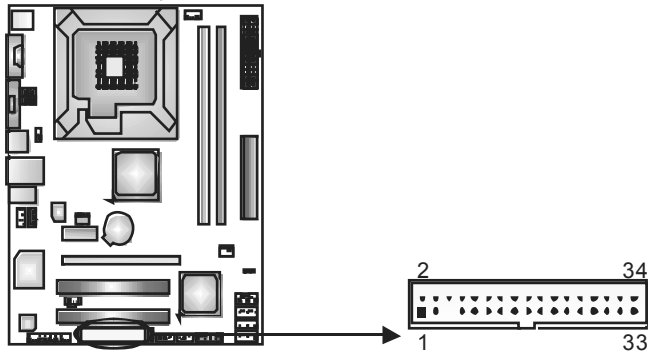

### IDE1: Hard Disk Connector

The motherboard has a 32-bit Enhanced PCI IDE Controller that provides PIO Mode 0~4, Bus Master, and Ultra DMA 33/66/100 functionality. The IDE connector can connect a master and a slave drive, so you can connect up to two hard disk drives.

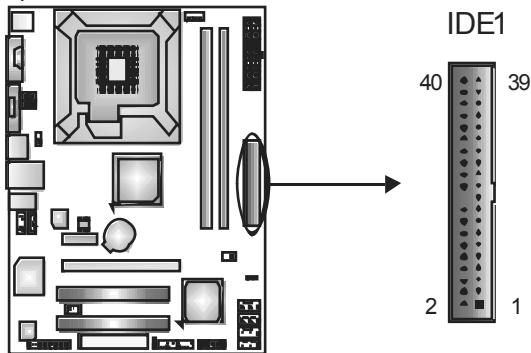

**PEX16\_1: PCI-Express x16 Slot**

- PCI-Express 1.0a compliant.
- Maximum theoretical realized bandwidth of 4GB/s simultaneously per direction, for an aggregate of 8GB/s totally.

**PEX1\_1: PCI-Express x1 Slot**

- PCI-Express 1.0a compliant.
- Data transfer bandwidth up to 250MB/s per direction; 500MB/s in total.
- PCI-Express supports a raw bit-rate of 2.5Gb/s on the data pins.
- 2X bandwidth over the traditional PCI architecture.

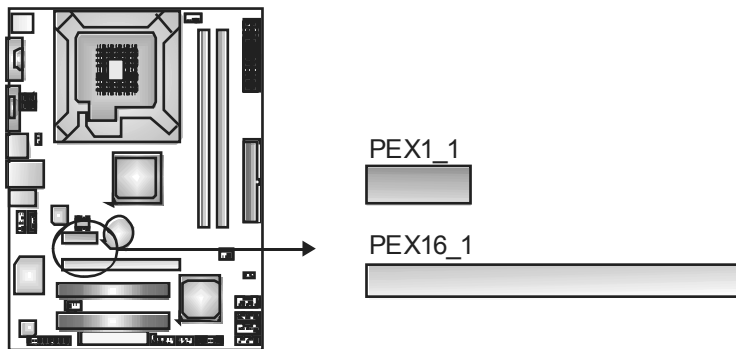

**PCI1~PCI2: Peripheral Component Interconnect Slots**

This motherboard is equipped with 2 standard PCI slots. PCI stands for Peripheral Component Interconnect, and it is a bus standard for expansion cards. This PCI slot is designated as 32 bits.

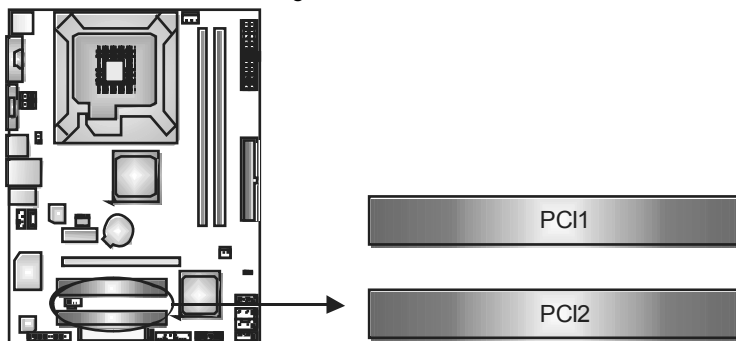

## CHAPTER 3: HEADERS & JUMPERS SETUP

### 3.1 HOW TO SETUP JUMPERS

The illustration shows how to set up jumpers. When the jumper cap is placed on pins, the jumper is “close”, if not, that means the jumper is “open”.



Pin opened



Pin closed



Pin 1-2 closed

### 3.2 DETAIL SETTINGS

#### JANEL1: Front Panel Header

This 16-pin connector includes Power-on, Reset, HDD LED, Power LED, and speaker connection. It allows user to connect the PC case's front panel switch functions.

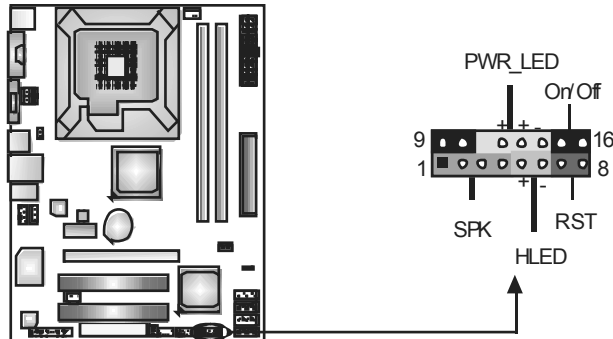

Pin	Assignment	Function	Pin	Assignment	Function
1	+5V	Speaker Connector	9	N/A	N/A
2	N/A		10	N/A	N/A
3	N/A		11	N/A	N/A
4	Speaker	Hard drive LED	12	Power LED (+)	Power LED
5	HDD LED (+)		13	Power LED (+)	
6	HDD LED (-)		14	Power LED (-)	
7	Ground	Reset button	15	Power button	Power-on button
8	Reset control		16	Ground	

**JATXPWR1: ATX Power Source Connector**

This connector allows user to connect 24-pin power connector on the ATX power supply.

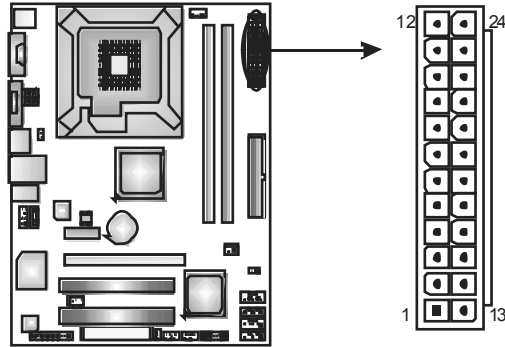

Pin	Assignment	Pin	Assignment
13	+3.3V	1	+3.3V
14	-12V	2	+3.3V
15	Ground	3	Ground
16	PS_ON	4	+5V
17	Ground	5	Ground
18	Ground	6	+5V
19	Ground	7	Ground
20	NC	8	PW_OK
21	+5V	9	Standby Voltage+5V
22	+5V	10	+12V
23	+5V	11	+12V
24	Ground	12	+3.3V

**JATXPWR2: ATX Power Source Connector**

By connecting this connector, it will provide +12V to CPU power circuit.

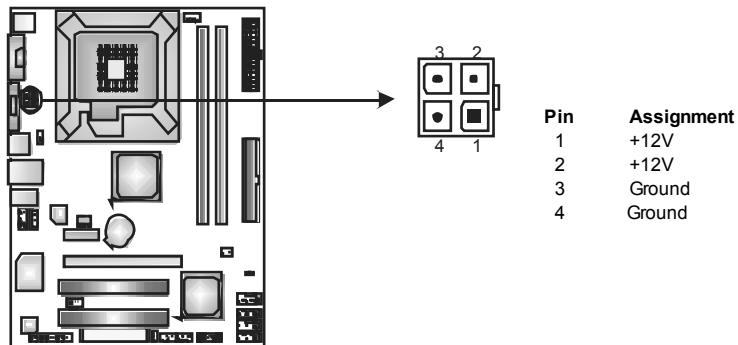

Pin	Assignment
1	+12V
2	+12V
3	Ground
4	Ground

**Note:**

Before power on the system, please make sure that both JATXPWR1 and JATXPWR2 connectors have been plugged-in.

**JUSB3/JUSB4: Headers for USB 2.0 Ports at Front Panel**

This motherboard provides 2 USB 2.0 headers, which allows user to connect additional USB cable on the PC front panel, and also can be connected with internal USB devices, like USB card reader.

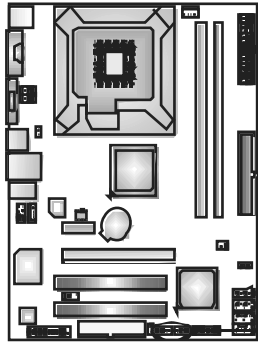

Pin	Assignment
1	+5V (fused)
2	+5V (fused)
3	USB-
4	USB-
5	USB+
6	USB+
7	Ground
8	Ground
9	Key
10	NC

**JAUDIO F1: Front Panel Audio Header**

This header allows user to connect the front audio output cable with the PC front panel. This header allows only HD audio front panel connector; AC'97 connector is not acceptable.

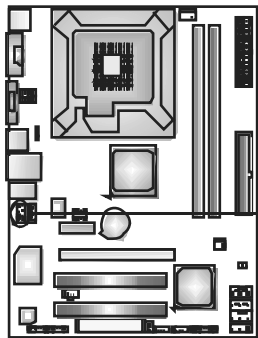

Pin	Assignment
1	Mic Left in
2	Ground
3	Mic Right in
4	GPIO
5	Right line in
6	Jack Sense
7	Front Sense
8	Key
9	Left line in
10	Jack Sense

**JCDIN1: CD-ROM Audio-in Connector**

This connector allows user to connect the audio source from the variety devices, like CD-ROM, DVD-ROM, PCI sound card, PCI TV turner card etc..

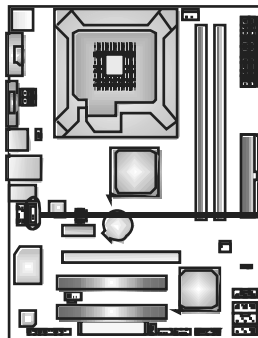

Pin	Assignment
1	Left Channel Input
2	Ground
3	Ground
4	Right Channel Input



**JCMOS1: Clear CMOS Header**

By placing the jumper on pin2-3, it allows user to restore the BIOS safe setting and the CMOS data, please carefully follow the procedures to avoid damaging the motherboard.

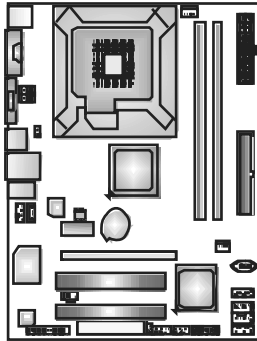

**Pin 1-2 Close:**  
Normal Operation  
(Default).



**Pin 2-3 Close:**  
Clear CMOS data.

**※ Clear CMOS Procedures:**

1. Remove AC power line.
2. Set the jumper to "Pin 2-3 close".
3. Wait for five seconds.
4. Set the jumper to "Pin 1-2 close".
5. Power on the AC.
6. Reset your desired password or clear the CMOS data.

**SATA1~SATA4: Serial ATA Connectors**

The motherboard has a PCI to SATA Controller with 4channels SATA interface, it satisfies the SATA 2.0 spec and with transfer rate of 3Gb/s.

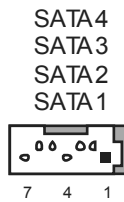
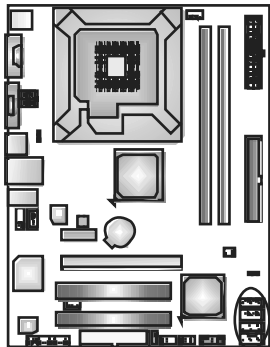

Pin	Assignment
1	Ground
2	TX+
3	TX-
4	Ground
5	RX-
6	RX+
7	Ground

### JSPDIF\_OUT1: Digital Audio out Connector

This connector allows user to connect the PCI bracket SPDIF output header.

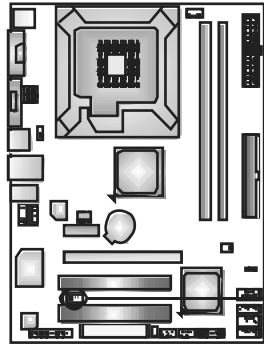

Pin	Assignment
1	+5V
2	SPDIF_OUT
3	Ground

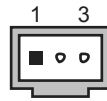

### JUSBV1/JUSBV2: Power Source Headers for USB Ports

**Pin 1-2 Close:**

JUSBV1: +5V for USB ports at JUSB2/JRJ45USB1.

JUSBV2: +5V for USB ports at front panel (JUSB3/JUSB4).

**Pin 2-3 Close:**

JUSBV1: +5V STB for USB ports at JUSB2/JRJ45USB1.

JUSBV2: +5V STB for USB ports at front panel (JUSB3/JUSB4).

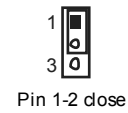
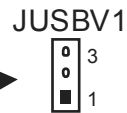
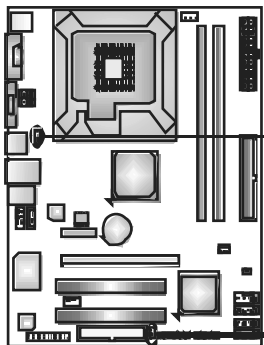

Pin 1-2 close

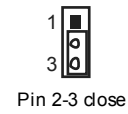
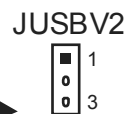

Pin 2-3 close

**JPRNT1: Printer Port Connector**

This header allows you to connect printer on the PC.

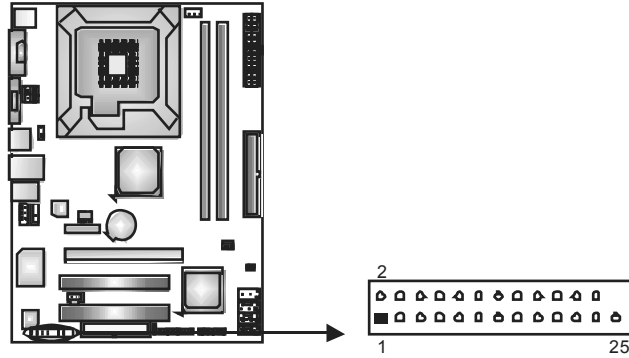

Pin	Assignment	Pin	Assignment
1	-Strobe	14	Ground
2	-ALF	15	Data 6
3	Data 0	16	Ground
4	-Error	17	Data 7
5	Data 1	18	Ground
6	-Init	19	-ACK
7	Data 2	20	Ground
8	-Scltin	21	Busy
9	Data 3	22	Ground
10	Ground	23	PE
11	Data 4	24	Ground
12	Ground	25	SCLT
13	Data 5	26	Key

## CHAPTER 4: USEFUL HELP

### 4.1 DRIVER INSTALLATION NOTE

After you installed your operating system, please insert the Fully Setup Driver CD into your optical drive and install the driver for better system performance.

You will see the following window after you insert the CD

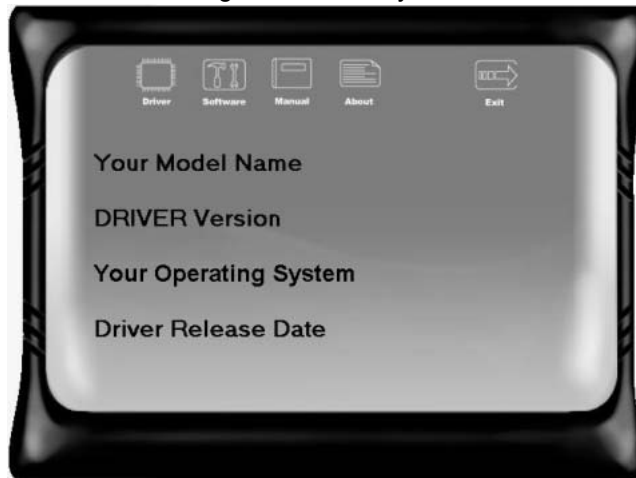

The setup guide will auto detect your motherboard and operating system.

**Note:**

If this window didn't show up after you insert the Driver CD, please use file browser to locate and execute the file **SETUP.EXE** under your optical drive.

#### A. Driver Installation

To install the driver, please click on the Driver icon. The setup guide will list the compatible driver for your motherboard and operating system. Click on each device driver to launch the installation program.

#### B. Software Installation

To install the software, please click on the Software icon. The setup guide will list the software available for your system, click on each software title to launch the installation program.

#### C. Manual

Aside from the paperback manual, we also provide manual in the Driver CD. Click on the Manual icon to browse for available manual.

**Note:**

You will need Acrobat Reader to open the manual file. Please download the latest version of Acrobat Reader software from <http://www.adobe.com/products/acrobat/readstep2.html>

## 4.2 AMIBIOS BEEP CODE

### Boot Block Beep Codes

Number of Beeps	Description
1	No media present. (Insert diskette in floppy drive A:)
2	"AMIBOOT.ROM" file not found in root directory of diskette in A:
3	Insert next diskette if multiple diskettes are used for recovery
4	Flash Programming successful
5	File read error
7	No Flash EPROM detected
10	Flash Erase error
11	Flash Program error
12	"AMIBOOT.ROM" file size error
13	BIOS ROM image mismatch (file layout does not match image present in flash device)

### POST BIOS Beep Codes

Number of Beeps	Description
1	Memory refresh timer error
3	Base memory read/write test error
6	Keyboard controller BAT command failed
7	General exception error (processor exception interrupt error)
8	Display memory error (system video adapter)

### Troubleshooting POST BIOS Beep Codes

Number of Beeps	Troubleshooting Action
1, 3	Reseat the memory, or replace with known good modules.
6, 7	<p>Fatal error indicating a serious problem with the system. Consult your system manufacturer. Before declaring the motherboard beyond all hope, eliminate the possibility of interference by a malfunctioning add-in card. Remove all expansion cards except the video adapter.</p> <ul style="list-style-type: none"> <li>● If beep codes are generated when all other expansion cards are absent, consult your system manufacturer's technical support.</li> <li>● If beep codes are not generated when all other expansion cards are absent, one of the add-in cards is causing the malfunction. Insert the cards back into the system one at a time until the problem happens again. This will reveal the malfunctioning card.</li> </ul>
8	If the system video adapter is an add-in card, replace or reseat the video adapter. If the video adapter is an integrated part of the system board, the board may be faulty.

### 4.3 EXTRA INFORMATION

#### ***CPU Overheated***

If the system shutdown automatically after power on system for seconds, that means the CPU protection function has been activated.

When the CPU is over heated, the motherboard will shutdown automatically to avoid a damage of the CPU, and the system may not power on again.

In this case, please double check:

1. The CPU cooler surface is placed evenly with the CPU surface.
2. CPU fan is rotated normally.
3. CPU fan speed is fulfilling with the CPU speed.

After confirmed, please follow steps below to relief the CPU protection function.

1. Remove the power cord from power supply for seconds.
2. Wait for seconds.
3. Plug in the power cord and boot up the system.

Or you can:

1. Clear the CMOS data.  
(See "Close CMOS Header: JCMOS1" section)
2. Wait for seconds.
3. Power on the system again.

## BIO-Flasher

BIO-Flasher is a BIOS flashing utility providing you an easy and simple way to update your BIOS via USB pen drive or floppy disk.

The BIO-Flasher is built in the BIOS chip. To enter the utility, **press <F12> during the Power-On Self Tests (POST)** procedure while booting up.

### Updating BIOS with BIO-Flasher

1. Go to the website to download the latest BIOS file for the motherboard.
2. Then, save the BIOS file into a USB pen drive or a floppy disk.
3. Insert the USB pen drive or the floppy disk that contains the BIOS file to the USB port or the floppy disk drive.
4. Power on or reset the computer and then press **<F12>** during the **POST** process. A select dialog as the picture on the right appears. Select the device contains the BIOS file and press **<Enter>** to enter the utility.



5. The utility will show the BIOS files and their respective information. Select the proper BIOS file and press **<Enter>** then **<Y>** to perform the BIOS update process.
6. After the update process, the utility will ask you to reboot the system. Press **<Y>** to proceed. BIOS update completes.



- This utility only allows storage device with FAT32/16 format and single partition.
- Shutting down or resetting the system while updating the BIOS will lead to system boot failure.

## 4.4 TROUBLESHOOTING

Probable	Solution
<ol style="list-style-type: none"> <li>1. No power to the system at all. Power light don't illuminate, fan inside power supply does not turn on.</li> <li>2. Indicator light on key board does not turn on.</li> </ol>	<ol style="list-style-type: none"> <li>1. Make sure power cable is securely plugged in.</li> <li>2. Replace cable.</li> <li>3. Contact technical support.</li> </ol>
<p>System inoperative. Keyboard lights are on, power indicator lights are lit, and hard drive is spinning.</p>	<p>Using even pressure on both ends of the DIMM, press down firmly until the module snaps into place.</p>
<p>System does not boot from hard disk drive, can be booted from optical drive.</p>	<ol style="list-style-type: none"> <li>1. Check cable running from disk to disk controller board. Make sure both ends are securely plugged in; check the drive type in the standard CMOS setup.</li> <li>2. Backing up the hard drive is extremely important. All hard disks are capable of breaking down at any time.</li> </ol>
<p>System only boots from optical drive. Hard disk can be read and applications can be used but booting from hard disk is impossible.</p>	<ol style="list-style-type: none"> <li>1. Back up data and applications files.</li> <li>2. Reformat the hard drive. Re-install applications and data using backup disks.</li> </ol>
<p>Screen message says "Invalid Configuration" or "CMOS Failure."</p>	<p>Review system's equipment. Make sure correct information is in setup.</p>
<p>Cannot boot system after installing second hard drive.</p>	<ol style="list-style-type: none"> <li>1. Set master/slave jumpers correctly.</li> <li>2. Run SETUP program and select correct drive types. Call the drive manufacturers for compatibility with other drives.</li> </ol>



This page is intentionally left blank.

## APPENDENCIES: SPEC IN OTHER LANGUAGE

### GERMAN

Spezifikationen		
CPU	LGA 775 Intel Core2Duo / Core2Quad / Celeron 4xx / Pentium 4 / Pentium D / Celeron D Prozessoren	Unterstützt Hyper-Threading / Execute Disable Bit / Enhanced Intel SpeedStep® / Intel Architecture-64/ Extended Memory 64 Technology / Virtualization Technology
FSB	533 / 800 / 1066 / 1333 MHz	
Chipsatz	Intel G31 Intel ICH7	
Super E/A	ITE 8712F Bietet die häufig verwendeten alten Super E/A-Funktionen. Low Pin Count-Schnittstelle	Umgebungs-kontrolle, Hardware-Überwachung Lüfterdrehzahl-Controller/-Überwachung "Smart Guardian"-Funktion von ITE
Arbeitsspeicher	DDR2 DIMM-Steckplätze x 2 Jeder DIMM unterstützt 256MB / 512MB / 1GB / 2GB DDR2. Max. 4GB Arbeitsspeicher	Dual-Kanal DDR2 Speichermodul Unterstützt DDR2 800/667 Unterstützt DDR2 533 (w. FSB 533/1066 CPU) registrierte DIMMs. ECC DIMMs werden nicht unterstützt.
Grafik	GMA 3100	Max. 256MB gemeinsam benutzter Videospeicher
IDE	Integrierter IDE-Controller	Ultra DMA 33 / 66 / 100 Bus Master-Modus Unterstützt PIO-Modus 0~4,
SATA	Integrierter Serial ATA-Controller	Datentransferrate bis zu 3.0Gb/s Konform mit der SATA-Spezifikation Version 2.0.
LAN	Realtek RTL 8101E / 8102E / 8111C(optional)	10 / 100 / 1000 Mb/s Auto-Negotiation (Gigabit-Bandbreite nur beim Realtek RTL 8111C) Halb-/Voll-duplex-Funktion
HD Audio-Unterstützung	ALC662	Unterstützt High-Definition Audio 5.1-Kanal-Audioausgabe

<b>Spezifikationen</b>			
Steckplätze	PCI-Steckplatz	x2	
	PCI Express x16 Steckplatz	x1	
	PCI Express x 1-Steckplatz	x1	
Onboard-Anschluss	Diskettenlaufwerkanschluss	x1	Jeder Anschluss unterstützt 2 Diskettenlaufwerke
	Druckeranschluss Anschluss	x1	Jeder Anschluss unterstützt 1 Druckeranschluss
	IDE-Anschluss	x1	Jeder Anschluss unterstützt 2 IDE-Laufwerke
	SATA-Anschluss	x4	Jeder Anschluss unterstützt 1 SATA-Laufwerk
	Fronttafelanschluss	x1	Unterstützt die Fronttafelaktionen
	Front-Audioanschluss	x1	Unterstützt die Fronttafel-Audioanschlussfunktion
	CD-IN-Anschluss	x1	Unterstützt die CDAudio-In-Funktion
	S/PDIF- Ausgangsanschluss	x1	Unterstützt die digitale Audioausgabefunktion
	CPU-Lüfter-Sockel	x1	CPU-Lüfterstromversorgungsanschluss (mit Smart Fan-Funktion)
	System-Lüfter-Sockel	x1	System-Lüfter-Stromversorgungsanschluss
Rückseiten-E/A	"CMOS löschen"-Sockel	x1	
	USB-Anschluss	x2	Jeder Anschluss unterstützt 2 Fronttafel-USB-Anschlüsse
	Stromanschluss (24-polig)	x1	
	Stromanschluss (4-polig)	x1	
	PS/2-Tastatur	x1	
Platinengröße	PS/2-Maus	x1	
	Serieller Anschluss	x1	
	VGA-Anschluss	x1	
	LAN-Anschluss	x1	
	USB-Anschluss	x4	
	Audioanschluss	x3	
	195 mm (B) X 244 mm (L)		
OS-Unterstützung	Windows 2000 / XP / VISTA		Biostar behält sich das Recht vor, ohne Ankündigung die Unterstützung für ein Betriebssystem hinzuzufügen oder zu entfernen.

**FRANCE**

SPEC		
UC	LGA 775 Processeurs Intel Core2Duo / Core2Quad / Celeron 4xx / Pentium 4 / Pentium D / Celeron D	Prend en charge les technologies Hyper-Threading / d'exécution de bit de désactivation / Intel SpeedStep® optimisée/ d'architecture Intel 64 / de mémoire étendue 64 / de virtualisation
Bus frontal	533 / 800 / 1066 / 1333 MHz	
Chipset	Intel G31 Intel ICH7	
Super E/S	ITE 8712F Fournit la fonctionnalité de Super E/S patrimoniales la plus utilisée. Interface à faible compte de broches	Initiatives de contrôle environnementales, Moniteur de matériel Contrôleur /moniteur de vitesse de ventilateur Fonction "Garden intelligent" de l'ITE
Mémoire principale	Fentes DDR2 DIMM x 2 Chaque DIMM prend en charge des DDR2 de 256Mo / 512Mo / 1Go / 2Go Capacité mémoire maximale de 4Go	Module de mémoire DDR2 à mode à double voie Prend en charge la DDR2 800/667 Prend en charge la DDR2 533 (w. FSB 533/1066 CPU) Les DIMM à registres et DIMM avec code correcteurs d'erreurs ne sont pas prises en charge
Graphiques	GMA 3100	Mémoire vidéo partagée maximale de 256 Mo
IDE	Contrôleur IDE intégré	Mode principale de Bus Ultra DMA 33 / 66 / 100 Prend en charge le mode PIO 0~4,
SATA	Contrôleur Serial ATA intégré	Taux de transfert jusqu'à 3.0Go/s. Conforme à la spécification SATA Version 2.0
LAN	Realtek RTL 8101E / 8102E / 8111C(optional)	10 / 100 / 1000 Mb/s négociation automatique (La bande passante Ggabit est pour le Realtek RTL 8111C uniquement) Half / Full duplex capability
Prise en charge audio HD	ALC662	Prise en charge de l'audio haute définition Sortie audio à 5.1 voies
Fentes	Fente PCI x2 Fente PCI Express x16 x1 Fente PCI Express x1 x1	

SPEC			
Connecteur embarqué	Connecteur de disquette	x1	Chaque connecteur prend en charge 2 lecteurs de disquettes
	Connecteur de Port d'imprimante	x1	Chaque connecteur prend en charge 1 Port d'imprimante
	Connecteur IDE	x1	Chaque connecteur prend en charge 2 périphériques IDE
	Connecteur SATA	x4	Chaque connecteur prend en charge 1 périphérique SATA
	Connecteur du panneau avant	x1	Prend en charge les équipements du panneau avant
	Connecteur Audio du panneau avant	x1	Prend en charge la fonction audio du panneau avant
	Connecteur d'entrée CD	x1	Prend en charge la fonction d'entrée audio de CD
	Connecteur de sortie S/PDIF	x1	Prend en charge la fonction de sortie audio numérique
	Embase de ventilateur UC	x1	Alimentation électrique du ventilateur UC (avec fonction de ventilateur intelligent)
	Embase de ventilateur système	x1	Alimentation électrique du ventilateur système
	Embase d'effacement CMOS	x1	
	Connecteur USB	x2	Chaque connecteur prend en charge 2 ports USB de panneau avant
	Connecteur d'alimentation (24 broches)	x1	
Connecteur d'alimentation (4 broches)	x1		
E/S du panneau arrière	Clavier PS/2	x1	
	Souris PS/2	x1	
	Port série	x1	
	Port VGA	x1	
	Port LAN	x1	
	Port USB	x4	
Fiche audio	x3		
Dimensions de la carte	195 mm (l) X 244 mm (H)		
Support SE	Windows 2000 / XP / VISTA	BioStar se réserve le droit d'ajouter ou de supprimer le support de SE avec ou sans préavis.	

**ITALIAN**

<b>SPECIFICA</b>		
CPU	LGA 775 Processore Intel Core2Duo / Core2Quad / Celeron 4xx / Pentium 4 / Pentium D / Celeron D	Supporto di Hyper-Threading / Execute Disable Bit / Enhanced Intel SpeedStep® / Architettura Intel 64 / Tecnologia Extended Memory 64 / Tecnologia Virtualization
FSB	533 / 800 / 1066 / 1333 MHz	
Chipset	Intel G31 Intel ICH7	
Super I/O	ITE 8712F Fornisce le funzionalità legacy Super I/O usate più comunemente. Interfaccia LPC (Low Pin Count)	Funzioni di controllo dell'ambiente: Monitoraggio hardware Controller / Monitoraggio velocità ventolina Funzione "Smart Guardian" di ITE
Memoria principale	Alloggi DIMM DDR 2 x 2 Ciascun DIMM supporta DDR2 256MB / 512MB / 1GB / 2GB Capacità massima della memoria 4GB	Modulo di memoria DDR2 a canale doppio Supporto di DDR2 800/667 Supporto di DDR2 533 (w. FSB 533/1066 CPU) DIMM registrati e DIMM ECC non sono supportati
Grafica	GMA 3100	La memoria video condivisa massima è di 256MB
IDE	Controller IDE integrato	Modalità Bus Master Ultra DMA 33 / 66 / 100 Supporto modalità PIO Mode 0-4
SATA	Controller Serial ATA integrato	Velocità di trasferimento dei dati fino a 3.0Gb/s. Compatibile specifiche SATA Versione 2.0.
LAN	Realtek RTL 8101E / 8102E / 8111C(optional)	Negoziazione automatica 10 / 100 / 1000 Mb/s (la larghezza di banda Gigabit è solo per Realtek RTL 8111C) Capacità Half / Full Duplex
Supporto audio HD	ALC662	Supporto audio High-Definition (HD) Uscita audio 5.1 canali
Alloggi	Alloggio PCI x2 Alloggio PCI Express x16 x1 Alloggio PCI Express x1 x1	

<b>SPECIFICA</b>			
Connettori su scheda	Connettore floppy	x1	Ciascun connettore supporta 2 unità Floppy
	Connettore Porta stampante	x1	Ciascun connettore supporta 1 Porta stampante
	Connettore IDE	x1	Ciascun connettore supporta 2 unità IDE
	Connettore SATA	x4	Ciascun connettore supporta 1 unità SATA
	Connettore pannello frontale	x1	Supporta i servizi del pannello frontale
	Connettore audio frontale	x1	Supporta la funzione audio pannello frontale
	Connettore CD-in	x1	Supporta la funzione input audio CD
	Connettore output SPDIF	x1	Supporta la funzione d'output audio digitale
	Collettore ventolina CPU	x1	Alimentazione ventolina CPU (con funzione Smart Fan)
	Collettore ventolina sistema	x1	Alimentazione ventolina di sistema
	Collettore cancellazione CMOS	x1	
Connettore USB	x2	Ciascun connettore supporta 2 porte USB pannello frontale	
Connettore alimentazione (24 pin)	x1		
Connettore alimentazione (4 pin)	x1		
I/O pannello posteriore	Tastiera PS/2	x1	
	Mouse PS/2	x1	
	Porta seriale	x1	
	Porta VGA	x1	
	Porta LAN	x1	
	Porta USB	x4	
Connettore audio	x3		
Dimensioni i scheda	195 mm (larghezza) x 244 mm (altezza)		
Sistemi operativi supportati	Windows 2000 / XP / VISTA		Biostar si riserva il diritto di aggiungere o rimuovere il supporto di qualsiasi sistema operativo senza preavviso.

**SPANISH**

<b>Especificación</b>		
CPU	LGA 775 Procesador Intel Core2Duo / Core2Quad / Celeron 4xx / Pentium 4 / Pentium D / Celeron D	Admite Hyper-Threading / Bit de deshabilitación de ejecución / Intel SpeedStep® Mejorado / Intel Architecture-64 / Tecnología Extended Memory 64 / Tecnología de virtualización
FSB	533 / 800 / 1066 / 1333 MHz	
Conjunto de chips	Intel G31 Intel ICH7	
Súper E/S	ITE 8712F Le ofrece las funcionalidades heredadas de uso más común Súper E/S. Interfaz de cuenta Low Pin	Iniciativas de control de entorno, Monitor hardware Controlador/monitor de velocidad de ventilador Función "Guarda inteligente" de ITE
Memoria principal	Ranuras DIMM DDR2 x 2 Cada DIMM admite DDR de 256MB / 512MB / 1GB / 2GB Capacidad máxima de memoria de 4GB	Módulo de memoria DDR2 de canal Doble Admite DDR2 de 800/667 Admite DDR2 de 533 (w. FSB 533/1066 CPU) No admite DIMM registrados o DIMM compatibles con ECC
Gráficos	GMA 3100	Memoria máxima de vídeo compartida de 256MB
IDE	Controlador IDE integrado	Modo bus maestro Ultra DMA 33 / 66 / 100 Soporte los Modos PIO 0~4,
SATA	Controlador ATA Serie Integrado	Tasas de transferencia de hasta 3.0 Gb/s. Compatible con la versión SATA 2.0.
Red Local	Realtek RTL 8101E / 8102E / 8111C (opcional)	Negociación de 10 / 100 / 1000 Mb/s (el ancho de banda Gigabit es únicamente para Realtek RTL 8111C) Funciones Half/ Full dúplex
Soporte de sonido HD	ALC662	Soporte de sonido de Alta Definición Salida de sonido de 5.1 canales
Ranuras	Ranura PCI X2 Ranura PCI Express x16 X1 Ranura PCI express x 1 X1	



<b>Especificación</b>			
Conectores en placa	Conector disco flexible	X1	Cada conector soporta 2 unidades de disco flexible
	Conector Puerto de impresora	X1	Cada conector soporta 1 Puerto de impresora
	Conector IDE	X1	Cada conector soporta 2 dispositivos IDE
	Conector SATA	X4	Cada conector soporta 1 dispositivos SATA
	Conector de panel frontal	X1	Soporta instalaciones en el panel frontal
	Conector de sonido frontal	X1	Soporta funciones de sonido en el panel frontal
	Conector de entrada de CD	X1	Soporta función de entrada de sonido de CD
	Conector de salida S/PDIF	X1	Soporta función de salida de sonido digital
	Cabecera de ventilador de CPU	X1	Fuente de alimentación de ventilador de CPU (con función Smart Fan)
	Cabecera de ventilador de sistema	X1	Fuente de alimentación de ventilador de sistema
	Cabecera de borrado de CMOS	X1	
	Conector USB	X2	Cada conector soporta 2 puertos USB frontales
	Conector de alimentación (24 patillas)	X1	
	Conector de alimentación (4 patillas)	X1	
Panel trasero de E/S	Teclado PS/2	X1	
	Ratón PS/2	X1	
	Puerto serie	X1	
	Puerto VGA	X1	
	Puerto de red local	X1	
	Puerto USB	X4	
	Conector de sonido	X3	
Tamaño de la placa	195 mm. (A) X 244 Mm. (H)		
Soporte de sistema operativo	Windows 2000 / XP / VISTA		Bestar se reserva el derecho de añadir o retirar el soporte de cualquier SO con osin aviso previo.

**PORTUGUESE**

<b>ESPECIFICAÇÕES</b>		
CPU	LGA 775 Processador Intel Core2Duo / Core2Quad/ Celeron 4xx / Pentium 4 / Pentium D / Celeron D	Suporta as tecnologias Hyper-Threading / Execute Disable Bit / Enhanced Intel SpeedStep® / Intel Architecture - 64 / Extended Memory 64 / Virtualization
FSB	533 / 800 / 1066 / 1333 MHz	
Chipset	Intel G31 Intel ICH7	
Especificação do Super I/O	ITE 8712F Proporciona as funcionalidades mais utilizadas em termos da especificação Super I/O. Interface LPC (Low Pin Count).	Iniciativas para controlo do ambiente Monitorização do hardware Controlador/Monitor da velocidade da ventoinha Função "Smart Guardian" da ITE
Memória principal	Ranuras DIMM DDR2 x 2 Cada módulo DIMM suporta uma memória DDR2 de 256 MB / 512 MB / 1GB / 2GB Capacidade máxima de memória: 4 GB	Módulo de memória DDR2 de canal duplo Suporta módulos DDR2 800/667 Suporta módulos DDR2 533 (w. FSB 533/1066 CPU) Os módulos DIMM registados e os DIMM ECC não são suportados
Placa gráfica	GMA 3100	Memória de vídeo máxima partilhada: 256 MB
IDE	Controlador IDE integrado	Modo Bus master Ultra DMA 33 / 66 / 100 Suporta o modo PIO 0~4,
SATA	Controlador Serial ATA integrado	Velocidades de transmissão de dados até 3.0 Gb/s. Compatibilidade com a especificação SATA versão 2.0.
LAN	Realtek RTL 8101E / 8102E / 8111C (opcional)	Auto negociação de 10 / 100 / 1000 Mb/s (a largura de banda Gigabit refere-se apenas à especificação Realtek RTL 8111C) Capacidade semi/full-duplex
Suporte para áudio de alta definição	ALC662	Suporta a especificação High-Definition Audio Saída de áudio de 5.1 canais

<b>ESPECIFICAÇÕES</b>			
Ranhuras	Ranhura PCI	x2	
	Ranhura PCI Express x16	x1	
	Ranhura PCI Express x 1	x1	
Conectores na placa	Conector da unidade de disquetes	x1	Cada conector suporta 2 unidades de disquetes
	Conector da para impressora	x1	Cada conector suporta 1 Porta para impressora
	Conector IDE	x1	Cada conector suporta 2 dispositivos IDE
	Conector SATA	x4	Cada conector suporta 1 dispositivo SATA
	Conector do painel frontal	x1	Para suporte de várias funções no painel frontal
	Conector de áudio frontal	x1	Suporta a função de áudio no painel frontal
	Conector para entrada de CDs	x1	Suporta a entrada de áudio a partir de CDs
	Conector de saída S/PDIF	x1	Suporta a saída de áudio digital
	Conector da ventoinha da CPU	x1	Alimentação da ventoinha da CPU (com a função Smart Fan)
	Conector da ventoinha do sistema	x1	Alimentação da ventoinha do sistema
	Conector para limpeza do CMOS	x1	
Conector USB	x2	Cada conector suporta 2 portas USB no painel frontal	
Conector de alimentação (24 pinos)	x1		
Conector de alimentação (4 pinos)	x1		
Entradas/Saídas no painel traseiro	Teclado PS/2	x1	
	Rato PS/2	x1	
	Porta série	x1	
	Porta VGA	x1	
	Porta LAN	x1	
	Porta USB	x4	
	Tomada de áudio	x3	
Tamanho da placa	195 mm (L) X 244 mm (A)		
Sistemas operativos suportados	Windows 2000 / XP / VISTA	A Biostar reserva-se o direito de adicionar ou remover suporte para qualquer sistema operativo com ou sem aviso prévio.	

**POLISH**

<i>SPEC</i>		
Procesor	LGA 775 Procesor Intel Core2Duo / Core2Quad / Celeron 4xx / Pentium 4 / Pentium D / Celeron D	Obsługa Hyper-Threading / Execute Disable Bit / Enhanced Intel SpeedStep® / Intel Architecture-64 / Extended Memory 64 Technology / Virtualization Technology
FSB	533 / 800 / 1066 / 1333 MHz	
Chipset	Intel G31 Intel ICH7	
Pamięć główna	Gniazda DDR2 DIMM x 2 Każde gniazdo DIMM obsługuje moduły 256MB / 512MB / 1GB / 2GB Maks. wielkość pamięci 4GB	Moduł pamięci DDR2 z trybem podwójnego kanału Obsługa DDR2 800/667 Obsługa DDR2 533 (w. FSB 533/1066 CPU) Brak obsługi Registered DIMM oraz ECC DIMM
Grafika	GMA 3100	Maks. wielkość współdzielonej pamięci video wynosi 256MB
Super I/O	ITE 8712F Zapewnia najbardziej powszechne funkcje Super I/O. Interfejs Low Pin Count	Funkcje kontroli warunków pracy Monitor H/W Kontroler/Monitor prędkości wentylatora Funkcja ITE "Smart Guardian"
IDE	Zintegrowany kontroler IDE	Ultra DMA 33 / 66 / 100 Tryb Bus Master obsługa PIO tryb 0~4,
SATA	Zintegrowany kontroler Serial ATA	Transfer danych do 3.0 Gb/s. Zgodność ze specyfikacją SATA w wersji 2.0.
LAN	Realtek RTL 8101E / 8102E / 8111C (opcja)	10 / 100 / 1000 Mb/s z automatyczną negocjacją szybkości (Pasmo gigabitowe wyłącznie dla Realtek RTL 8111C) Działanie w trybie podwójnego / pełnego duplexu
Obsługa audio HD	ALC662	Obsługa High-Definition Audio 5.1 kanałowe wyjście audio
Gniazda	Gniazdo PCI x2 Gniazdo PCI Express x16 x1	

SPEC			
	Gniazdo PCI Express x 1	x1	
Złącza wbudowane	Złącze napędu dyskiętek	x1	Każde złącze obsługuje 2 napędy dyskiętek
	Złącze Port drukarki	x1	Każde złącze obsługuje 1 Port drukarki
	Złącze IDE	x1	Każde złącze obsługuje 2 urządzenia IDE
	Złącze SATA	x4	Każde złącze obsługuje 1 urządzenie SATA
	Złącze panela przedniego	x1	Obsługa elementów panela przedniego
	Przednie złącze audio	x1	Obsługa funkcj audio na panelu przednim
	Złącze wejścia CD	x1	Obsługa funkcj wejścia audio CD
	Złącze wyjścia S/PDIF	x1	Obsługa funkcj cyfrowego wyjścia audio
	Złącze główkowe wentylatora procesora	x1	Zasilanie wentylatora procesora (z funkcj Smart Fan)
	Złącze główkowe wentylatora systemowego	x1	Zasilanie wentylatora systemowego
	Złącze główkowe kasowania CMOS	x1	
	Złącze USB	x2	Każde złącze obsługuje 2 porty USB na panelu przednim
	Złącze zasilania (24 pinowe)	x1	
Złącze zasilania (4 pinowe)	x1		
Back Panel I/O	Klawiatura PS/2	x1	
	Mysz PS/2	x1	
	Port szeregowy	x1	
	Port VGA	x1	
	Port LAN	x1	
	Port USB	x4	
	Gniazdo audio	x3	
Wymiary płyty	195 mm (S) X 244 mm (W)		
Obsługa systemu operacyjnego	Windows 2000 / XP / VISTA		Biostar zastrzega sobie prawo dodawania lub odwoływania obsługi dowolnego systemu operacyjnego bez powiadomienia.

**RUSSIAN**

<b>СПЕЦ</b>		
ЦПУ (центральный процессор)	LGA 775 Процессор Intel Core2Duo / Core2Quad / Celeron 4xx / Pentium 4 / Pentium D / Celeron D	Поддержка технологий Hyper-Threading / Execute Disable Bit / Enhanced Intel SpeedStep® / Intel Architecture-64 / Extended Memory 64 Technology / технологии виртуализация
FSB	533 / 800 / 1066 / 1333 МГц	
Набор микросхем	Intel G31 Intel ICH7	
Основная память	Слоты DDR2 DIMM x 2 Каждый модуль DIMM поддерживает 256 МБ / 512МБ / 1ГБ / 2ГБ DDR2 Максимальная ёмкость памяти 4ГБ	Модуль памяти с двухканальным режимом DDR2 Поддержка DDR2 800/667 Поддержка DDR2 533 (w. FSB 533/1066 CPU) Не поддерживает зарегистрированные модули DIMM and ECC DIMM
Графика	GMA 3100	Максимальная совместно используемая видео память составляет 256 МБ
Super I/O	ITE 8712F Обеспечивает наиболее используемые действующие функциональные возможности Super I/O. Интерфейс с низким количеством выводов	Инициативы по охране окружающей среды, Аппаратный монитор Регулятор скорости вентилятора/ монитор Функция ITE "Smart Guardian" (Интеллектуальная защита)
IDE	Встроенное устройство управления встроенными интерфейсами устройств	Режим "хвояина" шины Ultra DMA 33 / 66 / 100 Поддержка режима PIO 0~4,
SATA	Встроенное последовательное устройство управления ATA	скорость передачи данных до 3.0 гигабит/с. Соответствие спецификации SATA версия 2.0.
Локальная сеть	Realtek RTL 8101E / 8102E / 8111C (дополнительно)	Автоматическое согласование 10 / 100 / 1000 Мб/с (гигабитная пропускная способность только для гигабитного физического уровня) Частичная / полная дуплексная способность
Звуковая поддержка жесткого диска	ALC662	Звуковая поддержка High-Definition 5.1-канальный звуковой выход
Слоты	Слот PCI x2 Слот PCI Express x16 x1 Слот PCI Express x 1 x1	

СПЕЦ			
Встроенный разъем	Разъем НГМД	x1	Каждый разъем поддерживает 2 накопителя на гибких магнитных дисках
	Разъем Порт подключения принтера	x1	Каждый разъем поддерживает 1 Порт подключения принтера
	Разъем IDE	x1	Каждый разъем поддерживает 2 встроенных интерфейса накопителей
	Разъем SATA	x4	Каждый разъем поддерживает 1 устройство SATA
	Разъем на лицевой панели	x1	Поддержка устройств на лицевой панели
	Входной звуковой разъем	x1	Поддержка звуковых функций на лицевой панели
	Разъем ввода для CD	x1	Поддержка функции ввода для CD
	Разъем вывода для S/PDIF	x1	Поддержка вывода цифровой звуковой функции
	Контактирующее приспособление вентилятора центрального процессора	x1	Источник питания для вентилятора центрального процессора (с функцией интеллектуального вентилятора)
	Контактирующее приспособление вентилятора системы	x1	Источник питания для вентилятора системы
	Открытое контактирующее приспособление CMOS	x1	
	USB-разъем	x2	Каждый разъем поддерживает 2 USB-порта на лицевой панели
	Разъем питания (24 вывод)	x1	
Разъем питания (4 вывод)	x1		
Задняя панель средств ввода-вывода	Клавиатура PS/2	x1	
	Мышь PS/2	x1	
	Последовательный порт	x1	
	Порт VGA	x1	
	Порт LAN	x1	
	USB-порт	x4	
Гнездо для подключения наушников	x3		
Размер панели	195 мм (Ш) X 244 мм (В)		
Поддержка OS	Windows 2000 / XP / VISTA		Biostar сохраняет за собой право добавлять или удалять средства обеспечения для OS с или без предварительного уведомления.

## ARABIC

المواصفات		
Hyper-Threading / Execute Disable Bit / Enhanced Intel SpeedStep® / Intel Architecture-64 / Extended Memory 64 Technology / Virtualization Technology	LGA 775 Intel Core2Duo / Core2Quad / Celeron 4xx / Pentium 4 / Pentium D / Celeron D	وحدة المعالجة المركبة بتردد يصل إلى
	533 / 800 / 1066 / 1333	ميجا هرتز الجاهز المنقل الأممي الجاهز
	Intel G31 Intel ICH7	مجموعة الشرائح
مزدوجة قننة DDR2 ووحدة ذاكرة سعات 800/667 ميجا بايت DDR2 تدعم الذاكرة من نوع 533 ميجا بايت DDR2 تدعم الذاكرة من نوع CPU) (w. FSB 533/1066 ECC وتلك التي لا تتوافق مع DIMM لا تدعم رقائق الذاكرة	قننة DDR2 DIMM عدد سعة DDR2 دعم ذاكرة من نوع DIMM تدعم كل قننة ميجا بايت و 2 بايت و 1 جيجا بايت 256/512 سعة ذاكرة قصوى 4 جيجا بايت	الذاكرة الرئيسية
	GMA 3100	بطاقة الرسومات
وسائل التحكم في البيئة: مراقب لمعومة حلة الاجهزة مراقب في سرعة لمروحة ITE من "Smart Guardian" وظيفة	ITE 8712F الأكثر استخداماً Super I/O توفر وظيفة Low Pin Count Interface تدعم تقنية	Super I/O
وضع رئيسي Ultra DMA 33 / 66 / 100 نقل بتقنية PIO Mode 0~4 دعم وضع	متكامل IDE متحكم	منفذ IDE
ججبلت/ثانية/3.0 نقل البيانات بسرعات تصل إلى 2.0 الإصدار SATA مطابقة لمواصفات	متكامل Serial ATA متحكم	SATA
قراض قنني 100/10 ميجا بايت / ثانية و 1 جيجا بايت / ثانية Realtek RTL 8111C للفتق الترددي لججبلت مقصور فقط على إمكانية النقل لمزواج الكامل/القصفي	Realtek RTL 8101E / 8102E / 8111C (اختياري)	شبكة داخلية
تدعم تقنية لصوت عالي تعريف من 5.1 قنوات للخروج الصوت	ALC662	دعم لصوت عالي التعريف



المواصفات		
	عدد 2 فتحة PCI عدد 1 فتحة PCI Express x 16 عدد 1 فتحة PCI Express x 1	الفتحات
يدعم محرك الأقراص المرنة IDE يدعم منفذ اثنين من أجهزة SATA يدعم منفذ واحد من أجهزة يدعم تجهيزات الواجهة الأمامية يدعم وظيفة الصوت بالواجهة الأمامية يدعم وظيفة نخل صوت القوس لدمج يدعم وظيفة خروج الصوت الرقمي Smart Fan لتوصيل الطاقة لمروحة وحدة المعالجة مع وظيفة لتوصيل الطاقة لمروحة النظم بالواجهة الأمامية USB يدعم منفذ قمتي	عدد 1 مقعد محرك أقراص مرنة عدد 1 مقعد طابعة عدد 1 مقعد IDE عدد 4 مقعد SATA عدد 1 مقعد اللوحة الأمامية عدد 1 مقعد الصوت الأمامي عدد 1 مقعد CD-IN عدد 1 مقعد خرج S/PDIF عدد 1 وصلة مروحة وحدة المعالجة المركزية عدد 1 وصلة مروحة النظم عدد 1 وصلة مسح CMOS عدد 2 مقعد USB عدد 1 مقعد توصيل الطاقة (24-دوس) عدد 1 مقعد توصيل الطاقة (4-دبليس)	المنافذ على سطح اللوحة
	عدد 1 لوحة مفاتيح PS/2 عدد 1 ماس PS/2 عدد 1 مقعد تسلسلي عدد 1 مقعد VGA عدد 1 مقعد شبكة لتصل محلية عدد 4 منافذ USB عدد 3 مقياس صوت	منافذ نخل/خروج اللوحة الخلفية
	195 مم (عرض) X 244 مم (ارتفاع)	حجم اللوحة
بخطها في إضافة أو إزالة الدعم لأي نظام تشغيل بإخطار أو بدون Biostar تحتفظ بخطها.	Windows 2000 / XP / VISTA	دعم أنظمة التشغيل

## JAPANESE

仕様		
CPU	LGA 775 Intel Core2Duo / Core2Quad / Celeron 4xx processor	Hyper-Threading / Execute Disable Bit / Enhanced Intel SpeedStep® / Intel Architecture-64 / Extended Memory 64 Technology / Virtualization Technologyをサポートします
FSB	533 / 800 / 1066 / 1333 MHz	
チップセット	Intel G31 Intel ICH7	
メインメモリ	DDR2 DIMMスロット x 2 各DIMMは 256MB / 512MB / 1GB / 2GB DDR2をサポート 最大メモリ容量4GB	デュアル チャンネルモードDDR2メモリモジュール DDR2 800/667をサポート DDR2 533をサポート (w. FSB 533/1066 CPU) 登録済みDIMMとECC DIMMはサポートされません
グラフィックス	GMA 3100	最大の共有ビデオメモリは256MBです
Super I/O	ITE 8712F もっとも一般に使用されるレガシーSuper I/O機能を採用しています。 低ピンカウントインターフェイス	環境コントロールイニシアチブ、 H/Wモニター ファン速度コントローラ / モニター ITEの「スマートガーディアン」機能
IDE	統合IDEコントローラ	Ultra DMA 33 / 66 / 100バスマスタモード PIO Mode 0~4のサポート、
SATA	統合シリアルATAコントローラ	最高3.0 Gb/秒のデータ転送速度 SATAバージョン2.0仕様で準備。
LAN	Realtek RTL 8101E / 8102E / 8111C(オプション)	10 / 100 / 1000 Mb/秒のオートネゴシエーション (Gigabit) バンド幅はRealtek RTL 8111C専用です) 半/全二重機能
HDオーディオのサポート	ALC662	ハイデフィニションオーディオのサポート 5.1 チャンネルオーディオアウト

仕様			
スロット	PCIスロット	x2	
	PCI Express x16スロット	x1	
	PCI Express x 1スロット	x1	
オンボードコネクタ	フロッピーコネクタ	x1	各コネクタは2つのフロッピードライブをサポートします
	プリンタポートコネクタ	x1	各コネクタは1つのプリンタポートをサポートします
	IDEコネクタ	x1	各コネクタは2つのIDEデバイスをサポートします
	SATAコネクタ	x4	各コネクタは1つのSATAデバイスをサポートします
	フロントパネルコネクタ	x1	フロントパネル機能をサポートします
	フロントオーディオコネクタ	x1	フロントパネルオーディオ機能をサポートします
	CDインコネクタ	x1	CDオーディオイン機能をサポートします
	S/PDIFアウトコネクタ	x1	デジタルオーディオアウト機能をサポートします
	CPUファンヘッダ	x1	CPUファン電源装置(スマートファン機能を搭載)
	システムファンヘッダ	x1	システムファン電源装置
	CMOSクリアヘッダ	x1	
	USBコネクタ	x2	各コネクタは2つのフロントパネルUSBポートをサポートします
	電源コネクタ(24ピン)	x1	
電源コネクタ(4ピン)	x1		
背面パネル I/O	PS/2キーボード	x1	
	PS/2マウス	x1	
	シリアルポート	x1	
	VGAポート	x1	
	LANポート	x1	
	USBポート	x4	
	オーディオジャック	x3	
ボードサイズ	195 mm (幅) X 244 mm (高さ)		
OSサポート	Windows 2000 / XP / VISTA		Biostarは事前のサポートなしにOSサポートを追加または削除する権利を留保します。

2008/03/12