

***939GT2-Ultra -G / 939GT2-STD -G
939GT2-Ultra-P / 939GT2-STD-P***

USER'S MANUAL

***M/B For Socket 939 64-bit & Dual Core
Ready AMD Athlon64FX Processor***

NO. G03939GT2R111

Rev:1.0

Release date: June 2005

Trademark:

* Specifications and Information contained in this documentation are furnished for information use only, and are subject to change at any time without notice, and should not be construed as a commitment by manufacturer.

TABLE OF CONTENT

| | |
|----------------------------------------------------------------|----|
| USER'S NOTICE..... | ii |
| MANUAL REVISION INFORMATION..... | ii |
| COOLING SOLUTIONS..... | ii |
| CHAPTER 1 INTRODUCTION OF 939GT2 MOTHERBOARD SERIES | |
| 1-1 FEATURE OF MOTHERBOARD..... | 1 |
| 1-1.1 SPECIAL FEATURES OF MOTHERBOARD..... | 2 |
| 1-2 SPECIFICATION..... | 3 |
| 1-3 PERFORMANCE LIST..... | 4 |
| 1-4 LAYOUT DIAGRAM & JUMPER SETTING..... | 5 |
| CHAPTER 2 HARDWARE INSTALLATION | |
| 2-1 HARDWARE INSTALLATION STEPS..... | 7 |
| 2-2 CHECKING MOTHERBOARD'S JUMPER SETTING..... | 7 |
| 2-3 INSTALL CPU..... | 8 |
| 2-3-1 GLOSSARY..... | 8 |
| 2-3-2 ABOUT AMD Athlon64 939-PIN CPU..... | 9 |
| 2-4 INSTALL MEMORY..... | 10 |
| 2-5 EXPANSION CARD..... | 11 |
| 2-5-1 PROCEDURE FOR EXPANSION CARD INSTALLATION..... | 11 |
| 2-5-2 ASSIGNING IRQ FOR EXPANSION CARD..... | 11 |
| 2-5-3 INTERRUPT REQUEST TABLE FOR THIS MOTHERBOARD..... | 12 |
| 2-5-4 PCI-Express SLOT..... | 12 |
| 2-6 CONNECTORS, HEADERS..... | 13 |
| 2-6-1 CONNECTORS..... | 13 |
| 2-6-2 HEADERS..... | 16 |
| 2-7 STARTING UP YOUR COMPUTER..... | 19 |
| CHAPTER 3 INTRODUCING BIOS | |
| 3-1 ENTERING SETUP..... | 21 |
| 3-2 GETTING HELP..... | 21 |
| 3-3 THE MAIN MENU..... | 22 |
| 3-4 STANDARD CMOS FEATURES..... | 23 |
| 3-5 ADVANCED BIOS FEATURES..... | 24 |
| 3-6 ADVANCED CHIPSET FEATURES..... | 26 |
| 3-6-1 DRAM TIMING SETTINGS..... | 27 |
| 3-7 INTEGRATED PERIPHERALS..... | 28 |
| 3-7-1 ONCHIP IDE FUNCTION..... | 28 |
| 3-7-2 ONCHIP DEVICE FUNCTION..... | 29 |
| 3-7-3 ONCHIP SUPER IO FUNCTION..... | 30 |
| 3-8 POWER MANAGEMENT SETUP..... | 31 |
| 3-9 MISCELLANEOUS CONTROL..... | 32 |
| 3-9-1 IRQ RESOURCES..... | 33 |
| 3-10 PC HEALTH STATUS..... | 33 |
| 3-10-1 SMART FAN CONFIGURATIONS..... | 34 |
| 3-11 THERMAL THROTTLING OPTIONS..... | 34 |
| 3-12 POWER USER OVERCLOCK SETTINGS..... | 36 |
| 3-13 PASSWORD SETTINGS..... | 38 |
| 3-14 LOAD STANDARD/OPTIMIZED DEFAULTS..... | 38 |
| CHAPTER 4 DRIVER & FREE PROGRAM INSTALLATION | |
| MAGIC INSTALL SUPPORTS WINDOWS 9X/ME/NT4.0/2000/XP..... | 40 |
| 4-1 NFORCE INSTALL NFORCE INTEGRATED DRIVER..... | 41 |
| 4-2 SOUND INSTALL ALC655 CODEC AUDIO DRIVER..... | 43 |
| 4-3 LAN INSTALL MARVELL YUKON GIGABIT ETHERNET NIC DRIVER..... | 44 |
| 4-4 USB2.0 INSTALL INTEL USB2.0 DRIVER..... | 44 |
| 4-5 PC-CILLIN INSTALL PC-CILLIN 2005 ANTI-VIRUS PROGRAM..... | 45 |
| 4-6 PC-HEALTH INSTALL MYGUARD HARDWARE MONITOR UTILITY..... | 46 |
| 4-7 HOW TO UPDATE BIOS..... | 47 |
| 4-8 NFORCE4 PLATFORM RAID FUNCTION INSTALLATION..... | 47 |
| 4-9 Pro Magic Plus Function Introduction..... | 50 |

USER'S NOTICE

COPYRIGHT OF THIS MANUAL BELONGS TO THE MANUFACTURER. NO PART OF THIS MANUAL, INCLUDING THE PRODUCTS AND SOFTWARE DESCRIBED IN IT MAY BE REPRODUCED, TRANSMITTED OR TRANSLATED INTO ANY LANGUAGE IN ANY FORM OR BY ANY MEANS WITHOUT WRITTEN PERMISSION OF THE MANUFACTURER.

THIS MANUAL CONTAINS ALL INFORMATION REQUIRED TO USE 939GT4SLI MOTHERBOARD AND WE DO ASSURE THIS MANUAL MEETS USER'S REQUIREMENT BUT WILL CHANGE, CORRECT ANY TIME WITHOUT NOTICE. MANUFACTURER PROVIDES THIS MANUAL "AS IS" WITHOUT WARRANTY OF ANY KIND, AND WILL NOT BE LIABLE FOR ANY INDIRECT, SPECIAL, INCIDENTAL OR CONSEQUENTIAL DAMAGES (INCLUDING DAMAGES FOR LOSS OF PROFIT, LOSS OF BUSINESS, LOSS OF USE OF DATA, INTERRUPTION OF BUSINESS AND THE LIKE).

PRODUCTS AND CORPORATE NAMES APPEARING IN THIS MANUAL MAY OR MAY NOT BE REGISTERED TRADEMARKS OR COPYRIGHTS OF THEIR RESPECTIVE COMPANIES, AND THEY ARE USED ONLY FOR IDENTIFICATION OR EXPLANATION AND TO THE OWNER'S BENEFIT, WITHOUT INTENT TO INFRINGE.

Manual Revision Information

| Reversion | Revision History | Date |
|------------------|-------------------------|-------------|
| 1.0 | First Edition | June 2005 |

Item Checklist

- 939GT2-Ultra-G / 939GT2-STD-G / 939GT2-Ultra-P / 939GT2-STD-P motherboard
- Cable for IDE/Floppy
- CD for motherboard utilities
- SLI Supported Bridge
- Cable for Serial ATA IDE Port
- SPDIF-IN/SPDIF-OUT Adaptor
- 939GT2-Ultra-G / 939GT2-STD-G / 939GT2-Ultra-P / 939GT2-STD-P User's Manual

AMD K8 Processor Family Cooling Solutions

As processor technology pushes to faster speeds and higher performance with increasing operation clock, thermal management becomes increasingly crucial while building computer systems. Maintaining the proper computing environment without thermal increasing is the key to reliable, stable, and 24 hours system operation. The overall goal is keeping the processor below its specified maximum case temperature. Heatsinks induce improved processor heat dissipation through increasing surface area and concentrated airflow from attached active cooling fans. In addition, interface materials allow effective transfers of heat from the processor to the heatsink. For optimum heat transfer, AMD recommends the use of thermal grease and mounting clips to attach the heatsink to the processor.

Please refer to the website below for collection of heatsinks evaluated and recommended for Socket-939 processors by AMD. In addition, this collection is not intended to be a comprehensive listing of all heatsinks that support Socket-939 processors.

For vendor list of heatsinks and Active cooling fans, please visit:

http://www.amd.com/us-en/Processors/DevelopWithAMD/0,,30_2252_869_9460^9515,00.html

Chapter 1

Introduction of 939GT2 Motherboard Series

1-1 Features of motherboard

The 939GT2-Ultra-G / 939GT2-STD-G motherboard is based on NVIDIA nForce4-Ultra and nForce4 single chip technology which supports the innovative 64-bit AMD Athlon64 FX and dual core multi-tasking Athlon64 X2 processors with HyperTransport Technology. The 939GT2 motherboard series deliver the leading-edge performance with both of the benefits from 64-bit multi-tasking dual core AMD processors and NVIDIA Single Chipset Technology with the latest PCI Express x16 for the latest announced graphics. Utilize the 64-bit multi-tasking socket 939 solution and the dual channel PC3200 DDR memory size which are expandable to 4.0GB, the 939 GT2 motherboard series meet the demanding usage of computing from now to the future.

The motherboards carry the advanced NVIDIA nForce4 and nForce4-Ultra single chip with 1000 MHz HyperTransport technology bus of data transferring and provided with 133MHz / 166MHz / 200MHz memory clock frequency for DDR266/DDR333/DDR400 DDR Module with Dual channel function. NVIDIA nForce4 and nForce4 Ultra single chipset offers **ULTRA ATA 133 ,Serial ATA RAID 0, 1, 0+1, and Serial ATA2 RAID0, 1, 0+1(Only for 939GT2-Ultra motherboard series)** functions to accelerate hard disk drives and guarantee the data security without failed in advanced computing performance.

The 939GT2-Ultra-P / 939GT2-STD-P motherboard provides 10 / 100 LAN function with Realtek 8201CL LAN PHY. The 939GT2-Ultra-G / 939GT2-STD-G provides Giga LAN function by using the Marvell 88E1111 Giga-LAN PHY which supports 10M / 100M or 10M / 100M / 1Gbps data transfer rate. Embedded 6-channel AC'97 CODEC is fully compatible with Sound Blaster Pro[®] standards that offers you with the home cinema quality and absolutely software compatibility.

Colorful PCB and placement design offers one PCI-Express x16 graphics slot with 4Gbyte/sec data transfer rate at each relative direction which get 3.5 times of bandwidth more than AGP8X and up to 8Gbyte/sec concurrent bandwidth at full speed to guarantee the fully operational multi-GPUs graphics power. One PCI Express x1 I/O slot offers 512Mbyte/sec concurrently, over 3.5 times more bandwidth than PCI at 133Mbyte/sec, tackling the most demanding multimedia tasks nowadays.

Embedded USB controller as well as capability of expanding to 10 of USB2.0 functional ports delivering 480Mb/s bandwidth and rich connectivity, these motherboards meet the future USB demands which are also equipped with hardware monitor function on system to monitor and protect your system and maintain your non-stop business computing.

Some special features---**CPU Thermal Throttling/ CPU Vcore 7-shift/ CPU Smart Fan/ Debug Port(Option)** in this motherboard are designed for power user to use the over-clocking function in more flexible ways. But please be caution that the over-clocking maybe cause the fails in system reliabilities. This motherboard provides the guaranteed performance and meets the demands of the next generation computing. But if you insist to gain more system performance with variety possibilities of the components you choose, please be careful and make sure to read the detailed descriptions of these value added product features, please get them in the coming section.

1-1.1 Special Features of motherboard

CPU Thermal Throttling Technology---(The CPU Overheat Protection Technology)
To prevent the increasing heat from damage of CPU or accidental shutdown while at high workload, the CPU Thermal Throttling Technology will force CPU to enter partially idle mode from 87.5% to 12.5% according to preset CPU operating temperature in BIOS (from 40°C to 90°C). When the system senses the CPU operating temperature reaching the preset value, the CPU operating bandwidth will be decreased to the preset idle percentage to cool down the processor. When at throttling mode the beeper sound can be optionally selected to indicate it is in working. (for detail operating please read Section 3-11 Bi-turbo Configuration)

Debug Port (Option)--- (The Professional Hardware Diagnosis System)
Being bugged of abnormal system failure through the tossed and turned nights no more, the embedded Hardware Debug Port offers you the real-time visual system healthy for the demanding usage of computing. No more bugging by unknown system failure and no more time wasted in the first moment of 24-hour nonstop ping business computing, the embedded Debug Port will turn you into a well training hardware professional with the seeing system situation. (The Post Code please refer Appendix)

CPU Smart Fan---(The Noise Management System)
It's never been a good idea to gain the performance of your system by sacrificing its acoustics. CPU Smart Fan Noise Management System is the answer to control the noise level needed for now-a-day's high performance computing system. The system will automatically increase the fan speed when CPU operating loading is high, after the CPU is in normal operating condition, the system will low down the fan speed for the silent operating environment. The system can provide the much longer life cycle for both CPU and the system fans for game use and business requirements.

CPU Vcore 7-Shift--- (Shift to Higher Performance)
The CPU voltage can be adjusted up by 7 steps for the precisely over-clocking of extra demanding computing performance.

1-2 Specification

| Spec | Description |
|------------------------------------------|---------------------------------------------------------------------------------------------------------------------------------------------------------------------------------------------------------------------------------------------------------------------------------------------|
| Design | * ATX form factor 4 layers PCB size: 30.5x22.0cm |
| Chipset | * NVIDIA nForce4 and nForce4 Ultra Single Chip Technology |
| CPU Socket 939 | * Support 64bit AMD Athlon64 939-Pin package utilizes Flip-Chip Pin Grid Array package processor * Support for future AMD Athlon64 939-pin Dual –Core processors up to 4800+ with HTT Frequency 1GHz |
| Memory Socket | * 184-pin DDR Module socket x 4 * Support 4 pcs DDR266/DDR33/DDR400 DDR Modules which are Expandable to 4.0GB * Support Dual channel function |
| Expansion Slot | * PCI-Express x16 slot 1pcs delivers up to 8GB/s concurrent bandwidth. * PCI-Express x1 slot 1pcs delivers up to 512MB/s concurrent bandwidth * 32-bit PCI slot x 3pcs for the most popular and cost-effective expansion cards for multimedia and communications. |
| Integrate Serial ATA2 RAID | * Four Serial ATA2 ports provide 300 MB/sec data transfer rate with RAID 0, 1, 0+1 functions for 939GT2-Ultra motherboard series. |
| Integrate IDE and Serial ATA RAID | * Two PCI IDE controllers support PCI Bus Mastering, ATA PIO/DMA and the ULTRA DMA 33/66/100/133 functions that deliver the data transfer rate up to 133 MB/s; Four Serial ATA / ports provide 150 MB/sec data transfer rate for Four Serial ATA Devices and offer RAID 0, 1, 0+1 functions |
| Ethernet LAN | * Integrated Marvel 88E1111 PCI-10/100 / 1000 LAN PHY for 939GT2-Ultra-G and and 939 GT2-STD -G series and optional PCI-10 / 100 LAN PHY for 939GT2-Ultra-P and and 939 GT2-STD -P series * Supports Fast Ethernet LAN function provide 10Mb/100Mb/ 1Gb /s data transfer rate. |
| 6CH-Audio | * AC'97 Digital Audio controller integrated * 6-channel AC'97 Audio CODEC on board * SPDIF-In/ SPDIF-Out Optical support (Cable optional) * Audio driver and utility included |
| BIOS | * Award 4MB Flash ROM |
| Multi I/O | * PS/2 keyboard and PS/2 mouse connectors * Floppy disk drive connector x1 * Parallel port x1 * Serial port x2 * USB2.0 port x 6 and headers x 4 (connecting cable option) * Audio connector (Line-in, Line-out, MIC/ 6CH Audio) |

1-3 Performance List

The following performance data list is the testing result of some popular benchmark testing programs. These data are just referred by users, and there is no responsibility for different testing data values gotten by users (the different Hardware & Software configuration will result in different benchmark testing results.)

Performance Test Report

CPU: AMD K8 Athlon64 3200+ Support (Socket 939, 512k L2 cache)
DRAM: KingMax MPTC220D-38HT 512MB DDR500 X 2 (1Gbyte) Memory
VGA Card : GeForce6600GT 128M PCI-E VGA CARD X 2 (1024X768X32BIT Color)
Hard Disk Driver: Seagate Barracude 7200.7 SATA150
BIOS: Award Optimal default
OS: Windows XP Professional (SERVICE PACK 2)

| | Ultra / 200/200 Dual channel | STD / 200/200 Dual channel |
|-----------------------------------------------------------------------------------------------------------------|-------------------------------|-------------------------------|
| 3D Mark 2001SE | 18286 | 18280 |
| 3D Mark 2003 | 8101 | 8137 |
| 3D Mark 2005 | 3532 | 3545 |
| AQUAMRK3 | 53014 (7545 / 8912) | 53336 (7569 / 9021) |
| PCMark2004 | | |
| System / CPU / Memory | 4072 / 3846 / 4401 | 4089 / 3854 / 4427 |
| Graph / HDD | 4436 / 4663 | 4391 / 4619 |
| Content Creation Winstone 2004 | 31.5 | 31.7 |
| Business Winstone 2004 | 22.8 | 23 |
| Winbench 99 V2.0: | | |
| Business/Hi-end Disk Winmark99 | 18700 / 41000 | 20300 / 41900 |
| Business/Hi-end Graphic Winmark | 1240 / 1930 | 1170 / 1990 |
| SISMark 2004: SISMark Rating(Internet Content Creation / Office Productivity) | | |
| SISMark 2004 | 175 (184 / 167) | 178 (184 / 172) |
| 3D Creation / 2D Creation | 169 / 255 | 170 / 228 |
| / Web publication | 163 | 161 |
| Communication / Document | 179 / 175 | 191 / 175 |
| / Data Analysis | 150 | 153 |
| SISOFT Sandra 2004 : 1.CPU Arithmetic Benchmark 2.Memory bandwidth Benchmark 3.CPU Multi-Media Benchmark | | |
| 1.Dhrystone ALU MIPS | 8576 | 8574 |
| Whetstone FPU iSSE2 FLOPS | 3293 / 4275 | 3279 / 4256 |
| 2.Int/Float Buffered iSSE2 MB/S | 4828 / 4828 | 4640 / 4643 |
| 3.Integer/Floating-Point IT/S | 19137 / 20650 | 19117 / 20669 |
| UT2003 Benchmark | 247.92 / 83.34 | 253.46 / 85.33 |
| Quake3 DEMO1 / FPS | N / A | N / A |
| Return to Castle FPS | 75.0 | 75.4 |
| Super Pi (1M) Second | 44s | 43s |
| CPUZ System / CPU Clock | 200.9 / 200.9 / 2009.3 | 200.9 / 200.9 / 2009.3 |

1-4 Layout Diagram & Jumper Setting

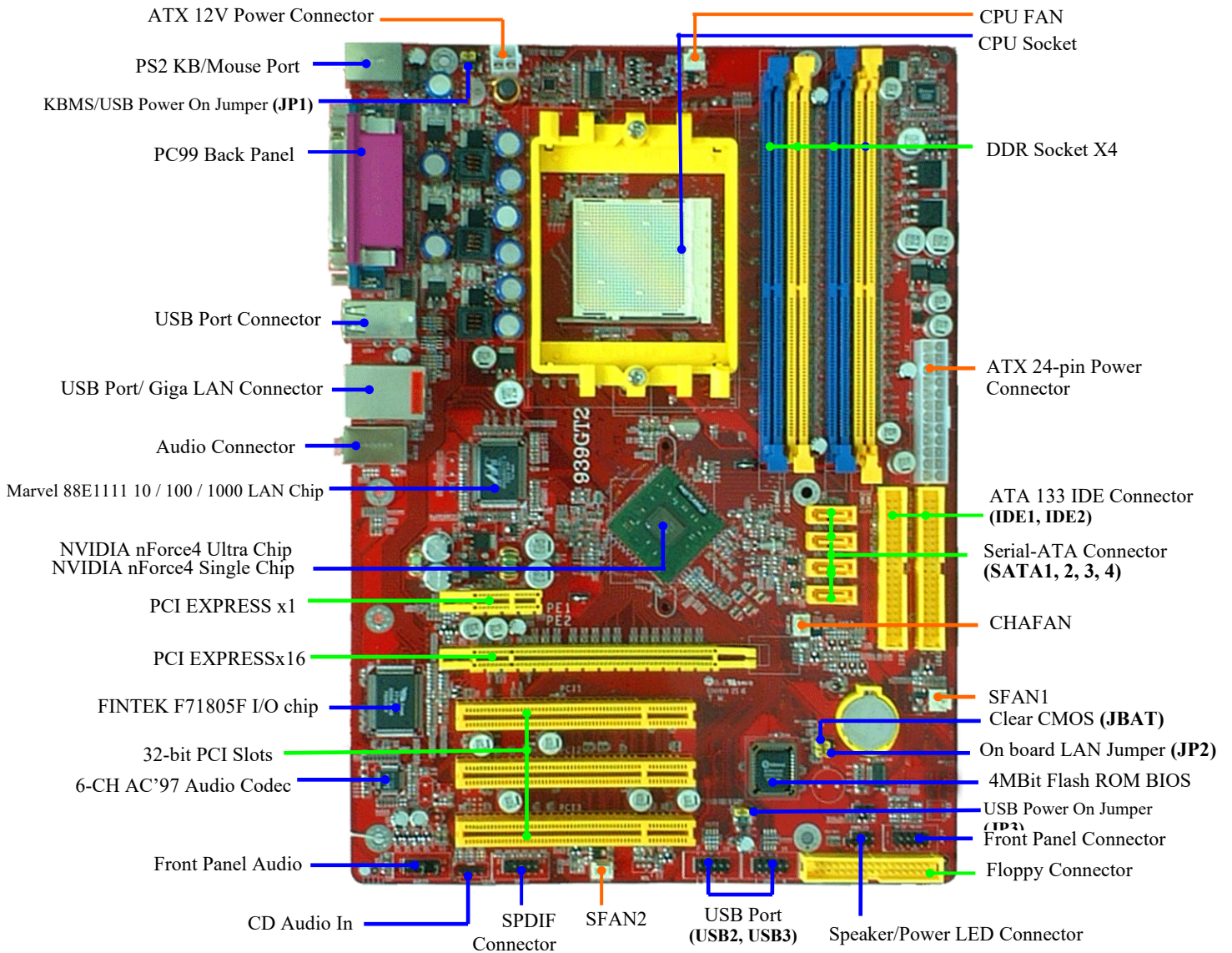
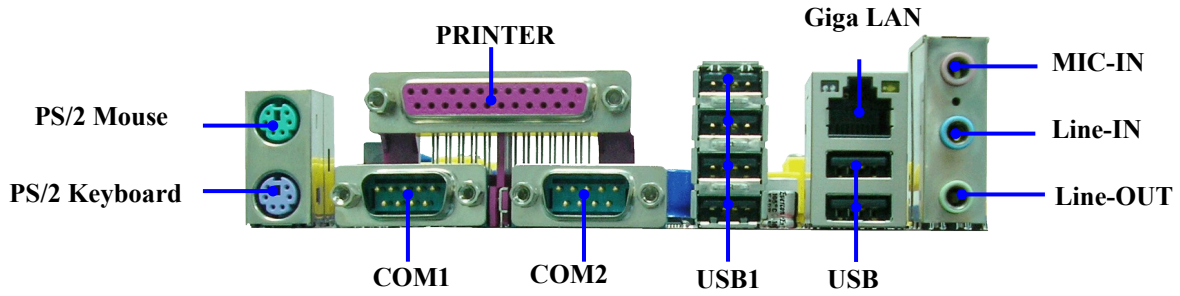

939GT2-Ultra series support Serial ATA & Serial ATA2 with RAID functions.

Jumpers

| Jumper | Name | Description | Page |
|---------------|-------------------------------------------|--------------------|-------------|
| JBAT | CMOS RAM Clear | 3-pin Block | P.7 |
| JP1 | Keyboard/USB0,1 Power On Enabled/Disabled | 3-pin Block | P.8 |
| JP2 | On board Marvell LAN Enabled/Disabled | 3-pin Block | P.8 |
| JP3 | USB Power On Enabled/Disabled | 3-pin Block | P.8 |

Connectors

| Connector | Name | Description | Page |
|------------------|--------------------------------------|------------------------|-------------|
| ATXPWR24P | ATX Power Connector | 24-pin Block | P.13 |
| ATX12V | ATX 12V Power Connector | 4-pin Block | P.13 |
| PS2KBMS | PS/2 Mouse & PS/2 Keyboard Connector | 6-pin Female | P.14 |
| USB / USB1 | USB Port Connector | 4-pin Connector | P.14 |
| USB / LAN | Giga-LAN Port Connector | RJ-45 Connector | P.14 |
| PARALLEL | Parallel Port Connector | 25-pin Female | P.14 |
| J1 | 6-CH Audio Connector | 3 phone jack Connector | P.14 |
| COM1/COM2 | Serial Port COM1/COM2 Connector | 9-pin Connector | P.14 |
| FDD | Floppy Driver Connector | 34-pin Block | P.15 |
| IDE1/IDE2 | Primary/Secondary IDE Connector | 40-pin Block | P.15 |
| SATA1~4 | Serial ATA IDE Connector | 7-pin Connector | P.16 |

Headers

| Header | Name | Description | Page |
|--------------------------------------------------------|---------------------------------------------------------------------------------------------------------|--------------------|-------------|
| AUDIO | SPEAKER, MIC header | 9-pin Block | P.16 |
| USB2, USB3 | USB Port Headers | 9-pin Block | P.17 |
| SPEAK | PC Speaker connector | 4-pin Block | P.17 |
| PWR LED | Power LED | 3-pin Block | P.17 |
| JW_FP (Power LED/Reset/ IDE LED/Power Button) | Front Panel Header (including Power LED/ IDE activity LED/Reset switch / Power On Button lead) | 9-pin Block | P.17 |
| SFAN1, SFAN2 CPUFAN | FAN Headers | 3-pin Block | P.17 |
| CDIN | CD Audio-In Header | 4-pin Block | P.18 |
| SPDIF | Optical In/Out Header | 9-pin Block | P.18 |

Expansion Sockets

| Socket/Slot | Name | Description | Page |
|--------------------|----------------------|--------------------------------------|-------------|
| ZIF Socket 939 | CPU Socket | 939-pin mPGAB Athlon64 CPU Socket | P.9 |
| DIMM1~4 | DDR Module Socket | 184-pin DDR Module Socket | P.10 |
| PCI1~ PCI3 | PCI Slot | 32-bit PCI Local Bus Expansion slots | P.11 |
| PE1 | PCI-Express x1 Slot | PCI-Express x1 Expansion Slot | P.12 |
| PE3 | PCI-Express x16 Slot | PCI-Express x16 Expansion Slot | P.12 |

Chapter 2

Hardware Installation

2-1 Hardware installation Steps

Before using your computer, you had better complete the following steps:

1. Check motherboard jumper setting
2. Install CPU and Fan
3. Install System Memory (DIMM)
4. Install Expansion cards
5. Connect IDE and Floppy cables, Front Panel /Back Panel cable
6. Connect ATX Power cable
7. Power-On and Load Standard Default
8. Reboot
9. Install Operating System
10. Install Driver and Utility

2-2 Checking Motherboard's Jumper Setting

(1) CMOS RAM Clear (3-pin) : JBAT

A battery must be used to retain the motherboard configuration in CMOS RAM short 1-2 pins of JBAT to store the CMOS data.

To clear the CMOS, follow the procedure below:

1. Turn off the system and unplug the AC power
2. Remove ATX power cable from ATX power connector
3. Locate JBAT and short pins 2-3 for a few seconds
4. Return JBAT to its normal setting by shorting pins 1-2
5. Connect ATX power cable back to ATX power connector

Note: When should clear CMOS

1. *Troubleshooting*
2. *Forget password*
3. *After over clocking system boot fail*

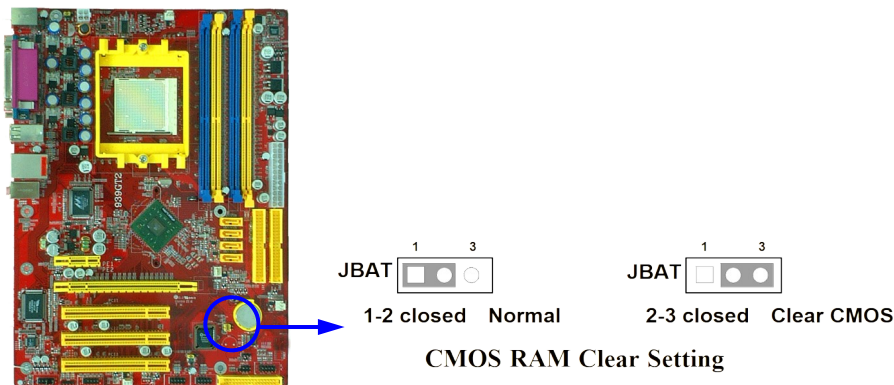

(2) On Board Marvell LAN function Enabled/Disabled: JP2

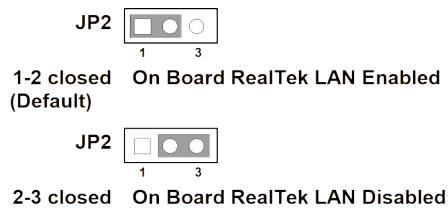
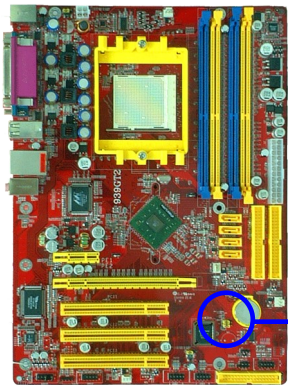

On Board Marvell LAN Setting

(3) Keyboard/USB Power On function Enabled/Disabled: JP1, JP3

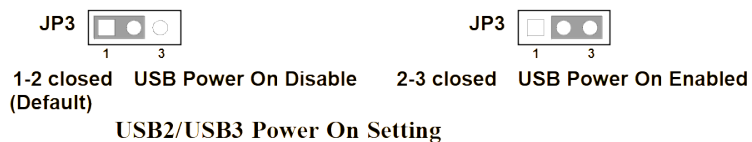
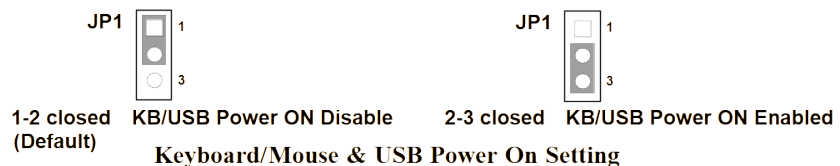
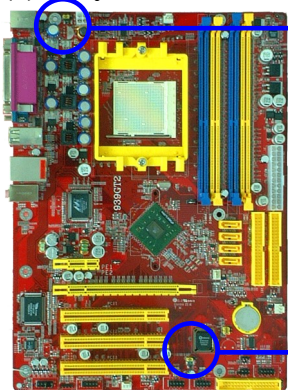

2-3 Install CPU

2-3-1 Glossary

Chipset (or core logic) - two or more integrated circuits which control the interfaces between the system processor, RAM, I/O devices, and adapter cards.

Processor slot/socket - the slot or socket used to mount the system processor on the motherboard.

Slot (PCI-E, PCI, RAM) - the slots used to mount adapter cards and system RAM.

AGP - Accelerated Graphics Port - a high speed interface for video cards; runs at 1X (66MHz), 2X (133MHz), or 4X (266MHz), or 8X (533MHz).

PCI - Peripheral Component Interconnect - a high speed interface for video cards, sound cards, network interface cards, and modems; runs at 33MHz.

PCI Express- Peripheral Component Interconnect Express- a high speed interface for video cards, sound cards, network interface cards, and modems.

Serial Port - a low speed interface typically used for mouse and external modems.

Parallel Port - a low speed interface typically used for printers.

PS/2 - a low speed interface used for mouse and keyboards.

USB - Universal Serial Bus - a medium speed interface typically used for mouse, keyboards, scanners, and some digital cameras.

Sound (interface) - the interface between the sound card or integrated sound connectors and speakers, MIC, game controllers, and MIDI sound devices.

LAN (interface) - Local Area Network - the interface to your local area network.

BIOS (Basic Input/Output System) - the program logic used to boot up a computer and establish the relationship between the various components.

Driver - software, which defines the characteristics of a device for use by another device or other software.

Processor - the "central processing unit" (CPU); the principal integrated circuit used for doing the "computing" in "personal computer"

Front Side Bus Frequency - the working frequency of the motherboard, which is generated by the clock generator for CPU, DRAM and PCI BUS.

CPU L2 Cache - the flash memory inside the CPU, normal it depend on CPU type.

2-3-2 About AMD Athlon64 939-pin CPU

This motherboard provides a 939-pin surface mount, Zero Insertion Force (ZIF) socket, referred to as the mPGA939 socket supports AMD Athlon64 processor in the 939 Pin package utilizes Flip-Chip Pin Grid Array package technology.

The CPU that comes with the motherboard should have a cooling FAN attached to prevent overheating. If this is not the case, then purchase a correct cooling FAN before you turn on your system.

WARNING! Be sure that there is sufficient air circulation across the processor's heatsink and CPU cooling FAN is working correctly, otherwise it may cause the processor and motherboard overheat and damage, you may install an auxiliary cooling FAN, if necessary.

To install a CPU, first turn off your system and remove its cover. Locate the ZIF socket and open it by first pulling the level sideways away from the socket then upward to a 90-degree angle. Insert the CPU with the correct orientation as shown below. The notched corner should point toward the end of the level. Because the CPU has a corner pin for two of the four corners, the CPU will only fit in the orientation as shown.

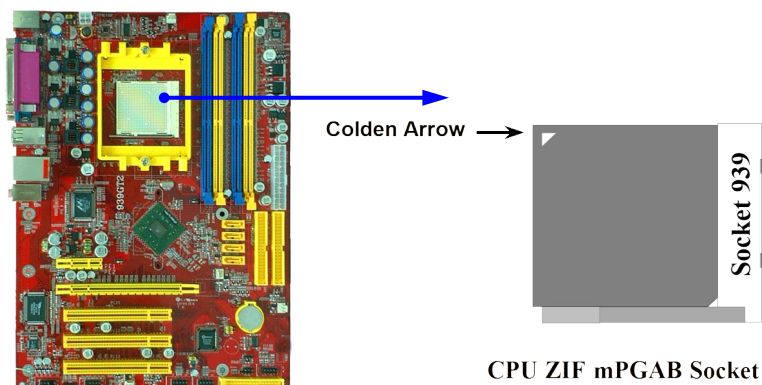

When you put the CPU into the ZIF socket. No force require to insert of the CPU, then press the level to Locate position slightly without any extra force.

2-4 Install Memory

This motherboard provides **four** 184-pin DDR DUAL INLINE MEMORY MODULES (DIMM) sites for DDR memory expansion available from minimum memory size of 128MB to maximum memory size of 4.0GB DDR SDRAM.

Valid Memory Configurations

| Bank | 184-Pin DIMM | PCS | Total Memory |
|-------------------|----------------------------|-----|--------------|
| Bank 0, 1 (DIMM1) | DDR266/DDR333/DDR400 | X1 | 128MB~1.0GB |
| Bank 2, 3 (DIMM2) | DDR266/DDR333/DDR400 | X1 | 128MB~1.0GB |
| Bank 4, 5 (DIMM3) | DDR266/DDR333/DDR400 | X1 | 128MB~1.0GB |
| Bank 6,7 (DIMM4) | DDR266/DDR333/DDR400 | X1 | 128MB~1.0GB |
| Total | System Memory (Max. 4.0GB) | 4 | 128MB~4.0GB |

Recommend DIMM Module Combination

1. **One DIMM Module** ---Plug in DIMM1
2. **Two DIMM Modules**---Plug in DIMM1 and DIMM3 for Dual channel function
3. **Four DIMM Modules**---Plug in DIMM1/DIMM2/DIMM3/DIMM4.

For Dual channel Limited!

4. Dual channel function only supports when 2 DIMM Modules plug in either both DIMM1 & DIMM3 or DIMM2 & DIMM4, or four DIMM Modules plug in DIMM1~DIMM4.
5. DIMM1 & DIMM3, or DIMM2 & DIMM4 must be the same type, same size, same frequency for dual channel function.

Generally, installing DDR SDRAM modules to your motherboard is very easy, you can refer to figure 2-4 to see what a 184-Pin DDR266/DDR333/DDR400 DDR SDRAM module looks like.

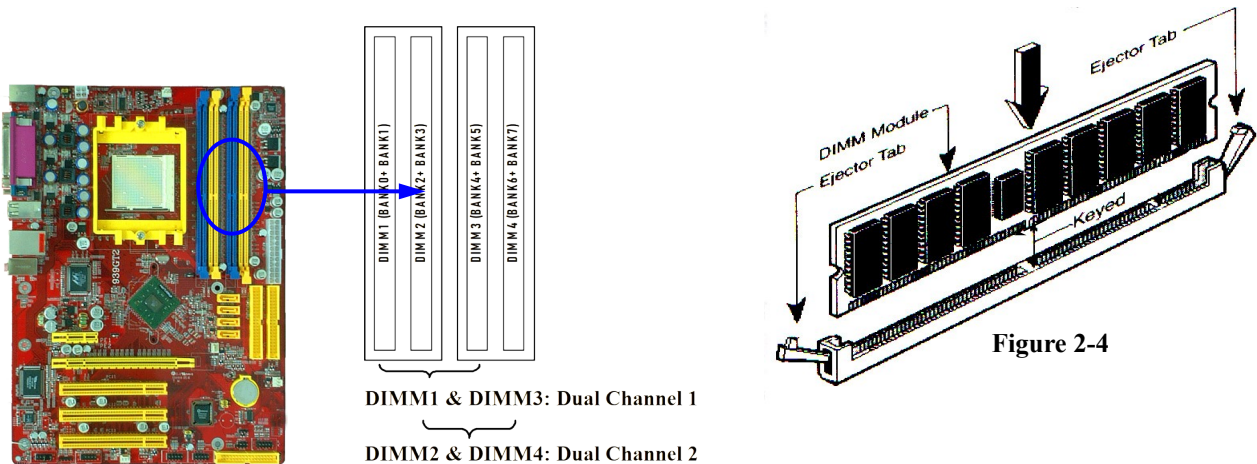

NOTE!

When you install DIMM module fully into the DIMM socket the eject tab should be locked into the DIMM module very firmly and fit into its indentation on both sides.

WARNING!

For the DDR SDRAM CLOCK is set at 200MHz, use only DDR400- compliant DDR Modules. When this motherboard operate at 200Mhz, most system will

not even boot if non-compliant modules are used because of the strict timing issues, if your DDR Modules are not DDR400-compliant, set the SDRAM clock to 133MHz to ensure system stability.

2-5 Expansion Cards

WARNING! Turn off your power when adding or removing expansion cards or other system components. Failure to do so may cause severe damage to both your motherboard and expansion cards.

2-5-1 Procedure For Expansion Card Installation

1. Read the documentation for your expansion card and make any necessary hardware or software setting for your expansion card such as jumpers.
2. Remove your computer's cover and the bracket plate on the slot you intend to use.
3. Align the card's connectors and press firmly.
4. Secure the card on the slot with the screen you remove above.
5. Replace the computer system's cover.
6. Set up the BIOS if necessary.
7. Install the necessary software driver for your expansion card.

2-5-2 Assigning IRQs For Expansion Card

Some expansion cards need an IRQ to operate. Generally, an IRQ must exclusively assign to one use. In a standard design, there are 16 IRQs available but most of them are already in use.

Standard Interrupt Assignments

| IRQ | Priority | Standard function |
|------|----------|-----------------------------|
| 0 | N/A | System Timer |
| 1 | N/A | Keyboard Controller |
| 2 | N/A | Programmable Interrupt |
| 3 * | 8 | Communications Port (COM2) |
| 4 * | 9 | Communications Port (COM1) |
| 5 * | 6 | Sound Card (sometimes LPT2) |
| 6 * | 11 | Floppy Disk Controller |
| 7 * | 7 | Printer Port (LPT1) |
| 8 | N/A | System CMOS/Real Time Clock |
| 9 * | 10 | ACPI Mode when enabled |
| 10 * | 3 | IRQ Holder for PCI Steering |
| 11 * | 2 | IRQ Holder for PCI Steering |
| 12 * | 4 | PS/2 Compatible Mouse Port |
| 13 | N/A | Numeric Data Processor |
| 14 * | 5 | Primary IDE Channel |
| 15 * | 1 | Secondary IDE Channel |

* These IRQs are usually available for ISA or PCI devices.

2-5-3 Interrupt Request Table For This Motherboard

Interrupt request are shared as shown the table below:

| | INT A | INT B | INT C | INT D | INT E | INT F | INT G | INT H |
|---------------|-------|-------|-------|-------|-------|-------|-------|-------|
| Slot 1 | | √ | | | | | | |
| Slot 2 | | | √ | | | | | |
| Slot 3 | | | | √ | | | | |
| Onboard USB 1 | √ | | | | | | | |
| Onboard USB 2 | | √ | | | | | | |
| AC97/MC97 | | | √ | | | | | |

IMPORTANT! If using PCI cards on shared slots, make sure that the drivers support “Shared IRQ” or that the cards don’t need IRQ assignments. Conflicts will arise between the two PCI groups that will make the system unstable or cards inoperable.

2-5-4 PCI Express Slot

This motherboard provides one 16-lane PCI Express slot intended for Graphics Attach which offers 4Gbyte/sec data transfer rate at each relative direction., and one x1 PCI Express Slot. Fully compliant to the *PCI Express Base Specification revision 1.0a* , support PCI Express VGA card, and other PCI Express device.

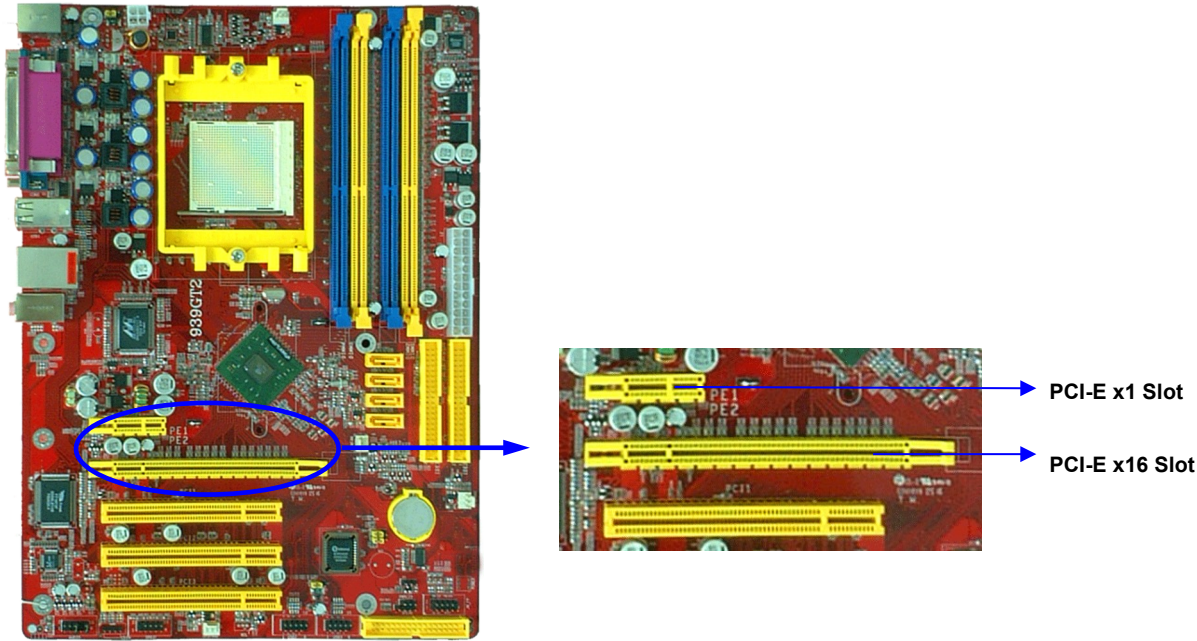

IMPORTANT! The modification for chipset is not an option for end users. Or you may get no warranty for the motherboard you purchased.

2-6 Connectors, Headers

2-6-1 Connectors

(1) Power Connector (24-pin block) : ATXPWR24P

ATX Power Supply connector. This is a new defined 24-pins connector that usually comes with ATX case. The ATX Power Supply allows to use soft power on momentary switch that connect from the front panel switch to 2-pins Power On jumper pole on the motherboard. When the power switch on the back of the ATX power supply turned on, the full power will not come into the system board until the front panel switch is momentarily pressed. Press this switch again will turn off the power to the system board.

- ** We recommend that you use an ATX 12V Specification 2.0-compliant power supply unit (PSU) with a minimum of 350W power rating. This type has 24-pin and 4-pin power plugs.
- ** If you intend to use a PSU with 20-pin and 4-pin power plugs, make sure that the 20-pin power plug can provide at least 15A on +12V and the power supply unit has a minimum power rating of 350W. The system may become unstable or may not boot up if the power is inadequate.

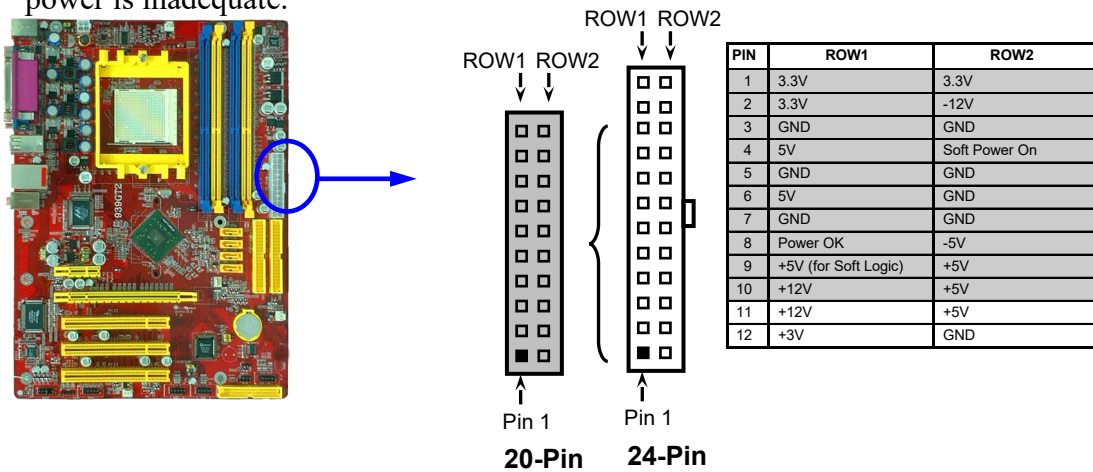

(2) ATX 12V Power Connector (4-pin block) : ATX12V

This is a new defined 4-pins connector that usually comes with ATX Power Supply. The ATX Power Supply which fully support Pentium 4 processor must including this connector for support extra 12V voltage to maintain system power consumption. Without this connector might cause system unstable because the power supply can not provide sufficient current for system.

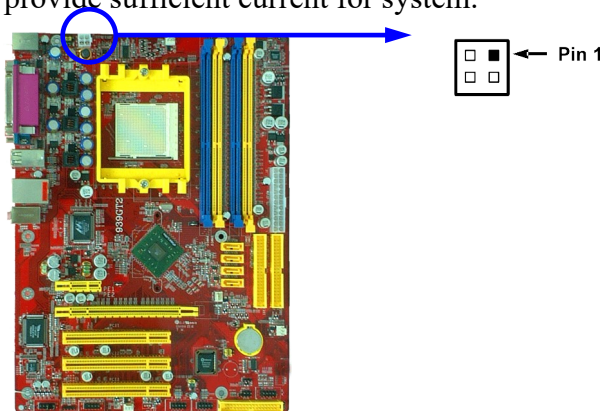

(3) PS/2 Mouse & PS/2 Keyboard Connector: PS2KBMS

The connectors for PS/2 keyboard and PS/2 Mouse.

(4) **USB Port connector: USB0/USB1**

The connectors are 4-pin connector that connect USB devices to the system board.

(5) **LAN Port connector: USBLAN**

This connector is standard RJ45 connector for Ethernet Compatible Network.

The USBLAN support 10M/100M/1G b/s data transfer rate (1Gb/s for 939GT2-STD-G and 939GT2-Ultra-G motherboard series)

(6) **Parallel Port Connector (25-pin female): PARALLEL**

Parallel Port connector is a 25-pin D-Subminiature Receptacle connector. The On-board Parallel Port can be disabled through the BIOS SETUP. Please refer to Chapter 3 “INTEGRATED PERIPHERALS SETUP” section for more detail information.

(7) **Audio Line-In, Lin-Out, MIC, Connector : J1**

This Connector are 3 phone Jack for LINE-OUT, LINE-IN, MIC

Line-in : (BLUE) Audio input to sound chip (Rear Speaker)

Line-out : (GREEN) Audio output to speaker (Front Speaker)

MIC : (PINK) Microphone Connector (Base/Center)

(8) **Serial Port COM1/COM2 : COM1/COM2**

COM1 is the 9-pin D-Subminiature male connector. The On-board serial port can be disabled through BIOS SETUP. Please refer to Chapter 3 “INTEGRATED PERIPHERALS SETUP” section for more detail information.

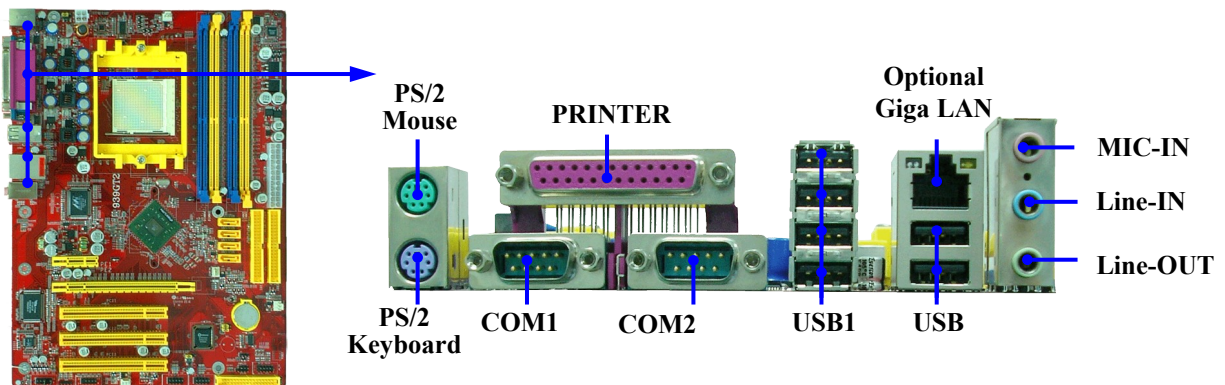

(9) **Floppy drive Connector (34-pin block): FDD**

This connector supports the provided floppy drive ribbon cable. After connecting the single plug end to motherboard, connect the two plugs at other end to the floppy drives.

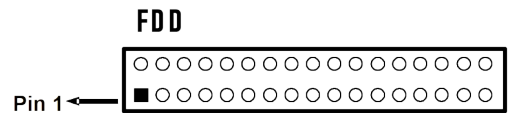
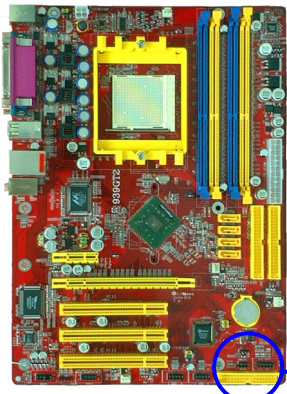

Floppy Drive Connector

(10) Primary IDE Connector (40-pin block): IDE1

This connector supports the provided IDE hard disk ribbon cable. After connecting the single plug end to motherboard, connect the two plugs at other end to your hard disk(s). If you install two hard disks, you must configure the second drive to Slave mode by setting its jumpers accordingly. Please refer to the documentation of your hard disk for the jumper settings.

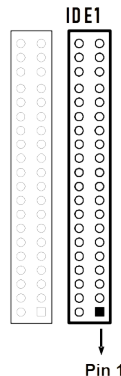
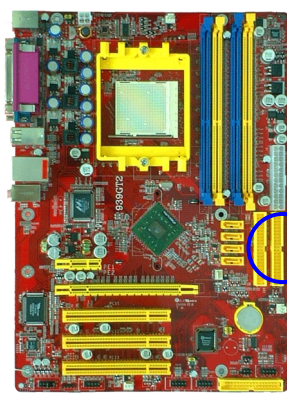

Primary IDE Connector

(11) Secondary IDE Connector (40-pin block): IDE2

This connector connects to the next set of Master and Slave hard disks. Follow the same procedure described for the primary IDE connector. You may also configure two hard disks to be both Masters using one ribbon cable on the primary IDE connector and another ribbon cable on the secondary IDE connector.

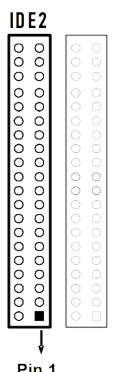
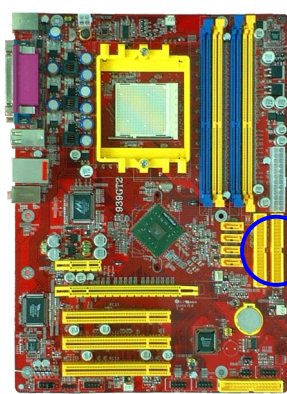

Secondary IDE Connector

- Two hard disks can be connected to each connector. The first HDD is referred to as the “Master” and the second HDD is referred to as the “Slave”.
- For performance issues, we strongly suggest you don’t install a CD-ROM or DVD-ROM drive on the same IDE channel as a hard disk. Otherwise, the system performance on this channel may drop.

(12) Serial-ATA Port connector: SATA1 / SATA2 / SATA3/ SATA4

This connector support the provided Serial ATA and Serial ATA2(Only for 939GT2-Ultra Series) IDE hard disk cable to connecting the motherboard and serial ATA hard disk.

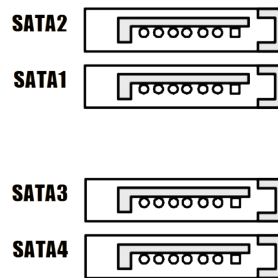
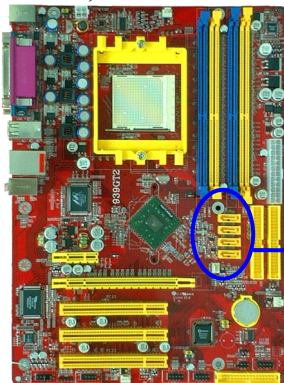

Serial-ATA 1 & 2 Port Connector

2-6-2 Headers

(1) Line-Out/MIC Header for Front Panel (9-pin): AUDIO

This header connect to Front Panel Line-out, MIC connector with cable.

Without install the cable, this header default setting is 5-6 short, 9-10 short. When you install the cable you have take off these jumpers.

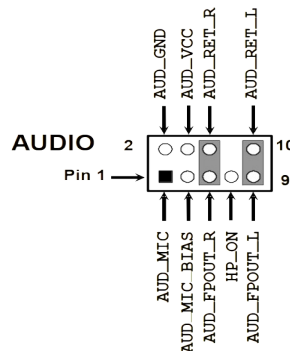
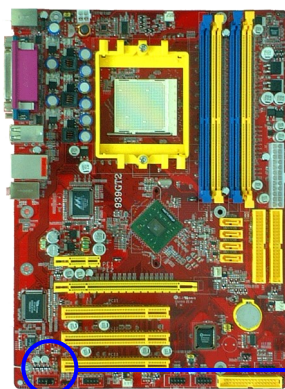

Line-Out, MIC Headers

(2) USB Port Headers (9-pin) : USB2/USB3

These headers are used for connecting the additional USB port plug. By attaching an option USB cable, your can be provided with two additional USB plugs affixed to the back panel.

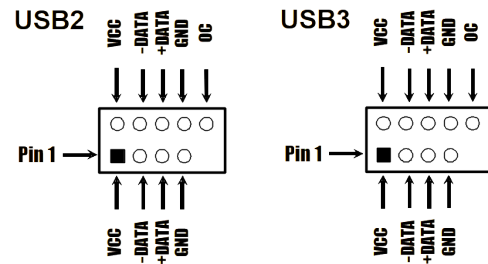
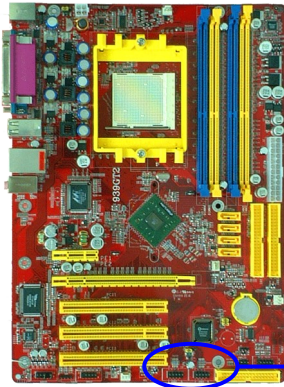

USB Port Headers

(3) Speaker connector: SPEAK

This 4-pin connector connects to the case-mounted speaker. See the figure below.

(4) Power LED: PWR LED

The Power LED is light on while the system power is on. Connect the Power LED from the system case to this pin.

(5) IDE Activity LED: HD LED

This connector connects to the hard disk activity indicator light on the case.

(6) Reset switch lead: RESET

This 2-pin connector connects to the case-mounted reset switch for rebooting your computer without having to turn off your power switch. This is a preferred method of rebooting in order to prolong the life of the system's power supply. See the figure below.

(7) Power switch: PWR BTN

This 2-pin connector connects to the case-mounted power switch to power ON/OFF the system.

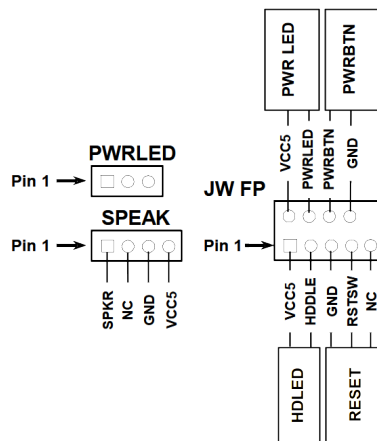
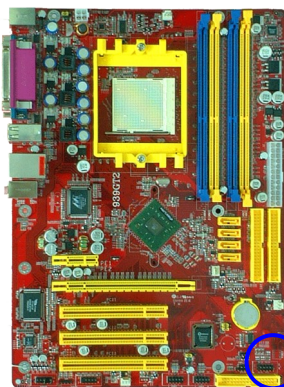

System Case Connections

(8) FAN Headers (3-pin) : CHAFAN, SFAN1, SFAN2, CPUFAN

These connectors support cooling fans of 350mA (4.2 Watts) or less, depending on the fan manufacturer, the wire and plug may be different. The red wire should be positive, while the black should be ground. Connect the fan's plug to the board taking into consideration the polarity of connector.

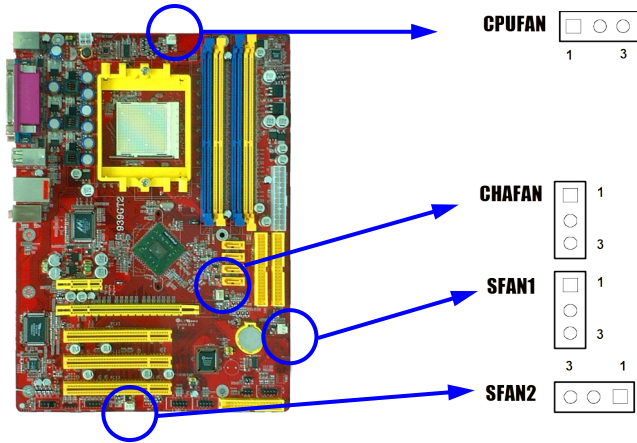

(9) CD Audio-In Headers (4-pin) : CDIN

CDIN are the connectors for CD-Audio Input signal. Please connect it to CD-ROM CD-Audio output connector.

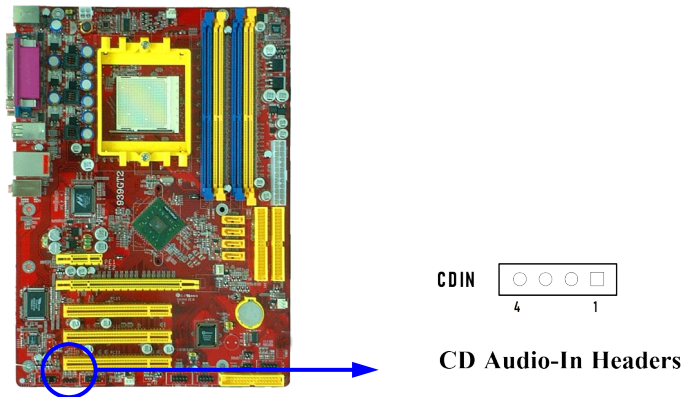

(10) Optical In/Out Header: SPDIF

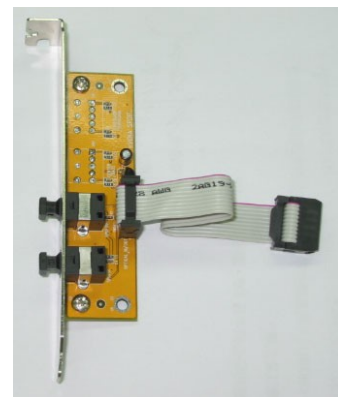
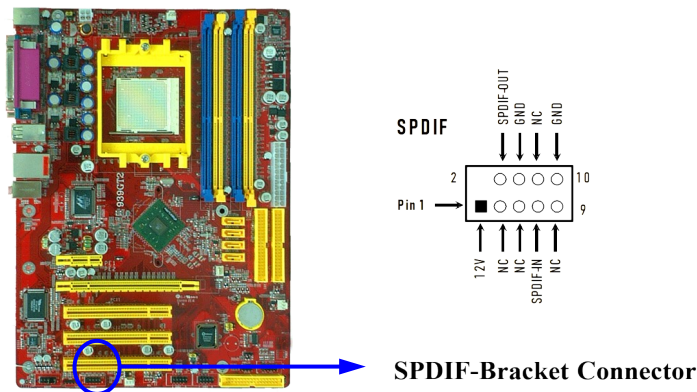

2-7 Starting Up Your Computer

1. Make sure that all connections are connected firmly, close your computer chassis cover.
2. Be sure all the switch are off, and check that the power supply input voltage is set to proper position, usually in-put voltage is 220V~240V or 110V~120V depending on your country's voltage used.
3. Connect the power supply cord into the power supply located on the back of your system case according to your system user's manual.
4. Turn on your peripheral as following order:
 - a. Your monitor.
 - b. Other external peripheral (Printer, Scanner, External Modem etc...)
 - c. Your system power. For ATX power supplies, you need to turn on the power supply and press the ATX power switch on the front side of the case.
5. The power LED on the front panel of the system case will light. The LED on the monitor may light up or switch between orange and green after the system is on. If it complies with green standards or if it is has a power standby feature. The system will then run power-on test. While the test are running, the BIOS will alarm beeps or additional message will appear on the screen.

If you do not see any thing within 30 seconds from the time you turn on the power. The system may have failed on power-on test. Recheck your jumper settings and connections or call your retailer for assistance.

| Beep | Meaning |
|---------------------------------------------|-------------------------------------------------------|
| One short beep when displaying logo | No error during POST |
| Long beeps in an endless loop | No DRAM install or detected |
| One long beep followed by three short beeps | Video card not found or video card memory bad |
| High frequency beeps when system is working | CPU overheated System running at a lower frequency |

6. During power-on, press <Delete> key to enter BIOS setup. Follow the instructions in BIOS SETUP.
7. **Power off your computer:** You must first exit or shut down your operating system before switch off the power switch. For ATX power supply, you can press ATX power switching after exiting or shutting down your operating system. If you use Windows 9X, click “**Start**” button, click “**Shut down**” and then click “**Shut down the computer?**” The power supply should turn off after windows shut down.



Chapter 3

Introducing BIOS

The BIOS is a program located on a Flash Memory on the motherboard. This program is a bridge between motherboard and operating system. When you start the computer, the BIOS program gain control. The BIOS first operates an auto-diagnostic test called POST (power on self test) for all the necessary hardware, it detects the entire hardware device and configures the parameters of the hardware synchronization. Only when these tasks are completed done it gives up control of the computer to operating system (OS). Since the BIOS is the only channel for hardware and software to communicate, it is the key factor for system stability, and in ensuring that your system performance as its best.

In the BIOS Setup main menu of Figure 3-1, you can see several options. We will explain these options step by step in the following pages of this chapter, but let us first see a short description of the function keys you may use here:

- Press <Esc> to quit the BIOS Setup.
- Press ↑↓←→ (up, down, left, right) to choose, in the main menu, the option you want to confirm or to modify.
- Press <F10> when you have completed the setup of BIOS parameters to save these parameters and to exit the BIOS Setup menu.
- Press Page Up/Page Down or +/- keys when you want to modify the BIOS parameters for the active option.

3-1 Entering Setup

Power on the computer and by pressing immediately allows you to enter Setup.

If the message disappears before your respond and you still wish to enter Setup, restart the system to try again by turning it OFF then ON or pressing the “RESET” button on the system case. You may also restart by simultaneously pressing <Ctrl>, <Alt> and <Delete> keys. If you do not press the keys at the correct time and the system does not boot, an error message will be displayed and you will again be asked to

Press <F1> to continue, <Ctrl-Alt-Esc> or to enter Setup

3-2 Getting Help

Main Menu

The on-line description of the highlighted setup function is displayed at the bottom of the screen.

Status Page Setup Menu/Option Page Setup Menu

Press F1 to pop up a small help window that describes the appropriate keys to use and the possible selections for the highlighted item. To exit the Help Window, press <Esc>.

3-3 The Main Menu

Once you enter Award → BIOS CMOS Setup Utility, the Main Menu (Figure 3-1) will appear on the screen. The Main Menu allows you to select from fourteen setup functions and two exit choices. Use arrow keys to select among the items and press <Enter> to accept or enter the sub-menu.

Phoenix - AwardBIOS CMOS Setup Utility

| | |
|----------------------------------------------------------------------------------------------------------------------------------------------------------------------------------------------------------------------|----------------------------------------------------------------------------------------------------------------------------------------------------------------------------------------------------------------------|
| <p>Standard CMOS Features</p> <p>Advanced BIOS Features</p> <p>Advanced Chipset Features</p> <p>Integrated Peripherals</p> <p>Power Management Setup</p> <p>Miscellaneous Control</p> <p>PC Health Status</p> | <p>Thermal Throttling Options</p> <p>Power User Overclock Settings</p> <p>Password Settings</p> <p>Load Optimized Defaults</p> <p>Load Standard Defaults</p> <p>Save & Exit Setup</p> <p>Exit Without Saving</p> |
| <p>Esc : Quit F9 : Menu in BIOS ↑↓→← : Select Item</p> <p>F10 : Save & Exit Setup</p> | |
| | |

Figure 3-1

Standard CMOS Features

Use this Menu for basic system configurations.

Advanced BIOS Features

Use this menu to set the Advanced Features available on your system.

Advanced Chipset Features

Use this menu to change the values in the chipset registers and optimize your system’s performance.

Integrated Peripherals

Use this menu to specify your settings for integrated peripherals.

Power Management Setup

Use this menu to specify your settings for power management.

Miscellaneous Control

Use this menu to specify your settings for Miscellaneous control.

PC Health Status

This entry shows your PC health status.

Thermal Throttling Options

The selection is set for activating the active CPU Thermal Protection by flexible CPU loading adjustment in the arrange of temperature you define.

Power User Overclock Settings

Use this menu to specify your settings (frequency, Voltage) for overclocking demand

Password Settings

This entry for setting Supervisor password and User password

Load Optimized Defaults

Use this menu to load the BIOS default values these are setting for optimal performances system operations for performance use.

Load Standard Defaults

Use this menu to load the BIOS default values for the stable performance system operation that are factory settings for normal use.

Save & Exit Setup

Save CMOS value changes to CMOS and exit setup.

Exit Without Saving

Abandon all CMOS value changes and exit setup.

3-4 Standard CMOS Features

The items in Standard CMOS Setup Menu are divided into several categories. Each category includes no, one or more than one setup items. Use the arrow keys to highlight the item and then use the <PgUp> or <PgDn> keys to select the value you want in each item.

Phoenix - AwardBIOS CMOS Setup Utility
Standard CMOS Features

| | | |
|-------------------------------------------------------------------------------------------------------------------------------------------|-------------------|-------------------------------------------------------------|
| Date (mm:dd:yy) | Wed, Mar, 09 2005 | Item Help |
| Time (hh:mm:ss) | 16 : 48 : 35 | |
| > IDE Channel 0 Master | None | Menu Level > Change the day, month, year and century |
| > IDE Channel 0 Slave | None | |
| > IDE Channel 1 Master | None | |
| > IDE Channel 1 Slave | None | |
| > SATA Channel 1 | None | |
| > SATA Channel 2 | None | |
| > SATA Channel 3 | None | |
| > SATA Channel 4 | None | |
| Drive A | 1.44M, 3.5 in. | |
| Drive B | None | |
| Halt On | All, But Keyboard | |
| Base Memory | 640K | |
| Extended Memory | 522240K | |
| Total Memory | 523264K | |
| ↑↓←→ Move Enter:Select +/-/PU/PD:Value F10:Save ESC:Exit F1:General Help F5:Previous Values F6:Optimized Defaults F7:Standard Defaults | | |

Date

The date format is <day><month><date><year>.

Day Day of the week, from Sun to Sat, determined by BIOS. Read-only.

Month The month from Jan. through Dec.

Date The date from 1 to 31 can be keyed by numeric function keys.

Year The year depends on the year of the BIOS.

Time

The time format is <hour><minute><second>.

**IDE Channel 0 Master / Channel 0 Slave / Channel 1 Master / Channel 0 Slave
SATA Channel 1, 2, 3, 4**

Press PgUp/<+> or PgDn/<-> to select Manual, None, Auto type. Note that the specifications of your drive must match with the drive table. The hard disk will not work properly if you enter improper information for this category. If the type of hard disk drives is not matched or listed, you can use Manual to define your own drive type manually.

If you select Manual, related information is asked to be entered to the following items. Enter the information directly from the keyboard. This information should be provided in the documentation from your hard disk vendor or the system manufacturer.

If the controller of HDD interface is SCSI, the selection shall be "None".

If the controller of HDD interface is CD-ROM, the selection shall be "None"

Access Mode The settings are Auto Normal, Large, and LBA.

Cylinder number of cylinders

Head number of heads

Precomp write precomp

Landing Zone landing zone

Sector number of sectors

3-5 Advanced BIOS Features

Phoenix - AwardBIOS CMOS Setup Utility

Advanced BIOS Features

| | | Item Help |
|-------------------------------------------------------------------------------------------------------------------------------------------|-------------|--------------|
| Removable Device Priority | Press Enter | |
| Hard Disk Boot Priority | Press Enter | |
| Virus Warning | Disabled | |
| L1 Cache | Enabled | |
| L2 Cache | Enabled | Menu Level > |
| Quick Power On Self Test | Enabled | |
| SATA &SCSI Boot Order | SATA, SCSI | |
| First Boot Device | Floppy | |
| Second Boot Device | HDD-0 | |
| Third Boot Device | CDROM | |
| Boot other Device | Enabled | |
| Swap Floppy Drive | Disabled | |
| Boot Up Floppy Seek | Enabled | |
| Boot Up NumLock Status | On | |
| Typematic Rate Setting | Disabled | |
| Typematic Rate (Chars/Sec) | 6 | |
| Typematic Delay (Msec) | 250 | |
| Security Option | Setup | |
| APIC Mode | Enabled | |
| MPS Version Control For OS | 1.4 | |
| OS Select For DRAM > 64MB | Non-OS2 | |
| HDD S.M.A.R.T. Capability | Disabled | |
| Report No FDD For Windows | Yes | |
| Small Logo (EPA) Show | Enabled | |
| ↑↓→← Move Enter:Select +/-/PU/PD:Value F10:Save ESC:Exit F1:General Help F5:Previous Values F6:Optimized Defaults F7:Standard Defaults | | |

Removable Device Priority

The selection is for you to choose the removable devices (Such as USB floppy or other related accessories) priorities to boot from.

Hard Disk Boot Priority

The selection is for you to choose the hard disk drives priorities to boot from.

Virus Warning

Allows you to choose the VIRUS Warning feature for IDE Hard Disk boot sector protection. If this function is enabled and someone attempt to write data into this area, BIOS will show a warning message on screen and alarm beep.

Disabled (default) No warning message to appear when anything attempts to access the boot sector or hard disk partition table.

Enabled Activates automatically when the system boots up causing a warning message to appear when anything attempts to access the boot sector of hard disk partition table.

CPU Internal Cache

The default value is Enabled.

Enabled (default) Enable cache

Disabled Disable cache

Note: The internal cache is built in the processor.

External Cache

Choose Enabled or Disabled. This option enables the Level 2 cache memory.

Quick Power On Self-Test

This category speeds up Power On Self Test (POST) after you power on the computer. If this is set to Enabled. BIOS will shorten or skip some check items during POST.

Enabled (default) Enable quick POST

Disabled Normal POST

First/Second/Third/Fourth Boot Device

The BIOS attempts to load the operating system from the devices in the sequence selected in these items. The settings are Floppy, LS/ZIP, HDD-0/HDD-1/HDD-3, SCSI, CDROM, LAD and Disabled.

Swap Floppy Drive

Switches the floppy disk drives between being designated as A and B. Default is Disabled.

Boot Up Floppy Seek

During POST, BIOS will determine if the floppy disk drive installed is 40 or 80 tracks. 360K type is 40 tracks while 760K, 1.2M and 1.44M are all 80 tracks.

Boot Up NumLock Status

The default value is On.

On (default) Keypad is numeric keys.

Off Keypad is arrow keys.

Typematic Rate Setting

Keystrokes repeat at a rate determined by the keyboard controller. When enabled, the typematic rate and typematic delay can be selected. The settings are: Enabled/Disabled.

Typematic Rate (Chars/Sec)

Sets the number of times a second to repeat a keystroke when you hold the key down. The settings are: 6, 8, 10, 12, 15, 20, 24, and 30.

Typematic Delay (Msec)

Sets the delay time after the key is held down before it begins to repeat the keystroke. The settings are 250, 500, 750, and 1000.

Security Option

This category allows you to limit access to the system and Setup, or just to Setup.

- System** The system will not boot and access to Setup will be denied if the correct password is not entered at the prompt.
- Setup (default)** The system will boot, but access to Setup will be denied if the correct password is not entered prompt.

Small Logo (EPA) Show

The selection is for you to choose the EPA small logo to show or not.

3-6 Advanced Chipset Features

The Advanced Chipset Features Setup option is used to change the values of the chipset registers. These registers control most of the system options in the computer.

Phoenix - AwardBIOS CMOS Setup Utility
Advanced Chipset Features

| | |
|----------------------------------------------------------------------------------------------------------------------------------------------------------------------------------|-------------------------------|
| <pre> > Hyper Transport Frequency Auto > Hyper Transport Width Auto > DRAM Timing Settings Press Enter > System BIOS Cacheable Enabled </pre> | Item Help Menu Level > |
| <pre> ↑↓→← Move Enter:Select +/-/PU/PD:Value F10:Save ESC:Exit F1:General Help F5:Previous Values F6:Optimized Defaults F7:Standard Defaults </pre> | |

HperTransport Frequency

The default setting is “Auto” for this selection, and it provides with the frequency from 200 to 1000MHz for you to select manually. The AMD Athlon64 FX processor supports 1GHz HyperTransport bus to access. We recommend you to use the frequency for both performance and reliabilities of your system.

HperTransport Width

The default setting is “Auto” for this selection, and it provides with the adjustable bandwidth selection for you to choose the combination of stream with x16 and x8 bandwidth of upload and down between the processor and system chip.

DRAM Timing Settings

Please refer to section 3-6-1

System BIOS Cacheable

Selecting Enabled allows caching of the system BIOS ROM at F0000h-FFFFFh, resulting in better system performance. However, if any program writes to this memory area, a system error may result. The settings are: Enabled and Disabled.

3-6-1 DRAM Timing Settings

Phoenix - AwardBIOS CMOS Setup Utility

DRAM Timing Settings

| | | |
|-------------------------------------------------------------------------------------------------------------------------------------------|------------|---------------|
| Auto Configuartion | Auto | Item Help |
| DRAM CAS Latency | CL=2.5 | |
| SDRAM Active Time | 8T | |
| DRAM Bank Interleaving | Enabled | Menu Level >> |
| SDRAM RAS-to-CAS Delay | 4T | |
| SDRAM Precharge Time | 2T | |
| DRAM Command Rate | 2T | |
| MTRR Mapping Mode | Continuous | |
| ↑↓→← Move Enter:Select +/-/PU/PD:Value F10:Save ESC:Exit F1:General Help F5:Previous Values F6:Optimized Defaults F7:Standard Defaults | | |

SDRAM RAS-to-CAS Delay

This field let’s you insert a timing delay between the CAS and RAS strobe signals, used when DRAM is written to, read from, or refreshed. *Fast* gives faster performance; and *Slow* gives more stable performance. This field applies only when synchronous DRAM is installed in the system. The settings are: 4T and 3T.

SDRAM Precharge Time

If an insufficient number of cycles is allowed for the RAS to accumulate its charge before DRAM refresh, the refresh may be incomplete and the DRAM may fail to retain date. *Fast* gives faster performance; and *Slow* gives more stable performance. This field applies only when synchronous DRAM is installed in the system. The settings are: 2T and 3T.

DRAM CAS Latency

When synchronous DRAM is installed, the number of clock cycles of CAS latency depends on the DRAM timing. The settings are: 2T and 2.5T.

3-7 Integrated Peripherals

Phoenix - AwardBIOS CMOS Setup Utility
Integrated Peripherals

| | |
|----------------------------------------------------------------------------------------------------------------------------------------------------------------------------------------------------------------------------------------------------------------------------------|-----------------------------------------------|
| <p>> OnChip IDE Function Press Enter</p> <p>> OnChip Device Function Press Enter</p> <p>> OnChop Super IO Function Press Enter</p> <p> Init Display First PCI Slot</p> | <p>Item Help</p> <hr/> <p>Menu Level ></p> |
| <p>↑↓→← Move Enter:Select +/-/PU/PD:Value F10:Save ESC:Exit F1:General Help F5:Previous Values F6:Optimized Defaults F7:Standard Defaults</p> | |

OnChip IDE Function

Please refer to section 3-7-1

OnChip Device Function

Please refer to section 3-7-2

OnChip Super IO Function

Please refer to section 3-7-3

Init Display First

This item allows you to decide to activate whether PCI Slot or AGP VGA first. The settings are: PCI Slot, AGP Slot.

3-7-1 OnChip IDE Function

Phoenix - AwardBIOS CMOS Setup Utility
OnChip IDE Function

| | |
|--------------------------------------------------------------------------------------------------------------------------------------------------------------------------------------------------------------------------------------------------------------------------------------------------------------------------------------------------------------------------------------------------------------------------------------------------------------------------------------------------------------------------------------------------------------------------------------------------------------------------------------------------------------------------------------------------------------------------------------------------------------------------------------------------------------------------------------------------------------------------------------------------------------------------------------------------------------------------------------------------------------------------------------------|---------------------------------------------------|
| <p>RAID Configuration Enter</p> <p>OnChip IDE Channel0 Enabled</p> <p>Primary Master PIO Auto</p> <p>Primary Slave PIO Auto</p> <p>Primary Master UDMA Auto</p> <p>Primary Slave UDMA Auto</p> <p>OnChip IDE Channell Enabled</p> <p>Secondary Master UDMA Auto</p> <p>Secondary Slave UDMA Auto</p> <p>Secondary Master UDMA Auto</p> <p>Secondary Slave UDMA Auto</p> <p>SATA Channel 1&2 Auto</p> <p>SATA Channel 3&4 Auto</p> <p>IDE DMA Transfer Access Enabled</p> <p>IDE Prefactch Enabled</p> <p>IDE HDD Block Mode Enabled</p> <p>Delay For HDD (Secs) 0</p> | <p>Item Help</p> <hr/> <p>Menu Level >></p> |
| <p>↑↓→← Move Enter:Select +/-/PU/PD:Value F10:Save ESC:Exit F1:General Help F5:Previous Values F6:Optimized Defaults F7:Standard Defaults</p> | |

OnChip IDE Channal0/Channell

The integrated peripheral controller contains an IDE interface with support for two IDE channels. Select *Enabled* to activate each channel separately. The settings are: Enabled and Disabled.

Primary/Secondary Master/Slave PIO

The four IDE PIO (Programmed Input/Output) fields let you set a PIO mode (0-4) for each of the four IDE devices that the onboard IDE interface supports. Modes 0 through 4 provide successively increased performance. In Auto mode, the system automatically determines the best mode for each device. The settings are: Auto, Mode 0, Mode 1, Mode 2, Mode 3, Mode 4.

Primary/Secondary Master/Slave UDMA

Ultra DMA/33 implementation is possible only if your IDE hard drive supports it and the operating environment includes a DMA driver (Windows 95 OSR2 or a third-party IDE bus master driver). If your hard drive and your system software both support Ultra DMA/33 and Ultra DMA/66, select Auto to enable BIOS support. The settings are: Auto, Disabled.

IDE Prefetch

The selection is for you to set the IDE device as the first priority to activate.

IDE HDD Block Mode

Block mode is also called block transfer, multiple commands, or multiple sector read/write. If your IDE hard drive supports block mode (most new drives do), select Enabled for automatic detection of the optimal number of block read/writes per sector the drive can support. The settings are: Enabled, Disabled.

Delay for HDD (Secs)

The selection is set for you to extend the time to search for the HDD which needs more time to activate.

3-7-2 OnChip Device Function

Phoenix - AwardBIOS CMOS Setup Utility

OnChip Device Function

| | | |
|-------------------------------------------------------------------------------------------------------------------------------------------|-------------|---------------|
| On Board AC97 Audio Device | Auto | Item Help |
| On Board LAN BootROM | Auto | |
| On Board LAN Device BootROM | Disabled | Menu Level >> |
| On Board LAN BootROM | Disabled | |
| Machine MAC Address is 003018-xxxxxx | | |
| On Board MAC Address Input | Press Enter | |
| = = = = = USB Controller System = = = = = | | |
| On Chip USB | V1.1+ V1.2 | |
| USB Memory Type | Shadow | |
| USB Keyboard Support | Disabled | |
| USB Mouse Support | Disabled | |
| ↑↓←→ Move Enter:Select +/-/PU/PD:Value F10:Save ESC:Exit F1:General Help F5:Previous Values F6:Optimized Defaults F7:Standard Defaults | | |

AC97 Sound Device

This item allows you to decide to enable/disable the chipset family to support AC97 Audio. The settings are: Enabled, Disabled.

USB Host Controller

Select *Enabled* if your system contains a Universal Serial Bus (USB) controller and you have a USB peripherals. The settings are: Enabled, Disabled.

USB Keyboard Support

Select *Enabled* if your system contains a Universal Serial Bus (USB) controller and you have a USB keyboard. The settings are: Enabled, Disabled.

3-7-3 OnChip Super IO Function

Phoenix - AwardBIOS CMOS Setup Utility

Onboard Super IO Function

| | | |
|-------------------------------------------------------------------------------------------------------------------------------------------|----------|---------------|
| Onboard FDD Controller | Enabled | Item Help |
| Onboard Serial Port 1 | 3F8/IRQ4 | |
| Onboard Serial Port 2 | 2F8/IRQ3 | Menu Level >> |
| UART Mode Select | Normal | |
| IR Duplex Mode | Half | |
| Onboard Parallel Port | 378/IRQ7 | |
| Parallel Mode | SPP | |
| ECP Mode Use DMA | 3 | |
| ↑↓→← Move Enter:Select +/-/PU/PD:Value F10:Save ESC:Exit F1:General Help F5:Previous Values F6:Optimized Defaults F7:Standard Defaults | | |

Onboard FDD Controller

Select Enabled if your system has a floppy disk controller (FDD) installed on the system board and you wish to use it. If you install add-on FDC or the system has no floppy drive, select Disabled in this field. The settings are: Enabled and Disabled.

Onboard Serial Port 1/Port 2

Select an address and corresponding interrupt for the first and the second serial ports. The settings are: 3F8/IRQ4, 2E8/IRQ3, 3E8/IRQ4, 2F8/IRQ3, Disabled, Auto.

Onboard Parallel Port

There is a built-in parallel port on the on-board Super I/O chipset that Provides Standard, ECP, and EPP features. It has the following option:

Disabled

- (3BCH/IRQ7)/ Line Printer port 0
- (278H/IRQ5)/ Line Printer port 2
- (378H/IRQ7) Line Printer port 1

Parallel Port Mode

- SPP : Standard Parallel Port
- EPP : Enhanced Parallel Port
- ECP : Extended Capability Port

SPP/EPP/ECP/ECP+EPP

To operate the onboard parallel port as Standard Parallel Port only, choose “SPP.” To operate the onboard parallel port in the EPP modes simultaneously, choose “EPP.” By choosing “ECP”, the onboard parallel port will operate in ECP mode only. Choosing “ECP+EPP” will allow the onboard parallel port to support both the ECP and EPP modes simultaneously. The ECP mode has to use the DMA channel, so choose the onboard parallel port with the ECP feature. After selecting it, the following message will appear: “ECP Mode Use DMA” at this time, the user can choose between DMA channels 3 to 1. The onboard parallel port is EPP Spec. compliant, so after the user chooses the onboard parallel port with the EPP function, the following message will be displayed on the screen: “EPP Mode Select.” At this time either EPP 1.7 spec. or EPP 1.9 spec. can be chosen.

3-8 Power Management Setup

The Power Management Setup allows you to configure your system to most effectively save energy saving while operating in a manner consistent with your own style of computer use.

Phoenix - AwardBIOS CMOS Setup Utility
Power Management Setup

| | |
|------------------------------------------------------------------------------------------------------------------------------------------------------------------------------------------------------------------------------------------------------------------------------------------------------------------------------------------------------------------------------------------------------------------------------------------------------------------------------------------|-------------------------------|
| PS2 KB/MS Wake up by (S3/S4/S5) Disabled ACPI Function Enabled ACPI Suspend Type S1(POS) Power Management User Define Video off Method DPMS Support HDDD Power Down Disabled Power Button Function Instant-Off Power After Power Failure Always Off Wake Up on PCI PME Disabled Wake-Up on Ring Disabled Wake-Up by Alarm Disabled AMD K8 Cool'n'Quiet Control Auto | Item Help Menu Level > |
| ↑↓→← Move Enter:Select +/-/PU/PD:Value F10:Save ESC:Exit F1:General Help F5:Previous Values F6:Optimized Defaults F7:Standard Defaults | |

ACPI Function

This item allows you to Enabled/Disabled the Advanced Configuration and Power Management (ACPI). The settings are Enabled and Disabled.

Video Off Option

This determines the manner in which the monitor is blanked. The choice are Suspend → off, All Modes → Off, and Always On.

Video Off Method

This determines the manner in which the monitor is blanked.

- DPMS (default)** Initial display power management signaling.
- Blank Screen** This option only writes blanks to the video buffer.
- V/H SYNC+Blank** This selection will cause the system to turn off the vertical and horizontal synchronization ports and write blanks to the video buffer.

Modem Use IRQ

This determines the IRQ in which the MODEM can use.
 The settings are: 3, 4, 5, 7, 9, 10, 11, NA.

Power Button Function

Pressing the power button for more than 4 seconds forces the system to enter the Soft-Off state.

The settings are: Delay 4 Sec, Instant-Off.

Wake Up On Ring/PME

During Disabled, the system will ignore any incoming call from the modem. During Enabled, the system will boot up if there's an incoming call from the modem.

Wake-Up by Alarm

This function is for setting date and time for your computer to boot up. During Disabled, you cannot use this function. During Enabled, choose the Date and Time Alarm:

Date(of month) Alarm

You can choose which month the system will boot up. Set to 0, to boot every day.

Time(hh:mm:ss) Alarm

You can choose what hour, minute and second the system will boot up.

Note: If you have change the setting, you must let the system boot up until it goes to the operating system, before this function will work.

3-9 Miscellaneous Control

This section is for setting CPU Frequency/Voltage Control.

Phoenix - AwardBIOS CMOS Setup Utility
Miscellaneous Control

| | |
|------------------------------------------------------------------------------------------------------------------------------------------------------------------------------------------------------------------------------------------------------------------------------------------------------------------------------------------------------------------------------------------------------------------------------------------------------------------------------------|-----------------------------------------------|
| <p>CPU Spread Spectrum Clock Enabled</p> <p>SATA Spread Spectrum Disabled</p> <p>PCIE Spread Spectrum Disabled</p> <p>Flash Part Write Protect Enabled</p> <p>> IRQ Resources Press Enter</p> <p>PCI/VGA Palette Snoop Disabled</p> <p>*** PCIExpress Relative Items ***</p> <p>Maximum Payload Size 4096</p> | <p>Item Help</p> <hr/> <p>Menu Level ></p> |
| <p>↑↓→← Move Enter:Select +/-/PU/PD:Value F10:Save ESC:Exit F1:General Help F5:Previous Values F6:Optimized Defaults F7:Standard Defaults</p> | |

Auto Detect PCI Clock

This item allows you to enable/disable auto detect PCI Clock.

Spread Spectrum

This item allows you to set the CPU Host / SATA / PCI clock and Spread Spectrum. The settings are: Enabled, Disabled.

IRQ Resources

When resources are controlled manually, assign each system interrupt a type, depending on the type of device using the interrupt.

Please refer to section 3-9-1

3-9-1 IRQ Resources

Phoenix - AwardBIOS CMOS Setup Utility
IRQ Resources

| | | |
|-------------------------------------------------------------------------------------------------------------------------------------------|------------|-----------|
| IRQ-3 assigned to | PCI Device | Item Help |
| IRQ-4 assigned to | PCI Device | |
| IRQ-5 assigned to | PCI Device | |
| IRQ-7 assigned to | PCI Device | |
| IRQ-9 assigned to | PCI Device | |
| IRQ-10 assigned to | PCI Device | |
| IRQ-11 assigned to | PCI Device | |
| IRQ-12 assigned to | PCI Device | |
| IRQ-14 assigned to | PCI Device | |
| IRQ-15 assigned to | PCI Device | |
| ↑↓→← Move Enter:Select +/-/PU/PD:Value F10:Save ESC:Exit F1:General Help F5:Previous Values F6:Optimized Defaults F7:Standard Defaults | | |

3-10 PC Health Status

This section shows the Status of you CPU, Fan, Warning for overall system status. This is only available if there is Hardware Monitor onboard.

Phoenix - AwardBIOS CMOS Setup Utility

PC Health Status

| | | |
|-------------------------------------------------------------------------------------------------------------------------------------------|-------------|-----------|
| Shutdown Temperature | Disabled | Item Help |
| Show PCHHealth in Post | Enabled | |
| > Smart FAN Configurations | Press Enter | |
| Vcore | 1.39V | |
| NB | 2.53V | |
| +5V | 4.99V | |
| +12V | 11.9V | |
| 5VSB | 4.89V | |
| VDIMM | 2.67V | |
| VBAT | 3.12V | |
| CPU Temperature | 40°C/104°F | |
| System 1 Temperature | 36°C/96°F | |
| System 1 Temperature | 29°C/84°F | |
| CPUFAN | 4440 RPM | |
| SFAN1 | 3375 RPM | |
| SFAN2 | 3375 RPM | |
| ↑↓→← Move Enter:Select +/-/PU/PD:Value F10:Save ESC:Exit F1:General Help F5:Previous Values F6:Optimized Defaults F7:Standard Defaults | | |

Shutdown Temperature

This item can let users setting the Shutdown temperature, when CPU temperature over this setting the system will auto shutdown to protect CPU.

Show PC Health in Post

During Enabled, it displays information list below. The choice is either Enabled or Disabled

Smart FAN Configurations

Please refer to section 3-10-1

Current CPU Temperature/Current System Temp/Current FAN1, FAN2 Speed/Vcore/Vdd/3.3V/+5V/+12V/-12V/VBAT(V)/5VSB(V)

This will show the CPU/FAN/System voltage chart and FAN Speed.

3-10-1 Smart FAN Configurations

Phoenix - AwardBIOS CMOS Setup Utility
Smart FAN Configurations

| | |
|-----------------------------------------------------------------------------------------------------------------------------------------------------------------------------------------------------------------------------------------------------------------------------------------------------------------------------------------------|-------------------------------|
| CPUFAN Smart Mode Enabled CPU SmartFAN Full-Speed 50 CPU SmartFAN Idle Temp 30 SFAN1 Smart Mode Enabled SFAN1 SmartFAN Full-Speed Temp 50 SFAN1 SmartFAN Idle Temp 30 SFAN2 Smart Mode Enabled SFAN2 SmartFAN Full-Speed Temp 50 SFAN2 SmartFAN Idle Temp 30 | Item Help Menu Level > |
| ↑↓→← Move Enter:Select +/-/PU/PD:Value F10:Save ESC:Exit F1:General Help F5:Previous Values F6:Optimized Defaults F7:Standard Defaults | |

CPU/SFAN1/SFAN2 Smart FAN Full-Speed Temp

This item allows you setting the FAN works in full speed when the temperature over the value which out set. If the temperature below the value but over the Idle Temperature, the FAN will works over 60% of full speed, and the higher temperature will gain higher FAN speed, after over the temperature which this item setting, the FAN works in full speed.

CPU/SFAN1/SFAN2 Smart FAN Idle Temp

This item allows you setting the FAN works in 60% of full speed, when the temperature lower than the temperature which you setting.

3-11 Thermal Throttling Options

Phoenix - AwardBIOS CMOS Setup Utility
Thermal Throttling Options

| | |
|-------------------------------------------------------------------------------------------------------------------------------------------|-------------------------------|
| CPU Thermal-Throttling Disabled CPU Thermal-Throttling CPU Thermal-Throttling CPU Thermal-Throttling | Item Help Menu Level > |
| ↑↓→← Move Enter:Select +/-/PU/PD:Value F10:Save ESC:Exit F1:General Help F5:Previous Values F6:Optimized Defaults F7:Standard Defaults | |

Phoenix - AwardBIOS CMOS Setup Utility
Thermal Throttling Options

| | |
|-------------------------------------------------------------------------------------------------------------------------------------------|-----------|
| CPU Thermal-Throttling Disabled CPU Thermal-Throttling | Item Help |
| ↑↓→← Move Enter:Select +/-/PU/PD:Value F10:Save ESC:Exit F1:General Help F5:Previous Values F6:Optimized Defaults F7:Standard Defaults | |

| | | |
|-------------------------------------------------------------------------------------------------------------------------------------------|---------|--------------|
| CPU Thermal-Throttling Duty | 50.00% | Menu Level > |
| CPU Thermal-Throttling Beep | Enabled | |
| ↑↓→← Move Enter:Select +/-/PU/PD:Value F10:Save ESC:Exit F1:General Help F5:Previous Values F6:Optimized Defaults F7:Standard Defaults | | |

Phoenix - AwardBIOS CMOS Setup Utility
Thermal Throttling Options

| | | |
|-------------------------------------------------------------------------------------------------------------------------------------------|------------------------------------|-----------|
| CPU Thermal-Throttling | Disabled | Item Help |
| CPU Thermal-Throttling | CPU Thermal-Throttling Duty | Level > |
| CPU Thermal-Throttling | 87.50% [] | |
| CPU Thermal-Throttling | 75.00% [] | |
| CPU Thermal-Throttling | 62.50% [] | |
| | 50.00% [] | |
| | 35.50% [] | |
| | 25.00% [] | |
| | 12.50% [] | |
| ↑↓:Move ENTER:Accept ESC:Abort | | |
| ↑↓→← Move Enter:Select +/-/PU/PD:Value F10:Save ESC:Exit F1:General Help F5:Previous Values F6:Optimized Defaults F7:Standard Defaults | | |

CPU Thermal Throttling Temp

This item allows you to activate the CPU Thermal Throttling function when the CPU temperature is over the value which you set to low down the CPU temperature when at high workload to protect processor from damage or accidental shutdown.

Phoenix - AwardBIOS CMOS Setup Utility
Thermal Throttling Options

| | | |
|-------------------------------------------------------------------------------------------------------------------------------------------|------------------------------------|--------------|
| CPU Thermal-Throttling | Disabled | Item Help |
| CPU Thermal-Throttling | CPU Thermal-Throttling Beep | Menu Level > |
| CPU Thermal-Throttling | Disabled [] | |
| CPU Thermal-Throttling | Enabled [] | |
| ↑↓:Move ENTER:Accept ESC:Abort | | |
| ↑↓→← Move Enter:Select +/-/PU/PD:Value F10:Save ESC:Exit F1:General Help F5:Previous Values F6:Optimized Defaults F7:Standard Defaults | | |

3-12 Power User Overclock Settings

Phoenix - AwardBIOS CMOS Setup Utility
Power User Overclock Settings

| | | |
|------------------------------------------------------------------------------------------------------------------------------------------|------------------|-------------------------------------|
| PCIE Clock | 100 | Item Help |
| ** Current Host Frequency is | 200MHZ ** | |
| CPU Clock at Next Boot is | 200 | Menu Level > |
| *** Current DRAM Clock | 200MHZ *** | |
| DRAM Clock at Next Boot | 200MHz (Auto) | } Not support AMD Sempron Processor |
| CPU Ratio Select | Default | |
| CPU Vcore Select | Default | |
| CPU Vcore 7-Shift | Normal (Default) | |
| Over Voltage | Enabled | |
| VRAM Output | 2.65V (Default) | |
| NB Voltage | 1.50V (Default) | |
| LDT Voltage | 1.25V (Default) | |
| ↑↓← Move Enter:Select +/-/PU/PD:Value F10:Save ESC:Exit F1:General Help F5:Previous Values F6:Optimized Defaults F7:Standard Defaults | | |

CPU/DRAM Clock at next Boot is

This item allows you change the CPU Host /DRAM clock for overclock demand. *When the CPU Host clock is over the CPU default value BIOS will auto disabled Bi-Turbo function.*

CPU Vcore 7-Shift

This item allows you select the CPU Vcore Voltage xx% more than the standard value, by this function for the precise over-clocking for extra demanding of performance.

VRAM Output

This item allows you to select 2.5V of the DDR Module. The choice are: 2.55V, 2.6V, 2.65V, 2.7V.

NB Voltage

This item allows you to select value of Voltage for North Bridge Chipset.

LDT Voltage

This item allows you to select value of Voltage for LDT.

Phoenix - AwardBIOS CMOS Setup Utility

Power User Overclock Settings

| | | |
|------------------------------------------------------------------------------------------------------------------------------------------|-----------------|-------------------------------------|
| PCIE Clock | 100 | Item Help |
| ** Current CPU Clock | | |
| CPU Clock at Next Boot | | Menu Level > |
| *** Current DRAM Clock | | |
| DRAM Clock at Next Boot | | } Not support AMD Sempron Processor |
| CPU Ratio Select | | |
| CPU Vcore Select | | |
| CPU Vcore 7-Shift | | |
| Over Voltage | | |
| VRAM Output | 2.50V (Default) | |
| NB Voltage | 1.50V (Default) | |
| LDT Voltage | 1.25V (Default) | |
| ↑↓← Move Enter:Select +/-/PU/PD:Value F10:Save ESC:Exit F1:General Help F5:Previous Values F6:Optimized Defaults F7:Standard Defaults | | |

Phoenix - AwardBIOS CMOS Setup Utility

Power User Overclock Settings

| | | |
|------------|--------------------------------|-----------|
| PCIE Clock | CPU Vcore 7-Shift | Item Help |
| | Normal [] | |
| | + 5% [] | |
| | + 10% [] | |
| | + 15% [] | |
| | + 20% [] | |
| | + 25% [] | |
| | + 30% [] | |
| | + 35% [] | |
| | ↑↓:Move ENTER:Accept ESC:Abort | |

| | | | |
|-------------------------------------------------------------------------------------------------------------------------------------------|----------------|--------------|--|
| ** Current CPU Clock | 200MHZ ** | Menu Level > | |
| CPU Clock at Next Boot is | 100 | | |
| *** Current DRAM Clock | 200MHZ *** | | |
| DRAM Clock at Next Boot | 200MHz (Auto) | | |
| CPU Ratio Select | Default | | |
| CPU Vcore Select | Default | | |
| CPU Vcore 7-Shift | Normal | | |
| Over Voltage | Enabled | | |
| VRAM Output | 2.50V(Default) | | |
| NB Voltage | 1.50V(Default) | | |
| LDT Voltage | 1.25V(Default) | | |
| ↑↓→← Move Enter:Select +/-/PU/PD:Value F10:Save ESC:Exit F1:General Help F5:Previous Values F6:Optimized Defaults F7:Standard Defaults | | | |

Phoenix - AwardBIOS CMOS Setup Utility

Power User Overclock Settings

| | | | |
|-------------------------------------------------------------------------------------------------------------------------------------------|-------------------------|-----------|--|
| PCIE Clock | 100 | Item Help | |
| ** Current CPU Clock | VRAM Output | Level > | |
| CPU Clock at Next Boot is | 2.55V(Default)..... [] | | |
| *** Current DRAM Clock | 2.65V [] | | |
| DRAM Clock at Next Boot | 2.75V [] | | |
| CPU Ratio Select | 2.85V [] | | |
| CPU Vcore Select | 3.05V [] | | |
| CPU Vcore 7-Shift | 3.25V [] | | |
| Over Voltage | | | |
| VRAM Output | | | |
| NB Voltage | | | |
| LDT Voltage | 1.25V(Default) | | |
| ↑↓→← Move Enter:Select +/-/PU/PD:Value F10:Save ESC:Exit F1:General Help F5:Previous Values F6:Optimized Defaults F7:Standard Defaults | | | |

Phoenix - AwardBIOS CMOS Setup Utility

Power User Overclock Settings

| | | | |
|-------------------------------------------------------------------------------------------------------------------------------------------|-------------------------|-----------|--|
| PCIE Clock | 100 | Item Help | |
| ** Current CPU Clock | NB Voltage | Level > | |
| CPU Clock at Next Boot is | 1.50V [] | | |
| *** Current DRAM Clock | 1.60V(Default)..... [] | | |
| DRAM Clock at Next Boot | 1.70V [] | | |
| CPU Ratio Select | | | |
| CPU Vcore Select | | | |
| CPU Vcore 7-Shift | | | |
| Over Voltage | | | |
| VRAM Output | | | |
| NB Voltage | 1.50V(Default) | | |
| LDT Voltage | 1.25V(Default) | | |
| ↑↓→← Move Enter:Select +/-/PU/PD:Value F10:Save ESC:Exit F1:General Help F5:Previous Values F6:Optimized Defaults F7:Standard Defaults | | | |

3-13 Password Settings

Phoenix - AwardBIOS CMOS Setup Utility

Password Settings

| | | |
|-------------------------------------------------------------------------------------------------------------------------------------------|----------------------------|-------------------------------|
| Set Supervisor Password Set User Password | Press Enter Press Enter | Item Help Menu Level > |
| ↑↓→← Move Enter:Select +/-/PU/PD:Value F10:Save ESC:Exit F1:General Help F5:Previous Values F6:Optimized Defaults F7:Standard Defaults | | |

You can set either supervisor or user password, or both of them. The differences are:

Supervisor password: Can enter and change the options of the setup menus.

User password: Can only enter but do not have the right to change the options of the setup menus. When you select this function, the following message will appear at the center of the screen to assist you in creating a password.

ENTER PASSWORD:

Type the password, up to eight characters in length, and press <Enter>. The password typed now will clear any previously entered password from CMOS memory. You will be asked to confirm the password. Type the password again and press <Enter>. You may also press <Esc> to abort the selection and not enter a password.

To disable a password, just press <Enter> when you are prompted to enter the password. A message will confirm that the password will be disabled. Once the password is disabled, the system will boot and you can enter Setup freely.

PASSWORD DISABLED.

When a password has been enabled, you will be prompted to enter it every time you try to enter Setup. This prevents an unauthorized person from changing any part of your system configuration.

Additionally, when a password is enabled, you can also require the BIOS to request a password every time your system is rebooted. This would prevent unauthorized use of your computer.

You determine when the password is required within the BIOS Features Setup Menu and its Security option. If the Security option is set to “System”, the password will be required both at boot and at entry to Setup. If set to “Setup”, prompting only occurs when trying to enter Setup.

3-14 Load Standard/Optimized Defaults

Load Standard Defaults

When you press <Enter> on this item, you get confirmation dialog box with a message similar to:

Load Standard Defaults (Y/N)? N

Pressing <Y> loads the BIOS default values for the most stable, minimal-performance system operations.

Load Optimized Defaults

When you press <Enter> on this item, you get a confirmation dialog box with a message similar to:

Load Optimized Defaults (Y/N)? N

Pressing <Y> loads the default values that are factory settings for optimal performance system operations.



Chapter 4

DRIVER & FREE PROGRAM INSTALLATION

Check your package and there is A MAGIC INSTALL CD included. This CD consists of all DRIVERS you need and some free application programs and utility programs. In addition, this CD also include an auto detect software which can tell you which hardware is installed, and which DRIVERS needed so that your system can function properly. We call this auto detect software MAGIC INSTALL.

MAGIC INSTALL supports WINDOWS 9X/NT/2K/XP

Insert CD into your CD-ROM drive and the MAGIC INSTALL Menu should appear as below. If the menu does not appear, double-click MY COMPUTER / double-click CD-ROM drive or click START / click RUN / type X:\SETUP.EXE (assuming X is your CD-ROM drive).



From MAGIC INSTALL MENU you may take 9 selections:

1. nFORCE install nFORCE integrated driver
2. SOUND install ALC655 AC97' Codec Audio driver
3. USB2.0 install USB 2.0 driver
4. LAN install LAN driver
5. DirectX9 install Microsoft DirectX 9 driver
6. PC-CILLIN install PC-CILLIN2005 anti-virus program
7. PC-HEALTH install My Guard PC-Health utility
8. BROWSE CD to browse the contents of the CD
9. EXIT to exit from MAGIC INSTALL menu

4-1 nForce Install nForce Integrated Driver

* nForce Integrated driver pack include following device driver:

NVIDIA GART driver : If you are using an AGP VGA Card, please install NVIDIA AGP GART driver which provides service routines to your VGA driver and interface directly to the hardware for speedy graphic access.

NVIDIA SMBUS driver : Install NVIDIA SMBUS driver

NVIDIA ETHERNET driver : Install NVIDIA 10/100 Fast Ethernet device driver.
Install NVIDIA firewall and Forceware Network Access Manager utility.

NVIDIA IDE driver : Install NVIDIA IDE driver

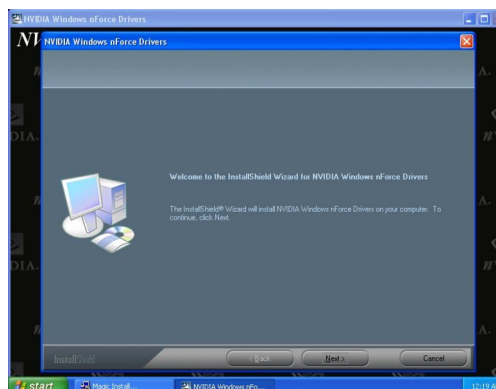

1. Click nForce in the MAGIC INSTALL MENU
2. Click NEXT when nForce Integrated driver Install windows appears

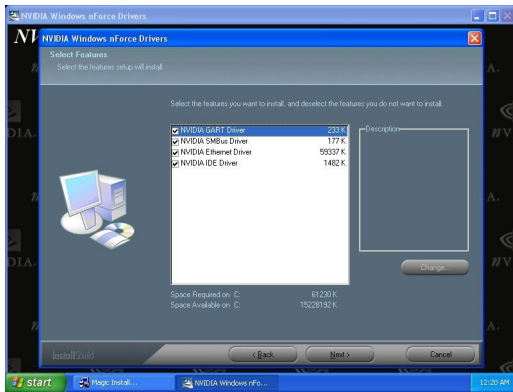

3. Please select the features you wish to install .

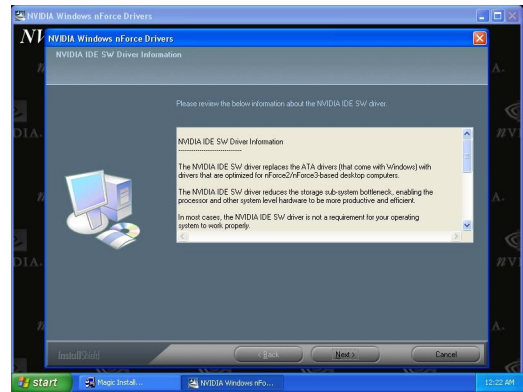

4. Click NEXT to install IDE driver and click "Yes" to proceed while system asking "Do you want to install the NVIDIA IDE SW Driver?"

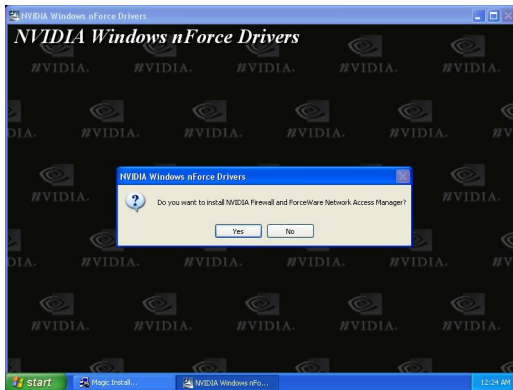

5. Please choose to install the NVIDIA firewall and Forceware Network Access Manager Utility Driver for demanding on you own.

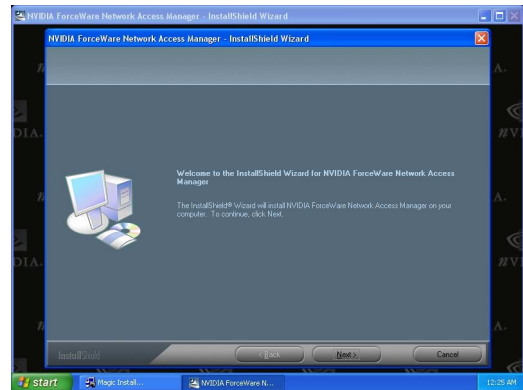

6. If you want to install NVIDIA firewall and Forceware Network Access Manager utility

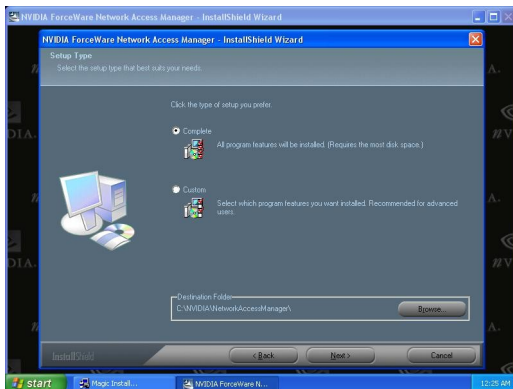

7. Select install complete software and Click NEXT

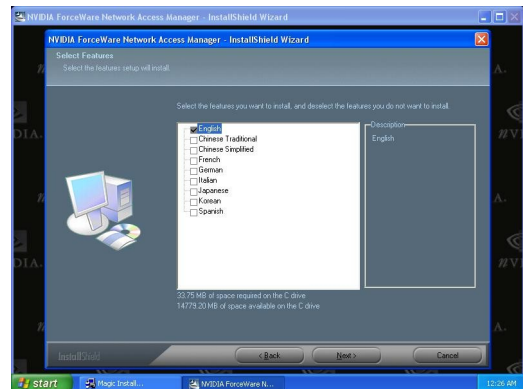

8. Select interface language and Click NEXT

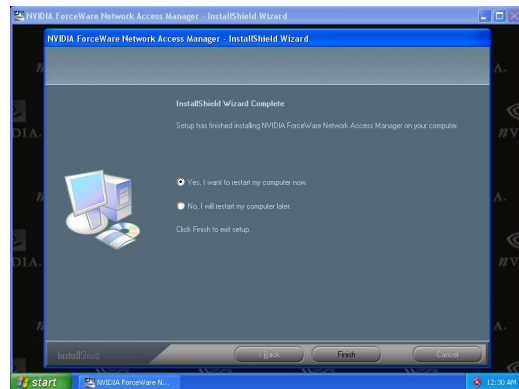
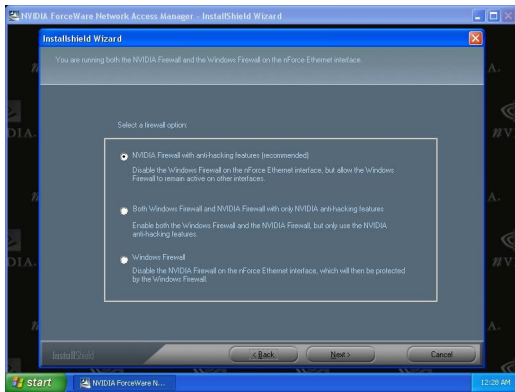

9. Please choose NVIDIA or Windows firewall 10. Select Finish and restart your computer for your system.

* The path of the file is X:\NFORCE4\DRIVER\SETUP.EXE

4-2 SOUND install ALC655 Codec Audio Driver

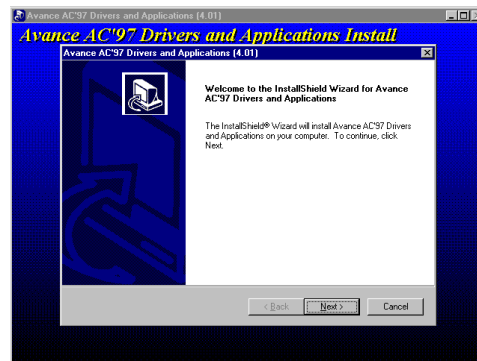

1. Click SOUND when MAGIC INSTALL MENU appears

2. Click NEXT when the realtek AC97 Audio Setup windows appear

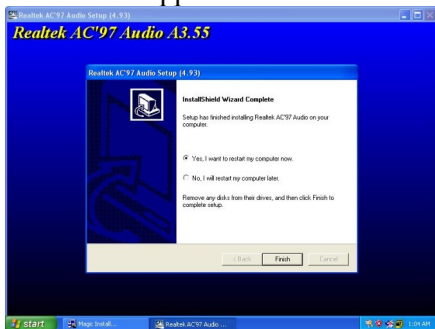

3. Click Finish and Restart Windows

4. Realtek AVRACK utility

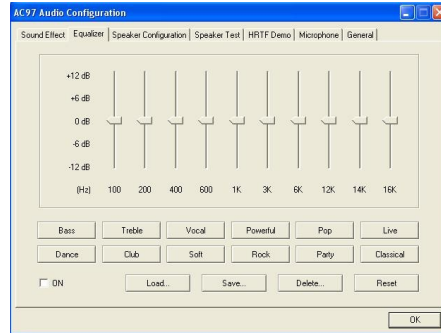
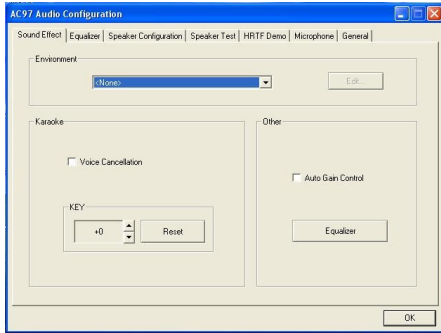

5. Sound Effect select and KaraOK Mode 6. Manual Sound Effect Setting Function



7. This is 2/4/6 channel speakers configuration 8. This is 2/4/6 channel speakers position test setting

Note: The path of the file: For WIN98/NT4.0/WIN2K/XP is X:\CODEC\ALC\SETUP.EXE

4-3 LAN Marvell Yukon Gigabit Ethernet NIC Driver (for 939GT2-Ultra-G / 939GT2-STD-G)

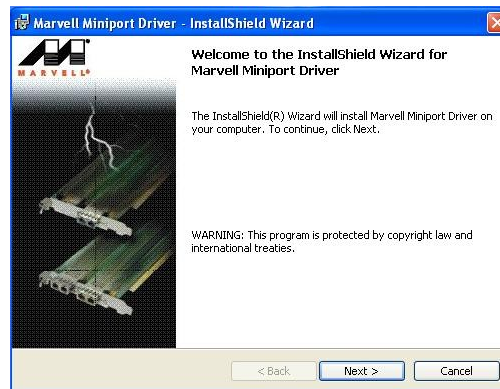

1. Click LAN when Magic Install Menu appear 2. Click Next to install Marvell LAN driver

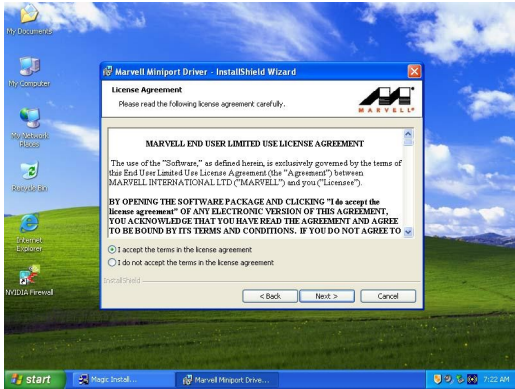

3. Please Accept the license agreement and read the “Readme” file for detailed information , then click Next to proceed.
4. Click Install to install driver and Click Finish end the installation

4-4 USB2.0 Install Nvidia USB2.0 DRIVER

Windows 2000 OS

Please install Windows 2000 service pack 4 or later .

Windows XP OS

Please install Windows XP service pack 1 or later .

4-5 PC-CILLIN Install PC-CILLIN 2005 Anti-virus program

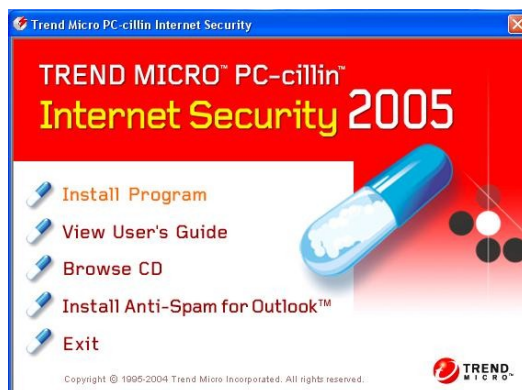

1. Click PC-CILLIN when MAGIC INSTALL MENU appears
2. Please select “Install program” when the "Trend Micro internet security" installshield wizard windows appears

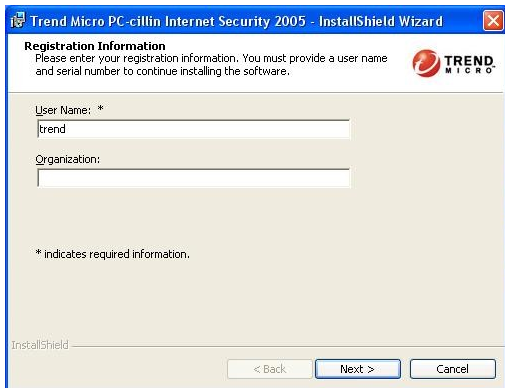

3. Click NEXT and Enter your Customer Information, Click NEXT or choose Change to change the path for the file to be stored

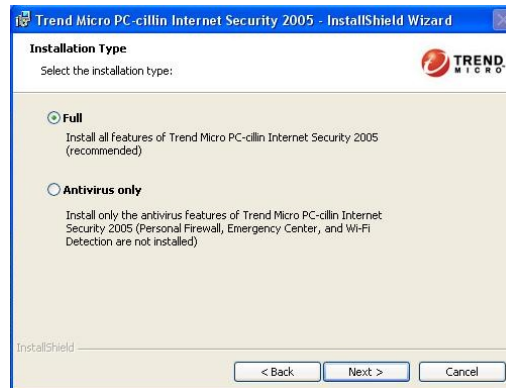

4. Please select install "FULL" function or install "Antivirus software" only



5. We suggest to use "Recommend configuration".

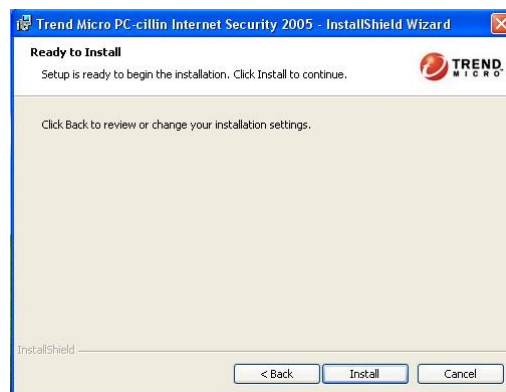

- Click Install to install PCCILLIN 2005 internet security software , then select to restart your computer

Note : Please install ACROBAT READER for reading PC-CILLIN 2005 User Manual which locates at the path "X:\acrobat\adberdr6_enu_full.exe".

4-6 PC-HEALTH Install Myguard Hardware monitor Utility



1. Click PC-HEALTH when MAGIC INSTALL MENU appears



2. Click Next when Install shield Wizard Window appears, Choose destination location

and click Next, when the start copy file windows appear, click next

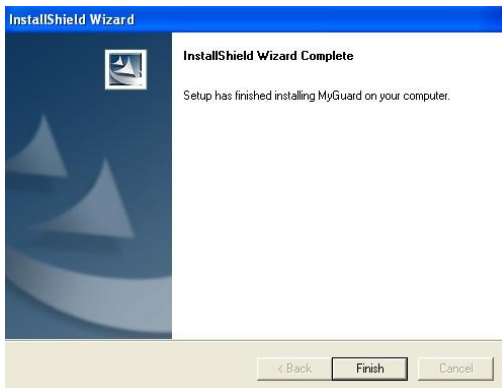

3. Select Finish after setup complete

4. Execute MY GUARD utility, On-time Monitoring your system health

NOTE:

MAGIC INSTALL will auto detect file path X:\NFORCE4\MYGUARD\SETUP.EXE

4-7 HOW TO UPDATE BIOS

Before updating the BIOS, users have to “Disable” the “Flash Part Write Protect” selection in “Miscellaneous Control” of BIOS SETUP. Otherwise the system will not allow you to upgrade BIOS by Award Flash Utility.

STEP 1. Prepare a boot disc. (you may make one by click START click RUN type SYS A: click OK)

STEP 2. Copy utility program to your boot disc. You may copy from DRIVER CD X:\FLASH\AWDFLASH.EXE or download from our web site.

STEP 3. Download and make a copy of the latest BIOS for 939GT4-SLI-D/ 939GT4-SLI-G/ 939GT4-SLI-P motherboard series from the web site to your boot disc.

STEP 4. Insert your boot disc into A:, start the computer, type “Awdflash A:\939GT4xxx.BIN /SN/PY/CC/R”
939GT4xxx.BIN is the file name of latest BIOS it can be 939GT403.BIN or

939GT402.BIN

SN means don't save existing BIOS data

PY means renew existing BIOS data

CC means clear existing CMOS data

R means restart computer

STEP 5. Push ENTER to update and flash the BIOS, then the system will restart automatically.

4-8 Nforce4 Platform RAID Function Installation

Step 1.

Please get into the location: BIOS setup \ Integrated Peripherals \ Onchip IDE function \ RAID Configuration to enable the RAID function and choose the RAID hard drive channel.

Phoenix - AwardBIOS CMOS Setup Utility

RAID Configuration

| RAID Configuration | | | Item Help |
|----------------------|------|----------|-----------|
| RAID Enable | | Enabled | |
| IDE Primary Master | RAID | Disabled | |
| IDE Primary Slave | RAID | Disabled | |
| IDE Secondary Master | RAID | Disabled | |
| IDE Secondary Slave | RAID | Disabled | |
| SATA Channel 1 | RAID | Enabled | |
| SATA Channel 2 | RAID | Enabled | |
| SATA Channel 3 | RAID | Enabled | |
| SATA Channel 4 | RAID | Enabled | |

↑↓→← Move Enter:Select +/-/PU/PD:Value F10:Save ESC:Exit F1:General Help
F5:Previous Values F6:Optimized Defaults F7:Standard Defaults

Step 2.

After the System boot up in the second page , you can find the NVIDIA RAID IDE ROM BIOS windows appear. It will ask you to "Press F10 to enter RAID setup utility ..." ?

Please press "F10" key to RAID utility now , then you can select the RAID functions on your own with the optional RAID functions as below,

1. Mirroring
2. Striping
3. Striping Mirroring
4. Spanning

Array 1 : NVIDIA MIRROR 74.50G

- Array Detail -

| RAID Mode : Mirroring | | Striping Width : 1 | | | | | Striping Block: 64K |
|------------------------------------------------------|---------|--------------------|-------|------|----------------|----------|---------------------|
| Adapt | Channel | M/S | Index | Disk | Model Name | Capacity | |
| 1 | 0 | Master | 0 | WDC | WD800JB-75JMA0 | 75.50GB | |
| 1 | 0 | Master | 0 | WDC | WD800JB-75JMA0 | 75.50GB | |
| [R] Rebuild [D] Delete [C] Clear Disk [ENTER] Return | | | | | | | |

Step 3.

Making RAID driver diskette before Install WindowsXP/2000

Before you install the Windows XP or Windows 2000, you will need to make a RAID driver diskette before you start to install the Operating System.

How to make a RAID driver diskette?

- 1: Insert the diskette which is being formatted in floppy drive on a system which can start OS.
- 2: After booting OS insert the bundle CD in your CD-ROM
- 3: Copy all the files from \Nforce4\RAIDDisk to floppy diskette

Once you have the SATA driver diskette ready, you may start to install Windows XP or Windows 2000 on your System.

Installation of Windows XP/ Windows 2000

For installation of Windows XP or Windows 2000, please insert Windows XP or Windows 2000 CD into the CD-ROM drive. Then remove the floppy diskette, and boot the system. At the very beginning, you will see the message at the bottom of screen, "Press F6 if you need to install a third party SCSI or RAID driver...."

At this moment, please press <F6> key and follow the instructions of Windows XP or Windows 2000 for the proper installation.

Execute Start → programs → NVIDIA corporation → RAID manager , you can view RAID function status or rebuild RAID function from Windows OS

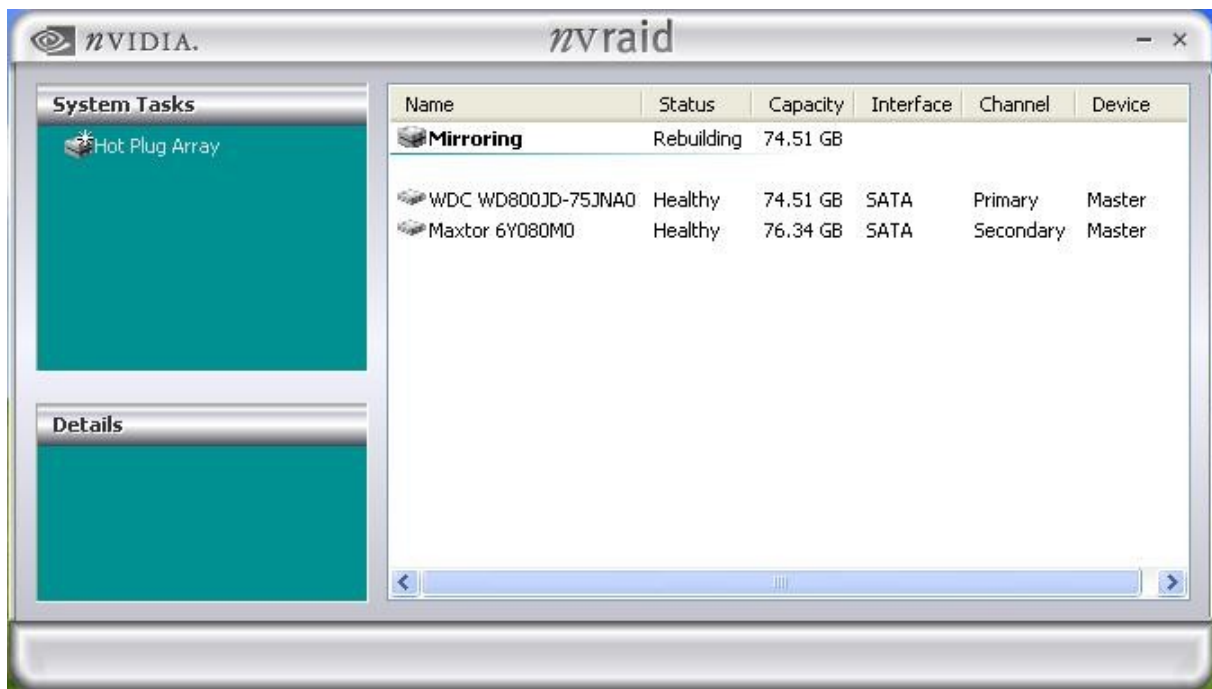

4-9 Pro Magic Plus Function Introduction

What's Pro Magic Plus?

Tired with reinstall OS each time when it doesn't work? Does your computer often crash down or unable to work after installed new software? Have you had great loses and troubles because of computer problems? Still using time-consuming backup software that occupies lots of HD space?

Pro Magic Plus- an instant system recovery software tailored to solve these problems for you. It combines various application tools (e.g. anti-virus, backup software, uninstall software, multi-boot software) to satisfy your needs of all sorts of system protections.

What functions does Pro Magic Plus have?

1. **Instant System Restoration** – Regardless of mis-operation or system crash, install Pro Magic Plus beforehand would allow you to instantly restore your system back by simply reboot your computer.
2. **Easy-to-use** – Auto installation from CD ROM; Supports Mouse
3. **System Uninstall** – Pro Magic provides a protection mode, which allows user to freely test any software. If user does not want to keep the software, just reboot the computer to restore back to the previous state, and Pro Magic will remove it completely from you computer.
4. **Password Security** – Pro Magic provides double password protection, including user password for entering each OS and manager password for managing 'Pro Magic', which can effectively prevent others from using your computer without permission or data from being stolen. (disable item for OEM version)
5. **Complete Protection** – Pro Magic not only protects the system disk, but also can protect your data disk, and does not require to reboot when backup or restore data disk.
6. **Multipoint Save/Restore** – You can backup your system whenever you need and restore them back to anytime you wish, 1 hour, 1 day or 1 month ago. Restore points are unlimited. (disable item for OEM version)
7. **Data Disk Protection** – Pro Magic Plus now comes with data disk protection, provides complete protection for your computer! (disable item for OEM version)
8. **You can choose to change the default path of 'My Document', 'My Favorite' and 'Outlook Express'**, so that when you are restoring the system, data in these folders will not be restored as well. (This is optional, you can leave it as it is).

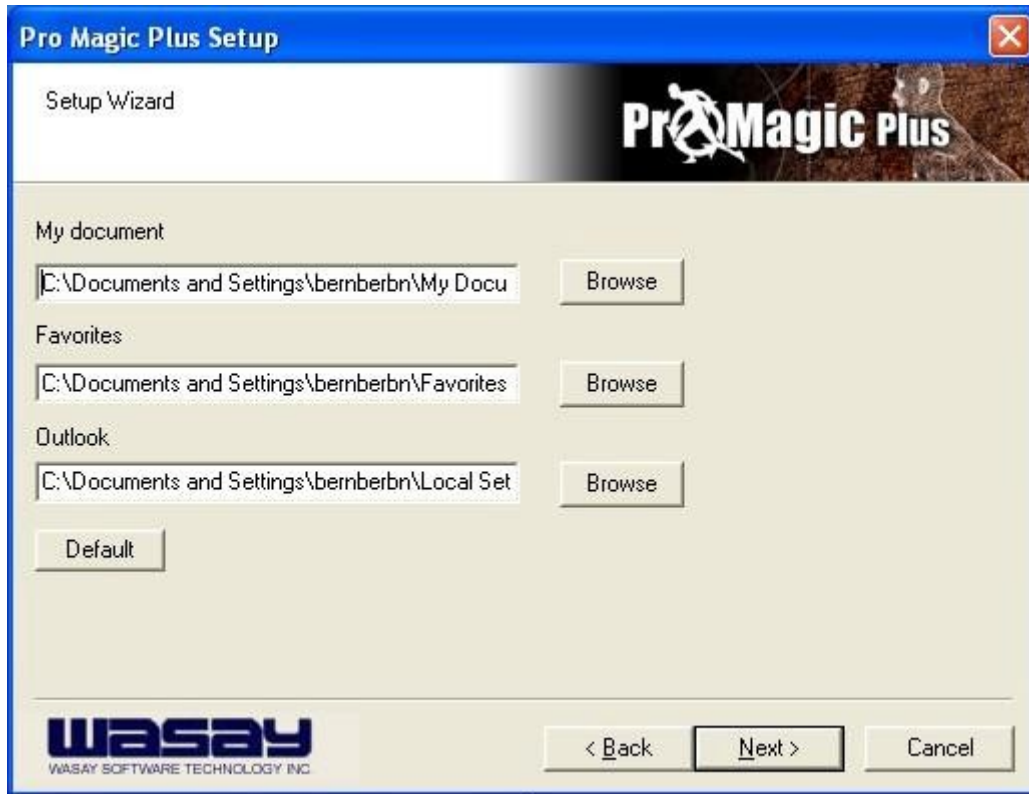

graph 4

NOTE: Functions of each version will differ from each other, and will be based on the function descriptions of each version.

System Requirements

- ◇ First OS must be Windows 98 SE/ME/2000/XP
- ◇ Support Only Windows OS (No Linux)
- ◇ Windows server OS and Windows NT not supported
- ◇ Minimum of Intel 486 or above, 16MB of memory or above
- ◇ Minimum of 500MB free/usable space or above
- ◇ Support for SCSI & SATA Hard disk

Pro Magic Plus only supports SCSI hard disk with Windows 2000 or OS above

Notice Before Installation

1. Before install Pro Magic Plus, turn off all anti-virus software. (Include BIOS anti-virus function)
2. Pro Magic Plus does not support multiple PRI partitions. If you have multiple PRI partitions, please repartition your HD before installation.
3. If your HDD is not fully partitioned (with un-partitioned/unused space at end of HDD), please repartition the HDD before install Pro Magic Plus.