

USER'S MANUAL
of
Intel 945P / 945PL Express Chipset
&
Intel FW82801GB ICH Chipset
Based
M/B For LGA 775 Core 2 Duo Processor

NO. G03945PLCAPR310

Rev3.0

Release date: September 2006

Trademark:

* Specifications and Information contained in this documentation are furnished for information use only, and are subject to change at any time without notice, and should not be construed as a commitment by manufacturer.

Environmental Protection Announcement

Do not dispose this electronic device into the trash while discarding. To minimize pollution and ensure environment protection of mother earth, please recycle.



TABLE OF CONTENT

USER'S NOTICE	ii
MANUAL REVISION INFORMATION.....	ii
COOLING SOLUTIONS.....	ii
CHAPTER 1 INTRODUCTION OF INTEL 945P / 945PL EXPRESS CHIPSET MOTHERBOARDS	
1-1 FEATURE OF MOTHERBOARD	1
1-1.1 SPECIAL FEATURES OF MOTHERBOARD	2
1-2 SPECIFICATION.....	3
1-3 PERFORMANCE LIST.....	4
1-4 LAYOUT DIAGRAM & JUMPER SETTING.....	5
CHAPTER 2 HARDWARE INSTALLATION	
2-1 HARDWARE INSTALLATION STEPS	7
2-2 CHECKING MOTHERBOARD'S JUMPER SETTING	7
2-3 INSTALL CPU.....	8
2-3-1 GLOSSARY.....	8
2-3-2 ABOUT INTEL PENTIUM 4 LGA 775 CPU	9
2-3-3 LGA 775 CPU INSTALLATION GUIDE	10
2-4 INSTALL MEMORY	19
2-5 EXPANSION CARDS	20
2-5-1 PROCEDURE FOR EXPANSION CARD INSTALLATION	20
2-5-2 ASSIGNING IRQ FOR EXPANSION CARD	20
2-5-3 INTERRUPT REQUEST TABLE FOR THIS MOTHERBOARD	21
2-5-4 PCI EXPRESS SLOT	21
2-6 CONNECTORS, HEADERS.....	22
2-6-1 CONNECTORS	22
2-6-2 HEADERS	25
2-7 STARTING UP YOUR COMPUTER	28
CHAPTER 3 INTRODUCING BIOS	
3-1 ENTERING SETUP	29
3-2 GETTING HELP	29
3-3 THE MAIN MENU.....	30
3-4 STANDARD CMOS FEATURES.....	31
3-5 ADVANCED BIOS FEATURES.....	32
3-6 ADVANCED CHIPSET FEATURES.....	34
3-6-1 PCIEXPRESS ROOT PORT FUNCTION	35
3-7 INTEGRATED PERIPHERALS	36
3-7-1 ONBOARD IDE FUNCTION.....	36
3-7-2 ONBOARD DEVICE FUNCTION	37
3-7-3 ONBOARD SUPER IO FUNCTION	38
3-8 POWER MANAGEMENT SETUP	39
3-8-1 PM TIMER RELOAD EVENTS.....	40
3-9 PNP / PCI CONFIGURATION STEP.....	40
3-9-1 IRQ RESOURCES.....	41
3-10 PC HEALTH STATUS	41
3-10-1 SMART FAN CONFIGURATIONS.....	42
3-10-2 THERMAL THROTTLING OPTIONS	42
3-11 MISCELLANEOUS CONTROL.....	44
3-12 LOAD STANDARD/OPTIMIZED DEFAULTS.....	46
3-13 SET SUPERVISOR / USER PASSWORD	46
CHAPTER 4 DRIVER & FREE PROGRAM INSTALLATION	
MAGIC INSTALL SUPPORTS WINDOWS 2000/XP	47
4-1 INF INSTALL INTEL 945 CHIPSET SYSTEM DRIVER	48
4-2 SOUND INSTALL ALC850 CODEC AUDIO DRIVER	48
4-3 LAN INSTALL REALTEK LAN CONTROLLER DRIVER	49
4-4 PC-HEALTH INSTALL MYGUARD HARDWARE MONITOR UTILITY	50
4-5 USB2.0 INSTALL INTELUSB2.0 DRIVER	51
4-6 PC-CILLIN INSTALL PC-CILLIN 2006 ANTI-VIRUS PROGRAM.....	51
4-7 HOW TO UPDATE BIOS	52
4-8 PRO MAGIC PLUS FUNCTION INTRODUCTION	52

USER'S NOTICE

COPYRIGHT OF THIS MANUAL BELONGS TO THE MANUFACTURER. NO PART OF THIS MANUAL, INCLUDING THE PRODUCTS AND SOFTWARE DESCRIBED IN IT MAY BE REPRODUCED, TRANSMITTED OR TRANSLATED INTO ANY LANGUAGE IN ANY FORM OR BY ANY MEANS WITHOUT WRITTEN PERMISSION OF THE MANUFACTURER.

THIS MANUAL CONTAINS ALL INFORMATION REQUIRED TO USE INTEL 945PL CHIPSET MOTHERBOARD SERIES AND WE DO ASSURE THIS MANUAL MEETS USER'S REQUIREMENT BUT WILL CHANGE, CORRECT ANY TIME WITHOUT NOTICE. MANUFACTURER PROVIDES THIS MANUAL "AS IS" WITHOUT WARRANTY OF ANY KIND, AND WILL NOT BE LIABLE FOR ANY INDIRECT, SPECIAL, INCIDENTAL OR CONSEQUENTIAL DAMAGES (INCLUDING DAMAGES FOR LOSS OF PROFIT, LOSS OF BUSINESS, LOSS OF USE OF DATA, INTERRUPTION OF BUSINESS AND THE LIKE).

PRODUCTS AND CORPORATE NAMES APPEARING IN THIS MANUAL MAY OR MAY NOT BE REGISTERED TRADEMARKS OR COPYRIGHTS OF THEIR RESPECTIVE COMPANIES, AND THEY ARE USED ONLY FOR IDENTIFICATION OR EXPLANATION AND TO THE OWNER'S BENEFIT, WITHOUT INTENT TO INFRINGE.

Manual Revision Information

Reversion	Revision History	Date
3.0	Third Edition	September 2006

Item Checklist

- Intel 945P / 945PL Express Chipset Based Motherboard
- Cable for IDE
- CD for motherboard utilities
- Cable for USB Port 3/4 (Option)
- Cable for Serial ATA2 IDE Port
- Intel 945P / 945PL Express Chipset Based Motherboard User's Manual

Intel Pentium 4 Processor Family

Cooling Solutions

As processor technology pushes to faster speeds and higher performance, thermal management becomes increasingly crucial when building computer systems. Maintaining the proper thermal environment is key to reliable, long-term system operation. The overall goal in providing the proper thermal environment is keeping the processor below its specified maximum case temperature. Heat sinks induce improved processor heat dissipation through increased surface area and concentrated airflow from attached fans. In addition, interface materials allow effective transfers of heat from the processor to the heatsink. For optimum heat transfer, Intel recommends the use of thermal grease and mounting clips to attach the heatsink to the processor.

When selecting a thermal solution for your system, please refer to the website below for collection of heat sinks evaluated and recommended by Intel for use with Intel processors. Note, those heat sinks are recommended for maintaining the specified Maximum T case requirement. In addition, this collection is not intended to be a comprehensive listing of all heat sinks that support Intel processors.

For vendor list of heatsink and fan, please visit :

<http://developer.intel.com/design/Pentium4/components/index>

Chapter 1

Introduction of Intel 945P / 945PL Express Chipset Motherboards

1-1 Feature of motherboard

The Intel 945P / 945PL chipset motherboard series are based on the latest Intel 945P / 945PL Express Chipset and Intel FW82801GB ICH Chipset technology which supports the innovative 65nm and 90nm Dual-Core Intel® Pentium® D Processor 8 and 9 Series, Intel® Pentium® D Processor, and Intel® Core 2 Duo® (Code Name: Conroe) Processor with Intel® Hyper-Threading Technology. The motherboard is optimized to deliver innovative features and professional desktop platform solution with the advantages of the new generation dual core Intel® Core 2 Duo® Processor for those who demand the best experience of personal computing. Through the high bandwidth of dual channel DDR2 400 / 533MHz system memories (945P Express Chipset supports dual Channel DDR2 533 / 667MHz system memories) which are expandable to 2.0GB and the next generation PCI Express interface for the latest graphics cards from both NVIDIA & ATI. The Intel 945P / 945PL chipset motherboard series for Intel® Core 2 Duo® Processor are absolutely a cost-effective solution for game enthusiasts and applications, and it also meets the demanding usage of computing of gaming, multimedia entertainment and business applications.

The motherboards implement Intel 945P / 945PL Express Chipset which supports Front Side Bus 533MHz / 800MHz of data transferring and offers with 100 / 133MHz memory clock frequency for Dual channel DDR2 400 / 533 MHz memory DIMMs to double the performance of memory access(945P Express Chipset which supports Front Side Bus 533MHz / 800MHz / 1066MHz of data transferring and offers with 100 / 133MHz / 166MHz memory clock frequency for Dual channel DDR2 400 / 533 / 667 MHz memory DIMMs). The motherboard is embedded with ICH7 chipset of providing one parallel Ultra ATA 100 interface for two IDE drives and four serial ATA2 interface of 3.0Gb / s data transfer rate for four serial ATA devices.

The motherboards offer one PCI-Express x16 graphics slot of 4Gbyte/sec data transfer rate at each relative direction which gets 3.5 times of bandwidth more than AGP8X and it's up to a peak concurrent bandwidth of 8Gbyte/sec at full speed to guarantee the ultimate GPU computing performance. Three 32-bit PCI slots guarantee the rich connectivity for the I/O of peripherals. Two PCI Express x1 I/O slots offer 512Mbyte/sec concurrently bandwidth which is over 3.5 times than 32-bit PCI at 133Mbyte/sec; the motherboards are designed of tackling the profuse multimedia requirements nowadays.

The motherboards provide optional 10 / 100 Ethernet compatible LAN function by using the Realtek RTL8100C 10 /100 LAN NIC which supports 10M / 100M data transfer rate. And the embedded AC'97 8-channel Audio CODEC is fully compatible with Sound Blaster Pro® standards that offers you with the home cinema quality and satisfying software compatibility.

Embedded USB controller as well as capability of expanding to 8 of USB2.0 functional ports delivering 480Mb/s of rich connectivity, these motherboards meet the demands of future USB peripherals which are also equipped with hardware monitor function on system to monitor and protect your system and maintain your non-stop business computing.

Some special features---**CPU Thermal Throttling/ CPU Vcore 7-shift/ CPU Smart Fan/ Optional Debug Port** in this motherboard are designed for power user to use the over-clocking function in more flexible ways. But please be caution that the over-clocking maybe cause the fails in system reliabilities. This motherboard provides the guaranteed performance and meets the demands of the next generation computing. But if you insist to gain more system performance with variety possibilities of the components you choose, please be careful and make sure to read the detailed descriptions of these value added product features, please get them in the coming section.

1-1.1 Special Features of motherboard

Optional Debug Port --- (The Professional Hardware Diagnosis System and not for 945PLDAS-VC motherboards)

Being bugged of abnormal system failure through the tossed and turned nights no more, the embedded Hardware Debug Port offers you the real-time visual system healthy for the demanding usage of computing. No more bugging by unknown system failure and no more time wasted in the first moment of 24-hour nonstop ping business computing, the embedded Debug Port will turn you into a well training hardware professional with the seeing system situation. (The Post Code please refer Appendix)

CPU Thermal Throttling Technology---(The CPU Overheat Protection Technology)

To prevent the increasing heat from damage of CPU or accidental shutdown while at high workload, the CPU Thermal Throttling Technology will force CPU to enter partially idle mode from 87.5% to 12.5% according to preset CPU operating temperature in BIOS (from 40°C to 90°C). When the system senses the CPU operating temperature reaching the preset value, the CPU operating bandwidth will be decreased to the preset idle percentage to cool down the processor. When at throttling mode the beeper sound can be optionally selected to indicate it is in working. (*for detail operating please read Section 3-11 Bi-turbo Configuration*)

CPU Smart Fan---(The Noise Management System)

It's never been a good idea to gain the performance of your system by sacrificing its acoustics. CPU Smart Fan Noise Management System is the answer to control the noise level needed for now-a-day's high performance computing system. The system will automatically increase the fan speed when CPU operating loading is high, after the CPU is in normal operating condition, the system will low down the fan speed for the silent operating environment. The system can provide the much longer life cycle for both CPU and the system fans for game use and business requirements.

CPU Vcore 7 Shift--- (Shift to Higher Performance)

The CPU voltage can be adjusted up by 7 steps for the precisely over-clocking of extra demanding computing performance.

1-2 Specification

Spec	Description
Design	* ATX form factor 4 layers PCB size: 30.5x21 cm
Chipset	* Intel 945P / 945PL Memory Controller Hub (MCH) Chipset * Intel 82801GB I/O Controller Hub (ICH7) Chipset
CPU Socket (LGA775 Socket)	* Support Intel Pentium 4, Celeron D, Pentium D, and Core 2 Duo 775-Land LGA Package utilizes Flip-Chip Land Grid Array (FCLGA4) package processor * Support FSB Frequency 533MHz / 800 MHz * 945P Express Chipset Supports FSB 1066 / 800 / 533 MHz
Memory Socket	* 240-pin DDR2 RAM module socket x2 * Support Dual channel DDR2 400MHz / 533MHz RAM Module and which is expandable to 2.0GB. * 945P Express Chipset Supports Dual channel DDR2 400MHz / 533MHz / 667MHz RAM Module and which is expandable to 2.0GB.
Expansion Slots	* PCI-Express x16 slot 1pcs delivers up to 8GB/s of concurrent bandwidth. * PCI-Express x1 slot 2pcs delivers up to 512MB/s of concurrent bandwidth * 32-bit PCI slot x 3pcs at 133MHz
Integrate IDE and Serial ATA2	* One PCI IDE controller that supports PCI Bus Mastering, ATA PIO/DMA and the ULTRA DMA 33/66/100 functions that deliver the data transfer rate up to 100 MB/s; four Serial ATA2 ports provide 3.0 Gb /sec data transfer rate.
LAN	* Integrated Realtek RTL8100C PCI 10 / 100 LAN. * Support Fast Ethernet LAN function of providing 10Mb/100Mb/1000 Mb/s data transfer rate
Audio	* Realtek ALC850 AC'97 8-channel Audio Codec integrated * Support 8-channel 3D surround & Positioning Audio * Audio driver and utility included
BIOS	* Award 4MB Flash ROM
Multi I/O	* PS/2 keyboard and PS/2 mouse connectors * Floppy disk drive connector x1 * Parallel port x1 * Serial port x1 * SPDIF In x1 * SPDIF Out x1 * USB 2.0 connector x 4, headers x4 (connecting cable option) * 8-channel Audio connector (Line-in, Line-out, MIC/ 8CH Audio)

1-3 Performance List

The following performance data list is the testing result of some popular benchmark testing programs. These data are just referred by users, and there is no responsibility for different testing data values gotten by users (the different Hardware & Software configuration will result in different benchmark testing results.)

Performance Test Report

CPU: Intel Pentium 4 Prescott 3.4G(CIE)
DRAM: PMI SAMSUNG 512M DDR2-533 X 2 1Gbyte Memory
 TwinMOS Hynix Hy5du56822CT 512M DDR400 X 2 (1Gbyte) Memory
On Board VGA: Nvidia Geforce 6600GT 128M (1024X768X32BIT Color)
Hard Disk Driver: Seagate Barracude 7200.7 SATA150
BIOS: Award Optimal default
OS: Win XP Professional (Service Pack 2)

	945P / 945PL Express Chipset Dual Channel
3D Mark 2001SE	17692
3D Mark 2003	8694
3D Mark 2005	3655
AQUAMRK3 (CPU)	54790 (9298)
PCMark2004	
System / CPU / Memory	5072 / 5194 / 5035
Graph / HDD	4178 / N/A
Content Creation Winstone 2004	28.5
Business Winstone 2004	17.6
Winbench 99 V2.0:	
Business/Hi-end Disk Winmark99	14200 / 39500
Business/Hi-end Graphic Winmark	729 / 1490
SISMark 2004: SISMark Rating(Internet Content Creation / Office Productivity)	
SISMark 2004	212 / 271
3D Creation / 2D Creation	192
/ Web publication	180 / 205
Communication / Document Creation	200
/ Data Analysis	212 / 271
SISOFT Sandra 2004 : 1.CPU Arithmetic Benchmark 2.Memory bandwidth Benchmark 3.CPU Multi-Media Benchmark	
1.Dhrystone ALU MIPS	10024
Whetstone FPU iSSE2 FLOPS	4125 / 6995
2.Int/Float Buffered iSSE2 MB/S	4815 / 4819
3.Integer/Floating-Point SSE2 IT/S	24495 / 32393
UT2003 Benchmark (flyby/botmatch)	238.27 / 83.40
DOOM3 FPS	90.4
Super Pi (1M) Second	38s
CPUZ System / Memory/CPU MHZ	200/266/3400

1-4 Layout Diagram & Jumper Setting

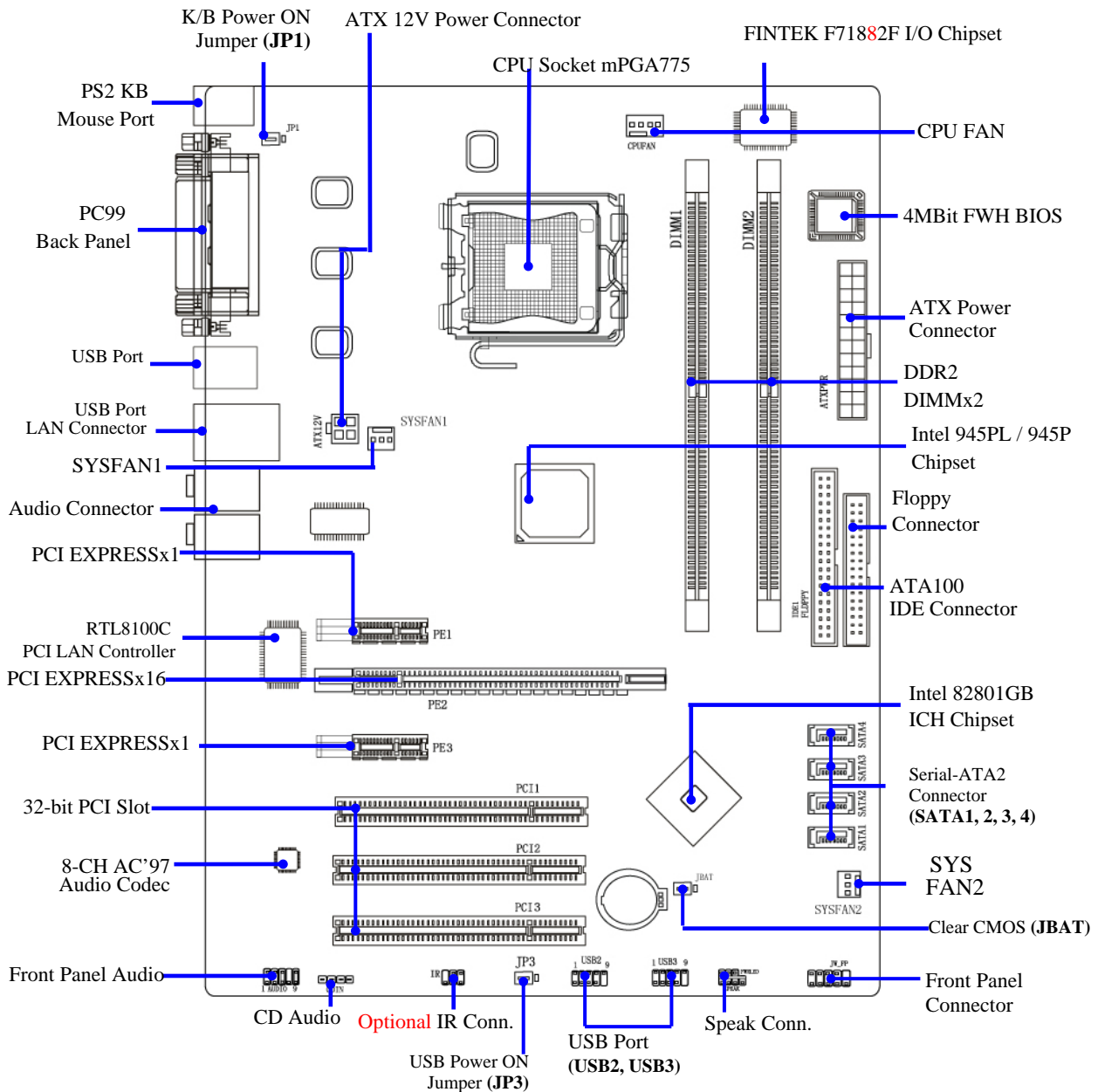
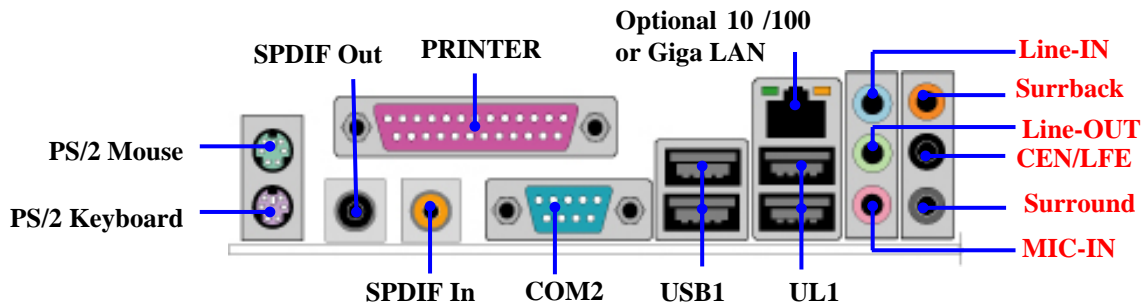

Jumpers

Jumper	Name	Description	Page
JBAT	CMOS RAM Clear	3-pin Block	P.7
JP1	Keyboard Power On Enable/Disabled	3-pin Block	P.8
JP3	USB Power On Enable/Disabled	3-pin Block	P.8

Connectors

Connector	Name	Description	Page
ATXPWR	ATX Power Connector	24-pin Block	P.22
ATX12V	ATX 12V Power Connector	4-pin Block	P.23
UL1	RJ45 LAN Port Over USB Conn.	RJ-45 Connector	P.23
USB1	USB Conn.	USB Connector	P.23
PS2 KB/MOUSE	PS/2 Mouse & PS/2 Keyboard Connector	6-pin Female	P.23
PARALLEL	Parallel Port Connector	25-pin Female	P.23
PHONE_JACK	Audio Line In/Out MIC Connector	6 phone jack Connector	P.23
COM2	Serial Port COM2 Connector	9-pin Connector	P.24
SPDIF IN/OUT	SPDIF In/Out Connector	1-pin jack Connector	P.23
FLOPPY	Floppy Driver Connector	34-pin Block	P.24
IDE1	Ultra DMA 100 IDE Connector	40-pin Block	P.24
SATA1~4	Serial-ATA2 Port Connector	7-pin Block	P.25

Headers

Header	Name	Description	Page
AUDIO	Line-Out, MIC Headers	9-pin Block	P.25
USB2 / USB3	USB Port Headers	9-pin Block	P.25
SPEAK	Speaker connector	4-pin Block	P.26
JW_FP (Power LED/Reset/ IDE LED/ Power Button)	Front Panel Header (including Power LED/ IDE activity LED/ Reset switch / Power On Button lead)	9-pin Block	P.26
CPUFAN	CPUFAN Power Header	4-pin Block	P.26
SYSFAN1, SYSFAN2	FAN Power Headers	3-pin Block	P.26
IR (Option)	IR infrared module Headers	5-pin Block	P.27
CDIN	CD Audio-In Headers	4-pin Block	P.27

Expansion Sockets

Socket/Slot	Name	Description	Page
LGA 775 Socket	CPU Socket	LGA 775 CPU Socket	P.9
DIMM1, DIMM2	DDR2 Module Socket	240-pin DDR2 RAM Module Expansion Socket	P.19
PCI 1 ~ PCI 3	PCI Slot	32-bit PCI Local Bus Expansion slots	P.21
PE2	x16 PCI Express Slot	x16 PCI Express Expansion Slot	P.21
PE1 / PE3	x1 PCI Express Slot	x1 PCI Express Expansion Slot	P.21

Chapter 2

Hardware Installation

2-1 Hardware Installation Steps

Before using your computer, you had better complete the following steps:

1. Check motherboard jumper setting
2. Install CPU and Fan
3. Install System Memory (DIMM)
4. Install Expansion cards
5. Connect IDE and Floppy cables, Front Panel /Back Panel cable
6. Connect ATX Power cable
7. Power-On and Load Standard Default
8. Reboot
9. Install Operating System
10. Install Driver and Utility

2-2 Checking Motherboard's Jumper Setting

(1) CMOS RAM Clear (3-pin) : JBAT

A battery must be used to retain the motherboard configuration in CMOS RAM short 1-2 pins of JPAT to store the CMOS data.

To clear the CMOS, follow the procedure below:

1. Turn off the system and unplug the AC power
2. Remove ATX power cable from ATX power connector
3. Locate JPAT and short pins 2-3 for a few seconds
4. Return JPAT to its normal setting by shorting pins 1-2
5. Connect ATX power cable back to ATX power connector

Note: When should clear CMOS

1. *Troubleshooting*
2. *Forget password*
3. *After over clocking system boot fail*

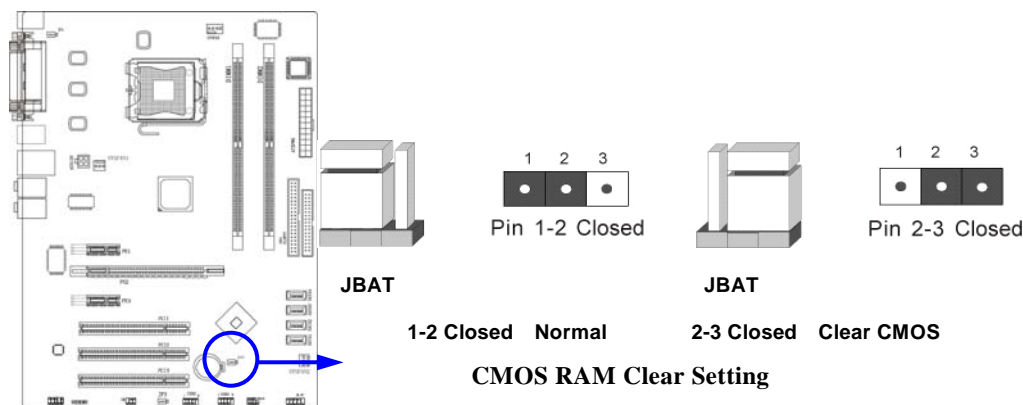

(2) Keyboard function Enabled/Disabled: JP1

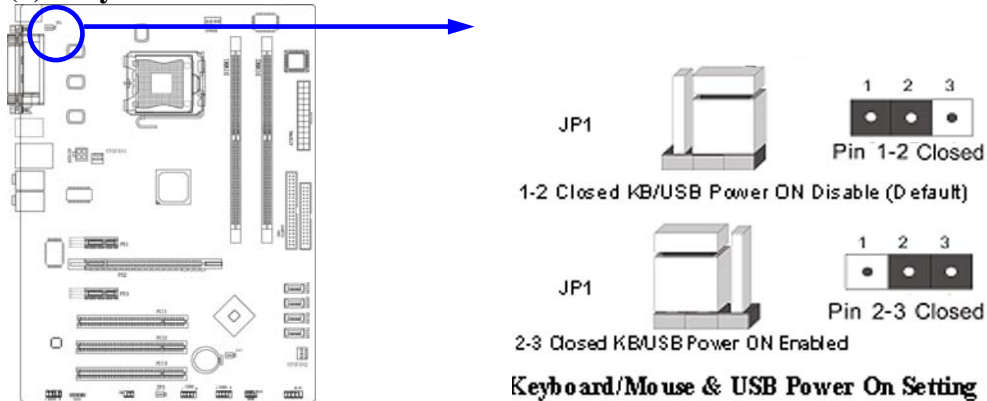

(3) USB Power On function Enabled/Disabled: JP3

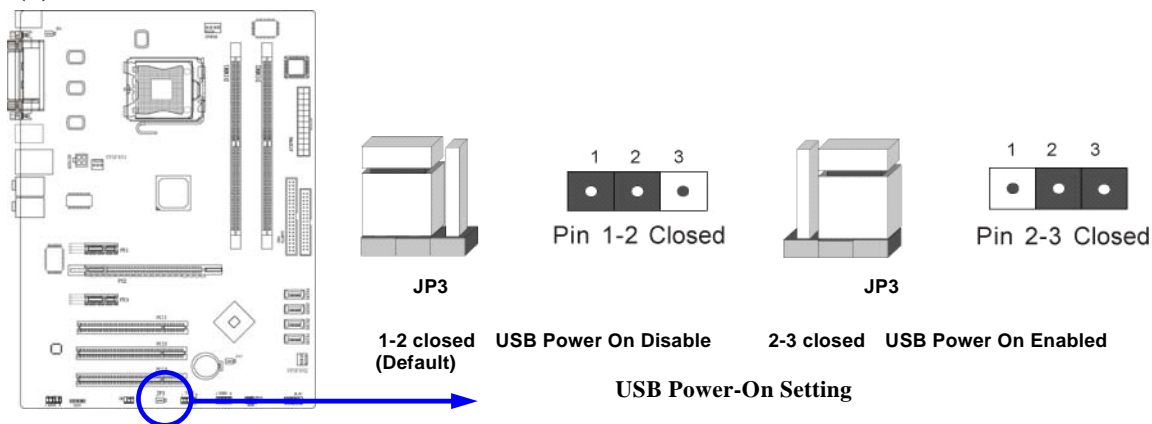

2-3 Install CPU

2-3-1 Glossary

Chipset (or core logic) - two or more integrated circuits which control the interfaces between the system processor, RAM, I/O devices, and adapter cards.

Processor slot/socket/LGA - the slot or socket used to mount the system processor on the motherboard.

Slot (PCI-E, PCI, RAM) - the slots used to mount adapter cards and system RAM.

PCI - Peripheral Component Interconnect - a high speed interface for video cards, sound cards, network interface cards, and modems; runs at 33MHz.

PCI Express- Peripheral Component Interconnect Express- a high speed interface for video cards, sound cards, network interface cards, and modems

Serial Port - a low speed interface typically used for mouse and external modems.

Parallel Port - a low speed interface typically used for printers.

PS/2 - a low speed interface used for mouse and keyboards.

USB - Universal Serial Bus - a medium speed interface typically used for mouse, keyboards, scanners, and some digital cameras.

Sound (interface) - the interface between the sound card or integrated sound connectors and speakers, MIC, game controllers, and MIDI sound devices.

LAN (interface) - Local Area Network - the interface to your local area network.

BIOS (Basic Input/Output System) - the program logic used to boot up a computer and establish the relationship between the various components.

Driver - software, which defines the characteristics of a device for use by another device or other software.

Processor - the "central processing unit" (CPU); the principal integrated circuit used for doing the "computing" in "personal computer"

Front Side Bus Frequency - the working frequency of the motherboard, which is generated by the clock generator for CPU, DRAM and PCI BUS.

CPU L2 Cache - the flash memory inside the CPU, normally Athlon CPU has 256K or above, while Duron will have 64K.

2-3-2 About Intel Pentium 4 LGA775 CPU

This motherboard provides a 775-pin surface mount, LGA775 Land Grid Array socket, referred to as the LGA775 socket supports Intel Pentium 4 processor in the 775 Pin package utilizes Flip-Chip Land Grid Array (FC-LGA4) package technology.

The CPU that comes with the motherboard should have a cooling FAN attached to prevent overheating. If this is not the case, then purchase a correct cooling FAN before you turn on your system.

WARNING! Be sure that there is sufficient air circulation across the processor's heatsink and CPU cooling FAN is working correctly, otherwise it may cause the processor and motherboard overheat and damage, you may install an auxiliary cooling FAN, if necessary.

To install a CPU, first turn off your system and remove its cover. Locate the LGA775 socket and open it by first pulling the level sideways away from the socket then upward to a 90-degree angle. Insert the CPU with the correct orientation as shown below. The notched corner should point toward the end of the level. Because the CPU has a corner pin for two of the four corners, the CPU will only fit in the orientation as shown.

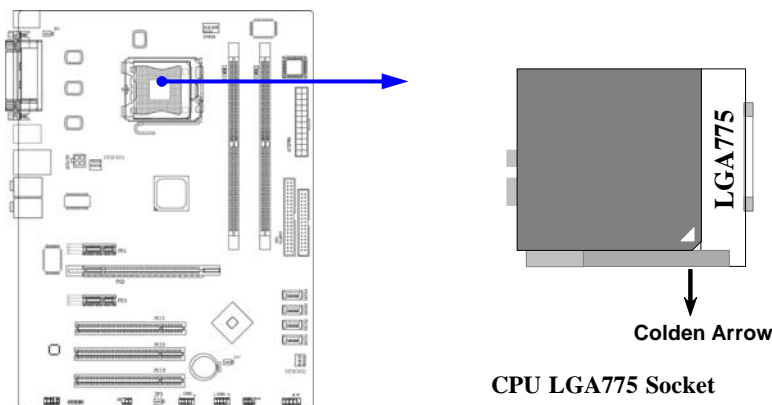

When you put the CPU into the LGA775 socket. No force require to insert of the CPU, then press the level to Locate position slightly without any extra force.

2-3-3 LGA 775 CPU Installation Guide

Socket Preparation

1. Opening the socket:

Note: Apply pressure to the corner with right hand thumb while opening/closing the load lever, otherwise lever can bounce back like a “mouse trap” and WILL cause bent contacts (when loaded)

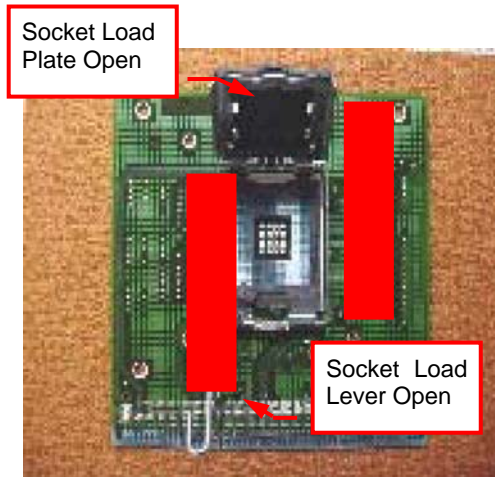

- i. Disengage Load Lever by **depressing down** and **out** on the hook to clear retention tab
- ii. Rotate Load Lever to fully open position at approximately 135degrees
- iii. Rotate Load Plate to fully open position at approximately 100degrees

2. Remove PnP Cap (Pick & Place Cap)

- i. With left hand index finger and thumb to support the load plate edge, engage PnP cap with right hand thumb and peel the cap from LGA775 Socket while pressing on center of PnP cap to assist in removal.
- ii. Set PnP cap aside. Always put PnP cap back on if the processor is removed from the socket.
- iii. Visually inspect PnP cap for damage. If damage observed, replace the PnP cap.



Note: After PnP cap removal, make sure socket load plate and contacts are free of foreign material; Refer to Overview Module for FM cleaning.

Note: Optionally, remove PnP cap after CPU insertion. This will compromise the ability to visually inspect socket.

3. Visually inspect for bent contacts (Recommend at least 1stpass visual inspection)

NOTE: Refer to the Handling and Inspection Module for 1stand 2ndpass inspection details.

NOTE: Glove images are for illustrative purposes only. Please consult local safety guidelines for specific requirements

NOTE: Recommend not to hold the load plate as a lever, instead hold at tab with left hand, removing the PnP cap with right hand

775- Land LGA Package Insertion

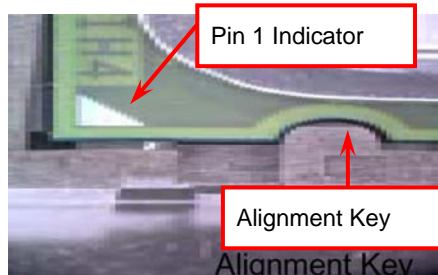

1. Lift processor package from shipping media by grasping the substrate edges ONLY.
Note: Orient processor package such that the Pin 1 triangle mark is on bottom left and both key notches are on left side
2. Land Side Cover Handling: Remove land side cover with the opposite hand by depressing larger retention tab and peeling the cover away
3. Set and reserve the land side cover aside.
Note: Always keep the land side cover on the processor when not in the socket.
4. Visually inspect the package gold pads: Scan the processor package gold pad array for presence of foreign material. Refer to Overview Module for FM cleaning recommendations
5. Orient the package with IHS up. Locate Pin 1 and the two orientation key notches
6. Carefully place the package into the socket body using a purely vertical motion

CAUTION: Using Vacuum Pen for installation is *not* recommended

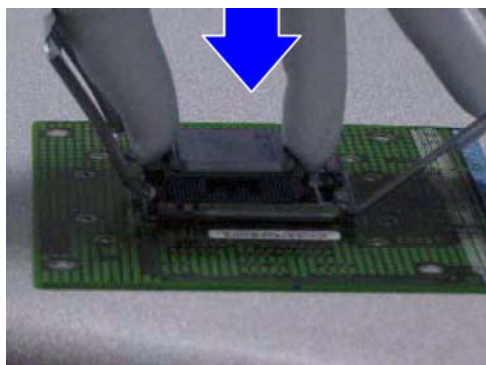

7. Verify that package is within the socket body and properly mated to the orient keys
8. Close the socket by
 - i. Rotating the Load Plate onto the package HIS
 - ii. While pressing down lightly on Load Plate, engage the Load Lever.
 - iii. Securing Load Lever with Load Plate tab under retention tab of Load Lever



775- Land Package Removal

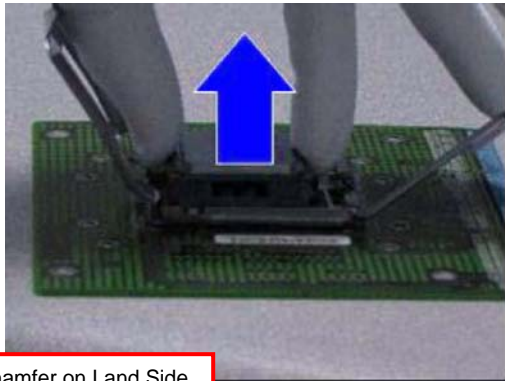

Chamfer on Land Side Cover (align this with pin 1 mark on 775-land LGA package)

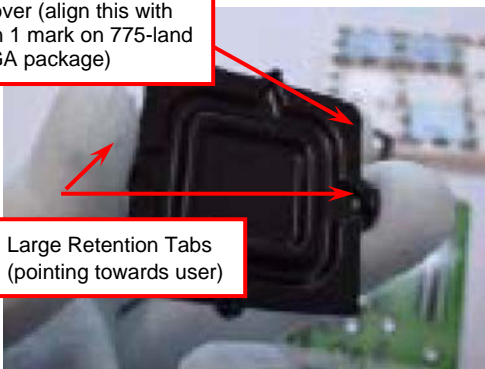

Large Retention Tabs (pointing towards user)

onto

Hold at corners

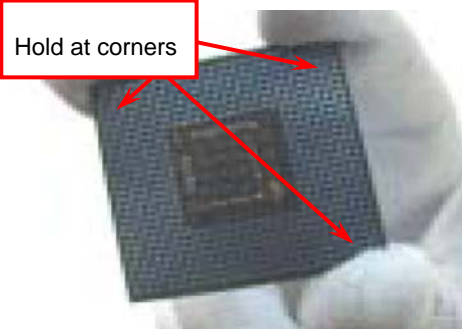

1. Open the Load Plate/Lever with both hands:
With left hand index finger and thumb to support the load plate edge, engage PnP cap with right hand thumb and peel the cap from LGA775 Socket while pressing on center of PnP cap to assist in removal.
2. Pick up 775-land LGA package:
By Vacuum Pen: Place a minimum 9-mm cup at approximately the center of IHS.
Recommend not to place Vacuum Pen on IHS edge. Risk of dropping and causing bent contact.
Recommend not to use Vacuum Pen for inserting CPU By Hand: Index finger to hold load plate hinge side and thumb to hold load lever side
3. Lift the package straight up and away.
4. Assemble processors land side cover immediately to prevent contamination.
 - i. While holding the processor by the 3 corners, the other hand lift land side cover from work surface by grasping at the large retention tabs. Ensure retention tabs and package are pointing each other.
 - ii. Orientate so that land side cover chamfer is matching with package Pin 1 location.
 - iii. Hook the first large retention tab on the package substrate. Then press the opposite tab onto the substrate.
 - iv. Place processor with land side cover installed onto proper shipping media or other ESD approved work surface

5. Visually inspect socket contact array

1. First Pass Inspection

- i. Scan socket contact array at varying angles noting the presence of any foreign material
- ii. If foreign material can't be blown off by compressed air, or mechanical damage (Mode1 or 4) observed, reject the motherboard for further evaluation or socket replacement.

2. Second Pass Inspection

- i. Repeat 2 more times to sight down the rows and columns from each of the 4 sides of the socket to ensure all contacts within the array are inspected
- ii. Inspect for Mode2, Mode3, and Mode5 failures

Note: Refer to the Test Module for detail visual inspections

6. Assemble LGA775 socket PnP cap

- i. Secure/Hook the back side of PnP cap.
- ii. Snap down the front side to fully secure

7. Close the Socket

Intel Reference Thermal Solution Assembly

NOTE: Depending on the configuration, Thermal Solution Integration procedure could perform with M/B alone or with M/B in the Chassis.



0.150-inch backside clearance for fastener installation

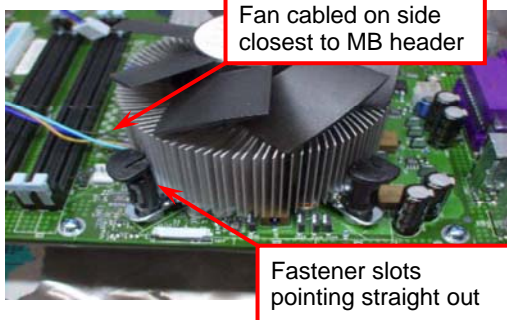
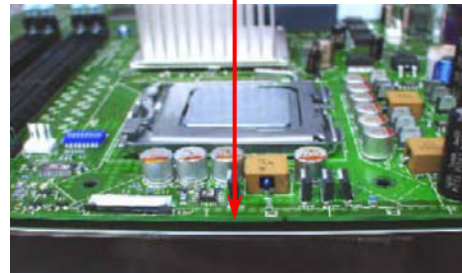

Fan cabled on side closest to MB header

Fastener slots pointing straight out

1. Place motherboard on support structure providing minimum 0.150-inch backside clearance
2. Apply 300 mg of Thermal Interface Material (Shin-Etsu G751) onto center of IHS

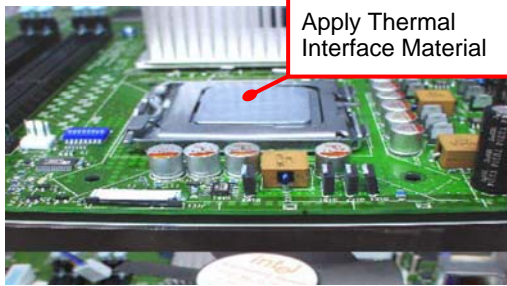

NOTE: Thermal Solutions that come with Intel® boxed processor use pre-applied thermal interface material and not grease.

3. Remove Heat Sink (HS) from packaging media
4. Place HS onto the LGA775 Socket
 - Ensure fan cables are oriented on side closest to fan header
 - Align Fasteners with MB through-holes

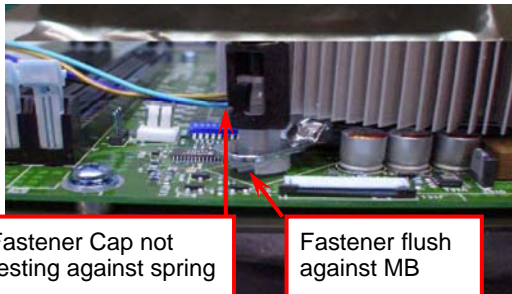

5. Inspection
 - Ensure cables are not trapped or interfere fastener operation
 - Ensure fastener slots are pointing straight out from heatsink

Press Down
(4 Places)

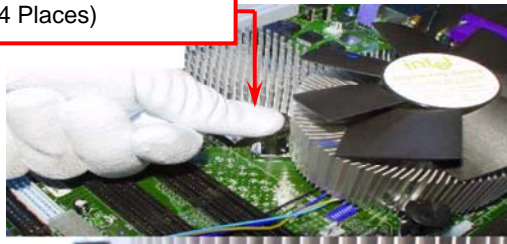

6. Actuate fasteners
 - While holding HS to prevent tilting, press down on fastener caps with thumb to install and lock
- Repeat with remaining fasteners

7. Inspection
 - Verify the fasteners are properly seated
 - Ensure both fastener cap and base are flush with spring and motherboard
8. Connect fan header with Board header

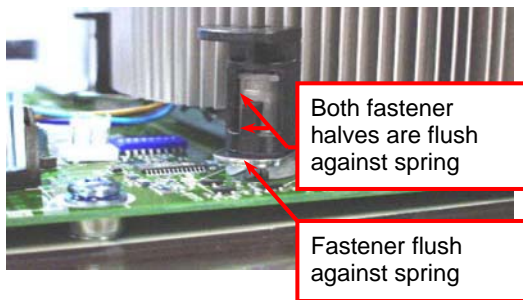

9. Secure excess cable with tie-wrap to ensure cable does not interfere with fan operation or contact other components.

Intel Reference Thermal Solution Disassembly

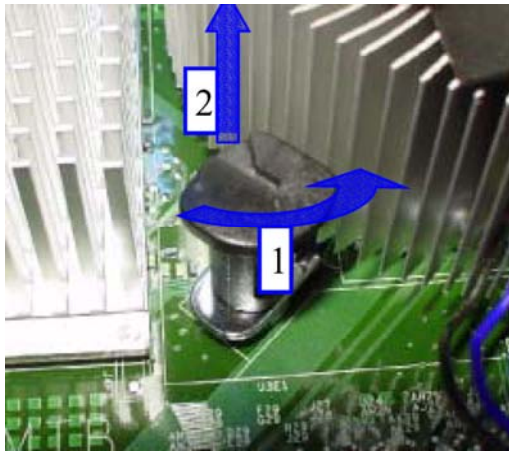

1. Rotate fastener cap. turn to un-lock
 2. Pull up fastener cap to un-seat
1. Disconnect fan cable from motherboard header
 2. Turn fastener caps (4) counter-clock wise 90degrees to the un-locked position
 - A flat-bladed screwdriver may be used if required
 3. Pull up on fastener caps to unseat
 4. Manually remove HS with gentle twist motion.
 5. To re-assemble the HS, reset the fastener caps to their original position with the slot perpendicular to the HS. Then, follow the assembly instructions.

Note: Thermal grease should be reapplied

TIM and Grease Removal from CPU

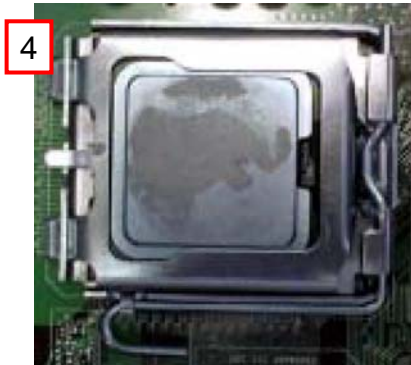
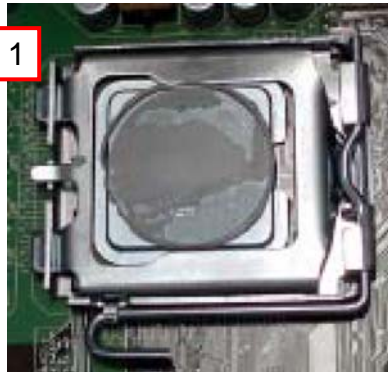

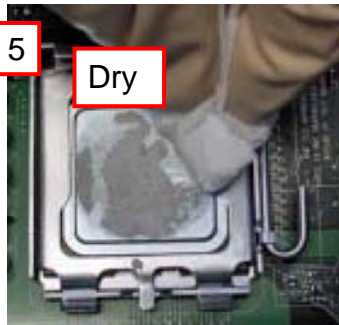

1. Remove the heatsink from the socket
2. Gently push loose thermal interface material (TIM) to center of processor (pictures 2 and 3)
3. Remove pieces with dry cloth (picture 4)
4. Wipe with dry, lint-free cloth to remove most of the material (picture 5)
5. Wet another lint-free cloth with isopropyl alcohol (IPA) and wipe to clean remaining material (picture 6)
6. Be careful to remove material from gaps between processor and load plate
7. For thermal grease removal use Step 4-6

TIM and Grease Removal from Heat-sink

Note: Remove and replace the TIM from the heatsink if you are re-using the heatsink on a new processor

1. Use dry, lint-free cloth and wipe package to remove most of the material
2. Wet another lint-free cloth with isopropyl alcohol (IPA) and wipe heatsink to clean remaining material



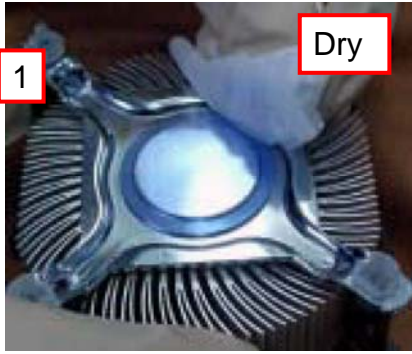

Replacing Damaged Fasteners

- To prevent damage, avoid setting the thermal solution with the prongs down
 - Set on heatsink side or with fan down
- The plastic fasteners on the heatsink can be replaced.
 - Use Shop Intel to order spare fasteners
 - <http://www.shop-intel.com>
- To remove a damaged fastener

Note: Protective gloves are not required for this procedure

- Rotate the black pin counterclockwise until it “snaps”. There will be some resistance
- Remove the black pin from the white prong
- Tilt the white prong to remove it from the heatsink leg

Avoid damage, avoid placing prongs on hard surface

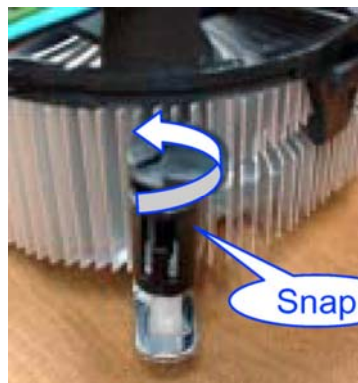

Damaged. Attempts to straighten not recommended





Replacing Fasteners

- To **replace** the fastener
 - Start with the white prong
 - Note the “keying” notch feature
 - Tilt the prong to insert into the heatsink leg.
 - Holding the white prong without bending it, push the black pin on from the bottom until you hear a single “click”

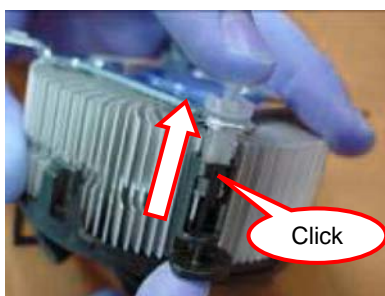
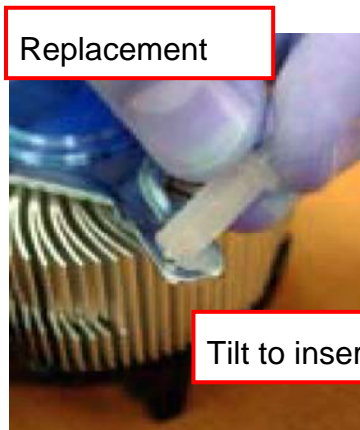

Note: The black pin and white prong will only “snap” on in one orientation

- Check to ensure the black pin is rotated properly for installation with the slot perpendicular to the heat sink

2-4 Install Memory

This motherboard provides two 240-pin DDR2 DUAL INLINE MEMORY MODULES (DIMM) sockets for DDR2 memory expansion available from minimum memory volume of 128MB to maximum memory volume of 2.0GB DDR2 SDRAM.

Valid Memory Configurations

Bank	240-Pin DIMM	PCS	Total Memory
Bank 0, 1 (DIMM1)	DDR2 400 / DDR2 533 / DDR2 667	X1	128MB~1.0GB
Bank 2, 3 (DIMM2)	DDR2 400 / DDR2 533 / DDR2 667	X1	128MB~1.0GB
Total	Memory (Max. 2.0GB)	2	128MB~2.0GB

Recommend DIMM Module Combination

1. One DIMM Module ----Plug in DIMM1
2. Two DIMM Modules---Plug in DIMM1 and DIMM3 for Dual channel function

For Dual channel Limited!

3. Dual channel function only supports when 2 DIMM Modules plug in either both DIMM1 & DIMM3.
4. DIMM1 & DIMM3 must be the same type, same size, same frequency for dual channel function.

Install DDR2 SDRAM modules to your motherboard is not difficult, you can refer to figure below to see how to install a 240-Pin DDR2 400 / DDR2 533 / DDR2 667 SDRAM module.

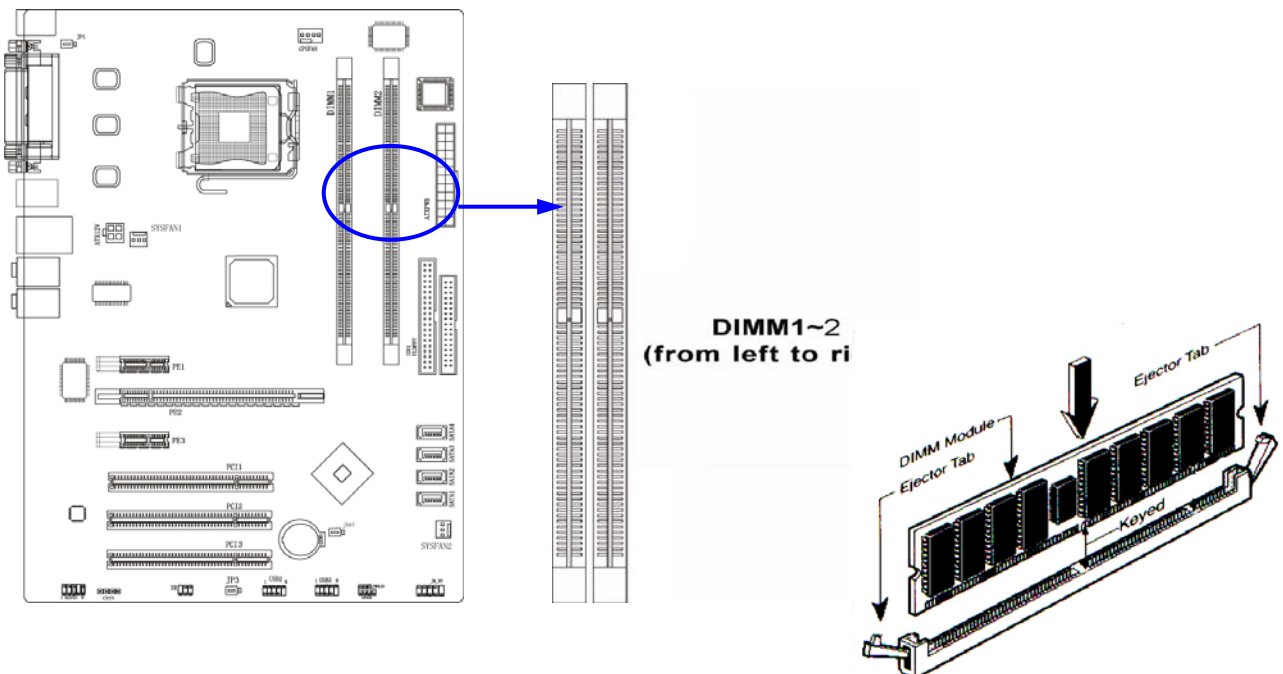

NOTE!

Intel 945PL Express Chipset supports dual channel DDR2 533 compliant. system memory at DDR SDRAM clock of 266MHz only.

NOTE! When you install DIMM module fully into the DIMM socket the eject tab should be locked into the DIMM module very firmly and fit into its indentation on both sides.

WARNING! For the DDR SDRAM CLOCK is set at 333 MHz, use only DDR2 667 compliant DDR2 Modules. When this motherboard operate at 333Mhz, most system will not even boot if non-compliant modules are used because of the strict timing issues, if your DDR Modules are not DDR2 667-compliant, set the SDRAM clock to 133MHz to ensure system stability.

2-5 Expansion Cards

WARNING! Turn off your PC while adding or removing expansion cards or other system components. Failure to do so may cause severe damage to both your motherboard and expansion cards.

2-5-1 Procedure For Expansion Card Installation

1. Read the documentation for your expansion card and make any necessary hardware or software setting for your expansion card such as jumpers.
2. Remove your computer's cover and the bracket plate on the slot you intend to use.
3. Align the card's connectors and press firmly.
4. Secure the card on the slot with the screen you remove above.
5. Replace the computer system's cover.
6. Set up the BIOS if necessary.
7. Install the necessary software driver for your expansion card.

2-5-2 Assigning IRQs For Expansion Card

Some expansion cards need an IRQ to operate. Generally, an IRQ must exclusively assign to one use. In a standard design, there are 16 IRQs available but most of them are already in use.

Standard Interrupt Assignments

IRQ	Priority	Standard function
0	N/A	System Timer
1	N/A	Keyboard Controller
2	N/A	Programmable Interrupt
3 *	8	Communications Port (COM2)
4 *	9	Communications Port (COM1)
5 *	6	Sound Card (sometimes LPT2)
6 *	11	Floppy Disk Controller
7 *	7	Printer Port (LPT1)
8	N/A	System CMOS/Real Time Clock
9 *	10	ACPI Mode when enabled
10 *	3	IRQ Holder for PCI Steering
11 *	2	IRQ Holder for PCI Steering
12 *	4	PS/2 Compatible Mouse Port
13	N/A	Numeric Data Processor
14 *	5	Primary IDE Channel
15 *	1	Secondary IDE Channel

* These IRQs are usually available for ISA or PCI devices.

2-5-3 Interrupt Request Table For This Motherboard

Interrupt request are shared as shown the table below:

	INT A	INT B	INT C	INT D	INT E	INT F	INT G	INT H
Slot 1	√							
Slot 2		√						
Slot 3			√					
Onboard LAN					√			
Onboard USB 2				√				
Onboard USB 3			√					
Sound		√						

IMPORTANT!

If using PCI cards on shared slots, make sure that the drivers support “Shared IRQ” or that the cards don’t need IRQ assignments. Conflicts will arise between the two PCI groups that will make the system unstable or cards inoperable.

2-5-4 PCI Express Slot

The motherboard offers one PCI-Express x16 graphics slot of 4Gbyte/sec data transfer rate at each relative direction which get 3.5 times of bandwidth more than AGP8X and it’s up to a peak concurrent bandwidth of 8Gbyte/sec at full speed to guarantee the fully operational GPU graphics power. Three 32-bit PCI slots guarantee the rich connectivity for the I/O peripheral devices. Two PCI Express x1 I/O slot offers 512Mbyte/sec concurrently, over 3.5 times more bandwidth than PCI at 133Mbyte/sec, tackling the most demanding multimedia tasks nowadays.

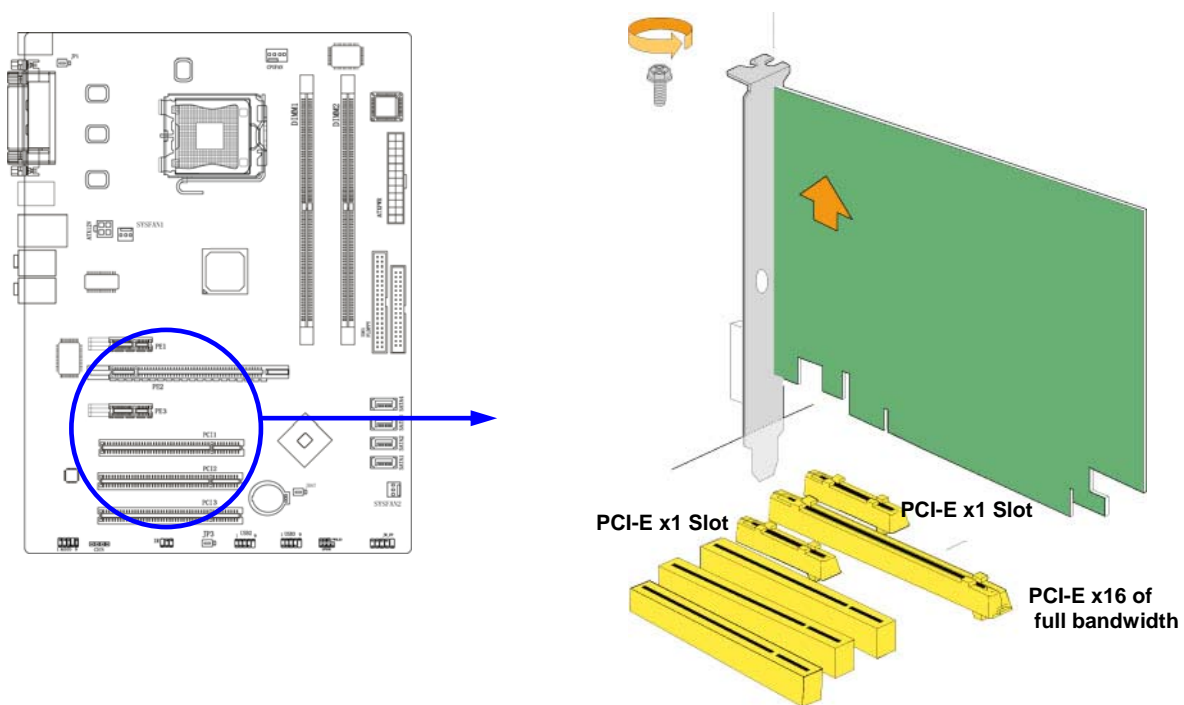

2-6 Connectors, Headers

2-6-1 Connectors

(1) Power Connector (24-pin block) : ATXPWR24P

ATX Power Supply connector. This is a new defined 24-pins connector that usually comes with ATX case. The ATX Power Supply allows to use soft power on momentary switch that connect from the front panel switch to 2-pins Power On jumper pole on the motherboard. When the power switch on the back of the ATX power supply turned on, the full power will not come into the system board until the front panel switch is momentarily pressed. Press this switch again will turn off the power to the system board.

- ** We recommend that you use an ATX 12V Specification 2.0-compliant power supply unit (PSU) with a minimum of 350W power rating. This type has 24-pin and 4-pin power plugs.
- ** If you intend to use a PSU with 20-pin and 4-pin power plugs, make sure that the 20-pin power plug can provide at least 15A on +12V and the power supply unit has a minimum power rating of 350W. The system may become unstable or may not boot up if the power is inadequate.

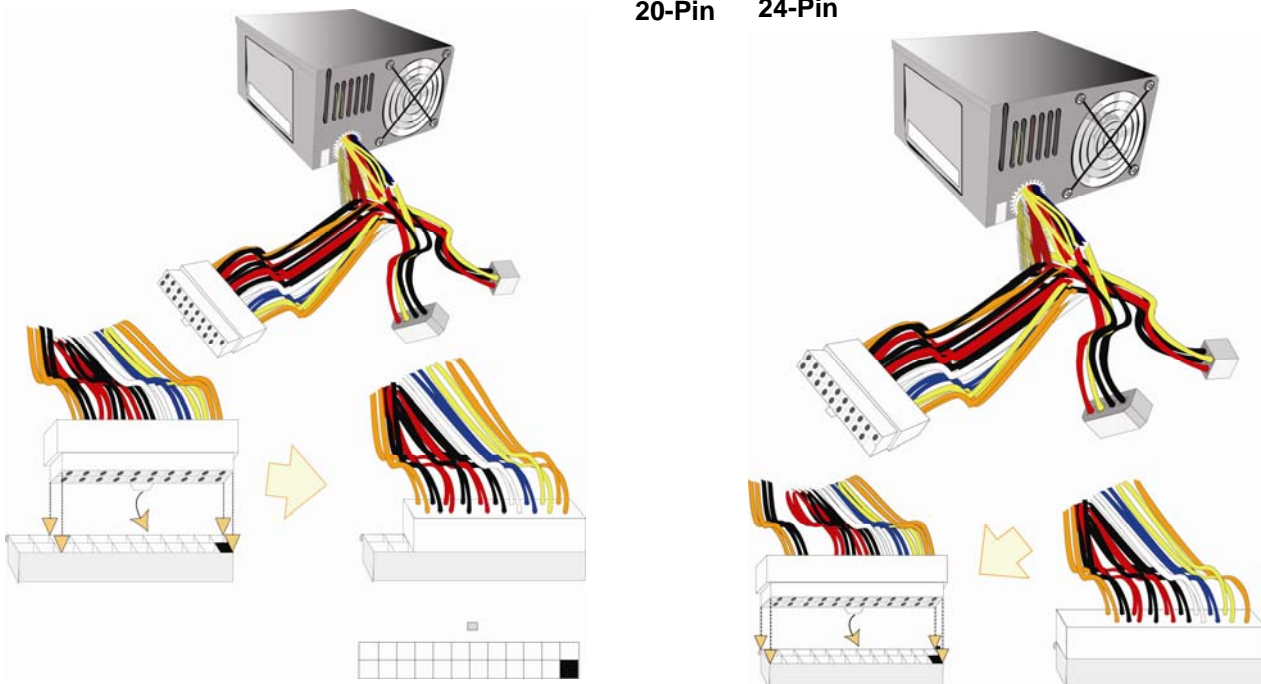
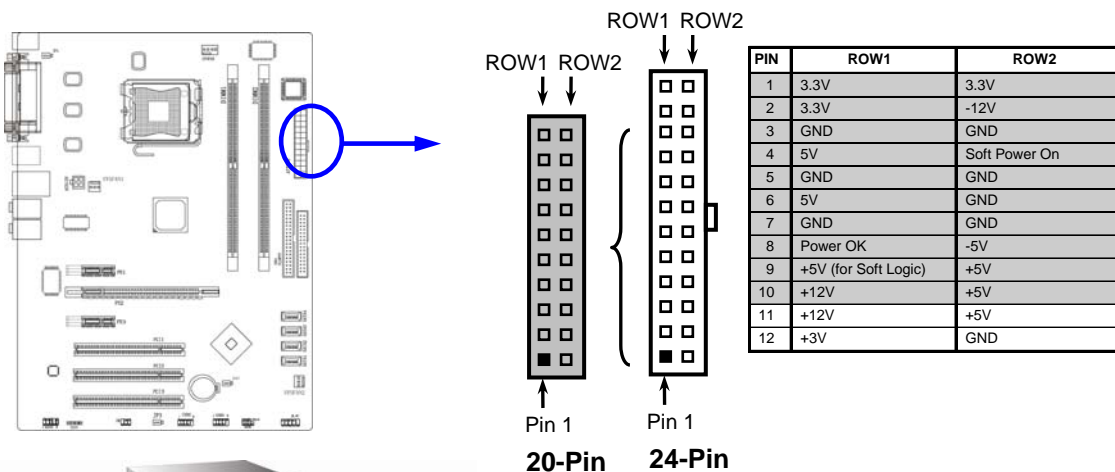

(2) **ATX 12V Power Connector (4-pin block) : ATX12V**

This is a new defined 4-pins connector that usually comes with ATX Power Supply. The ATX Power Supply which fully support Pentium 4 processor must including this connector for support extra 12V voltage to maintain system power consumption. Without this connector might cause system unstable because the power supply can not provide sufficient current for system.

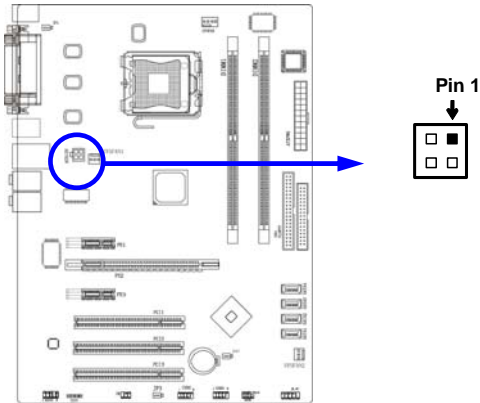

(3) **USB Port connector: USB1**

The connectors are 4-pin connector that connect USB devices to the system board.

(4) **LAN Port connector: UL1**

This connector is standard RJ45 over USB connector.

(5) **PS/2 Mouse & PS/2 Keyboard Connector: KB1 (PS2 KB/MOUSE)**

The connectors for PS/2 keyboard and PS/2 Mouse.

(6) **Parallel Port Connector (25-pin female): PARALLEL**

Parallel Port connector is a 25-pin D-Subminiature Receptacle connector. The On-board Parallel Port can be disabled through the BIOS SETUP. Please refer to Chapter 3 “INTEGRATED PERIPHERALS SETUP” section for more detail information.

(7) **SPDIF In/Out Connector: SPDIF_IN/OUT**

The SPDIF output is capable of providing digital audio to external speakers or compressed AC3 data to an external Dolby digital decoder. Use this feature only when your stereo system has digital input function. Use SPDIF IN feature only when your device has digital output function.

(8) **Audio Line-In, Lin-Out, MIC, Surrback, Surround, GEN/LEF Connector : PHONE_JACK**

This Connector are 6 phone Jack for LINE-OUT, LINE-IN, MIC, Surrback, Surround, GEN/LEF

Line-out : (GREEN)	Audio output to speaker
Line-in : (BLUE)	Audio input to sound chip
MIC : (PINK)	Microphone Connector
Surrback : (ORANGE)	Audio output to speaker-Rear speaker out
CEN / LFE : (BLACKNESS)	Audio output to speaker-Center/Subwoofer speaker out
Surround: (GRAY)	Audio output to speaker-Side speaker out

(9) Serial Port COM2

COM2 is the 9-pin D-Subminiature male connector. The On-board serial port can be disabled through BIOS SETUP. Please refer to Chapter 3 “INTEGRATED PERIPHERALS SETUP” section for more detail information.

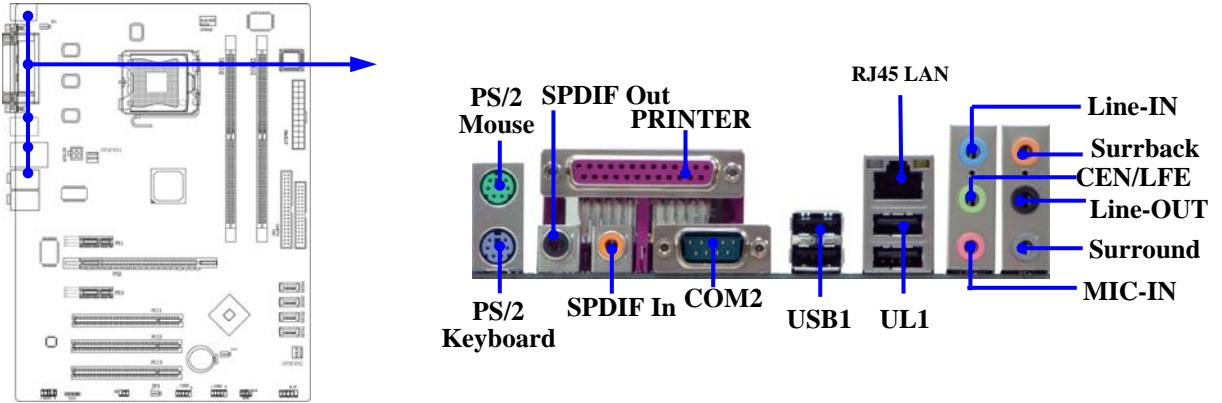

(10) Floppy drive Connector (34-pin block): FDD

This connector supports the provided floppy drive ribbon cable. After connecting the single plug end to motherboard, connect the two plugs at other end to the floppy drives.

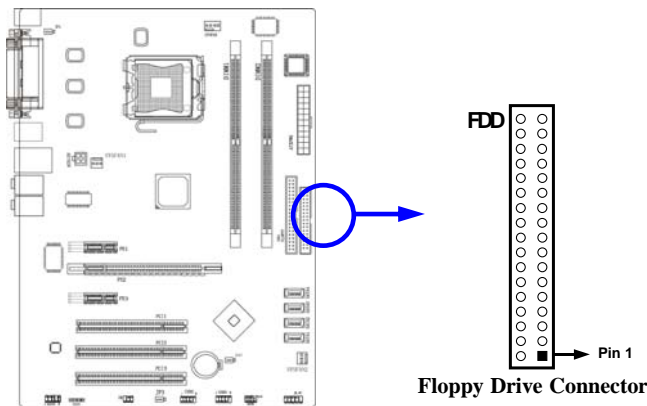

(11) Ultra ATA100 IDE Connector (40-pin block): IDE1 (Support ATA 100)

This connector supports the provided IDE hard disk ribbon cable. After connecting the single plug end to motherboard, connect the two plugs at other end to your hard disk(s). If you install two hard disks, you must configure the second drive to Slave mode by setting its jumpers accordingly. Please refer to the documentation of your hard disk for the jumper settings.

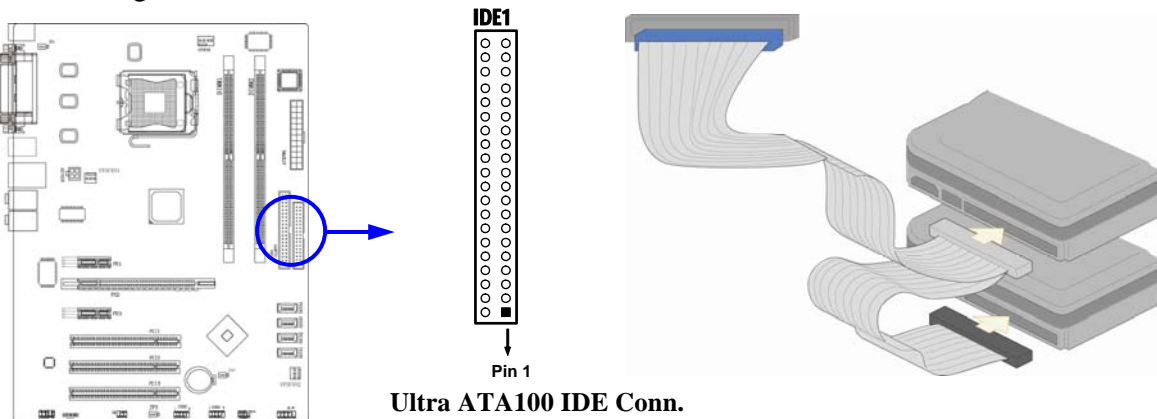

- Two hard disks can be connected to each connector. The first HDD is referred to as the “Master” and the second HDD is referred to as the “Slave”.
- For performance issues, we strongly suggest you don’t install a CD-ROM or DVD-ROM drive on the same IDE channel as a hard disk. Otherwise, the system performance on this channel may drop.

(12) Serial-ATA2 Port connector: SATA1/SATA2/SATA3/SATA4

This connector supports the provided Serial ATA2 IDE hard disk cable connect to the motherboard and serial ATA hard disk.

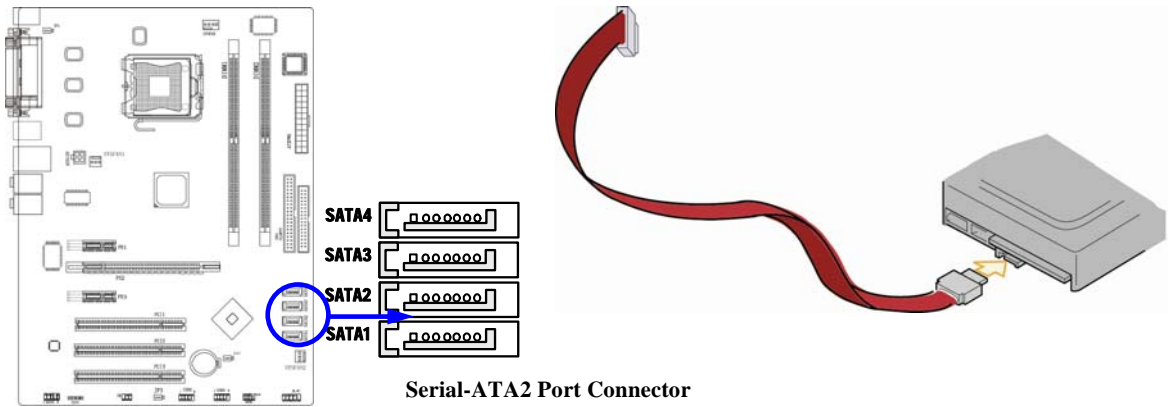

2-6-2 Headers

(1) Line-Out, MIC Header (9-pin): AUDIO

This header connect to Front Panel Line-out, MIC connector with cable.

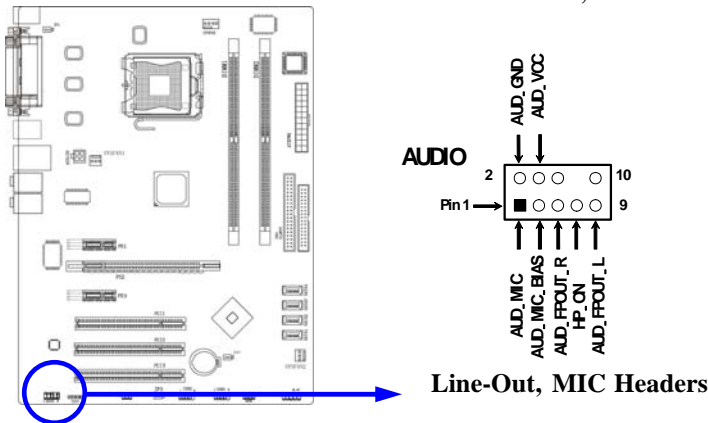

(2) USB Port Headers (9-pin) : USB2, USB3

The header is used for connecting the additional USB port plug. By attaching an option USB cable, you can be provided with two additional USB plugs affixed to the back panel.

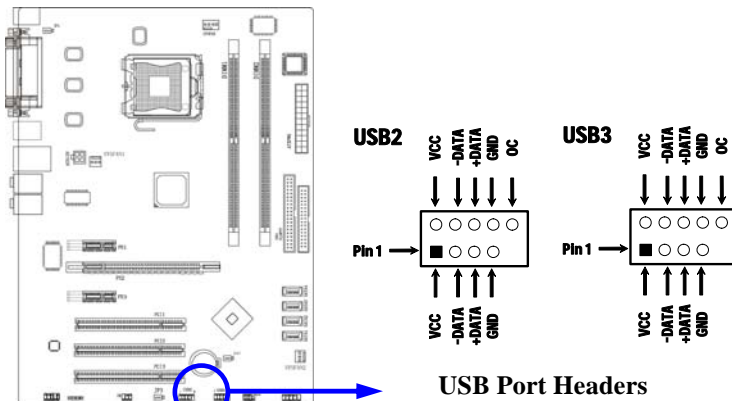

(3) IDE Activity LED: IDE LED

This connector connects to the hard disk activity indicator light on the case.

(4) Reset switch led: RESET

This 2-pin connector connects to the case-mounted reset switch for rebooting your computer without having to turn off your power switch. This is a preferred method of rebooting in order to prolong the life of the system's power supply. See the figure below.

(5) Power LED: PWR-LED

The Power LED is light on while the system power is on. Connect the Power LED from the system case to this pin.

(6) Speaker connector: SPEAK

This 4-pin connector connects to the case-mounted speaker. See the figure below.

(7) Power switch: PWR BTN

This 2-pin connector connects to the case-mounted power switch to power ON/OFF the system.

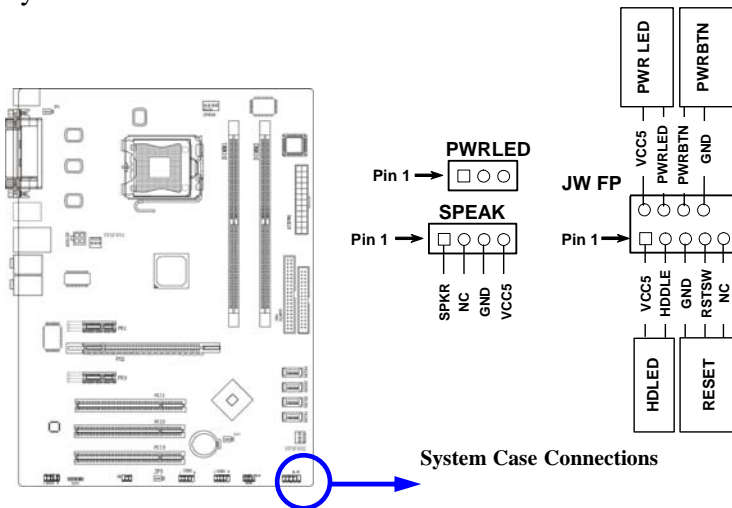

(8) FAN Power Headers: SYSFAN1, SYSFAN2 (3-pin), CPUFAN (4-pin)

These connectors support cooling fans of 350mA (4.2 Watts) or less, depending on the fan manufacturer, the wire and plug may be different. The red wire should be positive, while the black should be ground. Connect the fan's plug to the board taking into consideration the polarity of connector.

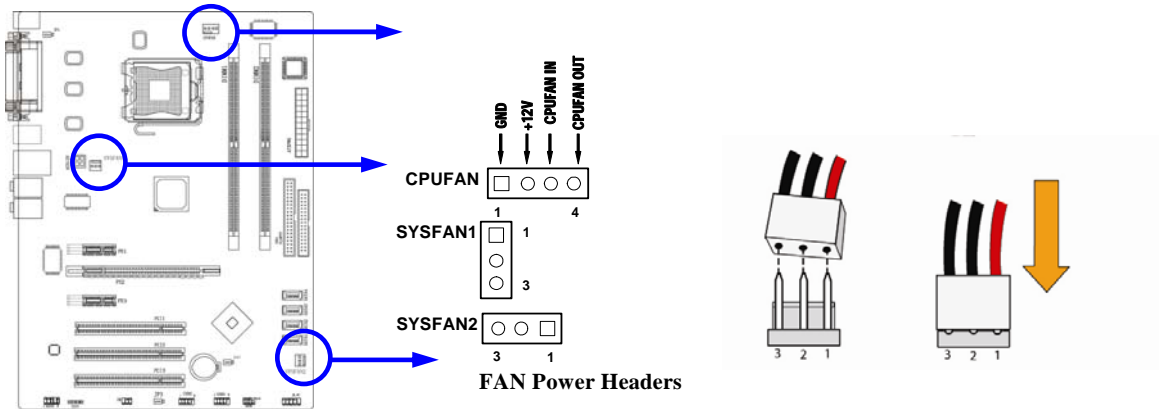

(9) IR infrared module Headers (5-pin) : IR

This connector supports the optional wireless transmitting and receiving infrared module. You must configure the setting through the BIOS setup to use the IR function.

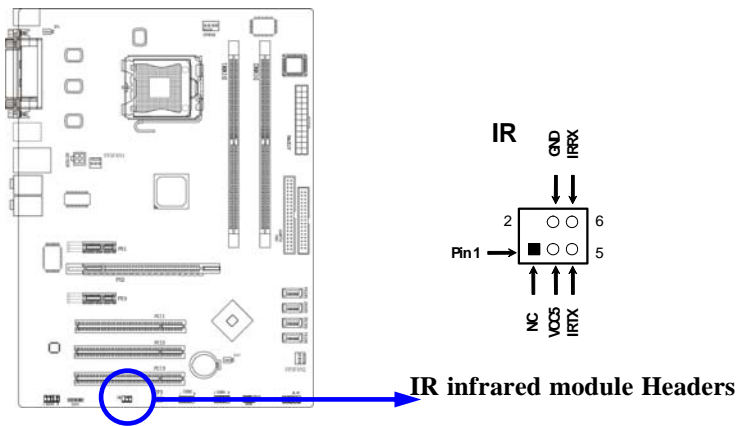

(10) CD Audio-In Headers (4-pin) : CDIN

CDIN are the connectors for CD-Audio Input signal. Please connect it to CD-ROM CD-Audio output connector.

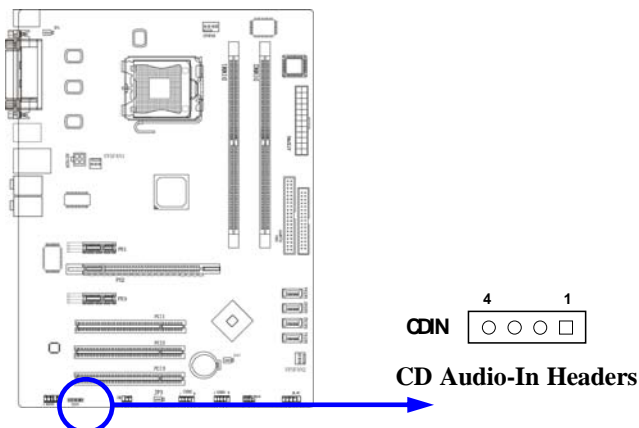

2-7 Starting Up Your Computer

1. After all connection are made, close your computer case cover.
2. Be sure all the switch are off, and check that the power supply input voltage is set to proper position, usually in-put voltage is 220V~240V or 110V~120V depending on your country's voltage used.
3. Connect the power supply cord into the power supply located on the back of your system case according to your system user's manual.
4. Turn on your peripheral as following order:
 - a. Your monitor.
 - b. Other external peripheral (Printer, Scanner, External Modem etc...)
 - c. Your system power. For ATX power supplies, you need to turn on the power supply and press the ATX power switch on the front side of the case.
5. The power LED on the front panel of the system case will light. The LED on the monitor may light up or switch between orange and green after the system is on. If it complies with green standards or if it is has a power standby feature. The system will then run power-on test. While the test are running, the BIOS will alarm beeps or additional message will appear on the screen. If you do not see any thing within 30 seconds from the time you turn on the power. The system may have failed on power-on test. Recheck your jumper settings and connections or call your retailer for assistance.

Beep	Meaning
One short beep when displaying logo	No error during POST
Long beeps in an endless loop	No DRAM install or detected
One long beep followed by three short beeps	Video card not found or video card memory bad
High frequency beeps when system is working	CPU overheated System running at a lower frequency

6. During power-on, press <Delete> key to enter BIOS setup. Follow the instructions in BIOS SETUP.
7. **Power off your computer:** You must first exit or shut down your operating system before switch off the power switch. For ATX power supply, you can press ATX power switching after exiting or shutting down your operating system. If you use Windows 9X, click "**Start**" button, click "**Shut down**" and then click "**Shut down the computer?**" The power supply should turn off after windows shut down.

Chapter 3

Introducing BIOS

The BIOS is a program located on a Flash Memory on the motherboard. This program is a bridge between motherboard and operating system. When you start the computer, the BIOS program gain control. The BIOS first operates an auto-diagnostic test called POST (power on self test) for all the necessary hardware, it detects the entire hardware device and configures the parameters of the hardware synchronization. Only when these tasks are completed done it gives up control of the computer to operating system (OS). Since the BIOS is the only channel for hardware and software to communicate, it is the key factor for system stability, and in ensuring that your system performance as its best.

In the BIOS Setup main menu of Figure 3-1, you can see several options. We will explain these options step by step in the following pages of this chapter, but let us first see a short description of the function keys you may use here:

- Press <Esc> to quit the BIOS Setup.
- Press ↑↓←→ (up, down, left, right) to choose, in the main menu, the option you want to confirm or to modify.
- Press <F10> when you have completed the setup of BIOS parameters to save these parameters and to exit the BIOS Setup menu.
- Press Page Up/Page Down or +/- keys when you want to modify the BIOS parameters for the active option.

3-1 Entering Setup

Power on the computer and by pressing immediately allows you to enter Setup.

If the message disappears before your respond and you still wish to enter Setup, restart the system to try again by turning it OFF then ON or pressing the “RESET” button on the system case. You may also restart by simultaneously pressing <Ctrl>, <Alt> and <Delete> keys. If you do not press the keys at the correct time and the system does not boot, an error message will be displayed and you will again be asked to

Press <F1> to continue, <Ctrl-Alt-Esc> or to enter Setup

3-2 Getting Help

Main Menu

The on-line description of the highlighted setup function is displayed at the bottom of the screen.

Status Page Setup Menu/Option Page Setup Menu

Press F1 to pop up a small help window that describes the appropriate keys to use and the possible selections for the highlighted item. To exit the Help Window, press <Esc>.

3-3 The Main Menu

Once you enter Award® BIOS CMOS Setup Utility, the Main Menu (Figure 3-1) will appear on the screen. The Main Menu allows you to select from fourteen setup functions and two exit choices. Use arrow keys to select among the items and press <Enter> to accept or enter the sub-menu.

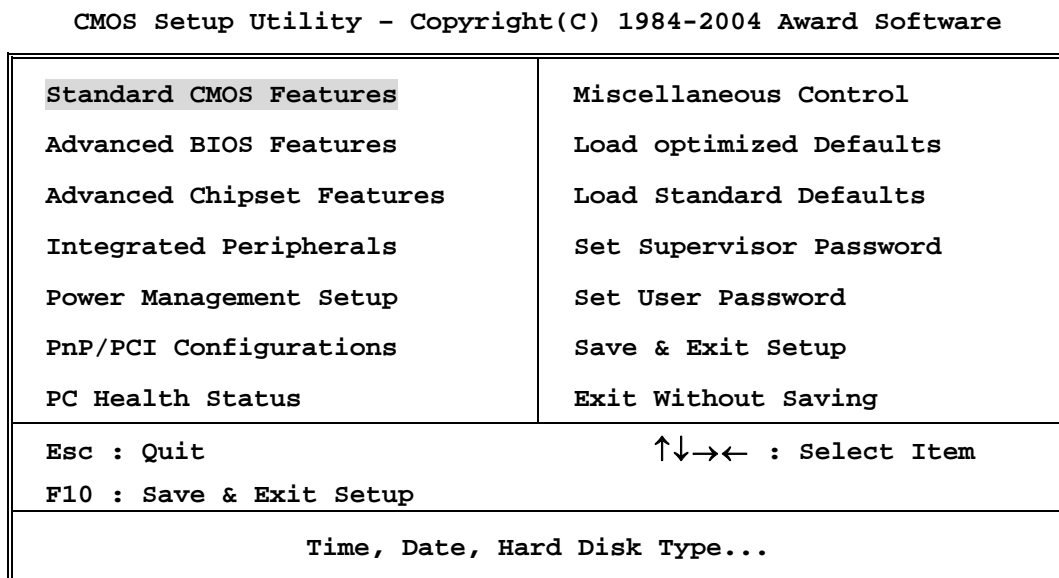

Figure 3-1

Standard CMOS Features

Use this Menu for basic system configurations.

Advanced BIOS Features

Use this menu to set the Advanced Features available on your system.

Advanced Chipset Features

Use this menu to change the values in the chipset registers and optimize your system's performance.

Integrated Peripherals

Use this menu to specify your settings for integrated peripherals.

Power Management Setup

Use this menu to specify your settings for power management.

PnP/PCI configurations

This entry appears if your system supports PnP/PCI.

PC Health Status

This entry shows your PC health status.

Miscellaneous Control

Use this menu to specify your settings for Miscellaneous control.

Load Optimized Defaults

Use this menu to load the BIOS default values that are settings for optimal performances system operations.

Load Standard Defaults

Use this menu to load the BIOS default values that are factory settings for the stable performance system operation.

Set Supervisor/User Password

Use this menu to set User and Supervisor Passwords.

Save & Exit Setup

Save CMOS value changes to CMOS and exit setup.

Exit Without Saving

Abandon all CMOS value changes and exit setup.

3-4 Standard CMOS Features

The items in Standard CMOS Setup Menu are divided into several categories. Each category includes no, one or more than one setup items. Use the arrow keys to highlight the item and then use the <PgUp> or <PgDn> keys to select the value you want in each item.

Phoenix - AwardBIOS CMOS Setup Utility
Standard CMOS Features

Date (mm:dd:yy)	Mon, Feb, 13 2006	Item Help
Time (hh:mm:ss)	11 : 02 : 35	
> IDE Channel 0 Master	None	Menu Level > Change the day, month, year and century
> IDE Channel 0 Slave	None	
> IDE Channel 1 Master	None	
> IDE Channel 1 Slave	None	
Drive A	1.44M, 3.5 in.	
Video	EGA/VGA	
Halt On	All Errors	
Base Memory	640K	
Extended Memory	56320K	
Total Memory	57344K	
↑↓→← Move Enter:Select +/-/PU/PD:Value F10:Save ESC:Exit F1:General Help F5:Previous Values F6:Optimized Defaults F7:Standard Defaults		

Date

The date format is <day><month><date><year>.

Day Day of the week, from Sun to Sat, determined by BIOS. Read-only.

Month The month from Jan. through Dec.

Date The date from 1 to 31 can be keyed by numeric function keys.

Year The year depends on the year of the BIOS.

Time

The time format is <hour><minute><second>.

IDE Channel 0 Master / Channel 0 Slave / Channel 1 Master / Channel 1 Slave

SATA Channel 1, 2, 3, 4

Press PgUp/<+> or PgDn/<-> to select Manual, None, Auto type. Note that the specifications of your drive must match with the drive table. The hard disk will not work properly if you enter improper information for this category. If the type of hard disk drives is not matched or listed, you can use Manual to define your own drive type manually.

If you select Manual, related information is asked to be entered to the following items. Enter the information directly from the keyboard. This information should be provided in the documentation from your hard disk vendor or the system manufacturer.

If the controller of HDD interface is SCSI, the selection shall be "None".

If the controller of HDD interface is CD-ROM, the selection shall be "None"

Access Mode The settings are Auto Normal, Large, and LBA.

Cylinder number of cylinders

Head number of heads

Precomp write precomp

Landing Zone landing zone

Sector number of sectors

3-5 Advanced BIOS Features

Phoenix - AwardBIOS CMOS Setup Utility

Advanced BIOS Features

Virus Warning	Disabled	Item Help	
CPU L1 & L2 Cache	Enabled		
CPU L3 Cache	Enabled	Menu Level >	
Limit CPUID MaxVal	Disabled		
C1E Function	Auto		
Execute Disable Bit	Enabled		
Hard Disk Boot Priority	Press Enter		
Hyper Threading Technology	Enabled		
Quick Power On Self Test	Enabled		
First Boot Device	Floppy		
Second Boot Device	Hard Disk		
Third Boot Device	CDROM		
Boot other Device	Enabled		
Boot Up Floppy Seek	Enabled		
Boot Up NumLock Status	On		
Typematic Rate Setting	Disabled		
Typematic Rate (Chars/Sec)	6		
Typematic Delay (Msec)	250		
Security Option	Setup		
APIC Mode	Enabled		
MPS Version Control For OS	1.4		
OS Select For DRAM > 64MB	Non-OS2		
HDD S.M.A.R.T Capability	Disabled		
Report No FDD For Windows	Yes		
↑↓→← Move Enter:Select +/-/PU/PD:Value F10:Save ESC:Exit F1:General Help F5:Previous Values F6:Optimized Defaults F7:Standard Defaults			

Virus Warning

Allows you to choose the VIRUS Warning feature for IDE Hard Disk boot sector protection. If this function is enabled and someone attempt to write data into this area, BIOS will show a warning message on screen and alarm beep.

Disabled (default) No warning message to appear when anything attempts to access the boot sector or hard disk partition table.

Enabled Activates automatically when the system boots up causing a warning message to appear when anything attempts to access the boot sector of hard disk partition table.

CPU L1&L2 Cache

The default value is Enabled.

Enabled (default) Enable cache

Disabled Disable cache

Note: The L1&L2 cache is built in the processor.

Hard Disk Boot Priority

The selection is for you to choose the hard disk drives priorities to boot from.

Quick Power On Self Test

This category speeds up Power On Self Test (POST) after you power on the computer. If this is set to Enabled. BIOS will shorten or skip some check items during POST.

Enabled (default) Enable quick POST

Disabled Normal POST

First/Second/Third Boot Device

The BIOS attempts to load the operating system from the devices in the sequence selected in these items. The settings are Removable, Hard Disk, CDROM, Legacy LAN, CDROM and Disabled.

Boot Up Floppy Seek

During POST, BIOS will determine if the floppy disk drive installed is 40 or 80 tracks. 360K type is 40 tracks while 760K, 1.2M and 1.44M are all 80 tracks.

Boot Up NumLock Status

The default value is On.

On (default) Keypad is numeric keys.

Off Keypad is arrow keys.

Gate A20 Option

Normal The A20 signal is controlled by keyboard controller or chipset hardware.

Fast (default) The A20 signal is controlled by port 92 or chipset specific method.

Typematic Rate Setting

Keystrokes repeat at a rate determined by the keyboard controller. When enabled, the typematic rate and typematic delay can be selected. The settings are: Enabled/Disabled.

Typematic Rate (Chars/Sec)

Sets the number of times a second to repeat a keystroke when you hold the key down. The settings are: 6, 8, 10, 12, 15, 20, 24, and 30.

Typematic Delay (Msec)

Sets the delay time after the key is held down before it begins to repeat the keystroke. The settings are 250, 500, 750, and 1000.

Security Option

This category allows you to limit access to the system and Setup, or just to Setup.

- System** The system will not boot and access to Setup will be denied if the correct password is not entered at the prompt.
- Setup (default)** The system will boot, but access to Setup will be denied if the correct password is not entered prompt.

APIC MODE

This field is used to enable or disable the APIC(Advanced Programmable Interrupt Controller). Due to compliance with PC2004 design guide, the system is able to run in APIC mode. Enabling APIC mode will expand available IRQ resources for the system. Settings:[Enabled] and [disabled].

MPS Version Control For OS

This field allows you to select which MPS(Multi-Processor Specification) version to be used for the operating system. You need to select the MPS version supported by your operating system. To find out which version to use, Consult the vendor of your operating system. Settings:[1.4],[1.1] .

OS Select For DRAM > 64MB

Allows OS2[®] to be used with >64MB or DRAM. Settings are Non-OS/2 (default) and OS2. Set to OS/2 if using more than 64MB and running OS/2.

3-6 Advanced Chipset Features

The Advanced Chipset Features Setup option is used to change the values of the chipset registers. These registers control most of the system options in the computer.

Phoenix - AwardBIOS CMOS Setup Utility
Advanced Chipset Features

DRAM Timing Selectable	By SPD	Item Help
SDRAM CAS Latency Time	Auto	
SDRAM Cycle Time	Auto	
SDRAM RAS-to CAS Delay	Auto	
SDRAM RAS Precharge Time	Auto	
System BIOS Cacheable	Disabled	
Video BIOS Cacheable	Disabled	
Memory Hole at 15M-16M	Disabled	
> PCIExpress Root Port Function Press Enter		
** VGA Setting **		
PEG/Onchip VGA Control	Auto	
PEG Force X1	Disabled	
On-Chip Frame Buffer Size	32MB	
FIXED Memory Size	64MB	
DVMT Memory Size	64MB	
↑↓→← Move Enter:Select +/-/PU/PD:Value F10:Save ESC:Exit F1:General Help F5:Previous Values F6:Optimized Defaults F7:Standard Defaults		

SDRAM RAS-to-CAS Delay

This field let's you insert a timing delay between the CAS and RAS strobe signals, used when DRAM is written to, read from, or refreshed. *Fast* gives faster performance; and *Slow* gives more stable performance. This field applies only when synchronous DRAM is installed in the system. The settings are: 4T and 3T.

SDRAM RAS Precharge Time

If an insufficient number of cycles is allowed for the RAS to accumulate its charge before DRAM refresh, the refresh may be incomplete and the DRAM may fail to retain data. *Fast* gives faster performance; and *Slow* gives more stable performance. This field applies only when synchronous DRAM is installed in the system. The settings are: 2T and 3T.

PCIExpress Root Port Function

Please refer to section 3-6-1

System BIOS Cacheable

Selecting Enabled allows caching of the system BIOS ROM at F0000h-FFFFFh, resulting in better system performance. However, if any program writes to this memory area, a system error may result. The settings are: Enabled and Disabled.

Video BIOS Cacheable

Select Enabled allows caching of the video BIOS, resulting in better system performance. However, if any program writes to this memory area, a system error may result. The settings are: Enabled and Disabled.

Memory Hole At 15M-16M

You can reserve this area of system memory for ISA adapter ROM. When this area is reserved, it cannot be cached. The user information of peripherals that need to use this area of system memory usually discusses their memory requirements. The settings are: Enabled and Disabled.

3-6-1 PCIExpress Root Port Function

Phoenix - AwardBIOS CMOS Setup Utility

PCIExpress Root Port Function

PCIExpress Compliancy Mode v1.0a	Item Help
	Menu Level >>
↑↓→← Move Enter:Select +/-/PU/PD:Value F10:Save ESC:Exit F1:General Help F5:Previous Values F6:Optimized Defaults F7:Standard Defaults	

3-7 Integrated Peripherals

CMOS Setup Utility - Copyright(C) 1984-2004 Award Software

Integrated Peripherals

> Onboard IDE Function Press Enter > Onboard Device Function Press Enter > Onboard Super IO Function Press Enter Init Display First PCI Slot PWR Status After PWR Failure Always Off	Item Help
	Menu Level >
↑↓→← Move Enter:Select +/-/PU/PD:Value F10:Save ESC:Exit F1:General Help F5:Previous Values F6:Optimized Defaults F7:Standard Defaults	

Onboard IDE Function

Please refer to section 3-7-1

Onboard Device Function

Please refer to section 3-7-2

Onboard Super IO Function

Please refer to section 3-7-3

Init Display First

This item allows you to decide to activate whether PCI Slot or AGP VGA first. The settings are: PCI Slot, AGP Slot.

3-7-1 Onboard IDE Function

Phoenix - AwardBIOS CMOS Setup Utility

Onboard IDE Function

On-Chip Primary PCI IDE Enabled On-Chip Secondary PCI IDE Enabled IDE Primary Master PIO Auto IDE Primary Slave PIO Auto IDE Secondary Master PIO Auto IDE Secondary Slave PIO Auto IDE Primary Master UDMA Auto IDE Primary Slave UDMA Auto IDE Secondary Master UDMA Auto IDE Secondary Slave UDMA Auto SATA Port Speed Settings Disabled IDE DMA Transfer Access Enabled IDE HDD Block Mode Enabled *** On-Chip Serial ATA Setting **** On-Chip Serial ATA Auto PATA IDE Mode Primary SATA Port P2, P4 is Secondary SATA PORT Speed Settings Disabled	Item Help
	Menu Level >>
↑↓→← Move Enter:Select +/-/PU/PD:Value F10:Save ESC:Exit F1:General Help F5:Previous Values F6:Optimized Defaults F7:Standard Defaults	

OnChip Primary/Secondary PCI IDE

The integrated peripheral controller contains an IDE interface with support for two IDE channels. Select *Enabled* to activate each channel separately. The settings are: Enabled and Disabled.

IDE Primary/Secondary Master/Slave PIO

The four IDE PIO (Programmed Input/Output) fields let you set a PIO mode (0-4) for each of the four IDE devices that the onboard IDE interface supports. Modes 0 through 4 provide successively increased performance. In Auto mode, the system automatically determines the best mode for each device. The settings are: Auto, Mode 0, Mode 1, Mode 2, Mode 3, Mode 4.

IDE Primary/Secondary Master/Slave UDMA

Ultra DMA/33 implementation is possible only if your IDE hard drive supports it and the operating environment includes a DMA driver (Windows 95 OSR2 or a third-party IDE bus master driver). If your hard drive and your system software both support Ultra DMA/33 and Ultra DMA/66, select Auto to enable BIOS support. The settings are: Auto, Disabled.

IDE HDD Block Mode

Block mode is also called block transfer, multiple commands, or multiple sector read/write. If your IDE hard drive supports block mode (most new drives do), select Enabled for automatic detection of the optimal number of block read/writes per sector the drive can support. The settings are: Enabled, Disabled.

3-7-2 Onboard Device Function

Phoenix - AwardBIOS CMOS Setup Utility

Onboard Device Function

RealTek LAN Function	Enabled	Item Help
RealTek LAN BootROM	Disabled	
USB Host Controller	Enabled	Menu Level >>
USB2.0 Function	Enabled	
USB Keyboard Legacy Support	Disabled	
USB Mouse Legacy Support	Disabled	
AC'97 Audio	Auto	
↑↓→← Move Enter:Select +/-/PU/PD:Value F10:Save ESC:Exit F1:General Help F5:Previous Values F6:Optimized Defaults F7:Standard Defaults		

RealTek LAN Function

Setting to [Enabled] allows the BIOS to auto-detect the LAN controller and enable it. Setting options:[Enabled] and [Disabled] .

USB Host Controller

Select *Enabled* if your system contains a Universal Serial Bus (USB) controller and you have a USB peripherals. The settings are: Enabled, Disabled.

USB 2.0 Function

This setting allows you to enable/disable the onboard USB controller. Selecting [Enabled] enables the system to support USB 2.0 spec. setting options:[Disabled],[Enabled].

USB Keyboard Legacy Support

Select *Enabled* if your system contains a Universal Serial Bus (USB) controller and you have a USB keyboard. The settings are: Enabled, Disabled.

AC'97 Audio

The selection for you to choose the embedded Audio function or 3rd party audio interface installed. The settings are: Enabled, Disabled, and Auto.

3-7-3 Onboard Super IO Function

Phoenix - AwardBIOS CMOS Setup Utility

Onboard Super IO Function

Onboard FDD Controller	Enabled	Item Help
Onboard Serial Port 2	3F8/IRQ4	
UART2 Mode Select	Normal	Menu Level >>
IR Duplex Mode	Half	
Onboard Parallel Port	378/IRQ7	
Parallel Port Mode	SPP	
ECP Mode Use DMA	3	
↑↓→← Move Enter:Select +/-/PU/PD:Value F10:Save ESC:Exit F1:General Help F5:Previous Values F6:Optimized Defaults F7:Standard Defaults		

Onboard FDD Controller

Select Enabled if your system has a floppy disk controller (FDD) installed on the system board and you wish to use it. If you install add-on FDC or the system has no floppy drive, select Disabled in this field. The settings are: Enabled and Disabled.

Onboard Serial Port 2

Select an address and corresponding interrupt for the serial ports. The settings are: 3F8/IRQ4, 2E8/IRQ3, 3E8/IRQ4, 2F8/IRQ3, Disabled, and Auto.

UART2 Mode Select

This item allows you to determine which InfraRed(IR) function of the onboard I/O chip, this functions uses.

Onboard Parallel Port

There is a built-in parallel port on the on-board Super I/O chipset that Provides Standard, ECP, and EPP features. It has the following option:

Disabled

(3BCH/IRQ7)/ Line Printer port 0

(278H/IRQ5)/ Line Printer port 2

(378H/IRQ7) Line Printer port 1

Parallel Port Mode

SPP : Standard Parallel Port

EPP : Enhanced Parallel Port

ECP : Extended Capability Port

SPP/EPP/ECP/ECP+EPP

To operate the onboard parallel port as Standard Parallel Port only, choose "SPP." To operate the onboard parallel port in the EPP modes simultaneously, choose "EPP." By choosing "ECP", the onboard parallel port will operate in ECP mode only. Choosing "ECP+EPP" will allow the onboard parallel port to support both the ECP and EPP modes simultaneously. The ECP mode has to use the DMA channel, so choose the onboard parallel port with the ECP feature. After selecting it, the following message will appear: "ECP Mode Use DMA" at this time, the user can choose between DMA channels 3 to 1. The onboard parallel port is EPP Spec. compliant, so after the user chooses the onboard parallel port with the EPP function, the following message will be displayed on the screen: "EPP Mode Select." At this time either EPP 1.7 spec. or EPP 1.9 spec. can be chosen.

3-8 Power Management Setup

The Power Management Setup allows you to configure your system to most effectively save energy saving while operating in a manner consistent with your own style of computer use.

Phoenix - AwardBIOS CMOS Setup Utility

Power Management Setup

ACPI Function	<u>Enabled</u>	Item Help
Power Management	User Define	
Video off Method	V/H SYNC+Blank	
Video Off In Suspend	Yes	Menu Level >
Suspend Type	Stop Grant	
MODEM Use IRQ	3	
Suspend Mode	Disabled	
HDD Power Down	Disabled	
Soft-off by PWR-BTTN	Instant-off	
Wake-Up by PCI card	Disabled	
Power On by Ring	Disabled	
PS2 KB/MS Wake-up From S5	Disabled	
Resume by Alarm	Disabled	
X Date (of Month)Alarm	0	
X Time (hh:mm:ss)Alarm	0 : 0 :0	
> PM Timer Reload Events	Press Enter	
↑↓→← Move Enter:Select +/-/PU/PD=Value F10:Save ESC:Exit F1:General Help F5:Previous Values F6:Optimized Defaults F7:Standard Defaults		

ACPI Function

This item allows you to Enabled/Disabled the Advanced Configuration and Power Management (ACPI). The settings are Enabled and Disabled.

Video Off in Suspend

This determines the manner in which the monitor is blanked. The choice are Yes → Video will off , and No→ Video always On.

Video Off Method

This determines the manner in which the monitor is blanked.

DPMS (default) Initial display power management signaling.

Blank Screen This option only writes blanks to the video buffer.

V/H SYNC+Blank This selection will cause the system to turn off the vertical and horizontal synchronization ports and write blanks to the video buffer.

Modem Use IRQ

This determines the IRQ in which the MODEM can use.

The settings are: 3, 4, 5, 7, 9, 10, 11, NA.

Soft-off by PWR-BTTN

Pressing the power button for more than 4 seconds forces the system to enter the Soft-Off state.

The settings are: Delay 4 Sec, Instant-Off.

Power On by Ring

During Disabled, the system will ignore any incoming call from the modem. During Enabled, the system will boot up if there's an incoming call from modem.

Date(of month) Alarm

You can choose which month the system will boot up. Set to 0, to boot every day.

Time(hh:mm:ss) Alarm

You can choose what hour, minute and second the system will boot up.

Note: If you have change the setting, you must let the system boot up until it goes to the operating system, before this function will work

PM Timer Reload Events

Please refer to section 3-8-1

3-8-1 PM Timer Reload Events

Phoenix - AwardBIOS CMOS Setup Utility

PM Timer Reload Events

Primary IDE 0	Disabled	Item Help
Primary IDE 1	Disabled	Menu Level >>
Secondary IDE 0	Disabled	
Secondary IDE 1	Disabled	
FDD, COM, LPT Port	Disabled	
PCI PIRQ [A-D] #	Disabled	
↑↓→← Move Enter:Select +/-/PU/PD:Value F10:Save ESC:Exit F1:General Help F5:Previous Values F6:Optimized Defaults F7:Standard Defaults		

3-9 PnP/PCI Configuration Setup

This section describes configuring the PCI bus system. PCI, or Personal Computer Interconnect, is a system which allows I/O devices to operate at speeds nearing the speed the CPU itself uses when communicating with its own special components. This section covers some very technical items and it is strongly recommended that only experienced users should make any changes to the default settings.

CMOS Setup Utility - Copyright(C) 1984-2004 Award Software

PnP/PCI Configurations

x IRQ Resources	Press Enter	Item Help
PCI/VGA Palette Snoop	Disabled	Menu Level >
** PCI Express relative items**		
Maximum Payload Size	4069	
↑↓→← Move Enter:Select +/-/PU/PD:Value F10:Save ESC:Exit F1:General Help F5:Previous Values F6:Optimized Defaults F7:Standard Defaults		

IRQ Resources

When resources are controlled manually, assign each system interrupt a type, depending on the type of device using the interrupt.

Please refer to section 3-9-1

PCI/VGA Palette Snoop

Leave this field at *Disabled*. The settings are Enabled, Disabled.

3-9-1 IRQ Resources

CMOS Setup Utility - Copyright(C) 1984-2004 Award Software

IRQ Resources

IRQ-5	assigned to	PCI Device	Item Help
IRQ-7	assigned to	PCI Device	
IRQ-9	assigned to	PCI Device	Menu Level >>
IRQ-10	assigned to	PCI Device	
IRQ-11	assigned to	PCI Device	
IRQ-12	assigned to	PCI Device	
IRQ-14	assigned to	PCI Device	
IRQ-15	assigned to	PCI Device	
↑↓→← Move Enter:Select +/-/PU/PD:Value F10:Save ESC:Exit F1:General Help F5:Previous Values F6:Optimized Defaults F7:Standard Defaults			

3-10 PC Health Status

This section shows the Status of you CPU, Fan, Warning for overall system status. This is only available if there is Hardware Monitor onboard.

Phoenix - AwardBIOS CMOS Setup Utility

PC Health Status

Shutdown Temperature	<u>Disabled</u>	Item Help
Show PC Health in Post	Enabled	
CPU Thermal-Throttling	Disable	Menu Level >
CPU Thermal-Throttling Temp	70	
CPU Thermal-throttling Duty	50.00%	
CPU Thermal-throttling Beep	Enabled	
> Smart FAN Configurations	Press Enter	
Vcore	1.52V	
Vccl.5V	1.5V	
+5	4.96V	
+12	12.36V	
5VSB	5.04V	
VDIMM	1.77V	
3VSB	3.40V	
Vbat	3.31V	
CPU Temperature	39°C/102°F	
System Temperature	23°C/73°F	
CPUFAN	3667 RPM	
SFAN 1	0 RPM	
SFAN 2	0 RPM	
↑↓→← Move Enter:Select +/-/PU/PD:Value F10:Save ESC:Exit F1:General Help F5:Previous Values F6:Optimized Defaults F7:Standard Defaults		

Shutdown Temperature

This item can let users setting the Shutdown temperature, when CPU temperature over this setting the system will auto shutdown to protect CPU.

Show PCHealth in Post

During Enabled, it displays information list below. The choice is either Enabled or Disabled.

Smart FAN Configurations

Please refer to section 3-10-1

Current CPU Temperature/Current System Temp/CurrentSFAN1,SFAN2 Speed/Vcore/VCC/ +5V/+12V/VBAT(V)/3VSB(V)

This will show the CPU/FAN/System voltage chart and FAN Speed.

3-10-1 Smart FAN Configurations

Phoenix - AwardBIOS CMOS Setup Utility

Smart FAN Configurations

CPUFAN Smart Mode	Disabled	Item Help
XCPUFAN Full-Speed Temp	50	Menu Level >
XCPUFAN Idle Temp	30	
↑↓→← Move Enter:Select +/-/PU/PD:Value F10:Save ESC:Exit F1:General Help F5:Previous Values F6:Optimized Defaults F7:Standard Defaults		

CPUFAN Full-Speed Temp

This item allows you setting the FAN works in full speed when the temperature over the value which out set. If the temperature below the value but over the Idle Temperature, the FAN will works over 60% of full speed, and the higher temperature will gain higher FAN speed, after over the temperature which this item setting, the FAN works in full speed.

CPUFAN Idle Temp

This item allows you setting the FAN works in 60% of full speed, when the temperature lower than the temperature which you setting.

3-10-2 Thermal Throttling Options

Phoenix - AwardBIOS CMOS Setup Utility

Thermal Throttling Options

CPU Thermal-Throttling	Disabled	Item Help
CPU Thermal-Throttling Temp	70	Menu Level >
CPU Thermal-Throttling	70	
↑↓:Move ENTER:Accept ESC:Abort		
↑↓→← Move Enter:Select +/-/PU/PD:Value F10:Save ESC:Exit F1:General Help F5:Previous Values F6:Optimized Defaults F7:Standard Defaults		

Phoenix - AwardBIOS CMOS Setup Utility
Thermal Throttling Options

<table style="width: 100%; border-collapse: collapse;"> <tr> <td style="width: 60%; padding: 2px;">CPU Thermal-Throttling Temp</td> <td style="width: 40%; text-align: right; padding: 2px;">Item Help</td> </tr> <tr> <td style="padding: 2px;">CPU Thermal-Throttling Temp</td> <td style="padding: 2px;">CPU Thermal-Throttling Temp Level ></td> </tr> <tr> <td style="padding: 2px;">CPU Thermal-Throttling Temp</td> <td style="padding: 2px;">CPU Thermal-Throttling Temp Level ></td> </tr> <tr> <td style="padding: 2px;">CPU Thermal-Throttling Temp</td> <td style="padding: 2px;">CPU Thermal-Throttling Temp Level ></td> </tr> </table>	CPU Thermal-Throttling Temp	Item Help	CPU Thermal-Throttling Temp	CPU Thermal-Throttling Temp Level >	CPU Thermal-Throttling Temp	CPU Thermal-Throttling Temp Level >	CPU Thermal-Throttling Temp	CPU Thermal-Throttling Temp Level >	
CPU Thermal-Throttling Temp	Item Help								
CPU Thermal-Throttling Temp	CPU Thermal-Throttling Temp Level >								
CPU Thermal-Throttling Temp	CPU Thermal-Throttling Temp Level >								
CPU Thermal-Throttling Temp	CPU Thermal-Throttling Temp Level >								
↑↓← Move Enter:Select +/-/PU/PD:Value F10:Save ESC:Exit F1:General Help F5:Previous Values F6:Optimized Defaults F7:Standard Defaults									

Phoenix - AwardBIOS CMOS Setup Utility
Thermal Throttling Options

<table style="width: 100%; border-collapse: collapse;"> <tr> <td style="width: 60%; padding: 2px;">BiTurbo Technology Mode</td> <td style="width: 40%; text-align: right; padding: 2px;">Disabled</td> <td style="width: 40%; text-align: right; padding: 2px;">Item Help</td> </tr> <tr> <td style="padding: 2px;">BiTurbo Activated Threshold</td> <td style="padding: 2px;">202MHz</td> <td style="padding: 2px;">CPU Thermal-Throttling Temp Level ></td> </tr> <tr> <td style="padding: 2px;">BiTurbo Activated Threshold</td> <td style="padding: 2px;">202MHz</td> <td style="padding: 2px;">CPU Thermal-Throttling Temp Level ></td> </tr> <tr> <td style="padding: 2px;">BiTurbo CPU Clock Set</td> <td style="padding: 2px;">87.50% []</td> <td style="padding: 2px;">CPU Thermal-Throttling Temp Level ></td> </tr> <tr> <td style="padding: 2px;">CPU Thermal-Throttling Temp</td> <td style="padding: 2px;">75.00% []</td> <td style="padding: 2px;">CPU Thermal-Throttling Temp Level ></td> </tr> <tr> <td style="padding: 2px;">CPU Thermal-Throttling Temp</td> <td style="padding: 2px;">62.50% []</td> <td style="padding: 2px;">CPU Thermal-Throttling Temp Level ></td> </tr> <tr> <td style="padding: 2px;">CPU Thermal-Throttling Temp</td> <td style="padding: 2px;">50.00% []</td> <td style="padding: 2px;">CPU Thermal-Throttling Temp Level ></td> </tr> <tr> <td style="padding: 2px;">CPU Thermal-Throttling Temp</td> <td style="padding: 2px;">37.50% []</td> <td style="padding: 2px;">CPU Thermal-Throttling Temp Level ></td> </tr> <tr> <td style="padding: 2px;">CPU Thermal-Throttling Temp</td> <td style="padding: 2px;">25.00% []</td> <td style="padding: 2px;">CPU Thermal-Throttling Temp Level ></td> </tr> </table>	BiTurbo Technology Mode	Disabled	Item Help	BiTurbo Activated Threshold	202MHz	CPU Thermal-Throttling Temp Level >	BiTurbo Activated Threshold	202MHz	CPU Thermal-Throttling Temp Level >	BiTurbo CPU Clock Set	87.50% []	CPU Thermal-Throttling Temp Level >	CPU Thermal-Throttling Temp	75.00% []	CPU Thermal-Throttling Temp Level >	CPU Thermal-Throttling Temp	62.50% []	CPU Thermal-Throttling Temp Level >	CPU Thermal-Throttling Temp	50.00% []	CPU Thermal-Throttling Temp Level >	CPU Thermal-Throttling Temp	37.50% []	CPU Thermal-Throttling Temp Level >	CPU Thermal-Throttling Temp	25.00% []	CPU Thermal-Throttling Temp Level >	
BiTurbo Technology Mode	Disabled	Item Help																										
BiTurbo Activated Threshold	202MHz	CPU Thermal-Throttling Temp Level >																										
BiTurbo Activated Threshold	202MHz	CPU Thermal-Throttling Temp Level >																										
BiTurbo CPU Clock Set	87.50% []	CPU Thermal-Throttling Temp Level >																										
CPU Thermal-Throttling Temp	75.00% []	CPU Thermal-Throttling Temp Level >																										
CPU Thermal-Throttling Temp	62.50% []	CPU Thermal-Throttling Temp Level >																										
CPU Thermal-Throttling Temp	50.00% []	CPU Thermal-Throttling Temp Level >																										
CPU Thermal-Throttling Temp	37.50% []	CPU Thermal-Throttling Temp Level >																										
CPU Thermal-Throttling Temp	25.00% []	CPU Thermal-Throttling Temp Level >																										
↑↓← Move Enter:Select +/-/PU/PD:Value F10:Save ESC:Exit F1:General Help F5:Previous Values F6:Optimized Defaults F7:Standard Defaults																												

CPU Thermal Throttling Temp

This item allows you to activate the CPU Thermal Throttling function when the CPU temperature is over the value which you set to low down the CPU temperature when at high workload to protect processor from damage or accidental shutdown.

Phoenix - AwardBIOS CMOS Setup Utility
Thermal Throttling Options

<table style="width: 100%; border-collapse: collapse;"> <tr> <td style="width: 60%; padding: 2px;">Bi-Turbo Technology Mode</td> <td style="width: 40%; text-align: right; padding: 2px;">Disabled</td> <td style="width: 40%; text-align: right; padding: 2px;">Item Help</td> </tr> <tr> <td style="padding: 2px;">Bi-Turbo Activated Threshold</td> <td style="padding: 2px;">202MHz</td> <td style="padding: 2px;">CPU Thermal-Throttling Temp Level ></td> </tr> <tr> <td style="padding: 2px;">Bi-Turbo Activated Threshold</td> <td style="padding: 2px;">202MHz</td> <td style="padding: 2px;">CPU Thermal-Throttling Temp Level ></td> </tr> <tr> <td style="padding: 2px;">Bi-Turbo CPU Clock</td> <td style="padding: 2px;">Disabled []</td> <td style="padding: 2px;">CPU Thermal-Throttling Temp Level ></td> </tr> <tr> <td style="padding: 2px;">CPU Thermal-Throttling Temp</td> <td style="padding: 2px;">Enabled []</td> <td style="padding: 2px;">CPU Thermal-Throttling Temp Level ></td> </tr> <tr> <td style="padding: 2px;">CPU Thermal-Throttling Temp</td> <td style="padding: 2px;">Enabled []</td> <td style="padding: 2px;">CPU Thermal-Throttling Temp Level ></td> </tr> <tr> <td style="padding: 2px;">CPU Thermal-Throttling Temp</td> <td style="padding: 2px;">Enabled []</td> <td style="padding: 2px;">CPU Thermal-Throttling Temp Level ></td> </tr> <tr> <td style="padding: 2px;">CPU Thermal-Throttling Temp</td> <td style="padding: 2px;">Enabled []</td> <td style="padding: 2px;">CPU Thermal-Throttling Temp Level ></td> </tr> </table>	Bi-Turbo Technology Mode	Disabled	Item Help	Bi-Turbo Activated Threshold	202MHz	CPU Thermal-Throttling Temp Level >	Bi-Turbo Activated Threshold	202MHz	CPU Thermal-Throttling Temp Level >	Bi-Turbo CPU Clock	Disabled []	CPU Thermal-Throttling Temp Level >	CPU Thermal-Throttling Temp	Enabled []	CPU Thermal-Throttling Temp Level >	CPU Thermal-Throttling Temp	Enabled []	CPU Thermal-Throttling Temp Level >	CPU Thermal-Throttling Temp	Enabled []	CPU Thermal-Throttling Temp Level >	CPU Thermal-Throttling Temp	Enabled []	CPU Thermal-Throttling Temp Level >	
Bi-Turbo Technology Mode	Disabled	Item Help																							
Bi-Turbo Activated Threshold	202MHz	CPU Thermal-Throttling Temp Level >																							
Bi-Turbo Activated Threshold	202MHz	CPU Thermal-Throttling Temp Level >																							
Bi-Turbo CPU Clock	Disabled []	CPU Thermal-Throttling Temp Level >																							
CPU Thermal-Throttling Temp	Enabled []	CPU Thermal-Throttling Temp Level >																							
CPU Thermal-Throttling Temp	Enabled []	CPU Thermal-Throttling Temp Level >																							
CPU Thermal-Throttling Temp	Enabled []	CPU Thermal-Throttling Temp Level >																							
CPU Thermal-Throttling Temp	Enabled []	CPU Thermal-Throttling Temp Level >																							
↑↓← Move Enter:Select +/-/PU/PD:Value F10:Save ESC:Exit F1:General Help F5:Previous Values F6:Optimized Defaults F7:Standard Defaults																									

3-11 Miscellaneous Control

Phoenix - AwardBIOS CMOS Setup Utility
Power User Overclock Settings

<pre> CPU Clock Ratio 8 X Auto Detect PCI/DIMM Clk Enabled Spread Spectrum Disabled *** Current Host/PCI Clock is 133/33 MHz *** Host/PCI Clock at Next Boot 200/33 MHz *** Current DRAM Clock is 267MHz *** DRAM Clock at Next Boot By SPD(DDR533) CPU Vcore Select Default VCC1.5V Select 1.50V(Default) VDIMM Select 1.85V(Default) CPU Vcore 7-Shift Normal Flash Part Write Protect Enabled </pre>	Item Help
<pre> Host/PCI Clock at Next Clock Min= 200 Max= 355 </pre>	Menu Level >
<pre> ↑↓:Move ENTER:Accept ESC:Abort </pre>	
<pre> ↑↓← Move Enter:Select +/-/PU/PD:Value F10:Save ESC:Exit F1:General Help F5:Previous Values F6:Optimized Defaults F7:Standard Defaults </pre>	

Phoenix - AwardBIOS CMOS Setup Utility
Power User Overclock Settings

<pre> CPU Clock Ratio 8 X Auto Detect PCI/DIMM Clk Enabled Spread Spectrum Disabled *** Current Host/PCI Clock is 133/33 MHz *** Host/PCI Clock at Next Boot 200/33 MHz *** Current DRAM Clock is 267MHz *** DRAM Clock at Next Boot By SPD(DDR533) CPU Vcore Select Default VCC1.5V Select 1.50V(Default) VDIMM Select 1.85V(Default) CPU Vcore 7-Shift Normal Flash Part Write Protect Enabled </pre>	Item Help
<pre> CPU Vcore 7-Shift Normal [] + 50mv [] + 100mv [] + 150mv [] + 200mv [] + 250mv [] + 300mv [] + 350mv [] </pre>	Menu Level >
<pre> ↑↓:Move ENTER:Accept ESC:Abort </pre>	
<pre> ↑↓← Move Enter:Select +/-/PU/PD:Value F10:Save ESC:Exit F1:General Help F5:Previous Values F6:Optimized Defaults F7:Standard Defaults </pre>	

Phoenix - AwardBIOS CMOS Setup Utility
Power User Overclock Settings

<pre> CPU Clock Ratio 8 X Auto Detect PCI/DIMM Clk Enabled Spread Spectrum Disabled *** Current Host/PCI Clock is 133/33 MHz *** Host/PCI Clock at Next Boot 200/33 MHz *** Current DRAM Clock is 267MHz *** DRAM Clock at Next Boot By SPD(DDR533) CPU Vcore Select Default VCC1.5V Select 1.50V(Default) VDIMM Select 1.85V(Default) CPU Vcore 7-Shift Normal Flash Part Write Protect Enabled </pre>	Item Help
<pre> VCC 1.5V Output 1.50V(Default) [] 1.55V [] 1.60V [] 1.65V [] 1.70V [] 1.80V [] 1.90V [] 2.00V [] ↑↓:Move ENTER:Accept ESC:Abort </pre>	Menu Level >
<pre> ↑↓→← Move Enter:Select +/-/PU/PD:Value F10:Save ESC:Exit F1:General Help F5:Previous Values F6:Optimized Defaults F7:Standard Defaults </pre>	

Host Clock at Next Boot

This item allows you to select CPU frequency step by step increasing.
The choice are: 533MHz CPU---133MHz~350MHz, 800MHz CPU---200MHz~350MHz

DRAM Clock at Next Boot

This item allows you select the DRAM Clock for DDR2 533/DDR2 400. The setting are:
By SPD, DDR2 533, DDR2 400

CPU Vcore 7-Shift

This item allows you select the CPU Vcore Voltage xx% more than the standard value, by this function for the precise over-clocking for extra demanding of performance.

CPU Vcore Select

This item allows you select CPU Vcore Voltage by increase 0.0125V step by step from 0.8375V to 1.6V or the Default setting is Default (CPU manufacturer Default setting).

VCC 1.5V Output

This item allows you to select 1.5V of the AGP VGA card. The choice are: Default, 1.5V,1.55V,1.6V,1.65V,1.70V,1.80V,1.90V,2.00V.

VDIMM Output

This item allows you to select DRAM Voltage. The choice are: 1.80V,1.85V,1.90V, 2.00V,2.05V,2.10V,2.15V.

3-12 Load Standard/Optimized Defaults

Load Standard Defaults

When you press <Enter> on this item, you get confirmation dialog box with a message similar to:

Load Standard Defaults (Y/N)? N

Pressing <Y> loads the BIOS default values for the most stable, minimal-performance system operations.

Load Optimized Defaults

When you press <Enter> on this item, you get a confirmation dialog box with a message similar to:

Load Optimized Defaults (Y/N)? N

Pressing <Y> loads the default values that are factory settings for optimal performance system operations.

3-13 Set Supervisor/User Password

You can set either supervisor or user password, or both of them. The differences are:

Supervisor password: Can enter and change the options of the setup menus.

User password: Can only enter but do not have the right to change the options of the setup menus. When you select this function, the following message will appear at the center of the screen to assist you in creating a password.

ENTER PASSWORD:

Type the password, up to eight characters in length, and press <Enter>. The password typed now will clear any previously entered password from CMOS memory. You will be asked to confirm the password. Type the password again and press <Enter>. You may also press <Esc> to abort the selection and not enter a password.

To disable a password, just press <Enter> when you are prompted to enter the password. A message will confirm that the password will be disabled. Once the password is disabled, the system will boot and you can enter Setup freely.

PASSWORD DISABLED.

When a password has been enabled, you will be prompted to enter it every time you try to enter Setup. This prevents an unauthorized person from changing any part of your system configuration.

Additionally, when a password is enabled, you can also require the BIOS to request a password every time your system is rebooted. This would prevent unauthorized use of your computer.

You determine when the password is required within the BIOS Features Setup Menu and its Security option. If the Security option is set to “System”, the password will be required both at boot and at entry to Setup. If set to “Setup”, prompting only occurs when trying to enter Setup.

Chapter 4

DRIVER & FREE PROGRAM INSTALLATION

Check your package and there is A MAGIC INSTALL CD included. This CD consists of all DRIVERS you need and some free application programs and utility programs. In addition, this CD also include an auto detect software which can tell you which hardware is installed, and which DRIVERS needed so that your system can function properly. We call this auto detect software MAGIC INSTALL.

MAGIC INSTALL Supports WINDOWS 2000/XP

Insert CD into your CD-ROM drive and the MAGIC INSTALL Menu should appear as below. If the menu does not appear, double-click MY COMPUTER / double-click CD-ROM drive or click START / click RUN / type X:\SETUP.EXE (assuming X is your CD-ROM drive).

The Intel 945 serial chipset driver only support Windows 2000 and Windows XP OS



From MAGIC INSTALL MENU you may make 9 selections:

1. INF install Intel 945P / 945PL Express Chipset system driver
2. SOUND install ALC850 AC97 Codec Audio Driver
3. LAN install Realtek LAN Controller driver
4. USB2.0 install USB 2.0 driver
5. DIRECTX9 install Microsoft DirectX 9 driver
6. PC-CILLIN install PC-CILLIN2006 anti-virus program
7. PC-HEALTH install MyGuard Hardware Doctor Utility
8. BROWSE CD to browse the contents of the CD
9. EXIT to exit from MAGIC INSTALL menu

4-1 INF Install Intel 945 chipset system driver



1. Click INF in the MAGIC INSTALL MENU



2. Click NEXT when Chipset Software Install Utility appears



3. This license agreement appear, click Yes, the readme information appear, click Next



4. Select if you want computer re-started click Finish

4-2 SOUND Install ALC850 8-Channel Audio Driver

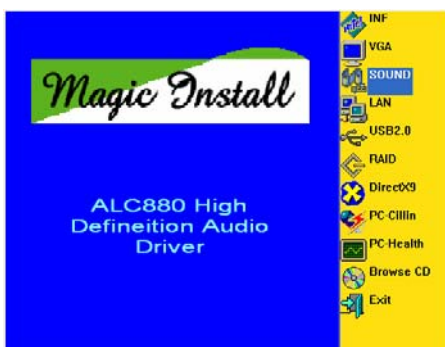

1. Click SOUND when MAGIC INSTALL MENU appears



2. Click NEXT When Realtek AC97Audio driver windows appears

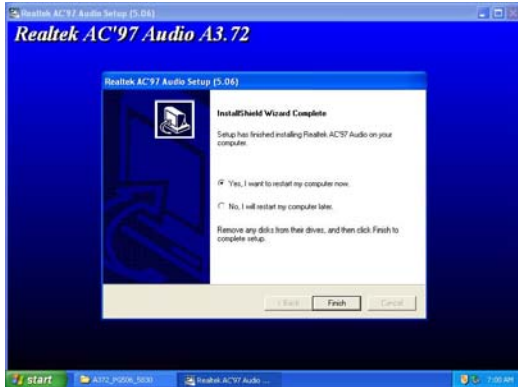

3. Click FINISH and restart your computer

4. Manual Sound Effect Setting



5. Speaker configuration setting

6. SPDIF IN/OUT setting

NOTE: Please upgrade your Windows XP to Service Pack 1 / Windows 2000 to Service Pack 4 or later before you the HD Audio CODEC driver.

4-3 LAN Install Realtek LAN Controller Driver

WINDOWS 2000/XP Setup

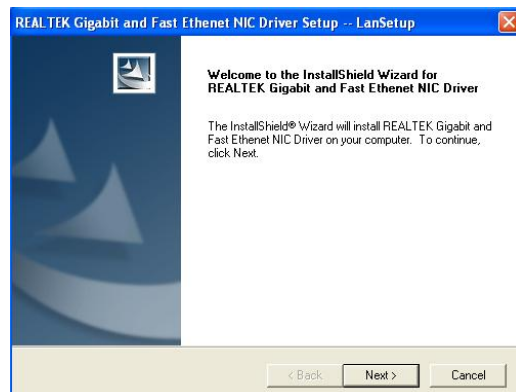

1. Click LAN when Magic Install Menu appear

2. Click NEXT, install REALTEK LAN and Fast Ethernet NIC Driver

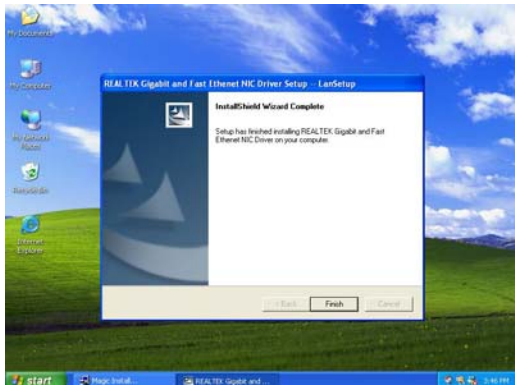

3. After driver installation completed, Click Finish

4-4 PC-HEALTH Install MyGuard Hardware monitor Utility



1. Click PC-HEALTH when MAGIC INSTALL MENU appears

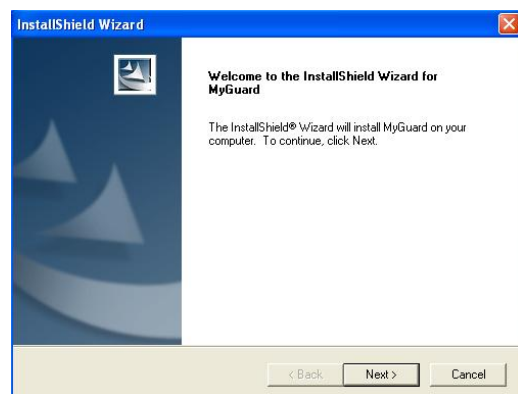

2. Click Next when Install shield wizard Window appears, Choose destination location and click Next, when the start copy file windows appear, click next

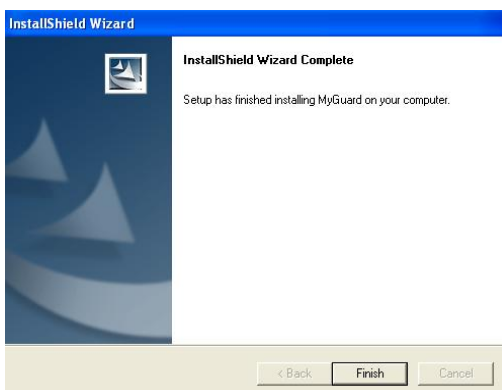

3. Select Finish after setup complete



4. Execute MY GUARD utility, On-time Monitoring your system health

NOTE:

MAGIC INSTALL will auto detect file path X:\NFORCE4\MYGUARD\SETUP.EXE

4-5 USB2.0 Install Intel USB2.0 DRIVER

Windows 2000 OS

Please install Windows 2000 service pack 4 or later .

Windows XP OS

Please install Windows XP service pack 1 or later .

4-6 PC-CILLIN Install PC-CILLIN 2006 Anti-virus program



1. Click PC-CILLIN when MAGIC INSTALL MENU appears

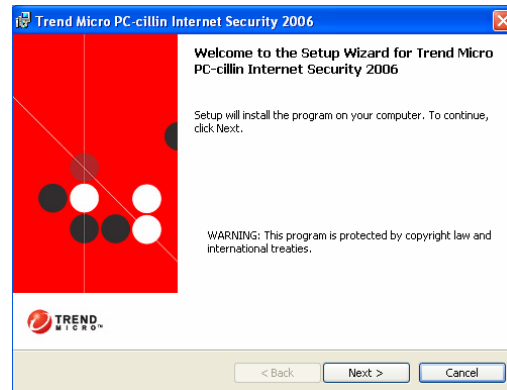

2. Select "Install program" when the "Trend Micro internet security" windows appears



3. This is license agreement, select "I Accept the terms" and Click NEXT

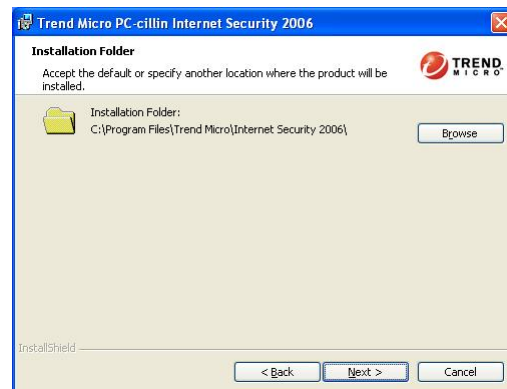

4. Click NEXT or choose Change to change the path for the file to be stored



5. Click INSTALL, Start to install the software

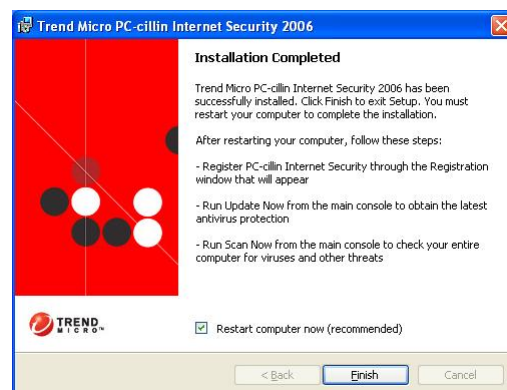

Setup Complete and click FINISH

Note : Please install ACROBAT READER for reading PC-CILLIN 2006 User Manual which locates at the path "X:\acrobat\adberdr6_enu_full.exe".

4-7 HOW TO UPDATE BIOS

Before update BIOS users have to “Disable”, “Flash Part Write Protect” item which in “Miscellaneous Control” of BIOS SETUP. Otherwise the system will not allow you to upgrade BIOS by Award Flash Utility.

- STEP 1.** Prepare a boot disc. (you may make one by click START click RUN type SYS A: click OK)
- STEP 2.** Copy utility program to your boot disc. You may copy from DRIVER CD X:\FLASH\AWDFLASH.EXE or download from our web site.
- STEP 3.** Copy latest BIOS for 945PL Chipset Motherboard from web site to your boot disc.
- STEP 4.** Insert your boot disc into A:,
start the computer, type “Awdflash A:\945PLXXXxxx.BIN /SN/PY/CC/R”
945PLXXX Axxx.BIN is the file name of latest BIOS it can be 945PLXXX
A03.BIN or 945PLXXX CPB02.BIN
SN means don’t save existing BIOS data
PY means renew existing BIOS data
CC means clear existing CMOS data
R means restart computer
- STEP 5.** Push ENTER and the BIOS will be updated, computer will be restarted automatically.

4-8 Pro Magic Plus Function Introduction

What’s Pro Magic Plus?

Tired with reinstall OS each time when it doesn’t work? Does your computer often crash down or unable to work after installed new software? Have you had great loses and troubles because of computer problems? Still using time-consuming backup software that occupies lots of HD space?

Pro Magic Plus- an instant system recovery software tailored to solve these problems for you. It combines various application tools (e.g. anti-virus, backup software, uninstall software, multi-boot software) to satisfy your needs of all sorts of system protections.

What functions does Pro Magic Plus have?

1. **Instant System Restoration** – Regardless of mis-operation or system crash, install Pro Magic Plus beforehand would allow you to instantly restore your system back by simply reboot your computer.
2. **Easy-to-use** – Auto installation from CD ROM; Supports Mouse
3. **System Uninstall** – Pro Magic provides a protection mode, which allows user to freely test any software. If user does not want to keep the software, just reboot the computer to restore back to the previous state, and Pro Magic will remove it completely from your computer.
4. **Password Security** – Pro Magic provides double password protection, including user password for entering each OS and manager password for managing ‘Pro Magic’, which can effectively prevent others from using your computer without permission or data from being stolen. (disable item for OEM version)
5. **Complete Protection** – Pro Magic not only protects the system disk, but also can protect your

data disk, and does not require to reboot when backup or restore data disk.

6. **Multipoint Save/Restore** – You can backup your system whenever you need and restore them back to anytime you wish, 1 hour, 1 day or 1 month ago. Restore points are unlimited. (disable item for OEM version)
7. **Data Disk Protection** – Pro Magic Plus now comes with data disk protection, provides complete protection for your computer! (disable item for OEM version)
8. **You can choose to change the default path of 'My Document', 'My Favorite' and 'Outlook Express'**, so that when you are restoring the system, data in these folders will not be restored as well. (This is optional, you can leave it as it is).

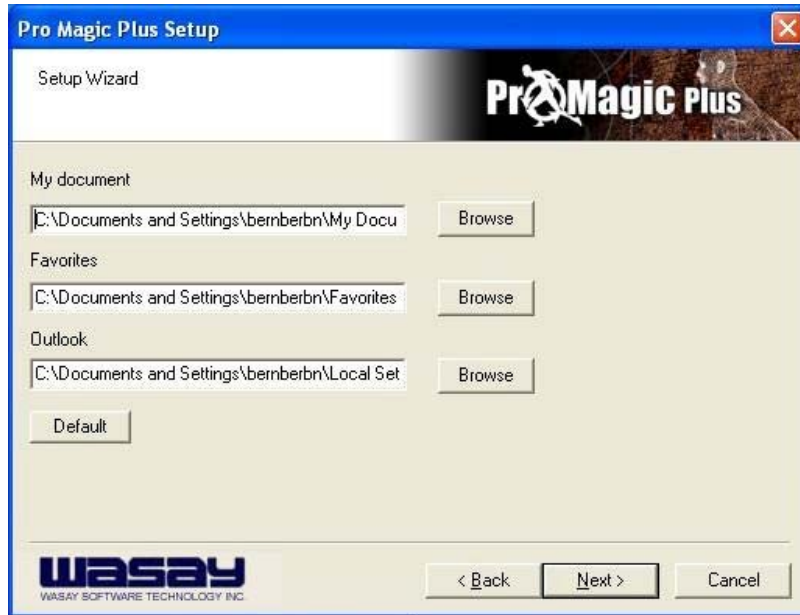

graph 4

NOTE: Functions of each version will differ from each other, and will be based on the function descriptions of each version.

System Requirements

- ◇ First OS must be Windows 98 SE/ME/2000/XP
- ◇ Support Only Windows OS (No Linux)
- ◇ Windows server OS and Windows NT not supported
- ◇ Minimum of Intel 486 or above, 16MB of memory or above
- ◇ Minimum of 500MB free/usable space or above
- ◇ Support for SCSI & SATA Hard disk

Pro Magic Plus only supports SCSI hard disk with Windows 2000 or OS above

Notice Before Installation

1. Before install Pro Magic Plus, turn off all anti-virus software. (Include BIOS anti-virus function)
2. Pro Magic Plus does not support multiple PRI partitions. If you have multiple PRI partitions, please repartition your HD before installation.
3. If your HDD is not fully partitioned (with un-partitioned/unused space at end of HDD), please repartition the HDD before install Pro Magic Plus.