

# **FW37**

---

## **MAINBOARD MANUAL**

DOC No.: M99B01

Rev. : A1

Date : 6, 2000

Part No. : 25-11427-21

## Handling Precautions

**Warning:**

1. Static electricity may cause damage to the integrated circuits on the mainboard. Before handling any motherboard outside of its protective packaging, ensure that your body is not electrostatically charged.
2. There is a danger of explosion if the battery is incorrectly replaced. Replace only with the same or an equivalent type of battery as recommended by the manufacturer.
3. Discard used batteries according to the manufacturer's instructions.

Observe the following basic precautions when handling the motherboard or other computer components:

- Wear a static wrist strap which fits around your wrist and is connected to a natural earth ground.
- Touch a grounded or anti-static surface or a metal fixture such as a water pipe.
- Ensure add-on cards, mainboards, and models do not come into contact with the golden fingers connectors, plugged into the expansion slot.

The above methods prevent static build-up and allow it to be discharged properly.

## Trademark

*All trademarks mentioned in this manual are registered property of the respective owners.*

## Handling Precautions

*This manual may not, in whole or in part, be photocopied, reproduced, transcribed, translated, or transmitted in whatever form without the written consent of the manufacturer, except for copies retained by the purchaser for personal archival purposes.*

---

**Chapter 1 Overview**

Package Checklist .....	1-2
Mfg. Optional Spec. of FW37, FW37(M), FW37(B) .....	1-2
The FW37 Mainboard .....	1-3
Main Features .....	1-4
ACPI Ready .....	1-6
FIC Unique Innovation for Users (NOVUS) - <i>Enhanced Mainboard Features and System Support</i> .....	1-7

**Chapter 2 Installation Procedures**

Quick Reference (from Page 2-2 to 2-4) .....	2-2
Mainboard Layout .....	2-2
Mfg. Optional Spec. of FW37, FW37(M), FW37(B) .....	2-3
1). Clear CMOS, Clear Password, Front Side Bus Speed Select, Over Clock Driving, Onboard LAN Disable, CPU Type Select .....	2-3
2). Front Panel Block Cable Connection .....	2-4
3). CPU Fan Installation .....	2-4
1). Set System Jumpers .....	2-5
CMOS Clearance Function: JP1 (CLRCMOS) .....	2-6
Password Clearance Function: JP2 (CLRPWD) .....	2-6
Disabling Onboard LAN Feature: JP4 .....	2-7
Enabling Over Voltage Driving: JP45 (Magic Tuner) .....	2-8
CPU Type Selection: JP6 .....	2-8
2). Install RAM Modules .....	2-9
Install and Remove DIMMs .....	2-9
3). Install the CPU .....	2-10
4). Install Expansion Cards .....	2-10
5). Connectors .....	2-12
Floppy Diskette Drive Connector: FDD .....	2-12
IDE HDD Device Connectors: PRIMARY, SECONDARY ..	2-13
Front Panel Block Connector: J1 .....	2-13
ATX Power Connector: POWER1 .....	2-14
CPU Fan Connector: FAN1 .....	2-15
System Case Fan Connector: FAN2 .....	2-16
Wake-On-LAN Connector: WOL1 .....	2-16

TV Audio Input Connector: J9 (VIDEO AD) .....	2-17
Flat Panel Display Connector: FTP1 (for specified customers) .....	2-17
Infrared Connector: IR .....	2-18
CD Audio-In Connector: J10, J11 .....	2-18
PS/2 Keyboard and Mouse Connector: PS2_KB, PS2_MS	2-19
Universal Serial Bus Connectors: Rear and Front USBs ...	2-19
Serial Port Connectors: COM1, COM2 .....	2-20
Printer Connector: LPT .....	2-20
Video Graphics Accelerator Connectors: VGA .....	2-20
GAME/MIDI Connector: GAME .....	2-21
Audio I/O Jacks: LINE_OUT, LINE_IN, MIC_IN .....	2-21
Local Area Network Jack: LAN (optional) .....	2-21

### **Chapter 3 BIOS Setup**

CMOS Setup Utility .....	3-1
Standard CMOS Setup .....	3-2
Hard Disk Configurations .....	3-2
Advanced BIOS Features .....	3-3
Advanced Chipset Features .....	3-7
Integrated Peripherals .....	3-10
Power Management Setup .....	3-16
PnP/PCI Configurations .....	3-21
PC Health Status .....	3-22
Frequency/Voltage Control .....	3-23
Load Fail-Safe Defaults .....	3-24
Load Optimized Defaults .....	3-24
Supervisor/User Password .....	3-25
Save and Exit Setup .....	3-26
Exit without Saving .....	3-26

<b>Quick Reference (German)</b>	<b>G-1</b>
<b>Quick Reference (French)</b>	<b>F-1</b>
<b>Quick Reference (Spanish)</b>	<b>S-1</b>
<b>Quick Reference (Japanese)</b>	<b>J-1</b>
<b>Quick Reference (Chinese Simplified)</b>	<b>C-1</b>

## Overview

The new Micro ATX, Socket 370 1stMainboard FW37 supports a full range of the latest generation Intel® and Cyrix processors. Intel's new Celeron™ and lightening fast Coppermine processors of up to 866 MHz and up\* are supported with Front Side Bus speeds of 66/100/133 MHz. Built using the leading edge 0.18 micron technology the Intel FCPGA Pentium®!!! processors provide a significant performance scaling boost over previous Pentium®!!! processors. (\*: not tested yet)

The Intel 810/810E accelerated Hub architecture provides exceptional onboard video. Direct AGP and it's efficient memory utilization allows a 4MB SDRAM display cache (mfg. option) and Dynamic Video Memory Technology. The 1stMainboard FW37 also features Onboard Audio provided by the state of the art embedded Codec and onboard Lan supported by the Realtek RTL 8139B/C (mfg. option).

Support for the Ultra DMA/66 protocol and its high-speed interface further ensures that data transfer speeds are improved, especially for long sequential transfers required by audio/visual applications. With 2 DIMM there is up to 512 MB available SDRAM.

The 1stMainboard FW37 comes with a versatile range of I/O features such as 2 serial port, 1 parallel port, 1 PS/2 mouse and keyboard connector, 2 USB connectors, 1 LAN jack (mfg. option), 1 front USB pin header (mfg. option), 1 VGA connector, 1 media connector (MIDI /game port, Line-in, Line-out and Mic-in). 1 DFTV Pin Header provides TV out and LCD panel support. Ample expansion is available through 3 PCI and 1 AMR.

Other key features are Remote On/Off, Auto Power Failure Recovery, Keyboard/Mouse Power On, Wake on Lan ( WOL ), integrated temperature monitoring and system fan control. Included also is CD Pro with enhanced drivers and the new CD Plus package containing 9 bundled soft-ware solutions including Norton AntiVirus, Ghost, Virtual Drive.

## Package Checklist

If you discover any item below was damaged or lost, please contact your vendor.

- The mainboard
- This user manual
- One FDD cable
- One HDD cable
- One ATA/66 cable
- One COM2 cable (optional)
- Two Software CDs (CD Pro, CD Plus and its manual)

## Mfg. Optional Spec. of FW37, FW37(M), FW37(B)

<b>FW37</b>	<b>FW37(M)</b>	<b>FW37(B)</b>
Intel 810E chipset	Intel 810E chipset	Intel 810 chipset
Support FSB 66/100/133MHz	Support FSB 66/100/133MHz	Support FSB 66/100MHz, No 133MHz
With AC-97	With AC-97	With AC-97
With 4MB Display Cache	Without 4MB Display Cache	Without 4MB Display Cache
With LAN	Without LAN	Without LAN
With Audio Alert	Without Audio Alert	Without Audio Alert

## The FW37 Mainboard

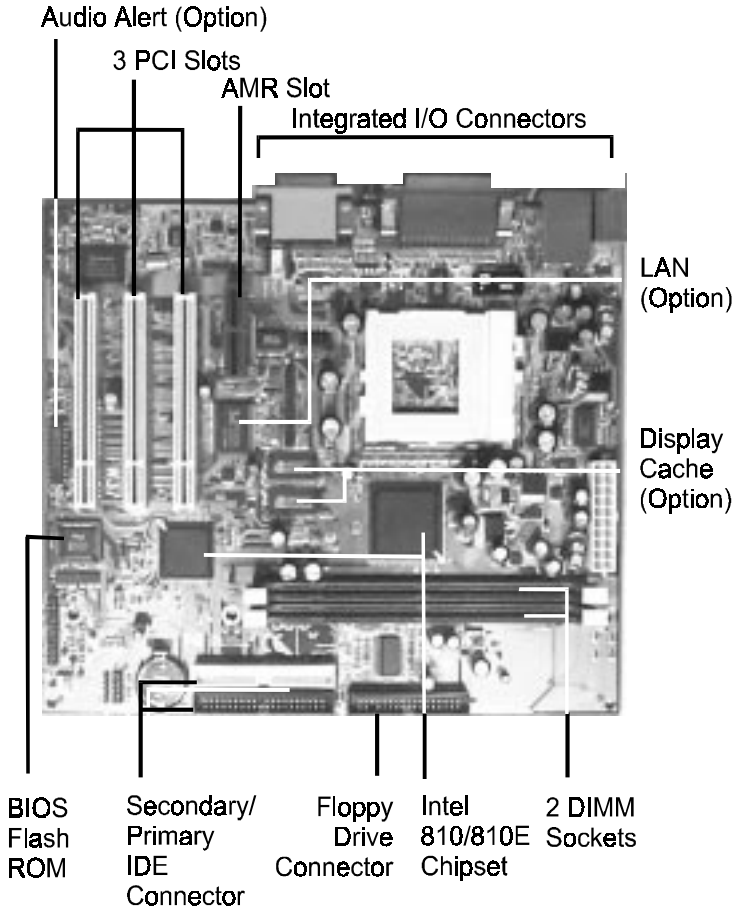

## Main Features

### ■ Easy Installation

BIOS with support for Plug and Play, auto detection of IDE hard drives, LS-120 drives, IDE ZIP drives, Windows 95, Windows 98, Windows NT 4.0, Windows 2000, and OS/2.

### ■ Leading Edge Chipset

Intel 810/810E provides integrated DRAM controllers with new Dynamic Power Management Architecture (DPMA), concurrent PCI (2.0/2.1), AGP 1.0/2.0 compliant and USB. The built-in audio and video features of the Intel chipset 810/810E (with optional 4MB display cache) provides better visual performance with the Dynamic Video Memory Technology (DVMT) properties.

### ■ Versatile Main Memory Support

Accepts up to 512MB DRAM using two DIMMs of 32, 64, 128, 256MB with support for lightning-fast SDRAM (100MHz).

### ■ Flexible Processor Support

Onboard CPU socket supports:

Intel® Celeron PPGA/FCPGA 433/500/533/566/600/667/700/733MHz at 66MHz FSB

Intel® CuMine FCPGA 500/550/600/650/700/750/800/850MHz at 100MHz FSB

Intel® CuMine FCPGA 533/566/600/667/733/800/866/933MHz at 133MHz FSB

Cyrix® III 466/500/533/550/600/650/700/733MHz at 133MHz FSB

### ■ PCI Expansion Slots and AMR Slot

Three 32-bit PCI Bus expansion slots provide the room to install a full range of add-on cards and an AMR slot for audio-modem riser card.



- 
- **Enhanced PCI Bus Master IDE Controller with Ultra DMA/33 and Ultra DMA/66 Support**

Integrated Enhanced PCI Bus Master IDE controller features two dual-channel connectors that accept up to four Enhanced IDE devices, including CD-ROM and Tape Backup Drives, as well as Hard Disk Drives supporting the new Ultra DMA/66 protocol. Standard PIO Mode 3, PIO Mode 4, DMA Mode 2, DMA Mode 4 devices are also supported.
  
  - **Integrated Audio Subsystem**

Embedded audio features in the ICH with an integrated PCI audio controller, DOS games compatible engine. The subsystem utilizes line-out, line-in, and MIC mini-jack external jacks, one joystick port with MIDI interface.
  
  - **Super Multi Input/Output (I/O) Support**

Integrated Plug and Play multi-I/O chipset features two high-speed UART 16550 compatible serial ports, one infrared port, one EPP/ECP capable parallel port, and one FDD connector.
  
  - **USB Support**

Two USB jacks for rear panel connection and two front USB ports for front panel connections provide you with convenient, high-speed Plug and Play connections to the growing number of USB compliant external peripheral devices on the market. (When two front USBs are used, two rear USBs will not work and vice versa).
  
  - **Remote Wake-Up Support**

One LAN wake-up connector, WOL, supports LAN cards equipped for remote wake-up functionality.
  
  - **Onboard IrDA Connector**

An IrDA connector for wireless infrared connections is available.

- Enjoy TV Program on Monitor

The connector, J9 (Video AD), attaches with a PCI TV convertor card allows you to enjoy TV programs by software and remote control. It can be done by accepting the audio signals from the TV card and output voices via the sound jacks. Your monitor displays TV programs.

- Flat Panel Display Support (Reserved for specified customers)

This mainboard supports flat panel displays via a PCI convertor card which output digital signals to the display. The card attaches to the FTP1 connector on the mainboard via a ribbon cable. It gives you one more choice about visual demonstration.

## ACPI Ready

This mainboard fully implements the new ACPI (Advanced Configuration and Power Interface) 1.0 Hardware and BIOS requirement. If you install ACPI aware operating system, such as Windows 98/98 SE, you fully utilized the power saving under ACPI. (*Windows 2000 Professional supports ACPI functions.*)

It is compatible with all other none ACPI operating systems. If you want to setup ACPI feature under Windows 98, please follow the description below: Run Windows 98 setup by using **setup/p j** on the command line for installing Windows 98 with the ACPI control feature.

If you type **setup** without the parameter **/p j**, Windows 98 will be installed as APM, PnP mode, no ACPI will be used. For more detail information, please visit the web site of Microsoft. Its address is: [www.microsoft.com/hwtest/](http://www.microsoft.com/hwtest/).



**NOTE:** If BIOS date is after 12/02/1999, the ACPI will be installed automatically. Users do not need to setup in the above-mentioned way.

---

## FIC Unique Innovation for Users (NOVUS) - Enhanced Mainboard Features and System Support

### ■ LogoGenie

A user friendly GUI supporting Windows 98, LogoGenie allows you to customize, create or select a Logo which will be displayed when the system is booting.

***Before execute this LogoGenie function, please make sure the related BIOS feature, BIOS Guardian, is disabled; and refer to its related README file.***



#### **NOTE:**

1. LogoGenie supports Award BIOS only.
2. If you create a Logo file (.bmp) by LogoGenie, the file size must be 640 x 464 x 16 colors (around 145K).

To enable this utility, please proceed as follows:

1. Insert CD Pro 4.X. Select LogoGenie from the Menu and follow the installation instructions.
2. After LogoGenie has been installed, go to Windows Start Box. In Programs Menu, select LogoGenie. Click three check boxes in the pop-up menu for making sure of the BIOS feature (*BIOS Guardian*) and other anti-virus software are disabled. Read README file carefully. After all these, the next procedure proceeds.
3. In LogoGenie Dialogue Box, choose one of 3 options; and then proceed as introduced in 4 or 5 steps listed on the left hand side of the Dialogue Box.
4. After complete the last step, press OK. The system will reboot to restore the BIOS with your new customized Logo.
5. The system will automatically restart with your customized Logo that appears in background.



**WARNING:** While execute Step3 below, please do not turn off the system power in order to avoid BIOS damage.

■ BIOS Guardian

BIOS Guardian by default is enabled. It must be disabled in order to reflash BIOS, thus effectively acts as a fire-wall against viruses that can attack the BIOS while the system is running.

BIOS Guardian can be disabled as follows:

1. Go to BIOS Set Up Menu. (Press **Del** key while booting.)
2. Go to BIOS Features Set Up Submenu.
3. Disable BIOS Guardian.
4. Save the setting, and restart system.



**NOTE:** However, if it is disabled and while boot the system, the POST screen will be held and shows you the message to let you know the current status of BIOS Guardian. To press **G** key will enable the BIOS Guardian again; or simply to press the **space bar** will continue the booting process.

■ Easy Key

Instead of completing the multi-layered BIOS setup process these 3 Easy Key functions provide direct access to Sub-Menu's when completing BIOS settings adjustments.

Easy-Keys are as follows:

- Ctrl + c:** To enter clock settings menu.
- Ctrl + p:** To load Performance Default settings and restart.
- Ctrl + f:** To load Fail-Safe Default settings and restart.

---

**■ Audio Alert (mfg. option)**

After complete a system upgrade, should the computer be assembled incorrectly, a friendly onboard voice caution, will advice of the error during system boot up.

A convenient onboard LED will also flash, waring that there is a system problem. If you do not hear the Audio Alert , please check that your speakers are connected.

Audio warning are activated as follows:

**No CPU:** 'Caution! Processor not detected. Please check your PC'

**No Memory:** 'Caution! Memory not detected. Please check your PC'

**No Graphics:** 'Caution! VGA not detected. Please check your PC'

**■ Overclock Partner**

Should the system not start because clock speed settings have been increased to a speed incompatible with the system, the Overclock Partner allows you to reboot at system default settings, protecting hardware from any damages caused by changes to the BIOS.

Complete the following steps:

1. Turn the system off.
2. Restart while holding down the **Insert** key. It is important that the **Insert** key is held down until the default clock speed is shown on the POST screen.
3. Enter BIOS setting menu, and re-set clock speed desired or default.

■ Clockometer

Clockometer is a Windows 98 compatible, attractive and user friendly Graphic User Interface (GUI). Clockometer enables you to change clock speed settings directly, without having to enter the BIOS Sub-Menus. With the on-screen display panel you can easily monitor your new clock speed settings with gauges that identify your system speed, Front Side Bus settings and CPU Ratios

On screen buttons:

1. "+" and "-" buttons : adjust the Front Side Bus ( FSB )and CPU ratio. ( the 'hand' cursor means the active button)
2. "OK" button : changes the FSB and CPU ratio (if adjustable) settings right away. If you do not save your new setting, your system will not implement the new setting when rebooting the next time.
3. "SAVE" button : save your new settings for rebooting the computer.
4. "Quit" button will escape the Clockometer program.
5. In order to run the other application programs more smoothly, it is strongly recommended to restart your computer after completing any adjustments.

# Installation Procedures

The mainboard has several user-adjustable jumpers on the board that allow you to configure your system to suit your requirements. This chapter contains information on the various jumper settings on your mainboard.

To set up your computer, you must complete the following steps:

- Step 1 - Set system jumpers/switches
- Step 2 - Install memory modules
- Step 3 - Install the Central Processing Unit (CPU)
- Step 4 - Install expansion cards
- Step 5 - Connect ribbon cables, cabinet wires, and power supply
- Step 6 - Set up BIOS software
- Step 7 - Install supporting software tools



**WARNING:** Excessive torque may damage the mainboard. When using an electric screwdriver on the mainboard, make sure that the torque is set to the allowable range of 5.0 ~ 8.0kg/cm.

Mainboard components contain very delicate Integrated Circuit (IC) chips. To prevent static electricity from harming any of the mainboard's sensitive components, you should follow the following precautions whenever working on the computer:

1. Unplug the computer when working on the inside.
2. Hold components by the edges and try not to touch the IC chips, leads, or circuitry.
3. Wear an anti-static wrist strap which fits around the wrist.
4. Place components on a grounded anti-static pad or on the bag that came with the component whenever the components are separated from the system.

# Quick Reference (from Page 2-2 to 2-4)

## Mainboard Layout

**Chapter 2**  
**Installation**  
**Procedures**

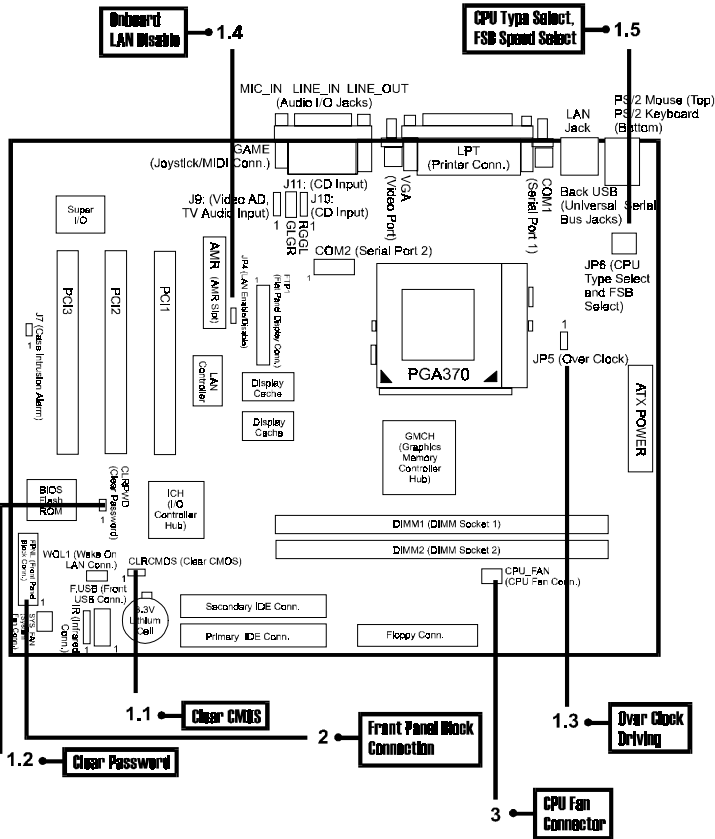







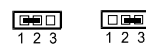

**Mfg. Optional Spec. of FW37, FW37(M), FW37(B)**

<b>FW37</b>	<b>FW37(M)</b>	<b>FW37(B)</b>
Intel 810E chipset	Intel 810E chipset	Intel 810 chipset
Support FSB 66/100/133MHz	Support FSB 66/100/133MHz	Support FSB 66/100MHz, No 133MHz
With AC-97	With AC-97	With AC-97
With 4MB Display Cache	Without 4MB Display Cache	Without 4MB Display Cache
With LAN	Without LAN	Without LAN
With Audio Alert	Without Audio Alert	Without Audio Alert

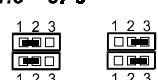
**1). Clear CMOS, Clear Password, Over Clock Driving, Onboard LAN Disable, CPU Type Select, FSB Speed Select**

<p><b>1.1 JP1</b></p>  <p><b>Normal (Default)</b>      <b>Clear CMOS</b></p>	<p><b>1.2 JP2</b></p>  <p><b>Clear Password (Default)</b>      <b>Normal</b></p>	<p><b>1.3 JP5</b></p>  <p><b>Over Clock Driving</b>      <b>Normal (Default)</b></p>
<p><b>1.4 JP4</b></p>  <p><b>Enable Onboard LAN (Default)</b>      <b>Disable Onboard LAN</b></p>	<p><b>1.5 JP6</b></p>  <p><b>Intel CPUs (Default)</b>      <b>Cyrix CPUs</b></p> <p><i>(for PCB 1.3)</i></p>	 <p><b>1-2: Cyrix Joshua</b>  <b>2-3: Intel Pentium III (Default)</b>  <b>5-6, 8-9: FSB Speed 66 MHz</b>  <b>5-6, 7-8: FSB Speed 100 MHz (Default)</b>  <b>4-5, 7-8: FSB Speed 133 MHz</b></p> <p><i>(for PCB 1.4 and above)</i></p>

## 2). Front Panel Block Cable Connection

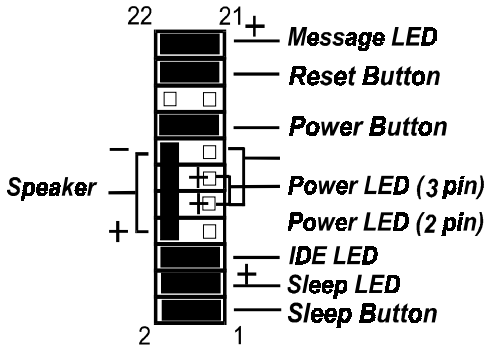

## 3). CPU Fan Installation

This connector is linked to the CPU fan. When the system is in suspend mode, the CPU fan will turn off; when it reverts back to full on mode, the fan will turn back on. Without sufficient air circulation, the CPU may overheat resulting in damage to both the CPU and the mainboard.

***Damage may occur to the mainboard and/or the CPU fan if these pins are used incorrectly. These are not jumpers, do not place jumper caps over these pins.***

## 1). Set System Jumpers

Jumpers are used to select the operation modes for your system. Some jumpers on the board have three metal pins with each pin representing a different function. A “1” is written besides pin 1 on jumpers with three pins. To **set** a jumper, a black cap containing metal contacts is placed over the jumper pin/s according to the required configuration. A jumper is said to be **shorted** when the black cap has been placed on one or two of its pins. The types of jumpers used in this manual are shown below:

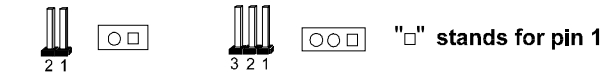
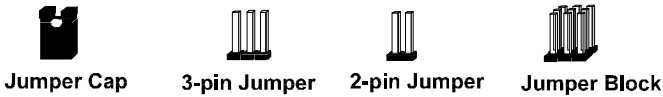

Jumpers are shown like above



Jumper cap like above



Jumpers in a Block



**NOTE:** Users are not encouraged to change the jumper settings not listed in this manual. Changing the jumper settings improperly may adversely affect system performance.

### **CMOS Clearance Function: JPI (CLRCMOS)**

The CMOS RAM is powered by the onboard button cell battery. To clear the RTC data: (1). Turn off your computer, (2). Move this jumper to Enable, (3). Move the jumper back to Disable, (4). Turn on your computer, (5). Hold down the Delete key during boot and enter BIOS Setup to re-enter user preferences.

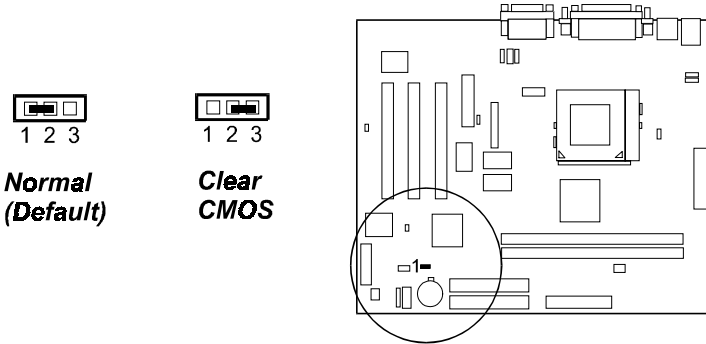

### **Password Clearance Function: JP2 (CLRPWD)**

This jumper allows you to enable or to disable the password configuration. You may need to enable this jumper by shorting it with a jumper cap if you forget your password. To clear the password setting: (1). Turn off your computer, (2). Short this jumper by placing a jumper cap on it; (3). Turn on your computer, (4). Hold down the Delete key during boot and enter BIOS Setup to re-enter user preferences, (5). Turn off your computer, (6). Remove the jumper cap, (7). Turn on your computer for the new settings to take ef

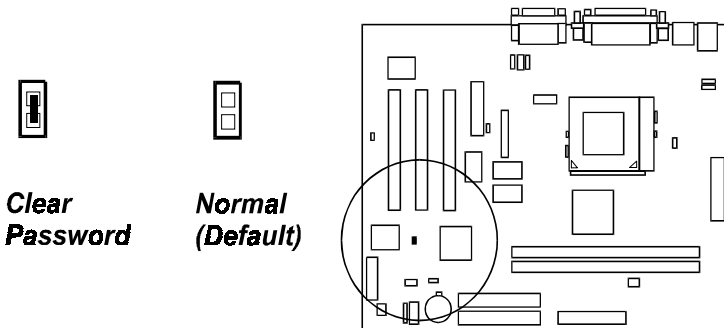

### ***Disabling Onboard LAN Feature: JP4***

The 2-pin jumper allows you to disable onboard LAN feature of your computer system if you install a LAN card.

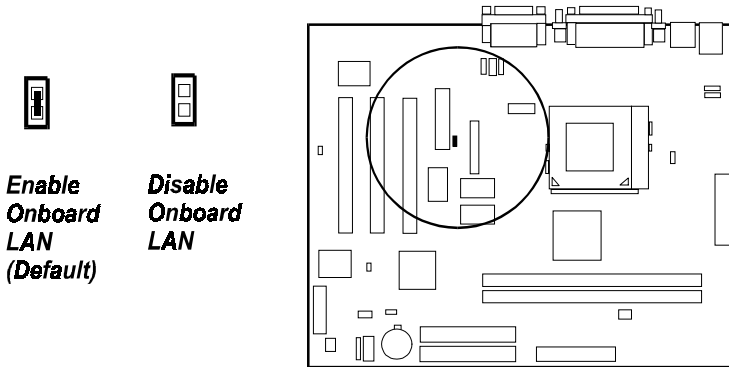

**Chapter 2  
Installation  
Procedures**

### ***Enabling Over Voltage Driving: JP5 (Magic Tuner)***

The 3-pin jumper allows you to start the over voltage driving capability of this mainboard to approach the best performance.



**WARNING:** Voltage and frequency above CPU's original specifications are not guaranteed to be stable.

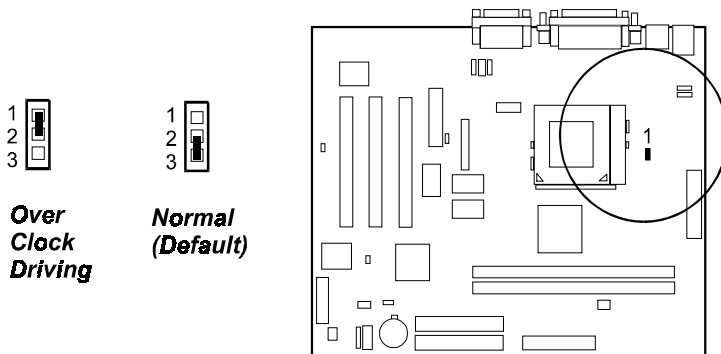

## CPU Type Selection: JP6

(for PCB 1.3) These two 3-pin jumpers are used together to select the CPU types that you will install.

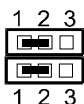

**Intel  
CPUs  
(Default)**

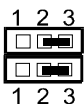

**Cyrix  
CPUs**

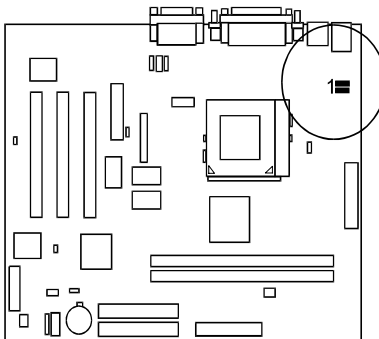

(for PCB 1.4 and above) The 3x3-pin jumper are used together to select the CPU types that you will install.

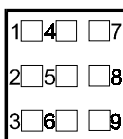

- 1-2: Cyrix Joshua**
- 2-3: Intel Pentium III  
(Default)**
- 5-6,  
8-9: FSB Speed 66 MHz**
- 5-6,  
7-8: FSB Speed 100 MHz  
(Default)**
- 4-5,  
7-8: FSB Speed 133 MHz**

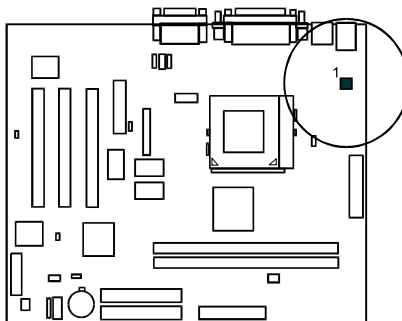

## 2). Install Memory Modules

This mainboard provides two onboard DIMM sockets supporting 3.3V (unbuffered) SDRAM DIMM modules. Either 32, 64, 128, 256MB DIMM can be installed on these three sockets. The maximum total memory supported is up to 512MB.

### Install and Remove DIMMs

1. Locate the DIMM slots on the mainboard.
2. Install the DIMM straight down into the DIMM slot using both hands.
3. The clip on both ends of the DIMM slot will close up to hold the DIMM in place when the DIMM reaches the slot's bottom.

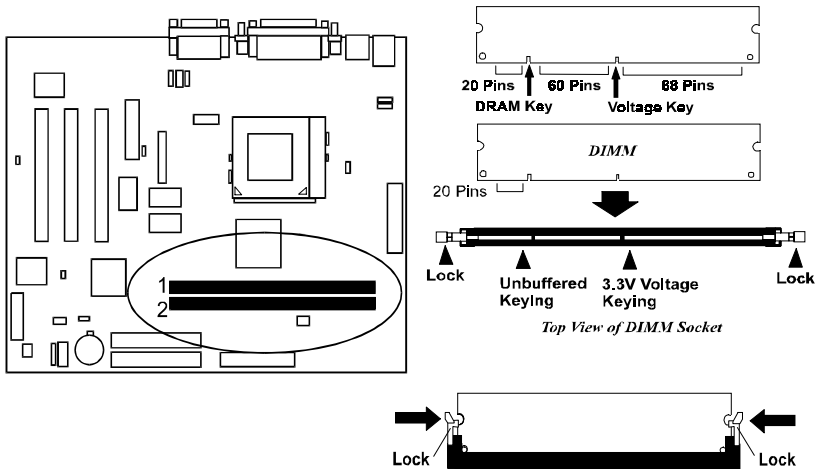

Press the clips with both hands to remove the DIMM.

### 3). Install the CPU

The mainboard has built-in Switching Voltage Regulator to support CPU Vcore autodetection. That is, It has the ability to detect and recognize the CPU voltage, clock, ratio and enables users to set up the CPU frequency from the BIOS Setup Screen. Users can adjust the frequency through “Frequency / Voltage Control” of the BIOS Setup Screen.

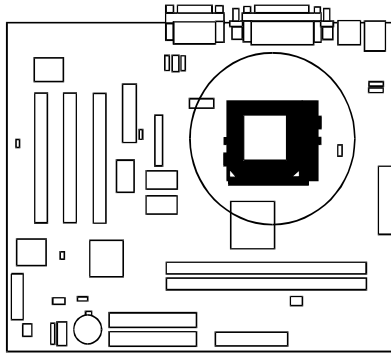

To install the CPU, do the following:

1. Lift the lever on the side of the CPU socket.
2. Handle the chip by its edges and try not to touch any of the pins.
3. Place the CPU in the socket. The chip has two notches to correctly locate the chip. Align two notches of the processor with the two triangular marks on the socket. Do not force the chip. The CPU should slide easily into the socket.
4. Swing the lever to the down position to lock the CPU in place.
5. Place the cooling fan with heatsink on top of the installed CPU.

### 4). Install Expansion Cards

This section describes how to connect an expansion card to one of your system’s expansion slots. Expansion cards are printed circuit boards that, when connected to the mainboard, increase the capabilities of your system. For example, expansion cards can provide video and sound capabilities. The mainboard features three PCI bus, one AMR slot for audio-modem riser card.



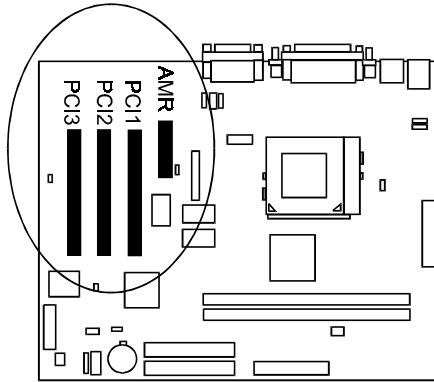

**CAUTION:** Make sure to unplug the power supply when adding or removing expansion cards or other system components. Failure to do so may cause severe damage to both the mainboard and expansioncards.

Always observe static electricity precautions.

Please read “Handling Precautions” at the start of this manual.

To install an expansion card, follow the steps below:

1. Remove the computer chassis cover and select an empty expansion slot.
2. Remove the corresponding slot cover from the computer chassis. Unscrew the mounting screw that secures the slot cover and pull the slot cover out from the computer chassis. Keep the slot cover mounting screw nearby.

3. Holding the edge of the peripheral card, carefully align the edge connector with the expansion slot.
4. Push the card firmly into the slot. Push down on one end of the expansion card, then the other. Use this “rocking” motion until the add-on card is firmly seated inside the expansion slot.
5. Secure the board with the mounting screw removed in Step 2. Make sure that the card has been placed evenly and completely into the expansion slot.
6. Replace the computer system’s cover.
7. Setup the BIOS if necessary.
8. Install the necessary software drivers for the expansion card.

## Connectors

### *Floppy Diskette Drive Connector: FDD*

This connector provides the connection with your floppy disk drive. The red stripe of the ribbon cable must be the same side with the Pin 1.

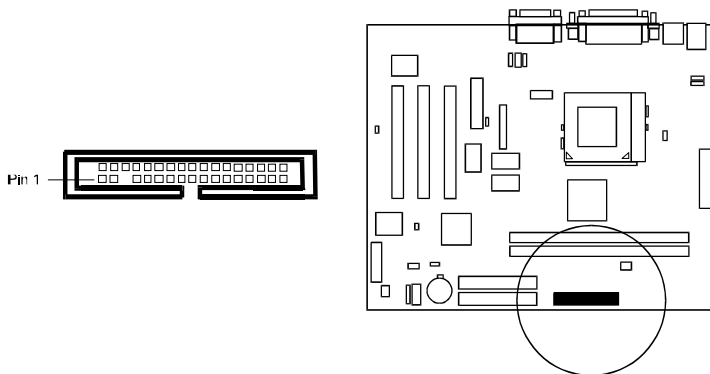

**IDE Device Connectors: PRIMARY, SECONDARY**

These two connectors are used for your IDE hard disk drives, CD drives, LS-120 drives, or IDE ZIP drives. The red stripe of the ribbon cable must be the same side with the Pin 1.

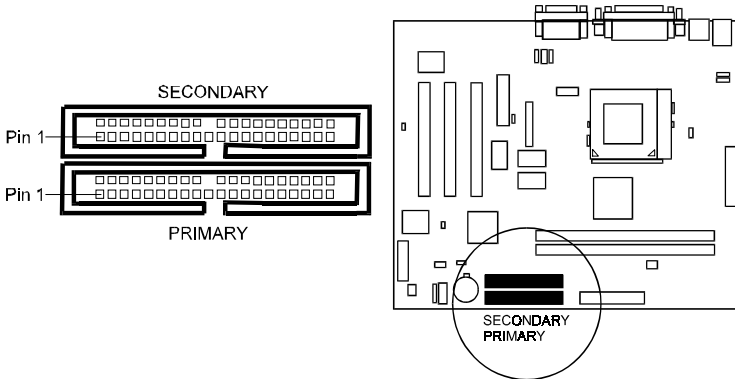

**Chapter 2  
Installation  
Procedures**

**Front Panel Block Connector: J1**

This block connector includes the connectors for linking with IDE LED, power LED, remote power button, message LED, suspend button, reset button and speaker on the front panel of the system case. Please identify polarities of plug wires for the case speaker and LEDs. Please ask vendor about this information when you buy them and install the system by yourself. The plug wires' polarities of these buttons will not affect the function.

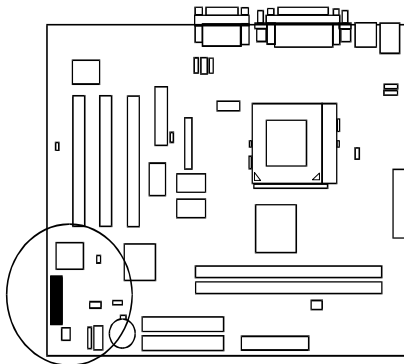

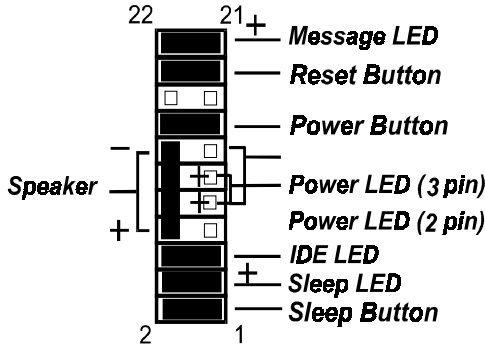

**Power LED** is connected with the system power indicator to indicate whether the system is on/off. It will blink when the system enters suspend mode.

**Remote Power Button** is connected with remote power (soft power) button. Push this switch This button allows the system to be turned on and off rather than using the power supply button.

**Message LED** is connected with the message LED. When the system is running normally, the indicator is off. It is controlled by the operating system or application software.

**Sleep Button** is connected with sleep mode button.

**Reset Button** is connected to the reset button. Push this switch to reboot the system instead of turning the power button off and on.

**Speaker** is connected with the case speaker.

**IDE LED** is connected to the IDE device indicator. This LED will blink when the hard disk drives are activated.

### ATX Power Connector: **POWER**

This 20-pin male block connector is connected to the ATX power supply. The plug from the power supply will only insert in one orientation because of the different hole sizes. Find the proper orientation and push down firmly making sure that the pins are aligned.

+12V	10	20	+5V
5V_VR	9	19	+5V
PWR_GOOD	8	18	-5V
GND	7	17	GND
+5V	6	16	GND
GND	5	15	GND
+5V	4	14	-PWR_ON
GND	3	13	GND
+3.3V	2	12	-12V
+3.3V	1	11	+3.3V

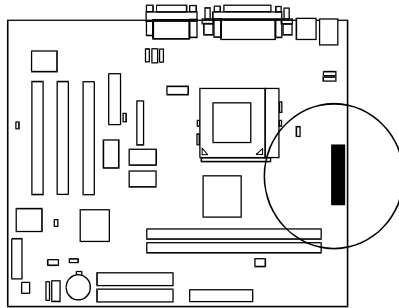

### CPU Fan Connector: **FAN1**

This connector is linked to the CPU fan. When the system is in suspend mode, the CPU fan will turn off; when it reverts back to full-on mode, the fan will turn back on. Please refer to the CPU fan installation manual for more information.

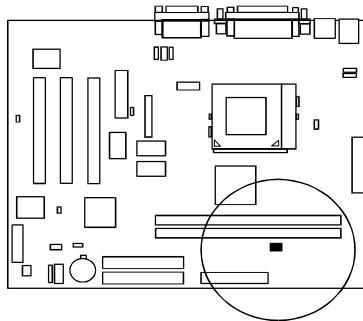
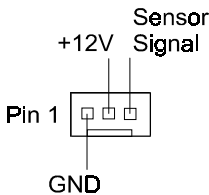

### ***System Case Fan Connector: FAN2***

There two 3-pin connectors onboard that either one allows you to link with the cooling fan on the system case to lower the system temperature.

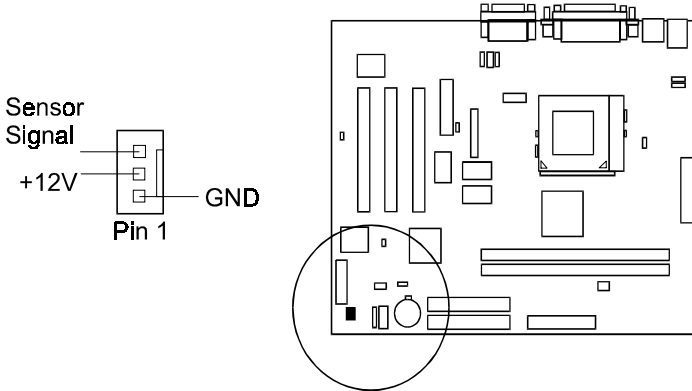

**Chapter 2**  
**Installation**  
**Procedures**

### ***Wake-On-Lan Connector: WOL1***

This 3-pin connector allows the remove servers to manage the system that installed this mainboard via your network adapter which also supports WOL. When you install such a LAN card, please read its installation guide for more information.

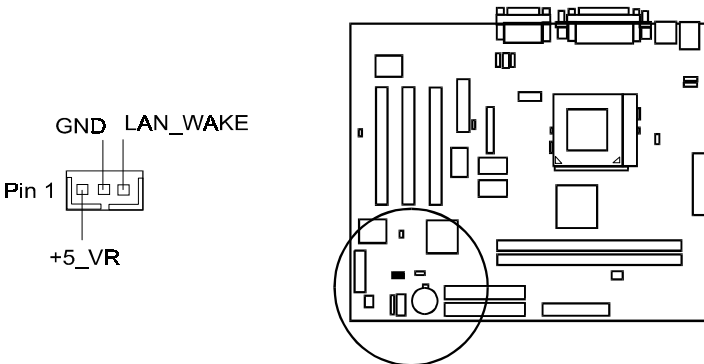



**CAUTION:**

Before connecting with the TV audio ribbon cable to VIDEO AD connector, make sure your system power is off. Failure to do so may cause damage to the mainboard.

***TV Audio Input Connector: J9 (VIDEO AD)***

This 1x4-pin connector is connected with your TV PCI card for taking the audio signal inputs through the card conversion. You can tune the TV program which display on your monitor together with your computer and a remote control.

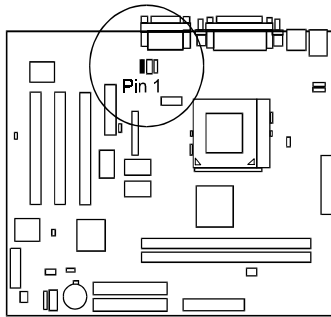

**Chapter 2  
Installation  
Procedures**

***Flat Panel Display Connector: FTP1  
(for specified customers)***

**(If PCB 1.3, it is reserved for specified customers. If PCB 1.4 and above, it is removed; , it is onboard only for specified customers.)**

This mainboard supports your flat panel display through this pinhead to a PCI converter card that outputs the signals to the display.

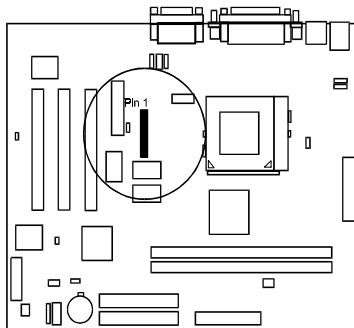

### ***Infrared Connector: IR***

This 5-pin connector is used to link with your ID device to allow transmission of data to another system that also supports the IR feature. This module mounts to a small opening on system cases that support it.

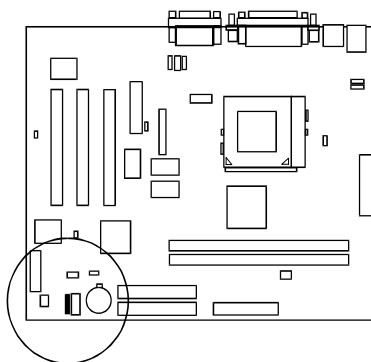
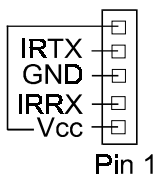

### ***CD Audio-In Connectors: J10, J11***

These two 4-pin connectors are used for different types of the AUDIO-OUT port of your CD drive.

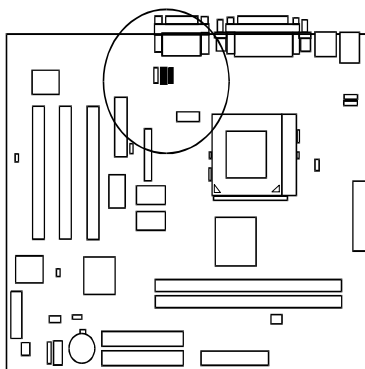
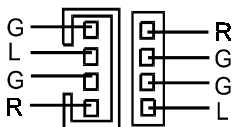



***PS/2 Keyboard and Mouse Connector: PS2\_KB, PS2\_MS***

These two 6-pin female connectors are used for your PS/2 keyboard and PS/2 mouse.

PS/2 Mouse

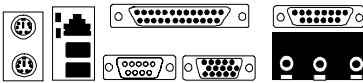

PS/2 Keyboard

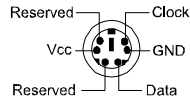

***Universal Serial Bus Connectors: Rear and Front USBs***

These two connectors integrated on the edge of the board are used for linking with USB peripheral devices. This board also provides a connector F.USB for linking with the two USB sockets on the front panel of some system cases. Please note your operating system must support USB features, such as MS Windows 98, MS Windows 95 OSR2.5 with USB Supplement. (When two front USBs are used, two rear USBs will not work and vice versa).

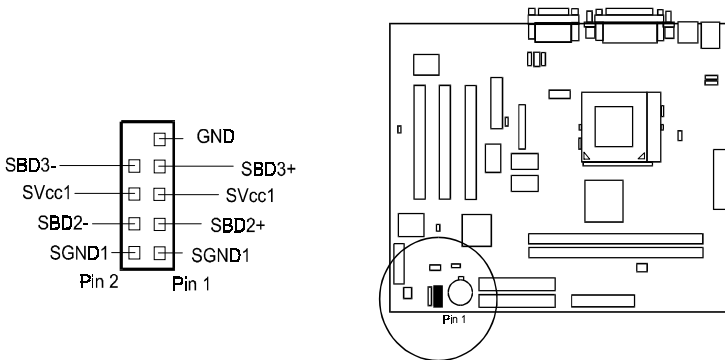

The figure above left is the pin assignment of the F.USB connector for two front panel USB connections.

### ***Serial Port Connectors: COM1, COM2***

COM1 (9-pin D-sub male connector) and COM2 (9-pin male connector) allow you to connect with your devices that use serial ports, such as a serial mouse or an external modem.

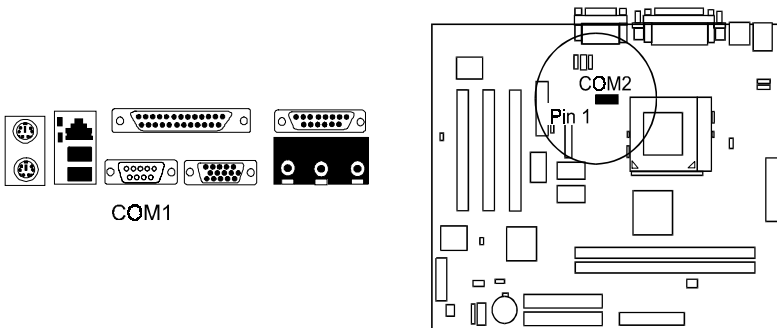

### ***Printer Connector: LPT***

This 25-pin D-Sub female connector is attached to your printer.

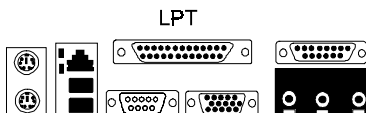

### ***Video Graphics Accelerator Connector: VGA***

This 15-pin female D-sub connector is connected to your display monitor.

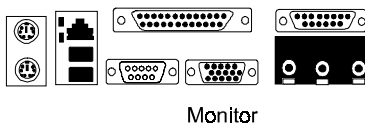

**GAME/MIDI Connector: GAME**

This 15-pin female connector allows you to connect game joysticks or game pads. Connect MIDI devices for playing or editing audio.

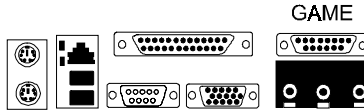

**Audio I/O Jacks: LINE\_OUT, LINE\_IN, MIC\_IN**

LINE\_OUT can be connected to headphones or preferably powered speakers. LINE\_IN allows tape players or other audio sources to be recorded by your computer or played through the LINE\_OUT. MIC\_IN allows microphones to be connected for voice input.

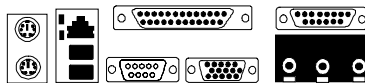

LINE\_OUT LINE\_IN MIC\_IN

**Local Area Network Jack: LAN (optional)**

Please plug your LAN cable into this jack to connect with your LAN and make sure the jumper LAN EN is set at Enable.

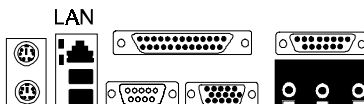

**This Page Left Blank for Note**

# Installation Procedures

The mainboard has several user-adjustable jumpers on the board that allow you to configure your system to suit your requirements. This chapter contains information on the various jumper settings on your mainboard.

To set up your computer, you must complete the following steps:

- Step 1 - Set system jumpers/switches
- Step 2 - Install memory modules
- Step 3 - Install the Central Processing Unit (CPU)
- Step 4 - Install expansion cards
- Step 5 - Connect ribbon cables, cabinet wires, and power supply
- Step 6 - Set up BIOS software
- Step 7 - Install supporting software tools



**WARNING:** Excessive torque may damage the mainboard. When using an electric screwdriver on the mainboard, make sure that the torque is set to the allowable range of 5.0 ~ 8.0kg/cm.

Mainboard components contain very delicate Integrated Circuit (IC) chips. To prevent static electricity from harming any of the mainboard's sensitive components, you should follow the following precautions whenever working on the computer:

1. Unplug the computer when working on the inside.
2. Hold components by the edges and try not to touch the IC chips, leads, or circuitry.
3. Wear an anti-static wrist strap which fits around the wrist.
4. Place components on a grounded anti-static pad or on the bag that came with the component whenever the components are separated from the system.

# Quick Reference (from Page 2-2 to 2-4)

## Mainboard Layout



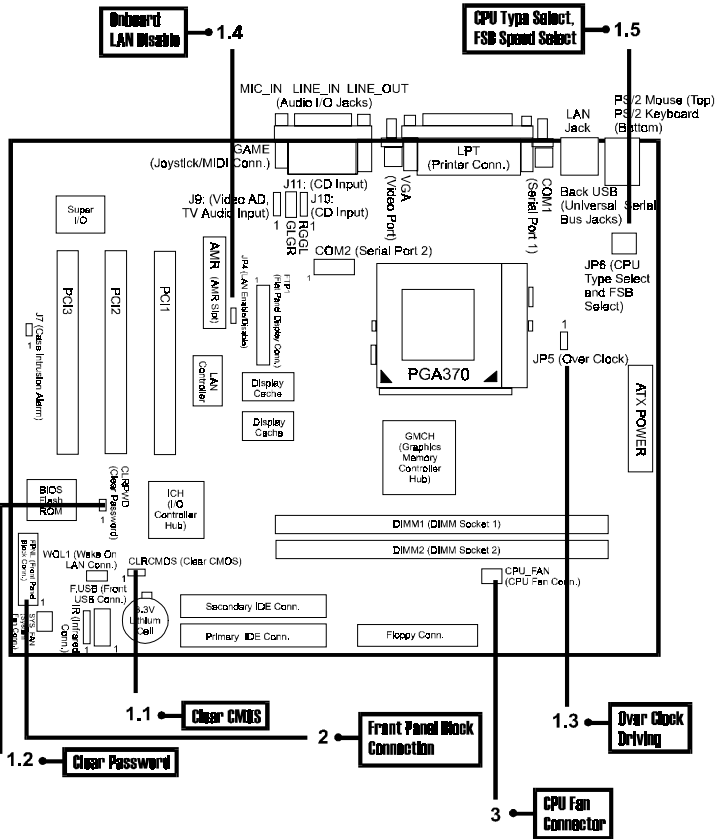



**Chapter 2**  
**Installation**  
**Procedures**

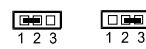

**Mfg. Optional Spec. of FW37, FW37(M), FW37(B)**

<b>FW37</b>	<b>FW37(M)</b>	<b>FW37(B)</b>
Intel 810E chipset	Intel 810E chipset	Intel 810 chipset
Support FSB 66/100/133MHz	Support FSB 66/100/133MHz	Support FSB 66/100MHz, No 133MHz
With AC-97	With AC-97	With AC-97
With 4MB Display Cache	Without 4MB Display Cache	Without 4MB Display Cache
With LAN	Without LAN	Without LAN
With Audio Alert	Without Audio Alert	Without Audio Alert

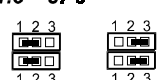
**1). Clear CMOS, Clear Password, Over Clock Driving, Onboard LAN Disable, CPU Type Select, FSB Speed Select**

<p><b>1.1 JP1</b></p>  <p><b>Normal (Default)</b>      <b>Clear CMOS</b></p>	<p><b>1.2 JP2</b></p>  <p><b>Clear Password (Default)</b>      <b>Normal</b></p>	<p><b>1.3 JP5</b></p>  <p><b>Over Clock Driving</b>      <b>Normal (Default)</b></p>
<p><b>1.4 JP4</b></p>  <p><b>Enable Onboard LAN (Default)</b>      <b>Disable Onboard LAN</b></p>	<p><b>1.5 JP6</b></p>  <p><b>Intel CPUs (Default)</b>      <b>Cyrix CPUs</b></p> <p><i>(for PCB 1.3)</i></p>	 <p><b>1-2: Cyrix Joshua</b>  <b>2-3: Intel Pentium III (Default)</b>  <b>5-6, 8-9: FSB Speed 66 MHz</b>  <b>5-6, 7-8: FSB Speed 100 MHz (Default)</b>  <b>4-5, 7-8: FSB Speed 133 MHz</b></p> <p><i>(for PCB 1.4 and above)</i></p>

## 2). Front Panel Block Cable Connection

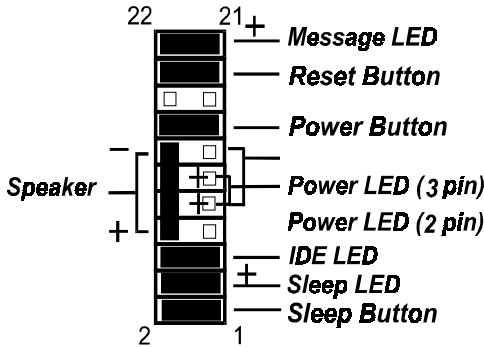

## 3). CPU Fan Installation

This connector is linked to the CPU fan. When the system is in suspend mode, the CPU fan will turn off; when it reverts back to full on mode, the fan will turn back on. Without sufficient air circulation, the CPU may overheat resulting in damage to both the CPU and the mainboard.

***Damage may occur to the mainboard and/or the CPU fan if these pins are used incorrectly. These are not jumpers, do not place jumper caps over these pins.***



## 1). Set System Jumpers

Jumpers are used to select the operation modes for your system. Some jumpers on the board have three metal pins with each pin representing a different function. A “1” is written besides pin 1 on jumpers with three pins. To **set** a jumper, a black cap containing metal contacts is placed over the jumper pin/s according to the required configuration. A jumper is said to be **shorted** when the black cap has been placed on one or two of its pins. The types of jumpers used in this manual are shown below:

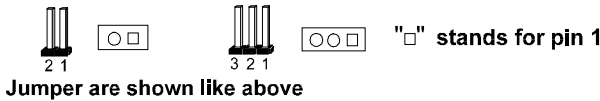
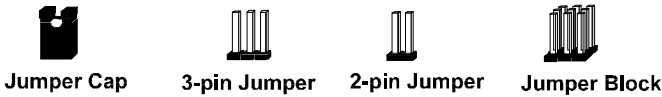

Jumpers in a Block



**NOTE:** Users are not encouraged to change the jumper settings not listed in this manual. Changing the jumper settings improperly may adversely affect system performance.

### **CMOS Clearance Function: JPI (CLRCMOS)**

The CMOS RAM is powered by the onboard button cell battery. To clear the RTC data: (1). Turn off your computer, (2). Move this jumper to Enable, (3). Move the jumper back to Disable, (4). Turn on your computer, (5). Hold down the Delete key during boot and enter BIOS Setup to re-enter user preferences.



**Normal  
(Default)**



**Clear  
CMOS**

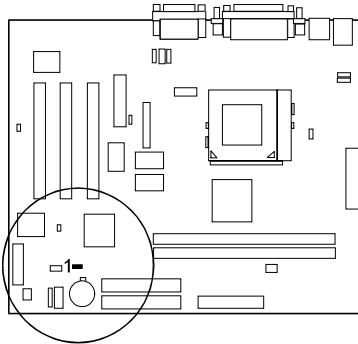

### **Password Clearance Function: JP2 (CLRPWD)**

This jumper allows you to enable or to disable the password configuration. You may need to enable this jumper by shorting it with a jumper cap if you forget your password. To clear the password setting: (1). Turn off your computer, (2). Short this jumper by placing a jumper cap on it; (3). Turn on your computer, (4). Hold down the Delete key during boot and enter BIOS Setup to re-enter user preferences, (5). Turn off your computer, (6). Remove the jumper cap, (7). Turn on your computer for the new settings to take ef



**Clear  
Password**



**Normal  
(Default)**

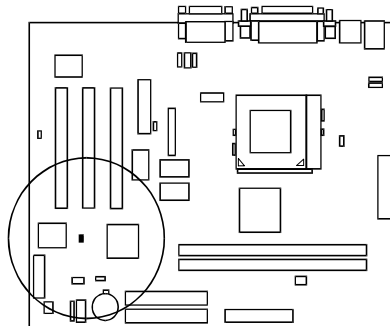

### ***Disabling Onboard LAN Feature: JP4***

The 2-pin jumper allows you to disable onboard LAN feature of your computer system if you install a LAN card.

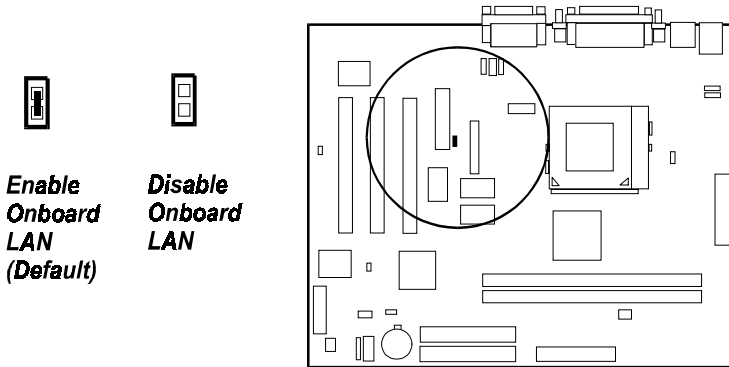

**Chapter 2  
Installation  
Procedures**

### ***Enabling Over Voltage Driving: JP5 (Magic Tuner)***

The 3-pin jumper allows you to start the over voltage driving capability of this mainboard to approach the best performance.



**WARNING:** Voltage and frequency above CPU's original specifications are not guaranteed to be stable.

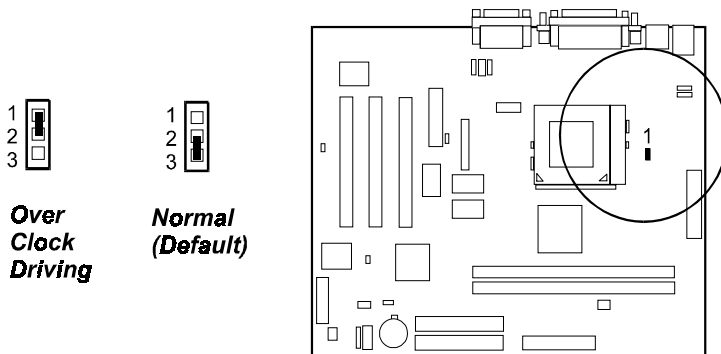

### *CPU Type Selection: JP6*

(for PCB 1.3) These two 3-pin jumpers are used together to select the CPU types that you will install.

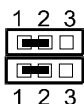

**Intel  
CPUs  
(Default)**

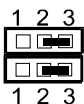

**Cyrix  
CPUs**

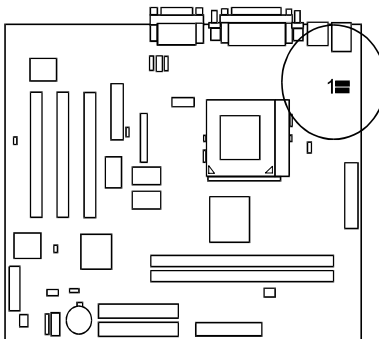

(for PCB 1.4 and above) The 3x3-pin jumper are used together to select the CPU types that you will install.

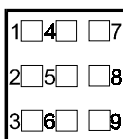

- 1-2: Cyrix Joshua**
- 2-3: Intel Pentium III  
(Default)**
- 5-6,  
8-9: FSB Speed 66 MHz**
- 5-6,  
7-8: FSB Speed 100 MHz  
(Default)**
- 4-5,  
7-8: FSB Speed 133 MHz**

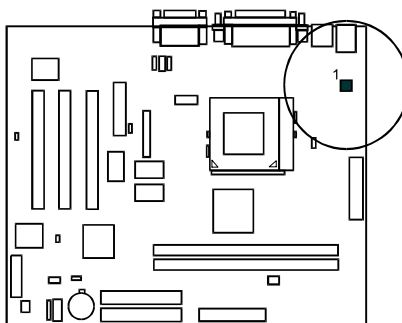

## 2). Install Memory Modules

This mainboard provides two onboard DIMM sockets supporting 3.3V (unbuffered) SDRAM DIMM modules. Either 32, 64, 128, 256MB DIMM can be installed on these three sockets. The maximum total memory supported is up to 512MB.

### Install and Remove DIMMs

1. Locate the DIMM slots on the mainboard.
2. Install the DIMM straight down into the DIMM slot using both hands.
3. The clip on both ends of the DIMM slot will close up to hold the DIMM in place when the DIMM reaches the slot's bottom.

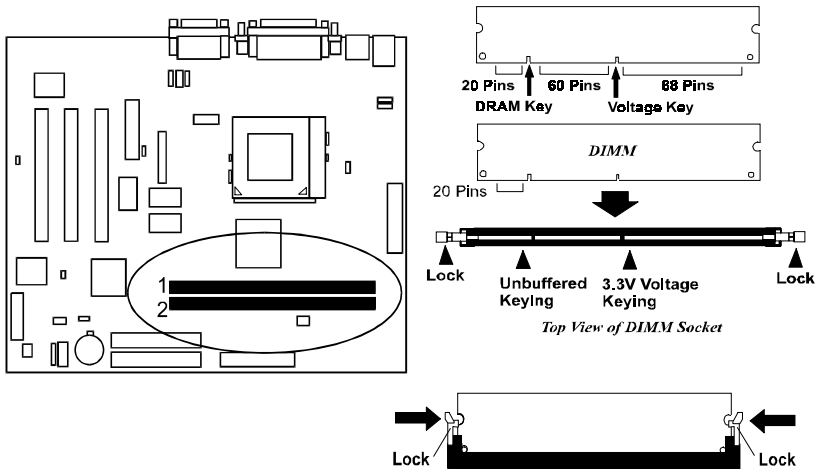

Press the clips with both hands to remove the DIMM.

### 3). Install the CPU

The mainboard has built-in Switching Voltage Regulator to support CPU Vcore autodetection. That is, It has the ability to detect and recognize the CPU voltage, clock, ratio and enables users to set up the CPU frequency from the BIOS Setup Screen. Users can adjust the frequency through “Frequency / Voltage Control” of the BIOS Setup Screen.

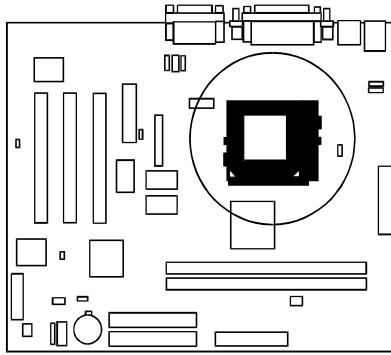

To install the CPU, do the following:

1. Lift the lever on the side of the CPU socket.
2. Handle the chip by its edges and try not to touch any of the pins.
3. Place the CPU in the socket. The chip has two notches to correctly locate the chip. Align two notches of the processor with the two triangular marks on the socket. Do not force the chip. The CPU should slide easily into the socket.
4. Swing the lever to the down position to lock the CPU in place.
5. Place the cooling fan with heatsink on top of the installed CPU.

### 4). Install Expansion Cards

This section describes how to connect an expansion card to one of your system’s expansion slots. Expansion cards are printed circuit boards that, when connected to the mainboard, increase the capabilities of your system. For example, expansion cards can provide video and sound capabilities. The mainboard features three PCI bus, one AMR slot for audio-modem riser card.

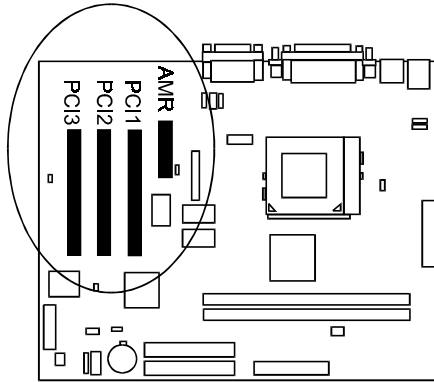

**CAUTION:** Make sure to unplug the power supply when adding or removing expansion cards or other system components. Failure to do so may cause severe damage to both the mainboard and expansioncards.

Always observe static electricity precautions.

Please read “Handling Precautions” at the start of this manual.

To install an expansion card, follow the steps below:

1. Remove the computer chassis cover and select an empty expansion slot.
2. Remove the corresponding slot cover from the computer chassis. Unscrew the mounting screw that secures the slot cover and pull the slot cover out from the computer chassis. Keep the slot cover mounting screw nearby.

3. Holding the edge of the peripheral card, carefully align the edge connector with the expansion slot.
4. Push the card firmly into the slot. Push down on one end of the expansion card, then the other. Use this “rocking” motion until the add-on card is firmly seated inside the expansion slot.
5. Secure the board with the mounting screw removed in Step 2. Make sure that the card has been placed evenly and completely into the expansion slot.
6. Replace the computer system’s cover.
7. Setup the BIOS if necessary.
8. Install the necessary software drivers for the expansion card.

## Connectors

### *Floppy Diskette Drive Connector: FDD*

This connector provides the connection with your floppy disk drive. The red stripe of the ribbon cable must be the same side with the Pin 1.

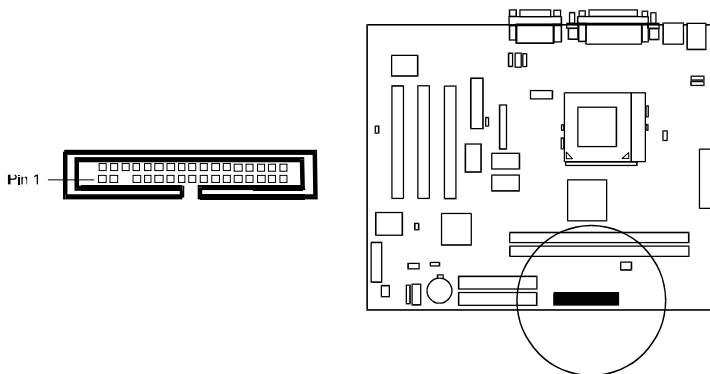



**IDE Device Connectors: PRIMARY, SECONDARY**

These two connectors are used for your IDE hard disk drives, CD drives, LS-120 drives, or IDE ZIP drives. The red stripe of the ribbon cable must be the same side with the Pin 1.

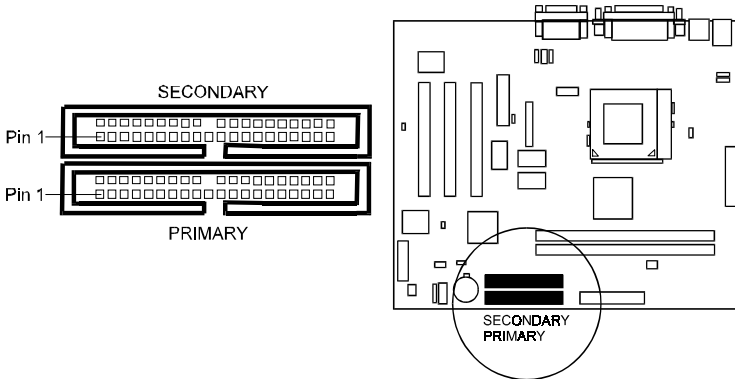

**Chapter 2  
Installation  
Procedures**

**Front Panel Block Connector: J1**

This block connector includes the connectors for linking with IDE LED, power LED, remote power button, message LED, suspend button, reset button and speaker on the front panel of the system case. Please identify polarities of plug wires for the case speaker and LEDs. Please ask vendor about this information when you buy them and install the system by yourself. The plug wires' polarities of these buttons will not affect the function.

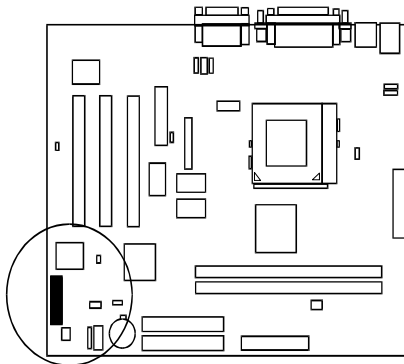

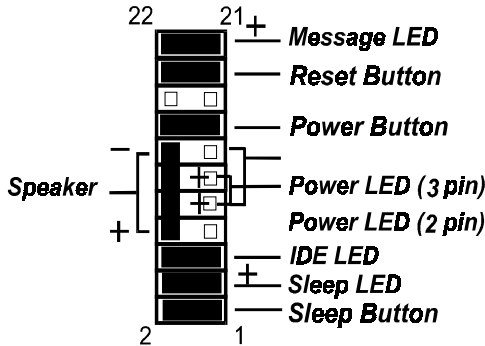

**Power LED** is connected with the system power indicator to indicate whether the system is on/off. It will blink when the system enters suspend mode.

**Remote Power Button** is connected with remote power (soft power) button. Push this switch This button allows the system to be turned on and off rather than using the power supply button.

**Message LED** is connected with the message LED. When the system is running normally, the indicator is off. It is controlled by the operating system or application software.

**Sleep Button** is connected with sleep mode button.

**Reset Button** is connected to the reset button. Push this switch to reboot the system instead of turning the power button off and on.

**Speaker** is connected with the case speaker.

**IDE LED** is connected to the IDE device indicator. This LED will blink when the hard disk drives are activated.

### ***ATX Power Connector: POWER***

This 20-pin male block connector is connected to the ATX power supply. The plug from the power supply will only insert in one orientation because of the different hole sizes. Find the proper orientation and push down firmly making sure that the pins are aligned.

+12V	10	20	+5V
5V_VR	9	19	+5V
PWR_GOOD	8	18	-5V
GND	7	17	GND
+5V	6	16	GND
GND	5	15	GND
+5V	4	14	-PWR_ON
GND	3	13	GND
+3.3V	2	12	-12V
+3.3V	1	11	+3.3V

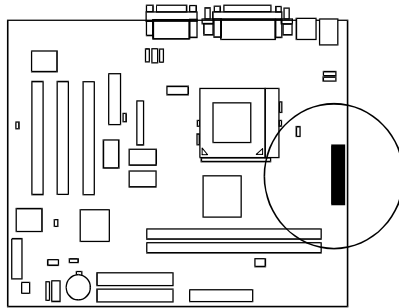

### ***CPU Fan Connector: FAN1***

This connector is linked to the CPU fan. When the system is in suspend mode, the CPU fan will turn off; when it reverts back to full-on mode, the fan will turn back on. Please refer to the CPU fan installation manual for more information.

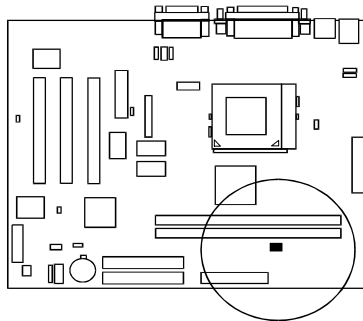
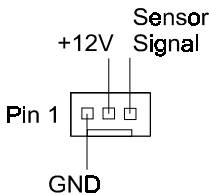

### ***System Case Fan Connector: FAN2***

There two 3-pin connectors onboard that either one allows you to link with the cooling fan on the system case to lower the system temperature.

**Chapter 2**  
**Installation**  
**Procedures**

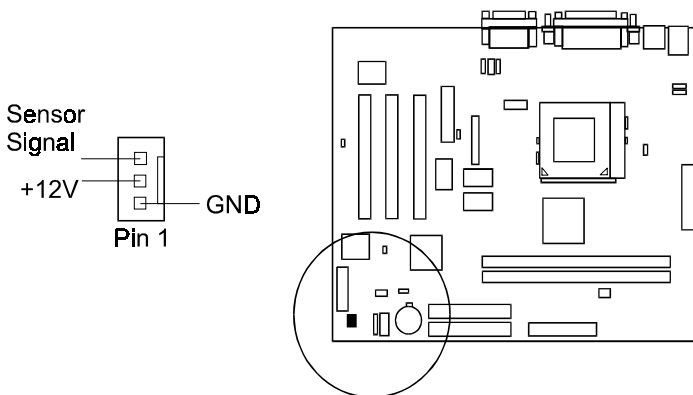

### ***Wake-On-Lan Connector: WOL1***

This 3-pin connector allows the remove servers to manage the system that installed this mainboard via your network adapter which also supports WOL. When you install such a LAN card, please read its installation guide for more information.

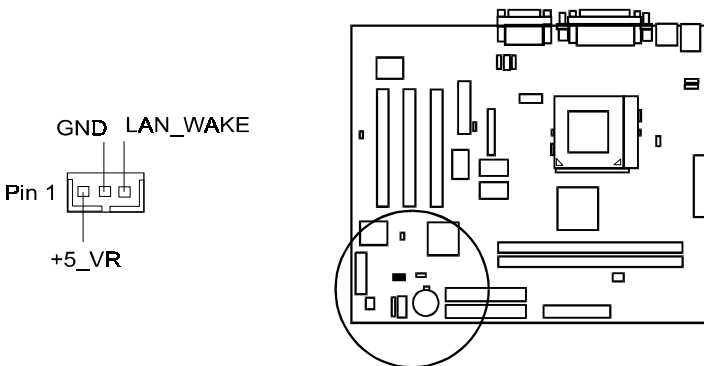

**CAUTION:**

Before connecting with the TV audio ribbon cable to VIDEO AD connector, make sure your system power is off. Failure to do so may cause damage to the mainboard.

***TV Audio Input Connector: J9 (VIDEO AD)***

This 1x4-pin connector is connected with your TV PCI card for taking the audio signal inputs through the card conversion. You can tune the TV program which display on your monitor together with your computer and a remote control.

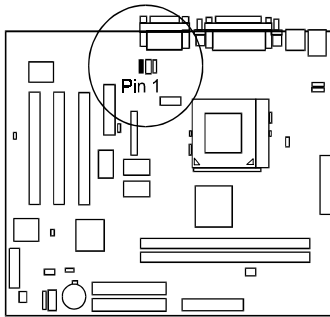
***Flat Panel Display Connector: FTP1  
(for specified customers)***

**(If PCB 1.3, it is reserved for specified customers. If PCB 1.4 and above, it is removed; , it is onboard only for specified customers.)**

This mainboard supports your flat panel display through this pinhead to a PCI converter card that outputs the signals to the display.

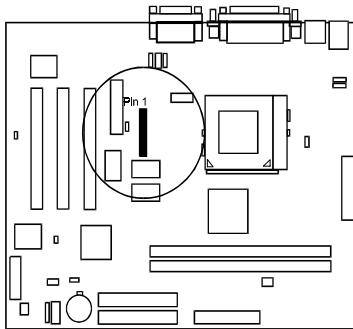

### ***Infrared Connector: IR***

This 5-pin connector is used to link with your ID device to allow transmission of data to another system that also supports the IR feature. This module mounts to a small opening on system cases that support it.

**Chapter 2**  
**Installation**  
**Procedures**

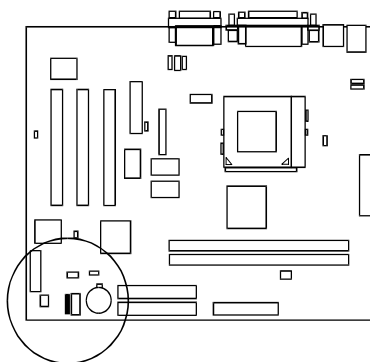
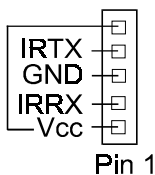

### ***CD Audio-In Connectors: J10, J11***

These two 4-pin connectors are used for different types of the AUDIO-OUT port of your CD drive.

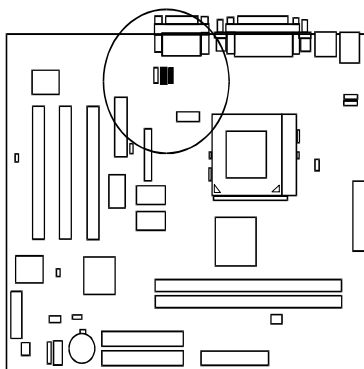
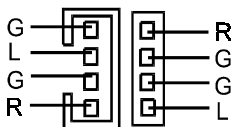

***PS/2 Keyboard and Mouse Connector: PS2\_KB, PS2\_MS***

These two 6-pin female connectors are used for your PS/2 keyboard and PS/2 mouse.

PS/2 Mouse

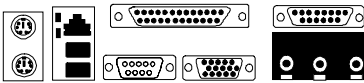

PS/2 Keyboard

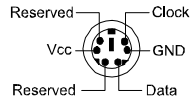

***Universal Serial Bus Connectors: Rear and Front USBs***

These two connectors integrated on the edge of the board are used for linking with USB peripheral devices. This board also provides a connector F.USB for linking with the two USB sockets on the front panel of some system cases. Please note your operating system must support USB features, such as MS Windows 98, MS Windows 95 OSR2.5 with USB Supplement. (When two front USBs are used, two rear USBs will not work and vice versa).

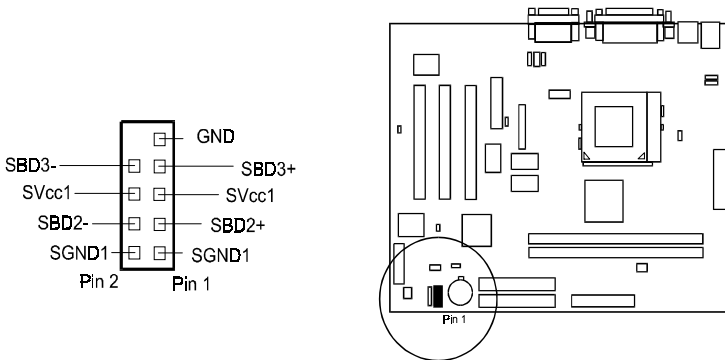

The figure above left is the pin assignment of the F.USB connector for two front panel USB connections.

### ***Serial Port Connectors: COM1, COM2***

COM1 (9-pin D-sub male connector) and COM2 (9-pin male connector) allow you to connect with your devices that use serial ports, such as a serial mouse or an external modem.

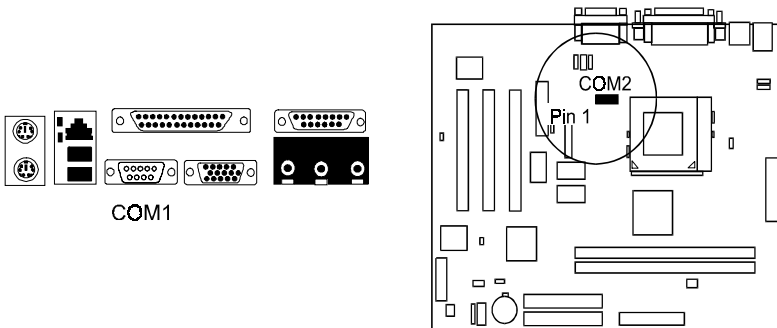

### ***Printer Connector: LPT***

This 25-pin D-Sub female connector is attached to your printer.

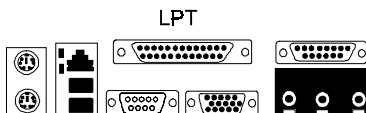

### ***Video Graphics Accelerator Connector: VGA***

This 15-pin female D-sub connector is connected to your display monitor.

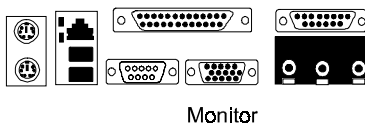



***GAME/MIDI Connector: GAME***

This 15-pin female connector allows you to connect game joysticks or game pads. Connect MIDI devices for playing or editing audio.

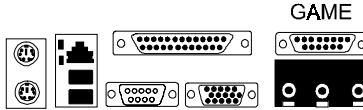

***Audio I/O Jacks: LINE\_OUT, LINE\_IN, MIC\_IN***

LINE\_OUT can be connected to headphones or preferably powered speakers. LINE\_IN allows tape players or other audio sources to be recorded by your computer or played through the LINE\_OUT. MIC\_IN allows microphones to be connected for voice input.

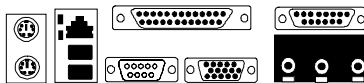

LINE\_OUT LINE\_IN MIC\_IN

***Local Area Network Jack: LAN (optional)***

Please plug your LAN cable into this jack to connect with your LAN and make sure the jumper LAN EN is set at Enable.

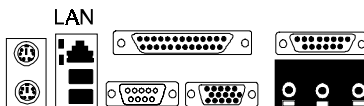

**This Page Left Blank for Note**

## BIOS Setup

The mainboard comes with the Award BIOS chip that contains the ROM Setup information of your system. This chip serves as an interface between the processor and the rest of the mainboard's components. This section explains the information contained in the Setup program and tells you how to modify the settings according to your system configuration.

### CMOS Setup Utility

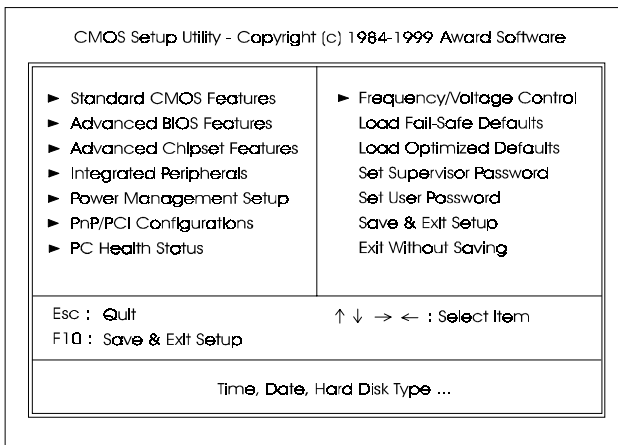

A Setup program, built into the system BIOS, is stored in the CMOS RAM. This Setup utility program allows changes to the mainboard configuration settings. It is executed when the user changes system configuration; user changes system backup battery; or the system detects a configuration error and asks the user to run the Setup program. Use the arrow keys to select and press **Enter** to run the selected program.



**NOTE:** Please disable this BIOS feature about BIOS Guardian before you start to reflash BIOS.  
(Please read Page 1-8, Page 3-6 for detail information).

## Standard CMOS Setup

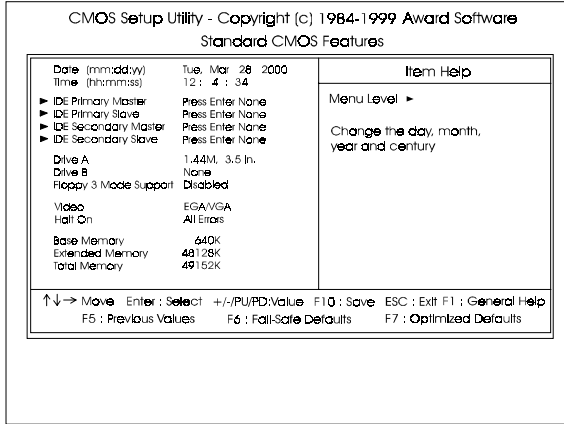

The Standard CMOS Setup screen is displayed above. Each item may have one or more option settings. The system BIOS automatically detects memory size, thus no changes are necessary. Use the arrow keys to highlight the item and then use **PgUp** or **PgDn** keys to select the value you want in each item.

### Hard Disk Configurations

**Capacity:** The hard disk size. The unit is Mega Bytes.

**Cylinder:** The cylinder number of the hard disk.

**Head:** The read/write head number of hard disk.

**Precomp:** The cylinder number at which the disk drive changes the write current.

**Landing Zone:** The cylinder number that the disk drive heads (read/write) are seated when the disk drive is parked.

**Sector:** The sector number of each track defined on the hard disk.

## Advanced BIOS Features

CMOS Setup Utility - Copyright (c) 1984-1999 Award Software

Advanced BIOS Features

		Item Help
Anti-Virus Protection	Enabled	Menu Level ►  Allows you to choose feature for IDE Hard Disk boot sector protection. If this function is enabled and someone attempt to write data into this area, BIOS will show a warning message on screen and alarm beep
CPU Internal Cache	Enabled	
External Cache	Enabled	
Processor Number Feature	Enabled	
First Boot Device	Floppy	
Second Boot Device	HDD-0	
Third Boot Device	CDROM	
Boot Other Device	Enabled	
Swap Floppy Drive	Disabled	
Boot Up Floppy Seek	Enabled	
Boot Up NumLock Status	On	
Gate A20 Option	Fast	
Memory Parity Check	Disabled	
Typeomatic Rate Setting	Disabled	
Typeomatic Rate (Chars/Sec)	6	
Typeomatic Delay (Msec)	250	
x Security Option	Setup	
x OS Select For DRAM > 64MB	Non-OS2	

↑↓→ Move    Enter : Select    +/-/PU/PD:Value    F10 : Save    ESC : Exit    F1 : General Help  
 F5 : Previous Values    F6 : Fail-Safe Defaults    F7 : Optimized Defaults

**Chapter 3  
BIOS Setup**

CMOS Setup Utility - Copyright (c) 1984-1999 Award Software

Advanced BIOS Features

		Item Help
External Cache	Enabled	Menu Level ►  Enabled to avoid virus Infect your BIOS. You will need to disable to update BIOS
Processor Number Feature	Enabled	
First Boot Device	Floppy	
Second Boot Device	HDD-0	
Third Boot Device	CDROM	
Boot Other Device	Enabled	
Swap Floppy Drive	Disabled	
Boot Up Floppy Seek	Enabled	
Boot Up NumLock Status	On	
Gate A20 Option	Fast	
Memory Parity Check	Disabled	
x Typeomatic Rate Setting	Disabled	
x Typeomatic Rate (Chars/Sec)	6	
Typeomatic Delay (Msec)	250	
Security Option	Setup	
OS Select For DRAM > 64MB	Non-OS2	
HDD S.M.A.R.T. Capability	Disabled	
Report No FDD For WIN 95	Yes	
BIOS Guardian	Enabled	

↑↓→ Move    Enter : Select    +/-/PU/PD:Value    F10 : Save    ESC : Exit    F1 : General Help  
 F5 : Previous Values    F6 : Fail-Safe Defaults    F7 : Optimized Defaults

### Anti-Virus Protection

This feature starts the virus scan tool to detect if boot virus in boot sector of the first hard disk drive when booting up.

The options are: Enabled (Default), Disabled.

### CPU Internal Cache

When enabled, improves the system performance. Disable this item when testing or trouble-shooting. The options are: Enabled (Default), Disabled.

### External Cache

When enabled, supports an optional cache SRAM. This feature allows you to disable the cache function when the system performance is unstable to run some software. The options are: Enabled (Default), Disabled.

### Processor Number Feature

If a Pentium III processor is installed on this mainboard, the system BIOS will allow other utilities to access the Intel Pentium III serial number while this feature set at Enabled. The options are: Enabled (Default), Disabled.

### Quick Power On Self Test

When enabled, allows the BIOS to bypass the extensive memory test.

The options are: Enabled (Default), Disabled.

### First Boot Device

This feature allows user to select the boot device priority.

The options are: Floppy (Default), LS120, HDD-0, SCSI, CDROM, HDD-1, HDD-2, HDD-3, ZIP100, LAN, Disabled.

### Second Boot Device

This feature allows user to select the boot device priority.

The options are: Floppy, LS120, HDD-0 (Default), SCSI, CDROM, HDD-1, HDD-2, HDD-3, ZIP100, LAN, Disabled.

### Third Boot Device

This feature allows user to select the boot device priority.

The options are: Floppy, LS120, HDD-0, SCSI, CDROM (Default), HDD-1, HDD-2, HDD-3, ZIP100, LAN, Disabled.

---

### Boot Other Device

This feature allows user to select the boot device priority.  
The options are: Enabled (Default), Disabled.

### Swap Floppy Drive

Allows you to switch the order in which the operating system accesses the floppy drives during boot up.  
The options are: Enabled, Disabled (Default).

### Boot Up Floppy Seek

When enabled, assigns the BIOS to perform floppy diskette drive tests by issuing the time-consuming seek commands.  
The options are: Enabled (Default), Disabled.

### Boot Up Numlock Status

When set to On, allows the BIOS to automatically enable the Num Lock Function when the system boots up. The options are: On (Default), Off.

### Gate A20 Option

When set at Fast, allows a faster access response under Protected mode.  
The options are: Fast (Default), Normal.

### Memory Parity Check

Enabling it will add a parity check to the boot-up memory tests. Set at Enabled only if the system DRAM contains parity.  
The options are: Disabled (Default), Enabled.

### Typematic Rate Setting

The term typematic means that when a keyboard key is held down, the character is repeatedly entered until the key is released.  
The options are: Disabled (Default), Enabled.

### Typematic Rate (Chars/Sec)

This feature is available only if the above item, Typematic Rate Setting, is set at Enabled. Sets the rate of a character repeat when the key is held down. The options are: 6 (Default), 8, 10, 12, 15, 20, 24, 30.

### Typematic Delay (Msec)

This feature is available only if the item, Typematic Rate Setting, is set at Enabled. Sets the delay time before a character is repeated.

The options are: 250 (Default), 500, 750, 1000 millisecond.

### Security Option

Allows you to set the security level of the system.

The options are: Setup (Default), System.

### OS Select For DRAM > 64MB

If your operating system (OS) is OS/2, select the option OS2. Otherwise, stay with the default setting Non-OS2.

The options are: Non-OS2 (Default), OS2.

### HDD S.M.A.R.T. Capability

S.M.A.R.T. stands for Self-Monitoring and Analysis Reporting Technology which allows your hard disk drive to report any read/write errors and issues a warning with LDCM installed.

The options are: Disabled (Default); Enabled.

### Report No FDD For WIN 95

When the field under the Standard CMOS Setup Menu for Drive A and/or Drive B is set at None, users must set this field is set at Yes for it to function properly. Otherwise, set at No, even if field for Drive A and/or Drive B is set at None, system will still detect and recognize of a floppy drive(s).

The options are: Yes, No (Default).

### Video BIOS Shadow

Allows the BIOS to copy the video ROM code of the add-on video card to the system memory for faster access.

The options are: Enabled (Default), Disabled.

### BIOS Guardian

It allows the system to prevent computer viruses. Users will need to disable it to update BIOS. The options are: Enabled (Default), Disabled.



**NOTE:** Please disable this BIOS feature about BIOS Guardian before you start to reflash BIOS.



## Advanced Chipset Features

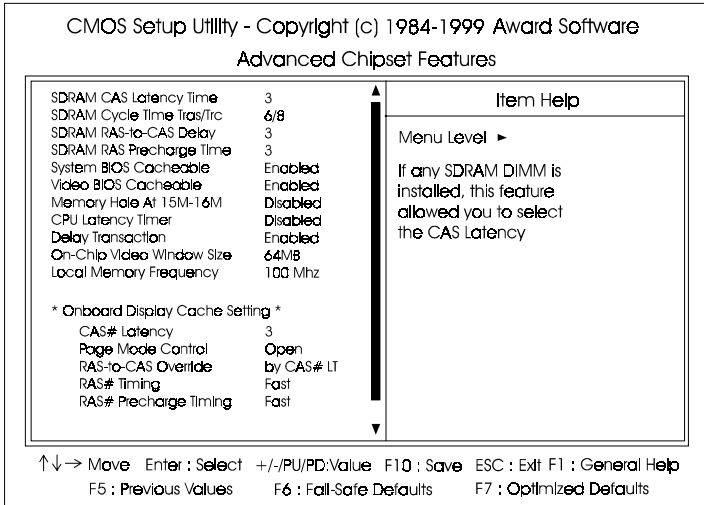

### SDRAM CAS Latency Time

If the CAS latency of your installed SDRAM DIMM is 2, set it at 2 to enhance system performance. If the CAS latency is 3, stay with the default setting of 3. The options are: 3 (Default); 2.

### SDRAM Cycle Time Tras/Trc

This item controls the number system clock for an access cycle. The options are: 6/8 (Default); 5/7.

### SDRAM RAS-to-CAS Delay

This item, which is available only when the above item Auto Configuration is set at *Disabled*, allows you to define the time delay from DRAM CAS# active to CAS# active, depending on the CPU frequency and DRAM type used, whether 2 clocks or 3 clocks. The options are: 3 (Default); 2.

### SDRAM RAS Precharge Time

This item, which is available only when the above item Auto Configuration is set at Disabled, allows you to select the DRAM RAS# precharge time whether 3 clocks or 4 clocks. The options are: 3 (Default); 2.

### System BIOS Cacheable

When enabled, allows the ROM area of F000H-FFFFH to be cacheable when the cache controller is activated.

The options are Enabled (default), Disabled.

### Video BIOS Cacheable

As with caching the system BIOS above, enabling the video BIOS cache will cause access to the video BIOS addressed at C0000H-C7FFFH to be cached, if the cache controller is also enabled.

The options are Enabled (default), Disabled.

### Memory Hole at 15M-16M

Enabling this feature reserves between 15MB and 16MB memory address space for expansion cards that specifically require this setting. This makes the memory for 15MB to 16MB unavailable to the system. Expansion cards can only access memory above 16MB.

The options are Disabled (Default), Enabled.

### CPU Latency Timer

CPU latency item setting to fix Japanese Win 95 problem.

The options are Disabled (Default), Enabled.

### Delayed Transaction

When enabled, it allows the current PCI bus master to retry the current PCI bus master cycle and to accept the new PCI bus master request. It re-accepts the original PCI bus master and returns data to the original PCI bus master, thereby enhancing system performance.

The options are: Disabled; Enabled (Default).

### On-Chip Video Window Size

This feature allows you to select the main memory frame size of AGP use.

The options are: 64MB (Default), 32MB, Disabled.

### Local Memory Frequency

This item allows users to select the SDRAM frequency.  
The options are: 100MHz (Default); 133MHz.

### CAS# Latency

When the display cache onboard, this item allows you to select CAS Latency. The options are: 3 (Default); 2.

### Paging Mode Control

This feature allows users to open or close the GMCH memory controller page mode. The options are: 3 (Default); 2.

### RAS-to-CAS Override

This feature allows users to select the unit of cache clock periods.  
The options are: by CAS#LT (Default); Override (2).

### RAS# Timing

This feature allows users to control RAS# active to precharge, and refresh to RAS# active delay (in local memory clocks).  
The options are: Fast (Default); Slow.

### RAS# Precharge Timing

This feature allows users to control RAS# precharge (in local memory clocks). The options are: Fast (Default); Slow.

## Integrated Peripherals

CMOS Setup Utility - Copyright (c) 1984-1999 Award Software

Integrated Peripherals

On-Chip Primary PCI IDE	Enabled	<p>Item Help</p> <p>Menu Level ▶</p> <p>When enabled, allows you to use the onboard primary PCI IDE.</p>
On-Chip Secondary PCI IDE	Enabled	
IDE Primary Master PIO	Auto	
IDE Primary Slave PIO	Auto	
IDE Secondary Master PIO	Auto	
IDE Secondary Slave PIO	Auto	
IDE Primary Master UDMA	Auto	
IDE Primary Slave UDMA	Auto	
IDE Secondary Master UDMA	Auto	
IDE Secondary Slave UDMA	Auto	
USB Controller	Enabled	
USB Keyboard Support	Enabled	
Init Display First	PCI Slot	
AC97 Audio	Auto	
AC97 Modem	Auto	
IDE HDD Block Mode	Enabled	
POWER ON Function		
KB Power ON Password	Enter	
Hot Key Power ON	Ctrl-F1	

↑↓→ Move Enter : Select +/-/PU/PD:Value F10 : Save ESC : Exit F1 : General Help  
F5 : Previous Values F6 : Fall-Safe Defaults F7 : Optimized Defaults

CMOS Setup Utility - Copyright (c) 1984-2000 Award Software

Integrated Peripherals

POWER ON Function		<p>Item Help</p> <p>Menu Level ▶</p> <p>The feature can let you select Midi IRQ if the Midi Enabled</p>
KB Power ON Password	Enter	
Hot Key Power ON	Ctrl-F1	
Onboard FDC Controller	Enabled	
Onboard Serial Port 1	3F8/IRQ4	
Onboard Serial Port 2		
UART Mode Select	Hi, Lo	
X Rx/D, Tx/D Active	Enabled	
IR Transmission Delay	Half	
UR2 Duplex Mode	IR-Rx2Tx2	
Use IR Pins		
Onboard Parallel Port		
Parallel Port Mode		
EPP Mode Select	EPP1.7	
ECP Mode Use DMA	3	
PWRON After PWR-Fail	Former-Sts	
Game Port Address	201	
Midi Port Address	330	
Midi Port IRQ	10	

↑↓→ Move Enter : Select +/-/PU/PD:Value F10 : Save ESC : Exit F1 : General Help  
F5 : Previous Values F6 : Fall-Safe Defaults F7 : Optimized Defaults

---

### On-Chip Primary PCI IDE

When enabled, it allows you to use the onboard primary PCI IDE. The options are: Enabled (Default); Disabled.

### On-Chip Secondary PCI IDE

When enabled, it allows you to use the onboard secondary PCI IDE. The options are: Enabled (Default); Disabled.

### IDE Primary Master PIO

Allows an automatic or a manual configuration of the PCI primary IDE hard drive (master) mode. The options are: Auto (Default); Mode 0; Mode 1; Mode 2; Mode 3; Mode 4.

### IDE Primary Slave PIO

Allows an automatic or a manual configuration of the PCI primary IDE hard drive (slave) mode. The options are: Auto (Default); Mode 0; Mode 1; Mode 2; Mode 3; Mode 4.

### IDE Secondary Master PIO

Allows an automatic or a manual configuration of the PCI secondary IDE hard drive (master) mode. The options are: Auto (Default); Mode 0; Mode 1; Mode 2; Mode 3; Mode 4.

### IDE Secondary Slave PIO

Allows an automatic or a manual configuration of the PCI secondary IDE hard drive (slave) mode. The options are: Auto (Default); Mode 0; Mode 1; Mode 2; Mode 3; Mode 4.

### IDE Primary Master UDMA

Allows an automatic configuration of the PCI primary IDE hard drive (master) mode if Ultra DMA is supported both on the motherboard and the hard disk. The options are: Auto (Default); Disabled.

### IDE Primary Slave UDMA

Allows an automatic configuration of the PCI primary IDE hard drive (slave) mode if Ultra DMA is supported both on the motherboard and the hard disk. The options are: Auto (Default); Disabled.

### IDE Secondary Master UDMA

Allows an automatic configuration of the PCI secondary IDE hard drive (master) mode if Ultra DMA is supported both on the motherboard and the hard disk. The options are: Auto (Default); Disabled.

### IDE Primary Slave UDMA

Allows you to select the first PCI IDE channel of the first slave hard disk mode or to detect it by the BIOS if the hard disk supports UDMA (Ultra DMA, faster than DMA). The options are: Auto (Default), Disabled.

### USB Controller

Disable this option if you are not using the onboard USB feature.  
The options are: Disabled (Default); Enabled.

### BIOS Support USB Keyboard

When a USB keyboard is installed, please set at Enabled.  
The options are: Enabled (Default); Disabled.

### Init Display First

When you install an AGP VGA card and a PCI VGA card on the board, this feature allows you to select the first initiation of the monitor display from which card. The options are: PCI Slot (Default), Onboard.

### AC97 Audio

This feature allows users to enable or disable the AC97 audio function.  
The options are: Auto (Default), Disabled.

### AC97 Modem

This feature allows users to enable or disable the AC97 modem function.  
The options are: Auto (Default), Disabled.

### IDE HDD Block Mode

When enabled, the system executes read/write requests to hard disk in block mode. The options are: Enabled (Default), Disabled.

## POWER ON Function

Allows you to set the method for powering-on the system. The default option of *BUTTON-ONLY* allows system power-on using the standard system case mounted ON/OFF switch. The option *Password* allows you to set up to 5 alphanumeric characters to power-on the system. The option *Hot KEY* allows you to set which of the 12 keyboard function keys (**F1** to **F12**) in combination with the **Ctrl** key to power-on the system. The option *Mouse Click* allows you to use the PS/2 mouse to power-on the system by double-clicking on the mouse button. The options are: Button Only (Default); Password; Hot KEY; Mouse Right, Mouse Left.



**NOTE:** When using Password, Hot KEY, or Mouse Click options for the item POWER ON Function will render the power button on the system case ineffective. In case user forgets password or hot key setting, use the clear password switch or jumper to clear RTC data (refer to section about clear password on Chapter 2). Another method is to unplug system power from the AC power outlet and then re-insert the power cord. Previous password and hot key settings will be disabled allowing user to set a new one.

## Hot Key power ON

Allows you to set which of the 12 keyboard function keys (F1 to F12) in combination with the Ctrl key will be used to power-on the system. The options are: Ctrl-F1 (default) up to Ctrl-F12.

## Onboard FDC Controller

When enabled, the floppy diskette drive (FDD) controller is activated. The options are: Enabled (Default), Disabled.

## Onboard Serial Port 1

If the serial port 1 uses the onboard I/O controller, you can modify your serial port parameters. If an I/O card needs to be installed, COM3 and COM4 may be needed. The options are: 3F8/IRQ4 (Default), 3E8/IRQ4, 2F8/IRQ3, 2E8/IRQ3, Disabled.

### Onboard Serial Port 2

If the serial port 2 uses the onboard I/O controller, you can modify your serial port parameters. If an I/O card needs to be installed, COM3 and COM4 may be needed. The options are: 2F8/IRQ3 (Default), 3E8/IRQ4, 2E8/IRQ3, 3F8/IRQ4, Disabled.

### UART Mode Select

Allows you to select the IR modes if the serial port 2 is used as an IR port. Set at Standard, if you use COM2 as the serial port as the serial port, instead as an IR port. The options are: HPSIR, ASKIR, Normal (Default).

### RxD , TxD Active

This feature is available only if the item, UART 2 Mode, is set at ASKIR or HPSIR. The feature allows you to select the active signals of the reception end and the transmission end. This is for technician use only. The options are: Hi, Lo (Default); Hi, Hi; Lo, Hi; Lo, Lo.

### IR Transmission Delay

When Enabled, the transmission delays 4 characters-time (40 bit-time) if SIR is changed from RX mode to TX mode. When Disabled, no transmission delay if SIR is changed from RX mode to TX mode. The options are: Enabled (Default), Disabled.

### UR2 Duplex Mode

Allows you to select the IR modes. The options are: Half (Default), Full.

### Use IR Pins

Allows you to select IR pin mode. The options are: IR-Rx2Tx2 (Default), RxD2, TxD2.

### Onboard Parallel Port

Allows you to select from a given set of parameters if the parallel port uses the onboard I/O controller. The options are: 378/IRQ7 (Default), 278/IRQ5, 3BC/IRQ7, Disabled.



### Parallel Port Mode

Allows you to connect with an advanced printer via the port mode it supports.

The options are: SPP (Default), EPP, ECP, ECP+EPP.

### EPP Mode Select

This feature allows you to select the EPP type version.

The options are: EPP1.7 (Default), EPP1.9.

### ECP Mode Use DMA

This feature allows you to select Direct Memory Access (DMA) channel if the ECP mode selected. The options are: 3 (Default), 1.

### PWRON After PWR-Fail

When the system is shut down owing to the power failure, the system will not be back to power on by itself. This feature allows you to set the system back to which power status of the system when the system power is resumed. The options are Former-Sts (Default), On, or Off.

### Game Port Address

This feature allows you to select the game port address or disable it.

The options are: 201 (Default), 209, Disabled.

### Midi Port Address

This feature allows you to select the Midi port address or disable it.

The options are: 330 (Default), 300, 290, Disabled.

### Midi Port IRQ

It allows you to select Midi IRQ if Midi is enabled.

The options are: 10 (Default), 5.

## Power Management Setup

CMOS Setup Utility - Copyright (c) 1984-1999 Award Software

Power Management Setup

ACPI Function	Enabled	<p>Item Help</p> <p>Menu Level ▶</p> <p>The item allows you to enable Advance configuration Power Management function.</p>
ACPI Suspend Type	S1 (POS)	
Power Management	User Define	
Video Off Method	DPMS	
Video Off In Suspend	Yes	
Suspend Type	Stop Grant	
MODEM Use IRQ	3	
Suspend Mode	Disabled	
HDD Power Down	Disabled	
Soft-Off by PWR-BTTN	Instant-Off	
Wake-Up by PCI card	Disabled	
Power On by Ring	Enabled	
Wake Up On LAN	Enabled	
CPU Thermal-Throttling	50.0%	
Resume by Alarm	Disabled	
x Date (of Month) Alarm	0	
x Time (hh:mm:ss) Alarm	0 0 0	
** Reload Global Timer Events **		

↑↓→ Move Enter : Select +/-/PU/PD:Value F10 : Save ESC : Exit F1 : General Help  
F5 : Previous Values F6 : Fail-Safe Defaults F7 : Optimized Defaults

CMOS Setup Utility - Copyright (c) 1984-1999 Award Software

Power Management Setup

MODEM Use IRQ	3	<p>Item Help</p> <p>Menu Level ▶</p> <p>When PCI PIRQ# has been alerted, system timer will be reloaded and system will be not into suspend mode.</p>
Suspend Mode	Disabled	
HDD Power Down	Disabled	
Soft-Off by PWR-BTTN	Instant-Off	
Wake-Up by PCI card	Disabled	
Power On by Ring	Enabled	
Wake Up On LAN	Enabled	
CPU Thermal-Throttling	50.0%	
Resume by Alarm	Disabled	
x Date (of Month) Alarm	0	
x Time (hh:mm:ss) Alarm	0 0 0	
** Reload Global Timer Events **		
Primary IDE 0	Disabled	
Primary IDE 1	Disabled	
Secondary IDE 0	Disabled	
Secondary IDE 1	Disabled	
FDD, COM, LPT Port	Disabled	
PCI PIRQ(A-D)#	Disabled	

↑↓→ Move Enter : Select +/-/PU/PD:Value F10 : Save ESC : Exit F1 : General Help  
F5 : Previous Values F6 : Fail-Safe Defaults F7 : Optimized Defaults

---

### ACPI function

This item allows you to disable the ACPI function.  
The options are: Enabled (Default), Disabled.

### ACPI Suspend Type

This item allows you to select suspend mode when the system in ACPI mode. The options are: S1 (POS) (Default), S3 (PTR).

### Power Management

This item allows you to adjust the power management features.

Select User Define for configuring your own power management features. Min Saving initiates all predefined timers in their minimum values. Max Saving, on the other hand, initiates maximum values. The options are: User Define (Default), Min Saving, Max Saving.

### Video Off Method

The option *V/H SYNC+Blank* allows the BIOS to blank off screen display by turning off the V-Sync and H-Sync signals sent from add-on VGA card. *DPMS* allows the BIOS to blank off screen display by your add-on VGA card which supports DPMS (Display Power Management Signaling function). *Blank Screen* allows the BIOS to blank off screen display by turning off the red-green-blue signals.

The options are: V/H SYNC+Blank, DPMS (Default), Blank Screen.

### Video Off In Suspend

The option allows you to select VGA status when the system goes to suspend mode. The options are: Yes (Default), No.

### Suspend Type

The option allows you to select VGA status when the system goes to suspend mode. The options are: Stop Grant (Default), PwrOn Suspend.

### HDD Power Down

The option lets the BIOS turn the HDD motor off when system is in Suspend mode. Selecting 1 Min..15 Min allows you define the HDD idle time before the HDD enters the Power Saving Mode.

The options 1 Min..15 Min will not work concurrently. When HDD is in the Power Saving Mode, any access to the HDD will wake the HDD up.

The options are: Disable (Default), 1 Min..15 Min.

### Soft-Off by PWR-BTTN

The selection Delay 4 Sec. will allow the system shut down after 4 seconds after the power button is pressed. The selection Instant-Off will allow the system shut down immediately once the power button is pressed.

The settings are: Delay 4 Sec, Instant-Off (Default).

### Wake-Up by PCI card

When set at Enabled, any PCI-PM event awakes the system from a PCI-PM controlled state. The options are Disabled (Default) or Enabled.

### Power On by Ring

An incoming call via modem awakes the system from its soft-off mode.

The options are Enabled (Default) or Disabled.

### Wake Up On LAN

When set at Enabled, an input signal comes from the other client/server on the LAN awakes the system from a soft off state if connected over LAN.

The options are Disabled or Enabled (Default).

### CPU Thermal-Throttling

When thermal override condition occur, this item allows users to determine the duty cycle of the throttling.

The options are: 12.5%, 25.0%, 37.5%, 50.0% (Default), 62.5, 75.0%, 87.5%.

### MODEM Use IRQ

This feature allows you to select the IRQ# to meet your modem's IRQ#.

The options are: 3 (Default), 4, 5, 7, 9, 10, 11.

---

### Resume by Alarm

This feature allows you to set the when the system being turned on from the system power-off status.

The options are: Enabled (Default), Disabled.

### Date (of Month)

This feature allows you to set the day of the alarm starts when the RTC Alarm Resume From Soft Off is set to be Enabled. The options are: 0, 1..31.

### Timer (hh:mm:ss)

If an ATX power supply is installed and when RTC Alarm Resume is Enabled, this feature allows you to set the time of the alarm starts when the RTC Alarm Resume From Soft Off is set to be Enabled.

The options are: 7: 0: 0 (Default). hh (*hour*) - 0, 1, 2,..., 23; mm (*minute*) - 0, 1, 2,...,59; ss (*second*) - 0, 1, 2,...,59.

### Primary IDE 0

When the primary master HDD is working, the system timer will be reloaded and the system will not be into the suspend mode.

The options are: Disabled (Default), Enabled.

### Primary IDE 1

When the primary slave HDD is working, the system timer will be reloaded and the system will not be into the suspend mode.

The options are: Disabled (Default), Enabled.

### Secondary IDE 0

When the secondary master HDD is working, the system timer will be reloaded and the system will not be into the suspend mode.

The options are: Disabled (Default), Enabled.

### Secondary IDE 1

When the secondary slave HDD is working, the system timer will be reloaded and the system will not be into the suspend mode.

The options are: Disabled (Default), Enabled.

**FDD, COM, LPT Port**

When FDD, COM, or LPT is working, the system timer will be reloaded and the system will not be into the suspend mode.

The options are: Disabled (Default), Enabled.

**PCI PIRQ[A-D]#**

When the PCI PIRQ[A-D]# has been alerted, the system timer will be reloaded and the system will not be into the suspend mode.

The options are: Disabled (Default), Enabled.

**PnP/PCI Configurations**

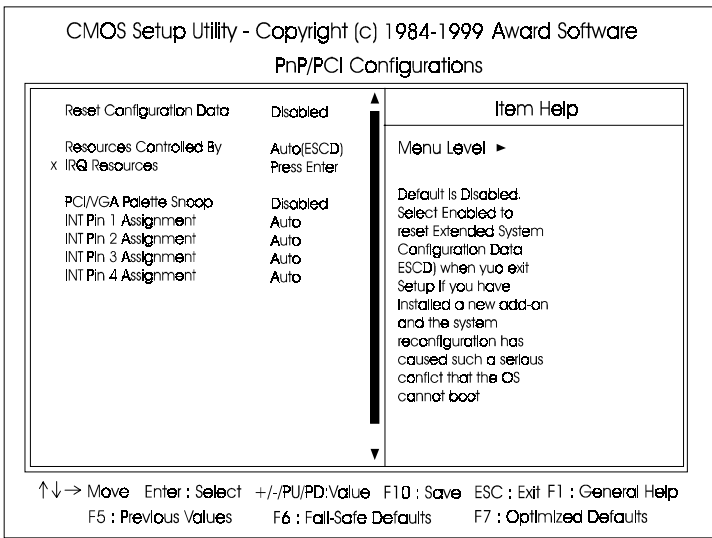

---

### Reset Configuration Data

Enabling it to reset the system Extended System Configuration Data (ESCD) when you exit Setup if you have installed a new add-on card and the system reconfiguration has caused such a serious conflict that the operating system can not boot. The options are: Disabled (Default), Enabled.

### Resources Controlled By

If set at Auto, the BIOS arranges all system resources. If there exists conflict, select Manual. The options are: Auto (ESCD) (Default), Manual.

### IRQ Resources

If resources are controlled manually, assign each system interrupt a type, depending on the device type using the interrupt.

### IRQ-3/4/5/7/9/10/11/12/14/15

Legacy ISA for devices compliant with the original PC AT bus specification, PCI/ISA PnP for devices compliant with PnP standard whether designed for PCI or ISA bus architecture.

The options are: PCI Device (Default), Reserved.

### PCI/VGA Palette Snoop

Set this feature to be enabled if any ISA adapter card installed in the system requires the VGA palette snoop function.

The options are: Disabled (Default), Enabled.

### INT Pin 1/2/3/4 Assignment

This feature allows you to assign the PCI IRQ numbers for PCI slots. Selecting the default, Auto, allows the PCI controller to automatically allocate the IRQ numbers.

The options are: Auto (Default), 3, 4, 5, 7, 9, 10, 11, 12, 14, 15.

## PC Health Status

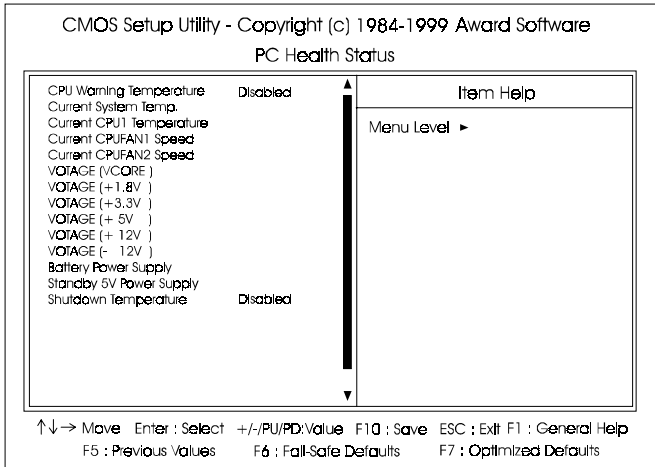

### CPU Warning Temperature

This feature allows you to set the temperature to slow down the CPU clock frequency.

The options are: Disabled (Default), 50°C/122°F, 53°C/127°F, 56°C/133°F, 60°C/140°F, 63°C/145°F, 66°C/151°F, 70°C/158°F.

### Current System Temp. / Current CPU1 Temperature / Current CPUFAN1 Speed / Current CPUFAN1 Speed / Current CPUFAN2 Speed / VOTAGE / Batter Power Supply / Standard 5V Power Supply

These items allow end users and technicians to monitor data provided by the BIOS on this mainboard. It is not user-configurable.

### Shutdown Temperature

When Windows 98 ACPI mode installed, this feature helps to shutdown the system when the system temperature is as high as the selected temperature to prevent from the overheat problem.

The options are: 60°C/140°F, 65°C/149°F, 70°C/158°F, 75°C/167°F, Disabled (Default).



## Frequency/Voltage Control

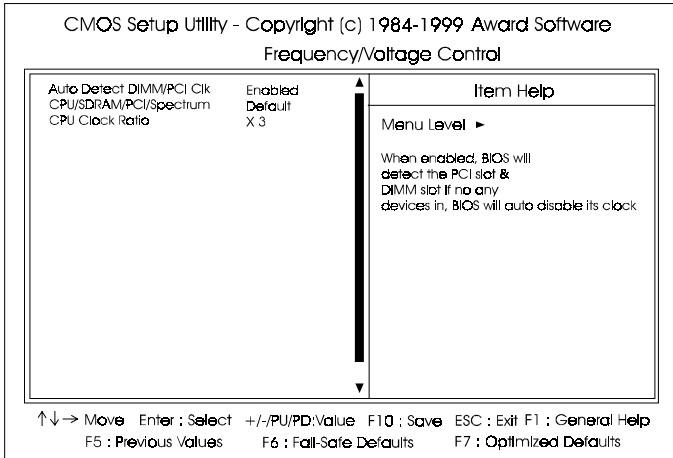

This submenu allows you to configure the frequency and voltage of your processor.

### Auto Detect DIMM/PCI Clk

When set at Enabled, the system BIOS will detect the PCI slots and DIMM slots. If a slot is found no device on it, the system BIOS will automatically disable the slot clock.

The options are: Enabled (Default), Disabled.

### CPU/SDRAM/PCI/Spectrum

This feature is used to set the CPU, SDRAM, PCI clock frequencies. The option list provides all available combinations provided by this system.

### CPU Clock Ratio

This feature allows you to select the frequency multiplier for CPU host clock. The option list offers the ratios from X 3 to X 8.

## Load Fail-Safe Defaults

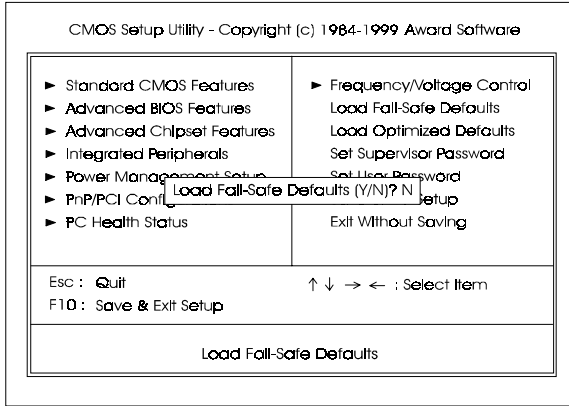

This submenu is selected to diagnose the problem after the computer boots, if the computer will not boot. These settings do not give optimal performance.

## Load Optimized Defaults

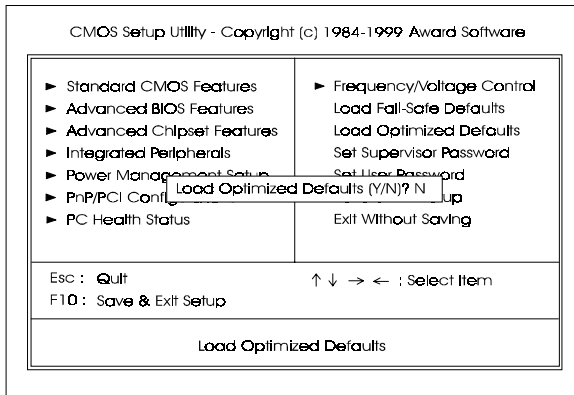

This submenu is selected for settings which provide the best system performance.



## Save and Exit Setup

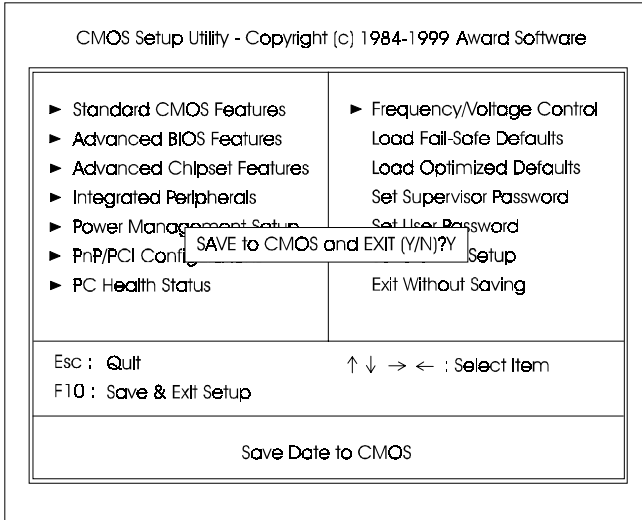

After you have made changes under Setup, press Esc to return to the main menu. Move cursor to Save and Exit Setup or press F10 and then press Y to change the CMOS Setup. If you did not change anything, press Esc again or move cursor to Exit Without Saving and press Y to retain the Setup settings. The following message will appear at the center of the screen to allow you to save data to CMOS and exit the setup utility: **SAVE to CMOS and EXIT (Y/N)?**

## Exit without Saving

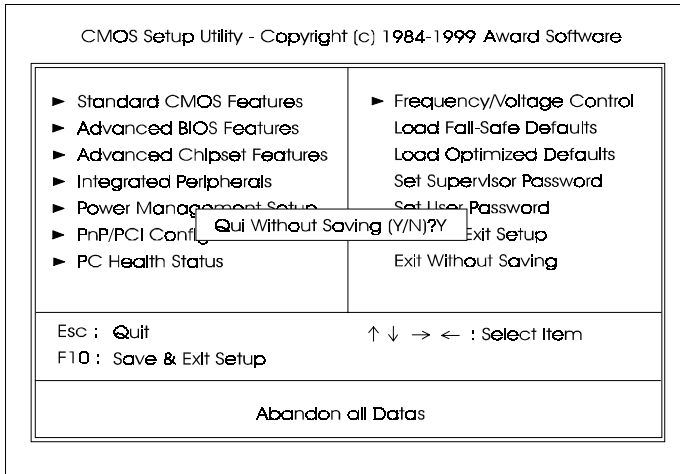

If you select this feature, the following message will appear at the center of the screen to allow you to exit the setup utility without saving CMOS modifications: **Quit Without Saving (Y/N)?**