

SYSTEM BOARD D1107

*ADDITIONAL TECHNICAL
MANUAL*

Is there ...

... any technical problem or other question you need clarified?

Please contact:

- Our Hotline:
 - Mo-Fr: 8 a.m. - 6 p.m.
 - Sat: 9 a.m. - 2 p.m.
 - Tel.: ++49 (0) 180 3777 005
- your sales outlet

The latest information on our products, tips, updates, etc., can be found on the Internet under:
<http://www.fujitsu-siemens.com>



Dieses Handbuch wurde auf Recycling-Papier gedruckt.
This manual has been printed on recycled paper.
Ce manuel est imprimé sur du papier recyclé.
Este manual ha sido impreso sobre papel reciclado.
Questo manuale è stato stampato su carta da riciclaggio.
Denna handbok är tryckt på recyclingpapper.
Dit handboek werd op recycling-papier gedrukt.

Herausgegeben von/Published by
Fujitsu Siemens Computers GmbH

Bestell-Nr./Order No.: **A26361-D1107-Z180-10-7619**
Printed in the Federal Republic of Germany
AG 0100 01/00



A26361-D1107-Z180-1-7619

English

System Board D1107

Additional Technical Manual

January 2000 edition

Copyright © Fujitsu Siemens Computers GmbH 2000

Intel, Pentium and Celeron are registered trademarks and MMX and OverDrive are trademarks of Intel Corporation, USA.

Microsoft, MS, MS-DOS and Windows are registered trademarks of Microsoft Corporation.

PS/2 and OS/2 Warp are registered trademarks of International Business Machines, Inc.

All other trademarks referenced are trademarks or registered trademarks of their respective owners, whose protected rights are acknowledged.

All rights, including rights of translation, reproduction by printing, copying or similar methods, even of parts are reserved.

Offenders will be liable for damages.

All rights, including rights created by patent grant or registration of a utility model or design, are reserved. Delivery subject to availability.

Right of technical modification reserved.

Contents

Introduction.....	1
Notational conventions	1
Features	2
Mechanics	3
Connectors and Jumpers.....	5
i°C connector (for ambient/external temperature sensor) for optional temperature sensor (LM75).....	5
Internal chipcard reader or serial port 2 (COM2) (external via wire)	5
Power supply ATX connector.....	6
Wake on LAN (WOL) connector.....	6
Power on switch connector (ON/OFF switch).....	6
Fan 2 connector for system fan or CPU fan (if external temperature sensor is in use)	6
Front panel connector (version 1)	7
Front panel connector (version 2)	8
USB chipcard reader connector	9
Fan 1 connector for CPU fan or system fan (if external temperature sensor is in use)	9
Power supply monitoring.....	9
Intrusion connector for case open detect for optional push-button (opener).....	10
System configurations	10
Hardware requirements	11
BIOS options	12
Messages	12
Configuration	13
Clock frequency.....	13
Functions controlled by the switch block	14
Power	14
Power requirement	14
Power loadability.....	15
Documentation	15
Installing drivers	15
Upgrades.....	15
Main memory.....	15
Troubleshooting.....	16
Message BIOS update.....	16
The screen stays blank.....	16

Introduction



This system board is available in different configuration levels. Depending on the hardware configuration of your device, it may be that you cannot find several options in your version of the system board, even though they are described.

You may find further information e. g. in the complete Technical Manual for the system board and in the description "BIOS Setup". For detailed information see chapter "[Documentation](#)".

Further information to drivers is provided on the supplied drivers diskettes or on the "Drivers & Utilities" or "ServerStart" CD. For detailed information please look at chapter "[Installing drivers](#)". The latest BIOS version or drivers can be found on the internet under

<http://www.siemens.de/computer/service>.

Notational conventions

The meanings of the symbols and fonts used in this manual are as follows:



Pay particular attention to texts marked with this symbol. Failure to observe this warning endangers your life, destroys the system, or may lead to loss of data.



Supplementary information, remarks and tips follow this symbol.

- ▶ Texts which follow this symbol describe activities that must be performed in the order shown.
- ␣ This symbol means that you must enter a blank space at this point.
- ↵ This symbol means that you must press the Enter key.

Texts in this typeface are screen outputs.

Texts in this bold typeface are the entries you make via the keyboard.

Texts in italics indicate commands or menu items.

"Quotation marks" indicate names of chapters and terms that are being emphasized.

Features

Function	D1107-A	D1107-B
Processor socket	Slot 1	Slot 1
Processor	Intel Celeron or Pentium II or Pentium III	Intel Celeron or Pentium II or Pentium III
Formfactor	ATX	ATX
Front Side Bus in MHz	66/100	66/100
Chipset	440BX	440BX
Memory sockets	3 DIMM	3 DIMM
ISA slots	1	1
PCI slots	4	4
ISA/PCI shared	1	1
AGP-Port	1	1
System monitoring	x	x
Thermal Management	x	x
Wake On LAN	x	x
Keyboard On	x	x
IrDA		
Chipcard reader	x	x
Save to Disk (ACPI S4)	x	x
Save to RAM(ACPI S3)	x	x
LAN onboard	x	--
Audio onboard	--	--
VGA onboard	--	--
4MB Display Cache	--	--



Computer system boards and components contain very delicate IC chips. To protect them against damage caused from electric static, you have to follow some precautions:

- Unplug your computer when you work inside.
- Hold components by the edge, don't touch their leads.
- Use a grounded wrist strap.

Place the system board and the components on a grounded antistatic pad whenever you work outside the computer.

Once you have installed the system board, you should remove the battery protection (i.e. the thin plastic plate between battery and contact spring).

Mechanics

Layout

ATX 12" x 8" (304,8 mm x 203,2 mm)

Some of the following connectors are optional and may therefore not be included on your system board.

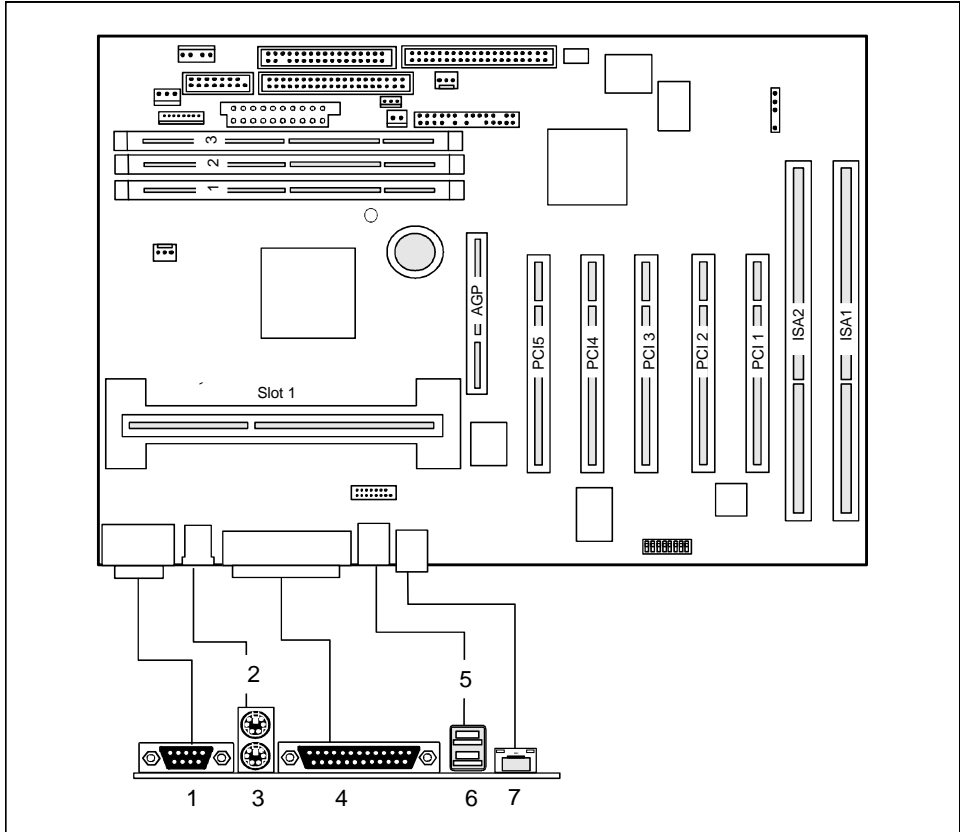

- 1 = Serial port 1
- 2 = PS/2 mouse port
- 3 = PS/2 keyboard port

- 4 = Parallel port
- 5 = USB connection 2
- 6 = USB connection 1
- 7 = LAN port

The components and connectors marked do not have to be present on the system board.

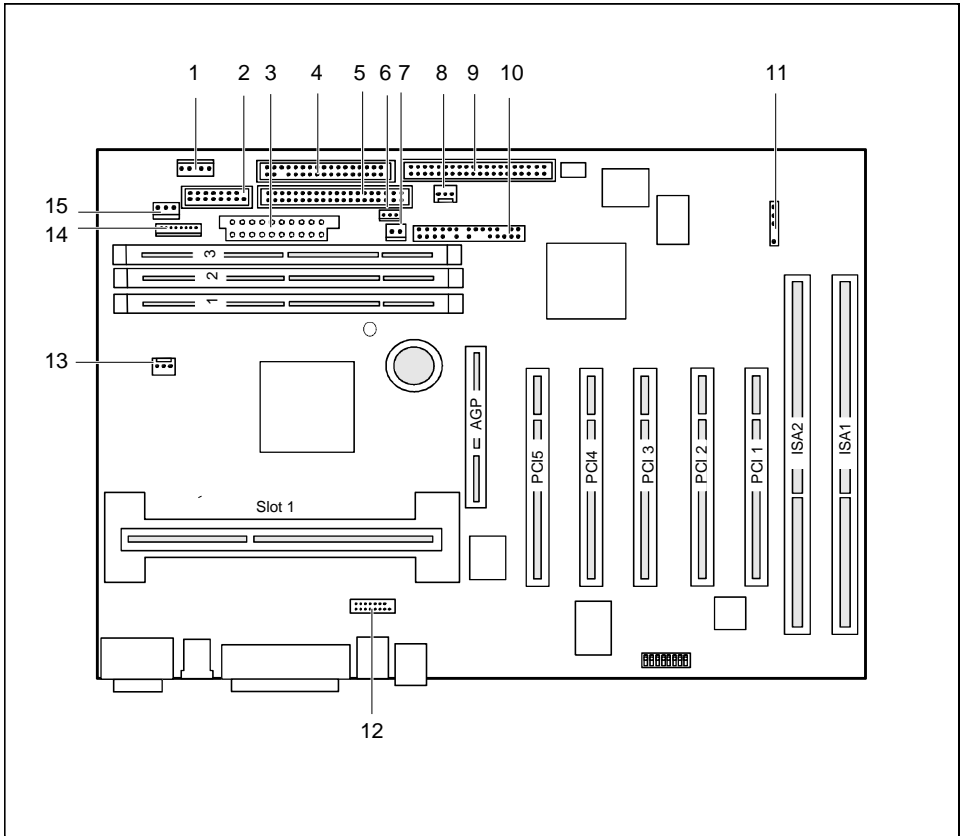

- 1 = I²C connector (for temperature sensor)
- 2 = Internal chipcard reader or serial port 2
- 3 = Power supply
- 4 = Floppy disk drive
- 5 = IDE drives 3 and 4 (secondary)
- 6 = Wake On LAN
- 7 = ON/OFF switch
- 8 = Fan 2

- 9 = IDE drives 1 and 2 (primary)
- 10 = Front panel connector
- 11 = IrDA
- 12 = USB chipcard reader
- 13 = Fan 1 (e. g. for the processor)
- 14 = Power supply monitoring
- 15 = Intrusion connector *

The components and connectors marked do not have to be present on the system board.

*: For correct installation please refer to chapter "Temperature monitoring / system monitoring" in the Technical Manual.

Connectors and Jumpers



Some of the following connectors are optional!

I²C connector (for ambient/external temperature sensor) for optional temperature sensor (LM75)

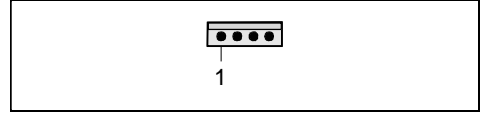

Pin	Signal
1	3.3 V standby
2	Clock
3	Data
4	GND

Refer to chapter "Temperature monitoring / system monitoring" in the Technical Manual.

Internal chipcard reader or serial port 2 (COM2) (external via wire)

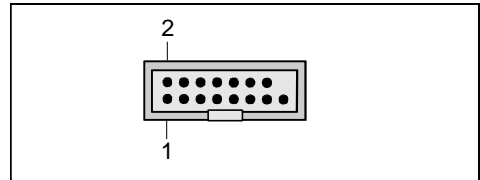

Pin	Signal	Pin	Signal
1	DCD 2 (low asserted)	2	DSR 2 (low asserted)
3	SIN 2 (high asserted)	4	RTS 2 (low asserted)
5	SOUT 2 (high asserted)	6	CTS 2 (low asserted)
7	DTR 2 (low asserted)	8	PC_ON Strobe
9	GND	10	VCC Auxiliary
11	EXT SMI (low asserted)	12	VCC
13	RESETDRV (high asserted)	14	GND
15	GND	16	Key

Power supply ATX connector

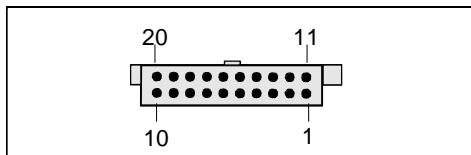

Pin	Signal	Pin	Signal
1	+3.3 V	2	+3.3 V
3	GND	4	+5 V
5	GND	6	+5 V
7	GND	8	Powergood (high asserted)
9	+5 V Auxiliary	10	+12 V
11	+3.3 V	12	-12 V
13	GND	14	PS on (low asserted)
15	GND	16	GND
17	GND	18	-5 V
19	+5 V	20	+5 V

Wake on LAN (WOL) connector

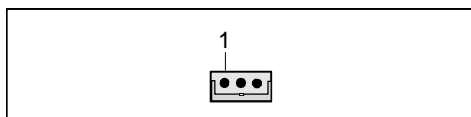

Pin	Signal
1	+5 V Auxiliary
2	GND
3	Wake pulse (high asserted)

Power on switch connector (ON/OFF switch)

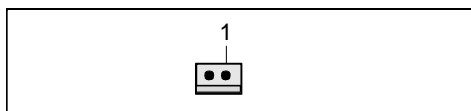

Pin	Signal
1	GND
2	Power on pulse (low asserted)

Fan 2 connector for system fan or CPU fan (if external temperature sensor is in use)

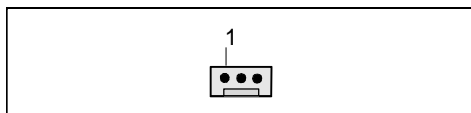

Pin	Signal
1	GND
2	+12 V
3	Fan sense

Refer to chapter "Temperature monitoring / system monitoring" in the Technical Manual.

Front panel connector (version 1)

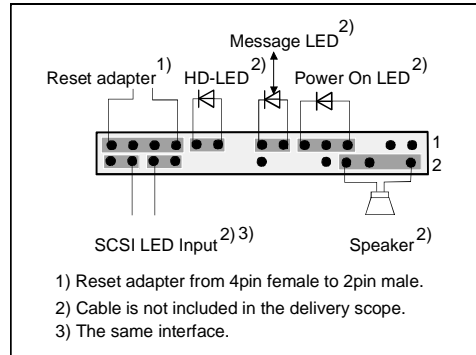

Pin	Signal	Pin	Signal
1	Reserved	2	Speaker
3	Anode Standby LED	4	Key
5	Key	6	GND
7	Anode PON_LED	8	VCC
9	Not connected	10	Key pin
11	Cathode PON_LED (GND)	12	Key
13	Anode Message LED	14	Key
15	Cathode Message LED	16	Key pin
17	Key	18	Key
19	Anode HD_LED	20	Key
21	Cathode HD_LED	22	Key
23	GND (for Reset and Power button)	24	Not connected
25	Power Button	26	SCSI LED Input
27	Not connected	28	SCSI LED Input
29	Reset Button	30	Not connected

Front panel connector (version 2)

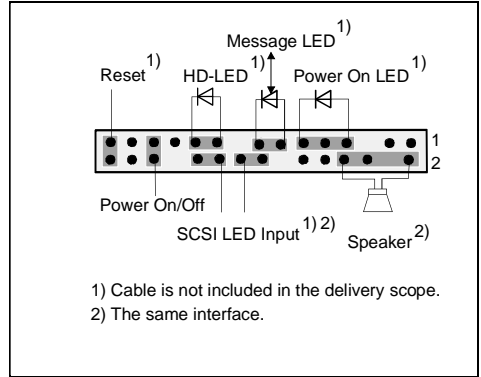

Pin	Signal	Pin	Signal
1	Reserved	2	Speaker
3	Anode Standby LED	4	Key
5	Key	6	GND
7	Anode PON_LED	8	VCC
9	Not connected	10	Key pin
11	Cathode PON_LED (GND)	12	Key pin
13	Anode Message LED	14	Key
15	Cathode Message LED	16	Not connected
17	Key	18	SCSI LED Input
19	Anode HD_LED	20	SCSI LED Input
21	Cathode HD_LED	22	Not connected
23	GND (for Reset and Power button)	24	Key
25	Power Button	26	GND
27	Not connected	28	GND
29	Reset Button	30	GND

USB chipcard reader connector

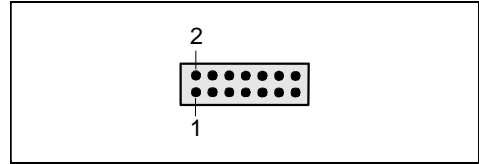

Pin	Signal	Pin	Signal
1	P3V3P_DUAL	2	VCC
3	Data negative output up	4	Data positive up
5	Data negative	6	Data positive down
7	GND	8	GND
9	Chipcard present (high asserted)	10	VCC Auxiliary
11	P3V3P	12	Power OK (low asserted)
13	Chipcard reader On (low pulse)	14	Key

Fan 1 connector for CPU fan or system fan (if external temperature sensor is in use)

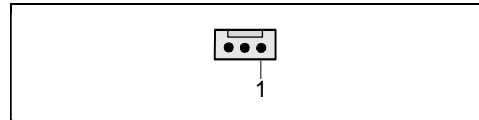

Pin	Signal
1	GND
2	6 - 12 V; 0 V
3	Fan sense

Refer to chapter "Temperature monitoring / system monitoring" in the Technical Manual.

Power supply monitoring

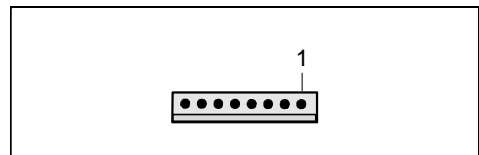

Pin	Signal
1	Monitor on
2	PS FAN off request (low asserted)
3	PS FAN full on (low asserted)
4	PS FAN pulse
5	SMB CLK
6	SMB DATA
7	VCC EEPROM
8	GND

Refer to chapter "Temperature monitoring / system monitoring" in the Technical Manual.

Intrusion connector for case open detect for optional push-button (opener)

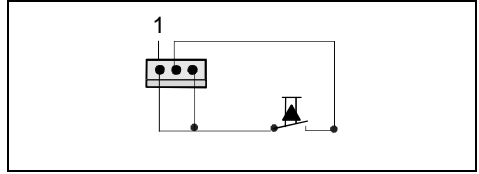

Pin	Signal
1	GND
2	Case open (low asserted)
3	Present (low asserted)

Refer to chapter "Temperature monitoring / system monitoring" in the Technical Manual.

System configurations

Systems with ...		Standard ATX power supply		
Example		1	2	3
		Standard	Workstation	Server
T0	processor temperature	Sensor in CPU integrated		
T1	system temperature	Sensor onboard		
T2	external temperature via optional LM75 sensor	--	--	yes
Fan 0				
	destination	--	--	--
	supervision	--	--	--
	control	--	--	--
Fan 1				
	destination	processor fan	processor fan	system fan
	supervision	yes	yes	yes
	control	yes (0 V, 6-12 V)	yes (0 V, 6-12 V)	yes (0 V, 6-12 V)
Fan 2				
	destination	--	system fan	system fan
	supervision	--	yes	yes
	control	--	no (12 V)	no (12 V)

Systems with ...		Extended ATX power supply		
Example		1	2	3
		Standard	Workstation	Server
T0	processor temperature	Sensor in CPU integrated		
T1	system temperature	Sensor onboard		
T2	external temperature via optional LM75 sensor	--	--	yes
Fan 0				
	destination	power supply fan		
	supervision	yes		
	control	yes (0 V, 6-12 V)		
Fan 1				
	destination	--	--	system fan
	supervision	--	--	yes
	control	--	--	yes (0 V, 6-12 V)
Fan 2				
	destination	--	--	processor fan
	supervision	--	--	yes
	control	--	--	no (12 V)

Hardware requirements

Power supply:

Power supply fan must be controllable by system board (22KHz PWM signal with 3.3V) and needs a sense-pin for rpm-measurement.

Fan sense:	2 ripples per rotation
Ripple pulse width:	T low and T high > 0.6 ms
Number of revolutions	at 100% PWM: maximum 14000 Rpm at 50% PWM: minimum 800 Rpm
e.g.:	Siemens S26113-E425 or. E427

Mechanics

Fan:

The fan speed must be controllable from 6 - 12 V (start voltage: 12 V). Therefore the fan must have a mechanical suitability as well as a 3-pole-plug with a sense-pin for rpm-measurement.

Fan sense:	2 ripples per rotation
Ripple pulse width:	T low and T high > 0.6 ms
Current:	blocking fan at 12 V: 1.6 A rotating fan at 6V / 12V: 0.3A / 0.6 A
number of revolutions	at 12V: maximum 14000 Rpm at 6V: minimum 800 Rpm
e.g.:	Papst type 412 F/2H as processor fan

Sensor for internal temperature:

Housing temperature is read by an onboard sensor.

CPU temperature is read by an onboard sensor but only with processors which have an integrated temperature diode.

Sensor for external temperature:

Use only a Siemens Sensor: e.g. T26139-Y3718-V1

Intrusion logic:

Push-button (type: opener, if housing is open pins 1 and 2 are connected).

BIOS options

Please refer to BIOS description on the including CD-ROM (menu *Advanced System Management*).

Messages

Message LED:

The Message LED (frontpanel connector) shows two different states

A slow blinking (once a second) of the LED signals that any application has received a message. (ACPI- mode)

A fast blinking (five times a second) of the LED signals a hardware problem. More detailed information are shown with an additional System Monitoring Software or on the monitor after reboot entering BIOS Setup (menu *Advanced System Management*).

The fast blinking LED can have several different causes.

- a necessary sensor is missing or defect
- an available sensor has overtemperature
- a fan is defect or not working properly
- a software is responsible for blinking

BIOS: Please refer to BIOS description on the including CD-ROM.

Configuration

Clock frequency



The switches may only be set as specified in the tables below for the particular Pentium II or Celeron used.

There are also Pentium II and Celeron processors, which automatically always operate at the proper frequency, regardless of the switch position.

As these new processors do not differ externally from the previous processors, we recommend always setting the switches in accordance with the processor.

This system board you may use with Pentium II processors with 66 MHz and 100 MHz Front Side Bus or with Celeron processors with 66 MHz Front Side Bus

Information on which processors can be used is available from your sales office or the customer service center.

Pentium II with 66 MHz Front Side Bus:

Processor	switch 5	switch 6	switch 7	switch 8
300 MHz	off	on	off	on
333 MHz	on	off	off	on

Celeron with 66 MHz Front Side Bus:

Processor	switch 5	switch 6	switch 7	switch 8
233 MHz	off	off	on	on
266 MHz	on	on	off	on
300 MHz	off	on	off	on
333 MHz	on	off	off	on
366 MHz	off	off	off	on
400 MHz	on	on	on	off
433 MHz	off	on	on	off
466 MHz	on	off	on	off
500 MHz	off	off	on	off
533 MHz	on	on	off	off

Pentium II with 100 MHz Front Side Bus:

Processor	switch 5	switch 6	switch 7	switch 8
350 MHz	off	off	on	on
400 MHz	on	on	off	on
450 MHz	off	on	off	on

Pentium III with 100 MHz Front Side Bus:

Processor	switch 5	switch 6	switch 7	switch 8
450 MHz	off	on	off	on
500 MHz	on	off	off	on
550 MHz	off	off	off	on
600 MHz	on	on	on	off
650 MHz	off	on	on	off
700 MHz	on	off	on	off
750 MHz	off	off	on	off
800 MHz	on	on	off	off

Functions controlled by the switch block

Function	SW1 PWS	SW2 RCV	SW3 FWP	SW4 AUX
Password Skip	on	X	X	X
Off	off	X	X	X
Recovery BIOS	X	on	X	X
Off	X	off	X	X
Floppy write protect	X	X	on	X
Off	X	X	off	X



Switch 4 (SW4) is reserved!

Power

Power requirement

Source	Voltage	Maximum variation	Maximum current	Comment
Main power supply	+5.1 V	±5 %	15 A	
Main power supply	+12 V	±10 %	300 mA	
Main power supply	-12 V	±10 %	100 mA	
Main power supply	+3.3 V	±5 %	4 A	
Auxiliary power supply	+5.0 V	±5 %	50 mA	without Save-to-RAM, Wake On LAN and PCI bus auxiliary power support
Auxiliary power supply			1 A	with Save-to-RAM, Wake On LAN and PCI bus auxiliary power support
Onboard power supply	1.8 - 3.5 V	±5 %	14 A	

Power loadability

Fuse number	Maximum Fuse current	Function	Maximum function current
1	750 mA	Universal serial bus (USB) Port A	500 mA
		Keyboard	Not specified
		Mouse	Not specified
2	750 mA	Universal serial bus (USB) Port B	500 mA

Documentation

- ▶ Insert the "Drivers & Utilities" CD.
- ▶ If the CD does not start automatically, run the *START.EXE* file in the main directory of the CD.
- ▶ Select your system board or your device.
- ▶ Select *Documentation*.
- ▶ Select - *Technical Manuals*
- ▶ Select - *Technical Manuals (BIOS)*



You may have to install the Acrobat Reader - Software on the CD-ROM (path *utls/acrobat*) before reading!

For more details please read the according *readme.txt* files.

Installing drivers

- ▶ Insert the "Drivers & Utilities" CD.
- ▶ If the CD doesn't start automatically call the *START.EXE* file in the main directory of the CD.
- ▶ If the system board list is displayed select the system board or select under *Driver* the operating system used and the audio and video drivers.

Upgrades

Main memory

Support: The system needs at least one module and can manage at most three SDRAM modules.

PC100 modules must have an SPD-EEPROM*.
It is not possible to mix SDRAM and EDO modules.

Size: From 16 Mbytes up to 768 Mbytes SDRAM

Technology: 100 MHz unbuffered DIMM modules.
168 pin, 3.3V, 100 MHz SDRAM
2M, 4M, 8M, 16M and 32M x 64 bit
2M, 4M, 8M, 16M and 32M x 72 bit (with ECC)

Granularity: For one socket 16, 32, 64, 128 or 256 Mbyte

- * The EEPROM of PC100 modules contains a number of critical timing parameters and data regarding the chip and the module vendor. Due to this the system board will properly recognize the module by reading all important timing parameters specified in the EEPROM via the **Serial Presence Detect** interface.

Troubleshooting

Message BIOS update

The System BIOS provides optimum support for the processor you have chosen. If the message `BIOS update for installed CPU failed`

appears the microcode required for the processor inserted must still be loaded. Further information on this is available in the "BIOS Setup" manual on the "Drivers & Utilities" CD provided.

The screen stays blank

If your screen stays blank this may have the following cause:

The wrong RAM memory module has been inserted

- ▶ See the chapter "Main Memory" for information which memory modules can be used.

ACPI S3 (Save-to-RAM) and/or ACPI S4 (Save-to-Disk) doesn't work

This system board is fully compliant for ACPI S3 and S4. Therefore it is PC98 certified by Microsoft.

If you have any problems with ACPI please ensure that all of your components are supporting ACPI S3 and S4.

- Operating System
- Hardware and drivers of controllers (e. g. VGA, audio, LAN, SCSI controllers).



The system board D1107 supports Save-to-RAM. Therefore the D1107 is certified by Intel and Microsoft. This support must be also guaranteed by the operating system, the extension boards and the power supply. For the time neither Windows 98 nor Windows NT4.0 support this function reliably. Windows 2000 will support ACPI S3 fully. Unfortunately only a few extension boards work with a functional Save-to-RAM support (refer to <http://developer.intel.com/technology/iapc/involve.htm>). For the ATX power supply we recommend a auxiliary power supply of 5V/1A.