

M2R-FVM

Motherboard

ASUS®

E2614

First Edition
May 2006

Copyright © 2006 ASUSTeK COMPUTER INC. All Rights Reserved.

No part of this manual, including the products and software described in it, may be reproduced, transmitted, transcribed, stored in a retrieval system, or translated into any language in any form or by any means, except documentation kept by the purchaser for backup purposes, without the express written permission of ASUSTeK COMPUTER INC. ("ASUS").

Product warranty or service will not be extended if: (1) the product is repaired, modified or altered, unless such repair, modification or alteration is authorized in writing by ASUS; or (2) the serial number of the product is defaced or missing.

ASUS PROVIDES THIS MANUAL "AS IS" WITHOUT WARRANTY OF ANY KIND, EITHER EXPRESS OR IMPLIED, INCLUDING BUT NOT LIMITED TO THE IMPLIED WARRANTIES OR CONDITIONS OF MERCHANTABILITY OR FITNESS FOR A PARTICULAR PURPOSE. IN NO EVENT SHALL ASUS, ITS DIRECTORS, OFFICERS, EMPLOYEES OR AGENTS BE LIABLE FOR ANY INDIRECT, SPECIAL, INCIDENTAL, OR CONSEQUENTIAL DAMAGES (INCLUDING DAMAGES FOR LOSS OF PROFITS, LOSS OF BUSINESS, LOSS OF USE OR DATA, INTERRUPTION OF BUSINESS AND THE LIKE), EVEN IF ASUS HAS BEEN ADVISED OF THE POSSIBILITY OF SUCH DAMAGES ARISING FROM ANY DEFECT OR ERROR IN THIS MANUAL OR PRODUCT.

SPECIFICATIONS AND INFORMATION CONTAINED IN THIS MANUAL ARE FURNISHED FOR INFORMATIONAL USE ONLY, AND ARE SUBJECT TO CHANGE AT ANY TIME WITHOUT NOTICE, AND SHOULD NOT BE CONSTRUED AS A COMMITMENT BY ASUS. ASUS ASSUMES NO RESPONSIBILITY OR LIABILITY FOR ANY ERRORS OR INACCURACIES THAT MAY APPEAR IN THIS MANUAL, INCLUDING THE PRODUCTS AND SOFTWARE DESCRIBED IN IT.

Products and corporate names appearing in this manual may or may not be registered trademarks or copyrights of their respective companies, and are used only for identification or explanation and to the owners' benefit, without intent to infringe.

Contents

Notices	vii
Safety information	viii
About this guide.....	ix
M2R-FVM specifications summary	xi

Chapter 1: Product introduction

1.1	Welcome!	1-1
1.2	Package contents	1-1
1.3	Special features	1-2
1.3.1	Product highlights	1-2
1.3.2	Innovative ASUS features	1-4
1.4	Before you proceed	1-5
1.5	Motherboard overview	1-6
1.5.1	Placement direction	1-6
1.5.2	Screw holes.....	1-6
1.5.3	Motherboard layout	1-7
1.5.4	Layout contents	1-8
1.6	Central Processing Unit (CPU)	1-9
1.6.1	Installing the CPU	1-9
1.6.2	Installing the heatsink and fan	1-11
1.7	System memory.....	1-14
1.7.1	Overview	1-14
1.7.2	Memory configurations	1-15
1.7.3	Installing a DIMM	1-16
1.7.4	Removing a DIMM.....	1-16
1.8	Expansion slots	1-17
1.8.1	Installing an expansion card	1-17
1.8.2	Configuring an expansion card	1-17
1.8.3	Interrupt assignments.....	1-18
1.8.4	PCI slots	1-18
1.8.5	PCI Express x1 slot	1-19
1.8.6	PCI Express x16 slot	1-19

Contents

- 1.9 Jumpers 1-20
- 1.10 Connectors 1-23
 - 1.10.1 Rear panel connectors 1-23
 - 1.10.2 Internal connectors 1-24

Chapter 2: BIOS setup

- 2.1 Managing and updating your BIOS 2-1
 - 2.1.1 Creating a bootable floppy disk 2-1
 - 2.1.2 ASUS EZ Flash 2 utility 2-2
 - 2.1.3 Award BIOS Flash Utility 2-3
 - 2.1.4 Saving the current BIOS file 2-5
 - 2.1.5 ASUS CrashFree BIOS 2 utility 2-6
- 2.2 BIOS setup program 2-7
 - 2.2.1 BIOS menu screen 2-8
 - 2.2.2 Menu bar 2-8
 - 2.2.3 Legend bar 2-9
 - 2.2.4 Menu items 2-9
 - 2.2.5 Sub-menu items 2-9
 - 2.2.6 Configuration fields 2-9
 - 2.2.7 Pop-up window 2-10
 - 2.2.8 General help 2-10
- 2.3 Main menu 2-11
 - 2.3.1 System Time 2-11
 - 2.3.2 System Date 2-11
 - 2.3.3 Legacy Diskette A 2-11
 - 2.3.4 Primary IDE Master/Slave 2-12
 - 2.3.6 SATA1, 2, 3 2-14

Contents

2.3.7	Installed Memory	2-15
2.4	Advanced menu	2-15
2.4.1	JumperFree Configuration.....	2-16
2.4.2	Chipset.....	2-16
2.4.3	PCI/PnP	2-18
2.4.4	Onboard Device Configuration	2-20
2.5	Power menu	2-23
2.5.1	ACPI Suspend Type	2-23
2.5.2	ACPI APIC Support	2-23
2.5.3	APM Configuration	2-24
2.5.4	Hardware Monitor.....	2-25
2.6	Boot menu	2-26
2.6.1	Boot Device Priority	2-26
2.6.2	Boot Settings Configuration	2-27
2.6.3	Security.....	2-28
2.7	Exit menu.....	2-29

Notices

Federal Communications Commission Statement

This device complies with Part 15 of the FCC Rules. Operation is subject to the following two conditions:

- This device may not cause harmful interference, and
- This device must accept any interference received including interference that may cause undesired operation.

This equipment has been tested and found to comply with the limits for a Class B digital device, pursuant to Part 15 of the FCC Rules. These limits are designed to provide reasonable protection against harmful interference in a residential installation. This equipment generates, uses and can radiate radio frequency energy and, if not installed and used in accordance with manufacturer's instructions, may cause harmful interference to radio communications. However, there is no guarantee that interference will not occur in a particular installation. If this equipment does cause harmful interference to radio or television reception, which can be determined by turning the equipment off and on, the user is encouraged to try to correct the interference by one or more of the following measures:

- Reorient or relocate the receiving antenna.
- Increase the separation between the equipment and receiver.
- Connect the equipment to an outlet on a circuit different from that to which the receiver is connected.
- Consult the dealer or an experienced radio/TV technician for help.



The use of shielded cables for connection of the monitor to the graphics card is required to assure compliance with FCC regulations. Changes or modifications to this unit not expressly approved by the party responsible for compliance could void the user's authority to operate this equipment.

Canadian Department of Communications Statement

This digital apparatus does not exceed the Class B limits for radio noise emissions from digital apparatus set out in the Radio Interference Regulations of the Canadian Department of Communications.

This class B digital apparatus complies with Canadian ICES-003.

Safety information

Electrical safety

- To prevent electrical shock hazard, disconnect the power cable from the electrical outlet before relocating the system.
- When adding or removing devices to or from the system, ensure that the power cables for the devices are unplugged before the signal cables are connected. If possible, disconnect all power cables from the existing system before you add a device.
- Before connecting or removing signal cables from the motherboard, ensure that all power cables are unplugged.
- Seek professional assistance before using an adapter or extension cord. These devices could interrupt the grounding circuit.
- Make sure that your power supply is set to the correct voltage in your area. If you are not sure about the voltage of the electrical outlet you are using, contact your local power company.
- If the power supply is broken, do not try to fix it by yourself. Contact a qualified service technician or your retailer.

Operation safety

- Before installing the motherboard and adding devices on it, carefully read all the manuals that came with the package.
- Before using the product, make sure all cables are correctly connected and the power cables are not damaged. If you detect any damage, contact your dealer immediately.
- To avoid short circuits, keep paper clips, screws, and staples away from connectors, slots, sockets and circuitry.
- Avoid dust, humidity, and temperature extremes. Do not place the product in any area where it may become wet.
- Place the product on a stable surface.
- If you encounter technical problems with the product, contact a qualified service technician or your retailer.

About this guide

This user guide contains the information you need when installing and configuring the motherboard.

How this guide is organized

This guide contains the following parts:

- **Chapter 1: Product introduction**

This chapter describes the features of the motherboard and the new technology it supports. This chapter also lists the hardware setup procedures that you have to perform when installing system components. It includes description of the switches, jumpers, and connectors on the motherboard.

- **Chapter 2: BIOS setup**

This chapter tells how to change system settings through the BIOS Setup menus. Detailed descriptions of the BIOS parameters are also provided.

Where to find more information

Refer to the following sources for additional information and for product and software updates.

1. **ASUS websites**

The ASUS website provides updated information on ASUS hardware and software products. Refer to the ASUS contact information.

2. **Optional documentation**

Your product package may include optional documentation, such as warranty flyers, that may have been added by your dealer. These documents are not part of the standard package.

Conventions used in this guide

To make sure that you perform certain tasks properly, take note of the following symbols used throughout this manual.



DANGER/WARNING: Information to prevent injury to yourself when trying to complete a task.



CAUTION: Information to prevent damage to the components when trying to complete a task.



IMPORTANT: Instructions that you **MUST** follow to complete a task.



NOTE: Tips and additional information to help you complete a task.

Typography

Bold text

Indicates a menu or an item to select.

Italics

Used to emphasize a word or a phrase.

<Key>

Keys enclosed in the less-than and greater-than sign means that you must press the enclosed key.

Example: <Enter> means that you must press the Enter or Return key.

<Key1>+<Key2>+<Key3> If you must press two or more keys simultaneously, the key names are connected with a plus sign (+).

Example: <Ctrl>+<Alt>+

Command

Means that you must type the command exactly as shown, then supply the required item or value enclosed in brackets.

Example: At the DOS prompt, type the command line:

```
afudos /i [filename]
afudos /iM2R-FVM.bin
```

M2R-FVM specifications summary

CPU	Socket AM2 for AMD Athlon™ 64 X2 /AMD Athlon™ 64 /AMD Sempron™ processors Supports AMD Cool 'n' Quiet™ Technology AMD64 architecture enables simultaneous 32-bit and 64-bit computing
Chipset	ATI® RS485 ATI® SB600
HT Frequency	800 MHz /1GHz
Memory	Dual-channel memory architecture <ul style="list-style-type: none"> - 4 x 240-pin DIMM sockets support unbuffered DDR2 667/533 MHz memory modules - Supports up to 2GB system memory with dual-channel memory
Expansion slots	1 x PCI Express™ x16 slots 1 x PCI Express™ x1 slots 2 x PCI 2.2 slots
Storage	South Bridge SB600 supports: <ul style="list-style-type: none"> - 1 x IDE connector for up to two Ultra DMA 133/100/66/33 devices - 4 x Serial ATA connectors support four Serial ATA devices - RAID 0, RAID1 and RAID 0+1 functions
Audio	Realtek® ALC883 8-channel Azalia CODEC Supports Jack-Sensing & Enumeration Technology Supports S/PDIF out interface
IEEE 1394	T1 1394 controller supports: <ul style="list-style-type: none"> - 1 x IEEE 1394a connector
USB	Supports up to 8 USB 2.0/1.1 ports
Form factor	uATX form factor: 9.6 in x 9.6 in (24.5 cm x 24.5 cm)
LAN	Realtek® RTL8100C 10/100M LAN controller
Special features	<ul style="list-style-type: none"> - ASUS CrashFree BIOS 2 - ASUS EZ Flash - ASUS Q-fan1.5 - ASUS MyLogo2 - Dram Burnt proof
Rear panel	1 x Serial (COM1) port 1 x VGA port 1 x S/PDIF Out port 1 x 1394 port 1 x LAN (RJ-45) port 4 x USB 2.0/1.1 ports 8-channel audio ports

(continued on the next page)

M2R-FVM specifications summary

Internal connectors	4 x USB 2.0 connectors 1 x Floppy disk drive connector 1 x IDE connector for two devices 4 x Serial ATA connectors 1 x CPU / 1 x Chassis fan connectors 1 x IEEE 1394a connector 1 x S/PDIF Out connector Front panel audio connector AUX audio in connector 24-pin ATX power connector 4-pin ATX 12 V power connector System panel connector
BIOS features	4 Mb AWARD BIOS, PnP, DMI, WfM2.0, ACPI 2.0c, SM BIOS 2.3, CrashFree BIOS2, EZ Flash, Special H/W write protection
Manageability	WOR by Ring, WOL by PME, WOR by PME, Wake on USB from S1, S3, S4
Power requirements	ATX power supply (with 24-pin and 4-pin 12 V plugs) ATX 12 V 2.0 compliant
Drivers	Chipset update driver On-board graphic driver Bus master IDE driver RAID driver Audio driver LAN driver AMD AWAY mode driver
Utilities & Applications	BIOS flash utility under DOS ASUS Update - BIOS AMD Cool'n Quiet Utility

**Specifications are subject to change without notice.*

This chapter describes the motherboard features and the new technologies it supports.

1 Product introduction

1.1 Welcome!

Thank you for buying an **ASUS® M2R-FVM motherboard!**

The motherboard delivers a host of new features and latest technologies, making it another standout in the long line of ASUS quality motherboards!

Before you start installing the motherboard, and hardware devices on it, check the items in your package with the list below.

1.3 Special features

1.3.1 Product highlights

Latest processor technology



The motherboard comes with a 940-pin AM2 socket that supports AMD Athlon™ 64 X2/AMD Athlon™ 64/AMD Sempron™ processor. With an integrated low-latency high-bandwidth memory controller and a highly scalable HyperTransport™ technology-based system bus, the motherboard provides a powerful platform for your diverse computing needs, increased office productivity, and enhanced digital media experience.

DDR2 memory support



The motherboard supports DDR2 memory that features data transfer rates of 667/533 MHz to meet the higher bandwidth requirements of the latest 3D graphics, multimedia, and Internet applications. The dual-channel DDR2 architecture doubles the bandwidth of your system memory to boost system performance and eliminating bottlenecks.

PCI Express™ interface



The motherboard fully supports PCI Express, the latest I/O interconnect technology that speeds up the PCI bus. PCI Express features point-to-point serial interconnections between devices and allows higher clockspeeds by carrying data in packets. This high speed interface is software compatible with existing PCI specifications.

Serial ATA technology with RAID function



The motherboard supports the Serial ATA technology through the Serial ATA interfaces and the SB600 Southbridge. Serial ATA allows for thinner, more flexible cables with lower pin count, reduced voltage requirement, and data transfer rates of up to 150 MB/s for SATA I and 300 MB/s for SATA II.

The SB600 built-in RAID function supports RAID 0, RAID 1 and RAID 0+1 configuration for four SATA and one IDE connectors and allows you to select the best RAID solution using IDE or Serial ATA devices.

IEEE 1394a support



The IEEE 1394a interface provides high-speed and flexible PC connectivity to a wide range of peripherals and devices compliant to the IEEE 1394a standard. The IEEE 1394a interface allows up to 400 Mbps transfer rates through simple, low-cost, high-bandwidth asynchronous (real-time) data interfacing between computers, peripherals, and consumer electronic devices such as camcorders, VCRs, printers, TVs, and digital cameras.

S/PDIF digital sound ready



The motherboard supports the S/PDIF technology through the S/PDIF interfaces on the rear panel. The S/PDIF technology turns your computer into a high-end entertainment system with digital connectivity to powerful audio and speaker systems.

USB 2.0 technology



The motherboard implements the Universal Serial Bus (USB) 2.0 specification, dramatically increasing the connection speed from the 12 Mbps bandwidth on USB 1.1 to a fast 480 Mbps on USB 2.0. USB 2.0 is backward compatible with USB 1.1.

AMD Cool 'n' Quiet Technology



The motherboard supports the AMD Cool 'n' Quiet Technology, which monitors system operation and automatically adjusts CPU voltage and frequency for a cool and quiet operating environment.

1.3.2 Innovative ASUS features

ASUS CrashFree BIOS 2

This feature allows you to restore the original BIOS data in case when the BIOS codes and data are corrupted. This protection eliminates the need to buy a replacement ROM chip.

ASUS EZ Flash BIOS

With the ASUS EZ Flash, you can easily update the system BIOS even before loading the operating system.

ASUS Q-Fan technology

The ASUS Q-Fan technology smartly adjusts the CPU fan speed according to the system loading to ensure quiet, cool, and efficient operation.

1.4 Before you proceed

Take note of the following precautions before you install motherboard components or change any motherboard settings.



- Unplug the power cord from the wall socket before touching any component.
- Use a grounded wrist strap or touch a safely grounded object or to a metal object, such as the power supply case, before handling components to avoid damaging them due to static electricity.
- Hold components by the edges to avoid touching the ICs on them.
- Whenever you uninstall any component, place it on a grounded antistatic pad or in the bag that came with the component.
- Before you install or remove any component, ensure that the ATX power supply is switched off or the power cord is detached from the power supply. Failure to do so may cause severe damage to the motherboard, peripherals, and/or components.

Onboard LED

The motherboard comes with a standby power LED. The green LED lights up to indicate that the system is ON, in sleep mode, or in soft-off mode. This is a reminder that you should shut down the system and unplug the power cable before removing or plugging in any motherboard component. The illustration below shows the location of the onboard LED.

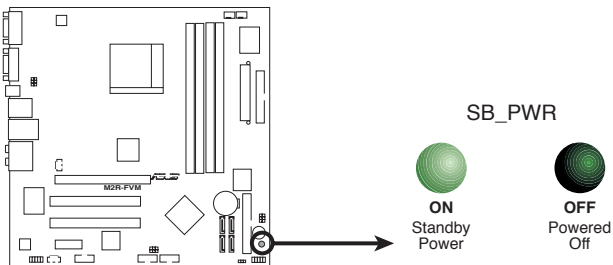

M2R-FVM Onboard LED

1.5 Motherboard overview

Before you install the motherboard, study the configuration of your chassis to ensure that the motherboard fits into it.



Make sure to unplug the power cord before installing or removing the motherboard. Failure to do so can cause you physical injury and damage motherboard components.

1.5.1 Placement direction

When installing the motherboard, make sure that you place it into the chassis in the correct orientation. The edge with external ports goes to the rear part of the chassis as indicated in the image below.

1.5.2 Screw holes

Place nine (9) screws into the holes indicated by circles to secure the motherboard to the chassis.



Do not overtighten the screws! Doing so can damage the motherboard.

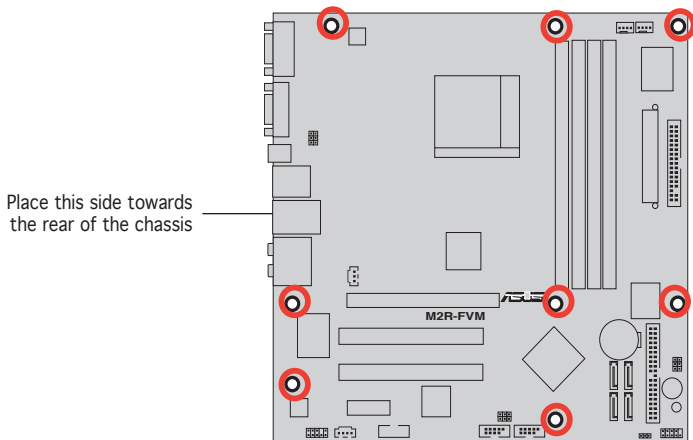

1.5.3 Motherboard layout

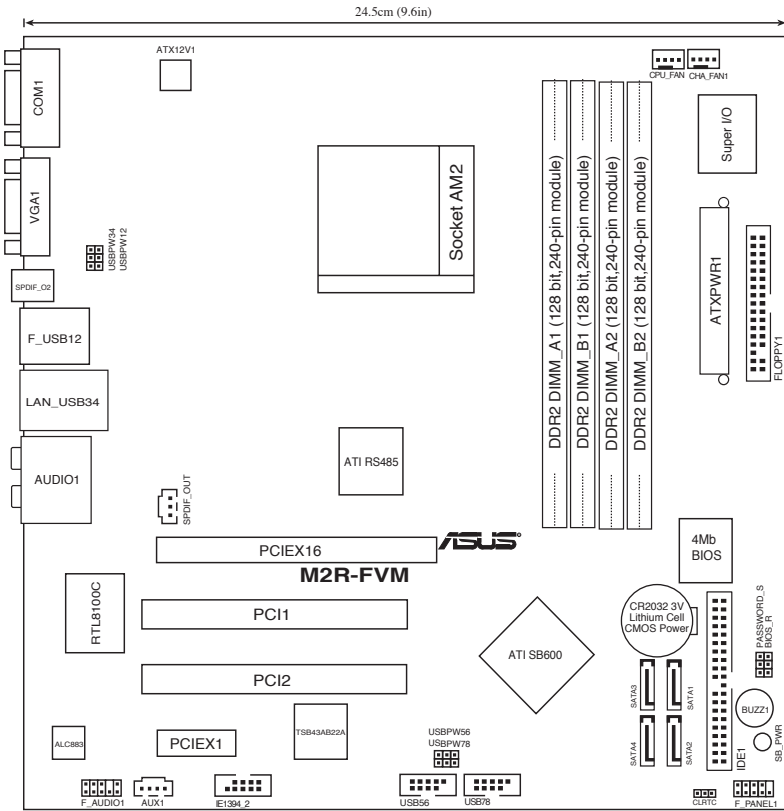

1.5.4 Layout contents

Slots		Page
1.	DDR2 DIMM slots	1-15
2.	PCI slots	1-19
3.	PCI Express x 1 slots	1-20
4.	PCI Express x16 slots	1-20
Jumpers		Page
1.	Clear RTC RAM (3-pin CLRRTC1)	1-21
2.	USB Power (3-pin USBPW12, 34, 56, 78)	1-23
3.	Password Skip (3-pin PASSWORD_s)	1-22
4.	BIOS Recovery (3-pin BIOS_R)	1-22
Rear panel connectors		Page
1.	Serial (COM1) port	1-25
2.	VGA port	1-25
3.	S/PDIF Out port	1-25
4.	LAN (RJ-45) port.	1-24
5.	IEEE 1394a port.	1-24
6.	USB 2.0 ports 1 and 2, 3 and 4	1-25
7.	Center/Subwoofer port (orange)	1-24
8.	Rear Speaker Out port (black)	1-24
9.	Line In port (light blue)	1-24
10.	Line Out port (lime)	1-24
11.	Microphone port (pink)	1-24
12.	Side Speaker Out port (grey)	1-24
Internal connectors		Page
1.	Floppy disk drive connector (34-1 pin FLOPPY)	1-25
2.	IDE connector (40-1 pin PRI_IDE)	1-26
3.	Serial ATA connectors (7-pin SATA1, SATA2, SATA3, SATA4)	1-27
5.	USB connectors (10-1 pin USB56, USB78)	1-29
6.	IEEE 1394a port connector (10-1 pin IE1394_2)	1-30
7.	CPU and chassis fan connectors (4-pin CPU_FAN, 4-pin CHA_FAN1)	1-28
8.	ATX power connectors (24-pin EATXPWR, 4-pin EATX12V)	1-28
9.	Front panel audio connector (10-1 pin F_AUDIO1)	1-30
10.	Internal audio connector (4-pin AUX1)	1-29
11.	Digital audio connector (3-pin SPDIF_OUT)	1-27
12.	System panel connector (10-1 pin F_PANEL1)	1-31
	<ul style="list-style-type: none"> • System power LED (Green 2-pin PWR_LED) • Hard disk drive activity LED (Red 2-pin HD_LED) • ATX power button/soft-off button (Black 2-pin PWR_BTN) • Reset button (Blue 2-pin RESET) 	

1.6 Central Processing Unit (CPU)

The motherboard comes with a 940-pin AM2 socket designed for the AMD Athlon™ 64 X2/Athlon™ 64/Sempron™ processor.



The AM2 socket has a different pinout from the 940-pin socket designed for the AMD Opteron™ processor. Make sure you use a CPU is designed for the AM2 socket. The CPU fits in only one correct orientation. DO NOT force the CPU into the socket to prevent bending the connectors on the socket and damaging the CPU!

1.6.1 Installing the CPU

To install a CPU:

1. Locate the CPU socket on the motherboard.

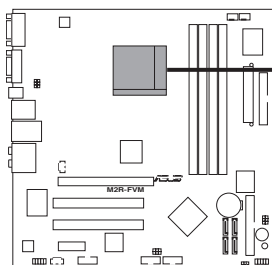

M2R-FVM CPU Socket AM2

2. Unlock the socket by pressing the lever sideways, then lift it up to a 90° angle.

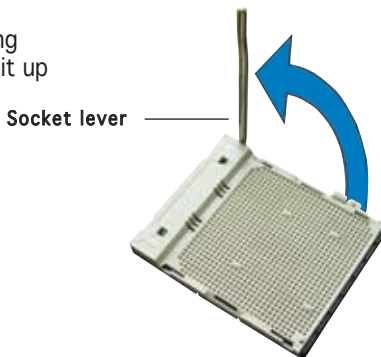

Make sure that the socket lever is lifted up to a 90° angle; otherwise, the CPU will not fit in completely.

3. Position the CPU above the socket such that the CPU corner with the gold triangle matches the socket corner with a small triangle.
4. Carefully insert the CPU into the socket until it fits in place.



Please make sure your CPU is fully plugged-in to reduce abnormal symptom.

Gold triangle

Small triangle

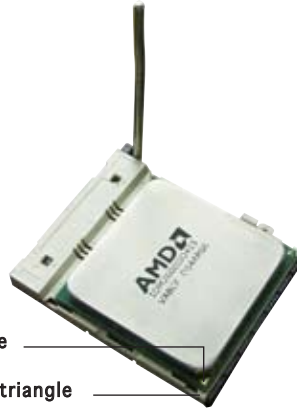

5. When the CPU is in place, push down the socket lever to secure the CPU. The lever clicks on the side tab to indicate that it is locked.
6. Install a CPU heatsink and fan following the instructions that came with the heatsink package.



1.6.2 Installing the heatsink and fan

The AMD Athlon™ 64/AMD Athlon™ 64 X2/ AMD Sempron™ processor requires a specially designed heatsink and fan assembly to ensure optimum thermal condition and performance.



Make sure that you use only AMD-certified heatsink and fan assembly.

Follow these steps to install the CPU heatsink and fan.

1. Place the heatsink on top of the installed CPU, making sure that the heatsink fits properly on the retention module base.



- The retention module base is already installed on the motherboard upon purchase.
 - You do not have to remove the retention module base when installing the CPU or installing other motherboard components.
 - If you purchased a separate CPU heatsink and fan assembly, make sure that a Thermal Interface Material is properly applied to the CPU heatsink or CPU before you install the heatsink and fan assembly.
-

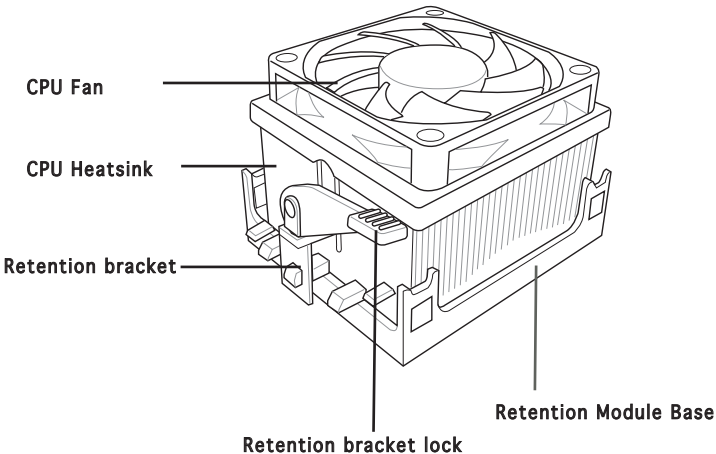

Your boxed CPU heatsink and fan assembly should come with installation instructions for the CPU, heatsink, and the retention mechanism. If the instructions in this section do not match the CPU documentation, follow the latter.

2. Attach one end of the retention bracket to the retention module base.

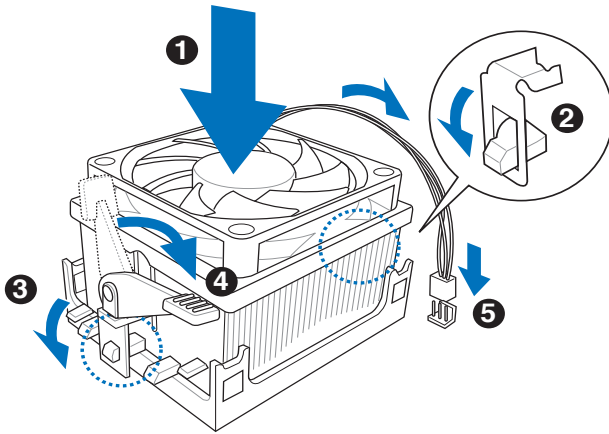

3. Align the other end of the retention bracket (near the retention bracket lock) to the retention module base. A clicking sound denotes that the retention bracket is in place.



Make sure that the fan and heatsink assembly perfectly fits the retention mechanism module base, otherwise you cannot snap the retention bracket in place.

4. Push down the retention bracket lock on the retention mechanism to secure the heatsink and fan to the module base.
5. When the fan and heatsink assembly is in place, connect the CPU fan cable to the connector on the motherboard labeled CPU_FAN.



Do not forget to connect the CPU fan connector! Hardware monitoring errors can occur if you fail to plug this connector.

- When the fan and heatsink assembly is in place, connect the CPU fan cable to the connector on the motherboard labeled CPU_FAN.

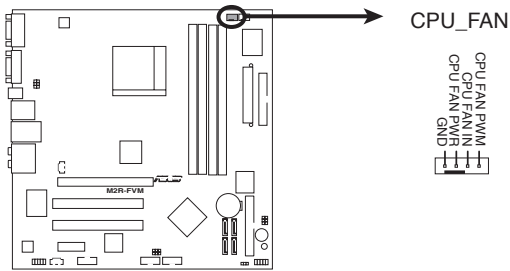

M2R-FVM CPU Fan Connector



Do not forget to connect the CPU fan connector! Hardware monitoring errors can occur if you fail to plug this connector.

1.7 System memory

1.7.1 Overview

The motherboard comes with four Double Data Rate 2 (DDR2) Dual Inline Memory Modules (DIMM) sockets.

A DDR2 module has the same physical dimensions as a DDR DIMM but has a 240-pin footprint compared to the 184-pin DDR DIMM. DDR2 DIMMs are notched differently to prevent installation on a DDR DIMM socket.

The figure illustrates the location of the DDR2 DIMM sockets:

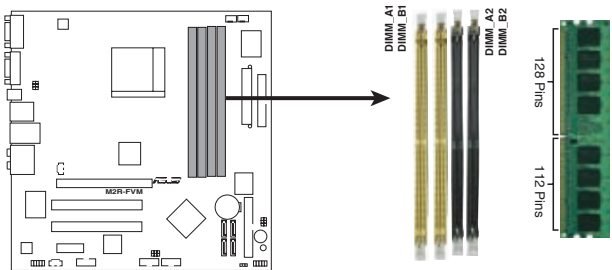

M2R-FVM 240-pin DDR2 DIMM Sockets

Channel	Sockets
Channel A	DIMM_A1/DIMM_A2
Channel B	DIMM_B1/DIMM_B2

1.7.2 Memory configurations

You may install 256 MB, 512 MB, and 1 GB unbuffered ECC/non-ECC DDR2 DIMMs into the DIMM sockets.



- For dual-channel configuration, the total size of memory module(s) installed per channel must be the same (DIMM_A1 + DIMM_A2 = DIMM_B1 + DIMM_B2).
- Always install DIMMs with the same CAS latency. For optimum compatibility, we recommend that you obtain memory modules from the same vendor. Visit the ASUS website (www.asus.com) for the latest Qualified Vendors List.
- When using only one DDR DIMM module, install it into slot DIMM_B2 only.
- For single-channel memory configuration, start installing the DDR2 DIMMs from slot DIMM_B1 or DIMM_B2.
- For dual-channel memory configuration, install the DIMMs in slots DIMM_B2 and DIMM_A2 (black); install another pair of DIMMs in slots DIMM_B1 and DIMM_A1 (yellow).



Important notice on installing Windows® XP 32-bit version

If you install Windows® XP 32-bit version Operating System (OS), the limitation of this OS version is that it may reserve a certain amount of memory space for system devices. We recommend that you install less than 3 GB system memory if you would like to work under Windows® XP 32-bit version OS. The excess memory installation will not cause any usage problem, but it will not give users the benefit of manipulating this excess memory space.

Visit the ASUS FAQ site for further explanation:

<http://support.asus.com/faq/faq.aspx?SLanguage=en-us>

Under General Search, make the selections as shown, then click Search. Click the article titled “4GB memory installed but less memory size detected.”



You also may check the URLs below for third party comments on this issue:

http://dlsvr01.asus.com/pub/ASUS/mb/4GB_Rev1.pdf

<http://www.intel.com/support/motherboards/server/sb/cs-016594.htm>

1.7.3 Installing a DIMM



Unplug the power supply before adding or removing DIMMs or other system components. Failure to do so can cause severe damage to both the motherboard and the components.

To install a DIMM:

1. Unlock a DIMM socket by pressing the retaining clips outward.
2. Align a DIMM on the socket such that the notch on the DIMM matches the break on the socket.
3. Firmly insert the DIMM into the socket until the retaining clips snap back in place and the DIMM is properly seated.

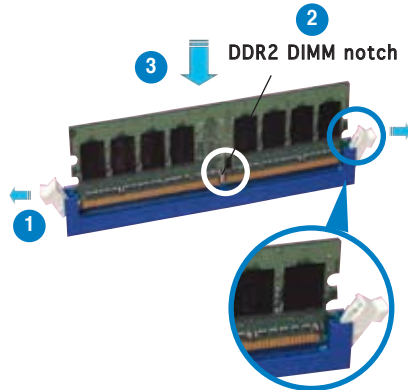

Unlocked retaining clip



- A DDR2 DIMM is keyed with a notch so that it fits in only one direction. Do not force a DIMM into a socket to avoid damaging the DIMM.
- The DDR2 DIMM sockets do not support DDR DIMMs. DO not install DDR DIMMs to the DDR2 DIMM sockets.

1.7.4 Removing a DIMM

To remove a DIMM:

1. Simultaneously press the retaining clips outward to unlock the DIMM.



Support the DIMM lightly with your fingers when pressing the retaining clips. The DIMM might get damaged when it flips out with extra force.

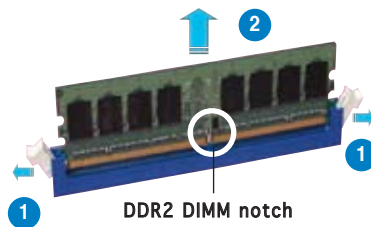

2. Remove the DIMM from the socket.

1.8 Expansion slots

In the future, you may need to install expansion cards. The following sub-sections describe the slots and the expansion cards that they support.



Make sure to unplug the power cord before adding or removing expansion cards. Failure to do so may cause you physical injury and damage motherboard components.

1.8.1 Installing an expansion card

To install an expansion card:

1. Before installing the expansion card, read the documentation that came with it and make the necessary hardware settings for the card.
2. Remove the system unit cover (if your motherboard is already installed in a chassis).
3. Remove the bracket opposite the slot that you intend to use. Keep the screw for later use.
4. Align the card connector with the slot and press firmly until the card is completely seated on the slot.
5. Secure the card to the chassis with the screw you removed earlier.
6. Replace the system cover.

1.8.2 Configuring an expansion card

After installing the expansion card, configure the it by adjusting the software settings.

1. Turn on the system and change the necessary BIOS settings, if any. See Chapter 2 for information on BIOS setup.
2. Assign an IRQ to the card. Refer to the tables on the next page.
3. Install the software drivers for the expansion card.



When using PCI cards on shared slots, ensure that the drivers support “Share IRQ” or that the cards do not need IRQ assignments; otherwise, conflicts will arise between the two PCI groups, making the system unstable and the card inoperable.

1.8.3 Interrupt assignments

Standard interrupt assignments

IRQ	Priority	Standard function
0	1	System Timer
1	2	Keyboard Controller
2	–	Redirect to IRQ#9
4	12	Communications Port (COM1)*
5	13	IRQ Holder for PCI Steering*
6	14	Floppy Disk Controller
7	15	Printer Port (LPT1)*
8	3	System CMOS/Real Time Clock
9	4	IRQ Holder for PCI Steering*
10	5	IRQ Holder for PCI Steering*
11	6	IRQ Holder for PCI Steering*
12	7	PS/2 Compatible Mouse Port*
13	8	Numeric Data Processor
14	9	Primary IDE Channel
15	10	Secondary IDE Channel

* These IRQs are usually available for ISA or PCI devices.

1.8.4 PCI slots

The PCI slots support cards such as a LAN card, SCSI card, USB card, and other cards that comply with PCI specifications. The figure shows a LAN card installed on a PCI slot.

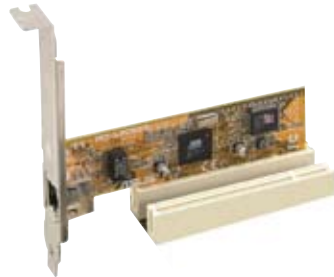

1.8.5 PCI Express x1 slot

This motherboard supports PCI Express x1 network cards, SCSI cards and other cards that comply with the PCI Express specifications. The figure shows a network card installed on the PCI Express x 1 slot.



1.8.6 PCI Express x16 slot

This motherboard supports PCI Express x16 graphics cards that comply with the PCI Express specifications. The figure shows a graphics card installed on the PCI Express x 16 slot.



1.9 Jumpers

Clear RTC RAM (CLRRTC)

This jumper allows you to clear the Real Time Clock (RTC) RAM in CMOS. You can clear the CMOS memory of date, time, and system setup parameters by erasing the CMOS RTC RAM data. The onboard button cell battery powers the RAM data in CMOS, which include system setup information such as system passwords.

To erase the RTC RAM:

1. Turn OFF the computer and unplug the power cord.
2. Remove the onboard battery.
3. Move the jumper cap from pins 1-2 (default) to pins 2-3. Keep the cap on pins 2-3 for about 5~10 seconds, then move the cap back to pins 1-2.
4. Reinstall the battery.
5. Plug the power cord and turn ON the computer.
6. Hold down the key during the boot process and enter BIOS setup to re-enter data.



Except when clearing the RTC RAM, never remove the cap on CLRRTC jumper default position. Removing the cap will cause system boot failure!

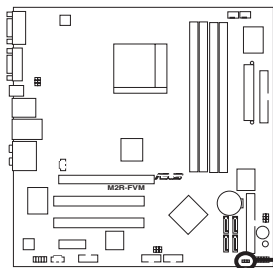

M2R-FVM Clear RTC RAM

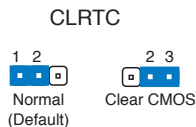

- Make sure to re-enter your previous BIOS settings after you clear the CMOS.
- You do not need to clear the RTC when the system hangs due to overclocking. For system failure due to overclocking, use the C.P.R. (CPU Parameter Recall) feature. Shut down and reboot the system so the BIOS can automatically reset parameter settings to default values.

BIOS Recovery (3-pin BIOS_R)

This jumper allows you to recover your original BIOS from a floppy disk in case the BIOS codes and data are corrupted.

To recover the BIOS:

1. Turn OFF your computer and unplug the power cord.
2. Move the jumper cap from pins 1-2 (default) to pins 2-3.
3. Insert a floppy disk with the original or updated BIOS file.
4. Plug the power cord and turn ON the computer.
5. The system searches for the BIOS file in the floppy then reflashes the BIOS.
6. When finished, shut down your computer.
7. Replace the jumper cap from pins 2-3 to pins 1-2.
8. Reboot your computer.
9. Hold down the key during the boot process and enter BIOS setup to re-enter data.

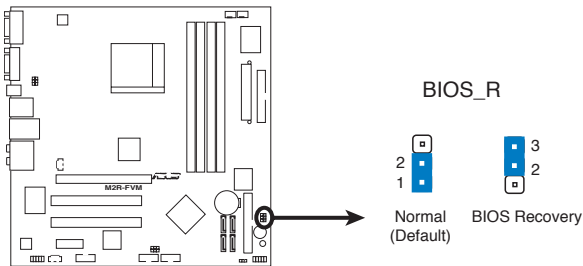

M2R-FVM BIOS Recovery

Password Skip (3-pin PASSWORD_S)

When the jumper cap is moved from 1-2 pin to 2-3 pin, the BIOS password function will be skipped and users will not need a password to enter into the BIOS.

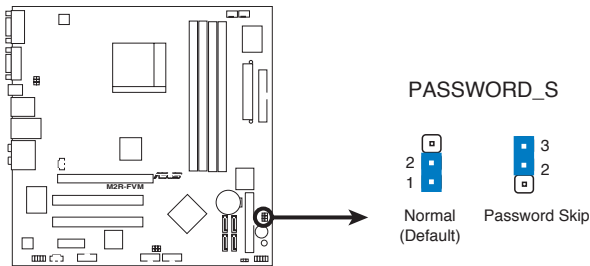

M2R-FVM Password Skip

USB device wake-up (3-pin USBPW12, USBPW34, USBPW56, USBPW78)

Set these jumpers to +5V to wake up the computer from S1 sleep mode (CPU stopped, DRAM refreshed, system running in low power mode) using the connected USB devices, Set to +5VSB to wake up from S3 and S4 sleep modes (no power to CPU, DRAM in slow refresh, power supply in reduced power mode)

The USBPW12 and USBPW34 jumpers are for the rear USB ports. The USBPW56 and USBPW78 jumper is for the internal USB connectors that you can connect to additional USB ports

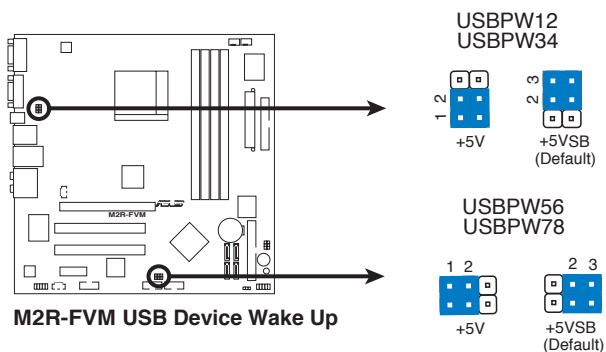

- The USB device wake-up feature requires a power supply that can provide 500mA on the +5VSB lead for each USB port; otherwise, the system would not power up.
- The total current consumed must NOT exceed the power supply capability (+5VSB) whether under normal condition or in sleep mode.

1.10 Connectors

1.10.1 Rear panel connectors

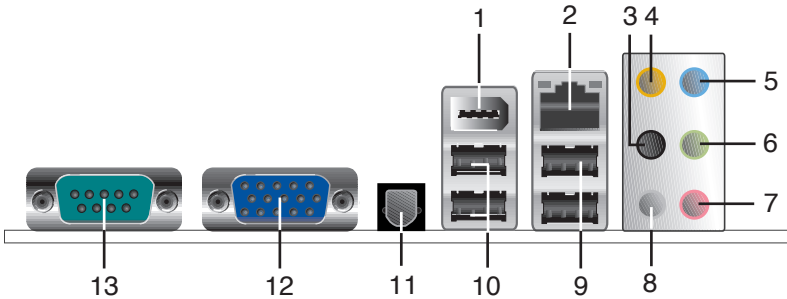

- 1. **IEEE 1394 port.** This 6-pin IEEE 1394 port provides high-speed connectivity for audio/video, storage peripherals, PCs, or portable devices.
- 2. **LAN (RJ-45) port.** This port allows Gigabit connection to a Local Area Network (LAN) through a network hub. Refer to the table below for the LAN port LED indications.
- 3. **Rear Speaker Out port (Black).** This port connects the rear speakers on a 4-channel, 6-channel, or 8-channel audio configuration.

LAN port LED indications

ACT/LINK LED		SPEED LED	
Status	Description	Status	Description
OFF	No link	OFF	10 Mbps connection
BLINKING	Data activity	GREEN	100Mbps connection

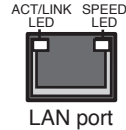

- 4. **Center/Subwoofer port (orange).** This port connects the center/subwoofer speakers.
- 5. **Line In port (light blue).** This port connects a tape, CD, DVD player, or other audio sources.
- 6. **Line Out port (lime).** This port connects a headphone or a speaker. In 4-channel, 6-channel, and 8-channel configuration, the function of this port becomes Front Speaker Out.
- 7. **Microphone port (pink).** This port connects a microphone.
- 8. **Side Speaker Out port (grey).** This port connects the side speakers in an 8-channel audio configuration.



Refer to the audio configuration table below for the function of the audio ports in 2, 4, or 6-channel configuration.

Audio 2, 4, 6 or 8-channel configuration

Port	2-channel (Headset)	4-channel	6-channel	8-channel
Light Blue	Line In	Line In	Line In	Line In
Lime	Line Out	Front Speaker Out	Front Speaker Out	Front Speaker Out
Pink	Mic In	Mic In	Mic In	Mic In
Orange	—	Center /Subwoofer	Rear Speaker Out	Center/Subwoofer
Black	—	—	—	Rear Speaker Out
Gray	—	—	Side speaker out	Side speaker out

- USB 2.0 ports 3 and 4.** These two 4-pin Universal Serial Bus (USB) ports are available for connecting USB 2.0 devices.
- USB 2.0 ports 1 and 2.** These two 4-pin Universal Serial Bus (USB) ports are available for connecting USB 2.0 devices.
- SPDIF port.** This port connectors an external audio output device via a S/PDIF cable.
- VGA port.** This 15-pin VGA port connects to a VGA monitor.
- Serial connector.** This 9-pin COM1 port is for serial devices.**SPDIF port.**

1.10.2 Internal connectors

1. Floppy disk drive connector (34-1 pin FLOPPY1)

This connector is for the provided floppy disk drive (FDD) signal cable. Insert one end of the cable to this connector, then connect the other end to the signal connector at the back of the floppy disk drive.



Pin 5 on the connector is removed to prevent incorrect cable connection when using an FDD cable with a covered Pin 5.

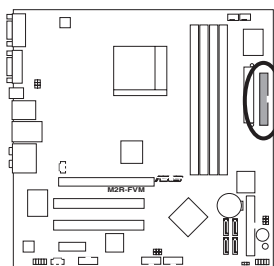

FLOPPY

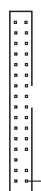

PIN 1

NOTE: Orient the red markings on the floppy ribbon cable to PIN 1.

M2R-FVM Floppy Disk Drive Connector

2. IDE connector (40-1 pin IDE1)

These connectors are for Ultra DMA 133/100/66 signal cables. The Ultra DMA 133/100/66 signal cable has three connectors: a blue connector for the primary IDE connector on the motherboard, a black connector for an Ultra DMA 133/100/66 IDE slave device (optical drive/hard disk drive), and a gray connector for an Ultra DMA 133/100/66 IDE master device (hard disk drive). If you install two hard disk drives, you must configure the second drive as a slave device by setting its jumper accordingly. Refer to the hard disk documentation for the jumper settings.



- Pin 20 on the IDE connector is removed to match the covered hole on the Ultra DMA cable connector. This prevents incorrect insertion when you connect the IDE cable.
- Use the 80-conductor IDE cable for Ultra DMA 100/66 IDE devices.

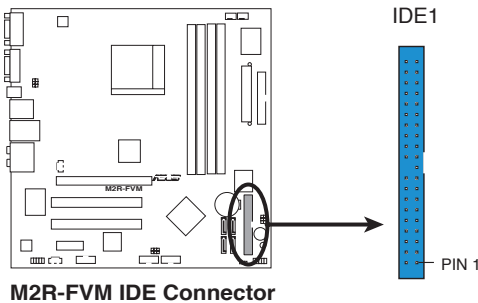

NOTE: Orient the red mar (usually zigzag) on the ID ribbon cable to PIN 1.

3. Serial ATA connectors (7-pin SATA1, SATA2, SATA3, SATA4)

These connectors are for the Serial ATA signal cables for Serial ATA hard disk drives. The current Serial ATA I interface allows up to 150 MB/s data transfer rate.

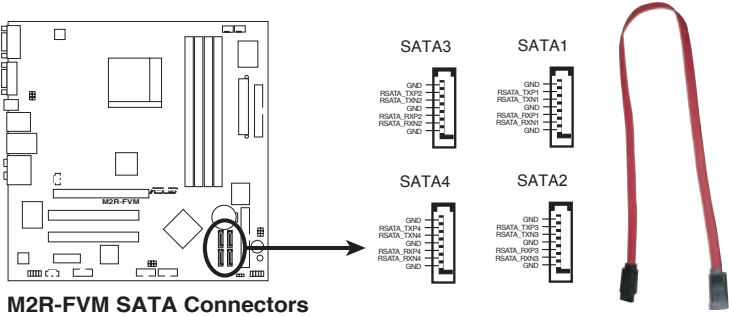

M2R-FVM SATA Connectors

 Install the Windows® 2000 Service Pack 4 or the Windows® XP Service Pack 1 or later before using Serial ATA.

4. Digital Audio connector (3-pin SPDIF_OUT)

This connector is for the S/PDIF audio module to allow digital sound output. Connect one end of the S/PDIF audio cable to this connector and the other end to the S/PDIF module.

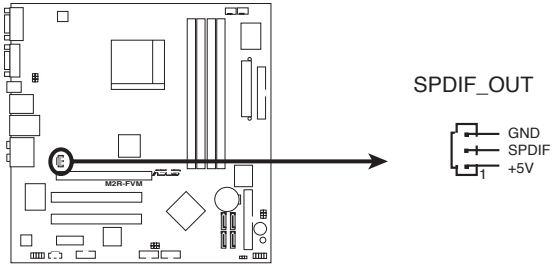

M2R-FVM Digital Audio Connector

 The S/PDIF out module is purchased separately.

5. CPU and Chassis fan connectors (4-pin CPU_FAN, 4-pin CHA_FAN1)

The fan connectors support cooling fans of 350mA~740mA (8.88W max.) or a total of 1A~2.22A (26.64W max.) at +12V. Connect the fan cables to the fan connectors on the motherboard, making sure that the black wire of each cable matches the ground pin of the connector.



Do not forget to connect the fan cables to the fan connectors. Insufficient air flow inside the system may damage the motherboard components. These are not jumpers! DO NOT place jumper caps on the fan connectors.

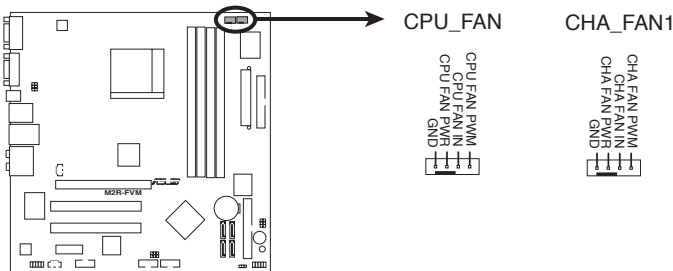

CPU_FAN

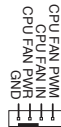

CHA_FAN1



M2R-FVM Fan Connectors

6. ATX power connectors (24-pin ATXPWR1 and 4-pin ATX12V)

These connectors are for ATX power supply plugs. The power supply plugs are designed to fit these connectors in only one orientation. Find the proper orientation and push down firmly until the connectors completely fit.



- Do not forget to connect the 4-pin ATX +12 V power plug; otherwise, the system will not boot.
- Use of a PSU with a higher power output is recommended when configuring a system with more power-consuming devices. The system may become unstable or may not boot up if the power is inadequate.
- Make sure that your power supply unit (PSU) can provide at least the minimum power required by your system.

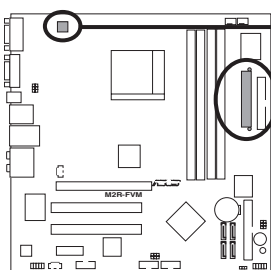

ATX12V1



ATXPWR1

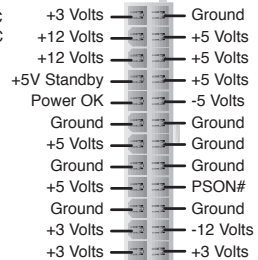

M2R-FVM ATX Power Connector

7. USB connectors (10-1 pin USB56[black], USB78[black])

These connectors are for USB 2.0 ports. Connect the optional USB module cable to any of these connectors, then install the module to a slot opening at the back of the system chassis. These USB connectors comply with USB 2.0 specification that supports up to 480 Mbps connection speed.

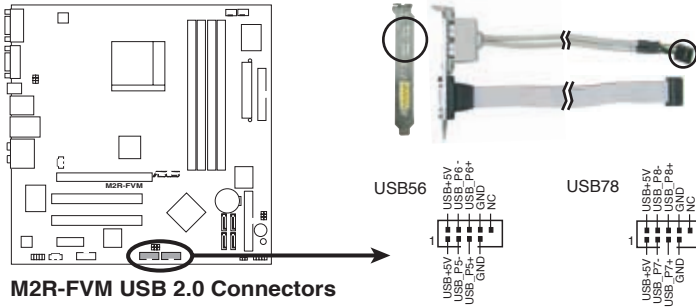

8. Internal audio connectors (4-pin AUX1 [white])

These connectors allow you to receive stereo audio input from sound sources such as a CD-ROM, TV tuner, or MPEG card.

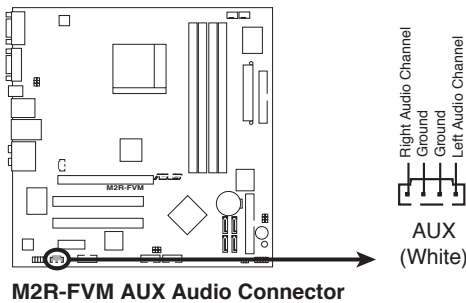

9. Front panel audio connector (10-1 pin F_AUDIO1)

This connector is for a chassis-mounted front panel audio I/O module.

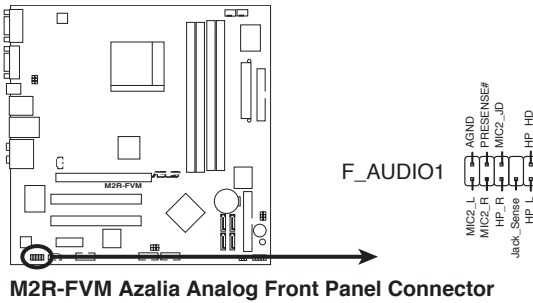

10. IEEE 1394a port connector (10-1 pin IE1394_2)

This connector is for a IEEE 1394a port. Connect the IEEE 1394a module cable to this connector, then install the module to a slot opening at the back of the system chassis.

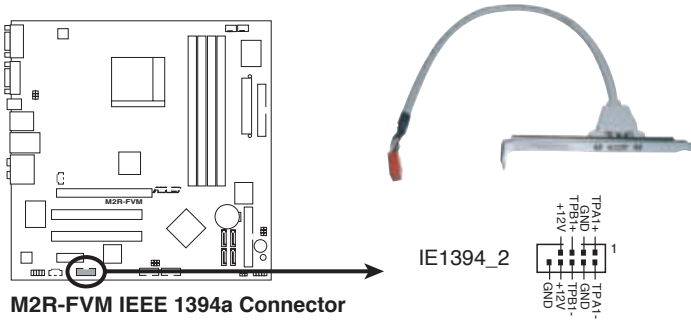

Never connect a USB cable to the IEEE 1394a connector. Doing so will damage the motherboard!

11. System panel connector (10-1 pin F_PANEL1)

This connector supports several chassis-mounted functions.

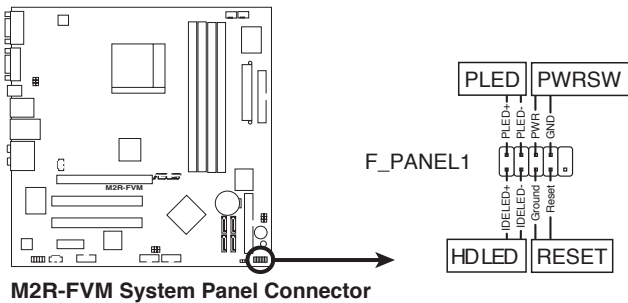

The system panel connector is color-coded for easy connection. Refer to the connector description below for details.

- **System power LED (Green 2-pin PWR_LED)**
This 3-pin connector is for the system power LED. Connect the chassis power LED cable to this connector. The system power LED lights up when you turn on the system power, and blinks when the system is in sleep mode.
- **Hard disk drive activity LED (Red 2-pin HD_LED)**
This 2-pin connector is for the HDD Activity LED. Connect the HDD Activity LED cable to this connector. The IDE LED lights up or flashes when data is read from or written to the HDD.
- **ATX power button/soft-off button (black 2-pin PWR_BTN)**
This connector is for the system power button. Pressing the power button turns the system on or puts the system in sleep or soft-off mode depending on the BIOS settings. Pressing the power switch for more than four seconds while the system is ON turns the system OFF.
- **Reset button (Blue 2-pin RESET)**
This 2-pin connector is for the chassis-mounted reset button for system reboot without turning off the system power.

This chapter tells how to change the system settings through the BIOS Setup menus. Detailed descriptions of the BIOS parameters are also provided.

BIOS setup **2**

2.1 Managing and updating your BIOS

The following utilities allow you to manage and update the motherboard Basic Input/Output System (BIOS) setup.

1. ASUS EZ Flash (Updates the BIOS in DOS using a floppy disk.)
2. Award BIOS Flash Utility (Updates the BIOS in DOS mode using a bootable floppy disk.)
3. ASUS CrashFree BIOS 2 (Updates the BIOS using a bootable floppy disk when the BIOS file fails or gets corrupted.)

Refer to the corresponding sections for details on these utilities.



Save a copy of the original motherboard BIOS file to a bootable floppy disk in case you need to restore the BIOS in the future. Copy the original motherboard BIOS using the ASUS Update or Award BIOS Flash utilities.

2.1.1 Creating a bootable floppy disk

1. Do either one of the following to create a bootable floppy disk.

DOS environment

- a. Insert a 1.44MB floppy disk into the drive.
- b. At the DOS prompt, type `format A:/S` then press <Enter>.

Windows® XP environment

- a. Insert a 1.44 MB floppy disk to the floppy disk drive.
- b. Click Start from the Windows® desktop, then select My Computer.
- c. Select the 3 1/2 Floppy Drive icon.
- d. Click File from the menu, then select Format. A Format 3 1/2 Floppy Disk window appears.
- e. Select Create an MS-DOS startup disk from the format options field, then click Start.

Windows® 2000 environment

To create a set of boot disks for Windows® 2000:

- a. Insert a formatted, high density 1.44 MB floppy disk into the drive.
 - b. Insert the Windows® 2000 CD to the optical drive.
 - c. Click Start, then select Run.
 - d. From the Open field, type
`D:\bootdisk\makeboot a:`
assuming that D: is your optical drive.
 - e. Press <Enter>, then follow screen instructions to continue.
2. Copy the original or the latest motherboard BIOS file to the bootable floppy disk.

2.1.2 ASUS EZ Flash utility

The ASUS EZ Flash feature allows you to update the BIOS without having to go through the long process of booting from a floppy disk and using a DOS-based utility. The EZ Flash utility is built-in the BIOS chip so it is accessible by pressing <Alt> + <F2> during the Power-On Self Tests (POST).

To update the BIOS using EZ Flash:

1. Visit the ASUS website (www.asus.com) to download the latest BIOS file for the motherboard.
2. Save the BIOS file to a floppy disk, then restart the system.
3. Press <Alt> + <F2> during POST to display the following.

```
Insert Disk then press Enter or ESC to continue POST
```

4. Insert the floppy disk that contains the BIOS file to the floppy disk drive then press <Enter>. The following screen appears.

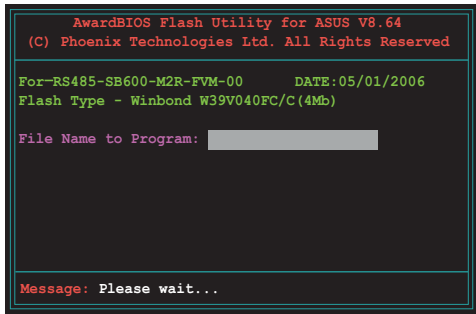

5. When the correct BIOS file is found, EZ Flash performs the BIOS update process and automatically reboots the system when done.



Do not shut down or reset the system while updating the BIOS to prevent system boot failure!

2.1.3 Award BIOS Flash Utility

The Basic Input/Output System (BIOS) can be updated using the AwardBIOS Flash Utility. Follow these instructions to update the BIOS using this utility.

1. Download the latest BIOS file from the ASUS web site. Rename the file to *.BIN and save it to a floppy disk.



Save only the updated BIOS file in the floppy disk to avoid loading the wrong BIOS file.

2. Copy the AwardBIOS Flash Utility (awdfash.exe) to the floppy disk with the latest BIOS file.
3. Boot the system in DOS mode using the bootable floppy disk you created earlier.
4. When the A:> appears, replace the bootable floppy disk with the floppy disk containing the new BIOS file and the Award BIOS Flash Utility.
5. At the prompt, type awdfash then press <Enter>. The Award BIOS Flash Utility screen appears.

```
AwardBIOS Flash Utility for ASUS V8.64
(C) Phoenix Technologies Ltd. All Rights Reserved

For-RS485-SB600-M2R-FVM-00      DATE:05/01/2006
Flash Type - Winbond W39V040FC/C(4Mb)

File Name to Program: 

Message: Please input File Name!
```

6. Type the BIOS file name in the File Name to Program field, then press <Enter>.

```
AwardBIOS Flash Utility for ASUS V8.64
(C) Phoenix Technologies Ltd. All Rights Reserved

For-RS485-SB600-M2R-FVM-00      DATE:05/01/2006
Flash Type - Winbond W39V040FC/C(4Mb)

File Name to Program: 0114.bin
```

- Press <N> when the utility prompts you to save the current BIOS file. The following screen appears.
- The utility verifies the BIOS file in the floppy disk and starts flashing the BIOS file.

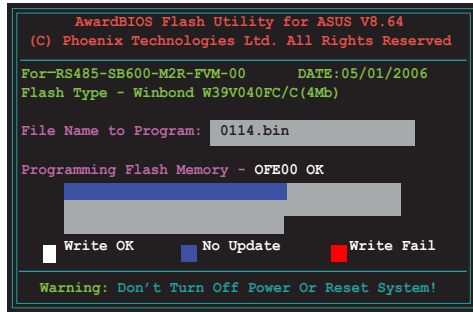

Do not turn off or reset the system during the flashing process!

- The utility displays a Flashing Complete message indicating that you have successfully flashed the BIOS file. Remove the floppy disk then press <F1> to restart the system.

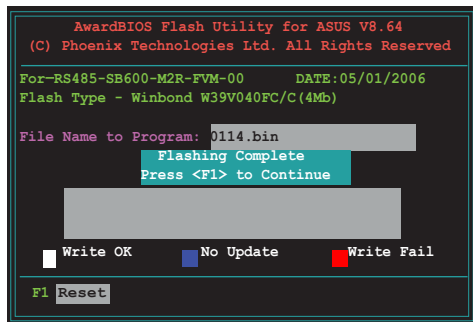

2.1.4 Saving the current BIOS file

You can use the AwardBIOS Flash Utility to save the current BIOS file. You can load the current BIOS file when the BIOS file gets corrupted during the flashing process.



Make sure that the floppy disk has enough disk space to save the file.

To save the current BIOS file using the AwardBIOS Flash Utility:

1. Follow steps 1 to 6 of the previous section.
2. Press <Y> when the utility prompts you to save the current BIOS file. The following screen appears.

```
AwardBIOS Flash Utility for ASUS V8.64
(C) Phoenix Technologies Ltd. All Rights Reserved

For-RS485-SB600-M2R-FVM-00    DATE:05/01/2006
Flash Type - Winbond W39V040FC/C(4Mb)

File Name to Program: 0114.bin
Save current BIOS as:

Message:
```

3. Type a filename for the current BIOS file in the Save current BIOS as field, then press <Enter>.

```
AwardBIOS Flash Utility for ASUS V8.64
(C) Phoenix Technologies Ltd. All Rights Reserved

For-RS485-SB600-M2R-FVM-00    DATE:05/01/2006
Flash Type - Winbond W39V040FC/C(4Mb)

File Name to Program: 0114.bin
Checksum: E52BH
Save current BIOS as: 0109.bin

Message: Please Wait!
```

4. The utility saves the current BIOS file to the floppy disk, then returns to the BIOS flashing process.

```
AwardBIOS Flash Utility for ASUS V8.64
(C) Phoenix Technologies Ltd. All Rights Reserved

For-RS485-SB600-M2R-FVM-00    DATE:05/01/2006
Flash Type - Winbond W39V040FC/C(4Mb)

File Name to Program: 0109.bin
Now Backup System BIOS to
File!

Message: Please Wait!
```

2.1.5 ASUS CrashFree BIOS 2 utility

The ASUS CrashFree BIOS 2 is an auto recovery tool that allows you to restore the BIOS file when it fails or gets corrupted during the updating process. You can update a corrupted BIOS file using a floppy disk that contains the updated BIOS file.



Prepare a floppy disk containing the updated motherboard BIOS before using this utility.

Recovering the BIOS from a floppy disk

To recover the BIOS from a floppy disk:

1. Turn on the system.
2. Insert the floppy disk with the original or updated BIOS file to the floppy disk drive.
3. The utility displays the following message and automatically checks the floppy disk for the BIOS file.

```
Award BootBlock BIOS v1.0
Copyright (c) 2000, Award Software, Inc.

BIOS ROM checksum error
Detecting IDE ATAPI device...
```

When found, the utility reads the BIOS file and starts flashing the corrupted BIOS file.

```
Award BootBlock BIOS v1.0
Copyright (c) 2000, Award Software, Inc.

BIOS ROM checksum error
Detecting IDE ATAPI device...
  Found CDROM, try to Boot from it... Pass
```



DO NOT shut down or reset the system while updating the BIOS! Doing so can cause system boot failure!

4. Restart the system after the utility completes the updating process.

2.2 BIOS setup program

This motherboard supports a programmable Low-Pin Count (LPC) chip that you can update using the provided utility described in section “4.1 Managing and updating your BIOS.”

Use the BIOS Setup program when you are installing a motherboard, reconfiguring your system, or prompted to “Run Setup.” This section explains how to configure your system using this utility.

Even if you are not prompted to use the Setup program, you can change the configuration of your computer in the future. For example, you can enable the security password feature or change the power management settings. This requires you to reconfigure your system using the BIOS Setup program so that the computer can recognize these changes and record them in the CMOS RAM of the LPC chip.

The LPC chip on the motherboard stores the Setup utility. When you start up the computer, the system provides you with the opportunity to run this program. Press during the Power-On Self-Test (POST) to enter the Setup utility; otherwise, POST continues with its test routines.

If you wish to enter Setup after POST, reboot the system by doing any of the following procedures:

- Restart using the OS standard shut-down procedure.
- Press <Ctrl>+<Alt>+ simultaneously.
- Press the reset button on the system chassis.
- Press the power button to turn the system off then back on.



Using the power button, reset button, or the <Ctrl>+<Alt>+ keys to force reset from a running operating system can cause damage to the data or system. We recommend to always shut-down the system properly from the operating system.

The Setup program is designed to make it as easy to use as possible. Being a menu-driven program, it lets you scroll through the various sub-menus and make your selections from the available options using the navigation keys.



- The default BIOS settings for this motherboard apply for most conditions to ensure optimum performance. If the system becomes unstable after changing any BIOS settings, load the default settings to ensure system compatibility and stability. Select the Load Default Settings item under the Exit Menu. See section “4.8 Exit Menu.”
 - The BIOS setup screens shown in this section are for reference purposes only, and may not exactly match what you see on your screen.
 - Visit the ASUS website (www.asus.com) to download the latest BIOS file for this motherboard.
-

2.2.1 BIOS menu screen

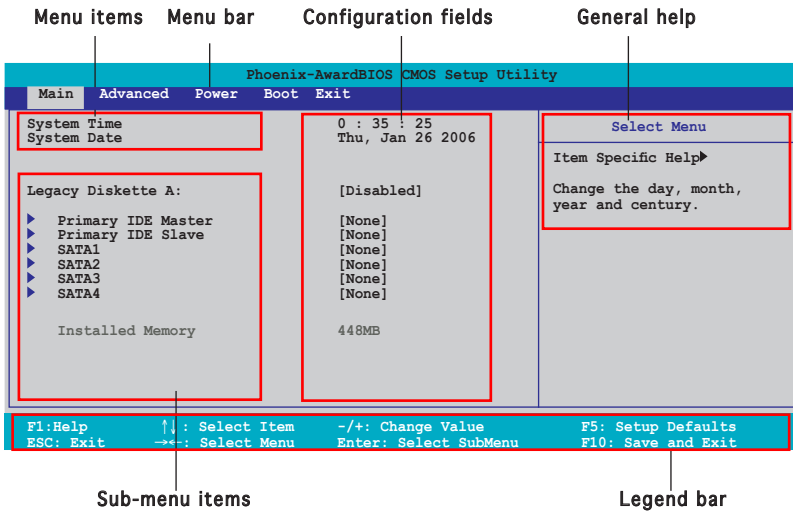

2.2.2 Menu bar

The menu bar on top of the screen has the following main items:

- Main** Select to change basic system configurations
- Advanced** Select to configure advanced system settings
- Power** Select for advanced power management (APM) configurations
- Boot** Select to change system boot configuration
- Exit** Select for the exit options and to load default BIOS settings

To select an item on the menu bar, press the right or left arrow key on the keyboard until the desired item is highlighted.



- The BIOS setup screens shown in this chapter are for reference purposes only, and may not exactly match what you see on your screen.
- Visit the ASUS website (www.asus.com) to download the latest BIOS information.

2.2.3 Legend bar

At the bottom of the Setup screen is a legend bar. The keys in the legend bar allow you to navigate through the various setup menus. The following table lists the keys found in the legend bar with their corresponding functions.

Navigation Key	Function
<F1>	Displays the General Help screen
<F5>	Loads setup default values
<Esc>	Exits the BIOS setup or returns to the main menu from a sub-menu
Left or Right arrow	Selects the menu item to the left or right
Up or Down arrow	Moves the highlight up or down between fields
Page Down or - (minus)	Scrolls backward through the values for the highlighted field
Page Up or + (plus)	Scrolls forward through the values for the highlighted field
<Enter>	Brings up a selection menu for the highlighted field
<F10>	Saves changes and exit

2.2.4 Menu items

The highlighted item on the menu bar displays the specific items for that menu. For example, selecting **Main** shows the Main menu items.

The other items (Advanced, Power, Boot, and Exit) on the menu bar have their respective menu items.

2.2.5 Sub-menu items

A solid triangle before each item on any menu screen means that the item has a sub-menu. To display the sub-menu, select the item and press <Enter>.

2.2.6 Configuration fields

These fields show the values for the menu items. If an item is user-configurable, you can change the value of the field opposite the item. You cannot select an item that is not user-configurable.

A configurable field is enclosed in brackets, and is highlighted when selected. To change the value of a field, select it then press <Enter> to display a list of options. Refer to “2.2.7 Pop-up window.”

2.2.7 Pop-up window

Select a menu item then press <Enter> to display a pop-up window with the configuration options for that item.

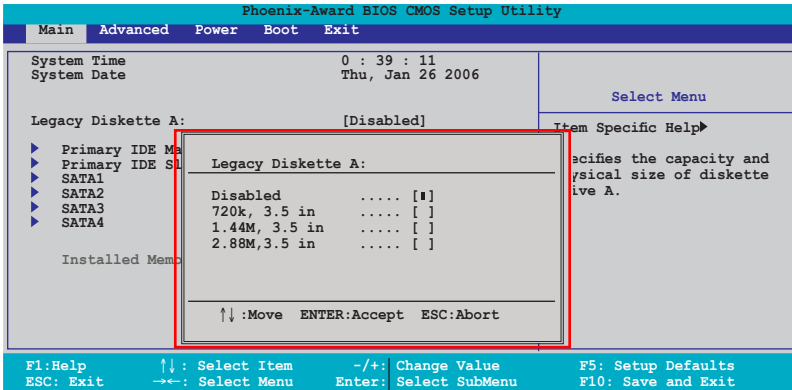

Pop-up menu

2.2.8 General help

At the top right corner of the menu screen is a brief description of the selected item.

2.3 Main menu

When you enter the BIOS Setup program, the Main menu screen appears, giving you an overview of the basic system information.



Refer to section “4.2.1 BIOS menu screen” for information on the menu screen items and how to navigate through them.

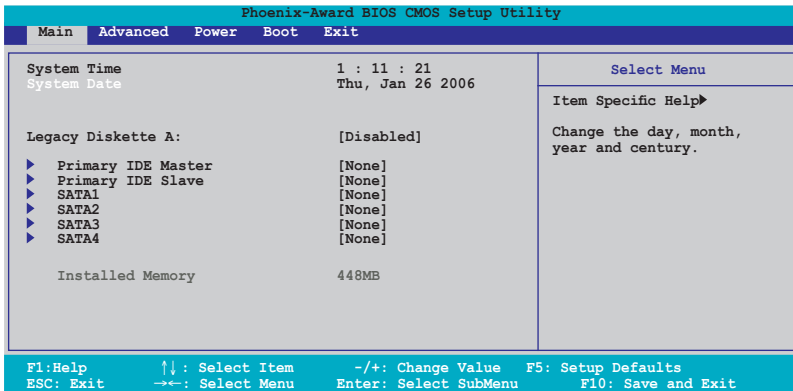

2.3.1 System Time [xx:xx:xx]

Allows you to set the system time.

2.3.2 System Date [Day xx/xx/xxxx]

Allows you to set the system date.

2.3.3 Legacy Diskette A [Disabled]

Specifies the capacity and physical size of diskette drive A.
Configuration options: [Disabled] [720K, 3.5 in.] [1.44M, 3.5 in.] [2.88M, 3.5 in.]

2.3.4 Primary IDE Master/Slave

While entering Setup, the BIOS automatically detects the presence of IDE devices. There is a separate sub-menu for each IDE device. Select a device item then press <Enter> to display the IDE device information.

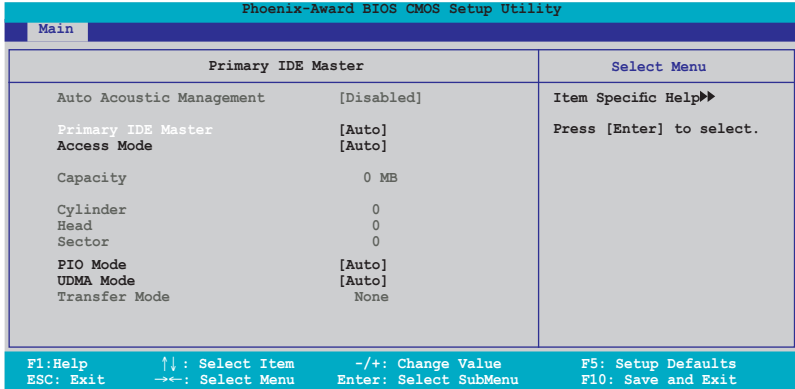

The BIOS automatically detects the values opposite the dimmed items (Capacity, Cylinder, Head, Sector and Transfer Mode). These values are not user-configurable. These items show “0/None” if no IDE device is installed in the system.

PIO Mode [Auto]

Sets a PIO mode for the IDE device. Mode 0 through 4 successive increase in performance. Configuration options: [Auto] [Mode 0] [Mode 1] [Mode 2] [Mode 3] [Mode 4]

UDMA Mode [Auto]

UDMA capability allows improved transfer speeds and data integrity for compatible IDE devices. Configuration options: [Disabled] [Auto]

Primary IDE Master [Auto]

Select [Auto] to automatically detect an IDE hard disk drive. If automatic detection is successful, the BIOS automatically fills in the correct values for the remaining fields on this sub-menu. If the hard disk was already formatted on a previous system, the setup BIOS may detect incorrect parameters. Select [Manual] to manually enter the IDE hard disk drive parameters. If no drive is installed select [None]. Configuration options: [None] [Auto] [Manual]

Access Mode [Auto]

The default [Auto] allows automatic detection of an IDE hard disk drive. Select [CHS] for this item if you set the IDE Primary Master/Slave to [Manual]. Configuration options: [CHS] [LBA] [Large] [Auto]



Before attempting to configure a hard disk drive, make sure you have the correct configuration information supplied by the drive manufacturer. Incorrect settings may cause the system to fail to recognize the installed hard disk.

Capacity

Displays the auto-detected hard disk capacity. This item is not configurable.

Cylinder

Shows the number of the hard disk cylinders. This item is not configurable.

Head

Shows the number of the hard disk read/write heads. This item is not configurable.

Sector

Shows the number of sectors per track. This item is not configurable.

Transfer Mode

Shows the Transfer mode. This item is not configurable.



After entering the IDE hard disk drive information into BIOS, use a disk utility, such as FDISK, to partition and format new IDE hard disk drives. This is necessary so that you can write or read data from the hard disk. Make sure to set the partition of the Primary IDE hard disk drives to active.

2.3.6 SATA1, 2, 3, 4

While entering Setup, the BIOS automatically detects the presence of Serial ATA devices. There is a separate sub-menu for each SATA device. Select a device item then press <Enter> to display the SATA device information.

Phoenix-Award BIOS CMOS Setup Utility		
Main		
First SATA Master		Select Menu
Auto Acoustic Management	Disabled	Item Specific Help▶▶ Selects the type of fixed disk connected to the system.
Extended IDE Drive Access Mode	[Auto] [Auto]	
Capacity	0 MB	
Cylinder	0	
Head	0	
Precomp	0	
Landing Zone	0	
Sector	0	
F1: Help ↑↓: Select Item -/+ : Change Value F5: Setup Defaults		
ESC: Exit →←: Select Menu Enter: Select SubMenu F10: Save and Exit		

The BIOS automatically detects the values opposite the dimmed items (Capacity, Cylinder, Head, Landing Zone and Sector). These values are not user-configurable. These items show 0 if no SATA device is installed in the system.

Extended Drive [Auto]

Selects the type of fixed disk connected to the system.
Configuration options: [None] [Auto]

Access Mode [Auto]

Sets the sector addressing mode. Configuration options: [Large] [Auto]



Before attempting to configure a hard disk drive, make sure you have the correct configuration information supplied by the drive manufacturer. Incorrect settings may cause the system to fail to recognize the installed hard disk.

Capacity

Displays the auto-detected hard disk capacity. This item is not configurable.

Cylinder

Shows the number of the hard disk cylinders. This item is not configurable.

Head

Shows the number of the hard disk read/write heads. This item is not configurable.

Landing Zone

Shows the number of landing zone per track. This item is not configurable.

Sector

Shows the number of sectors per track. This item is not configurable.



After entering the IDE hard disk drive information into BIOS, use a disk utility, such as FDISK, to partition and format new IDE hard disk drives. This is necessary so that you can write or read data from the hard disk. Make sure to set the partition of the Primary IDE hard disk drives to active.

2.3.7 Installed Memory [xxx MB]

Shows the size of installed memory.

2.4 Advanced menu

The Advanced menu items allow you to change the settings for the CPU and other system devices.



Take caution when changing the settings of the Advanced menu items. Incorrect field values can cause the system to malfunction.

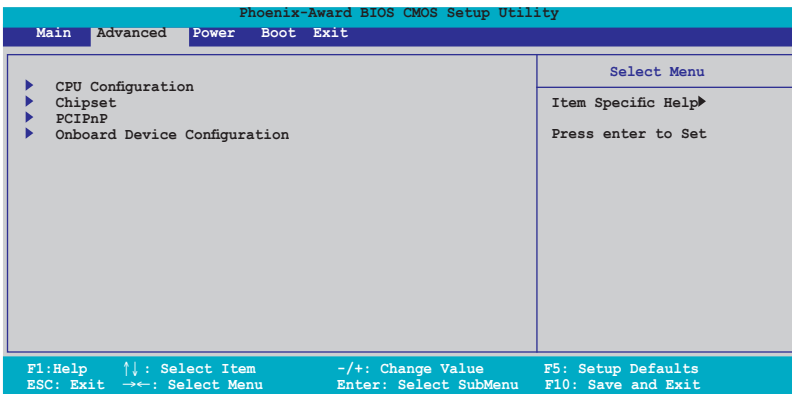

2.4.1 CPU Configuration

Phoenix-Award BIOS CMOS Setup Utility		
Advanced		
CPU Configuration		Select Menu
CPU Type	AMD Sempron(tm) Processor 3200+	Item Specific Help▶▶▶
CPU Speed	1800MHz	
Cache RAM	128K	
AMD Cool'n'Quiet Function	[Disabled]	

AMD Cool'n'Quiet Function [Disabled]

Enable or disable AMD Cool'n'Quiet function which support P-state transitions in AMD processors Configuration options:[Auto][Disabled]

2.4.2 Chipset

Phoenix-Award BIOS CMOS Setup Utility		
Advanced		
Chipset		Select Menu
▶ DRAM Configuration		Item Specific Help▶▶▶
▶ IDT & PCI Bus Control		
PCIE GFX Core Payload Size	[64 bytes]	
PCIE GPP Core Payload Size	[64 bytes]	DRAM timing and control
NB-SB Port Configuration	[Default]	
Onboard Video Memory	[64MB]	
▶ Frequency/Voltage control		
System BIOS Cacheable	[Disabled]	

DRAM Configuration

Phoenix-Award BIOS CMOS Setup Utility		
Advanced		
DRAM Configuration		Select Menu
Timing Mode	[Auto]	Item Specific Help▶▶▶
Memory Clock Frequency	Auto	
Bottom of UMA DRAM [31:24]	[FC]	

Timing Mode [Auto]

Configuration options: [Auto] [MaxMemCLK] [Manual]

Bottom of UMA DRAM [31:24]

Phoenix-Award BIOS CMOS Setup Utility		
Advanced		
DRAM Configuration		Select Menu
Timing Mode	[Auto]	Item Specific Help▶▶▶
Memory Clock Frequency	Auto	
Bottom of UMA DRAM	[FC]	

Bottom of UMA DRAM [31:24]

Min=0000
Max=00FC

Key in a HEX number:

ENTER: Accept ESC:Abort

LDT & PCI Bus Control

Phoenix-Award BIOS CMOS Setup Utility		
Advanced		
LDT & PCI Bus Control	Select Menu	
LDT Configuration	[Enabled]	Item Specific Help▶▶▶
Upstream LDT Bus Width	[16 bit]	
Downstream LDT Bus Width	[16 bit]	
LDT Bus Frequency	[Auto]	
PCIe Reset Delay	[Disabled]	

LDT Configuration [Enabled]

Allows you to enable or disable LDT configuration. Configuration options:

[Disabled] [Enabled]

Upstream LDT Bus Width [16 bit]

Allows you to select upstream LDT bus width. Configuration options: [8 bit] [16 bit]

Downstream LDT Bus Width [16 bit]

Allows you to select downstream LDT bus width. Configuration options: [8 bit] [16 bit]

LDT Bus Frequency [Auto]

Allows you to set LDT bus frequency. Configuration options: [Auto] [1 GHz] [800 MHz] [600 MHz] [400 MHz] [200 MHz]

PCIe Reset Delay [Disabled]

Allows you to enable or disable PCI Express reset delay. Configuration options: [Disabled] [Enabled]

PCIe GFX Core Payload Size [64 Bytes]

Sets the PCIe GFX Core Payload size. Configuration options: [16 Bytes] [32 Bytes] [64 Bytes].

PCIe GPP Core Payload Size [64 Bytes]

Sets the PCIe GPP Core Payload size. Configuration options: [16 Bytes] [32 Bytes] [64 Bytes].

NB-SB Port Configuration [Default]

Configuration options: [Default] [Enhanced]. In enhanced mode, GPP Links are configured 422 instead of 21111.

Onboard Video Memory [64MB]

Configuration options: [16MB] [32MB] [64MB] [128MB].

Frequency/Voltage control

Spread Spectrum [Enabled]

Select clock generator spread spectrum. Configuration options: [Disabled] [Enabled]

System BIOS Cacheable [Disabled]

Enable or disable BIOS cacheable. Configuration options: [Disabled] [Enabled].

2.4.3 PCIPnP

Phoenix-Award BIOS CMOS Setup Utility		
Advanced		
PCIPnP		Select Menu
Plug & Play O/S	[Yes]	Item Specific Help▶▶▶
Resources Controlled By x IRQ Resources	[Auto]	Select Yes if you are using a Plug and Play capable operating system. Select No if you need the BIOS to configure non-boot devices.
PCI/VGA Palette Snoop PCI Latency Timer (CLK)	[Disabled] [64]	
** PCI Express relative items ** Maximum Payload Size	[4096]	

Plug & Play O/S [Yes]

When set to [No], the BIOS configures all the devices in the system. When set to [Yes] and if you install a Plug and Play operating system, the operating system configures the Plug and Play devices not required for boot. Configuration options: [No] [Yes]

Resources Controlled By [Auto]

When set to [Auto], the BIOS automatically configures all the boot and Plug and Play compatible devices. Set to [Manual] if you want to assign the IRQ DMA and memory base address fields. Configuration options: [Auto] [Manual]



The item IRQ Resources becomes user-configurable when you set Resources Controlled By to [Manual].

Phoenix-Award BIOS CMOS Setup Utility		
Advanced		
IRQ Resources		Select Menu
IRQ-3 assigned to	[PCI Device]	Item Specific Help▶▶▶
IRQ-4 assigned to	[PCI Device]	Legacy ISA for devices compliant with the original PC AT bus specification, PCI/ISA PnP for devices compliant with the Plug and Play standard whether designed for PCI or ISA bus architecture.
IRQ-5 assigned to	[PCI Device]	
IRQ-7 assigned to	[PCI Device]	
IRQ-9 assigned to	[PCI Device]	
IRQ-10 assigned to	[PCI Device]	
IRQ-11 assigned to	[PCI Device]	
IRQ-14 assigned to	[PCI Device]	
IRQ-15 assigned to	[PCI Device]	

IRQ-xx assigned to

When set to [PCI Device], the specific IRQ is free for use of PCI/PnP devices. When set to [Reserved], the IRQ is reserved for legacy ISA devices. Configuration options: [PCI Device] [Reserved]

PCI/VGA Palette Snoop [Disabled]

Some non-standard VGA cards may not show colors properly. Set this field to [Enable] to solve the problem. Configuration options:[Disabled] [Enabled].

PCI Latency Timer (CLK) [64]

Sets the PCI Latency Timer by key in a DEC number.

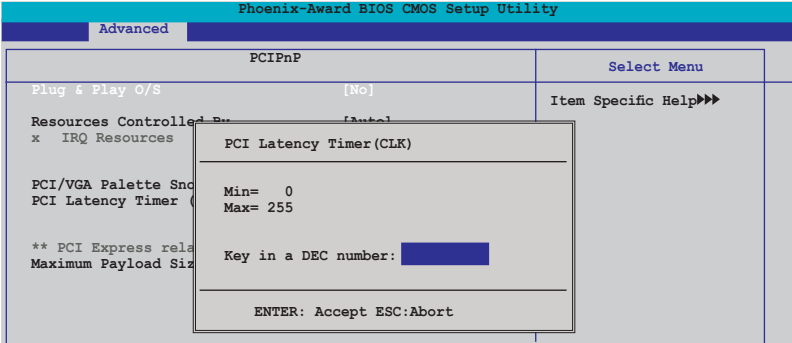

Maximum Payload Size [4096]

Set maximum TLP payload size for the PCI Express devices. The unit is byte. Configuration options:[128] [256] [512] [1024] [2048] [4096].

2.4.4 Onboard Device Configuration

Phoenix-Award BIOS CMOS Setup Utility		
Advanced		
Onboard Device Configuration		Select Menu
<ul style="list-style-type: none"> ▶ South OnChip IDE Device Onboard 1394 Controller [Enabled] Onboard LAN [Enabled] Onboard LAN Boot ROM [Disabled] ▶ South OnChip PCI Device Onboard SATA Type [IDE Controller] Init Display First [PCIEx] x Surroundview Disabled Serial Port1 Address [3F8/IRQ4] MODEM Use IRQ [3] ▶ USB Configuration 		Item Specific Help▶▶
F1: Help ↑↓: Select Item -/+ : Change Value F5: Setup Defaults ESC: Exit ←→: Select Menu Enter: Select Sub-menu F10: Save and Exit		

South OnChip IDE Device

This sub-menu contains IDE function-related items. Select an item then press <Enter> to edit.

Phoenix-Award BIOS CMOS Setup Utility		
Advanced		
South OnChip IDE Device		Select Menu
IDE DMA transfer access [Enabled] OnChip IDE Channel0 [Enabled] IDE Prefetch Mode [Disabled]		Item Specific Help▶▶▶

OnChip IDE Channel0 [Enabled]

Allows you to enable or disable the onchip IDE channel 0 controller .
 Configuration options: [Disabled] [Enabled]

IDE DMA transfer access [Enabled]

Allows you to enable or disable the IDE DMA transfer access.
 Configuration options: [Disabled] [Enabled]

IDE Prefetch Mode [Disabled]

Allows you to enable or disable the IDE PIO read prefetch mode.
 Configuration options: [Disabled] [Enabled]

Onboard 1394 Controller [Enabled]

Enable/Disable onboard 1394 device support. Configuration options:[Disabled] [Enabled].

Onboard LAN [Enabled]

Enable/Disable onboard LAN. Configuration options:[Disabled] [Enabled].

Onboard LAN Boot ROM [Disabled]

Decide whether to invoke the boot ROM of the onboard LAN chip. Configuration options:[Disabled] [Enabled].

South OnChip PCI Device

The items in this menu allows you to change the South OnChip PCI devices related features. Select an item then press <Enter> to display the configuration options.

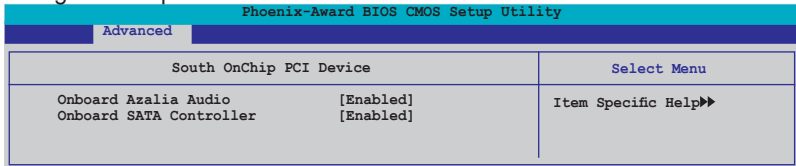

The screenshot shows the Phoenix-Award BIOS CMOS Setup Utility. The 'Advanced' menu is selected. The 'South OnChip PCI Device' menu is open, showing two items: 'Onboard Azalia Audio' and 'Onboard SATA Controller', both set to '[Enabled]'. A 'Select Menu' option is visible on the right, with 'Item Specific Help' selected.

South OnChip PCI Device		Select Menu
Onboard Azalia Audio	[Enabled]	Item Specific Help▶▶
Onboard SATA Controller	[Enabled]	

Onboard Azalia Audio [Enabled]

Allows you to enable or disable the onboard Azalia audio. Configuration options: [Disabled] [Enabled]

Onboard SATA Controller [Enabled]

Allows you to enable or disable the onboard SATA controller. Configuration options: [Disabled] [Enabled]

Onboard SATA Type [IDE Controller]

Allows you to select the onboard SATA type. Configuration options: [IDE Controller] [RAID Controller] [ACHI Controller]

Init Display First [PCIEx]

Select which graphics controller to use as the primary boot device. Configuration options: [PCI Slot] [OnChipVGA] [PCIEx]

Serial Port 1 Address [3F8/IRQ4]

Select the I/O address & IRQ. Configuration options: [Disabled] [3F8/IRQ4] [2F8/IRQ3] [3E8/IRQ4] [2E8/IRQ3] [Auto]

MODEM Use IRQ [3]

Configuration options: [NA] [3] [4] [5] [7] [9] [10] [11]

USB Configuration

The items in this menu allows you to change the USB related features. Select an item then press <Enter> to display the configuration options.

Phoenix-Award BIOS CMOS Setup Utility	
Advanced	
USB Configuration	Select Menu
USB 2.0 Controller [Enabled]	Item Specific Help▶▶
OnChip USB Controller [Enabled]	
USB Legacy support [Enabled]	

USB 2.0 Controller [Enabled]

Enable support for Universal Serial Bus 2.0.

Configuration options: [Disabled] [Enabled]

OnChip USB Controller [Enabled]

Allows you to enable or disable the OnChip USB controller.

Configuration options: [Disabled] [Enabled]

USB Legacy support [Enabled]

Allows you to enable or disable the USB legacy support.

Configuration options: [Disabled] [Enabled]

2.5 Power menu

The Power menu items allow you to change the settings for the Advanced Configuration and Power Interface (ACPI) and the Advanced Power Management (APM). Select an item then press <Enter> to display the configuration options.

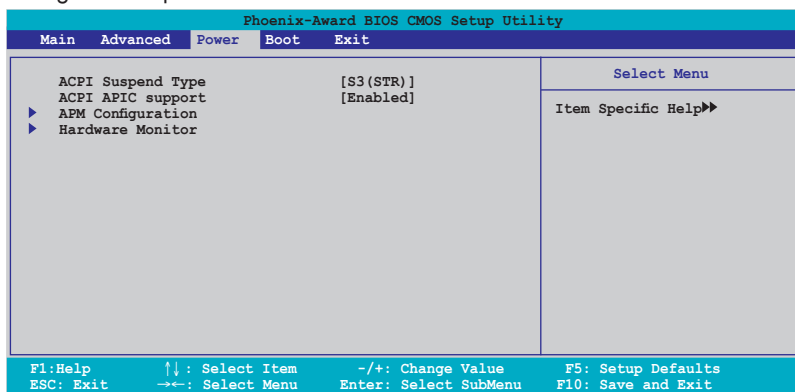

2.5.1 ACPI Suspend Type [S3(STR)]

Allows you to select the Advanced Configuration and Power Interface (ACPI) state to be used for system suspend. Configuration options: [S1 (POS)] [S3(STR)] [S1&S3]

2.5.2 ACPI APIC Support [Enabled]

Allows you to enable or disable the Advanced Configuration and Power Interface (ACPI) support in the Application-Specific Integrated Circuit (ASIC). When set to Enabled, the ACPI APIC table pointer is included in the RSDT pointer list. Configuration options: [Disabled] [Enabled]

2.5.3 APM Configuration

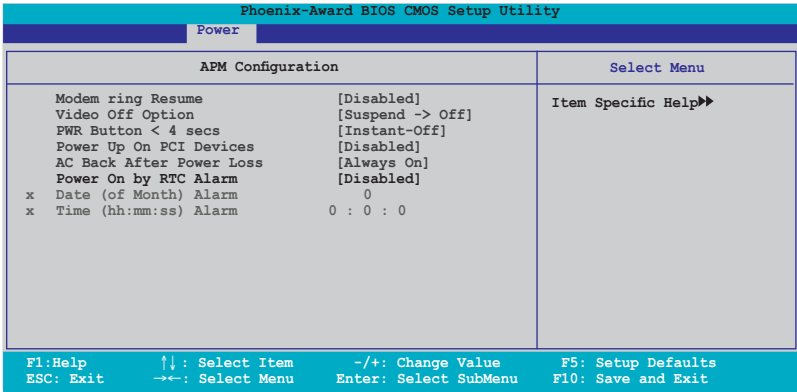

Modem Ring Resume [Disabled]

Allows you to enable or disable modem ring resume function.
 Configuration options: [Disabled] [Enabled]

Video Off Option [Suspend -> Off]

Determines when to activate the video off feature for minit power management. Configuration options: [Always on] [Suspend -> Off]

PWR Button < 4 secs [Instant-Off]

When set to [Instant-Off], the system will go soft-off when power button is pressed for less than 4 seconds. [Suspend] means holding the power for more than 4 seconds to power off the system. Configuration options: [Instant-Off] [Suspend]

Power Up On PCI Devices [Disabled]

Disable/Enable PME to generate a wake event. Configuration options: [Disabled] [Enabled]

AC Back After Power Loss [Always On]

Configuration options: [Always On] [Always Off] [Previous]

Power On by RTC Alarm

Disable or enable power on by RTC alarm function. Configuration options: [Disabled] [Enabled]

2.5.4 Hardware Monitor

The items in this sub-menu displays the hardware monitor values automatically detected by the BIOS. Select an item then press <Enter> to display the configuration options.

Phoenix-Award BIOS CMOS Setup Utility		
Power		
Hardware Monitor		Select Menu
CPU Temperature	40C	Item Specific Help▶▶
MB Temperature	33C	
Vccp	[Ignored]	
5V	[Ignored]	
12V	[Ignored]	
3.3V	[Ignored]	
CPU FAN Speed	3300 RPM	
Chassis FAN Speed	0 RMP	
Fan Control	[Enabled]	

F1: Help ↑↓ : Select Item -/+ : Change Value F5: Setup Defaults
ESC: Exit →← : Select Menu Enter: Select SubMenu F10: Save and Exit

Vccp [Ignored]

Configuration options: [1.38V] [Ignored]

5V [Ignored]

Configuration options: [5.12V] [Ignored]

12V [2C]

Configuration options: [12.02V] [Ignored]

3.3V [Ignored]

Configuration options: [3.29V] [Ignored]

Fan Control [Enabled]

Enable/Disable the control of the system/CPU fan speed by changing the fan voltage. Configuration options: [Enabled] [Disabled]

2.6 Boot menu

The Boot menu items allow you to change the system boot options. Select an item then press <Enter> to display the sub-menu.

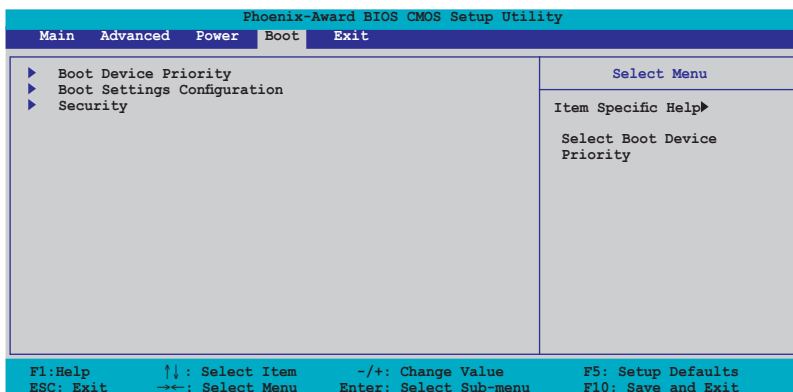

2.6.1 Boot Device Priority

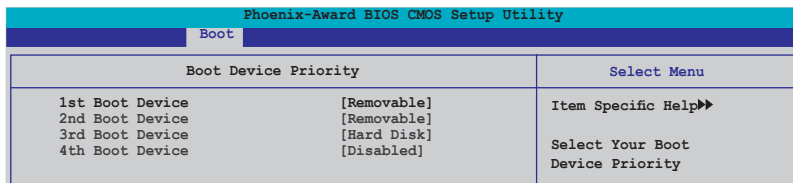

1st ~ 4th Boot Device [Removable]

These items specify the boot device priority sequence from the available devices. The number of device items that appears on the screen depends on the number of devices installed in the system. Configuration options: [Removable] [Hard Disk] [CDROM] [Disabled]

2.6.2 Boot Settings Configuration

Phoenix-Award BIOS CMOS Setup Utility			
Boot			
Boot Settings Configuration		Select Menu	
Quick Boot	[Enabled]	Item Specific Help▶▶	
Boot Up Floppy Seek	[Enabled]	Press [Enter] to enable or disable.	
Bootup Num-Lock	[On]		
Full Screen LOGO	[Enabled]		
Halt On	[No Errors]		

Fl:Help ↑↓: Select Item -/+ : Change Value F5: Setup Defaults
ESC: Exit →←: Select Menu Enter: Select Sub-menu F10: Save and Exit

Quick Boot [Enabled]

Allows you to enable or disable the system quick boot feature. When Enabled, the system skips certain tests while booting. Configuration options: [Disabled] [Enabled]

Boot Up Floppy Seek [Enabled]

Enables or disables the floppy seek feature while booting. Setting to Enabled, clears the chassis open status. Configuration options: [Disabled] [Enabled]

Bootup Num-Lock [On]

Allows you to select the power-on state for the NumLock. Configuration options: [Off] [On]

Full Screen LOGO [Enabled]

Allows you to enable or disable the full screen logo display feature. Configuration options: [Disabled] [Enabled]



Make sure that the above item is set to [Enabled] if you want to use the ASUS MyLogo™ feature.

Halt On [No Errors]

Allows you to select error report type. Configuration options: [All Errors] [No Errors] [All, But Keyboard] [All, But Diskette] [All, But Disk/Key]

2.6.3 Security

Phoenix-Award BIOS CMOS Setup Utility		
Boot		
Security		Select Menu
Supervisor Password	Clear	Item Specific Help▶▶
User Password	Clear	
Password Check	[Setup]	

Supervisor Password User Password

These fields allow you to set passwords:

To set a password:

1. Select an item then press <Enter>.
2. Type in a password using a combination of a maximum of eight (8) alpha-numeric characters, then press <Enter>.
3. When prompted, confirm the password by typing the exact characters again, then press <Enter>. The password field setting is changed to Set.

To clear the password:

1. Select the password field and press <Enter> twice. The following



2. Press any key to continue. The password field setting is changed to Clear.

A note about passwords

The Supervisor password is required to enter the BIOS Setup program preventing unauthorized access. The User password is required to boot the system preventing unauthorized use.

Forgot your password?

If you forget your password, you can clear it by erasing the CMOS Real Time Clock (RTC) RAM. The RAM data containing the password information is powered by the onboard button cell battery. If you need to erase the CMOS RAM, refer to section “2.6 Jumper” for instructions.

Password Check

This field requires you to enter the password before entering the BIOS setup or the system. Select [Setup] to require the password before entering the BIOS Setup. Select [System] to require the password before entering the system. Configuration options: [Setup] [System]

2.7 Exit menu

The Exit menu items allow you to load the optimal or failsafe default values for the BIOS items, and save or discard your changes to the BIOS items.

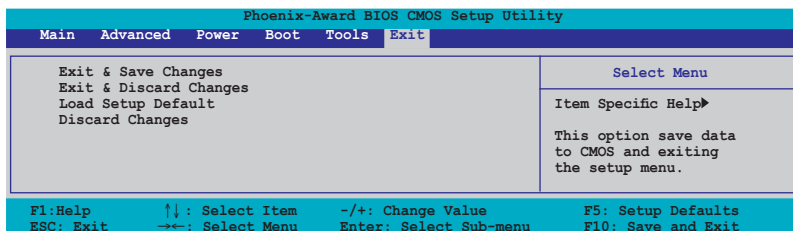

Pressing <Esc> does not immediately exit this menu. Select one of the options from this menu or <F10> from the legend bar to exit.

Exit & Save Changes

Once you are finished making your selections, choose this option from the Exit menu to ensure the values you selected are saved to the CMOS RAM. An onboard backup battery sustains the CMOS RAM so it stays on even when the PC is turned off. When you select this option, a confirmation window appears. Select YES to save changes and exit.



If you attempt to exit the Setup program without saving your changes, the program prompts you with a message asking if you want to save your changes before exiting. Press <Enter> to save the changes while exiting.

Exit & Discard Changes

Select this option only if you do not want to save the changes that you made to the Setup program. If you made changes to fields other than System Date, System Time, and Password, the BIOS asks for a confirmation before exiting.

Load Setup Defaults

This option allows you to load the default values for each of the parameters on the Setup menus. When you select this option or if you press <F5>, a confirmation window appears. Select YES to load default values. Select Exit & Save Changes or make other changes before saving the values to the non-volatile RAM.

Discard Changes

This option allows you to discard the selections you made and restore the previously saved values. After selecting this option, a confirmation appears. Select YES to discard any changes and load the previously saved values.