

ASRock®



FATAL1TY
GAMING 1 GEAR

970 PERFORMANCE
SERIES 1

User Manual

Version 1.0

Published October 2014

Copyright©2014 ASRock INC. All rights reserved.

Copyright Notice:

No part of this documentation may be reproduced, transcribed, transmitted, or translated in any language, in any form or by any means, except duplication of documentation by the purchaser for backup purpose, without written consent of ASRock Inc.

Products and corporate names appearing in this documentation may or may not be registered trademarks or copyrights of their respective companies, and are used only for identification or explanation and to the owners' benefit, without intent to infringe.

Disclaimer:

Specifications and information contained in this documentation are furnished for informational use only and subject to change without notice, and should not be constructed as a commitment by ASRock. ASRock assumes no responsibility for any errors or omissions that may appear in this documentation.

With respect to the contents of this documentation, ASRock does not provide warranty of any kind, either expressed or implied, including but not limited to the implied warranties or conditions of merchantability or fitness for a particular purpose.

In no event shall ASRock, its directors, officers, employees, or agents be liable for any indirect, special, incidental, or consequential damages (including damages for loss of profits, loss of business, loss of data, interruption of business and the like), even if ASRock has been advised of the possibility of such damages arising from any defect or error in the documentation or product.



This device complies with Part 15 of the FCC Rules. Operation is subject to the following two conditions:

- (1) this device may not cause harmful interference, and
- (2) this device must accept any interference received, including interference that may cause undesired operation.

CALIFORNIA, USA ONLY

The Lithium battery adopted on this motherboard contains Perchlorate, a toxic substance controlled in Perchlorate Best Management Practices (BMP) regulations passed by the California Legislature. When you discard the Lithium battery in California, USA, please follow the related regulations in advance.

“Perchlorate Material-special handling may apply, see www.dtsc.ca.gov/hazardouswaste/perchlorate”

ASRock Website: <http://www.asrock.com>

Manufactured under license under U.S. Patent Nos: 5,956,674; 5,974,380; 6,487,535; 7,003,467 & other U.S. and worldwide patents issued & pending. DTS, the Symbol, & DTS and the Symbol together is a registered trademark & DTS Connect, DTS Interactive, DTS Neo:PC are trademarks of DTS, Inc. Product includes software.

© DTS, Inc., All Rights Reserved.





Fatal1ty Story

Who knew that at age 19, I would be a World Champion PC gamer. When I was 13, I actually played competitive billiards in professional tournaments and won four or five games off guys who played at the highest level. I actually thought of making a career of it, but at that young age situations change rapidly. Because I've been blessed with great hand-eye coordination and a grasp of mathematics (an important element in video gaming) I gravitated to that activity.

GOING PRO

I started professional gaming in 1999 when I entered the CPL (Cyberathlete Professional League) tournament in Dallas and won \$4,000 for coming in third place. Emerging as one of the top players in the United States, a company interested in sponsoring me flew me to Sweden to compete against the top 12 players in the world. I won 18 straight games, lost none, and took first place, becoming the number one ranked Quake III player in the world in the process. Two months later I followed that success by traveling to Dallas and defending my title as the world's best Quake III player, winning the \$40,000 grand prize. From there I entered competitions all over the world, including Singapore, Korea, Germany, Australia, Holland and Brazil in addition to Los Angeles, New York and St. Louis.

WINNING STREAK

I was excited to showcase my true gaming skills when defending my title as CPL Champion of the year at the CPL Winter 2001 because I would be competing in a totally different first person shooter (fps) game, Alien vs. Predator II. I won that competition and walked away with a new car. The next year I won the same title playing Unreal Tournament 2003, becoming the only three-time CPL champion of the year. And I did it playing a different game each year, something no one else has ever done and a feat of which I am extremely proud.

At QuakeCon 2002, I faced off against my rival ZeRo4 in one of the most highly anticipated matches of the year, winning in a 14 to (-1) killer victory. Competing at Quakecon 2004, I became the World's 1st Doom3 Champion by defeating Daler in a series of very challenging matches and earning \$25,000 for the victory.

Since then Fatal1ty has traveled the globe to compete against the best in the world, winning prizes and acclaim, including the 2005 CPL World Tour Championship in New York City for a \$150,000 first place triumph. In August 2007, Johnathan was awarded the first ever Lifetime Achievement Award in the four year history of the eSports-Award for "showing exceptional sportsmanship, taking part in shaping eSports into what it is today and for being the prime representative of this young sport. He has become the figurehead for eSports worldwide".

LIVIN' LARGE

Since my first big tournament wins, I have been a "Professional Cyberathlete", traveling the world and livin' large with lots of International media coverage on outlets such as MTV, ESPN and a 60 Minutes segment on CBS to name only a few. It's unreal - it's crazy. I'm living a dream by playing video games for a living. I've always been athletic and took sports like hockey and football very seriously, working out and training hard. This discipline helps me become a better gamer and my drive to be the best has opened the doors necessary to become a professional.

A DREAM

Now, another dream is being realized – building the ultimate gaming computer, made up of the best parts under my own brand. Quality hardware makes a huge difference in competitions...a couple more frames per second and everything gets really nice. It's all about getting the computer processing faster and allowing more fluid movement around the maps.

My vision for Fatal1ty hardware is to allow gamers to focus on the game without worrying about their equipment, something I've preached since I began competing. I don't want to worry about my equipment. I want to be there – over and done with - so I can focus on the game. I want it to be the fastest and most stable computer equipment on the face of the planet, so quality is what Fatal1ty Brand products represent.



Johnathan "Fatal1ty" Wendel



Contents

Chapter 1 Introduction	1
1.1 Package Contents	1
1.2 Specifications	2
1.3 Motherboard Layout	6
1.4 I/O Panel	8
Chapter 2 Installation	10
2.1 Installing the CPU	11
2.2 Installing the CPU Fan and Heatsink	13
2.3 Installing Memory Modules (DIMM)	14
2.4 Expansion Slots (PCI and PCI Express Slots)	16
2.5 Jumpers Setup	17
2.6 Onboard Headers and Connectors	18
2.7 CrossFireX™, 3-Way CrossFireX™ and Quad CrossFireX™ Operation Guide	23
2.7.1 Installing Two CrossFireX™-Ready Graphics Cards	23
2.7.2 Installing Three CrossFireX™-Ready Graphics Cards	24
2.7.3 Driver Installation and Setup	25
2.8 M.2_SSD (NGFF) Module Installation Guide	26
Chapter 3 Software and Utilities Operation	28
3.1 Installing Drivers	28
3.2 F-Stream	29
3.3 ASRock APP Shop	33

3.3.1	UI Overview	33
3.3.2	Apps	34
3.3.3	BIOS & Drivers	37
3.3.4	Setting	38
3.4	Start8	39
3.5	XSplit Broadcaster	42
3.5.1	Live Streaming Your Gameplay	42
3.5.2	Recording Your Gameplay	45
Chapter 4 UEFI SETUP UTILITY		46
4.1	Introduction	46
4.1.1	UEFI Menu Bar	46
4.1.2	Navigation Keys	47
4.2	Main Screen	48
4.3	OC Tweaker Screen	49
4.4	Advanced Screen	54
4.4.1	CPU Configuration	55
4.4.2	North Bridge Configuration	57
4.4.3	South Bridge Configuration	58
4.4.4	Storage Configuration	59
4.4.5	Super IO Configuration	61
4.4.6	ACPI Configuration	62
4.4.7	USB Configuration	64
4.4.8	Trusted Computing	65
4.5	Tools	66

4.6	Hardware Health Event Monitoring Screen	69
4.7	Boot Screen	70
4.8	Security Screen	73
4.9	Exit Screen	74

Chapter 1 Introduction

Thank you for purchasing ASRock Fatal1ty 970 Performance Series motherboard, a reliable motherboard produced under ASRock's consistently stringent quality control. It delivers excellent performance with robust design conforming to ASRock's commitment to quality and endurance.

In this manual, Chapter 1 and 2 contains the introduction of the motherboard and step-by-step installation guides. Chapter 3 contains the operation guide of the software and utilities. Chapter 4 contains the configuration guide of the BIOS setup.



Because the motherboard specifications and the BIOS software might be updated, the content of this manual will be subject to change without notice. In case any modifications of this manual occur, the updated version will be available on ASRock's website without further notice. If you require technical support related to this motherboard, please visit our website for specific information about the model you are using. You may find the latest VGA cards and CPU support list on ASRock's website as well. ASRock website <http://www.asrock.com>.

1.1 Package Contents

- ASRock Fatal1ty 970 Performance Series Motherboard (ATX Form Factor)
- ASRock Fatal1ty 970 Performance Series Quick Installation Guide
- ASRock Fatal1ty 970 Performance Series Support CD
- 2 x Serial ATA (SATA) Data Cables (Optional)
- 1 x I/O Panel Shield
- 1 x Screw for M.2_SSD (NGFF) Socket 3

1.2 Specifications

- Platform**
- ATX Form Factor
 - ASRock DuraCap (2.5 x longer life time) (100% Japan-made high-quality conductive polymer capacitors)
 - High Density Glass Fabric PCB

- CPU**
- Supports Socket AM3+ processors
 - Supports Socket AM3 processors: AMD Phenom™ II X6 / X4 / X3 / X2 (except 920 / 940) / Athlon II X4 / X3 / X2 / Sempron processors
 - Supports 8-Core CPU
 - Supports UCC feature (Unlock CPU Core)
 - Digi Power design
 - 8 + 2 Power Phase design
 - Supports CPU up to 220W
 - Supports AMD's Cool 'n' Quiet Technology
 - FSB 2400 MHz (4.8 GT/s)
 - Supports Untied Overclocking Technology
 - Supports Hyper-Transport 3.0 (HT 3.0) Technology

- Chipset**
- Northbridge: AMD 970
 - Southbridge: AMD SB950

- Memory**
- Dual Channel DDR3 Memory Technology
 - 4 x DDR3 DIMM Slots
 - Supports DDR3 2400+(OC)/2100(OC)/1866(OC)/1800(OC)/1600(OC)/1333/1066 non-ECC, un-buffered memory (see CAUTION1)
 - Max. capacity of system memory: 64GB (see CAUTION2)
 - Supports Intel® Extreme Memory Profile (XMP) 1.3 / 1.2
 - Supports AMD Memory Profile Technology (AMP) up to AMP 2400

- Expansion Slot**
- 3 x PCI Express 2.0 x16 Slots (PCIE2/PCIE4/PCIE5: single at x16 (PCIE2); dual at x8 (PCIE2) / x8 (PCIE4); triple at x8 (PCIE2) / x8 (PCIE4) / x4 (PCIE5))

* If M.2 PCI Express module is installed, PCIE5 slot will be disabled.

- 2 x PCI Express 2.0 x1 Slots
- Supports AMD Quad CrossFireX™, 3-Way CrossFireX™ and CrossFireX™

Audio

- 7.1 CH HD Audio with Content Protection (Realtek ALC1150 Audio Codec)
- Premium Blu-ray Audio Support
- Supports Surge Protection (ASRock Full Spike Protection)
- Supports Purity Sound™ 2
 - Nichicon Fine Gold Series Audio Caps
 - 115dB SNR DAC with Differential Amplifier
 - TI® NE5532 Premium Headset Amplifier (Supports up to 600 Ohms headsets)
 - Direct Drive Technology
 - EMI Shielding Cover
 - PCB Isolate Shielding
- Supports DTS Connect

LAN

- PCIE x1 Gigabit LAN 10/100/1000 Mb/s
- Realtek RTL8111GR
- Supports Wake-On-WAN
- Supports Wake-On-LAN
- Supports Lightning/ESD Protection (ASRock Full Spike Protection)
- Supports LAN Cable Detection
- Supports Energy Efficient Ethernet 802.3az
- Supports PXE

Rear Panel I/O

- 1 x PS/2 Mouse Port
- 1 x PS/2 Keyboard Port
- 1 x Optical SPDIF Out Port
- 3 x USB 2.0 Ports (Supports ESD Protection (ASRock Full Spike Protection))
- 1 x Fatal1ty Mouse Port (USB 2.0) (Supports ESD Protection (ASRock Full Spike Protection))
- 4 x USB 3.0 Ports (Etron EJ188H) (Supports ESD Protection (ASRock Full Spike Protection))
- 1 x RJ-45 LAN Port with LED (ACT/LINK LED and SPEED LED)
- 1 x Clear CMOS Switch

- HD Audio Jacks: Rear Speaker / Central / Bass / Line in / Front Speaker / Microphone

Storage

- 6 x SATA3 6.0 Gb/s Connectors, support RAID (RAID 0, RAID 1, RAID 5 and RAID 10), NCQ, AHCI and Hot Plug
- 1 x M.2_SSD (NGFF) Socket 3, supports M.2 SATA3 6.0 Gb/s module and M.2 PCI Express module up to Gen2 x4 (20 Gb/s) (M.2_SSD (NGFF) Socket 3 is shared with the SATA3_0 connector)

Connector

- 1 x COM Port Header
- 1 x TPM Header
- 1 x Power LED Header
- 2 x CPU Fan Connectors (1 x 4-pin, 1 x 3-pin)
- 3 x Chassis Fan Connectors (1 x 4-pin, 2 x 3-pin)
- 1 x Power Fan Connector (3-pin)
- 1 x 24 pin ATX Power Connector
- 1 x 8 pin 12V Power Connector
- 2 x PCIe Power Connectors
- 1 x Front Panel Audio Connector
- 1 x SPDIF Out Connector
- 3 x USB 2.0 Headers (Support 6 USB 2.0 ports) (Supports ESD Protection (ASRock Full Spike Protection))
- 1 x USB 3.0 Header by ASMedia ASM1042A (Supports 2 USB 3.0 ports) (Supports ESD Protection (ASRock Full Spike Protection))

BIOS

Feature

- 32Mb AMI UEFI Legal BIOS with with GUI support
- Supports “Plug and Play”
- ACPI 1.1 Compliant wake up events
- Supports jumperfree
- SMBIOS 2.3.1 support
- CPU, VCCM, NB, SB Voltage multi-adjustment

Hardware Monitor

- CPU/Chassis temperature sensing
- CPU/Chassis/Power Fan Tachometer
- CPU/Chassis Quiet Fan (Auto adjust fan speed by CPU temperature)
- CPU/Chassis Fan multi-speed control
- Voltage monitoring: +12V, +5V, +3.3V, CPU Vcore Voltage

OS

- Microsoft® Windows® 8.1 32-bit / 8.1 64-bit / 8 32-bit / 8 64-bit / 7 32-bit / 7 64-bit / Vista™ 32-bit / Vista™ 64-bit / XP 32-bit / XP 64-bit

Certifications

- FCC, CE, WHQL
- ErP/EuP ready (ErP/EuP ready power supply is required)

* For detailed product information, please visit our website: <http://www.asrock.com>



Please realize that there is a certain risk involved with overclocking, including adjusting the setting in the BIOS, applying Untied Overclocking Technology, or using third-party overclocking tools. Overclocking may affect your system's stability, or even cause damage to the components and devices of your system. It should be done at your own risk and expense. We are not responsible for possible damage caused by overclocking.



1. Whether 2400/2100MHz memory speed is supported depends on the AM3/AM3+ CPU you adopt. If you want to adopt DDR3 2400/2100 memory module on this motherboard, please refer to the memory support list on our website for the compatible memory modules. ASRock website: <http://www.asrock.com>
2. Due to the operating system limitation, the actual memory size may be less than 4GB for the reservation for system usage under Windows® 32-bit OS. For Windows® 64-bit OS with 64-bit CPU, there is no such limitation. You can use ASRock XFast RAM to utilize the memory that Windows® cannot use.

1.3 Motherboard Layout

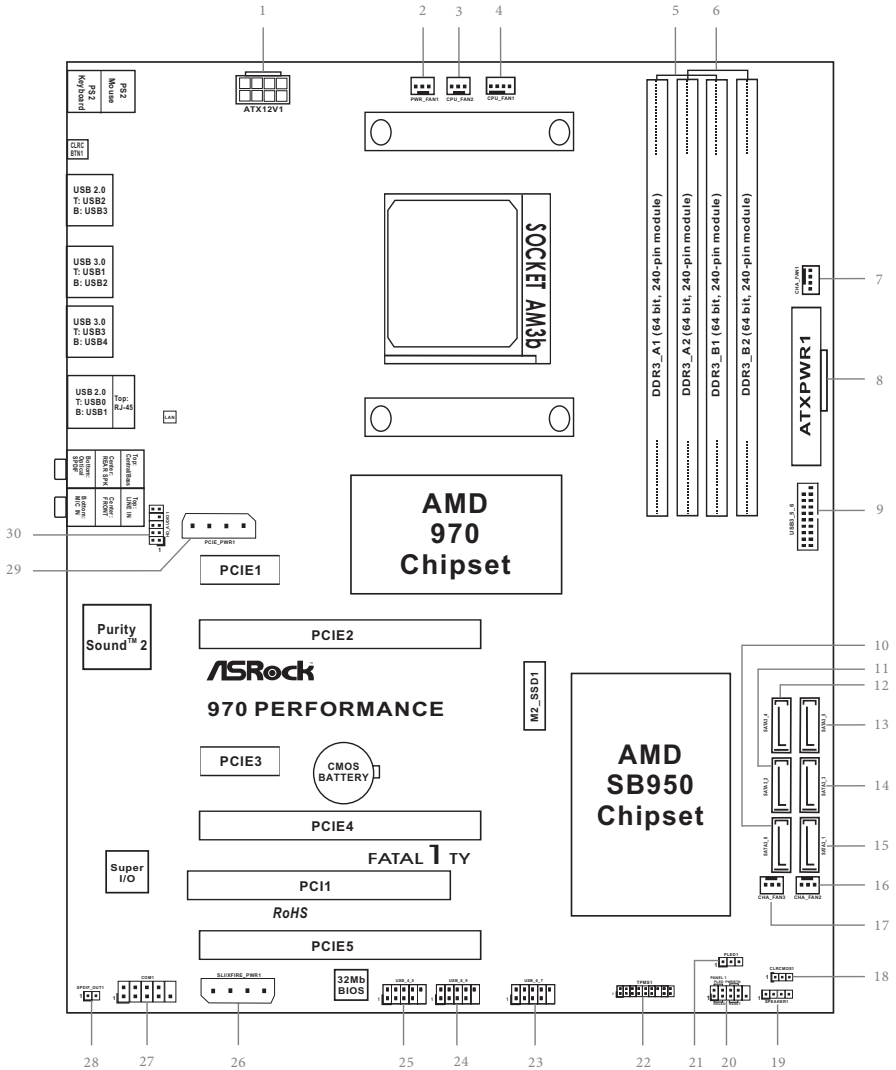

No.	Description
1	ATX 12V Power Connector (ATX12V1)
2	Power Fan Connector (PWR_FAN1)
3	CPU Fan Connector (CPU_FAN2)
4	CPU Fan Connector (CPU_FAN1)
5	2 x 240-pin DDR3 DIMM Slots (DDR3_A1, DDR3_B1)
6	2 x 240-pin DDR3 DIMM Slots (DDR3_A2, DDR3_B2)
7	Chassis Fan Connector (CHA_FAN1)
8	ATX Power Connector (ATXPWR1)
9	USB 3.0 Header (USB3_5_6)
10	SATA3 Connector (SATA3_0)
11	SATA3 Connector (SATA3_2)
12	SATA3 Connector (SATA3_4)
13	SATA3 Connector (SATA3_5)
14	SATA3 Connector (SATA3_3)
15	SATA3 Connector (SATA3_1)
16	Chassis Fan Connector (CHA_FAN2)
17	Chassis Fan Connector (CHA_FAN3)
18	Clear CMOS Jumper (CLRCMOS1)
19	Chassis Speaker Header (SPEAKER1)
20	System Panel Header (PANEL1)
21	Power LED Header (PLED1)
22	TPM Header (TPMS1)
23	USB 2.0 Header (USB_6_7)
24	USB 2.0 Header (USB_8_9)
25	USB 2.0 Header (USB_4_5)
26	PCIe Power Connector (SLI/XFIRE_PWR1)
27	COM Port Header (COM1)
28	SPDIF Out Connector (SPDIF_OUT1)
29	PCIe Power Connector (PCIE_PWR1)
30	Front Panel Audio Header (HD_AUDIO1)

1.4 I/O Panel

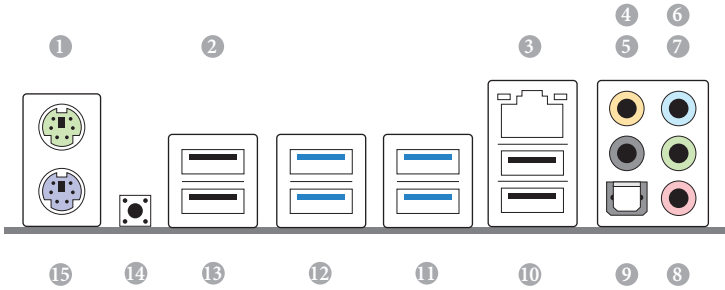

No.	Description	No.	Description
1	PS/2 Mouse Port	9	Optical SPDIF Out Port
2	Fatal1ty Mouse Port (USB_2)	10	USB 2.0 Ports (USB01)
3	LAN RJ-45 Port*	11	USB 3.0 Ports (USB3_34)
4	Central / Bass (Orange)	12	USB 3.0 Ports (USB3_12)
5	Rear Speaker (Black)	13	USB 2.0 Ports (USB_3)
6	Line In (Light Blue)	14	Clear CMOS Switch
7	Front Speaker (Lime)**	15	PS/2 Keyboard Port
8	Microphone (Pink)		

* There are two LEDs on each LAN port. Please refer to the table below for the LAN port LED indications.

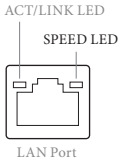

Activity / Link LED		Speed LED	
Status	Description	Status	Description
Off	No Link	Off	10Mbps connection
Blinking	Data Activity	Orange	100Mbps connection
On	Link	Green	1Gbps connection

** If you use a 2-channel speaker, please connect the speaker's plug into "Front Speaker Jack". See the table below for connection details in accordance with the type of speaker you use.

Audio Output Channels	Front Speaker (No. 7)	Rear Speaker (No. 5)	Central / Bass (No. 4)	Line In (No. 6)
2	V	--	--	--
4	V	V	--	--
6	V	V	V	--
8	V	V	V	V



To enable Multi-Streaming, you need to connect a front panel audio cable to the front panel audio header. After restarting your computer, you will find the "Mixer" tool on your system. Please select "Mixer ToolBox" , click "Enable playback multi-streaming", and click "ok". Choose "2CH", "4CH", "6CH", or "8CH" and then you are allowed to select "Realtek HDA Primary output" to use the Rear Speaker, Central/Bass, and Front Speaker, or select "Realtek HDA Audio 2nd output" to use the front panel audio.

Chapter 2 Installation

This is an ATX form factor motherboard. Before you install the motherboard, study the configuration of your chassis to ensure that the motherboard fits into it.

Pre-installation Precautions

Take note of the following precautions before you install motherboard components or change any motherboard settings.

- Make sure to unplug the power cord before installing or removing the motherboard. Failure to do so may cause physical injuries to you and damages to motherboard components.
- In order to avoid damage from static electricity to the motherboard's components, NEVER place your motherboard directly on a carpet. Also remember to use a grounded wrist strap or touch a safety grounded object before you handle the components.
- Hold components by the edges and do not touch the ICs.
- Whenever you uninstall any components, place them on a grounded anti-static pad or in the bag that comes with the components.
- When placing screws to secure the motherboard to the chassis, please do not over-tighten the screws! Doing so may damage the motherboard.

2.1 Installing the CPU



Unplug all power cables before installing the CPU.



3

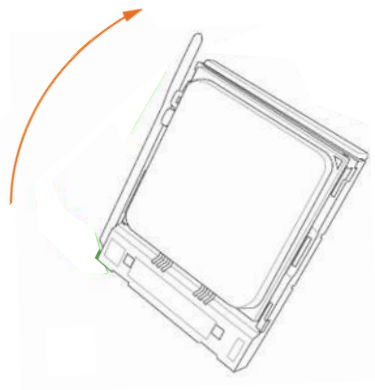

2.2 Installing the CPU Fan and Heatsink

After you install the CPU into this motherboard, it is necessary to install a larger heatsink and cooling fan to dissipate heat. You also need to spray thermal grease between the CPU and the heatsink to improve heat dissipation. Make sure that the CPU and the heatsink are securely fastened and in good contact with each other. Then connect the CPU fan to the CPU FAN connector. For proper installation, please kindly refer to the instruction manuals of the CPU fan and the heatsink.

2.3 Installing Memory Modules (DIMM)

This motherboard provides four 240-pin DDR3 (Double Data Rate 3) DIMM slots, and supports Dual Channel Memory Technology.



1. For dual channel configuration, you always need to install identical (the same brand, speed, size and chip-type) DDR3 DIMM pairs.
2. It is unable to activate Dual Channel Memory Technology with only one or three memory module installed.
3. It is not allowed to install a DDR or DDR2 memory module into a DDR3 slot; otherwise, this motherboard and DIMM may be damaged.
4. Please install the memory module into DDR3_A2 and DDR3_B2 slots for the first priority.
5. If you adopt DDR3 2400/2100 memory modules on this motherboard, it is recommended to install them on DDR3_A2 and DDR3_B2 slots.

Dual Channel Memory Configuration

Priority	DDR3_A1	DDR3_A2	DDR3_B1	DDR3_B2
1		Populated		Populated
2	Populated		Populated	
3	Populated	Populated	Populated	Populated



The DIMM only fits in one correct orientation. It will cause permanent damage to the motherboard and the DIMM if you force the DIMM into the slot at incorrect orientation.

1

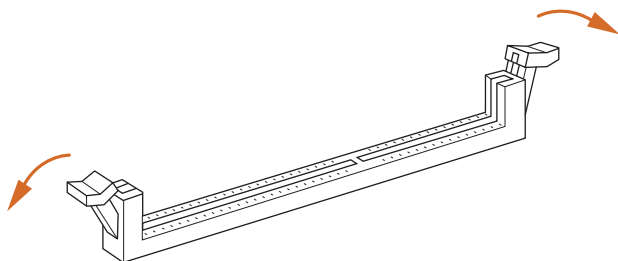

2

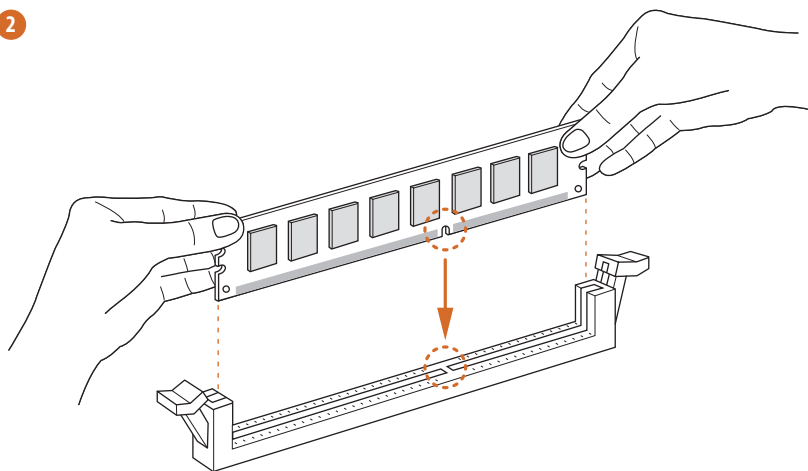

3

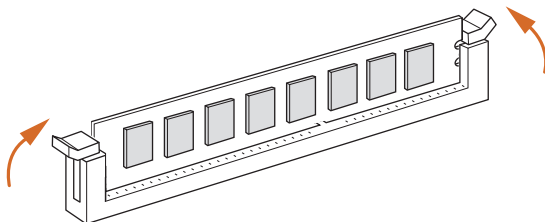

2.4 Expansion Slots (PCI and PCI Express Slots)

There is 1 PCI slot and 5 PCI Express slots on the motherboard.



Before installing an expansion card, please make sure that the power supply is switched off or the power cord is unplugged. Please read the documentation of the expansion card and make necessary hardware settings for the card before you start the installation.

PCI slot:

The PCI1 slot is used to install expansion cards that have 32-bit PCI interface.

PCIe slots:

PCIE1 (PCIe 2.0 x1 slot) is used for PCI Express x1 lane width cards.

PCIE2 (PCIe 2.0 x16 slot) is used for PCI Express x16 lane width graphics cards.

PCIE3 (PCIe 2.0 x1 slot) is used for PCI Express x1 lane width cards.

PCIE4 (PCIe 2.0 x16 slots) is used for PCI Express x8 lane width graphics cards.

PCIE5 (PCIe 2.0 x16 slot) is used for PCI Express x4 lane width graphics cards.

PCIe Slot Configurations

	PCIE2	PCIE4	PCIE5
Single Graphics Card	x16	N/A	N/A
Two Graphics Cards in CrossFireX™ Mode	x8	x8	N/A
Three Graphics Cards in 3-Way CrossFireX™ Mode	x8	x8	x4



For a better thermal environment, please connect a chassis fan to the motherboard's chassis fan connector (CHA_FAN1, CHA_FAN2 or CHA_FAN3) when using multiple graphics cards.

2.5 Jumpers Setup

The illustration shows how jumpers are setup. When the jumper cap is placed on the pins, the jumper is “Short”. If no jumper cap is placed on the pins, the jumper is “Open”. The illustration shows a 3-pin jumper whose pin1 and pin2 are “Short” when a jumper cap is placed on these 2 pins.

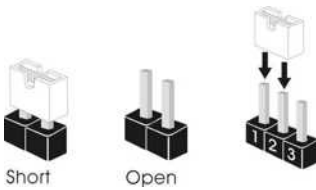

Clear CMOS Jumper
(CLRCMOS1)
(see p.6, No. 18)

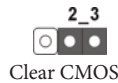

CLRCMOS1 allows you to clear the data in CMOS. To clear and reset the system parameters to default setup, please turn off the computer and unplug the power cord from the power supply. After waiting for 15 seconds, use a jumper cap to short pin2 and pin3 on CLRCMOS1 for 5 seconds. However, please do not clear the CMOS right after you update the BIOS. If you need to clear the CMOS when you just finish updating the BIOS, you must boot up the system first, and then shut it down before you do the clear-CMOS action. Please be noted that the password, date, time, and user default profile will be cleared only if the CMOS battery is removed.

2.6 Onboard Headers and Connectors



Onboard headers and connectors are NOT jumpers. Do NOT place jumper caps over these headers and connectors. Placing jumper caps over the headers and connectors will cause permanent damage to the motherboard.

System Panel Header
(9-pin PANEL1)
(see p.6, No. 20)

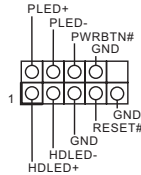

Connect the power switch, reset switch and system status indicator on the chassis to this header according to the pin assignments below. Note the positive and negative pins before connecting the cables.



PWRBTN (Power Switch):

Connect to the power switch on the chassis front panel. You may configure the way to turn off your system using the power switch.

RESET (Reset Switch):

Connect to the reset switch on the chassis front panel. Press the reset switch to restart the computer if the computer freezes and fails to perform a normal restart.

PLED (System Power LED):

Connect to the power status indicator on the chassis front panel. The LED is on when the system is operating. The LED keeps blinking when the system is in S1/S3 sleep state. The LED is off when the system is in S4 sleep state or powered off (S5).

HDLED (Hard Drive Activity LED):

Connect to the hard drive activity LED on the chassis front panel. The LED is on when the hard drive is reading or writing data.

The front panel design may differ by chassis. A front panel module mainly consists of power switch, reset switch, power LED, hard drive activity LED, speaker and etc. When connecting your chassis front panel module to this header, make sure the wire assignments and the pin assignments are matched correctly.

Power LED Header

(3-pin PLED1)
(see p.6, No. 21)

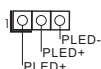

Please connect the chassis power LED to this header to indicate the system's power status.

Serial ATA Connectors

(SATA3_0:
see p.6, No. 10)
(SATA3_1:
see p.6, No. 15)
(SATA3_2:
see p.6, No. 11)
(SATA3_3:
see p.6, No. 14)
(SATA3_4:
see p.6, No. 12)
(SATA3_5:
see p.6, No. 13)

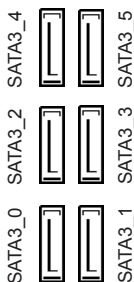

These six SATA3 connectors support SATA data cables for internal storage devices with up to 6.0 Gb/s data transfer rate.

USB 2.0 Headers

(9-pin USB_4_5)
(see p.6, No. 25)
(9-pin USB_6_7)
(see p.6, No. 23)
(9-pin USB_8_9)
(see p.6, No. 24)

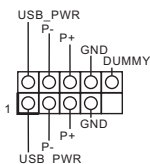

Besides four USB 2.0 ports on the I/O panel, there are three headers on this motherboard. Each USB 2.0 header can support two ports.

USB 3.0 Headers

(19-pin USB3_5_6)
(see p.6, No. 9)

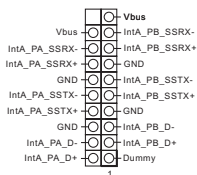

Besides four USB 3.0 ports on the I/O panel, there is one header and one port on this motherboard. Each USB 3.0 header can support two ports.

Front Panel Audio Header
(9-pin HD_AUDIO1)
(see p.6, No. 30)

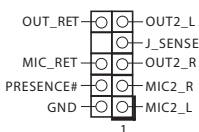

This header is for connecting audio devices to the front audio panel.



- High Definition Audio supports Jack Sensing, but the panel wire on the chassis must support HDA to function correctly. Please follow the instructions in our manual and chassis manual to install your system.
- If you use an AC'97 audio panel, please install it to the front panel audio header by the steps below:
 - Connect Mic_IN (MIC) to MIC2_L.
 - Connect Audio_R (RIN) to OUT2_R and Audio_L (LIN) to OUT2_L.
 - Connect Ground (GND) to Ground (GND).
 - MIC_RET and OUT_RET are for the HD audio panel only. You don't need to connect them for the AC'97 audio panel.
 - To activate the front mic, go to the "FrontMic" Tab in the Realtek Control panel and adjust "Recording Volume".

Chassis Speaker Header
(4-pin SPEAKER1)
(see p.6, No. 19)

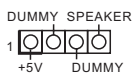

Please connect the chassis speaker to this header.

Chassis and Power Fan Connectors
(4-pin CHA_FAN1)
(see p.6, No. 7)

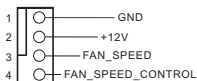

Please connect fan cables to the fan connectors and match the black wire to the ground pin.

(3-pin CHA_FAN2)
(see p.6, No. 16)

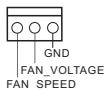

(3-pin CHA_FAN3)
(see p.6, No. 17)

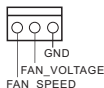

(3-pin PWR_FAN1)
(see p.6, No. 2)



CPU Fan Connectors

(4-pin CPU_FAN1)

(see p.6, No. 4)

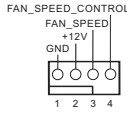

This motherboard provides a 4-Pin CPU fan (Quiet Fan) connector.

If you plan to connect a 3-Pin CPU fan, please connect it to Pin 1-3.

(3-pin CPU_FAN2)

(see p.6, No. 3)

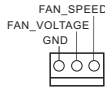

ATX Power Connector

(24-pin ATXPWR1)

(see p.6, No. 8)

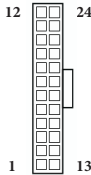

This motherboard provides a 24-pin ATX power connector. To use a 20-pin ATX power supply, please plug it along Pin 1 and Pin 13.

ATX 12V Power Connector

(8-pin ATX12V1)

(see p.6, No. 1)

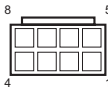

This motherboard provides an 8-pin ATX 12V power connector. To use a 4-pin ATX power supply, please plug it along Pin 1 and Pin 5.

PCIe Power Connectors

(4-pin SLI/XFIRE_PWR1)

(see p.6, No. 26)



Please connect this connector with a hard disk power connector when three graphics cards are installed on this motherboard.

(4-pin PCIE_PWR1)

(see p.6, No. 29)



Serial Port Header

(9-pin COM1)

(see p.6, No. 27)

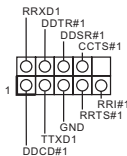

This COM1 header supports a serial port module.

SPDIF Out Connector
(2-pin SPDIF_OUT1)
(see p.6, No. 28)



Please connect the SPDIF_OUT connector of a HDMI VGA card to this header with a cable.

TPM Header
(17-pin TPMS1)
(see p.6, No. 22)

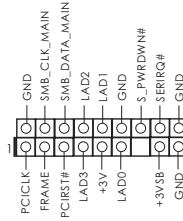

This connector supports Trusted Platform Module (TPM) system, which can securely store keys, digital certificates, passwords, and data. A TPM system also helps enhance network security, protects digital identities, and ensures platform integrity.

2.7 CrossFireX™, 3-Way CrossFireX™ and Quad CrossFireX™ Operation Guide

This motherboard supports CrossFireX™, 3-way CrossFireX™ and Quad CrossFireX™ that allows you to install up to three identical PCI Express x16 graphics cards. Currently CrossFireX™, 3-way CrossFireX™ and Quad CrossFireX™ are supported with Windows® 7 / 7 64-bit / 8 / 8 64-bit / 8.1 / 8.1 64-bit OS.



1. You should only use identical CrossFireX™-ready graphics cards that are AMD certified.
2. Make sure that your graphics card driver supports AMD CrossFireX™ technology. Download the drivers from the AMD's website: www.amd.com
3. Make sure that your power supply unit (PSU) can provide at least the minimum power your system requires. It is recommended to use a AMD certified PSU. Please refer to the AMD's website for details.
4. If you pair a 12-pipe CrossFireX™ Edition card with a 16-pipe card, both cards will operate as 12-pipe cards while in CrossFireX™ mode.
5. Different CrossFireX™ cards may require different methods to enable CrossFireX™. Please refer to AMD graphics card manuals for detailed installation guide.

2.7.1 Installing Two CrossFireX™-Ready Graphics Cards

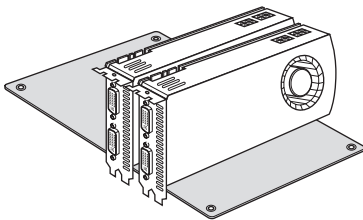

Step 1

Insert one graphics card into PCIE2 slot and the other graphics card to PCIE4 slot. Make sure that the cards are properly seated on the slots.



CrossFire Bridge

Step 2

Connect two graphics cards by installing a CrossFire Bridge on the CrossFire Bridge Interconnects on the top of the graphics cards. (The CrossFire Bridge is provided with the graphics card you purchase, not bundled with this motherboard. Please refer to your graphics card vendor for details.)

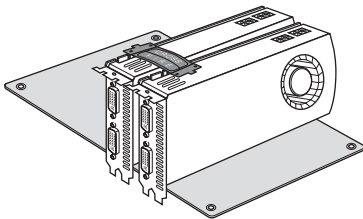

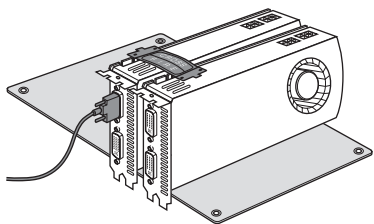

Step 3

Connect a VGA cable or a DVI cable to the monitor connector or the DVI connector of the graphics card that is inserted to PCIE2 slot.

2.7.2 Installing Three CrossFire™-Ready Graphics Cards

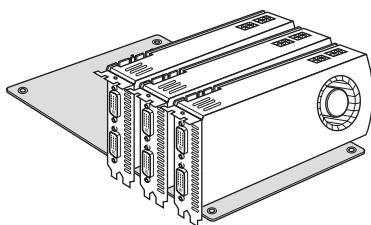

Step 1

Insert one graphics card into PCIE2 slot, another graphics card to PCIE4 slot, and the other graphics card to PCIE5 slot. Make sure that the cards are properly seated on the slots.



CrossFire Bridge

Step 2

Use one CrossFire Bridge to connect the graphics cards on PCIE2 and PCIE4 slots, and use the other CrossFire Bridge to connect the graphics cards on PCIE4 and PCIE5 slots. (The CrossFire Bridge is provided with the graphics card you purchase, not bundled with this motherboard. Please refer to your graphics card vendor for details.)

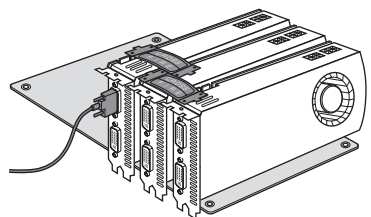
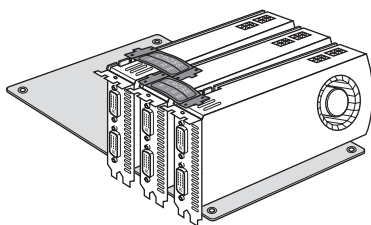

Step 3

Connect a VGA cable or a DVI cable to the monitor connector or the DVI connector of the graphics card that is inserted to PCIE2 slot.

2.7.3 Driver Installation and Setup

Step 1

Power on your computer and boot into OS.

Step 2

Remove the AMD drivers if you have any VGA drivers installed in your system.



The Catalyst Uninstaller is an optional download. We recommend using this utility to uninstall any previously installed Catalyst drivers prior to installation. Please check AMD's website for AMD driver updates.

Step 3

Install the required drivers and CATALYST Control Center then restart your computer. Please check AMD's website for details.



AMD Catalyst Control Center

Step 4

Double-click the **AMD Catalyst Control Center** icon in the Windows[®] system tray.



Step 5

In the left pane, click **Performance** and then **AMD CrossFireX™**. Then select **Enable AMD CrossFireX** and click **Apply**. Select the GPU number according to your graphics card and click **Apply**.

2.8 M.2_SSD (NGFF) Module Installation Guide

The M.2, also known as the Next Generation Form Factor (NGFF), is a small size and versatile card edge connector that aims to replace mPCIe and mSATA. The M.2_SSD (NGFF) Socket 3 can accommodate either a M.2 SATA3 6.0 Gb/s module or a M.2 PCI Express module up to Gen 2 x4 (20 Gb/s). Please be noted that the M.2_SSD (NGFF) Socket 3 is shared with the SATA3_0 connector; you can only choose either the M.2_SSD (NGFF) Socket 3 or the SATA3_0 connector to use.

Installing the M.2_SSD (NGFF) Module

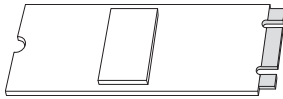

Step 1

Prepare a M.2_SSD (NGFF) module.

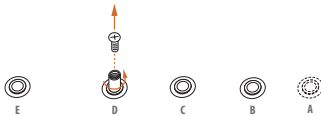

Step 2

Uninstall the screw knob and the standoff counterclockwise for later use.

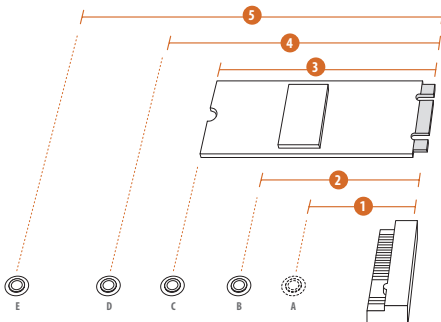

Step 3

Depending on the PCB length of your M.2_SSD (NGFF) module, find the corresponding NUT location to be used.

No.	1	2	3	4
Location	NUT1	NUT2	NUT3	NUT4
PCB Length	4.2cm	6cm	8cm	11cm
Module Type	Type 2242	Type2260	Type 2280	Type 22110

Step 4



Hand tighten the standoff into the desired NUT on the motherboard.

Step 5

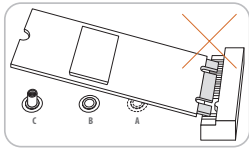

Align and gently insert the M.2 (NGFF) SSD module into the M.2 slot. Please be aware that the M.2 (NGFF) SSD module only fits in one orientation.

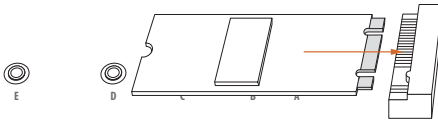

Step 6

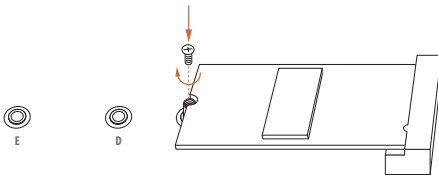

Tighten the screw knob to secure the module into place.

M.2_SSD (NGFF) Module Support List

PCIe Interface	SATA Interface
SanDisk SD6PP4M-128G	Intel SSDSCKGW080A401/80G
SanDisk SD6PP4M-256G	

For the latest updates of M.2_SSD (NFGG) module support list, please visit our website for details: <http://www.asrock.com>

Chapter 3 Software and Utilities Operation

3.1 Installing Drivers

The Support CD that comes with the motherboard contains necessary drivers and useful utilities that enhance the motherboard's features.

Running The Support CD

To begin using the support CD, insert the CD into your CD-ROM drive. The CD automatically displays the Main Menu if "AUTORUN" is enabled in your computer. If the Main Menu does not appear automatically, locate and double click on the file "ASRSETUP.EXE" in the Support CD to display the menu.

Drivers Menu

The drivers compatible to your system will be auto-detected and listed on the support CD driver page. Please click **Install All** or follow the order from top to bottom to install those required drivers. Therefore, the drivers you install can work properly.

Utilities Menu

The Utilities Menu shows the application software that the motherboard supports. Click on a specific item then follow the installation wizard to install it.

3.2 F-Stream

F-Stream is an all-in-one tool to fine-tune different system functions in a user-friendly interface, it includes Hardware Monitor, Fan Control, Overclocking, FatalIty Mouse Port, Energy Saving and XFast RAM. In Hardware Monitor, it shows the major readings of your system. In Fan Control, it shows the fan speed and temperature for you to adjust. In Overclocking, you are allowed to overclock CPU frequency for optimal system performance. In FatalIty Mouse Port, you can adjust the mouse polling rate to enjoy FatalIty Mouse Polling feature. In Energy Saving, you can enjoy the intelligent power saving feature. In XFast RAM, it fully utilizes the memory space that cannot be used under Windows® OS 32-bit CPU. It also shortens the loading time of previously visited websites, making web surfing faster than ever. And it also boosts the speed of Adobe Photoshop 5 times faster. Another advantage is that it reduces the frequency of accessing your SSDs or HDDs in order to extend their lifespan.

3.2.1 Installing F-Stream

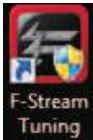
When you install the all-in-one driver to your system from our support CD, F-Stream will be auto-installed as well. After installation, you will find the icon “F-Stream” on your desktop. Double-click the “F-Stream” icon , and the F-Stream main menu will pop out.

3.2.2 Using F-Stream

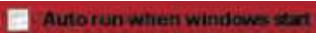
Please be noted that there is a button “Auto run when windows start” on the lower right corner. If you click this button, every time you turn on your system and enter Windows®, the system will automatically start F-Stream. 

There are six sections in the F-Stream main menu: Hardware Monitor, Fan Control, Overclocking, FatalIty Mouse Port, Energy Saving and XFast RAM.

Hardware Monitor

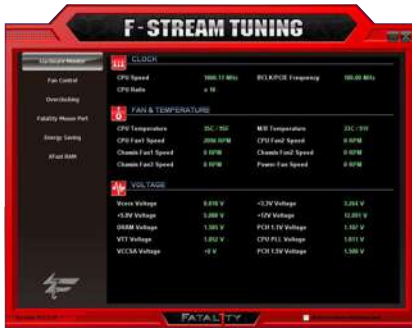

In the Hardware Monitor section, it shows the major readings of your system. The main readings include Clock, Fan & Temperature, and Voltage. In Clock, there are CPU speed and CPU ratio. In Fan & Temperature, there are CPU temperature and CPU fan speed. You may find out if there are any abnormal situations occurring to your system's temperature. In Voltage, there are many respective voltages.

Fan Control

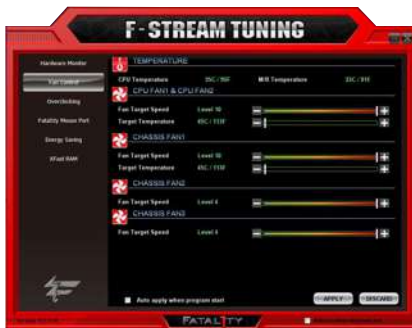

In the Fan Control section, there are two major chapters: Temperature and CPU/Chassis Fan. In Temperature, it shows the major readings of CPU and motherboard temperature. In CPU/Chassis Fan, it shows the fan target speed and temperature, and you are able to adjust the settings by clicking the "+/-" and confirming by "APPLY" afterwards.

Overclocking

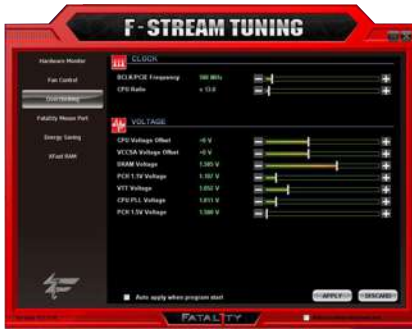

In the Overclocking section, there are Clock and Voltage chapters for users to adjust settings and pursue optimal system performance. You are able to fine-tune the CPU ratio, CPU frequency, and respective voltages by clicking the “+/-” at the display panel. After confirmation of the settings, please click on the “APPLY” button.



Overclocking and over-voltage may affect your system's stability, or even cause damage to your hardware devices. It should be done at your own risk and expense. We are not responsible for the possible damage caused by overclocking and overvoltage. If system hangs after overclocking, please remove the AC power cord and plug the AC power cord back on again before you power on your system.

Fatal1ty Mouse Port

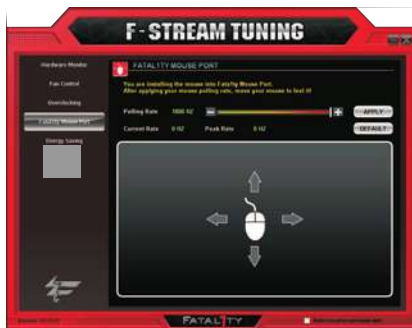

Fatal1ty Mouse Port is a customizable technology for PC gamers. After plugging the USB mouse into the Fatal1ty Mouse Port and running F-Stream, gamers can use Fatal1ty's personal preferred mouse polling rate at 500 Hz. F-Stream also provides the flexibility for gamers to adjust the mouse polling rate from 125 Hz to 1000 Hz. This is helpful for professional gamers to experience smoother game play and faster response time from the mouse. After confirmation of the settings, please click on the “APPLY” button.

Energy Saving



Featuring an advanced proprietary hardware and software design, Energy Saving is a revolutionary technology that delivers unparalleled power saving. The voltage regulator can reduce the number of output phases to improve efficiency when the CPU cores are idle. In other words, it is able to provide exceptional power saving and improve power efficiency without sacrificing computing performance.

XFast RAM



XFast RAM fully utilizes the memory space that cannot be used under Windows® OS 32-bit CPU. It also shortens the loading time of previously visited websites, making web surfing faster than ever. And it also boosts the speed of Adobe Photoshop 5 times faster. Another advantage is that it reduces the frequency of accessing your SSDs or HDDs in order to extend their lifespan.

3.3 ASRock APP Shop

The ASRock APP Shop is an online store for purchasing and downloading software applications for your ASRock computer. You can install various apps and support utilities quickly and easily, and optimize your system and keep your motherboard up to date simply with a few clicks.

Double-click  on your desktop to access ASRock APP Shop utility.

**You need to be connected to the Internet to download apps from the ASRock APP Shop.*

3.3.1 UI Overview

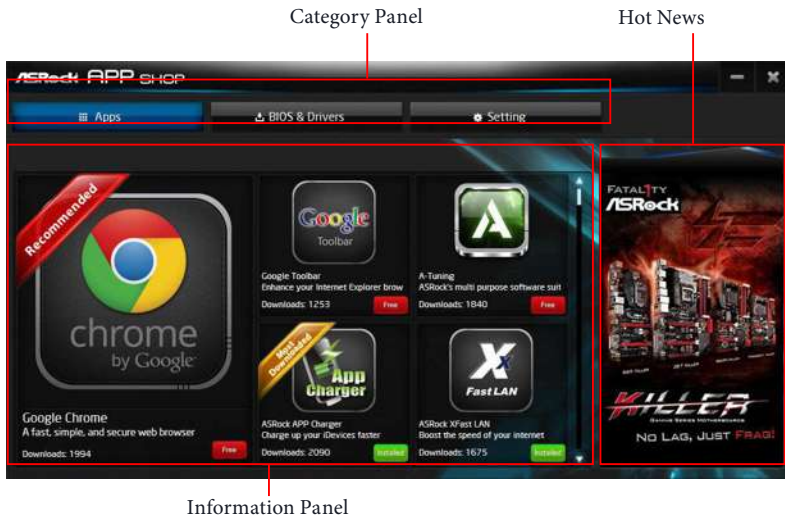

Category Panel: The category panel contains several category tabs or buttons that when selected the information panel below displays the relative information.

Information Panel: The information panel in the center displays data about the currently selected category and allows users to perform job-related tasks.

Hot News: The hot news section displays the various latest news. Click on the image to visit the website of the selected news and know more.

3.3.2 Apps

When the "Apps" tab is selected, you will see all the available apps on screen for you to download.

Installing an App

Step 1

Find the app you want to install.



The most recommended app appears on the left side of the screen. The other various apps are shown on the right. Please scroll up and down to see more apps listed.

You can check the price of the app and whether you have already installed it or not.



- The red icon displays the price or "Free" if the app is free of charge.



- The green "Installed" icon means the app is installed on your computer.

Step 2

Click on the app icon to see more details about the selected app.

Step 3

If you want to install the app, click on the red icon  to start downloading.

**Step 4**

When installation completes, you can find the green "Installed" icon appears on the upper right corner.



To uninstall it, simply click on the trash can icon .

*The trash icon may not appear for certain apps.

Upgrading an App

You can only upgrade the apps you have already installed. When there is an available new version for your app, you will find the mark of "New Version" appears below the installed app icon.



Step 1

Click on the app icon to see more details.

Step 2

Click on the yellow icon  to start upgrading.

3.3.3 BIOS & Drivers

Installing BIOS or Drivers

When the "BIOS & Drivers" tab is selected, you will see a list of recommended or critical updates for the BIOS or drivers. Please update them all soon.

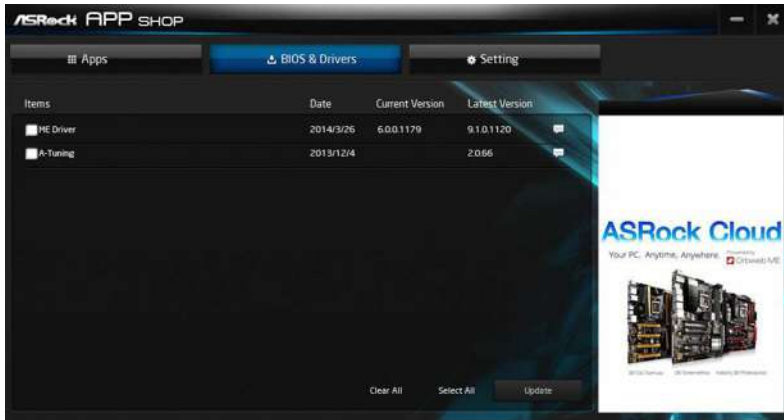

Step 1

Please check the item information before update. Click on  to see more details.

Step 2

Click to select one or more items you want to update.

Step 3

Click Update to start the update process.

3.3.4 Setting

In the "Setting" page, you can change the language, select the server location, and determine if you want to automatically run the ASRock APP Shop on Windows startup.

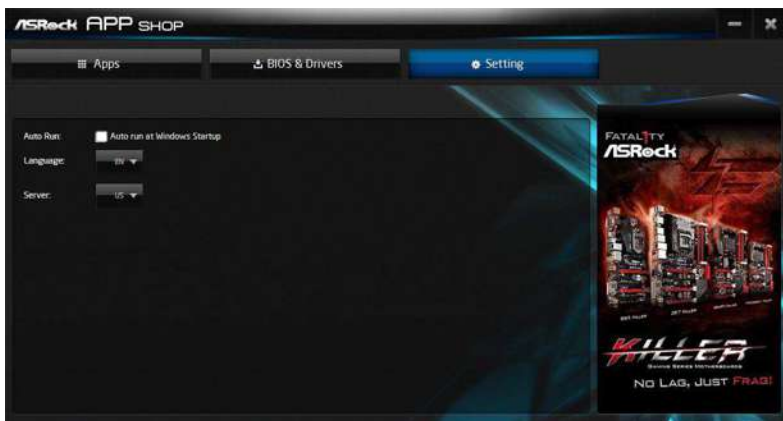

3.4 Start8

For those Windows 8 users who miss the Start Menu, Start8 is an ideal solution that brings back the familiar Start Menu along with added customizations for greater efficiency.

3.4.1 Installing Start8

Install **Start8**, which is located in the folder at the following path of the Support CD:
 \ **ASRock Utility** > **Start8**.

3.4.2 Configuring Start8

Style

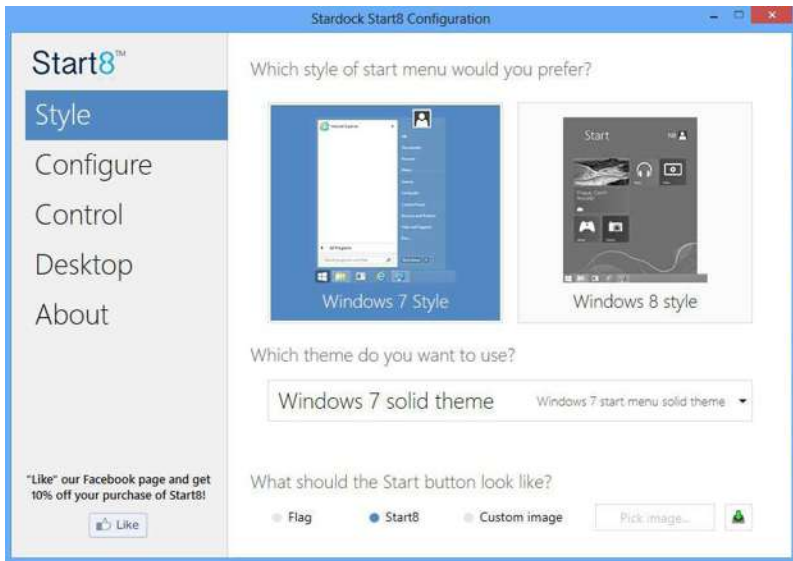

Select between the Windows 7 style and Windows 8 style Start Menu. Then select the theme of the Start Menu and customize the style of the Start icon.

Configure

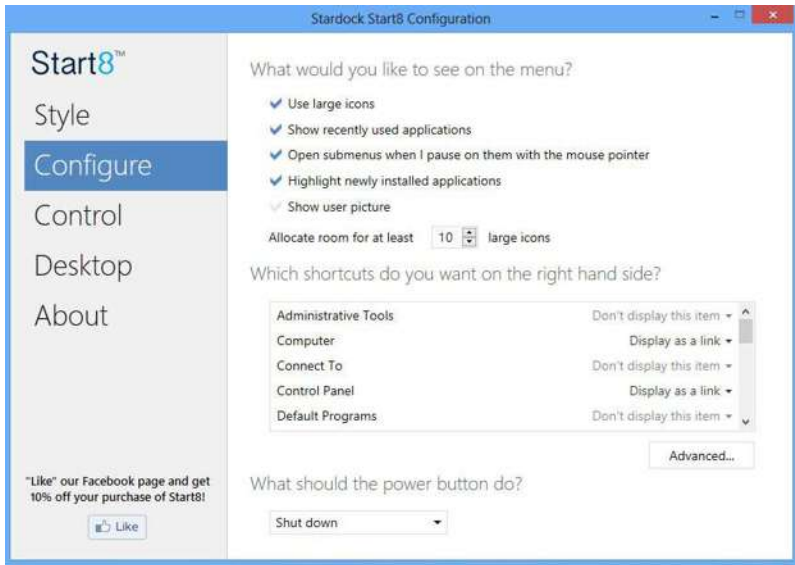

Configure provides configuration options, including icon sizes, which shortcuts you want Start Menu to display, quick access to recently used apps, the functionality of the power button, and more.

Control

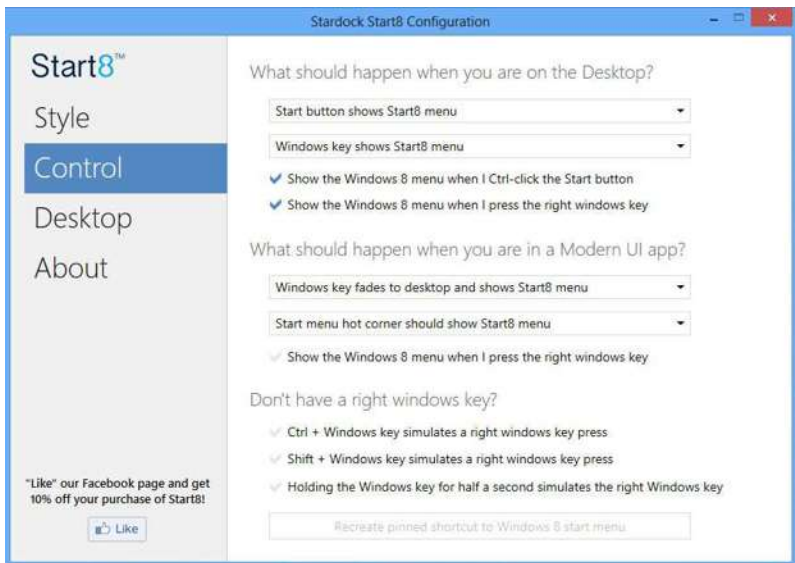

Control lets you configure what a click on the start button or a press on the Windows key does.

Desktop

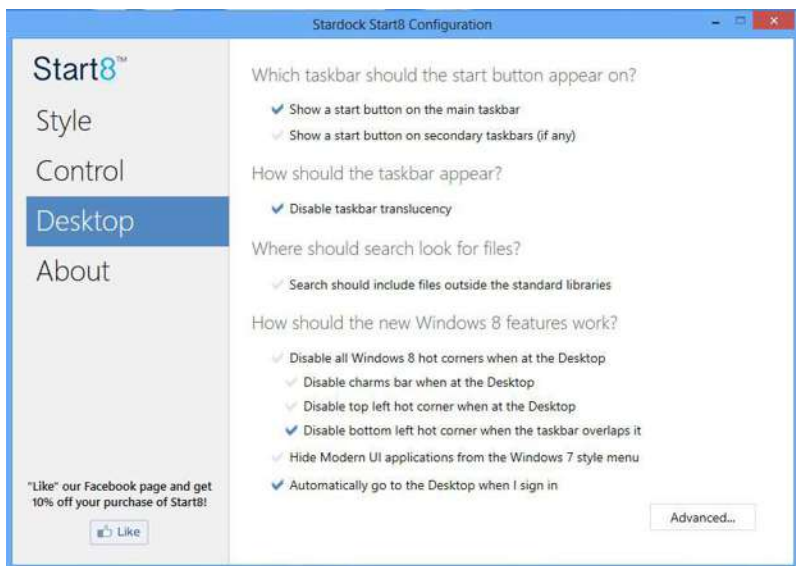

Desktop allows you to disable the hot corners when you are working on the desktop. It also lets you choose whether or not the system boots directly into desktop mode and bypass the Metro user interface.

About

Displays information about Start8.

3.5 XSplit Broadcaster

XSplit Broadcaster is a desktop application designed to make your multimedia broadcasting, live-streaming and recording a lot easier and more fun to do, we are giving away the 3 months premium license which is worth US\$24.95 for free!

3.5.1 Live Streaming Your Gameplay

Step 1

Go to **Start > All Programs > XSplit > XSplit Broadcaster** to launch it.

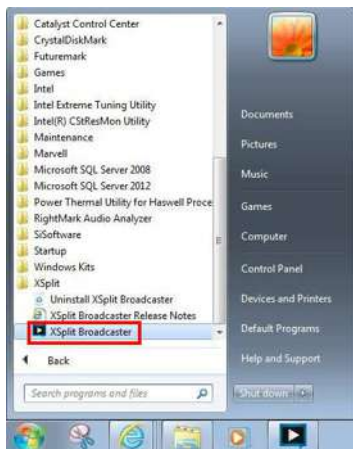

Step 2

Log in with your own username and password. (If you do not have an XSplit account, click **No XSplit account?** to register.)



Step 3

Go to **Broadcast > Add Channels...**

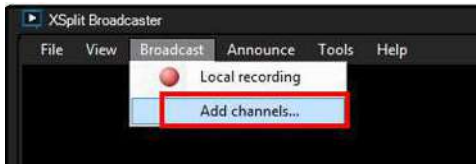
**Step 4**

Click **Add...**

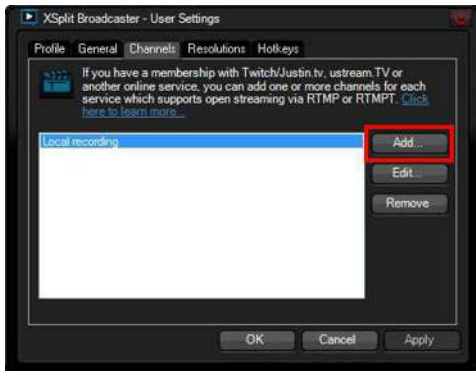
**Step 5**

Select a platform for live streaming.

*Before you start streaming, you need to register an account for the streaming service website, such as Twitch.tv, USTREAM, or other livestreaming services.

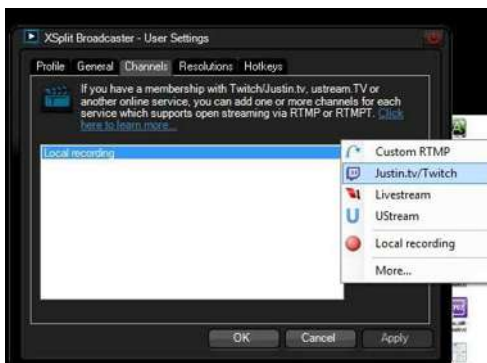

Step 6

Fill in your platform's **Username** and **Password**.

Based on your needs, configure the Video and Audio Encoding settings. Click **OK**.

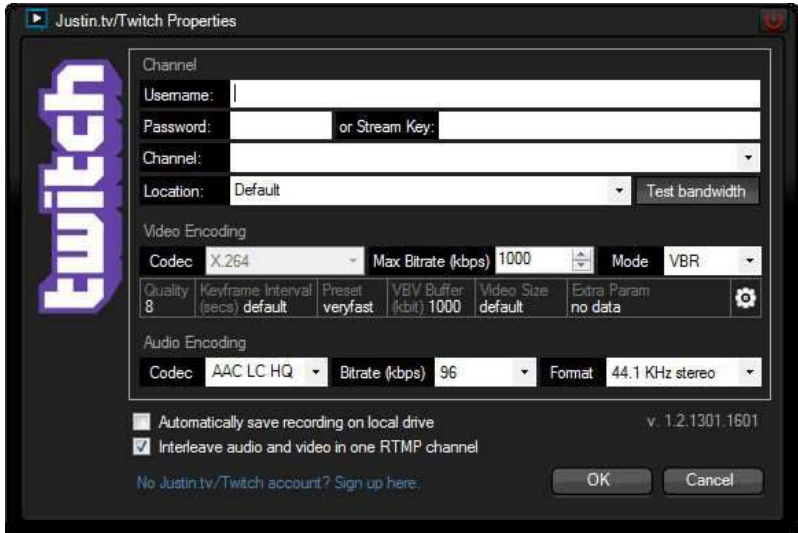

Step 7

The channel then appears in your broadcast list. Click **Apply** and **OK** to save the settings.

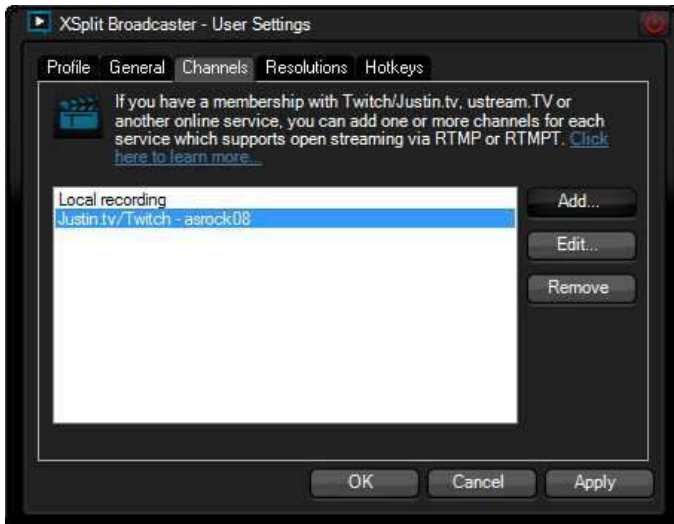

Step 8

Go to **Broadcast** and select the platform to enable live streaming.

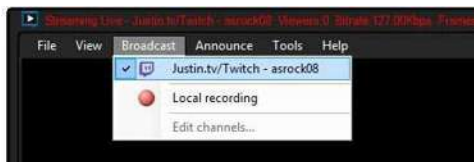

A link to view your live Broadcast has been copied for you automatically. Simply press CTRL-V or right click and choose Paste to paste the link into the browser, and you can see your broadcast.

To disable live streaming, go to **Broadcast** again and deselect the platform.

3.5.2 Recording Your Gameplay

Step 1

Go to **Broadcast > Local recording** to start recording.

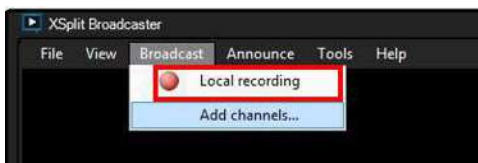
**Step 2**

To stop recording, Go to **Broadcast** again and deselect **Local recording**.

Step 3

Go to **Tools > My Recordings...** to access your recordings

Chapter 4 UEFI SETUP UTILITY

4.1 Introduction

This section explains how to use the UEFI SETUP UTILITY to configure your system. You may run the UEFI SETUP UTILITY by pressing <F2> or right after you power on the computer, otherwise, the Power-On-Self-Test (POST) will continue with its test routines. If you wish to enter the UEFI SETUP UTILITY after POST, restart the system by pressing <Ctl> + <Alt> + <Delete>, or by pressing the reset button on the system chassis. You may also restart by turning the system off and then back on.



Because the UEFI software is constantly being updated, the following UEFI setup screens and descriptions are for reference purpose only, and they may not exactly match what you see on your screen.

4.1.1 UEFI Menu Bar

The top of the screen has a menu bar with the following selections:

Main	For setting system time/date information
OC Tweaker	For overclocking configurations
Advanced	For advanced system configurations
Tool	Useful tools
H/W Monitor	Displays current hardware status
Boot	For configuring boot settings and boot priority
Security	For security settings
Exit	Exit the current screen or the UEFI Setup Utility

4.1.2 Navigation Keys

Use <←> key or <→> key to choose among the selections on the menu bar, and use <↑> key or <↓> key to move the cursor up or down to select items, then press <Enter> to get into the sub screen. You can also use the mouse to click your required item.

Please check the following table for the descriptions of each navigation key.

Navigation Key(s)	Description
+ / -	To change option for the selected items
<Tab>	Switch to next function
<PGUP>	Go to the previous page
<PGDN>	Go to the next page
<HOME>	Go to the top of the screen
<END>	Go to the bottom of the screen
<F1>	To display the General Help Screen
<F7>	Discard changes and exit the SETUP UTILITY
<F9>	Load optimal default values for all the settings
<F10>	Save changes and exit the SETUP UTILITY
<F12>	Print screen
<ESC>	Jump to the Exit Screen or exit the current screen

4.2 Main Screen

When you enter the UEFI SETUP UTILITY, the Main screen will appear and display the system overview.



Active Page on Entry

Select the default page when entering the UEFI setup utility.

4.3 OC Tweaker Screen

In the OC Tweaker screen, you can set up overclocking features.



Because the UEFI software is constantly being updated, the following UEFI setup screens and descriptions are for reference purpose only, and they may not exactly match what you see on your screen.

OC Mode

Use this to select Overclock Mode. Please note that overcloing may cause damage to your components and motherboard. It should be done at your own risk and expense.

Load Optimized CPU OC Setting

Please note that overclocking may cause damage to your CPU and motherboard. It should be done at your own risk and expense.

CPU Configuration

Overclock Mode

Use this to select Overclock Mode. Configuration options: [Auto] and [Manual]. The default value is [Auto].

Spread Spectrum

This item should always be [Auto] for better system stability.

ASRock UCC

ASRock UCC (Unlock CPU Core) feature simplifies AMD CPU activation. As long as a simple switch of the UEFI option “ASRock UCC”, you can unlock the extra CPU core to enjoy an instant performance boost. When UCC feature is enabled, the dual-core or triple-core CPU will boost to the quad-core CPU, and some CPU, including quad-core CPU, can also increase L3 cache size up to 6MB, which means you can enjoy the upgrade CPU performance with a better price. Please be noted that UCC feature is supported with AM3/AM3+ CPU only, and in addition, not every AM3/AM3+ CPU can support this function because some CPU’s hidden core may be malfunctioned.

CPU Active Core Control

This allows you to adjust CPU Active Core Control feature. The configuration options depend on the CPU core you adopt. The default value is [Disabled].

AMD Turbo Core Technology

This item appears only when the processor you adopt supports this feature. Use this to select enable or disable AMD Turbo Core Technology. Configuration options: [Enabled] and [Disabled]. The default value is [Enabled].

AMD Application Power Management

Application Power Management (APM) ensures that average power consumption over a thermally significant time period remains at or below the TDP for the CPU mode being used. If [Enabled] is selected, the power consumption is reduced when overclocking.

Processor Maximum Frequency

It will display Processor Maximum Frequency for reference.

North Bridge Maximum Frequency

It will display North Bridge Maximum Frequency for reference.

Processor Maximum Voltage

It will display Processor Maximum Voltage for reference.

Multiplier/Voltage Change

This item is set to [Auto] by default. If it is set to [Manual], you may adjust the value of Processor Frequency and Processor Voltage. However, it is recommended to keep the default value for system stability.

CPU Frequency Multiplier

For safety and system stability, it is not recommended to adjust the value of this item.

CPU Voltage

It allows you to adjust the value of CPU voltage. However, for safety and system stability, it is not recommended to adjust the value of this item.

NB Frequency Multiplier

For safety and system stability, it is not recommended to adjust the value of this item.

CPU NB Voltage

It allows you to adjust the value of CPU NB voltage. However, for safety and system stability, it is not recommended to adjust the value of this item.

HT Bus Speed

This feature allows you selecting Hyper-Transport bus speed. Configuration options: [200MHz] to [2000MHz].

HT Bus Width

This feature allows you selecting Hyper-Transport bus width. Configuration options: [8 Bit] and [16 Bit].

DRAM Timing Configuration

DRAM Frequency

If [Auto] is selected, the motherboard will detect the memory module(s) inserted and assign the appropriate frequency automatically.

DRAM Timing Control



DRAM Slot

Use this item to view SPD data.

DRAM Timing Control

Use this item to control DRAM timing.

Power Down Enable

Use this item to enable or disable DDR power down mode.

Bank Interleaving

Interleaving allows memory accesses to be spread out over banks on the same node, or across nodes, decreasing access contention.

Channel Interleaving

It allows you to enable Channel Memory Interleaving. Configuration options: [Disabled], [Auto]. The default value is [Auto].

Voltage Configuration

DRAM Voltage

Use this to select DRAM Voltage. The default value is [Auto].

CPU Voltage Offset

Configure the dynamic CPU voltage added to the CPU.

NB Voltage

Use this to select NB Voltage. The default value is [Auto].

HT Voltage

Use this to select HT Voltage. The default value is [Auto].

CPU VDDA Voltage

Use this to select CPU VDDA Voltage. The default value is [Auto].

PCIE VDDA Voltage

Use this to select PCIE VDDA Voltage. The default value is [Auto].

SB Voltage

Use this to select SB Voltage. The default value is [Auto].

4.4 Advanced Screen

In this section, you may set the configurations for the following items: CPU Configuration, North Bridge Configuration, South Bridge Configuration, Storage Configuration, Super IO Configuration, ACPI Configuration, USB Configuration and Trusted Computing.



Setting wrong values in this section may cause the system to malfunction.

4.4.1 CPU Configuration



Cool 'n' Quiet

Use this item to enable or disable AMD's Cool 'n' Quiet™ technology. The default value is [Enabled]. Configuration options: [Enabled] and [Disabled]. If you install Windows® 8.1 / 8 / 7 and want to enable this function, please set this item to [Enabled]. Please note that enabling this function may reduce CPU voltage and memory frequency, and lead to system stability or compatibility issue with some memory modules or power supplies. Please set this item to [Disable] if above issue occurs.

Enhance Halt State (C1E)

All processors support the Halt State (C1). The C1 state is supported through the native processor instructions HLT and MWAIT and requires no hardware support from the chipset. In the C1 power state, the processor maintains the context of the system caches.

Secure Virtual Machine

When this option is set to [Enabled], a VMM (Virtual Machine Architecture) can utilize the additional hardware capabilities provided by AMD-V. The default value is [Enabled]. Configuration options: [Enabled] and [Disabled].

Core C6 Mode

Use this item to enable or disable Core C6 mode. The default value is [Enabled].

CPU Thermal Throttle

Use this item to enable CPU internal thermal control mechanism to keep the CPU from overheated. The default value is [Auto].

4.4.2 North Bridge Configuration



Primary Graphics Adapter

Select a primary VGA.

IOMMU

Use this to enable or disable IOMMU. The default value of this feature is [Disabled].

4.4.3 South Bridge Configuration



Onboard HD Audio

Enable/disable onboard HD audio. Set to Auto to enable onboard HD audio and automatically disable it when a sound card is installed.

Front Panel

Enable/disable front panel HD audio.

Onboard LAN

Enable or disable the onboard network interface controller.

Good Night LED

By enabling Good Night LED, the Power/HDD LEDs will be switched off when the system is on. It will also automatically switch off the Power and Keyboard LEDs when the system enters into Standby/Hibernation mode.

4.4.4 Storage Configuration



SATA Controller(s)

Enable/disable the SATA controllers.

SATA Mode

IDE: For better compatibility.

AHCI: Supports new features that improve performance.

RAID: Combine multiple disk drives into a logical unit.



If you set this item to RAID mode, it is suggested to install SATA ODD driver on SATA3_4 or SATA3_5 port.

AMD AHCI BIOS ROM

Use this item to enable or disable AMD AHCI BIOS ROM. The default value of this option is [Disabled].

SATA IDE Combined Mode

This item is for SATA3_4 and SATA3_5 ports. Use this item to enable or disable SATA IDE combined mode. The default value is [Enabled].



If you want to build RAID on SATA3_4 and SATA3_5 ports, please disable this item.

Aggressive Link Power Management

Aggressive Link Power Management allows SATA devices to enter a low power state during periods of inactivity to save power. It is only supported by AHCI mode.

Hard Disk S.M.A.R.T.

S.M.A.R.T stands for Self-Monitoring, Analysis, and Reporting Technology. It is a monitoring system for computer hard disk drives to detect and report on various indicators of reliability.

4.4.5 Super IO Configuration



Serial Port

Enable or disable the Serial port.

Serial Port Address

Select the address of the Serial port.

4.4.6 ACPI Configuration



Suspend to RAM

Select disable for ACPI suspend type S1. It is recommended to select auto for ACPI S3 power saving.

Check Ready Bit

Enable to enter the operating system after S3 only when the hard disk is ready, this is recommended for better system stability.

ACPI HPET Table

Enable the High Precision Event Timer for better performance and to pass WHQL tests.

Restore on AC/Power Loss

Select the power state after a power failure. If [Power Off] is selected, the power will remain off when the power recovers. If [Power On] is selected, the system will start to boot up when the power recovers.

PS/2 Keyboard Power On

Allow the system to be waked up by a PS/2 Keyboard.

PCIE Devices Power On

Allow the system to be waked up by a PCIE device and enable wake on LAN.

Ring-In Power On

Allow the system to be waked up by onboard COM port modem Ring-In signals.

RTC Alarm Power On

Allow the system to be waked up by the real time clock alarm. Set it to By OS to let it be handled by your operating system.

USB Phy Power On

Allow the system to be waked up by an USB Phy.

USB Keyboard/Remote Power On

Allow the system to be waked up by an USB keyboard or remote controller.

USB Mouse Power On

Allow the system to be waked up by an USB mouse.

4.4.7 USB Configuration



USB Controller

Enable or disable all the USB 2.0 ports.

USB 3.0 Controller

Enable or disable all the USB 3.0 ports.

Legacy USB Support

Enable or disable Legacy OS Support for USB 2.0 devices. If you encounter USB compatibility issues it is recommended to disable legacy USB support. Select UEFI Setup Only to support USB devices under the UEFI setup and Windows/Linux operating systems only.

Legacy USB 3.0 Support

Enable or disable Legacy OS Support for USB 3.0 devices.

4.4.8 Trusted Computing



Security Device Support

Enable to activate Trusted Platform Module (TPM) security for your hard disk drives.

4.5 Tools



System Browser

ASRock System Browser shows the overview of your current PC and the devices connected.

OMG (Online Management Guard)

Administrators are able to establish an internet curfew or restrict internet access at specified times via OMG. You may schedule the starting and ending hours of internet access granted to other users. In order to prevent users from bypassing OMG, guest accounts without permission to modify the system time are required.

UEFI Tech Service

Contact ASRock Tech Service if you are having trouble with your PC. Please setup network configuration before using UEFI Tech Service.

Easy RAID Installer

Easy RAID Installer helps you to copy the RAID driver from the support CD to your USB storage device. After copying the drivers please change the SATA mode to RAID, then you can start installing the operating system in RAID mode.

Easy Driver Installer

For users that don't have an optical disk drive to install the drivers from our support CD, Easy Driver Installer is a handy tool in the UEFI that installs the LAN driver to your system via an USB storage device, then downloads and installs the other

required drivers automatically.

Instant Flash

Save UEFI files in your USB storage device and run Instant Flash to update your UEFI.

Internet Flash

ASRock Internet Flash downloads and updates the latest UEFI firmware version from our servers for you. Please setup network configuration before using Internet Flash.

*For BIOS backup and recovery purpose, it is recommended to plug in your USB pen drive before using this function.

Network Configuration

Use this to configure internet connection settings for Internet Flash.



Internet Setting

Enable or disable sound effects in the setup utility.

UEFI Download Server

Select a server to download the UEFI firmware.

Dehumidifier Function

If Dehumidifier Function is enabled, the computer will power on automatically to dehumidify the system after entering S4/S5 state.

Dehumidifier Period

Configure the period of time until the computer powers on and enables Dehumidifier after entering S4/S5 state.

Dehumidifier Duration

Configure the duration of the dehumidifying process before it returns to S4/S5 state.

Dehumidifier CPU Fan Setting

Configure the speed of the CPU fan while Dehumidifier is enabled. The higher the value, the faster the fan speed.

Max: 255

Min: 1

Save User Default

Type a profile name and press enter to save your settings as user default.

Load User Default

Load previously saved user defaults.

4.6 Hardware Health Event Monitoring Screen

This section allows you to monitor the status of the hardware on your system, including the parameters of the CPU temperature, motherboard temperature, fan speed and voltage.



CPU Fan 1 & 2 Setting

This allows you to set the CPU fan 1 & 2 speed. Configuration options: [Full On] and [Automatic Mode]. The default is value [Full On].

Chassis Fan 1 Setting

This allows you to set the chassis fan 1 speed. Configuration options: [Full On] and [Automatic Mode]. The default is value [Full On].

Chassis Fan 2 Setting

This allows you to set the chassis fan 2 speed. Configuration options: [Full On] and [Manual]. The default is value [Full On].

Chassis Fan 3 Setting

This allows you to set the chassis fan 3 speed. Configuration options: [Full On] and [Manual]. The default is value [Full On].

4.7 Boot Screen

This section displays the available devices on your system for you to configure the boot settings and the boot priority.



Fast Boot

Fast Boot minimizes your computer's boot time. In fast mode you may not boot from an USB storage device. Ultra Fast mode is only supported by Windows 8.1 / 8 and the VBIOS must support UEFI GOP if you are using an external graphics card. Please notice that Ultra Fast mode will boot so fast that the only way to enter this UEFI Setup Utility is to Clear CMOS or run the Restart to UEFI utility in Windows.

Boot From Onboard LAN

Allow the system to be waked up by the onboard LAN.

Setup Prompt Timeout

Configure the number of seconds to wait for the setup hot key.

Bootup Num-Lock

Select whether Num Lock should be turned on or off when the system boots up.

Full Screen Logo

Enable to display the boot logo or disable to show normal POST messages.

AddOn ROM Display

Enable AddOn ROM Display to see the AddOn ROM messages or configure the AddOn ROM if you've enabled Full Screen Logo. Disable for faster boot speed.

Boot Failure Guard

If the computer fails to boot for a number of times the system automatically restores the default settings.

Boot Failure Guard Count

Configure the number of attempts to boot until the system automatically restores the default settings.

CSM (Compatibility Support Module)



CSM

Enable to launch the Compatibility Support Module. Please do not disable unless you're running a WHCK test. If you are using Windows 8.1 / 8 64-bit and all of your devices support UEFI, you may also disable CSM for faster boot speed.

Launch PXE OpROM Policy

Select UEFI only to run those that support UEFI option ROM only. Select Legacy only to run those that support legacy option ROM only. Do not launch?

Launch Storage OpROM Policy

Select UEFI only to run those that support UEFI option ROM only. Select Legacy only to run those that support legacy option ROM only. Do not launch?

Launch Video OpROM Policy

Select UEFI only to run those that support UEFI option ROM only. Select Legacy only to run those that support legacy option ROM only. Do not launch?

4.8 Security Screen

In this section you may set or change the supervisor/user password for the system. You may also clear the user password.



Supervisor Password

Set or change the password for the administrator account. Only the administrator has authority to change the settings in the UEFI Setup Utility. Leave it blank and press enter to remove the password.

User Password

Set or change the password for the user account. Users are unable to change the settings in the UEFI Setup Utility. Leave it blank and press enter to remove the password.

Secure Boot

Enable to support Windows 8.1 / 8 Secure Boot.

4.9 Exit Screen



Save Changes and Exit

When you select this option the following message, “Save configuration changes and exit setup?” will pop out. Select [OK] to save changes and exit the UEFI SETUP UTILITY.

Discard Changes and Exit

When you select this option the following message, “Discard changes and exit setup?” will pop out. Select [OK] to exit the UEFI SETUP UTILITY without saving any changes.

Discard Changes

When you select this option the following message, “Discard changes?” will pop out. Select [OK] to discard all changes.

Load UEFI Defaults

Load UEFI default values for all options. The F9 key can be used for this operation.

Contact Information

If you need to contact ASRock or want to know more about ASRock, you're welcome to visit ASRock's website at <http://www.asrock.com>; or you may contact your dealer for further information. For technical questions, please submit a support request form at <http://www.asrock.com/support/tsd.asp>

ASRock Incorporation

2F., No.37, Sec. 2, Jhongyang S. Rd., Beitou District,

Taipei City 112, Taiwan (R.O.C.)

ASRock EUROPE B.V.

Bijsterhuizen 3151

6604 LV Wijchen

The Netherlands

Phone: +31-24-345-44-33

Fax: +31-24-345-44-38

ASRock America, Inc.

13848 Magnolia Ave, Chino, CA91710

U.S.A.

Phone: +1-909-590-8308

Fax: +1-909-590-1026