

ASUS[®] AP110

Pentium[®] III IDE RAID Server

User's Manual



Disclaimer/Copyrights

No part of this manual, including the products and software described in it, may be reproduced, transmitted, transcribed, stored in a retrieval system, or translated into any language in any form or by any means, except documentation kept by the purchaser for backup purposes, without the express written permission of ASUSTeK COMPUTER INC. ("ASUS").

ASUS PROVIDES THIS MANUAL "AS IS" WITHOUT WARRANTY OF ANY KIND, EITHER EXPRESS OR IMPLIED, INCLUDING BUT NOT LIMITED TO THE IMPLIED WARRANTIES OR CONDITIONS OF MERCHANTABILITY OR FITNESS FOR A PARTICULAR PURPOSE. IN NO EVENT SHALL ASUS, ITS DIRECTORS, OFFICERS, EMPLOYEES OR AGENTS BE LIABLE FOR ANY INDIRECT, SPECIAL, INCIDENTAL, OR CONSEQUENTIAL DAMAGES (INCLUDING DAMAGES FOR LOSS OF PROFITS, LOSS OF BUSINESS, LOSS OF USE OR DATA, INTERRUPTION OF BUSINESS AND THE LIKE), EVEN IF ASUS HAS BEEN ADVISED OF THE POSSIBILITY OF SUCH DAMAGES ARISING FROM ANY DEFECT OR ERROR IN THIS MANUAL OR PRODUCT.

Product warranty or service will not be extended if: (1) the product is repaired, modified or altered, unless such repair, modification or alteration is authorized in writing by ASUS; or (2) the serial number of the product is defaced or missing.

Products and corporate names appearing in this manual may or may not be registered trademarks or copyrights of their respective companies, and are used only for identification or explanation and to the owners' benefit, without intent to infringe.

The product name and revision number are both printed on the product itself. Manual revisions are released for each product design represented by the digit before and after the period of the manual revision number. Manual updates are represented by the third digit in the manual revision number.

For previous or updated manuals, BIOS, drivers, or product release information, contact ASUS at <http://www.asus.com.tw> or through any of the means indicated on the following page.

SPECIFICATIONS AND INFORMATION CONTAINED IN THIS MANUAL ARE FURNISHED FOR INFORMATIONAL USE ONLY, AND ARE SUBJECT TO CHANGE AT ANY TIME WITHOUT NOTICE, AND SHOULD NOT BE CONSTRUED AS A COMMITMENT BY ASUS. ASUS ASSUMES NO RESPONSIBILITY OR LIABILITY FOR ANY ERRORS OR INACCURACIES THAT MAY APPEAR IN THIS MANUAL, INCLUDING THE PRODUCTS AND SOFTWARE DESCRIBED IN IT.

Copyright © 2001 ASUSTeK COMPUTER INC. All Rights Reserved.

Product Name:	AP110
Manual Revision:	1.00 E767
Release Date:	June 2001

Contents

Disclaimer/Copyrights	2
ASUS Contact Information	6
FCC/CDC Statements	7
Safety Precautions	8
Introduction: About This Manual	9
Audience	10
Contents	10
Conventions	11
References	11
System Package Contents	12
Chapter 1: System Overview	13
1.1 System Features	14
1.2 Front Panel Features	15
1.3 Rear Panel Features	16
1.4 Internal Features	17
Chapter 2: Hardware Setup	19
2.1 Remove the Front Cover	20
Unlock the Front Panel	20
Remove the Screws	20
Remove the Panel	20
2.2 Remove the Chassis Cover	21
Remove the Screws	21
Remove the Cover	21
2.3 Motherboard Placement	22
Placement Direction	22
Motherboard Screws	22
2.4 Install a CPU	23
CPU Socket Location	23
CPU Orientation	23
Unlock the CPU Socket	24
Insert the CPU	24
Secure the CPU	25
Connect the Fan Cable	25

Contents

2.5	Install System Memory	26
	DIMM Sockets Location	26
	Install a DIMM	26
2.6	Install a Hard Disk Drive	27
	HDD Metal Cage	27
	Remove the HDD Cage	27
	Install the HDD	28
	Replace the HDD Cage	28
	Connect the Cables	29
	IDE HDD Cabling	29
2.7	Replace the Covers	30
	Re-install the Cover	30
	Re-install the Panel	30
Chapter 3: Powering Up		31
3.1	Getting Started	32
	Connect a Monitor	32
	Connect the Power Cord	32
	Power On	32
	Check Power Status	32
Chapter 4: Hardware Options		33
4.1	IDE RAID Kit	34
	IDE RAID Kit Contents	34
	HDD Tray Frame	35
	Hot-swap HDD Tray	35
4.2	Install a Hot-swap HDD	36
	Install HDD Tray Frame	36
	Remove HDD Tray Cover	37
	Install an IDE Drive	38
4.3	RAID Configuration	39
	Connect IDE Cables	39
	Install a RAID Card	39
4.4	Removing a Hot-swap HDD Tray	40
	Connect Power Cables	40
4.5	CD-ROM Drive	41
	Remove the CD-ROM Drive	41
	Re-install the CD-ROM Drive	42

Contents

Appendix A: Power Supply	43
A.1 General Description	44
A.2 Specifications	45
Input Characteristics	45
Output Characteristics	45
Over-Voltage Protection (OVP)	45
Appendix B: Troubleshooting	47
B.1 Simple Fixes	48

ASUS Contact Information

ASUSTeK COMPUTER INC. (Asia-Pacific)

Marketing

Address: 150 Li-Te Road, Peitou, Taipei, Taiwan 112
Telephone: +886-2-2894-3447
Fax: +886-2-2894-3449
Email: info@asus.com.tw

Technical Support

Tel (English): +886-2-2890-7123
Tel (Chinese): +886-2-2890-7113
Fax: +886-2-2893-7775
Email: tsd@asus.com.tw
Newsgroup: news2.asus.com.tw
WWW: www.asus.com.tw
FTP: ftp.asus.com.tw/pub/ASUS

ASUS COMPUTER INTERNATIONAL (America)

Marketing

Address: 6737 Mowry Avenue, Mowry Business Center, Building 2
Newark, CA 94560, USA
Fax: +1-510-608-4555
Email: info-usa@asus.com.tw

Technical Support

Fax: +1-510-608-4555
BBS: +1-510-739-3774
Email: tsd@asus.com
WWW: www.asus.com
FTP: ftp.asus.com.tw/pub/ASUS

ASUS COMPUTER GmbH (Europe)

Marketing

Address: Harkortstr. 25, 40880 Ratingen, BRD, Germany
Fax: +49-2102-442066
Email: sales@asuscom.de (for marketing requests only)

Technical Support

Hotline: MB/Others: +49-2102-9599-0
Notebook: +49-2102-9599-10
Fax: +49-2102-9599-11
Support (Email): www.asuscom.de/de/support (for online support)
WWW: www.asuscom.de
FTP: ftp.asuscom.de/pub/ASUSCOM

FCC/CDC Statements

Federal Communications Commission Statement

This device complies with FCC Rules Part 15. Operation is subject to the following two conditions:

- This device may not cause harmful interference, and
- This device must accept any interference received including interference that may cause undesired operation.

This equipment has been tested and found to comply with the limits for a Class B digital device, pursuant to Part 15 of the FCC Rules. These limits are designed to provide reasonable protection against harmful interference in a residential installation. This equipment generates, uses and can radiate radio frequency energy and, if not installed and used in accordance with manufacturer's instructions, may cause harmful interference to radio communications. However, there is no guarantee that interference will not occur in a particular installation. If this equipment does cause harmful interference to radio or television reception, which can be determined by turning the equipment off and on, the user is encouraged to try to correct the interference by one or more of the following measures:

- Reorient or relocate the receiving antenna.
- Increase the separation between the equipment and receiver.
- Connect the equipment to an outlet on a circuit different from that to which the receiver is connected.
- Consult the dealer or an experienced radio/TV technician for help.

WARNING! The use of shielded cables for connection of the monitor to the graphics card is required to assure compliance with FCC regulations. Changes or modifications to this unit not expressly approved by the party responsible for compliance could void the user's authority to operate this equipment.

Canadian Department of Communications Statement

This digital apparatus does not exceed the Class B limits for radio noise emissions from digital apparatus set out in the Radio Interference Regulations of the Canadian Department of Communications.

This class B digital apparatus complies with Canadian ICES-003.

Safety Precautions

Electrical Safety



IMPORTANT

- Before installing or removing signal cables, ensure that the power cables for the system unit and all attached devices are unplugged.
- To prevent electrical shock hazard, disconnect the power cable from the electrical outlet before relocating the system.
- When adding or removing any additional devices to or from the system, ensure that the power cables for the devices are unplugged before the signal cables are connected. If possible, disconnect all power cables from the existing system before you add a device.
- If the power supply is broken, do not try to fix it by yourself. Contact an authorized dealer.



CAUTION

This product is equipped with a three-wire power cable and plug for the user's safety. Use the power cable with a properly grounded electrical outlet to avoid electrical shock.

Operation Safety



IMPORTANT

- Any mechanical operation on this server must be conducted by certified or experienced engineers.
- Before operating the server, carefully read all the manuals included with the server package.
- Before using the server, make sure all cables are correctly connected and the power cables are not damaged. If any damage is detected, contact your dealer as soon as possible.
- To avoid short circuits, keep paper clips, screws, and staples away from connectors, slots, sockets and circuitry.
- Avoid dust, humidity, and temperature extremes. Place the server on a stable surface.

Introduction

“About This Manual” introduces the contents of this document. This part includes the target audience, chapter description, and conventions used. It also lists other sources of information that are not contained in this manual.

About This Manual

Audience

This installation guide is intended for system integrators, and experienced users with at least basic knowledge of configuring an entry-level server.

Contents

This manual contains the following parts:

1. Introduction: About This Manual

This part introduces the contents of this document. It includes the target audience, chapter description, and conventions used. It also lists other sources of information that are not contained in this manual.

2. Chapter 1: System Overview

This chapter describes the general features of the AP110 server. It includes sections on front panel and rear panel specifications.

3. Chapter 2: Hardware Setup

This chapter lists the hardware setup procedures that you have to perform when installing system components.

4. Chapter 3: Powering Up

This chapter tells how to get started with the AP110 server after you have installed the basic components.

5. Chapter 4: Hardware Options

This chapter gives information on how to install the optional IDE RAID kit. You will also find the procedure for removing and installing the CD-ROM drive in this chapter.

6. Appendix A: Power Supply Information

This appendix gives information on the 250-watt switching power supply that comes with the AP110 server.

7. Appendix B: Troubleshooting

This appendix lists the common problems that you may encounter while using the AP110 server. It lists the possible causes of the problems and offers solutions. You may refer to this part and try to solve simple problems before calling customer support.

Conventions

Symbols

To make sure that you perform certain tasks properly, take note of the following symbols used throughout this manual.



WARNING: Information to prevent injury to yourself when trying to complete a task.



CAUTION: Information to prevent damage to the components when trying to complete a task.



IMPORTANT: Information that you **MUST** follow to complete a task.



NOTE: Tips and information to aid in completing a task.

References

Refer to the following sources for additional information and for product and software updates.

1. **ASUS CUV-2LSV Series Motherboard User's Manual**

This manual contains detailed information about the CUV-2LV motherboard.

2. **ASUS Websites**

The ASUS websites worldwide provide updated information on ASUS hardware and software products. The ASUS websites are listed in the ASUS Contact Information on page 6.

3. **Optional Documentation**

Your product package may include optional documentation such as a CD-ROM manual, warranty flyers, and others that may have been added by your dealer. **NOTE:** These documents are not part of the standard server package.

System Package Contents

The following checklist enumerates the components included in the standard system package.

- 1) ASUS AS-15 Chassis
- 2) ASUS CUV-2LV Motherboard
- 3) 250W ATX Power Supply
- 4) 50X CD-ROM Drive
- 5) 1.44MB Floppy Disk Drive
- 6) Support CD with Drivers and Utilities
- 7) User's Manuals (for system and motherboard)
- 8) ASUS System Management Agent (ASMA) Support CD

If any of the above items is missing, contact your dealer.

Chapter 1

This chapter describes the general features of the AP110 server. It includes sections on front panel, rear panel, and internal features of the server.

System Overview

1.1 System Features

The ASUS AP110 Server is a stylish tower chassis that accommodates the ASUS CUV-2LV motherboard. The server is powered by Intel® Pentium® III/Celeron™ processor, and supports the latest I/O, audio, and video technologies through the chipsets embedded on the motherboard.

Following are highlights of the server's many features.

- **Processor:** Support for Intel Pentium III/Celeron processor running up to over 1GHz
- **Memory:** Three DIMM sockets that support Intel PC133/PC100-compliant DIMMs, NEC's VC133-compliant Virtual Channel (VC) SDRAM, or Enhanced Memory System's High-speed DRAMs (HSDRAMs) up to 3GB
- **System Chipset:** VIA Apollo Pro133A composed of VT82C694X North Bridge that supports 133/100/66MHz Front Side Bus (FSB), and 133/100/66MHz memory bus, and VT82C686A South Bridge with PCI Super I/O integrated peripheral controller
- **LAN Chipset:** Two Intel 82559 Fast Ethernet LAN controller that fully supports 10BASE-T/100BASE-TX
- **VGA Chipset:** ATI RAGE-XL controller with 4MB video memory
- **Storage:** Four external bays that support two optional 5.25-inch IDE hot-swap drives, one 50X CD-ROM, and 1.44MB floppy drive; internal 3.5-inch drive bays available for two additional IDE drives
- **Expansion:** Four PCI expansion slots
- **Power Supply:** 250-watt ATX power supply with a 115Vac/230Vac voltage selector switch
- **Security:** Equipped with security keylocks for chassis and hot-swap drives

1.2 Front Panel Features

The AP110 front panel is designed with a door on the upper part secured by a keylock. When locked, the door provides security to the hot-swap IDE drives and other internal components because neither the front panel nor the chassis cover cannot be removed.

When the door is open, you can easily access the hot-swap IDE drives (if available), floppy disk drive, and CD-ROM drive.

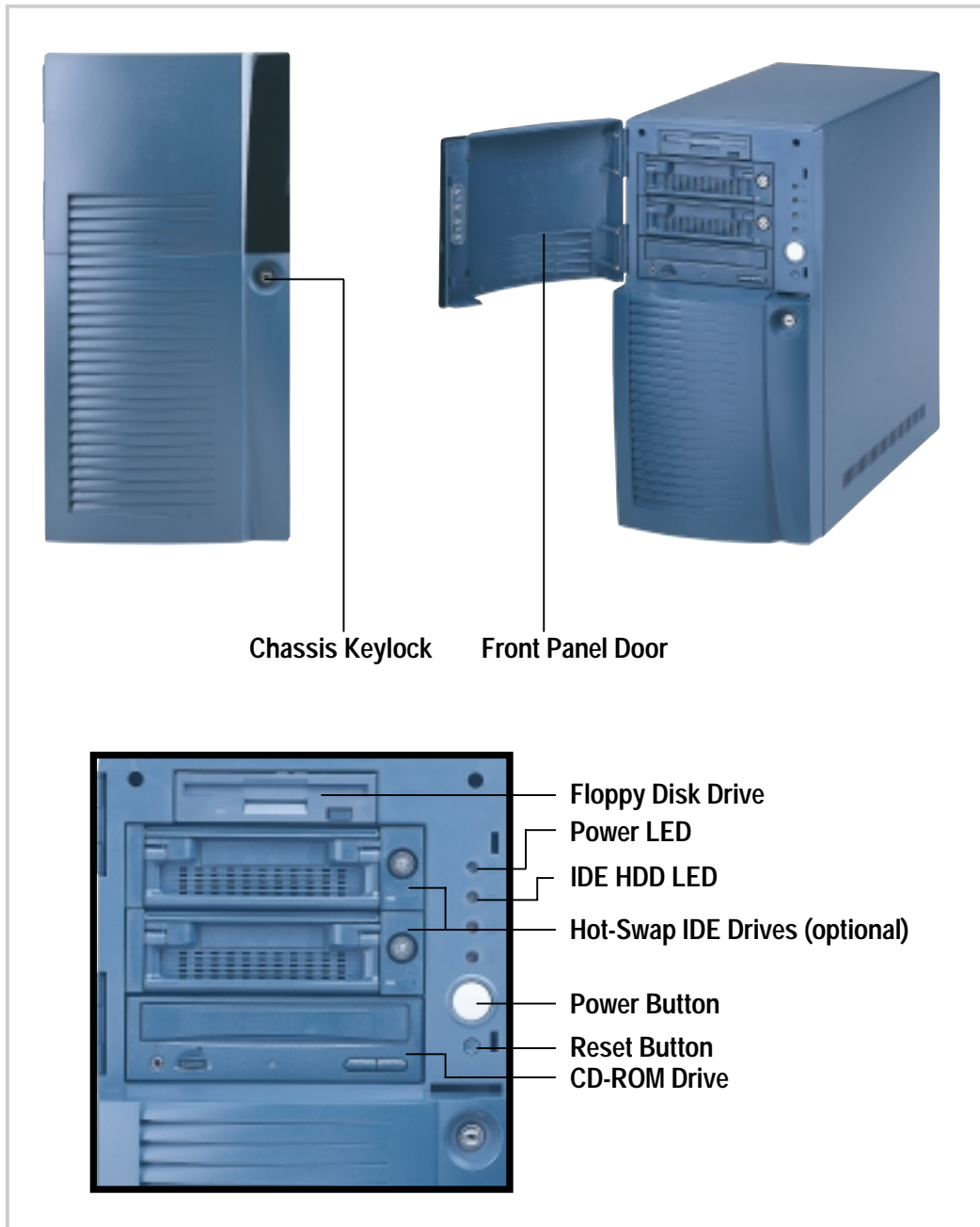

1.3 Rear Panel Features

The AP110 rear panel includes the external I/O ports. The following picture shows the cable connectors and the devices that you connect to the ports.

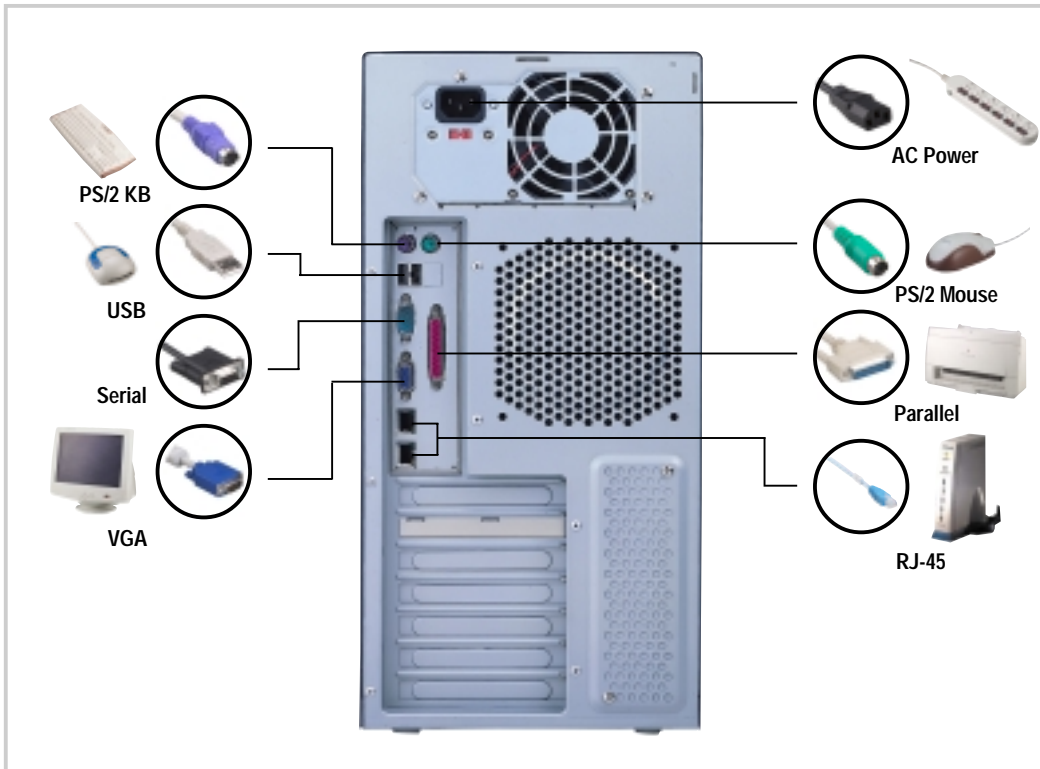

Voltage Selector

The switching power supply that came with the server has a voltage selector switch below the power socket. Use this switch to select the appropriate voltage according to the voltage supply in your area.

If the voltage supply in your area is 100-127V, set the switch to 115V.

If the voltage supply in your area is 200-240V, set the switch to 230V.

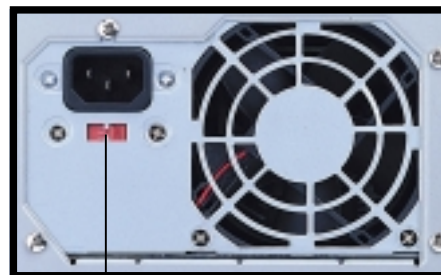

115V/ 230V
Voltage Selector



CAUTION

Setting the switch to 115V in a 230V environment will seriously damage the server.

1.4 Internal Features

The standard components inside the AP110 server include the motherboard, power supply, floppy and CD-ROM drives, and cables.

The picture below shows the standard components and the optional IDE RAID kit that consists of hot-swap drive tray sets, IDE RAID card, and IDE cables.

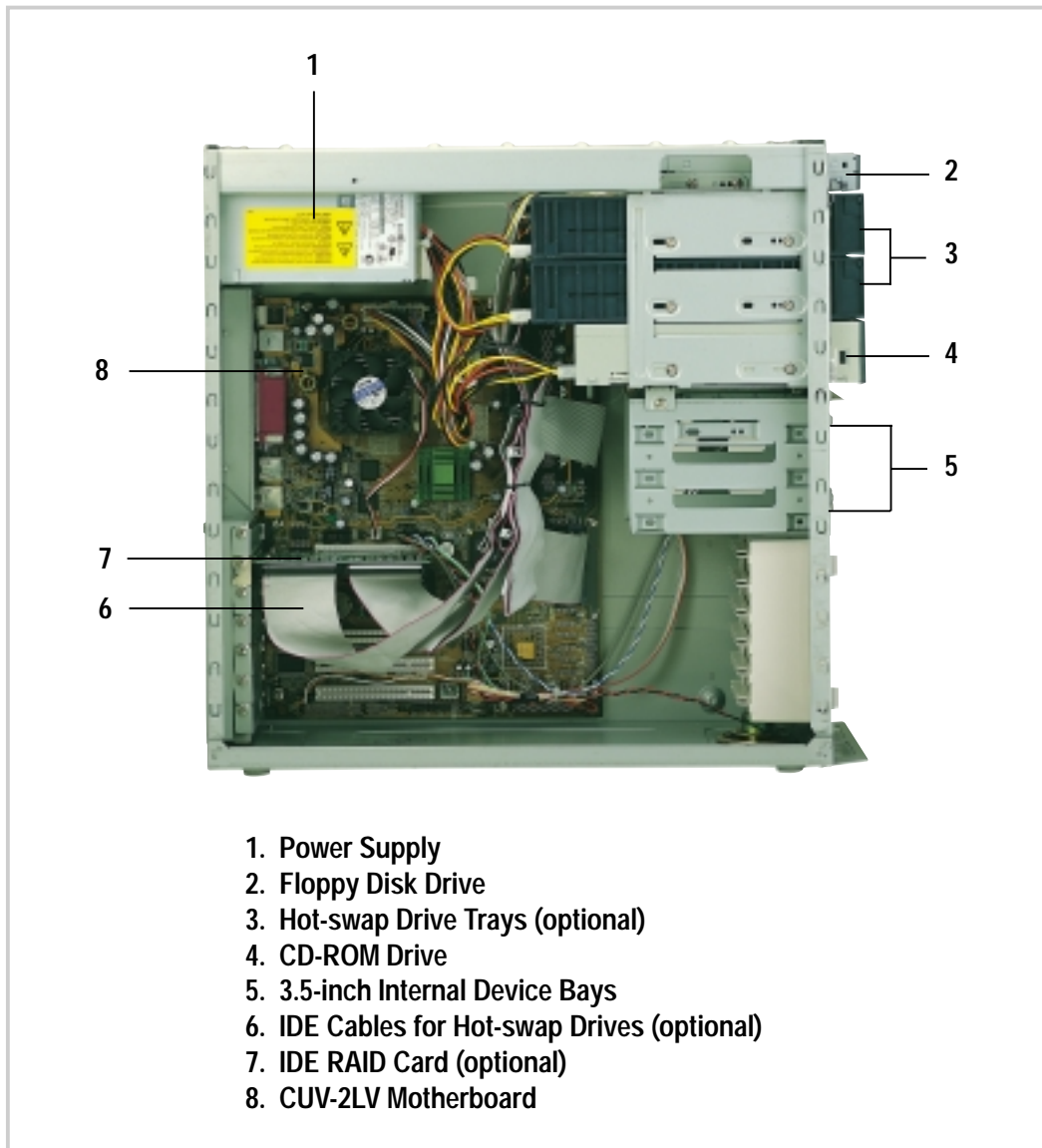

NOTE

The IDE RAID kit is optional and does not come with all models. If your server includes a RAID kit, it comes already pre-installed in the chassis.

Chapter 2

This chapter describes the hardware setup procedures that you have to perform when installing system components.

Hardware Setup

2.1 Remove the Front Cover

Follow these steps to remove the front panel.

Unlock the Front Panel

Insert the system key to the keylock and turn it 90 degrees counter clockwise to unlock the front panel cover.



Chassis Keylock

Remove the Screws

Use a Phillips screwdriver to remove the two screws that secure the front panel to the main chassis.

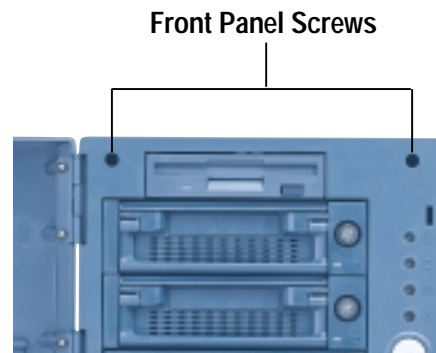

Remove the Panel

1. Close the panel door.
2. Place your hands on the upper part of the panel and pull it firmly.



2.2 Remove the Chassis Cover

Follow these steps to remove the chassis cover.

Remove the Screws

Remove the screws that secure the cover to the main chassis. The locations of the screws are indicated by circles.

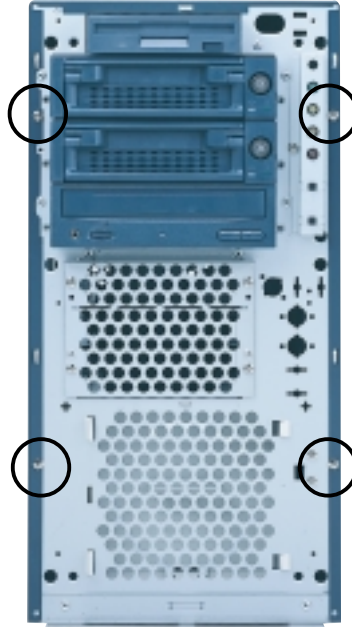

Remove the Cover

Slide the cover for about an inch toward the front and lift it out of the chassis.



2.3 Motherboard Placement



NOTE

The motherboard and other internal components of the AP110 server are already installed as indicated in section “1.4 Internal Features”. Refer to the motherboard user’s manual for detailed technical information about the motherboard.

When removing the motherboard, you need to remove the hot-swap trays and the CD-ROM drive first, because they overlap with the motherboard. Refer to Chapter 4 for the procedure to remove the drives.

Placement Direction

When installing the motherboard, make sure that you place it into the chassis correctly. The edge with the external ports goes to the rear part of the chassis.

Rear Panel

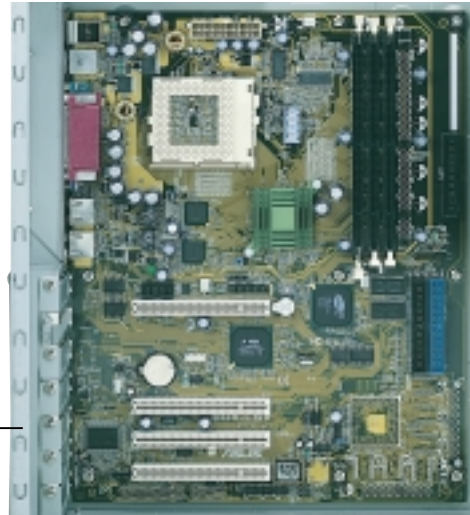

Motherboard Screws

Place nine (9) screws in the holes indicated by circles to secure the motherboard to the chassis. Do not overtighten the screws. Doing so may damage the motherboard.

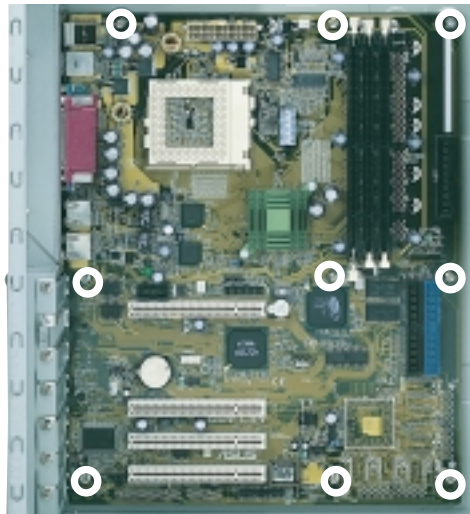

2.4 Install a CPU

The Socket 370 on the CUV-2LV motherboard supports a Pentium III/Celeron CPU. This section tells you how to install a CPU.

The following pictures show the CPU socket location on the motherboard, and the Pin 1 mark on a CPU.

CPU Socket Location

The CPU socket is located beside the rear panel connectors. Note the Pin 1 location on the socket.

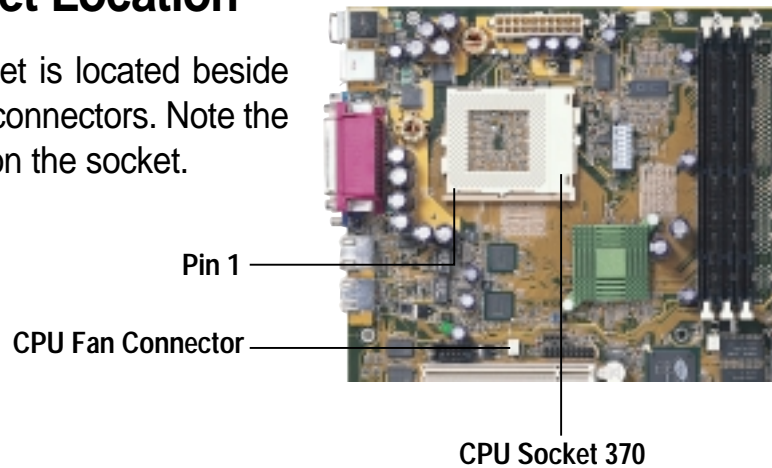

CPU Orientation

A CPU has a mark (usually a notch or a gold mark) on one corner to help you identify the correct orientation when inserting it to the socket.

Match the marked corner of the CPU to Pin 1 on the socket.



Marked Corner



NOTE

In most cases, when you buy a CPU, the fan heatsink is already attached to the CPU.

2.4 Install a CPU

Unlock the CPU Socket

Unlock the socket by pressing the lever sideways then lifting it up to a 90°-100° angle.

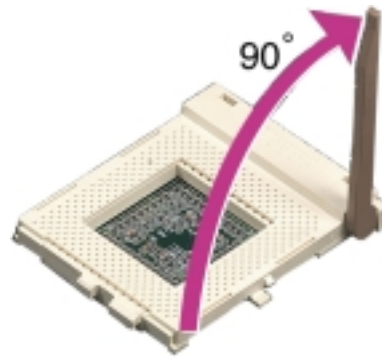

Insert the CPU

1. Position the CPU above the socket such that its notched or marked corner matches the socket corner near the end of the lever.
2. Carefully insert the CPU into the socket until it fits in place.

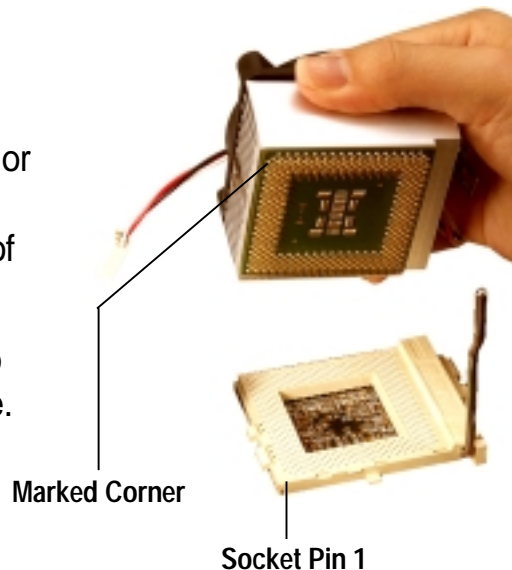

CAUTION

The CPU fits only in one orientation. Do not force the CPU into the socket to prevent bending the pins and damaging the CPU. If the CPU does not fit completely, check its orientation or check for bent pins.

2.4 Install a CPU

Secure the CPU

Push down the lever to secure the CPU to the socket. The lever clicks in place indicating that the socket is locked.



NOTE

The fan heatsink picture above is for reference only. The fan heatsink that you purchased may not look exactly the same as shown. Refer to the documentation that comes with the CPU for more information.

Connect the Fan Cable

Connect the CPU fan cable to the 3-pin CPU_FAN connector on the motherboard.



2.5 Install System Memory

DIMM Sockets Location

The motherboard has three Dual Inline Memory Module (DIMM) sockets that support 3.3V SDRAM modules in 32, 64, 128, 256, 512MB, or 1GB densities.

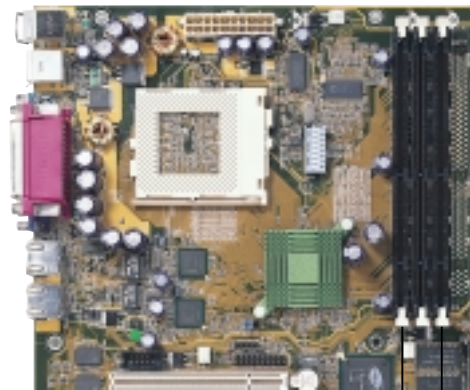

DIMM Sockets

Install a DIMM

1. Unlock a DIMM socket by pressing the retaining clips outward. Align a DIMM on the socket such that the notches on the DIMM match the breaks on the socket.
2. Firmly insert the DIMM into the socket until the retaining clips snap back in place and the DIMM is properly seated.

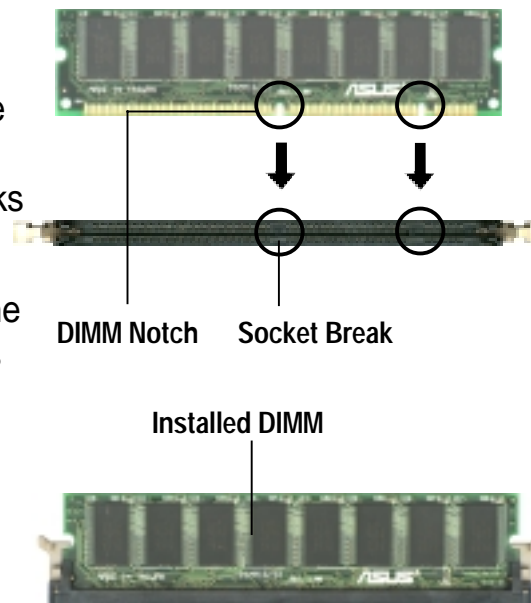

CAUTION

DIMMs are keyed with notches so that they fit in only one direction. DO NOT force a DIMM into a socket to avoid damaging the DIMM.

2.6 Install a Hard Disk Drive

The AP110 server comes with drive bays for internal hard disk drives. You can install up to two internal hard disk drives.

HDD Metal Cage

The HDD metal cage is located right under the CD-ROM drive bay. You have to remove the cage from the chassis to conveniently install a hard disk drive.

HDD Metal Cage



Remove the HDD Cage

1. Remove the screws (indicated by circles) that secure the HDD cage to the front of the chassis.

Cage Screw

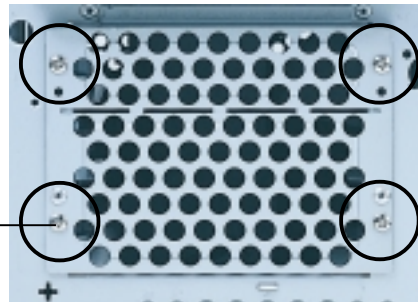

2. Remove the screw on the side of the HDD cage.
3. Pull the HDD cage out of the chassis.

Cage Screw

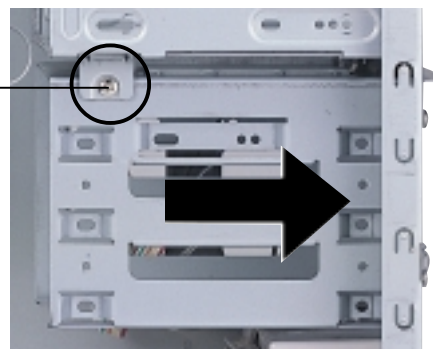

2.6 Install a Hard Disk Drive

Install the HDD

1. Insert the HDD into the cage (label side up) until the holes on the sides align.
2. Secure the HDD with four screws (two on each side).

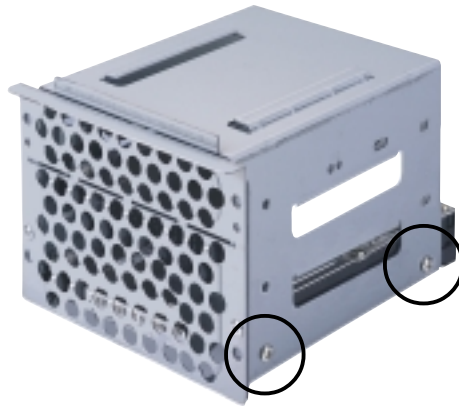

Replace the HDD Cage

1. Carefully insert the HDD cage back into the chassis until it fits in place.
2. Secure the cage with the screws you removed earlier.



2.6 Install a Hard Disk Drive

Connect the Cables

1. Connect one end of the IDE cable to the IDE connector at the back of the drive, matching the red stripe on the cable with Pin 1 on the IDE connector.
2. Connect a power cable (plug marked P3 or P4) to the power connector at the back of the drive.
3. Connect the other end of the IDE cable to the primary IDE connector (blue connector) on the motherboard.



IDE Cable

Red Stripe to Pin 1

Power Cable
(P3 or P4)

Primary IDE Connector



IDE HDD Cabling

The picture on the left shows an installed HDD.



2.7 Replace the Covers



NOTE

If you are installing optional components such as the IDE RAID kit, proceed to Chapter 4 before replacing the covers.

Re-install the Cover

1. Place the cover from the top of the chassis, leaving about an inch from the rear edge.
2. Slide the cover toward the rear panel until it fits in place.



Re-install the Panel

1. Align the bottom edge of the panel to the chassis.
2. Firmly push the panel with both hands until it fits in place.
3. Open the panel door.
4. Secure the panel with the two screws that you removed earlier.
5. Lock the front panel with the system key.



Chapter 3

This chapter tells how to get started with the AP110 server. Powering up the server basically includes connecting the cables and turning power on.

Powering Up

3.1 Getting Started

Make sure that you have completed the basic system installations in Chapter 2, then follow these steps to start up the server.

Connect a Monitor

Connect a monitor by plugging the monitor cable to the video port (blue port) on the server rear panel.

Video Port



Connect the Power Cord

1. Adjust the voltage selector to the correct voltage in your area.
2. Connect a power cord to the power connector on the rear panel.
3. Plug the power cord to a grounded wall socket.

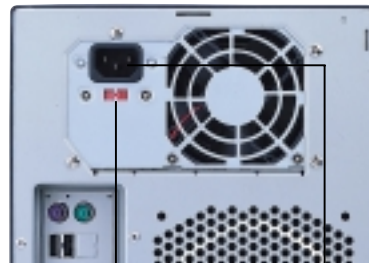

Voltage Selector

Power Connector

Power On

Turn on the server by pressing the power button on the front panel.

Power Button



Check Power Status

After turning on the power, the power LED lights up. If it doesn't, check the power connection.

Power LED

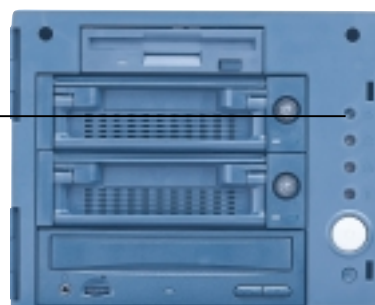

Chapter 4

This chapter tells how to install the optional IDE RAID kit.

Hardware Options

4.1 IDE RAID Kit

The AP110 server supports a maximum of four hard disk drives, two external and two internal. The external HDD bays are available for an IDE RAID configuration using the optional IDE RAID Kit.

This chapter tells about external HDD installation using the IDE RAID kit. Refer to Chapter 3 for instructions on internal HDD installation.



NOTE

The IDE RAID kit is optional and does not come with all models. If your server includes a RAID kit, it comes already pre-installed in the chassis.

IDE RAID Kit Contents

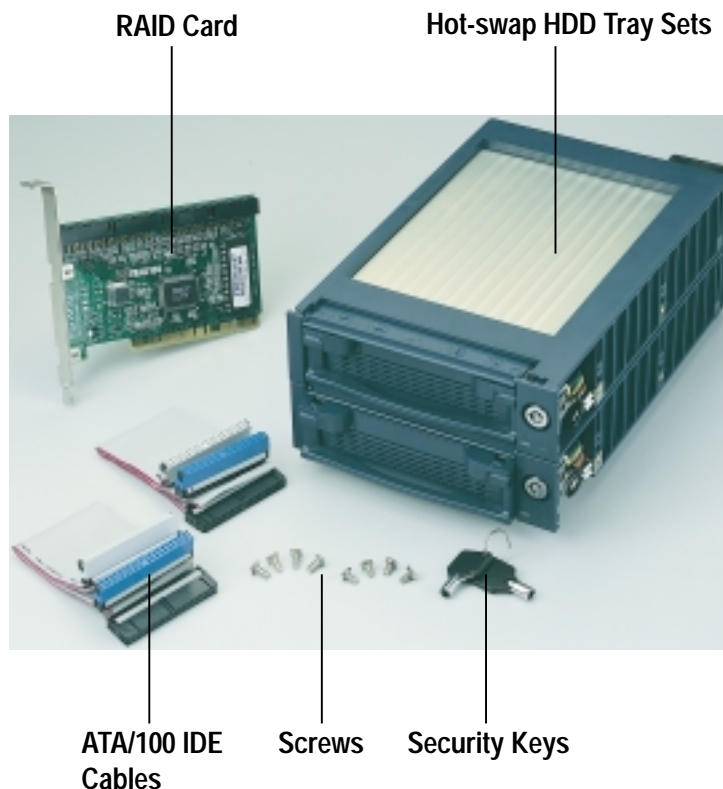

NOTE

The IDE RAID kit also includes a diskette that contains the IDE drivers and a RAID card user's manual.

4.1 IDE RAID Kit

HDD Tray Frame

The HDD tray frame is a separate unit that holds the hot-swap drive tray. A 64-pin male connector is found on the rear of the frame. This connector matches the 64-pin female connector at the back of the hot-swap drive tray.



64-pin Male Connector

The back of the tray frame is an HDD fan, an IDE connector (male), and a power connector.

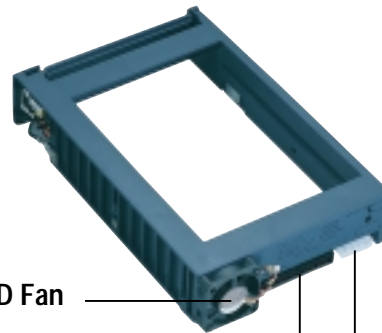

HDD Fan

IDE Connector

Power Connector

Hot-swap HDD Tray

The hot-swap drive tray is an enclosure that holds the HDD. The drive tray interior includes an IDE cable and a power cable.

64-pin Female Connector

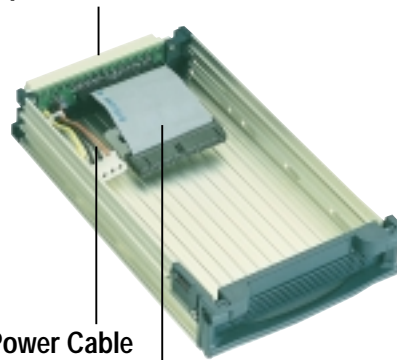

Power Cable

IDE Cable

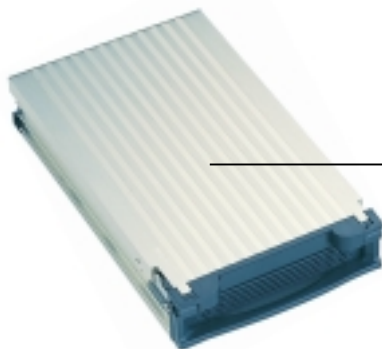

Hot-swap HDD Tray with Cover

4.2 Install a Hot-swap HDD

Install HDD Tray Frame

1. Insert an HDD tray frame into one external drive bay as shown.

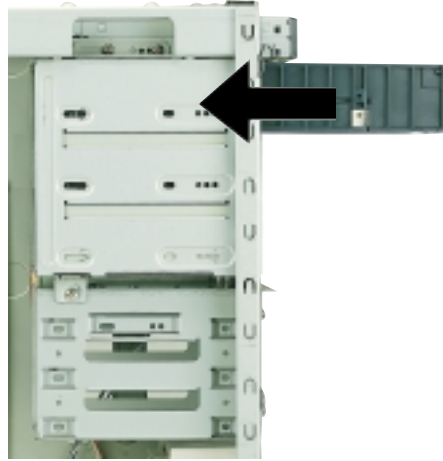

2. Secure the frame with four screws (two on each side).
NOTE: Align the front screws with the holes labeled 1.

3. Follow steps 1 and 2 to install the second HDD tray frame.

The picture on the right shows the two installed HDD tray frames.

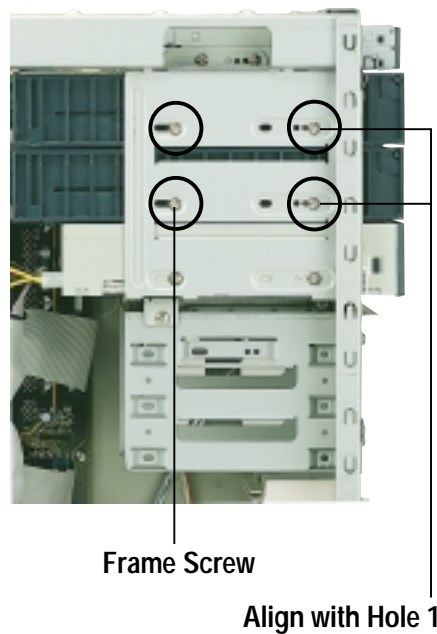

4.2 Install Hot-swap HDD

Remove HDD Tray Cover

The hot-swap drive tray has a cover that you have to remove before you can install a hard disk.

To remove the tray cover:

1. Pull up the lever on the front of the tray. Doing this action slides the tray cover backward about a quarter of an inch.
2. Following the direction of the arrow in the picture, use a finger to flip out the metal latch on the front corner of the cover to disengage it from the tray.
3. Slide the cover all the way back to remove it.

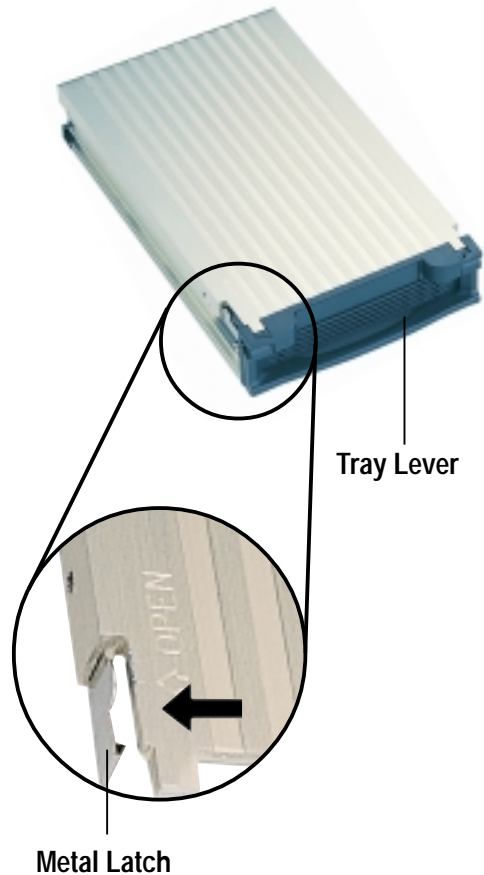

4.2 Install Hot-swap HDD

Install an IDE Drive

1. Connect the IDE cable to the IDE connector at the back of the drive.
2. Connect the power cable to the power connector at the back of the drive.



IDE Cable Power Cable

3. Carefully place the drive into the tray until it fits in place.
4. Secure the drive with four screws (two on each side).



5. Align the tray cover to the rails at the back of the tray, then slide the cover forward until the metal latch clicks in place.
6. Insert the hot-swap drive tray into the bay until it is flushed to the front panel.
7. Lock the hot-swap drive tray with the security key to prevent unauthorized access.
8. Do steps 1 to 7 to install the other hot-swap drive.



Installed Hot-Swap
Drive Trays

4.3 RAID Configuration

This section presents only the physical hardware connections of the RAID card, hot-swap HDDs, and IDE and power cables. For detailed instructions on RAID configuration, refer to the user's manual that came with the IDE RAID kit.

Install a RAID Card

1. Remove the cover opposite the PCI1 expansion slot.
2. Carefully insert the golden fingers of the RAID card into the slot until the card is properly seated.

RAID Card

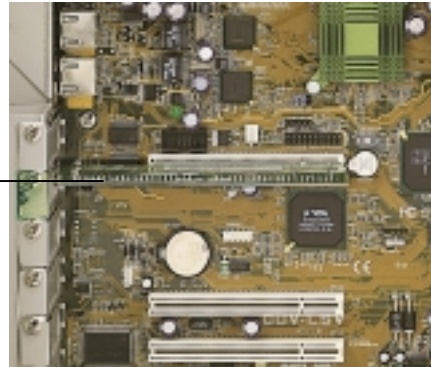

Connect IDE Cables

1. Connect one end of an IDE cable to the IDE1 connector on the RAID card, and the other end to the back of a hot-swap drive frame.
2. Connect one end of the second IDE cable to the IDE2 connector on the RAID card, and the other end to the second hot-swap drive frame.

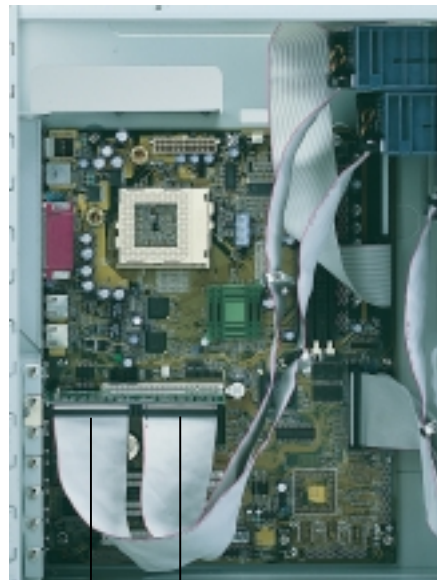

IDE2 Connector

IDE1 Connector



IMPORTANT

Use two separate IDE cables for IDE1 and IDE2 connections.

4.3 RAID Configuration

Connect Power Cables

Connect the power cables, with plugs labeled P5 and P6, to the power connectors at the back of the hot-swap drive frames.

Power Cables



4.4 Removing a Hot-swap HDD Tray

In the future, you might need to remove the drive tray and replace a hot-swap HDD.

To remove a hot-swap drive tray:

1. Unlock the drive tray you desire to remove.
2. Lift up the tray handle.
3. Pull the tray out of the bay.
4. Refer to section 4.2 for instructions on installing a hot-swap HDD.



4.5 CD-ROM Drive

The server comes with the CD-ROM drive already installed. This section tells how to remove and re-install the CD-ROM drive.

You will need to remove the CD-ROM drive for either one of the following reasons:

1. You need to replace the drive
2. You need to remove the motherboard. The CD-ROM drive overlaps with the top right corner of the motherboard, so you can not get it out without moving the drive outward.

Remove the CD-ROM Drive

1. Disconnect the power and IDE cables from the drive.
2. Remove the four screws (two on each side) that secure the drive to the chassis.
3. Carefully pull the drive out of the chassis.

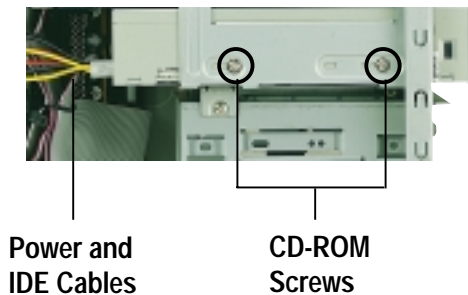

NOTE

If you are doing the above procedure for the purpose of removing the motherboard, you do not have to completely remove the drive from the chassis. Simply pull out the drive for about an inch, or until you can access the motherboard. In this instance, you also have to pull out the hot-swap drive trays because they, too, overlap with the motherboard.

Top Right Corner
of the Motherboard

Hot-swap HDD Trays
and CD-ROM Drive
Pulled Out

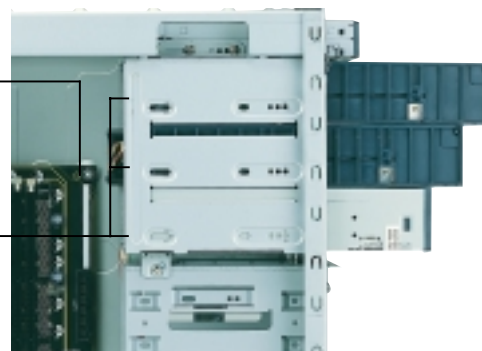

4.5 CD-ROM Drive

Re-install the CD-ROM Drive

1. Align the CD-ROM drive to its bay and carefully push it inward until it is flushed to the front panel.



2. Secure the drive with the screws that you removed earlier (two on each side).

NOTE: Align the front screw with the hole labeled 1.

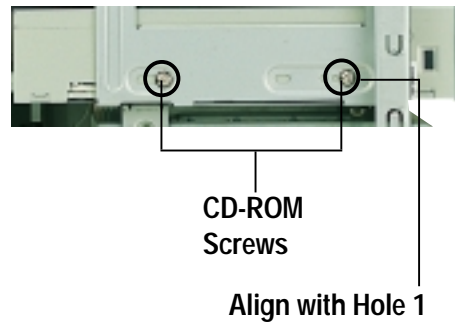

3. Connect the IDE cable to the IDE connector at the back of the drive, matching the red pin stripe on the cable with Pin 1 on the IDE connector.
4. Connect the power cable labeled P2 to the power connector at the back of the drive.

IDE Cable
Red Stripe to Pin 1



Power Cable (P2)

Appendix A

This appendix gives information on the 250-watt switching power supply that comes with the AP110 server.

Power Supply

A.1 General Description

The server comes with a 250W ATX power supply with universal AC input that includes PFC and ATX-compliant output cables and connectors. The power supply has an internal cooling fan.

The power supply has seven plugs labeled P1 to P7. The picture below shows the specific device assignments for the plugs.

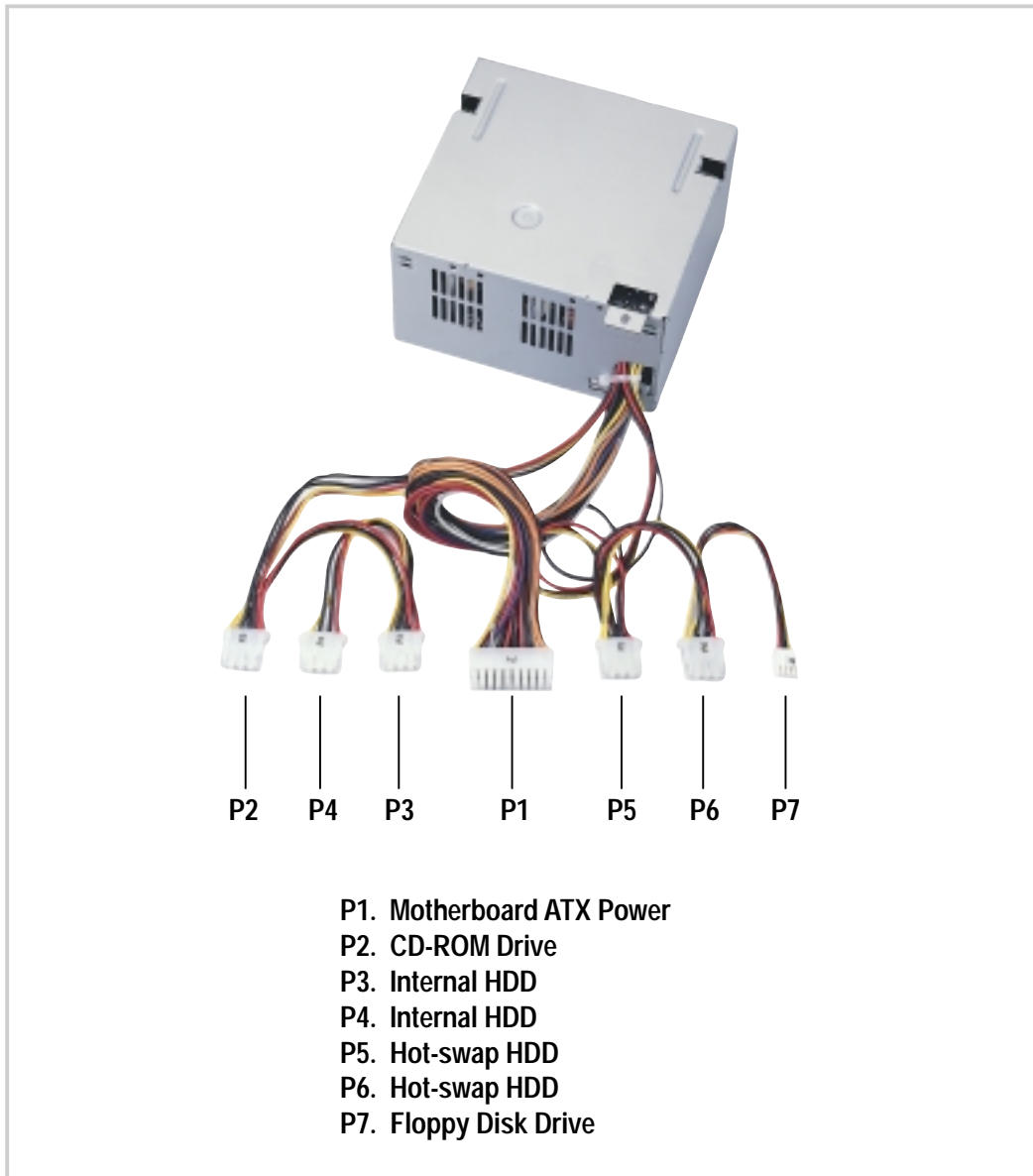

A.2 Specifications

Input Characteristics

Input Voltage Range	Min	Nom	Max
Range 1	90V	115V	135V
Range 2	180V	230V	265V
Input Frequency Range	47 Hz to 63 Hz		
Maximum Input ac Current	9A max at 115Vac 5A max. at 230Vac, maximum load		
Inrush Current	70A max. at 115Vac, full load cold start at 25°C		
Efficiency	68% min. at nominal input, maximum load		

Output Characteristics

Output Voltage	Load Range		Regulation		Ripple
	Min	Max	Min	Max	Max
+5V	1.5A	25.0A	-5%	+5%	50mV _{p-p}
+12V	0.2A	8.0A	-5%	+5%	120mV _{p-p}
-12V	0A	0.8A	-10%	+10%	150mV _{p-p}
-5V	0A	0.5A	-5%	+5%	100mV _{p-p}
+5Vsb	0A	2.0A	-5%	+5%	100mV _{p-p}
+3V3	0A	14.0A	-5%	+5%	50mV _{p-p}

Over-Voltage Protection (OVP)

Output Voltage	Maximum Voltage
+5V	6.5V
+12V	15.6V
+3.3V	4.3V



NOTE

The power supply will shut down and latch off for shorting +5V, +12V, -12V, -5V, or +3.3V. By shorting +5Vsb, the power supply can latch down or automatically recover when the fault condition is removed.

Appendix B

This appendix lists the common problems that you may encounter while using the AP110 server. It lists the possible causes of the problems and offers solutions. You may refer to this part and try to solve simple problems before calling customer support.

Troubleshooting

B.1 Simple Fixes



NOTE

Some problems that you may encounter are not due to defects on the system or the components. These problems only requires simple troubleshooting actions that you can perform by yourself.

Problem	Action
The power LED on the server and/or the monitor do not light up	<ol style="list-style-type: none">1. Make sure that the 115V/230V voltage selector switch is set to the correct voltage supply in your area.2. Check the power cable connection on the system rear panel if properly connected.3. Make sure that the power cables are connected to a grounded power outlet.4. Press the power button to make sure that the system is turned on.
The keyboard does not work	Check the keyboard cable if properly connected to the keyboard port.
The mouse does not work	Check the mouse cable if properly connected to the mouse port.
The system does not perform power-on self tests (POST) after it was turned on	<ol style="list-style-type: none">1. Check the memory modules and make sure you installed the DIMMs the system supports.2. Make sure that the DIMMs are properly installed on the sockets.

Problem	Action
The system continuously beeps after it was turned on	<ol style="list-style-type: none"> 1. Check the memory modules and make sure you installed the DIMMs the system supports. 2. Make sure that the DIMMs are properly installed on the sockets.
The message “Non-system disk or disk error” appears	Check if bootable HDD is active.
RAID HDD is only detected as 1024MB	<ol style="list-style-type: none"> 1. Boot from DOS/Win9x floppy disk. 2. Run FDISK utility to delete all partition 3. Reboot the system and run FDISK /MBR.
RAID HDD shows incorrect size when you execute FDISK	If the RAID set is larger than 64GB, try using SPFDISK utility to solve the problem.
PCI-IDE RAID controller does not detect HDDs	Press F6 and load the PCI-IDE RAID driver when booting from Windows NT/200 OS CD.
Onboard IDE HDD is unstable	Install the VIA utility drivers from the ASUS support CD.
Network connection not available	<ol style="list-style-type: none"> 1. Make sure the network cable is connector the RJ-45 port on the rear panel. 2. Make sure that you have installed the network drivers from the motherboard support CD.

