

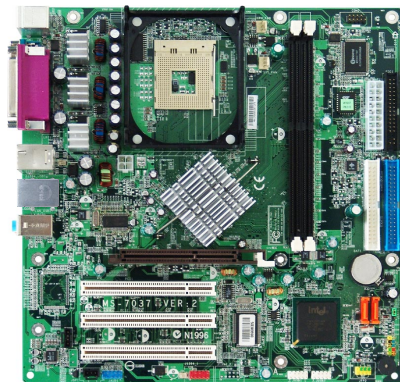

865GM3/865GVM2/865PEM3/848PM
MS-7037 (v1.X) M-ATX Mainboard

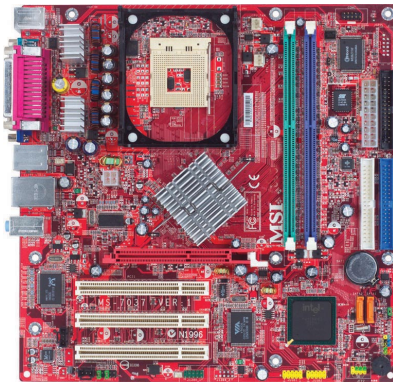

G52-M7037X3

Manual Rev: 1.2

Release Date: July 2004



FCC-B Radio Frequency Interference Statement

This equipment has been tested and found to comply with the limits for a class B digital device, pursuant to part 15 of the FCC rules. These limits are designed to provide reasonable protection against harmful interference when the equipment is operated in a commercial environment. This equipment generates, uses and can radiate radio frequency energy and, if not installed and used in accordance with the instruction manual, may cause harmful interference to radio communications. Operation of this equipment in a residential area is likely to cause harmful interference, in which case the user will be required to correct the interference at his own expense.

Notice 1

The changes or modifications not expressly approved by the party responsible for compliance could void the user's authority to operate the equipment.

Notice 2

Shielded interface cables and A.C. power cord, if any, must be used in order to comply with the emission limits.

VOIR LA NOTICE D'INSTALLATION AVANT DE RACCORDER AU RESEAU.

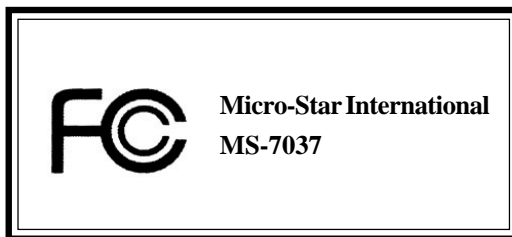

This device complies with Part 15 of the FCC Rules. Operation is subject to the following two conditions:

- (1) this device may not cause harmful interference, and
- (2) this device must accept any interference received, including interference that may cause undesired operation

Copyright Notice

The material in this document is the intellectual property of **MICRO-STAR INTERNATIONAL**. We take every care in the preparation of this document, but no guarantee is given as to the correctness of its contents. Our products are under continual improvement and we reserve the right to make changes without notice.

Trademarks

All trademarks are the properties of their respective owners.

AMD, Athlon™, Athlon™ XP, Thoroughbred™, and Duron™ are registered trademarks of AMD Corporation.

Intel® and Pentium® are registered trademarks of Intel Corporation.

PS/2 and OS®/2 are registered trademarks of International Business Machines Corporation.

Microsoft is a registered trademark of Microsoft Corporation. Windows® 98/2000/NT/XP are registered trademarks of Microsoft Corporation.

NVIDIA, the NVIDIA logo, DualNet, and nForce are registered trademarks or trademarks of NVIDIA Corporation in the United States and/or other countries.

Netware® is a registered trademark of Novell, Inc.

Award® is a registered trademark of Phoenix Technologies Ltd.

AMI® is a registered trademark of American Megatrends Inc.

Kensington and MicroSaver are registered trademarks of the Kensington Technology Group.

PCMCIA and CardBus are registered trademarks of the Personal Computer Memory Card International Association.

Revision History

Revision	Revision History	Date
V1.0	First release of PCB 1.0 with Intel 865G/865GV/865PE/848P & Intel ICH5	March 2004
V1.1	Special version for Trigem	April 2004
V1.2	Revise connector's content	July 2004

Technical Support

If a problem arises with your system and no solution can be obtained from the user's manual, please contact your place of purchase or local distributor. Alternatively, please try the following help resources for further guidance.

➤ Visit the MSI homepage & FAQ site for technical guide, BIOS updates, driver updates, and other information: <http://www.msi.com.tw> & http://www.msi.com.tw/program/service/faq/faq/esc_faq_list.php

➤ Contact our technical staff at: support@msi.com.tw

Safety Instructions

1. Always read the safety instructions carefully.
2. Keep this User's Manual for future reference.
3. Keep this equipment away from humidity.
4. Lay this equipment on a reliable flat surface before setting it up.
5. The openings on the enclosure are for air convection hence protects the equipment from overheating. **Do not cover the openings.**
6. Make sure the voltage of the power source and adjust properly 110/220V before connecting the equipment to the power inlet.
7. Place the power cord such a way that people can not step on it. Do not place anything over the power cord.
8. Always Unplug the Power Cord before inserting any add-on card or module.
9. All cautions and warnings on the equipment should be noted.
10. Never pour any liquid into the opening that could damage or cause electrical shock.
11. If any of the following situations arises, get the equipment checked by a service personnel:
 - The power cord or plug is damaged.
 - Liquid has penetrated into the equipment.
 - The equipment has been exposed to moisture.
 - The equipment has not work well or you can not get it work according to User's Manual.
 - The equipment has dropped and damaged.
 - The equipment has obvious sign of breakage.
12. **Do not leave this equipment in an environment unconditioned, storage temperature above 60°C (140°F), it may damage the equipment.**



CAUTION: Danger of explosion if battery is incorrectly replaced. Replace only with the same or equivalent type recommended by the manufacturer.

CONTENTS

FCC-B Radio Frequency Interference Statement	ii
Copyright Notice	iii
Revision History	iii
Technical Support	iv
Safety Instructions	iv
Chapter 1. Getting Started	1-1
Mainboard Specifications	1-2
Mainboard Layout	1-4
Chapter 2. Hardware Setup	2-1
Quick Components Guide	2-2
Central Processing Unit: CPU	2-3
Example of CPU Core Speed Derivation Procedure	2-3
Memory Speed/CPU FSB Support Matrix	2-3
CPU Installation Procedures for Socket 478	2-4
Installing the CPU Fan	2-5
Memory	2-6
Introduction to DDR SDRAM	2-6
DDR Population Rules	2-7
Installing DDR Modules	2-7
Power Supply	2-8
ATX 20-Pin Power Connector: ATX1	2-8
ATX 12V Power Connector: JPW1	2-8
Back Panel	2-9
Mouse Connector	2-9
Keyboard Connector	2-9
RJ-45 LAN Jack: 10/100 LAN (8100C) / Giga-bit LAN (8110S/SB) (Optional)	2-10
IEEE1394 Port (Optional)	2-11
VGA Connector (Optional, for 865G/GV)	2-11
Audio Port Connectors	2-11
USB Connectors	2-12
Serial Port Connector: COM 1 & COM2 (Optional)	2-12
Parallel Port Connector: LPT1	2-13
Connectors	2-14
Floppy Disk Drive Connector: FDD1	2-14
Fan Power Connectors: CPU_FAN/SYS_FAN	2-14
Hard Disk Connectors: IDE1 & IDE2	2-15
Chassis Intrusion Switch Connector: JCI1	2-15

CD-In Connector: JCD1	2-16
SPDIF-Out Connector: JSP1	2-16
Front USB Connectors: JUSB1 / JUSB2	2-16
Front Panel Connectors: JFP1 & JFP2	2-17
Serial ATA Connectors controlled by ICH5: SATA1, SATA2	2-18
Front Panel Audio Connector: JAUD1	2-19
Joystick/Game Connector: JGP1 (Optional)	2-19
IEEE 1394 Connector: J1394_1/J1394_2 (Optional)	2-20
Jumpers	2-21
Clear CMOS Jumper: JBAT1	2-21
AGP (Accelerated Graphics Port) Slot	2-22
PCI (Peripheral Component Interconnect) Slots	2-22
PCI Interrupt Request Routing	2-22
Chapter 3. BIOS Setup	3-1
Entering Setup	3-2
Control Keys	3-2
Getting Help	3-2
The Main Menu	3-3
Standard CMOS Features	3-5
Advanced BIOS Features	3-7
Advanced Chipset Features	3-11
Integrated Peripherals	3-14
Power Management Setup	3-19
PNP/PCI Configurations	3-22
PC Health Status	3-24
Frequency/Voltage Control	3-26
Load High Performance/BIOS Setup Defaults	3-27
Set Supervisor/User Password	3-28
Appendix A: Using 2-, 4- & 6-Channel Audio Function	A-1
Installing the Audio Driver	A-2
Installation for Windows 98SE/ME/2000/XP	A-2
Software Configuration	A-4
Sound Effect	A-4
Equalizer	A-6
Speaker Configuration	A-7
Speaker Test	A-8
HRTF Demo	A-9
General	A-10
Using 2-, 4- & 6- Channel Audio Function	A-11



Getting Started

Thank you for purchasing the 865GM3 / 865GVM2 / 865PEM3 / 848PM (MS-7037) v1.X Micro ATX mainboard. The 865GM2 / 865GVM / 865PM / 848PM is based on **Intel® 865G / 865GV / 865PE / 848P & Intel® ICH5** chipsets for optimal system efficiency. Designed to fit the advanced **Intel® Pentium 4** processor in the 478-pin package, 865GM3 / 865GVM2 / 865PEM3 / 848PM delivers a high performance and professional desktop platform solution.

Mainboard Specifications

CPU

- Supports Socket 478 for Intel® Pentium 4 (Socket 478) processor
- Supports 533MHz or 800MHz FSB
- Supports 3.4GHz or higher speed P4 processor (Require multi-directional CPU heatsink)

(For the latest information about CPU, please visit http://www.msi.com.tw/program/products/mainboard/mbd/pro_mbd_cpu_support.php)

Chipsets

- Intel® 865G/865GV/865PE/848P chipset
 - Supports AGP 8x/4x (for 865G/865PE)
 - Integrated graphic controller (865G/865GV only)
 - Supports DDR266/333/400 SDRAM.
 - Supports 400/533/800MHz Intel NetBurst micro-architecture bus.
- Intel® ICH5 chipset (421 mBGA)
 - AC'97 2.3 interface
 - 8 USB 2.0/1.1 ports
 - 2 channel Ultra ATA/100 Bus Master IDE controller
 - SMBus 2.0 support
 - 2 serial ATA Host Controllers

Main Memory

- Supports two 64-bit wide DDR data channels (848P supports a 64-bit wide DDR data channel)
- Supports dual-channel function (865G/865PE/865GV only)
- Supports 128Mb, 256Mb or 512Mb DDR technologies
- Supports 2 DDR 333/400 memory modules

(For the updated supporting memory modules, please visit http://www.msi.com.tw/program/products/mainboard/mbd/pro_mbd_trp_list.php to refer the memory module part in the test report.)

Slots

- One AGP supports 8x/4x (865G/865PE/865GV only)
- Three PCI 2.2 32-bit Master PCI Bus slots.

On-Board ATA

- An IDE controller on the ICH5 chipset provides IDE HDD/CD-ROM with PIO, Bus Master and Ultra DMA66/100 operation modes.
- Can connect up to four IDE devices.
- Supports Serial ATA Host Controllers*2.

On-Board Peripherals

- On-Board Peripherals include:
 - 1 floppy port supports 1 FDD with 360K, 720K, 1.2M, 1.44M and 2.88 Mbytes.
 - 1 serial port (COM1), 1 VGA port (Optional, for 865G / 865GV only)

- 1 parallel port supports SPP/EPP/ECP mode
- 8 USB 2.0/1.1 ports (Rear * 4 / Front * 4)
- 1 Line-In/Line-Out/Mic
- 1 RJ45 connector (Optional)
- 2 1394 ports (Rear*1 / Front*1) (Optional)
- 3 1394 ports (Rear*1 / Front*2) (Optional)
- 1 serial port pin header (COM2) (Optional)

Audio

- AC97 link controller integrated in ICH5
- 6 channels software audio codec Realtek ALC655
 - Compliant with AC97 v2.2 spec.
 - Meet PC2001 audio performance requirement

On-Board LAN (Optional)

- Realtek 8110S / 8100SB / Realtek 8100 C
 - Integrated Fast Ethernet MAC and PHY in one chip
 - Supports 10/100Mb/s (for 8100C) and 10/100/1000Mb/s (for 8110S / 8100SB) auto-negotiation operation
 - Compliant with PCI v2.2, and LAN on Motherboard (LOM) standard

On-Board 1394 (Optional)

- VIA VT6307/6306

BIOS

- The mainboard BIOS provides “Plug & Play” BIOS which detects the peripheral devices and expansion cards of the board automatically.
- The mainboard provides a Desktop Management Interface (DMI) function which records your mainboard specifications.

Dimension

- M-ATX Form Factor: 24.5 cm (L) x 24.5 cm (W)

Mounting

- 8 mounting holes

Mainboard Layout

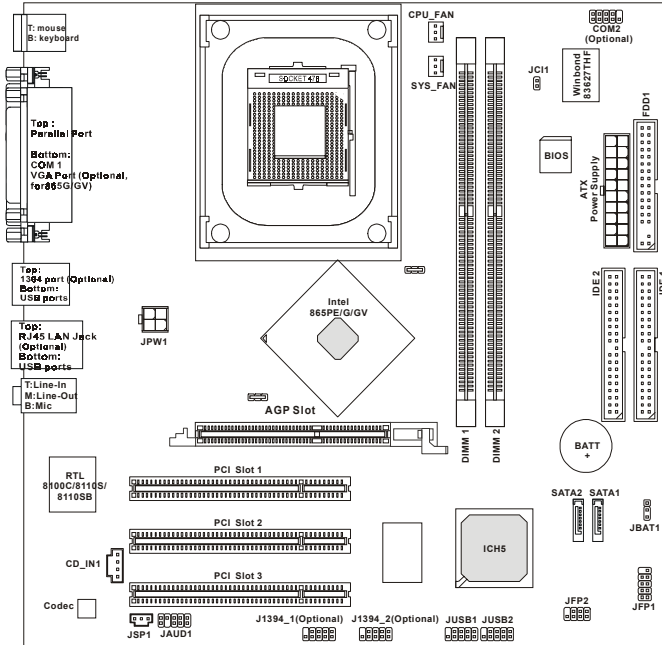

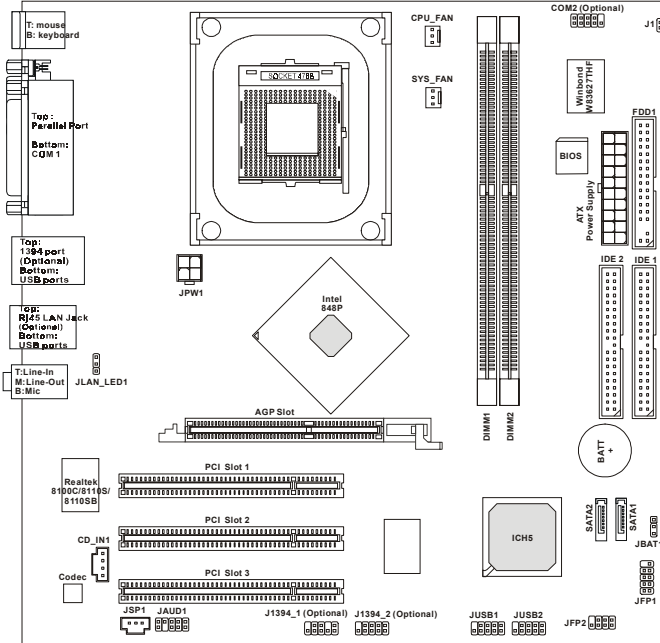

**MS-7037 v2.X M-ATX Mainboard
(MS-7037 v2.X is for Intel 848P chipset)**

2

Hardware Setup

This chapter tells you how to install the CPU, memory modules, and expansion cards, as well as how to setup the jumpers on the mainboard. Also, it provides the instructions on connecting the peripheral devices, such as the mouse, keyboard, etc.

While doing the installation, be careful in holding the components and follow the installation procedures.

Quick Components Guide

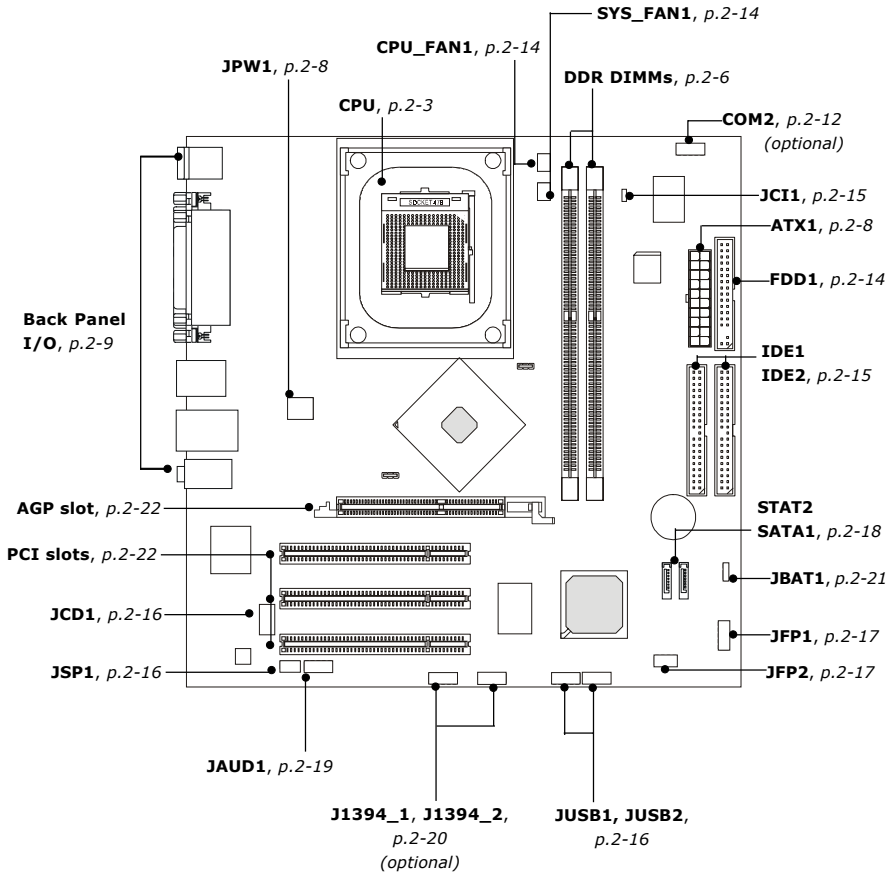

Central Processing Unit: CPU

The mainboard supports Intel® Pentium® 4/Celeron Northwood/Prescott processor in the 478 pin package. The mainboard uses a CPU socket called PGA478 for easy CPU installation. When you are installing the CPU, **make sure the CPU has a heat sink and a cooling fan attached on the top to prevent overheating.** If you do not find the heat sink and cooling fan, contact your dealer to purchase and install them before turning on the computer.

For the latest information about CPU, please visit http://www.msi.com.tw/program/products/mainboard/mbd/pro_mbd_cpu_support.php

Example of CPU Core Speed Derivation Procedure

If CPU Clock = 133MHz
 Core/Bus ratio = 23
then CPU core speed = Host Clock x Core/Bus ratio
 = 133MHz x 23
 = 3.06 GHz

Memory Speed/CPU FSB Support Matrix

Memory FSB	DDR 266	DDR 333	DDR 400
400 MHz	OK	N/A	N/A
533 MHz	OK	OK	N/A
800 MHz	N/A	N/A	OK



MSI Reminds You...

Overheating

Overheating will seriously damage the CPU and system, always make sure the cooling fan can work properly to protect the CPU from overheating.

Replacing the CPU

While replacing the CPU, always turn off the ATX power supply or unplug the power supply's power cord from grounded outlet first to ensure the safety of CPU.

CPU Installation Procedures for Socket 478

1. Please turn off the power and unplug the power cord before installing the CPU.
2. Pull the lever sideways away from the socket. Make sure to raise the lever up to a 90-degree angle.
3. Look for the cut edge. The cut edge should point towards the lever pivot. The CPU can only fit in the correct orientation.
4. If the CPU is correctly installed, the pins should be completely embedded into the socket and can not be seen. Please note that any violation of the correct installation procedures may cause permanent damages to your mainboard.
5. Press the CPU down firmly into the socket and close the lever. As the CPU is likely to move while the lever is being closed, always close the lever with your fingers pressing tightly on top of the CPU to make sure the CPU is properly and completely embedded into the socket.

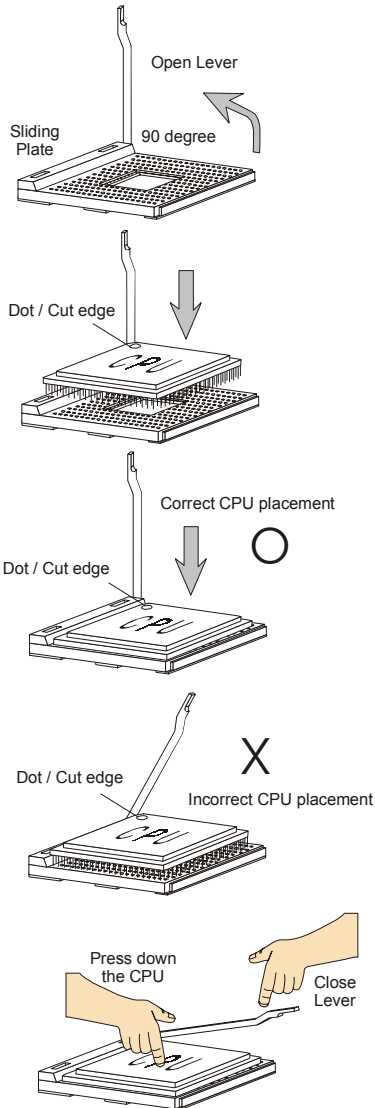

Installing the CPU Fan

As processor technology pushes to faster speeds and higher performance, thermal management becomes increasingly important. To dissipate heat, you need to attach the CPU cooling fan and heatsink on top of the CPU. Follow the instructions below to install the Heatsink/Fan:

1. Locate the CPU and its retention mechanism on the motherboard.
2. Position the heatsink onto the retention mechanism.

retention mechanism

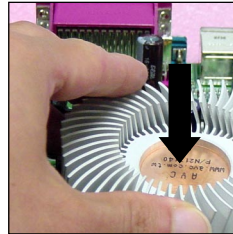
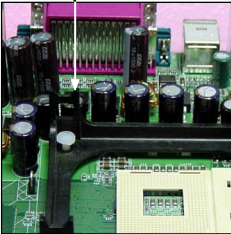

3. Mount the fan on top of the heatsink. Press down the fan until its four clips get wedged in the holes of the retention mechanism.
4. Press the two levers down to fasten the fan. Each lever can be pressed down in only ONE direction.

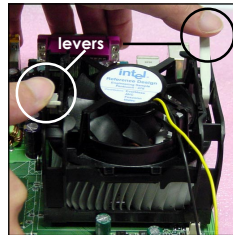
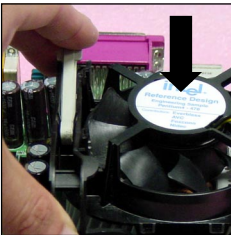

5. Connect the fan power cable from the mounted fan to the 3-pin fan power connector on the board.

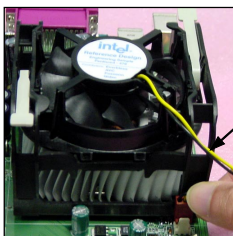

fan power cable



MSI Reminds You...

If your Intel Pentium 4 processor supports 3.0GHz (and up), please be sure to use a multi-direction fan to make the heatsink exhausts air towards the voltage regulators on the board easier. Multi-direction fan has better performance in CPU overheating.

Memory

The mainboard provides 2 slots for 184-pin DDR SDRAM DIMM (Double In-Line Memory Module) modules and supports the memory size up to 1GB. You can install DDR400/DDR333/DDR266 modules on the DDR DIMM slots (DDR 1~2).

For the updated supporting memory modules, please visit http://www.msi.com.tw/program/products/mainboard/mbd/pro_mbd_trp_list.php.



DIMM1 DIMM2

Introduction to DDR SDRAM

DDR (Double Data Rate) SDRAM is similar to conventional SDRAM, but doubles the rate by transferring data twice per cycle. It uses 2.5 volts as opposed to 3.3 volts used in SDR SDRAM, and requires 184-pin DIMM modules rather than 168-pin DIMM modules used by SDR SDRAM. High memory bandwidth makes DDR an ideal solution for high performance PC, workstations and servers.

DDR Population Rules

Install at least one DIMM module on the slots. Each DIMM slot supports up to a maximum size of 1GB. Users can install either single- or double-sided modules to meet their own needs. Also, since this mainboard supports dual-channel function, please note that **DIMM1 (Channel A, in green) working together with DIMM2 (Channel B, in purple) will function as dual-channel**. In order to have better performance, it is recommended to install memory modules of **the same type and density** on DDR DIMMs.

Please refer to the following table for detailed DDR population:

DIMM1 (Ch A)	DIMM2 (Ch A)	System Density
128MB~1GB		128MB~1GB
	128MB~1GB	128MB~1GB
128MB~1GB *	128MB~1GB *	256MB~2GB

Installing DDR Modules

1. The DDR DIMM has only one notch on the center of module. The module will only fit in the right orientation.
2. Insert the DIMM memory module vertically into the DIMM slot. Then push it in until the golden finger on the memory module is deeply inserted in the socket.
3. The plastic clip at each side of the DIMM slot will automatically close.

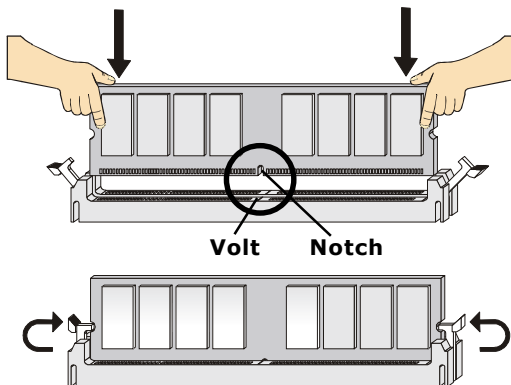

MSI Reminds You...

You can barely see the golden finger if the module is properly inserted in the socket.

Power Supply

The mainboard supports ATX power supply for the power system. Before inserting the power supply connector, always make sure that all components are installed properly to ensure that no damage will be caused.

ATX 20-Pin Power Connector: ATX1

This connector allows you to connect to an ATX power supply. To connect to the ATX power supply, make sure the plug of the power supply is inserted in the proper orientation and the pins are aligned. Then push down the power supply firmly into the connector.

ATX 12V Power Connector: JPW1

This 12V power connector is used to provide power to the CPU.

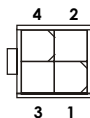

JPW1

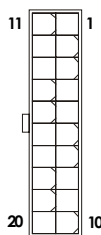

ATX1

ATX1 Pin Definition

PIN	SIGNAL	PIN	SIGNAL
1	3.3V	11	3.3V
2	3.3V	12	-12V
3	GND	13	GND
4	5V	14	PS_ON
5	GND	15	GND
6	5V	16	GND
7	GND	17	GND
8	PW_OK	18	-5V
9	5V_SB	19	5V
10	12V	20	5V

JPW1 Pin Definition

PIN	SIGNAL
1	GND
2	GND
3	12V
4	12V



MSI Reminds You...

Power supply of 300 (and up) watt is highly recommended for system stability.

Back Panel

The back panel provides the following connectors:

(1) MS-7037 v1.X Rear I/O

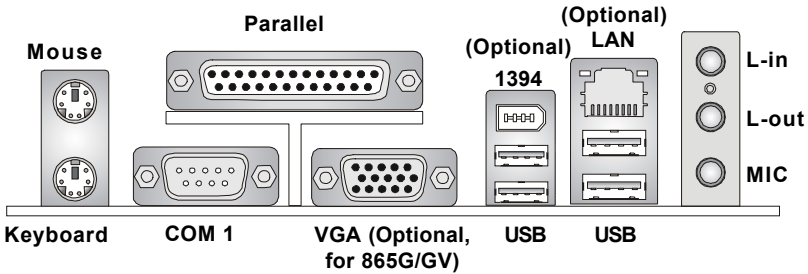

(2) MS-7037 v2.X Rear I/O

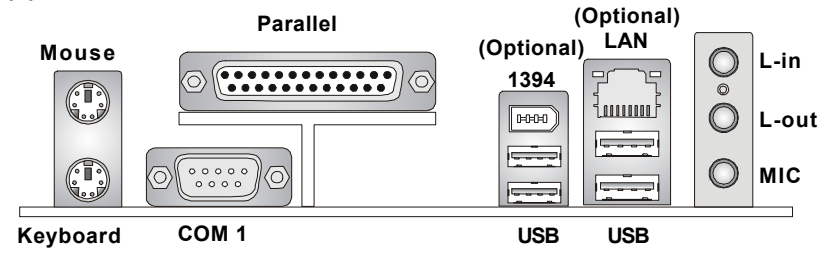

Mouse Connector

The mainboard provides a standard PS/2[®] mouse mini DIN connector for attaching a PS/2[®] mouse. You can plug a PS/2[®] mouse directly into this connector.

Keyboard Connector

The mainboard provides a standard PS/2[®] keyboard mini DIN connector for attaching a PS/2[®] keyboard. You can plug a PS/2[®] keyboard directly into this connector.

Pin Definition

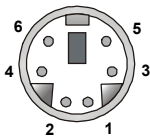

PS/2 Mouse (6-pin Female)
PS/2 Keyboard (6-pin Female)

PIN	SIGNAL	DESCRIPTION
1	Mouse DATA (or Keyboard DATA)	Mouse DATA (or Keyboard DATA)
2	NC	No connection
3	GND	Ground
4	VCC	+5V
5	Mouse Clock (or Keyboard Clock)	Mouse clock (or Keyboard Clock)
6	NC	No connection

RJ-45 LAN Jack: 10/100 LAN (8100C) / Giga-bit LAN (8110S/SB) (Optional)

The mainboard provides two standard RJ-45 jacks for connection to Local Area Network (LAN). Giga-bit LAN enables data to be transferred at 1000, 100 or 10Mbps. You can connect a network cable to either LAN jack.

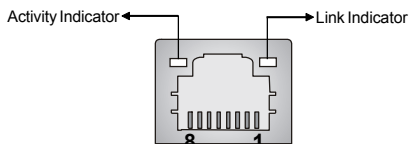

RJ-45 LAN Jack

LED	Color	LED State	Condition
Left	Green	Off	LAN link is not established.
		On (steady state)	LAN link is established.
		On (brighter & pulsing)	The computer is communicating with another computer on the LAN.
Right	Green	Off	10 Mbit/sec data rate is selected.
		On	100 Mbit/sec data rate is selected.
	Orange	On	1000 Mbit/sec data rate is selected.

The pin assignments vary depending on the transfer rates: 10/100Mbps or 1000Mbps. Note that Pin 1/2, 3/6, 4/5, 7/8 must work in pairs. Please refer to the following for details:

10/100 LAN Pin Definition

PIN	SIGNAL	DESCRIPTION
1	TDP	Transmit Differential Pair
2	TDN	Transmit Differential Pair
3	RDP	Receive Differential Pair
4	NC	Not Used
5	NC	Not Used
6	RDN	Receive Differential Pair
7	NC	Not Used
8	NC	Not Used

Giga-bit LAN Pin Definition

PIN	SIGNAL	DESCRIPTION
1	D0P	Differential Pair 0+
2	D0N	Differential Pair 0-
3	D1P	Differential Pair 1+
4	D2P	Differential Pair 2+
5	D2N	Differential Pair 2-
6	D1N	Differential Pair 1-
7	D3P	Differential Pair 3+
8	D3N	Differential Pair 3-

IEEE1394 Port (Optional)

The mainboard provides one standard IEEE1394 port. The standard IEEE1394 port connects to IEEE1394 devices without external power. The IEEE1394 high-speed serial bus complements USB by providing enhanced PC connectivity for a wide range of devices, including consumer electronics audio/video (A/V) appliances, storage peripherals, other PCs, and portable devices.

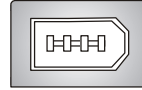

VGA Connector (Optional, for 865G/GV)

The mainboard provides a DB 15-pin female connector to connect a VGA monitor.

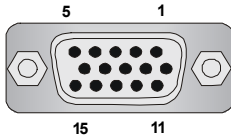

VGA Connector
(DB 15-pin)

Pin	Signal Description	Pin	Signal Description
1	RED	2	GREEN
3	BLUE	4	N/C
5	GND	6	GND
7	GND	8	GND
9	+5V	10	GND
11	N/C	12	SDA
13	Horizontal Sync	14	Vertical Sync
15	SCL		

Audio Port Connectors

Line Out is a connector for Speakers or Headphones. **Line In** is used for external CD player, Tape player, or other audio devices. **MIC-In** is a connector for microphones.

1/8" Stereo Audio Connectors

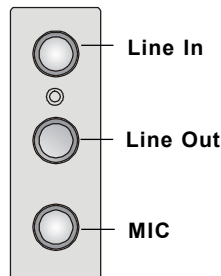

USB Connectors

The mainboard provides a UHCI (Universal Host Controller Interface) Universal Serial Bus root for attaching USB devices such as keyboard, mouse or other USB-compatible devices. You can plug the USB device directly into the connector.

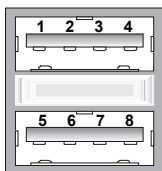

USB Ports

USB Port Description

PIN	SIGNAL	DESCRIPTION
1	VCC	+5V
2	-Data 0	Negative Data Channel 0
3	+Data 0	Positive Data Channel 0
4	GND	Ground
5	VCC	+5V
6	-Data 1	Negative Data Channel 1
7	+Data 1	Positive Data Channel 1
8	GND	Ground

Serial Port Connector: COM 1 & COM2 (Optional)

The mainboard offers one 9-pin male DIN connector COM 1, and one optional serial port COM2. Both are 16550A high speed communication ports that send/receive/ 16 bytes FIFOs. You can attach a serial mouse or other serial device directly to them.

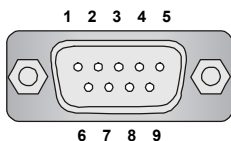

**9-Pin Male DIN Connector
COM 1**

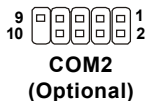

Pin Definition

PIN	SIGNAL	DESCRIPTION
1	DCD	Data Carry Detect
2	SIN	Serial In or Receive Data
3	SOUT	Serial Out or Transmit Data
4	DTR	Data Terminal Ready)
5	GND	Ground
6	DSR	Data Set Ready
7	RTS	Request To Send
8	CTS	Clear To Send
9	RI	Ring Indicate

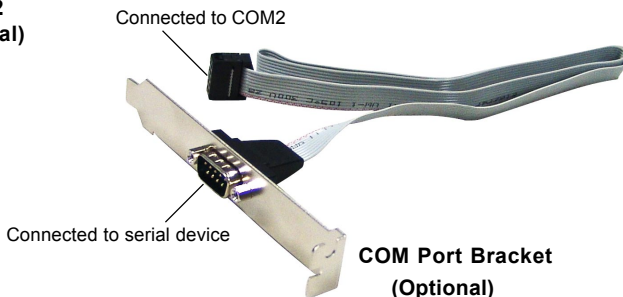

Parallel Port Connector: LPT1

The mainboard provides a 25-pin female centronic connector as LPT. A parallel port is a standard printer port that supports Enhanced Parallel Port (EPP) and Extended Capabilities Parallel Port (ECP) mode.

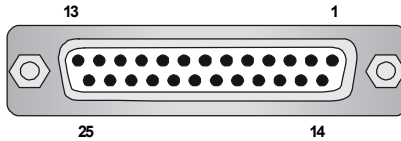

Pin Definition

PIN	SIGNAL	DESCRIPTION
1	STROBE	Strobe
2	DATA0	Data0
3	DATA1	Data1
4	DATA2	Data2
5	DATA3	Data3
6	DATA4	Data4
7	DATA5	Data5
8	DATA6	Data6
9	DATA7	Data7
10	ACK#	Acknowledge
11	BUSY	Busy
12	PE	PaperEnd
13	SELECT	Select
14	AUTO FEED#	AutomaticFeed
15	ERR#	Error
16	INIT#	Initialize Printer
17	SLIN#	Select In
18	GND	Ground
19	GND	Ground
20	GND	Ground
21	GND	Ground
22	GND	Ground
23	GND	Ground
24	GND	Ground
25	GND	Ground

Connectors

The mainboard provides connectors to connect to FDD, IDE HDD, case, modem, LAN, USB Ports and CPU/System/Power Supply FAN.

Floppy Disk Drive Connector: FDD1

The mainboard provides a standard floppy disk drive connector that supports 360K, 720K, 1.2M, 1.44M and 2.88M floppy disk types.

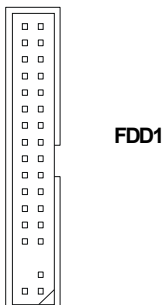

Fan Power Connectors: CPU_FAN/SYS_FAN

The CPU_FAN (processor fan), SYS_FAN (system fan) support system cooling fan with +12V. It supports three-pin head connector. When connecting the wire to the connectors, always take note that the red wire is the positive and should be connected to the +12V, the black wire is Ground and should be connected to GND. If the mainboard has a System Hardware Monitor chipset on-board, you must use a specially designed fan with speed sensor to take advantage of the CPU fan control.

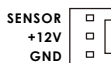

SYS_FAN

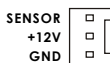

CPU_FAN



MSI Reminds You...

1. Always consult the vendors for proper CPU cooling fan.
2. Please refer to the recommended CPU fans at Intel® official website.
3. If you want to overclock the CPU, it is strongly recommended to use a multi-direction fan for better heatsink.

Hard Disk Connectors: IDE1 & IDE2

The mainboard has a 32-bit Enhanced PCI IDE and Ultra DMA 33/66/100 controller that provides PIO mode 0~4, Bus Master, and Ultra DMA 33/66/100 function. You can connect up to four hard disk drives, CD-ROM, 120MB Floppy (reserved for future BIOS) and other devices.

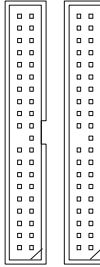

IDE2 IDE1

IDE1 (Primary IDE Connector)

The first hard drive should always be connected to IDE1. IDE1 can connect a Master and a Slave drive. You must configure second hard drive to Slave mode by setting the jumper accordingly.

IDE2 (Secondary IDE Connector)

IDE2 can also connect a Master and a Slave drive.



MSI Reminds You...

If you install two hard disks on cable, you must configure the second drive to Slave mode by setting its jumper. Refer to the hard disk documentation supplied by hard disk vendors for jumper setting instructions.

Chassis Intrusion Switch Connector: JCI1

This connector is connected to a 2-pin chassis switch. If the chassis is opened, the switch will be short. The system will record this status and show a warning message on the screen. To clear the warning, you must enter the BIOS utility and clear the record.



JCI1

CD-In Connector: JCD1

The connector is for CD-ROM audio connector.

SPDIF-Out Connector: JSP1

This connector is used to connect SPDIF (Sony & Philips Digital Interconnect Format) interface for digital audio transmission.

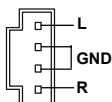

JCD1

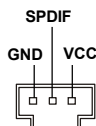

JSP1

Connected to JSP1

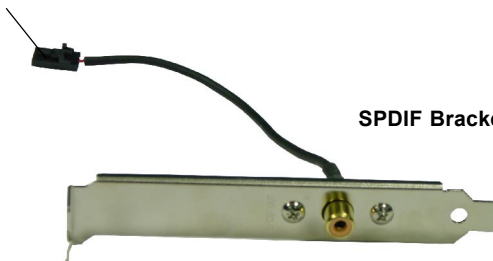

SPDIF Bracket (Optional)

Front USB Connectors: JUSB1 / JUSB2

The mainboard provides two standard USB 2.0 pin headers JUSB1 / JUSB2. USB 2.0 technology increases data transfer rate up to a maximum throughput of 480Mbps, which is 40 times faster than USB 1.1, and is ideal for connecting high-speed USB interface peripherals such as **USB HDD**, **digital cameras**, **MP3 players**, **printers**, **modems** and the like.



JUSB1/2 Pin Definition

PIN	SIGNAL	PIN	SIGNAL
1	VCC	2	VCC
3	USB0-	4	USB1-
5	USB0+	6	USB1+
7	GND	8	GND
9	Key	10	USBOC

Front Panel Connectors: JFP1 & JFP2

The mainboard provides two front panel connectors for electrical connection to the front panel switches and LEDs. JFP1 is compliant with Intel® Front Panel I/O Connectivity Design Guide.

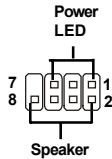

JFP2

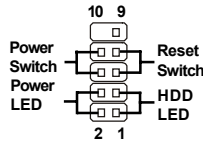

JFP1

JFP1 Pin Definition

PIN	SIGNAL	DESCRIPTION
1	HD_LED_P	Hard disk LED pull-up
2	FP PWR/SLP	MSG LED pull-up
3	HD_LED_N	Hard disk active LED
4	FP PWR/SLP	MSG LED pull-up
5	RST_SW_N	Reset Switch low reference pull-down to GND
6	PWR_SW_P	Power Switch high reference pull-up
7	RST_SW_P	Reset Switch high reference pull-up
8	PWR_SW_N	Power Switch low reference pull-down to GND
9	RSVD_DNU	Reserved. Do not use.

JFP2 Pin Definition

PIN	SIGNAL	PIN	SIGNAL
1	GND	2	SPK-
3	SLED	4	BUZ+
5	PLED	6	BUZ-
7	NC	8	SPK+

Serial ATA Connectors controlled by ICH5: SATA1, SATA2

The Southbridge of this mainboard is ICH5 which supports two serial connectors SATA1 & SATA2.

SATA1 & SATA2 are dual high-speed Serial ATA interface ports. Each supports 1st generation serial ATA data rates of 150 MB/s. Both connectors are fully compliant with Serial ATA 1.0 specifications. Each Serial ATA connector can connect to 1 hard disk device.

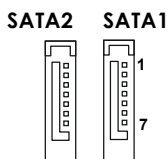

SATA1 & SATA2 Pin Definition

PIN	SIGNAL	PIN	SIGNAL
1	GND	2	TXP
3	TXN	4	GND
5	RXN	6	RXP
7	GND		

Serial ATA cable



Take out the dust cover and connect to the hard disk devices



MSI Reminds You...

Please do not fold the serial ATA cable in a 90-degree angle, which will cause the loss of data during the transmission.

Front Panel Audio Connector: JAUD1

The JAUD1 front panel audio connector allows you to connect to the front panel audio and is compliant with Intel® Front Panel I/O Connectivity Design Guide.



JAUD1

JAUD1 Pin Definition

PIN	SIGNAL	DESCRIPTION
1	AUD_MIC	Front panel microphone input signal
2	AUD_GND	Ground used by analog audio circuits
3	AUD_MIC_BIAS	Microphone power
4	AUD_VCC	Filtered +5V used by analog audio circuits
5	AUD_FPOUT_R	Right channel audio signal to front panel
6	AUD_RET_R	Right channel audio signal return from front panel
7	HP_ON	Reserved for future use to control headphone amplifier
8	KEY	No pin
9	AUD_FPOUT_L	Left channel audio signal to front panel
10	AUD_RET_L	Left channel audio signal return from front panel



MSI Reminds You...

If you don't want to connect to the front audio header, pins 5 & 6, 9 & 10 have to be jumpered in order to have signal output directed to the rear audio ports. Otherwise, the Line-Out connector on the back panel will not function.



IEEE 1394 Connector: J1394_1/J1394_2 (Optional)

The mainboard provides two 1394 pin headers that allow you to connect optional IEEE 1394 port.

Pin Definition

PIN	SIGNAL	PIN	SIGNAL
1	TPA+	2	TPA-
3	Ground	4	Ground
5	TPB+	6	TPB-
7	Cable power	8	Cable power
9	Key (no pin)	10	Ground

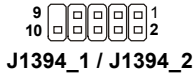

How to attach the IEEE 1394 Port:

Connected to J1394_1 / J1394_2

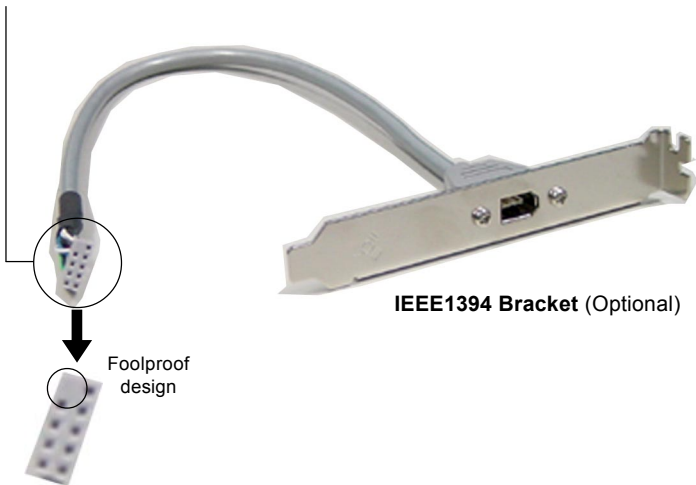

Jumpers

The motherboard provides the following jumpers for you to set the computer's function. This section will explain how to change your motherboard's function through the use of jumpers.

Clear CMOS Jumper: JBAT1

There is a CMOS RAM on board that has a power supply from external battery to keep the data of system configuration. With the CMOS RAM, the system can automatically boot OS every time it is turned on. That battery has long life time for at least 5 years. If you want to clear the system configuration, use the JBAT1 (Clear CMOS Jumper) to clear data. Follow the instructions below to clear the data:



JBAT1

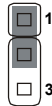

Keep Data



Clear Data



MSI Reminds You...

You can clear CMOS by shorting 2-3 pin while the system is off. Then return to 1-2 pin position. Avoid clearing the CMOS while the system is on; it will damage the mainboard.

Slots

The motherboard provides one AGP slot and three 32-bit PCI bus slots.

AGP (Accelerated Graphics Port) Slot

The AGP slot allows you to insert the AGP graphics card. AGP is an interface specification designed for the throughput demands of 3D graphics. It introduces a 66MHz, 32-bit channel for the graphics controller to directly access main memory. The mainboard supports one AGP 8x slot.

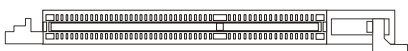

AGP Slot

PCI (Peripheral Component Interconnect) Slots

The PCI slots allow you to insert the expansion cards to meet your needs. When adding or removing expansion cards, make sure that you unplug the power supply first. Meanwhile, read the documentation for the expansion card to make any necessary hardware or software settings for the expansion card, such as jumpers, switches or BIOS configuration.

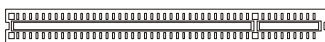

PCI Slots

PCI Interrupt Request Routing

The IRQ, abbreviation of interrupt request line and pronounced I-R-Q, are hardware lines over which devices can send interrupt signals to the microprocessor. The PCI IRQ pins are typically connected to the PCI bus INT A# ~ INT D# pins as follows:

	Order 1	Order 2	Order 3	Order 4
PCI Slot 1	INT G#	INT H#	INT E#	INT F#
PCI Slot 2	INT F#	INT G#	INT H#	INT E#
PCI Slot 3	INT E#	INT F#	INT G#	INT H#

3

BIOS Setup

This chapter provides information on the BIOS Setup program and allows you to configure the system for optimum use.

You may need to run the Setup program when:

- ◆ An error message appears on the screen during the system booting up, and requests you to run SETUP.
- ◆ You want to change the default settings for customized features.



MSI Reminds You...

1. *The items under each BIOS category described in this chapter are under continuous update for better system performance. Therefore, the description may be slightly different from the latest BIOS and should be held for reference only.*
2. *While booting up, the BIOS version is shown in the 1st line appearing after the memory counting. It is usually in the format: example: W7005MS V2.0 091096*

where:

1st digit refers to BIOS maker as A=AMI(R); W=AWARD(R)

2nd - 5th digit refers to the model number.

6th - 7th digit refers to the customer, MS=all standard customers.

V2.0 refers to the BIOS version.

091096 refers to the date this BIOS is released.

Entering Setup

Power on the computer and the system will start POST (Power On Self Test) process. When the message below appears on the screen, press key to enter Setup.

Press DEL to enter SETUP

If the message disappears before you respond and you still wish to enter Setup, restart the system by turning it OFF and On or pressing the RESET button. You may also restart the system by simultaneously pressing <Ctrl>, <Alt>, and <Delete> keys.

Control Keys

<↑>	Move to the previous item
<↓>	Move to the next item
<←>	Move to the item in the left hand
<→>	Move to the item in the right hand
<Enter>	Select the item
<Esc>	Jumps to the Exit menu or returns to the main menu from a submenu
<+ /PU>	Increase the numeric value or make changes
<- /PD>	Decrease the numeric value or make changes
<F1>	General help, only for Status Page Setup Menu and Option Page Setup Menu

Getting Help

After entering the Setup menu, the first menu you will see is the Main Menu.

Main Menu

The main menu lists the setup functions you can make changes to. You can use the control keys (↑↓) to select the item. The on-line description of the highlighted setup function is displayed at the bottom of the screen.

Sub-Menu

If you find a right pointer symbol (as shown in the right view) appears to the left of certain fields that means a sub-menu containing additional options can be launched from this field. You can use control keys (↑↓) to highlight the field and press <Enter> to call up the sub-menu. Then you can use the control keys to enter values and move from field to field within a sub-menu. If you want to return to the main menu, just press <Esc >.

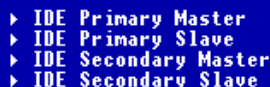

```

▶ IDE Primary Master
▶ IDE Primary Slave
▶ IDE Secondary Master
▶ IDE Secondary Slave
  
```

General Help <F1>

The BIOS setup program provides a General Help screen. You can call up this screen from any menu by simply pressing <F1>. The Help screen lists the appropriate keys to use and the possible selections for the highlighted item. Press <Esc> to exit the Help screen.

The Main Menu

Once you enter Phoenix-Award® BIOS CMOS Setup Utility, the Main Menu will appear on the screen. The Main Menu allows you to select from twelve setup functions and two exit choices. Use arrow keys to select among the items and press <Enter> to accept or enter the sub-menu.

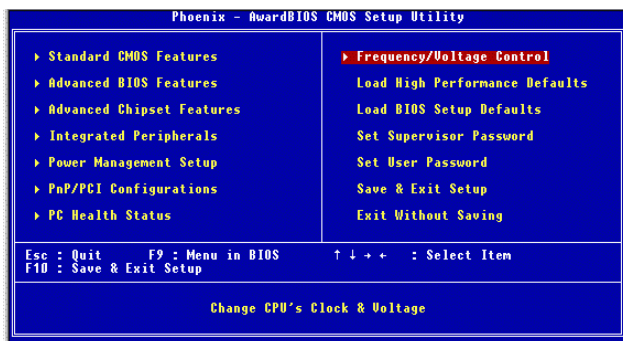

Standard CMOS Features

Use this menu for basic system configurations, such as time, date etc.

Advanced BIOS Features

Use this menu to setup the items of AWARD® special enhanced features.

Advanced Chipset Features

Use this menu to change the values in the chipset registers and optimize your system's performance.

Integrated Peripherals

Use this menu to specify your settings for integrated peripherals.

Power Management Setup

Use this menu to specify your settings for power management.

PNP/PCI Configurations

This entry appears if your system supports PnP/PCI.

PC Health Status

This entry shows your PC health status.

Frequency/Voltage Control

Use this menu to specify your settings for frequency/voltage control.

Load High Performance Defaults

Use this menu to load the BIOS values for the best system performance, but the system stability may be affected.

Load BIOS Setup Defaults

Use this menu to load factory default settings into the BIOS for stable system performance operations.

Set Supervisor Password

Use this menu to set Supervisor Password.

Set User Password

Use this menu to set User Password.

Save & Exit Setup

Save changes to CMOS and exit setup.

Exit Without Saving

Abandon all changes and exit setup.

Standard CMOS Features

The items in Standard CMOS Features Menu includes some basic setup items. Use the arrow keys to highlight the item and then use the <PgUp> or <PgDn> keys to select the value you want in each item.

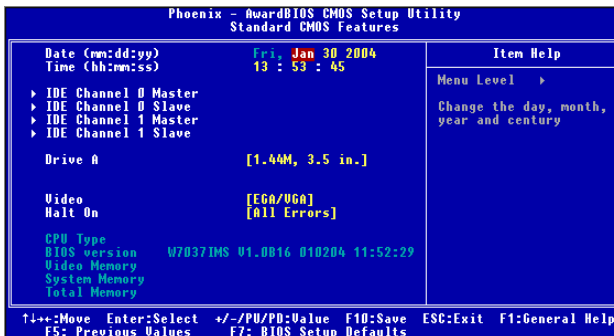

Date

This allows you to set the system to the date that you want (usually the current date). The format is <day><month> <date> <year>.

day	Day of the week, from Sun to Sat, determined by BIOS. Read-only.
month	The month from Jan. through Dec.
date	The date from 1 to 31 can be keyed by numeric function keys.
year	The year can be adjusted by users.

Time

This allows you to set the system time that you want (usually the current time). The time format is <hour> <minute> <second>.

IDE Channel 0/1 Master/Slave

Press PgUp/<+> or PgDn/<-> to select [Manual], [None] or [Auto] type. Note that the specifications of your drive must match with the drive table. The hard disk will not work properly if you enter improper information for this category. If your hard disk drive type is not matched or listed, you can use [Manual] to define your own drive type manually.

If you select [Manual], related information is asked to be entered to the following items. Enter the information directly from the keyboard. This information should be provided in the documentation from your hard disk vendor or the system manufacturer.

Access Mode	The settings are CHS, LBA, Large, Auto.
Capacity	The formatted size of the storage device.
Cylinder	Number of cylinders.
Head	Number of heads.
Precomp	Write precompensation.
Landing Zone	Cylinder location of the landing zone.
Sector	Number of sectors.

Drive A:

This item allows you to set the type of floppy drives installed. Available options: [None], [360K, 5.25 in.], [1.2M, 5.25 in.], [720K, 3.5 in.], [1.44M, 3.5 in.], [2.88M, 3.5 in.].

Video

The setting controls the type of video adapter used for the primary monitor of the system. Available options are [EGA/VGA], [CGA 40], [CGA 80] and [Mono].

Halt On

The setting determines whether the system will stop if an error is detected at boot. Available options are:

[All Errors]	The system stops when any error is detected.
[No Errors]	The system doesn't stop for any detected error.
[All, But Keyboard]	The system doesn't stop for a keyboard error.
[All, But Diskette]	The system doesn't stop for a disk error.
[All, But Disk/Key]	The system doesn't stop for either a disk or a keyboard error.

CPU Type/BIOS Version/Video Memory/System Memory/Total Memory

The items show the CPU type, BIOS version and memory status of your system (read only).

Advanced BIOS Features

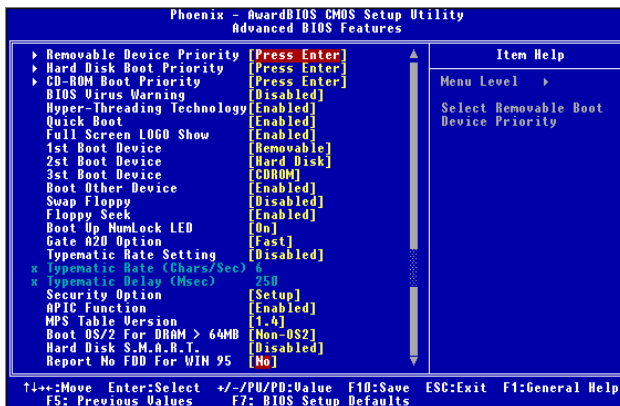

Removable Device Priority

Press <Enter> to enter the sub-menu. Then you may use the arrow keys (\uparrow) to select the desired device, then press <+>, <-> or <PageUp>, <PageDown> key to move it up/down in this removable device priority list.

Hard Disk Boot Priority

Press <Enter> to enter the sub-menu. Then you may use the arrow keys (\uparrow) to select the desired device, then press <+>, <-> or <PageUp>, <PageDown> key to move it up/down in this hard disk boot priority list.

CD-ROM Boot Priority

Press <Enter> to enter the sub-menu. Then you may use the arrow keys (\uparrow) to select the desired device, then press <+>, <-> or <PageUp>, <PageDown> key to move it up/down in this CD-ROM boot priority list.

BIOS Virus Warning

The item is to set the Virus Warning feature for IDE Hard Disk boot sector protection. If the function is enabled and any attempt to write data into this area is made, BIOS will display a warning message on screen and beep. Settings: [Disabled] and [Enabled].

Hyper-Threading Technology

The processor uses Hyper-Threading technology to increase transaction rates and reduces end-user response times. The technology treats the two cores inside the processor as two logical processors that can execute instructions simultaneously. In this way, the system performance is highly improved. If you disable the function, the processor will use only one core to execute the instructions. Settings: [Disabled] and [Enabled].



MSI Reminds You...

Enabling the functionality of Hyper-Threading Technology for your computer system requires ALL of the following platform Components:

- * **CPU:** An Intel® Pentium® 4 Processor with HT Technology;
- * **Chipset:** An Intel® Chipset that supports HT Technology;
- * **BIOS:** A BIOS that supports HT Technology and has it enabled;
- * **OS:** An operating system that supports HT Technology.

For more information on Hyper-threading Technology, go to:
www.intel.com/info/hyperthreading

Quick Boot

Setting the item to [Enabled] allows the system to boot within 5 seconds since it will skip some check items. Available options: [Enabled], [Disabled].

Full Screen LOGO Show

This item enables you to show the company logo on the bootup screen. Settings are:

- | | |
|------------|--|
| [Enabled] | Shows a still image (logo) on the full screen at boot. |
| [Disabled] | Shows the POST messages at boot. |

1st/2nd/3rd Boot Device

The items allow you to set the sequence of boot devices where BIOS attempts to load the disk operating system.



MSI Reminds You...

Available settings for “1st/2nd/3rd Boot Device” vary depending on the bootable devices you have installed. For example, if you did not install a floppy drive, the setting “Floppy” does not show up.

Boot Other Device

Setting the option to [Enabled] allows the system to try to boot from other device if the system fails to boot from the 1st/2nd/3rd boot device.

Swap Floppy

Setting to [Enabled] will swap floppy drives A: and B:.

Floppy Seek

Setting to [Enabled] will make BIOS seek floppy drive A: before booting the system. Settings: [Enabled], [Disabled].

Boot Up Num-Lock LED

This setting is to set the Num Lock status when the system is powered on. Setting to [On] will turn on the Num Lock key when the system is powered on. Setting to [Off] will allow users to use the arrow keys on the numeric keypad. Setting options: [On], [Off].

Gate A20 Option

This item is to set the Gate A20 status. A20 refers to the first 64KB of extended memory. When the default value [Fast] is selected, the Gate A20 is controlled by Port92 or chipset specific method resulting in faster system performance. When [Normal] is selected, A20 is controlled by a keyboard controller or chipset hardware.

Typematic Rate Setting

This item is used to enable or disable the typematic rate setting including Typematic Rate & Typematic Delay.

Typematic Rate (Chars/Sec)

After **Typematic Rate Setting** is enabled, this item allows you to set the rate (characters/second) at which the keys are accelerated. Settings: [6], [8], [10], [12], [15], [20], [24], [30].

Typematic Delay (Msec)

This item allows you to select the delay between when the key was first pressed and when the acceleration begins. Settings: [250], [500], [750], [1000].

Security Option

This specifies the type of BIOS password protection that is implemented. Settings are described below:

Option	Description
[Setup]	The password prompt appears only when end users try to run Setup.
[System]	A password prompt appears every time when the computer is powered on or when end users try to run Setup.

APIC Function

This field is used to enable or disable the APIC (Advanced Programmable Interrupt Controller). Due to compliance with PC2001 design guide, the system is able to run in APIC mode. Enabling APIC mode will expand available IRQ resources for the system. Settings: [Enabled], [Disabled].

MPS Table Version

This field allows you to select which MPS (Multi-Processor Specification) version to be used for the operating system. You need to select the MPS version supported by your operating system. To find out which version to use, consult the vendor of your operating system. Settings: [1.4], [1.1].

Boot OS/2 for DRAM > 64MB

This allows you to run the OS/2® operating system with DRAM larger than 64MB. When you choose [Non-OS2], you cannot run the OS/2® operating system with DRAM larger than 64MB. But it is possible if you choose [OS2].

Hard Disk S.M.A.R.T.

This allows you to activate the S.M.A.R.T. (Self-Monitoring Analysis & Reporting Technology) capability for the hard disks. S.M.A.R.T is a utility that monitors your disk status to predict hard disk failure. This gives you an opportunity to move data from a hard disk that is going to fail to a safe place before the hard disk becomes offline. Settings: [Enabled], [Disabled].

Report No FDD for WIN 95

For compatibility with Windows 95 logo certification, select [Yes] to release IRQ6 when the system contains no floppy drive. When this setting is set to Yes, users have to select [No] for the Onboard FDC Controller in the Integrated Peripherals menu. Setting options: [Yes], [No].

Advanced Chipset Features

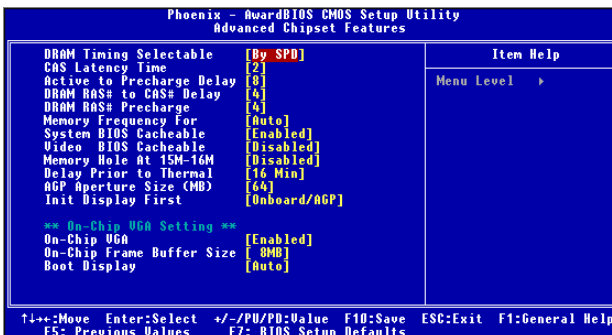

MSI Reminds You...

Change these settings only if you are familiar with the chipset.

DRAM Timing Selectable

Selects whether DRAM timing is controlled by the SPD (Serial Presence Detect) EEPROM on the DRAM module. Setting to [By SPD] enables the following fields automatically to be determined by BIOS based on the configurations on the SPD. Selecting [Manual] allows users to configure these fields manually.

CAS Latency Time

The fid controls the CAS latency, which determines the timing delay before RAM starts a read command after receiving it. Setting options are: [2], [2.5], [3]. [2] increases system performance while [3] provides more stable system performance.

Active to Precharge Delay

This setting controls the precharge delay, which determines the timing delay for DRAM precharge. Settings: [5], [6], [7], [8].

DRAM RAS# to CAS# Delay

When DRAM is refreshed, both rows and columns are addressed separately. This setup item allows you to determine the timing of the transition from RAS (row address strobe) to CAS (column address strobe). The less the clock cycles, the faster the DRAM performance. Setting options: [2], [3], [4].

DRAM RAS# Precharge

This item controls the number of cycles for Row Address Strobe (RAS) to be allowed to precharge. If insufficient time is allowed for the RAS to accumulate its charge before DRAM refresh, refreshing may be incomplete and DRAM may fail to retain data. This item applies only when synchronous DRAM is installed in the system. Setting options: [2], [3], [4].

Memory Frequency For

Use this item to configure the clock frequency of the installed DRAMs. Setting options: [Auto], [DDR266], [DDR333], [DDR320], [DDR400].

System BIOS Cacheable

Selecting [Enabled] allows caching of the system BIOS ROM at F0000h-FFFFFh, resulting in better system performance. However, if any program writes to this memory area, a system error may result. Setting options: [Enabled], [Disabled].

Video BIOS Cacheable

Selecting [Enabled] allows caching of the video BIOS ROM at C0000h to C7FFFh, resulting in better video performance. However, if any program writes to this memory area, a system error may result. Setting options: [Enabled], [Disabled].

Memory Hole At 15M-16M

In order to improve performance, certain space in memory can be reserved for ISA peripherals. This memory must be mapped into the memory space below 16MB. When this area is reserved, it cannot be cached. Setting options: [Enabled], [Disabled].

Delay Prior to Thermal

When the CPU temperature reaches a factory preset level, a thermal monitoring mechanism will be enabled following the appropriate timing delay specified in this field. With the thermal monitoring enabled, clock modulation controlled by the processor's internal thermal sensor is also activated to keep the processor within allowable temperature limit. Setting options: [4 Min], [8 Min], [16 Min], [32 Min].

AGP Aperture Size (MB)

This setting controls just how much system RAM can be allocated to AGP for video purposes. The aperture is a portion of the PCI memory address range dedicated to graphics memory address space. Host cycles that hit the aperture range are forwarded to the AGP without any translation. The option allows the selection of an aperture size of [4], [8], [16], [32], [64], [128], and [256].

Init Display First

Initialize the AGP video display before initializing any other display device on the system. Thus the AGP display becomes the primary display. Setting options: [Onboard/AGP] and [PCI Slot].

****On-Chip VGA Setting****

The following items allow you to configure the settings about On-Chip VGA.

On-Chip VGA

This setting determines whether the system RAM can be allocated to on-chip video controller for video purposes. When setting to Enabled, up to 128MB system RAM will be allocated to on-chip video controller. Setting: [Enabled] and [Disabled].

On-Chip Frame Buffer Size

Frame Buffer is the video memory that stores data for video display (frame). This field is used to determine the memory size for Frame Buffer. Larger frame buffer size increases video performance. Settings: [1MB], [8MB], [16MB].

Boot Display

Use the field to select the type of device you want to use as the display(s) of the system. Setting options: [Auto], [CRT], [TV], [EFP], [CRT+EFP], [CRT+TV]. The option [EFP] refers to the LCD display.

Integrated Peripherals

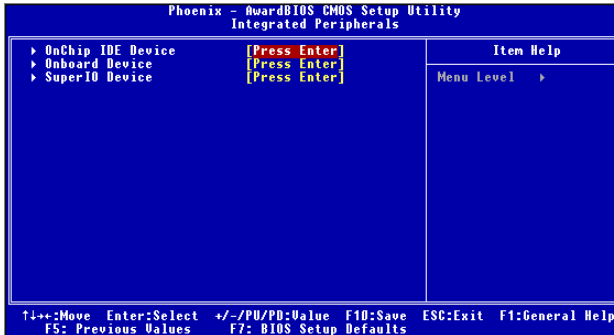

OnChip IDE Device

Press <Enter> to enter the sub-menu and the following screen appears:

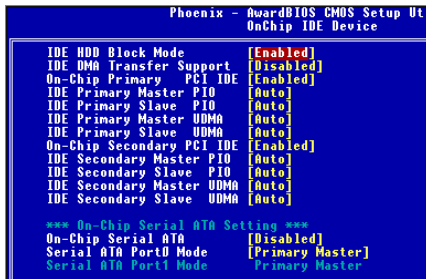

IDE HDD Block Mode

Block mode is also called block transfer, multiple commands, or multiple sector read/write. If your IDE hard drive supports block mode (most new drives do), select [Enabled] for automatic detection of the optimal number of block read/writes per sector the drive can support. Setting options: [Enabled], [Disabled].

IDE DMA Transfer Support

This item is used to enable or disable the DMA transfer function of the IDE Hard Drive. Setting options: [Enabled], [Disabled].

On-Chip Primary/Secondary PCI IDE

The integrated peripheral controller contains an IDE interface with support for two IDE channels. Choose [Enabled] to activate each channel separately. Settings: [Enabled], [Disabled].

IDE Primary/Secondary Master/Slave PIO

The four IDE PIO (Programmed Input/Output) fields let you set a PIO mode (0-4) for each of the four IDE devices that the onboard IDE interface supports. [Modes 0] through [Mode 4] provide successively increased performance. In [Auto]

mode, the system automatically determines the best mode for each device. The settings are: [Auto], [Mode 0], [Mode 1], [Mode 2], [Mode 3], [Mode 4].

IDE Primary/Secondary Master/Slave UDMA

Ultra DMA/33 implementation is possible only if your IDE hard drive supports it and the operating environment includes a DMA driver (Windows 95 OSR2 or a third-party IDE bus master driver). If your hard drive and your system software both support Ultra DMA/33, Ultra DMA/66 and Ultra DMA/100 select [Auto] to enable BIOS support. The settings are: [Auto], [Disabled].

*****On-Chip Serial ATA Setting*****

The following items allow you to configure the settings about on-chip Serial ATA settings.

On-Chip Serial ATA

This setting is used to specify the SATA controller. The settings are:

- [Disabled] Disable the SATA controller.
- [Auto] PATA and SATA will be arranged by BIOS, and you will be able to see the IDE Device status listed in **Standard CMOS Features**.
- [Legacy Mode] PATA and SATA will be combined. Max. of 2 IDE drives in each channel are available.
- [Native Mode] PATA and SATA will both be enabled. Max. of 6 IDE drives are supported.

Serial ATA Port 0/1 Mode

Select a compatible mode for Port 1 and Port 2 from Award setting to the chipset settings:

1. [Primary Master]
Compatible Mode with Serial ATA Port 1 set to Primary Master.
2. [Primary Slave]
Compatible Mode with Serial ATA Port 1 set to Primary Slave.
3. [Secondary Master]
Compatible Mode with Serial ATA Port 1 set to Secondary Master.
4. [Secondary Slave]
Compatible Mode with Serial ATA Port 1 set to Secondary Slave.
5. [Primary Master]
Compatible Mode with only Serial ATA Enabled and Port 1 set to Primary Master.
6. [Secondary Master]
Compatible Mode with only Serial ATA Enabled and Port 1 set to Secondary Master.
7. [SATA0 Master]
Enhance Mode with Port 0 set to Native Mode Master.
8. [SATA1 Master]
Enhance Mode with Port 1 set to Native Mode Master.

Onboard Device

Press <Enter> to enter the sub-menu and the following screen appears:

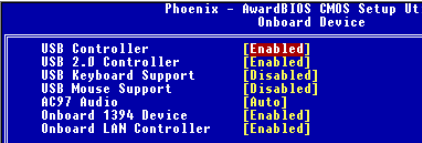

USB Controller

Select [Enabled] if your system contains a Universal Serial Bus (USB) controller and you have USB peripherals.

USB 2.0 Controller

Set to [Enabled] if you need to use any USB 2.0 device in the operating system that does not support or have any USB 2.0 driver installed, such as DOS and SCO Unix. Setting options: [Disabled], [Enabled].

USB Keyboard/Mouse Support

Select [Enabled] if you need to use a USB-interfaced keyboard/mouse in the operating system. The settings are: [Enabled], [Disabled].

AC97 Audio

[Auto] allows the mainboard to detect whether an audio device is used. If an audio device is detected, the onboard AC'97 (Audio Codec'97) controller will be enabled; if not, it is disabled. Disable the controller if you want to use other controller cards to connect an audio device. The settings are: [Auto], [Disabled].

OnBoard 1394

This item allows you to enable/disable the onboard IEEE1394 controller. The settings are: [Enabled], [Disabled].

Onboard LAN Control

This setting controls the onboard LAN controller. Setting options: [Enabled], [Disabled].

SuperIO Device

Press <Enter> to enter the sub-menu and the following screen appears:

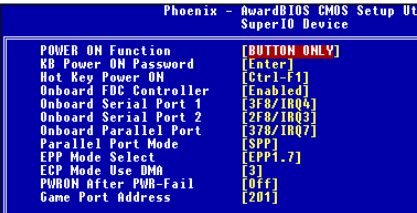

POWER ON Function

This controls how the PS/2 mouse or keyboard can power on the system. Settings: [Password], [Hot KEY], [Mouse Left], [Mouse Left], [Mouse Right], [Any KEY], [BUTTON ONLY], [Keyboard 98].

KB Power ON Function

If POWER ON Function is set to [Password], then you can set a password in the field for the PS/2 keyboard to power on the system.

Hot Key Power ON

If **POWER ON Function** is set to [Hot KEY], you can assign a hot key combination in the field for the PS/2 keyboard to power on the system. Settings: [Ctrl-F1] through [Ctrl-F12].

Onboard FDC Controller

Select [Enabled] if your system has a floppy disk controller (FDD) installed on the system board and you wish to use it. If you install add-on FDC or the system has no floppy drive, select [Disabled] in this field. The settings are: [Enabled], [Disabled].

Onboard Serial Port 1/2

Select an address and corresponding interrupt for the first and second serial ports. The settings are: [3F8/IRQ4], [2E8/IRQ3], [3E8/IRQ4], [2F8/IRQ3], [Disabled], [Auto].

Onboard Parallel Port

There is a built-in parallel port on the on-board Super I/O chipset that provides Standard, ECP, and EPP features. It has the following options:

[Disabled]	
[3BC/IRQ7]	Line Printer port 0
[278/IRQ5]	Line Printer port 2
[378/IRQ7]	Line Printer port 1

Parallel Port Mode

SPP : Standard Parallel Port

EPP : Enhanced Parallel Port

ECP : Extended Capability Port

ECP + EPP: Extended Capability Port + Enhanced Parallel Port

SPP/EPP/ECP/ECP+EPP

To operate the onboard parallel port as Standard Parallel Port only, choose [SPP]. To operate the onboard parallel port in the EPP mode simultaneously, choose [EPP]. By choosing [ECP], the onboard parallel port will operate in ECP mode only. Choosing [ECP + EPP] will allow the onboard parallel port to support both the ECP and EPP modes simultaneously. Choose [Normal] to use Standard Parallel Port + Bi-Directional Mode simultaneously.

EPP Mode Select

The onboard parallel port is EPP Spec. compliant, so after the user chooses the onboard parallel port with the EPP function, the following message will be displayed on the screen: "EPP Mode Select." At this time either [EPP 1.7] spec or [EPP 1.9] spec can be chosen.

ECP Mode Use DMA

The ECP mode has to use the DMA channel, so choose the onboard parallel port with the ECP feature. After selecting it, the following message will appear: "ECP Mode Use DMA." At this time, the user can choose between DMA channel [3] or [1].

PWRON After PWR-fail

This item specifies whether your system will reboot after a power failure or interrupt occurs. Available settings are:

- [Off] Leaves the computer in the power off state.
- [On] Leaves the computer in the power on state.
- [Former-Sts] Restores the system to the status before power failure or interrupt occurred.

Game Port Address

This item is used to specify the address for the onboard game port. Settings: [Disabled], [201], [209].

Power Management Setup

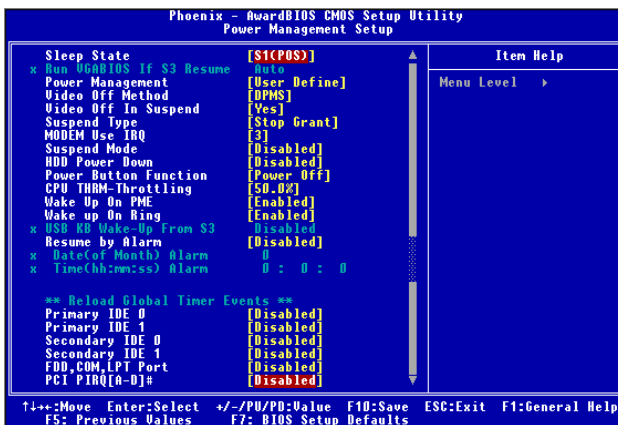

MSI Reminds You...

S3-related functions described in this section are available only when your BIOS supports S3 sleep mode.

Sleep State

This item specifies the power saving modes for ACPI function. If your operating system supports ACPI, such as Windows 98SE, Windows ME and Windows 2000, you can choose to enter the Standby mode in S1(POS) or S3(STR) fashion through the setting of this field. Options are:

- [S1 (POS)] The S1 sleep mode is a low power state. In this state, no system context is lost (CPU or chipset) and hardware maintains all system context.
- [S3 (STR)] The S3 sleep mode is a lower power state where the information of system configuration and open applications/files is saved to main memory that remains powered while most other hardware components turn off to save energy. The information stored in memory will be used to restore the system when a “wake up” event occurs.

Run VGABIOS if S3 Resume

When **Sleep State** is set to S3, users can select the options in this field. Selecting [Yes] allows BIOS to call VGABIOS to initialize the VGA card when system wakes up (resumes) from S3 sleep state. The system resume time is shortened when you disable the function, but system will need an AGP driver to initialize the VGA card. Therefore, if the AGP driver of the card does not support the initialization feature, the display may work abnormally or not function after resuming from S3. Options: [Auto], [Yes], [No].

Power Management

This item is used to select the degree (or type) of power saving and is related to the **HDD Power Down** item. There are three options for power management:

- [Min Saving] Minimum Power Management. Suspend Mode=1 Hour
- [Max Saving] Maximum Power Management. Suspend Mode=1 Min
- [User Define] Allows end users to configure each mode separately.

Video Off Method

This determines the manner in which the monitor is blanked.

- [V/H SYNC+Blank] This selection will cause the system to turn off the vertical and horizontal synchronization ports and write blanks to the video buffer.
- [Blank Screen] This option only writes blanks to the video buffer.
- [DPMS] Initial display power management signaling.

Video Off In Suspend

This option enables the monitor to be turned off during the suspend mode. Settings: [Yes], [No].

Suspend Type

This item allows you to select the suspend type for system power management. Settings: [Stop Grant], [PwrOn Suspend].

MODEM Use IRQ

This determines the IRQ in which the MODEM can use. Activity of the selected IRQ always awakens the system. Settings: [3], [4], [5], [7], [9], [10], [11], [NA].

Suspend Mode

If system activity is not detected for the length of time specified in this field, all devices except CPU will be shut off. Settings: [Disabled], [1 Min], [2 Min], [4 Min], [8 Min], [12 Min], [20 Min], [30 Min], [40 Min], [1 Hour].

HDD Power Down

If HDD activity is not detected for the length of time specified in this field, the hard disk drive will be powered down while all other devices remain active. Settings are [Disabled] and [1] through [15] Min.

Power Button Function

This feature sets the function of the power button. Settings are:

- [Power Off] The power button functions as normal power off button.
- [Suspend] When you press the power button, the computer enters the suspend/sleep mode, but if the button is pressed for more than four seconds, the computer is turned off.

CPU THRM-Throttling

The item allows you to specify the CPU speed (at percentage) to which it will slow down when the CPU reaches the predetermined overheat temperature. Settings: [75.0%], [50.0%], [25.0%].

Wake-Up On PME, Wake Up On Ring

These fields specify whether the system will be awakened from power saving modes when activity or input signal of the specified hardware peripheral or component is detected. Options: [Enabled], [Disabled].

**MSI Reminds You...**

You need to install a modem card supporting power on function for "Wake Up On Ring" function.

USB KB Wake-Up from S3

This setting allows you to enter "Any Key" (max. 8 numbers) to wake up the system from S3 state. Settings are: [Enabled] and [Disabled].

Resume by Alarm

This function is for setting time for your computer to boot up. The settings are: [Enabled], [Disabled].

Date (of Month)

The field specifies the date for **Resume by Alarm**. Settings: 0~31.

Resume Time (hh:mm:ss)

The field specifies the time for **Resume by Alarm**. Format is <hour><minute><second>.

**** Reload Global Timer Events ******Primary/Secondary IDE 0/1, FDD, COM, LPT Port, PCI PIRQ [A-D] #**

The global timer is the hardware timer that counts down to the power saving modes. If monitoring of the selected hardware peripherals or components is enabled, they will awaken the system from, or reload the original count of global timer for, suspend/sleep mode when they are accessed. Settings are: [Enabled] and [Disabled].

PNP/PCI Configurations

This section describes configuring the PCI bus system and PnP (Plug & Play) feature. PCI, or **P**eripheral **C**omponent **I**nterconnect, is a system which allows I/O devices to operate at speeds nearing the speed the CPU itself uses when communicating with its special components. This section covers some very technical items and it is strongly recommended that only experienced users should make any changes to the default settings.

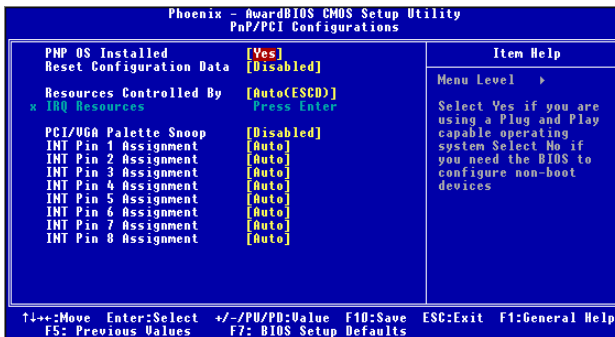

PNP OS Installed

When set to [Yes], BIOS will only initialize the PnP cards used for booting (VGA, IDE, SCSI). The rest of the cards will be initialized by the PnP operating system like Windows 98. When set to [No], BIOS will initialize all the PnP cards. So, select [Yes] if your operating system is Plug & Play aware.

Reset Configuration Data

Normally, you leave this field [Disabled]. Select [Enabled] to reset Extended System Configuration Data (ESCD) when you exit Setup if you have installed a new add-on and the system reconfiguration has caused such a serious conflict that the operating system cannot boot.

Resource Controlled By

The Award Plug and Play BIOS has the capacity to automatically configure all of the boot and Plug and Play compatible devices. However, this capability means absolutely nothing unless you are using a Plug and Play operating system such as Windows® 95/98. If you set this field to [Manual], choose specific resources by going into each of the sub menu that follows this field (a sub menu is preceded by a ">"). The settings are: [Auto (ESCD)], [Manual].

IRQ Resources

The items are adjustable only when **Resources Controlled By** is set to [Manual]. Press <Enter> and you will enter the sub-menu of the items. IRQ Resources list IRQ 3/4/5/7/9/10/11/12/14/15 for users to set each IRQ a type depending on the type of device using the IRQ. Settings are:

- [PCI Device] For Plug & Play compatible devices designed for PCI bus architecture.
- [Reserved] The IRQ will be reserved for further request.



MSI Reminds You...

IRQ (Interrupt Request) lines are system resources allocated to I/O devices. When an I/O device needs to gain attention of the operating system, it signals this by causing an IRQ to occur. After receiving the signal, when the operating system is ready, the system will interrupt itself and perform the service required by the I/O device.

PCI/VGA Palette Snoop

When set to [Enabled], multiple VGA devices operating on different buses can handle data from the CPU on each set of palette registers on every video device. Bit 5 of the command register in the PCI device configuration space is the VGA Palette Snoop bit (0 is disabled). For example, if there are two VGA devices in the computer (one PCI and one ISA) and the:

VGA Palette Snoop Bit Setting	Action
[Disabled]	Data read or written by the CPU is only directed to the PCI VGA device's palette registers.
[Enabled]	Data read or written by the CPU is directed to both the PCI VGA device's palette registers and the ISA VGA device's palette registers, permitting the palette registers of both VGA devices to be identical.

The setting must be set to [Enabled] if any ISA bus adapter in the system requires VGA palette snooping.

INT Pin 1-8 Assignment

These items specify the IRQ line for each PCI slot. Settings: [3], [4], [5], [7], [9], [10], [11], [12], [14], [15] and [Auto]. Selecting [Auto] allows BIOS to automatically determine the IRQ line for each PCI slot.

PC Health Status

This section shows the status of your CPU, fan, overall system status, etc. Monitor function is available only if there is hardware monitoring mechanism onboard.

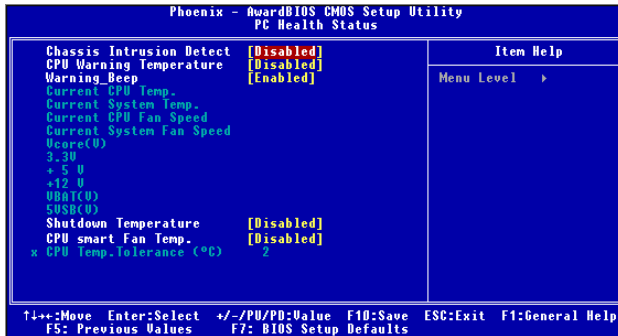

Chassis Intrusion Detect

The field enables or disables the feature of recording the chassis intrusion status and issuing a warning message if the chassis is once opened. To clear the warning message, set the field to [Reset]. The setting of the field will automatically return to [Enabled] later. Setting options: [Enabled], [Reset], [Disabled].

CPU Warning Temperature

This item is used to specify a thermal limit for CPU. If CPU temperature reaches the specified limit, the system will issue a warning which allows you to prevent the CPU overheat problem.

Warning_Beep

The item controls whether the system beeps when any warning such as system overheating problem or chassis intrusion event occurs. The settings are: [Enabled], [Disabled].

Current CPU/System Temperature, Current CPU/System Fan Speed, Vcore (V), 3.3V, +5V, +12V, -12V, -5V, VBAT(V), 5VSB(V)

These items display the current status of all of the monitored hardware devices/components such as CPU voltages, temperatures and all fans' speeds.

Shutdown Temperature

If the CPU temperature reaches the limit preset in this setting, the system will shut-down automatically.

CPU smart Fan Temperature

There is a pair of Temperature/FAN Speed control: CPU Temperature with CPU Fan. W83627THF provides the Smart Fan system which can control the fan speed automatically depending on the current temperature to keep it with in a specific range. Settings: [Enabled], [Disabled].

CPU Temp. Tolerance (°C)

You can select a fan tolerance value here for the specific range for the **CPU smart Fan Temperature** item. If the current temperatures of the 2 fans reach to the maximum threshold (the temperatures set in the **CPU smart Fan Temperature** plus the tolerance values you set here), the fans will speed up for cooling down. On the contrary if the current temperatures reach to the minimum threshold (the set temperatures minus the tolerance values), the fans will slow down to keep the temperatures stable.

Frequency/Voltage Control

Use this menu to specify your settings for frequency/voltage control.

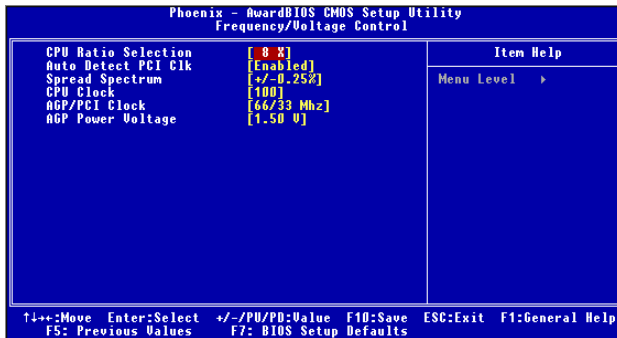

CPU Ratio Selection

This setting controls the multiplier that is used to determine the internal clock speed of the processor relative to the external or motherboard clock speed.

Auto Detect PCI Clk

This feature enables the BIOS to auto detect PCI device and set PCI slot clock. The settings are: [Enabled], [Disabled].

Spread Spectrum

When the motherboard's clock generator pulses, the extreme values (spikes) of the pulses creates EMI (Electromagnetic Interference). The **Spread Spectrum** function reduces the EMI generated by modulating the pulses so that the spikes of the pulses are reduced to flatter curves. If you do not have any EMI problem, leave the setting at [Disabled] for optimal system stability and performance. But if you are plagued by EMI, activate the **Spread Spectrum** for EMI reduction. Remember to disable **Spread Spectrum** if you are overclocking because even a slight jitter can introduce a temporary boost in clock speed which may just cause your overclocked processor to lock up. Options: [Disabled], [Enabled].

CPU Clock

This item specifies the clock frequency of CPU host bus (FSB), AGP (3V66) and PCI bus. It provides a method for end users to overclock the processor. Setting options: Give a DEC value by entering a number between maximum [233] MHz to minimum [100] MHz.

AGP/PCI Clock

AGP/PCI clock is adjustable in the field, allowing you to increase the performance of your AGP display card when overclocking, but the stability may be affected.

AGP Power Voltage

AGP voltage is adjustable in the field, allowing you to increase the performance of your AGP display card when overclocking, but the stability may be affected.

Load High Performance/BIOS Setup Defaults

The two options on the main menu allow users to restore all of the BIOS settings to High Performance defaults or BIOS Setup defaults. The High Performance Defaults are the values set by the mainboard manufacturer for the best system performance but probably will cause a stability issue. The BIOS Setup Defaults are the default values also set by the mainboard manufacturer for stable performance of the mainboard.

When you select Load High Performance Defaults, a message as below appears:

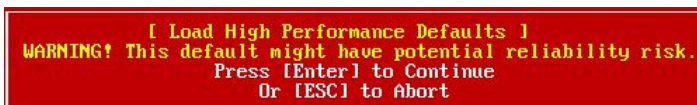

Pressing 'Enter' loads the default BIOS values that enable the best system performance but may lead to a stability issue.



MSI Reminds You...

The option is for power or overclocking users only. Use of high performance defaults will tighten most timings to increase the system performance. Therefore, a high-end system configuration is a must, which means you need high-quality VGA adapter, RAM and so on. **We don't recommend that users should apply the high performance defaults in their regular systems.** Otherwise, the system may become unstable or even crash. If the system crashes or hangs after enabling the feature, please CLEAR CMOS DATA to resolve the problem. For more information, refer to "Clear CMOS Jumper: JBAT1" in Chapter 2.

When you select Load BIOS Setup Defaults, a message as below appears:



Pressing 'Enter' loads the default values that are factory settings for stable system performance.

Set Supervisor/User Password

When you select this function, a message as below will appear on the screen:



Enter Password:

Type the password, up to six characters in length, and press <Enter>. The password typed now will replace any previously set password from CMOS memory. You will be prompted to confirm the password. Retype the password and press <Enter>. You may also press <Esc> to abort the selection and not enter a password.

To clear a set password, just press <Enter> when you are prompted to enter the password. A message will show up confirming the password will be disabled. Once the password is disabled, the system will boot and you can enter Setup without entering any password.

When a password has been set, you will be prompted to enter it every time you try to enter Setup. This prevents an unauthorized person from changing any part of your system configuration.

Additionally, when a password is enabled, you can also have Award BIOS to request a password each time the system is booted. This would prevent unauthorized use of your computer. The setting to determine when the password prompt is required is the *Security Option* of the *ADVANCED BIOS FEATURES* menu. If the *Security Option* is set to *System*, the password is required both at boot and at entry to Setup. If set to *Setup*, password prompt only occurs when you try to enter Setup.



MSI Reminds You...

About Supervisor Password & User Password:

Supervisor password: Can enter and change the settings of the setup menu.

User password: Can only enter but do not have the right to change the settings of the setup menu.

Appendix A: Using 2-, 4- & 6-Channel Audio Function

The mainboard is equipped with Realtek ALC655 chip, which provides support for 6-channel audio output, including 2 Front, 2 Rear, 1 Center and 1 Subwoofer channel. ALC655 allows the board to attach 4 or 6 speakers for better surround sound effect. The section will tell you how to install and use 4-/6-channel audio function on the board.

Installing the Audio Driver

You need to install the driver for Realtek ALC655 chip to function properly before you can get access to 4-/6-channel audio operations. Follow the procedures described below to install the drivers for different operating systems.

Installation for Windows 98SE/ME/2000/XP

For Windows® 2000, you must install Windows® 2000 Service Pack2 or later before installing the driver.

The following illustrations are based on Windows® XP environment and could look slightly different if you install the drivers in different operating systems.

1. Insert the companion CD into the CD-ROM drive. The setup screen will automatically appear.
2. Click **Realtek AC97 Audio Drivers**.

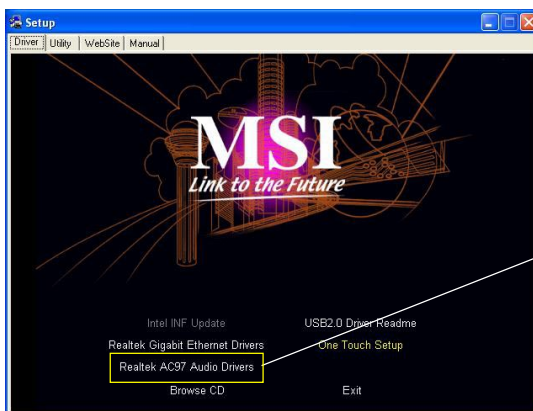

Click here



MSI Reminds You...

The **AC97 Audio Configuration**  software utility is under continuous update to enhance audio applications. Hence, the program screens shown here in this appendix may be slightly different from the latest software utility and shall be held for reference only.

3. Click **Next** to install the AC'97 Audio software.

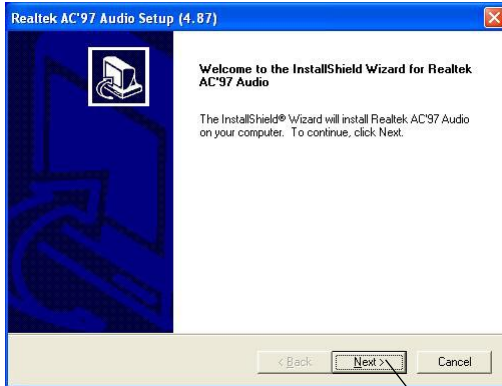

Click here

4. Click **Finish** to restart the system.

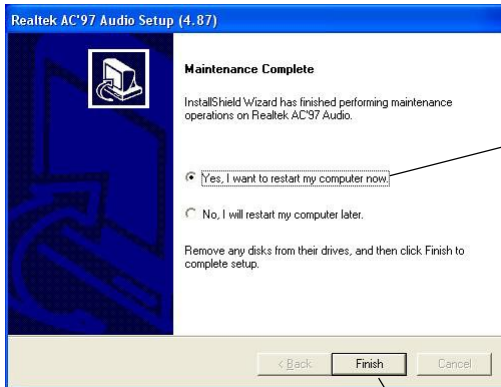

Select this option

Click here

Software Configuration

After installing the audio driver, you are able to use the 4-/6-channel audio feature now. Click the audio icon  from the window tray at the lower-right corner of the screen to activate the **AC97 Audio Configuration**.

Sound Effect

Here you can select a sound effect you like from the **Environment** list.

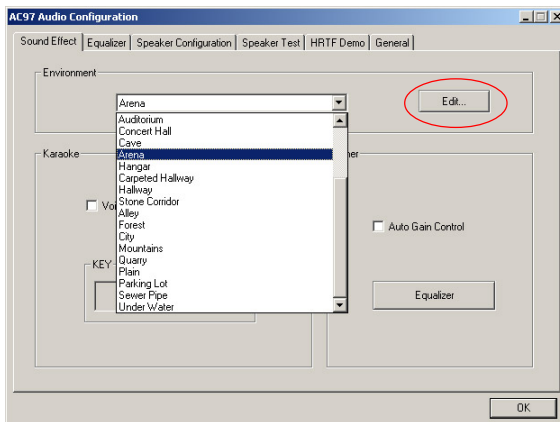

You may also edit the properties for an environment as you wish by clicking the **Edit** button, then just scroll the bar in the bottom for each property to adjust.

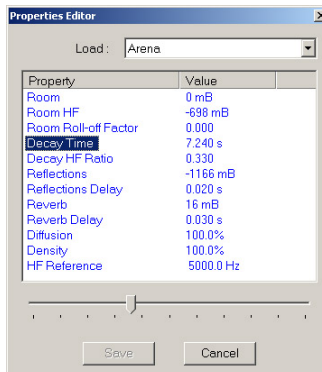

Here it provides the Karaoke function which will automatically remove human voice (lyrics) and leave melody for you to sing the song. Note that this function applies only for 2-channel audio operation.

Just check the **Voice Cancellation** box and then click **OK** to activate the Karaoke function.

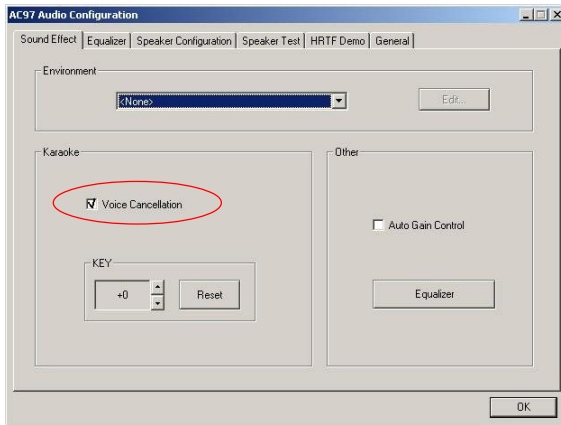

Equalizer

Here you regulate each equalizer for current playing digital sound sources.

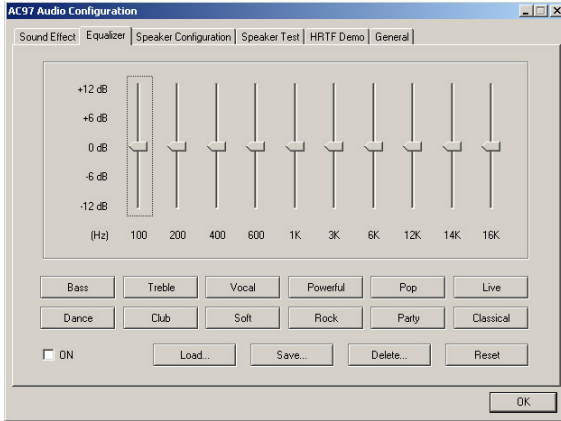

You may choose the provided sound effects, and the equalizer will adjust automatically. If you like, you may also load an equalizer setting or make a new equalizer setting to save as a new one by using the buttons **Load** and **Save**. Or you may click **Reset** to use the default value.

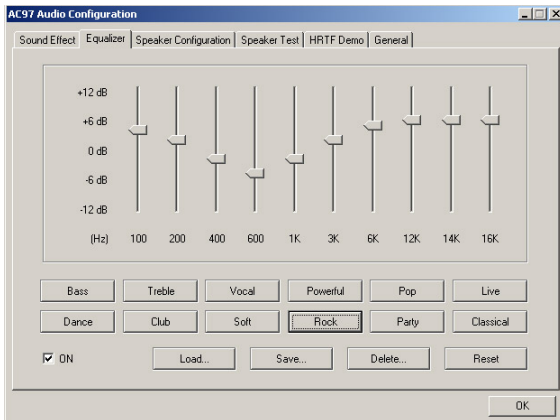

Speaker Configuration

In this tab, you can easily configure your multi-channel audio function and speakers.

1. Select **Synchronize the phonejack switch with the settings.**
2. Select a desired multi-channel operation from **No. of Speakers.**
Headphone
2-Channel Mode for Stereo-Speaker Output
4-Channel Mode for 4-Speaker Output
6-Channel Mode for 5.1-Speaker Output
3. Click **OK** to close this window.

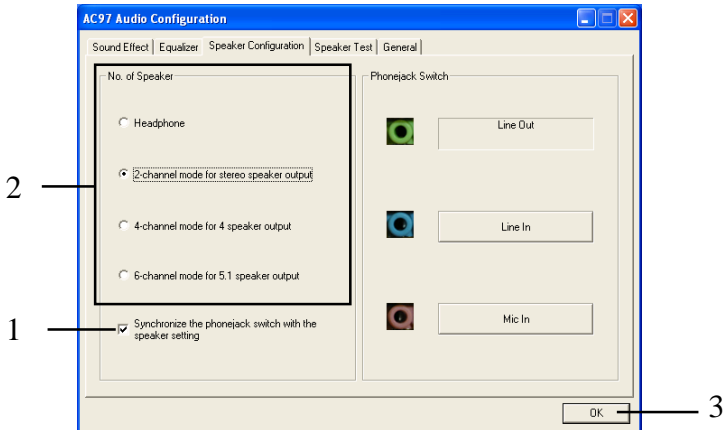

Speaker Test

You can use this tab to test each connected speaker to ensure if 4- or 6-channel audio operation works properly. If any speaker fails to make sound, then check whether the cable is inserted firmly to the connector or replace the bad speakers with good ones.

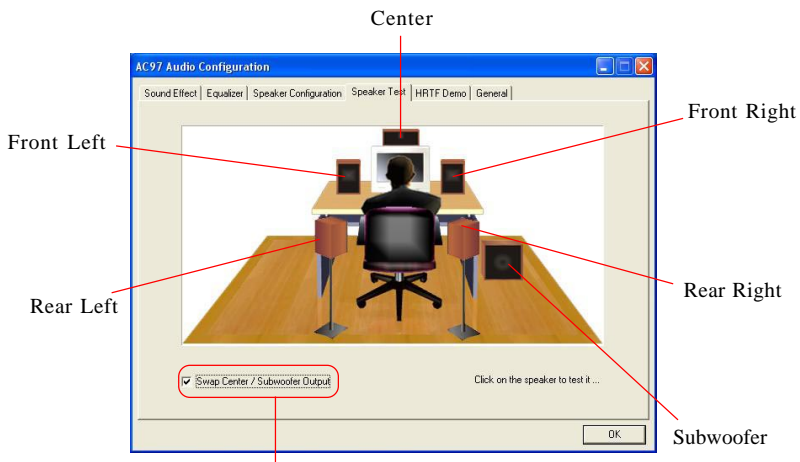

Select this function

Select the speaker by clicking it to test its functionality. The one you select will light up and make testing sound.

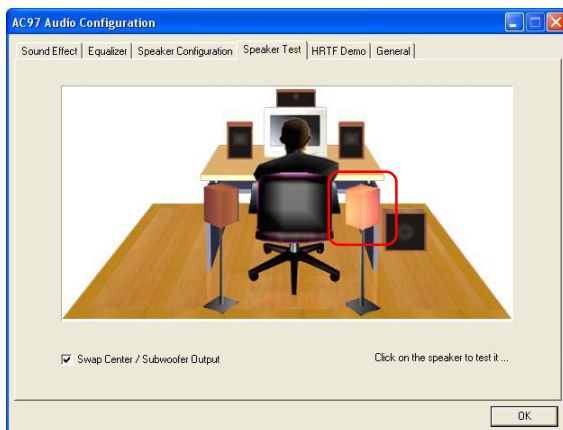



MSI Reminds You...

1. 6 speakers appear on the “Speaker Test” tab only when you select “**6-Channel Mode**” in the “Number of Speakers” column in “Speaker Configuration” tab. If you select “4-Channel Mode”, only 4 speakers appear on the window.
2. While you are testing the speakers in 6-Channel Mode, if the sound coming from the center speaker and subwoofer is swapped, you should select **Swap Center/Subwoofer Output** to readjust these two channels.

HRTF Demo

In this tab you may adjust your HRTF (Head Related Transfer Functions) 3D positional audio before playing 3D audio applications like gaming. You may also select different environment to choose the most suitable environment you like.

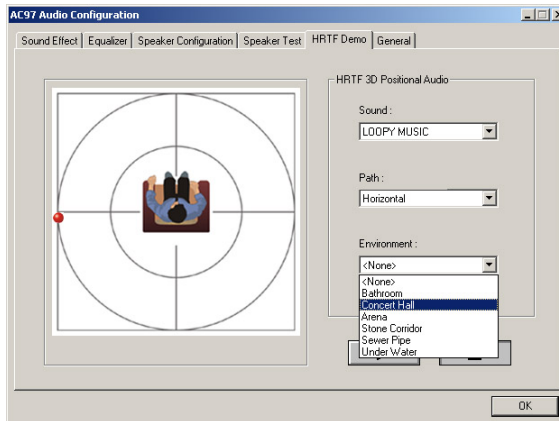

General

In this tab it provides some information about the AC97 Audio Configuration utility, including Audio Driver Version, DirectX Version, Audio Controller & AC97 Codec. You may also select the language of this utility by choosing from the **Language** list.

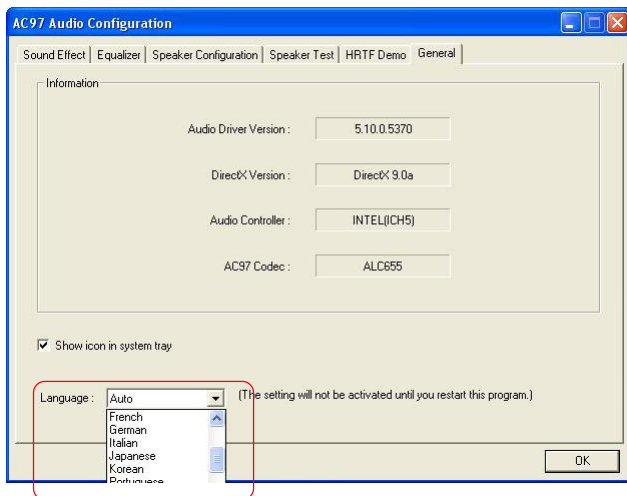

Using 2-, 4- & 6- Channel Audio Function

Connecting the Speakers

When you have set the Multi-Channel Audio Function mode properly in the software utility, connect your speakers to the correct phone jacks in accordance with the setting in software utility.

■ 2-Channel Mode for Stereo-Speaker Output

Refer to the following diagram and caption for the function of each phone jack on the back panel when 2-Channel Mode is selected.

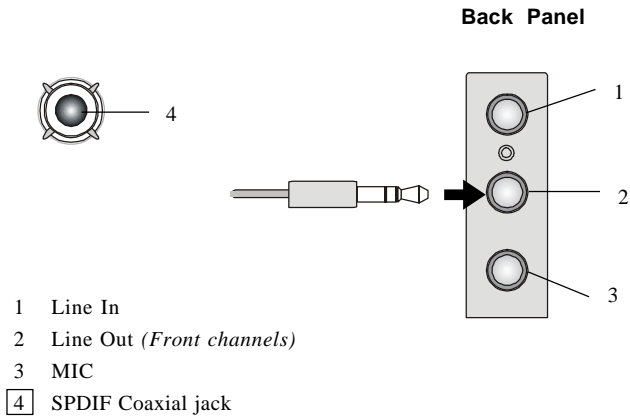

■ 4-Channel Mode for 4-Speaker Output

The audio jacks on the back panel always provide 2-channel analog audio output function, however these audio jacks can be transformed to 4- or 6-channel analog audio jacks by selecting the corresponding multi-channel operation from **No. of Speakers**.

Refer to the following diagram and caption for the function of each jack on the back panel when 4-Channel Mode is selected.

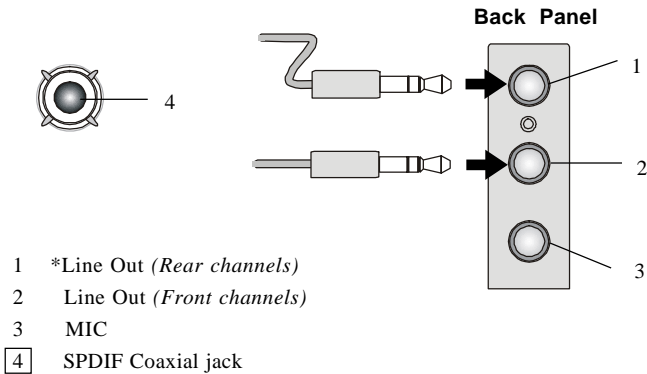

* Line In function is converted to Line Out function when 4-Channel Mode for 4-Speaker Output is selected.

■ **6-Channel Mode for 6-Speaker Output**

Refer to the following diagram and caption for the function of each jack on the back panel when 6-Channel Mode is selected.

- 1 * Line Out (*Rear channels*)
- 2 Line Out (*Front channels*)
- 3 * Line Out (*Center and Subwoofer channel*)
- 4 SPDIF Coaxial jack

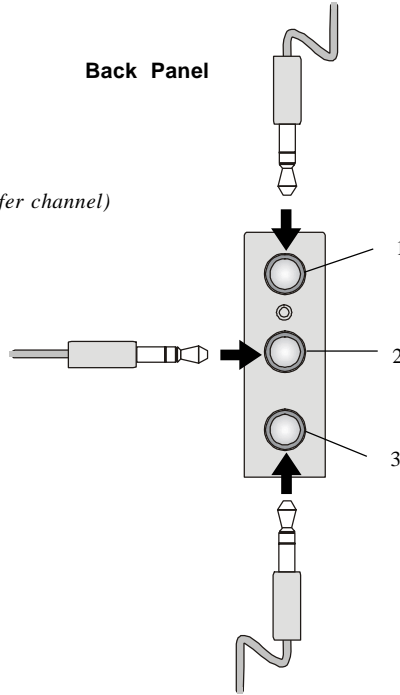
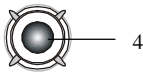

* Both Line In and MIC function are converted to Line Out function when 6-Channel Mode for 6-Speaker Output is selected.



MSI Reminds You...

If the audio signals coming from the Center and Subwoofer speaker are swapped when you play video or music on the computer, a converter may be required to exchange center and subwoofer audio signals. The converter can be purchased from a speaker store.