

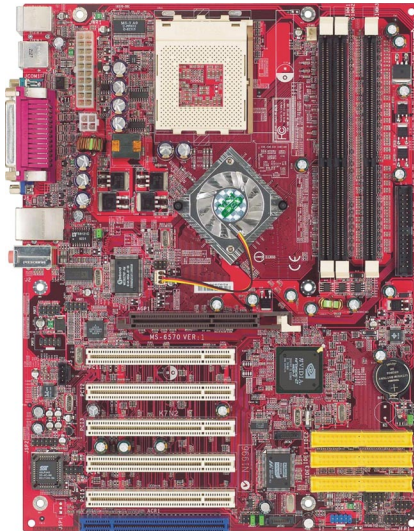

K7N2 Delta Series
MS-6570 (v1.X) ATX Mainboard



Version 1.3
G52-M6570XA-G22

Manual Rev: 1.3

Release Date: March 2003



FCC-B Radio Frequency Interference Statement

This equipment has been tested and found to comply with the limits for a class B digital device, pursuant to part 15 of the FCC rules. These limits are designed to provide reasonable protection against harmful interference when the equipment is operated in a commercial environment. This equipment generates, uses and can radiate radio frequency energy and, if not installed and used in accordance with the instruction manual, may cause harmful interference to radio communications. Operation of this equipment in a residential area is likely to cause harmful interference, in which case the user will be required to correct the interference at his own expense.

Notice 1

The changes or modifications not expressly approved by the party responsible for compliance could void the user's authority to operate the equipment.

Notice 2

Shielded interface cables and A.C. power cord, if any, must be used in order to comply with the emission limits.

VOIR LA NOTICE D'INSTALLATION AVANT DE RACCORDER AU RESEAU.

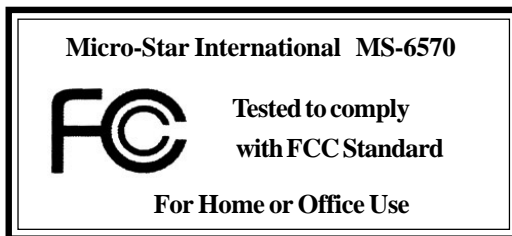

Copyright Notice

The material in this document is the intellectual property of **MICRO-STAR INTERNATIONAL**. We take every care in the preparation of this document, but no guarantee is given as to the correctness of its contents. Our products are under continual improvement and we reserve the right to make changes without notice.

Trademarks

All trademarks are the properties of their respective owners.

AMD, Athlon™, Athlon™ XP, Thoroughbred™, and Duron™ are registered trademarks of AMD Corporation.

PS/2 and OS®/2 are registered trademarks of International Business Machines Corporation.

Windows® 95/98/2000/NT/XP are registered trademarks of Microsoft Corporation.

Netware® is a registered trademark of Novell, Inc.

Award® is a registered trademark of Phoenix Technologies Ltd.

AMI® is a registered trademark of American Megatrends Inc.

Revision History

Revision	Revision History	Date
V1.3	Update specifications, MSI Special Features & Appendix	March 2003

Technical Support

If a problem arises with your system and no solution can be obtained from the user's manual, please contact your place of purchase or local distributor. Alternatively, please try the following help resources for further guidance.

- 🔍 Visit the MSI website for FAQ, technical guide, BIOS updates, driver updates, and other information: <http://www.msi.com.tw/>
- 🔍 Contact our technical staff at: support@msi.com.tw

Safety Instructions

1. Always read the safety instructions carefully.
2. Keep this User's Manual for future reference.
3. Keep this equipment away from humidity.
4. Lay this equipment on a reliable flat surface before setting it up.
5. The openings on the enclosure are for air convection hence protects the equipment from overheating. **DO NOT COVER THE OPENINGS.**
6. Make sure the voltage of the power source and adjust properly 110/220V before connecting the equipment to the power inlet.
7. Place the power cord such a way that people can not step on it. Do not place anything over the power cord.
8. Always Unplug the Power Cord before inserting any add-on card or module.
9. All cautions and warnings on the equipment should be noted.
10. Never pour any liquid into the opening that could damage or cause electrical shock.
11. If any of the following situations arises, get the equipment checked by a service personnel:
 - The power cord or plug is damaged.
 - Liquid has penetrated into the equipment.
 - The equipment has been exposed to moisture.
 - The equipment has not work well or you can not get it work according to User's Manual.
 - The equipment has dropped and damaged.
 - The equipment has obvious sign of breakage.
12. **DO NOT LEAVE THIS EQUIPMENT IN AN ENVIRONMENT UNCONDITIONED, STORAGE TEMPERATURE ABOVE 60°C (140°F), IT MAY DAMAGE THE EQUIPMENT.**



CAUTION: Danger of explosion if battery is incorrectly replaced. Replace only with the same or equivalent type recommended by the manufacturer.

CONTENTS

FCC-B Radio Frequency Interference Statement	ii
Copyright Notice	iii
Revision History	iii
Technical Support	iii
Safety Instructions	iv
Chapter 1. Getting Started	1-1
Mainboard Specifications	1-2
Mainboard Layout	1-4
MSI Special Features	1-5
Live BIOS™/Live Driver™	1-5
D-Bracket™ 2 (Optional)	1-6
PC Alert™ 4	1-8
InterVideo WinDVD 4 (Optional)	1-10
Live Monitor™	1-12
Round Cable (Optional)	1-13
Color Management	1-14
CPU Thermal Protection	1-15
S-Bracket (Optional)	1-15
Chapter 2. Hardware Setup	2-1
Quick Components Guide	2-2
Central Processing Unit: CPU	2-3
CPU Core Speed Derivation Procedure	2-3
Thermal Issue for CPU	2-3
CPU Installation Procedures for Socket 462	2-4
Installing AMD Athlon CPU (Socket 462) Cooler Set	2-5
CPU Clock Frequency Selection through BIOS	2-6
Memory	2-7
Introduction to DDR SDRAM	2-7
DIMM Module Combination	2-8

Installing DDR Modules	2-8
Power Supply	2-9
ATX 20-Pin Power Connector: JWR1	2-9
ATX 12V Power Connector: JPW1	2-9
Back Panel	2-10
Mouse Connector	2-10
Keyboard Connector	2-11
USB Connectors	2-11
Parallel Port Connector: LPT1	2-12
RJ-45 LAN Jack	2-13
Audio Port Connectors	2-13
Serial Port Connector	2-14
Connectors	2-15
Floppy Disk Drive Connector: FDD1	2-15
Hard Disk Connectors: IDE1 & IDE2	2-16
Fan Power Connectors: CFAN1/SFAN1	2-17
Hard Disk RAID Connectors: IDE3, SER1 & SER2 (Optional)	2-18
Front Panel Connectors: JFP1 & JFP2	2-20
Front Panel Audio Connector: JAUD1	2-21
Front USB Connector: JUSB2	2-22
Bluetooth Connector: JBT1 (Optional)	2-23
D-Bracket™ 2 Connector: JDLED1	2-24
CD-In Connector: JCD	2-25
S-Bracket Connector: JSP2	2-25
IEEE1394 Connectors: J1394_1 & J1394_2 (Optional)	2-27
IrDA Infrared Module Header: JIR1	2-29
Jumpers	2-30
Clear CMOS Jumper: JBAT1	2-30
FSB Mode Jumper: J10	2-31
CPU FSB Frequency Jumper: J11	2-31
Slots	2-32

AGP (Accelerated Graphics Port) Slot	2-32
PCI (Peripheral Component Interconnect) Slots	2-32
ACR (Advanced Communication Riser) Slot	2-33
PCI Interrupt Request Routing	2-33
Chapter 3. BIOS Setup	3-1
Entering Setup	3-2
Control Keys	3-2
Getting Help	3-3
The Main Menu	3-4
Standard CMOS Features	3-6
Advanced BIOS Features	3-8
Advanced Chipset Features	3-12
Integrated Peripherals	3-16
Power Management Features	3-21
PNP/PCI Configurations	3-25
PC Health Status	3-27
Frequency/Voltage Control	3-28
Load High Performance/BIOS Setup Defaults	3-30
Set Supervisor/User Password	3-31
Appendix: Using 4- or 6-Channel Audio Function	A-1
Installing the Audio Drivers	A-2
Using 4- or 6-Channel Audio Function	A-4
(For MCP2-T) Using the Optional S-Bracket	A-5
Using the Back Panel Only	A-14
(For MCP2) Configuration in the Software Utility	A-19
Troubleshooting	T-1
Glossary	G-1



Getting Started

Thank you for purchasing K7N2 Delta Series (MS-6570 v1.X) ATX mainboard. The K7N2 Delta Series mainboard is based on NVIDIA® nForce™2 system platform processor (SPP) & NVIDIA® nForce™2 media and communications processor / -turbo (MCP2/MCP2-T) for optimal system efficiency. Designed to fit the advanced AMD® Athlon™, Athlon™ XP or Duron™ processors, the K7N2 Delta Series mainboard delivers a high performance and professional desktop platform solution.

Mainboard Specifications

CPU

- ▶ Supports Socket A (Socket-462) for AMD Athlon/Athlon XP /Duron processors @ FSB 266/333/400
- ▶ Supports 600MHz up to Athlon XP 3000+ processor or higher

Chipset

- ▶ NVIDIA nForce2 SPP
 - Supports DDR200/266/333/400
 - Supports external AGP 4X/8X
- ▶ NVIDIA nForce2 MCP2 or MCP2-T
 - AC97 Interface supporting up to two concurrent codecs
 - Ultra ATA-133 for the fastest hard disk throughput
 - USB 2.0 EHCI/1.1 OHCI controller
 - FireWire® for the fastest digital connectivity (MCP2-T only)
 - Audio Processing Unit (APU) encodes audio in Dolby® Digital 5.1 format for full surround sound effects (MCP2-T only)

Main Memory

- ▶ Supports six memory banks using three 184-pin DDR DIMMs
- ▶ Supports up to 3GB PC3200/2700/2100/1600 DDR SDRAMs
- ▶ Supports both 64-bit and 128-bit DDR SDRAM

Slots

- ▶ One AGP (Accelerated Graphics Port) 1.5V 4X/8X slot
- ▶ Five 32-bit PCI bus slots (support 3.3v/5v PCI bus interface)
- ▶ One ACR (Advanced Communication Riser) slot

On-Board IDE

- ▶ An IDE controller on the MCP2/MCP2-T chipset provides IDE HDD/CD-ROM with PIO, Bus Master and Ultra DMA133/100/66 operation modes
- ▶ Can connect up to four IDE devices

On-Board Peripherals

- ▶ On-Board Peripherals include:
 - 1 floppy port supports 2 FDDs with 360K, 720K, 1.2M, 1.44M and 2.88Mbytes
 - 1 serial port

- 1 parallel port supports SPP/EPP/ECP mode
- 3 audio ports in vertical
- 2 IEEE1394 connectors (Optional)
- 1 D-Bracket2 pinheader
- 1 S-Bracket pinheader
- 1 Bluetooth pinheader (Optional)
- 6 USB ports (Rear * 4/ Front * 2)
- On-Board 10/100 Ethernet

Promise 20376 Serial ATA Interface (Optional)

- Support 2 serial ATA plus 1 ATA133
 - RAID 0 or 1 are supported
 - RAID function works w/ATA133+SATA H/D or 2 SATA H/D
- Connect up to 2 SATA devices and 1 ATA133 device

Audio

- Realtek ALC650 6-channel audio
- Dolby Digital 5.1 format (with MCP2-T option)

In-Chip IEEE1394(Optional)

- NVIDIA MCP2-T IEEE1394 controller
- Support up to two ports via external bracket

BIOS

- The mainboard BIOS provides “Plug & Play” BIOS which detects the peripheral devices and expansion cards of the board automatically.
- The mainboard provides a Desktop Management Interface (DMI) function which records your mainboard specifications.

Mounting and Dimension

- ATX Form Factor: 30.5 cm (L) x 23 cm (W)
- 6 mounting holes

Others

- Suspend to RAM/Disk (S3/S4)
- PC2001 compliant
- Support PCI 2.2/WOR

Mainboard Layout

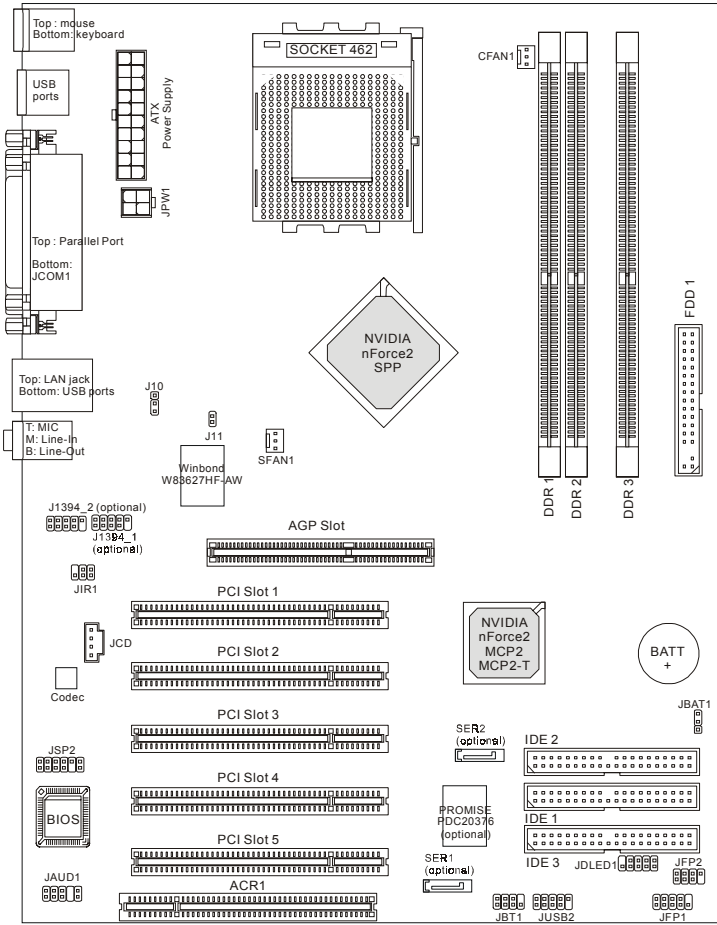

K7N2 Delta-L/LS/ILSR (MS-6570 v1.X) ATX Mainboard

MSI Special Features

Live BIOS™/Live Driver™

The Live BIOS™/Live Driver™ is a tool used to detect and update your BIOS/drivers online so that you don't need to search for the correct BIOS/driver version throughout the Web site. To use the function, you need to install the “MSI Live Update 2” application. After the installation, the “MSI Live Update 2” icon (as shown on the right) will appear on the screen.



Double click the “MSI Live Update 2” icon, and the following screen will appear:

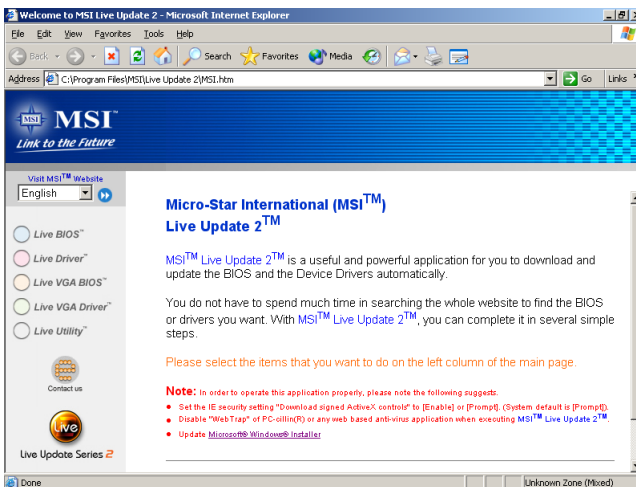

Five buttons are placed on the leftmost pane of the screen. Click the desired button to start the update process.

- **Live BIOS** – Updates the BIOS online.
- **Live Driver** – Updates the drivers online.
- **Live VGA BIOS** – Updates the VGA BIOS online.
- **Live VGA Driver** – Updates the VGA driver online.
- **Live Utility** – Updates the utilities online.

If the product you purchased does not support any of the functions listed above, a “sorry” message is displayed. For more information on the update instructions, insert the companion CD and refer to the “Live Update Guide” under the “Manual” Tab.

D-Bracket™ 2 (Optional)

D-Bracket™ 2 is a USB bracket integrating four Diagnostic LEDs, which use graphic signal display to help users understand their system. The LEDs provide up to 16 combinations of signals to debug the system. The 4 LEDs can detect all problems that fail the system, such as VGA, RAM or other failures. This special feature is very useful for overclocking users. These users can use the feature to detect if there are any problems or failures. D-Bracket™ 2 supports both USB 1.1 & 2.0 spec.



● Red ○ Green

D-Bracket 2	Description
<div style="display: flex; justify-content: space-between;"> 1 ● 2 ● </div> <div style="display: flex; justify-content: space-between;"> 3 ○ 4 ○ </div>	<p>System Power ON</p> <ul style="list-style-type: none"> - The D-LED will hang here if the processor is damaged or not installed properly.
<div style="display: flex; justify-content: space-between;"> ○ ● </div> <div style="display: flex; justify-content: space-between;"> ● ● </div>	<p>Early Chipset Initialization</p>
<div style="display: flex; justify-content: space-between;"> ● ○ </div> <div style="display: flex; justify-content: space-between;"> ● ● </div>	<p>Memory Detection Test</p> <ul style="list-style-type: none"> - Testing onboard memory size. The D-LED will hang if the memory module is damaged or not installed properly.
<div style="display: flex; justify-content: space-between;"> ○ ○ </div> <div style="display: flex; justify-content: space-between;"> ● ● </div>	<p>Decompressing BIOS image to RAM for fast booting.</p>
<div style="display: flex; justify-content: space-between;"> ● ● </div> <div style="display: flex; justify-content: space-between;"> ○ ● </div>	<p>Initializing Keyboard Controller.</p>
<div style="display: flex; justify-content: space-between;"> ○ ● </div> <div style="display: flex; justify-content: space-between;"> ○ ● </div>	<p>Testing VGA BIOS</p> <ul style="list-style-type: none"> - This will start writing VGA sign-on message to the screen.

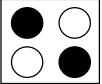
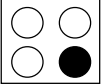
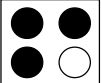
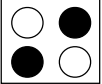
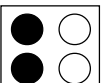
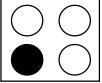
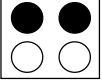
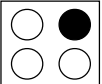
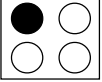
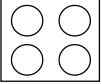
D-Bracket 2	Description
	<p>Processor Initialization</p> <ul style="list-style-type: none"> - This will show information regarding the processor (like brand name, system bus, etc...)
	<p>Testing RTC (Real Time Clock)</p>
	<p>Initializing Video Interface</p> <ul style="list-style-type: none"> - This will start detecting CPU clock, checking type of video onboard. Then, detect and initialize the video adapter.
	<p>BIOS Sign On</p> <ul style="list-style-type: none"> - This will start showing information about logo, processor brand name, etc...
	<p>Testing Base and Extended Memory</p> <ul style="list-style-type: none"> - Teting base memory from 240K to 640K and extended memory above 1MB using various patterns.
	<p>Assign Resources to all ISA.</p>
	<p>Initializing Hard Drive Controller</p> <ul style="list-style-type: none"> - This will initialize IDE drive and controller.
	<p>Initializing Floppy Drive Controller</p> <ul style="list-style-type: none"> - This will initialize Floppy Drive and controller.
	<p>Boot Attempt</p> <ul style="list-style-type: none"> - Thi will set low stack and boot via INT 19h.
	<p>Operating System Booting</p>

PC Alert™ 4

The PC Alert™ 4 is a utility you can find in the CD-ROM disk. The utility is just like your PC doctor that can detect the following PC hardware status during real time operation:

- ✦ monitor CPU & system temperatures
- ✦ monitor fan speeds
- ✦ monitor system voltages



If one of the items above is abnormal, the program main screen will be immediately shown on the screen, with the abnormal item highlighted in red. This will continue to be shown until the condition returns to the normal status.

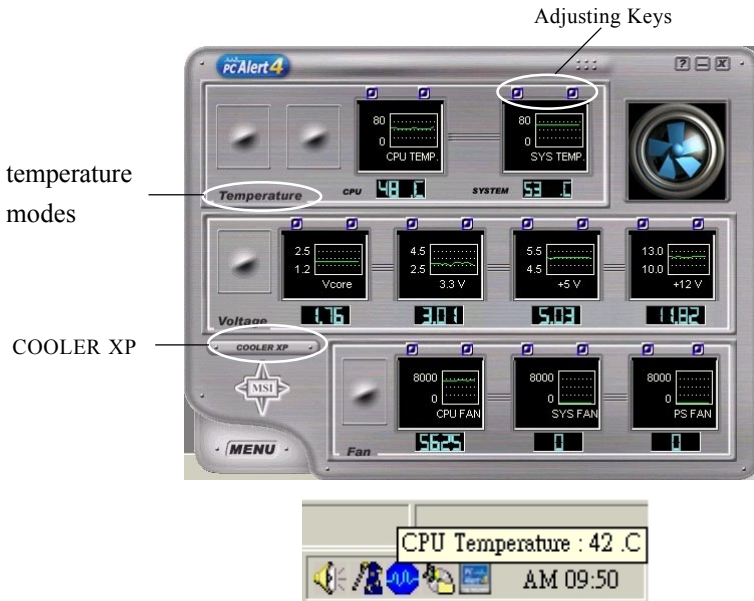

Users can use the Adjusting Keys to change the minimum and maximum threshold of each item for the system to send out a warning message. Click *Temperature* to select the temperature modes of either Fahrenheit (°F) or Celsius (°C). The PC Alert4 icon on the Status Area will show the current CPU temperature.

To better protect the CPU from overheating, a new feature, **COOLER XP**, has been added to decrease the temperature of AMD Athlon XP CPU. To do so, simply click **COOLER XP** and the screen will show the **Cute** skin (as shown below) with information about the CPU and chipset. Right-click the mouse to select the skin you want to switch to.

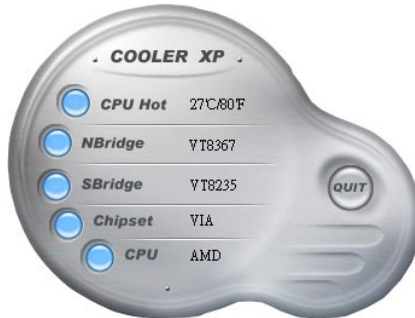

Cute



MSI Reminds You...

*The new feature **COOLER XP** will work only if your mainboard supports AMD Athlon XP CPU.*

Items shown on PC Alert 4 vary depending on your system's status.



InterVideo WinDVD 4 (Optional)

The motherboard comes with InterVideo WinDVD 4 application which supports 5.1 channel (6-channel audio) operation. The accompanying WinDVD for MSI is a convenient tool to meet increasing demands for home entertainment.



To play DVD with 6-channel audio output, you must configure both the WinDVD 4 application and the audio codec's software utility. Otherwise, the 6-channel audio function will not work properly. For information on how to select 6-channel mode in the audio software utility, refer to *Appendix. Using 4- or 6-Channel Audio Function*.

Follow the procedures below to enable the audio functions:

1. Click this button  on the control panel of WinDVD to see the submenus. You can make adjustments in *Navigation, Language, Display, Color, Audio Effect* and *Audio Mode*.
2. Go to any menu and click  to bring up the Setup screen.



3. Click the **Audio** tab. Select **6 Channel** for 5.1 channel home entertainment experience.

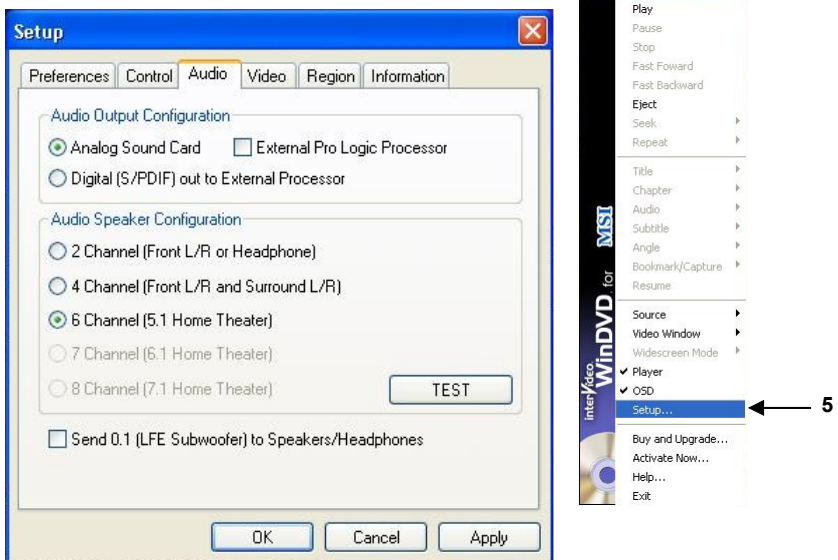

4. Click **OK** or **Apply** to finish the audio setup.
5. Shortcut to Setup: Right-click the InterVideo screen to bring up the *WinDVD for MSI* audio menu.

Live Monitor™

The Live Monitor™ is a tool used to schedule the search for the latest BIOS/drivers version on the MSI Web site. To use the function, you need to install the “MSI Live Update 2” application. After the installation, the “MSI Live Monitor” icon (as shown on the right) will appear on the screen. Double click this icon to run the application.



Double click the “MSI Live Monitor” icon  at the lower-right corner of the taskbar, and the following dialog box will appear. You can specify how often the system will automatically search for the BIOS/drivers version, or change the LAN settings right from the dialog box.

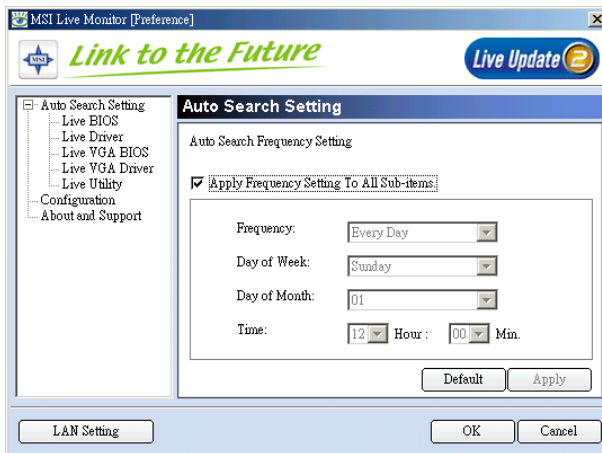

You can right-click the MSI Live Monitor icon  to perform the functions listed below:

- **Auto Search** – Searches for the BIOS/drivers version you need immediately.
- **View Last Result** – Allows you to view the last search result if there is any.
- **Preference** – Configures the Search function, including the Search schedule.
- **Exit** – Exits the Live Monitor™ application.
- **FAQ** – Provides a link to a database which contents various possible questions about MSI's products for users to inquire.

Round Cable (Optional)

Round cable is an enhanced cable for PCI IDE and Ultra DMA controller. It has the following benefits:

- Data transfer rate started by 133MB/s
- Backward compatibility (ATA33/66/100/133)
- Higher performance than traditional Flat cable (data rate)
- Improved data robustness
- Better airflow due to thinner ATA/133 cable

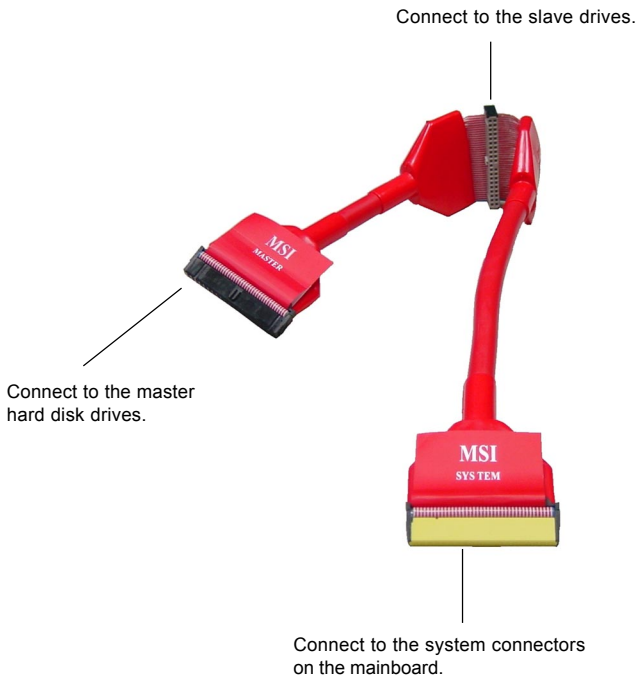

Color Management

MSI has an unified color management rule for some connectors on the mainboards, which helps you to install the memory modules, expansion cards and other peripherals devices more easily and conveniently.

- Memory DDR DIMMs: light green
- IDE ATA133 connectors: yellow
- Serial ATA150 connectors: orange
- AGP 8X slot: red
- 1394 connectors: dark green
- USB 2.0 connector shared with bluetooth module: blue
- Front panel connector JFP1 : HDD LED in red, Reset Switch in blue, Power Switch in black, Power LED in light green.
- Front panel connector JFP2: Power LED in light green.

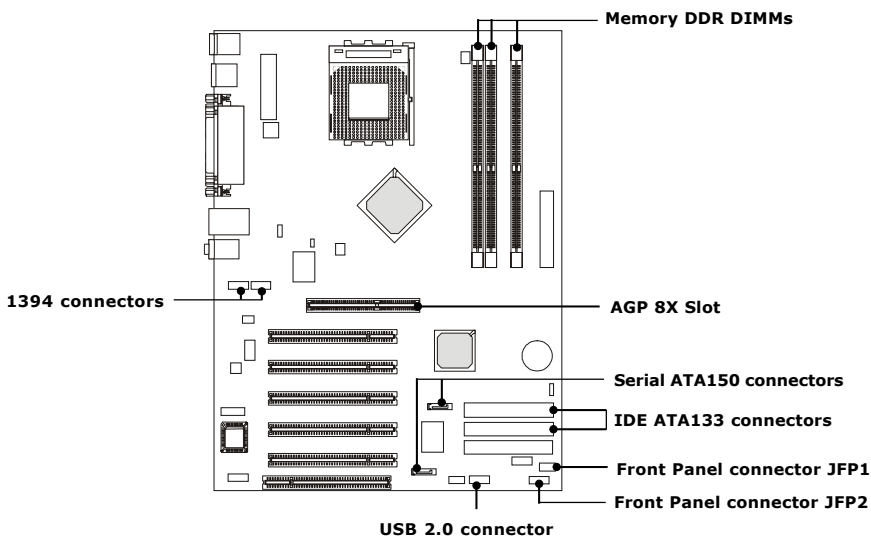

CPU Thermal Protection

Aimed to prevent the CPU from overheating, MSI has developed a CPU Thermal Protection mechanism for AMD Athlon™ XP CPU platform. This CPU Thermal Protection mechanism works on a thermal signal sensor. If the mechanism senses an abnormal temperature rise, it will automatically shut down the system and the CPU temperature will then drop down and resume normal. With this unique feature, users can better protect their CPU. Please note that this feature is for AMD Athlon™ XP CPU only.

S-Bracket (Optional)

S-Bracket is a bracket which provides 2 SPDIF jacks for digital audio transmission and 2 analog Line-Out connectors for additional 4-channel analog audio output. With the S-Bracket, your system will be able to perform 6-channel audio operation for wonderful surround sound effect, or connect to Sony & Philips Digital Interface (SPDIF) speakers for audio transmission with better quality.

The S-Bracket offers two types of SPDIF connectors: one for optical fiber and the other for coaxial connection. Select the appropriate one to meet your own need. For more information on S-Bracket, refer to *Appendix. Using 4- or 6-Channel Audio Function.*

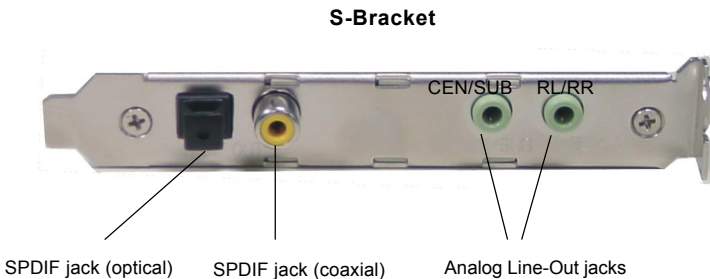

2

Hardware Setup

This chapter tells you how to install the CPU, memory modules, and expansion cards, as well as how to setup the jumpers on the mainboard. Also, it provides the instructions on connecting the peripheral devices, such as the mouse, keyboard, etc.

While doing the installation, be careful in holding the components and follow the installation procedures.

Quick Components Guide

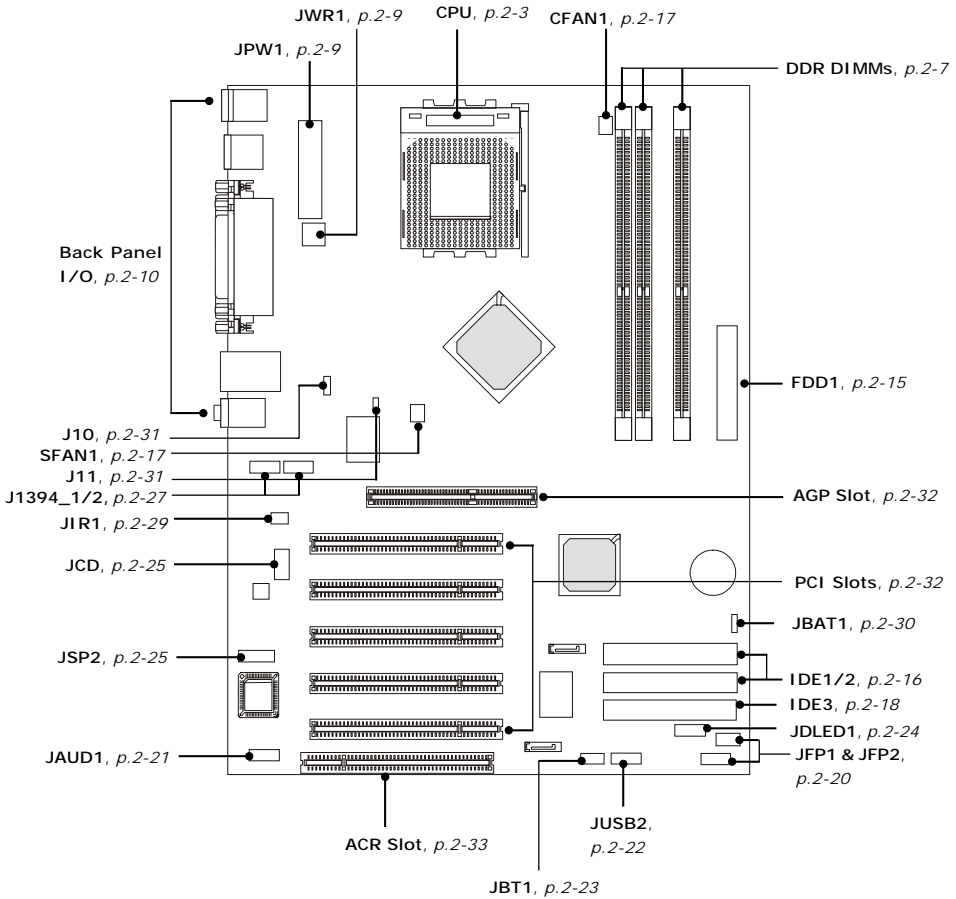

Central Processing Unit: CPU

The mainboard supports AMD® Athlon™, Athlon™ XP and Duron™ processors in the 462 pin package. The mainboard uses a CPU socket called Socket A for easy CPU installation. When you are installing the CPU, **make sure the CPU has a heat sink and a cooling fan attached on the top to prevent overheating.** If you do not find the heat sink and cooling fan, contact your dealer to purchase and install them before turning on the computer.

CPU Core Speed Derivation Procedure

CPU Clock multiplied by **Core/Bus ratio** equals the CPU core speed.

For example:

If	CPU Clock	=	100MHz
	Core/Bus ratio	=	14
then	CPU core speed	=	Host Clock x Core/Bus ratio
		=	100MHz x 14
		=	1.4 GHz



WARNING! Thermal Issue for CPU

As processor technology pushes to faster speeds and higher performance, thermal management becomes increasingly crucial when building computer systems. Maintaining the proper thermal environment is key to reliable operation. As such, the processor must be maintained in the specified thermal requirements.

AMD Athlon™/Duron™/Athlon™ XP processor with a speed of **600MHz and above** requires a LARGER heatsink and fan. You also need to add thermal grease between the CPU and heatsink to improve heat dissipation. Then, make sure that the CPU and heatsink are securely fastened and in good contact with each other. These are needed to prevent damaging the processor and ensuring reliable operation. If you want to get more information on the proper cooling, you can visit AMD's website for reference.

CPU Installation Procedures for Socket 462

1. Please turn off the power and unplug the power cord before installing the CPU.
2. Pull the lever sideways away from the socket. Make sure to raise the lever up to a 90-degree angle.
3. Look for the gold arrow. The gold arrow should point towards the lever pivot. The CPU can only fit in the correct orientation.
4. If the CPU is correctly installed, the pins should be completely embedded into the socket and can not be seen. Please note that any violation of the correct installation procedures may cause permanent damages to your mainboard.
5. Press the CPU down firmly into the socket and close the lever. As the CPU is likely to move while the lever is being closed, always close the lever with your fingers pressing tightly on top of the CPU to make sure the CPU is properly and completely embedded into the socket.

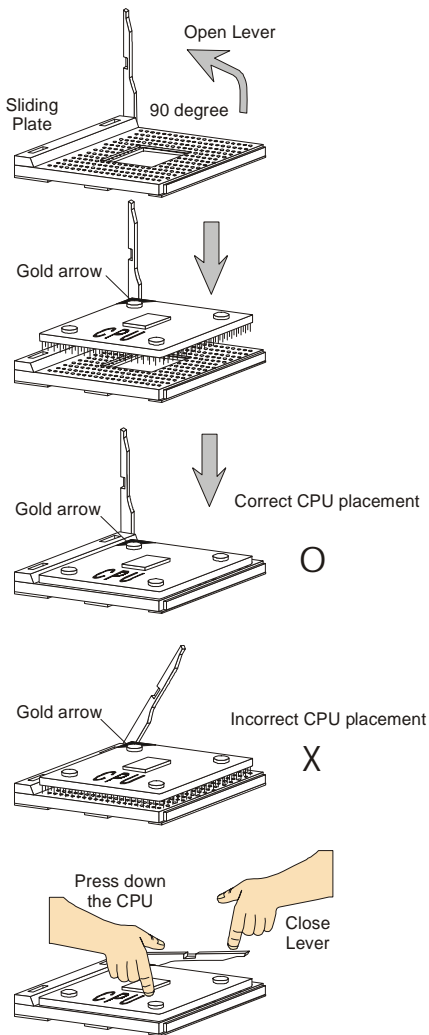

Installing AMD Athlon CPU (Socket 462) Cooler Set

The following instructions will guide you through the heat sink installation process. Please consult your agent for the proper CPU cooler set.

1. Position your CPU cooler set onto the CPU.
2. Use one end of the clip to hook the latch of the CPU sliding plate.
3. Hook the other latch to fix the cooling fan set. You may need a screw driver to press down the other side of the clip.
4. Connect the fan to the power supply connector provided on your mainboard.

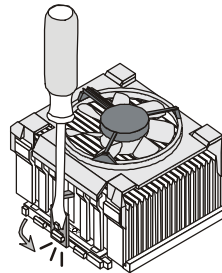
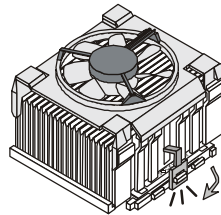
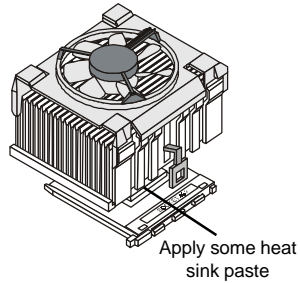

MSI Reminds You...

Please apply some heat sink paste on top of your CPU to dissipate the heat more effectively.

CPU Clock Frequency Selection through BIOS

The hardware configuration for CPU clock frequency of the motherboard is set to 133MHz by default. Therefore, to use a CPU with FSB clock frequency of 166MHz or higher, you have to adjust the CPU clock frequency in the BIOS setup utility (see p.3-12). If you use a 100MHz CPU, make sure that you have set the CPU FSB Frequency jumper open connected (see p. 2-31).



MSI Reminds You...

Overheating

Overheating will seriously damage the CPU and system, always make sure the cooling fan can work properly to protect the CPU from overheating.

Replacing the CPU

While replacing the CPU, always turn off the ATX power supply or unplug the power supply's power cord from grounded outlet first to ensure the safety of CPU.

Overclocking

*This motherboard is designed to support overclocking. However, please make sure your components are able to tolerate such abnormal setting, while doing overclocking. Any attempt to operate beyond product specifications is not recommended. **We do not guarantee the damages or risks caused by inadequate operation or beyond product specifications.***

Memory

The mainboard provides 3 slots for 184-pin DDR SDRAM DIMM (Double In-Line Memory Module) modules and supports the memory size up to 3GB. You can install DDR200/266/333/400 modules on the DDR DIMM slots (DIMM 1~3).

Please note that the system supports 128-bit dual channel DDR when you install DDR modules on DIMM1 (purple slot) and DIMM3 (green slot), or DIMM2 (purple slot) and DIMM3 (green slot).

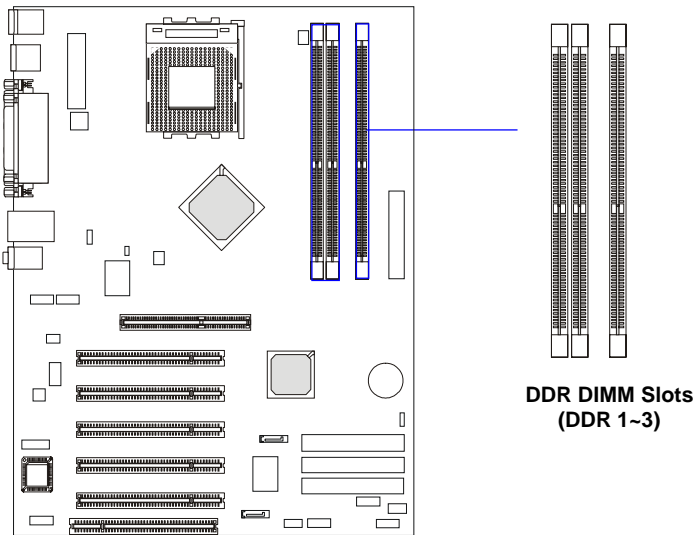

Introduction to DDR SDRAM

DDR (Double Data Rate) SDRAM is similar to conventional SDRAM, but doubles the rate by transferring data twice per cycle. It uses 2.5 volts as opposed to 3.3 volts used in SDR SDRAM, and requires 184-pin DIMM modules rather than 168-pin DIMM modules used by SDR SDRAM. High memory bandwidth makes DDR an ideal solution for high performance PC, workstations and servers.

DIMM Module Combination

Install at least one DIMM module on the slots. You can install either single- or double-sided modules in any order to meet your own needs.

Memory modules can be installed in any combination as follows:

Slot	Memory Module	Total Memory
DIMM 1 (Bank 0 & 1)	S/D	64MB~1GB
DIMM 2 (Bank 2 & 3)	S/D	64MB~1GB
DIMM 3 (Bank 4 & 5)	S/D	64MB~1GB
Maximum System Memory Supported		64MB~3GB

S: Single Side

D: Double Side

Installing DDR Modules

1. The DDR DIMM has only one notch on the center of module. The module will only fit in the right orientation.
2. Insert the DIMM memory module vertically into the DIMM slot. Then push it in until the golden finger on the memory module is deeply inserted in the socket.
3. The plastic clip at each side of the DIMM slot will automatically close.

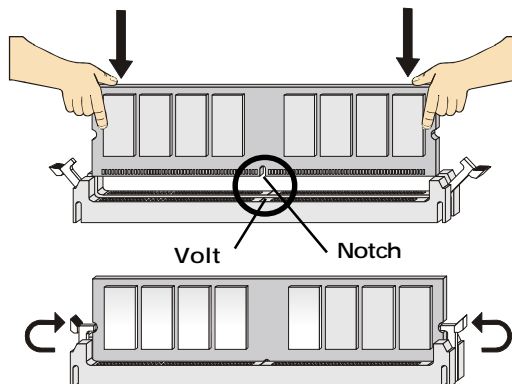

MSI Reminds You...

You can barely see the golden finger if the module is properly inserted in the socket.

Power Supply

The mainboard supports ATX power supply for the power system. Before inserting the power supply connector, always make sure that all components are installed properly to ensure that no damage will be caused.

ATX 20-Pin Power Connector: JWR1

This connector allows you to connect to an ATX power supply. To connect to the ATX power supply, make sure the plug of the power supply is inserted in the proper orientation and the pins are aligned. Then push down the power supply plug firmly into the connector.

ATX 12V Power Connector: JPW1

This 12V power connector is used to provide power to the CPU.

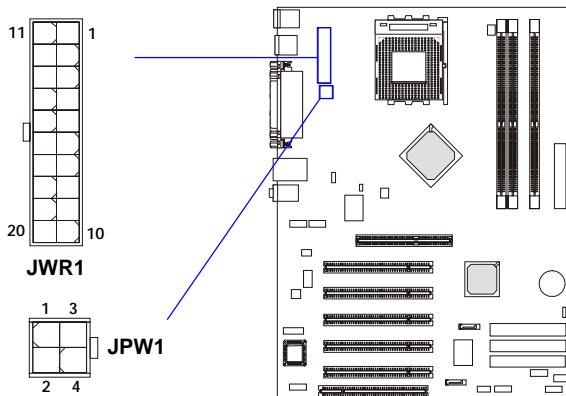

JWR1 Pin Definition

PIN	SIGNAL	PIN	SIGNAL
1	3.3V	11	3.3V
2	3.3V	12	-12V
3	GND	13	GND
4	5V	14	PS_ON
5	GND	15	GND
6	5V	16	GND
7	GND	17	GND
8	PW_OK	18	-5V
9	5V_SB	19	5V
10	12V	20	5V

JPW1 Pin Definition

PIN	SIGNAL
1	GND
2	GND
3	12V
4	12V

Back Panel

The back panel provides the following connectors:

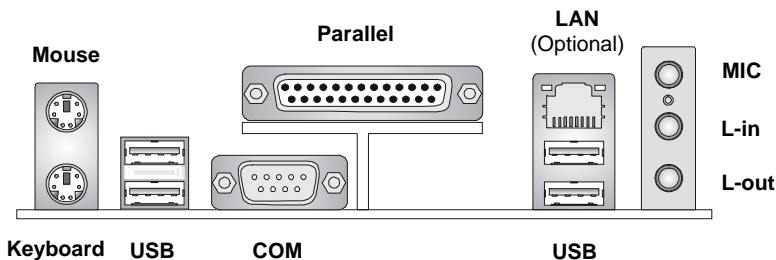

Mouse Connector

The mainboard provides a standard PS/2[®] mouse mini DIN connector for attaching a PS/2[®] mouse. You can plug a PS/2[®] mouse directly into this connector. The connector location and pin assignments are as follows:

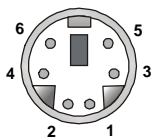

PS/2 Mouse (6-pin Female)

Pin Definition

PIN	SIGNAL	DESCRIPTION
1	Mouse DATA	Mouse DATA
2	NC	No connection
3	GND	Ground
4	VCC	+5V
5	Mouse Clock	Mouse clock
6	NC	No connection

Keyboard Connector

The mainboard provides a standard PS/2[®] keyboard mini DIN connector for attaching a PS/2[®] keyboard. You can plug a PS/2[®] keyboard directly into this connector.

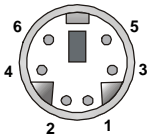

PS/2 Keyboard (6-pin Female)

Pin Definition

PIN	SIGNAL	DESCRIPTION
1	Keyboard DATA	Keyboard DATA
2	NC	No connection
3	GND	Ground
4	VCC	+5V
5	Keyboard Clock	Keyboard clock
6	NC	No connection

USB Connectors

The mainboard provides an OHCI (Open Host Controller Interface) Universal Serial Bus root for attaching USB devices such as keyboard, mouse or other USB-compatible devices. You can plug the USB device directly into the connector.

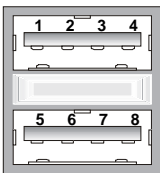

USB Ports

USB Port Description

PIN	SIGNAL	DESCRIPTION
1	VCC	+5V
2	-Data 0	Negative Data Channel 0
3	+Data0	Positive Data Channel 0
4	GND	Ground
5	VCC	+5V
6	-Data 1	Negative Data Channel 1
7	+Data 1	Positive Data Channel 1
8	GND	Ground

Parallel Port Connector: LPT1

The mainboard provides a 25-pin female centronic connector as LPT. A parallel port is a standard printer port that supports Enhanced Parallel Port (EPP) and Extended Capabilities Parallel Port (ECP) mode.

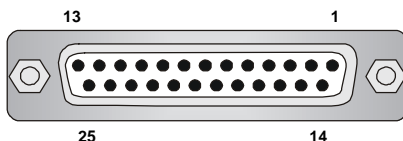

Pin Definition

PIN	SIGNAL	DESCRIPTION
1	STROBE	Strobe
2	DATA0	Data0
3	DATA1	Data1
4	DATA2	Data2
5	DATA3	Data3
6	DATA4	Data4
7	DATA5	Data5
8	DATA6	Data6
9	DATA7	Data7
10	ACK#	Acknowledge
11	BUSY	Busy
12	PE	Paper End
13	SELECT	Select
14	AUTO FEED#	Automatic Feed
15	ERR#	Error
16	INIT#	Initialize Printer
17	SLIN#	Select In
18	GND	Ground
19	GND	Ground
20	GND	Ground
21	GND	Ground
22	GND	Ground
23	GND	Ground
24	GND	Ground
25	GND	Ground

RJ-45 LAN Jack

The mainboard provides a RJ-45 connector that allows your computer to be connected to a network environment.

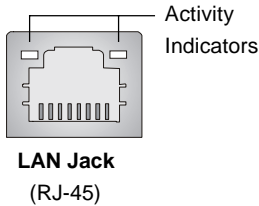

Pin	Signal	Description
1	TDP	Transmit differential pair
2	TDN	Transmit differential pair
3	RDP	Receive differential pair
4	NC	Not used
5	NC	Not used
6	RDN	Receive differential pair
7	NC	Not used
8	NC	Not used

Audio Port Connectors

Line Out is a connector for Speakers or Headphones. **Line In** is used for external CD player, Tape player, or other audio devices. **Mic** is a connector for microphones.

1/8" Stereo Audio Connectors

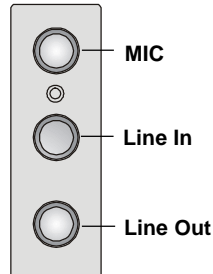

MSI Reminds You...

For advanced audio application, **RealTek ALC650 audio chip is provided as an option** to offer support for **6-channel audio operation** and can turn rear audio connectors from 2-channel to 4-/6-channel audio. For more information on **6-channel audio operation**, please refer to Appendix. Using 4- or 6-Channel Audio Function.

Serial Port Connector

The mainboard offers one 9-pin male DIN connector as the serial port. The port is a 16550A high speed communication port that sends/receives 16 bytes FIFOs. You can attach a serial mouse or other serial devices directly to the connector.

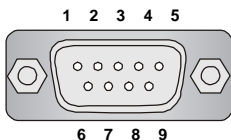

9-Pin Male DIN Connector

Pin Definition

PIN	SIGNAL	DESCRIPTION
1	DCD	Data Carry Detect
2	SIN	Serial In or Receive Data
3	SOUT	Serial Out or Transmit Data
4	DTR	Data Terminal Ready)
5	GND	Ground
6	DSR	Data Set Ready
7	RTS	Request To Send
8	CTS	Clear To Send
9	RI	Ring Indicate

Connectors

The mainboard provides connectors to connect to FDD, IDE HDD, case, modem, LAN, USB Ports, IR module and CPU/System FAN.

Floppy Disk Drive Connector: FDD1

The mainboard provides a standard floppy disk drive connector that supports 360K, 720K, 1.2M, 1.44M and 2.88M floppy disk types.

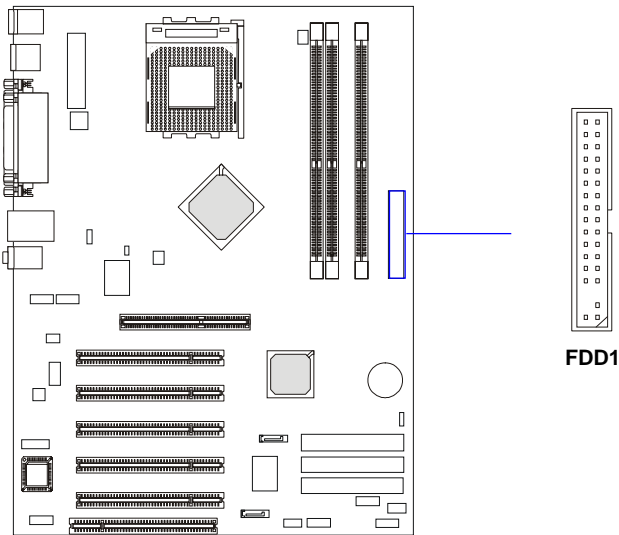

Hard Disk Connectors: IDE1 & IDE2

The mainboard has a 32-bit Enhanced PCI IDE and Ultra DMA 33/66/100/133 controller that provides PIO mode 0~4, Bus Master, and Ultra DMA 33/66/100/133 function. You can connect up to four hard disk drives, CD-ROM, 120MB Floppy (reserved for future BIOS) and other devices.

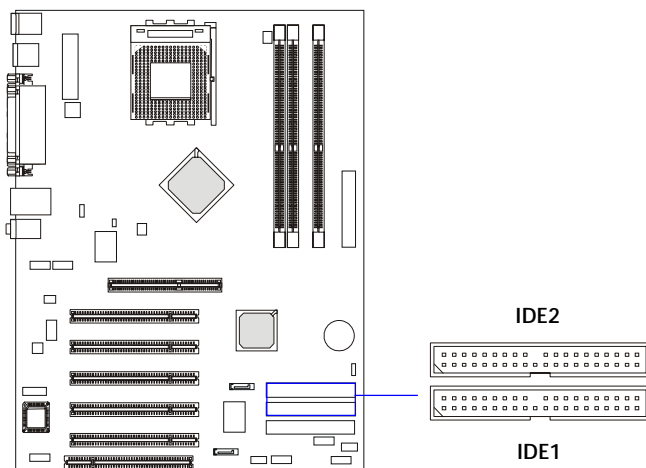

IDE1 (Primary IDE Connector)

The first hard drive should always be connected to IDE1. IDE1 can connect a Master and a Slave drive. You must configure second hard drive to Slave mode by setting the jumper accordingly.

IDE2 (Secondary IDE Connector)

IDE2 can also connect a Master and a Slave drive.



MSI Reminds You...

If you install two hard disks on cable, you must configure the second drive to Slave mode by setting its jumper. Refer to the hard disk documentation supplied by hard disk vendors for jumper setting instructions.

Fan Power Connectors: CFAN1/SFAN1

The CFAN1 (processor fan) and SFAN1 (system fan) support system cooling fan with +12V. It supports three-pin head connector. When connecting the wire to the connectors, always take note that the red wire is the positive and should be connected to the +12V, the black wire is Ground and should be connected to GND. If the mainboard has a System Hardware Monitor chipset on-board, you must use a specially designed fan with speed sensor to take advantage of the CPU fan control.

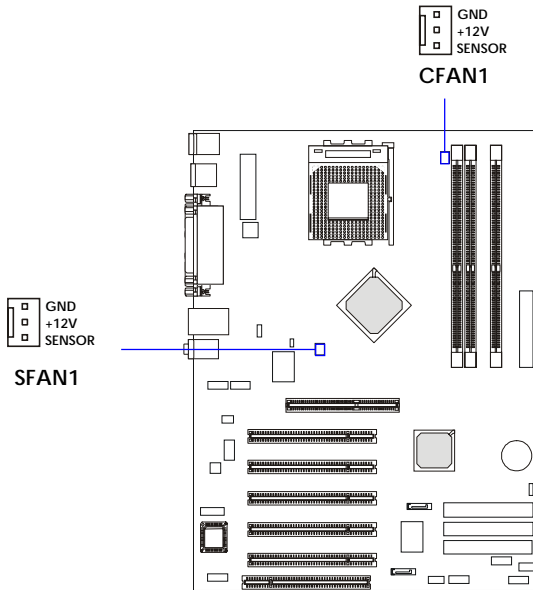

MSI Reminds You...

Always consult the vendors for proper CPU cooling fan.

Hard Disk RAID Connectors: IDE3, SER1 & SER2 (Optional)

The mainboard has 3 IDE RAID connectors, which are controlled by Promise 20376.

IDE3 is a 32-bit Enhanced PCI IDE and Ultra DMA 66/100/133 controller that provides PIO mode 0~5, Bus Master, and Ultra DMA 66/100/133 function. You can connect to 1 hard disk drive, CD-ROM, 120MB Floppy (reserved for future BIOS) and other devices.

The mainboard also provides optional dual high-speed Serial ATA interface ports, SER1 & SER2. Each supports 1st generation serial ATA data rates of 150 MB/s. Both connectors are fully compliant with Serial ATA 1.0 specifications. Each Serial ATA connector can connect to 1 hard disk device. Please refer to *Serial ATA Raid* manual for detail software installation procedure.

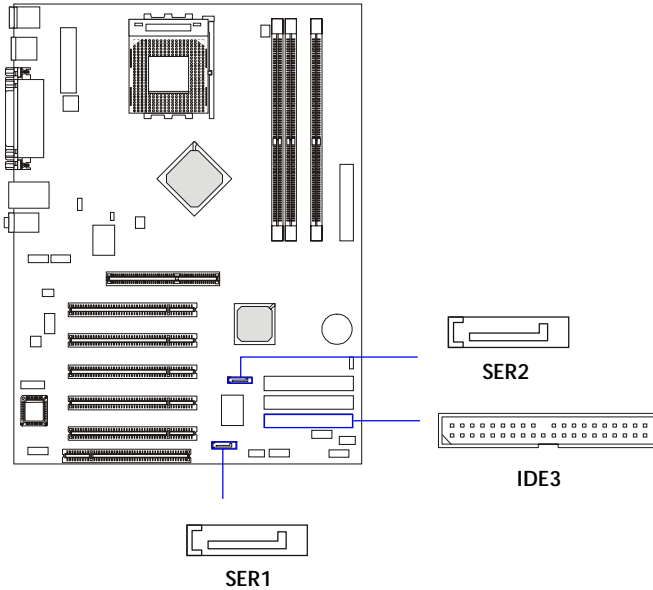

SER1 & SER2 Pin Definition

PIN	SIGNAL	PIN	SIGNAL
1	GND	2	TXP
3	TXN	4	GND
5	RXN	6	RXP
7	GND		

Optional Serial ATA cable

Take out the dust cover and connect to the hard disk devices

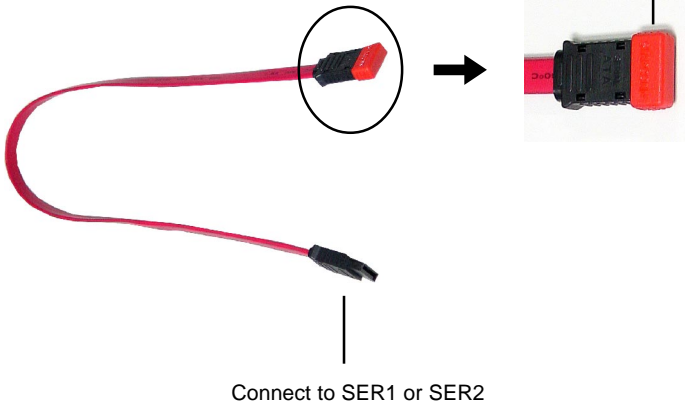

MSI Reminds You...

Please do not fold the serial ATA cable in a 90-degree angle, which will cause the loss of data during the transmission.

Front Panel Connectors: JFP1 & JFP2

The mainboard provides two front panel connectors for electrical connection to the front panel switches and LEDs. JFP1 is compliant with Intel® Front Panel I/O Connectivity Design Guide.

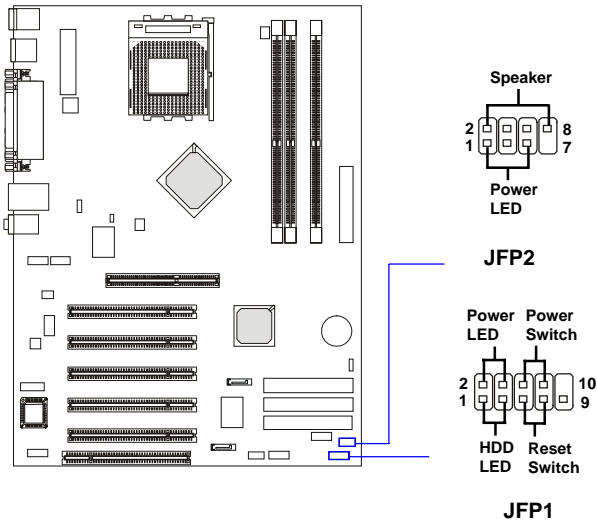

JFP1 Pin Definition

PIN	SIGNAL	DESCRIPTION
1	HD_LED_P	Hard disk LED pull-up
2	FP_PWR/SLP	MSG LED pull-up
3	HD_LED_N	Hard disk active LED
4	FP_PWR/SLP	MSG LED pull-up
5	RST_SW_N	Reset Switch low reference pull-down to GND
6	PWR_SW_P	Power Switch high reference pull-up
7	RST_SW_P	Reset Switch high reference pull-up
8	PWR_SW_N	Power Switch low reference pull-down to GND
9	RSVD_DNU	Reserved. Do not use.

JFP2 Pin Definition

PIN	SIGNAL	PIN	SIGNAL
1	GND	2	SPK-
3	SLED	4	BUZ+
5	PLED	6	BUZ-
7	NC	8	SPK+

Front Panel Audio Connector: JAUD1

The JAUD1 front panel audio connector allows you to connect to the front panel audio and is compliant with Intel® Front Panel I/O Connectivity Design Guide.

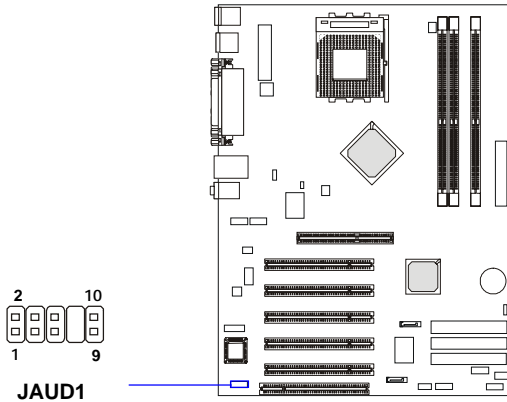

Pin Definition

PIN	SIGNAL	DESCRIPTION
1	AUD_MIC	Front panel microphone input signal
2	AUD_GND	Ground used by analog audio circuits
3	AUD_MIC_BIAS	Microphone power
4	AUD_VCC	Filtered +5V used by analog audio circuits
5	AUD_FPOUT_R	Right channel audio signal to front panel
6	AUD_RET_R	Right channel audio signal return from front panel
7	HP_ON	Reserved for future use to control headphone amplifier
8	KEY	No pin
9	AUD_FPOUT_L	Left channel audio signal to front panel
10	AUD_RET_L	Left channel audio signal return from front panel



MSI Reminds You...

If you don't want to connect to the front audio header, pins 5 & 6, 9 & 10 have to be jumpered in order to have signal output directed to the rear audio ports. Otherwise, the Line-Out connector on the back panel will not function.



Front USB Connector: JUSB2

The mainboard provides one USB 2.0 pin header *JUSB2* that is compliant with Intel® I/O Connectivity Design Guide. USB 2.0 technology increases data transfer rate up to a maximum throughput of 480Mbps, which is 40 times faster than USB 1.1, and is ideal for connecting high-speed USB interface peripherals such as **USB HDD, digital cameras, MP3 players, printers, modems and the like.**

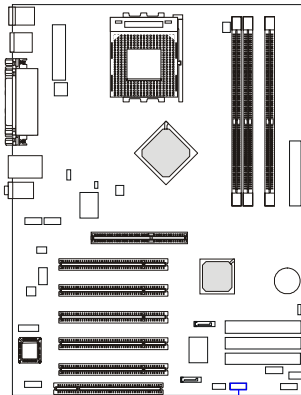

JUSB2 Pin Definition

PIN	SIGNAL	PIN	SIGNAL
1	VCC	2	VCC
3	USB0-	4	USB1-
5	USB0+	6	USB1+
7	GND	8	GND
9	Key	10	USBOC

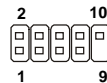

JUSB2



MSI Reminds You...

The USB 2.0 technology is downward compatible with USB 1.1 spec. To use the USB 2.0 ports, you have to install the USB 2.0 driver, which is supplied by Microsoft for Windows® 2000 and XP. If you have any problems regarding the USB 2.0 driver, please visit the Microsoft Web site for more information. For details on the bluetooth settings, please refer to PC2PC Bluetooth Manual.

Bluetooth Connector: JBT1 (Optional)

This connector is used to connect a bluetooth module for wireless connection.

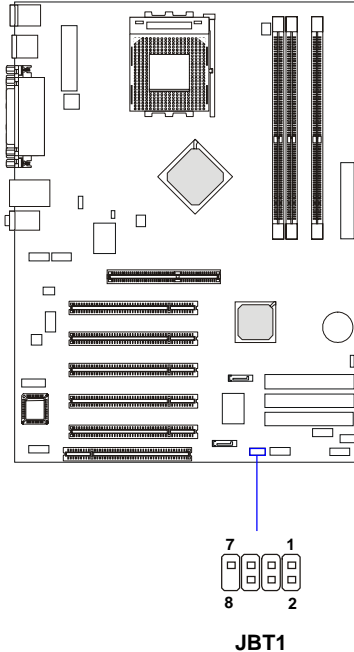

Pin Definition

PIN	SIGNAL	PIN	SIGNAL
1	5VDUAL	2	3VDUAL
3	D+ (USB signal)	4	GND
5	D- (USB signal)	6	GND
7	GND	8	NC



MSI Reminds You...

Because the bluetooth connector shares the USB interface with the onboard USB pinheader, the USB port covered by a sticker will not function when you attach a bluetooth module to this connector.

D-Bracket™ 2 Connector: JDLED1

The mainboard comes with a JDLED1 connector for you to connect to D-Bracket™ 2. D-Bracket™ 2 is a USB Bracket that supports both USB 1.1 & 2.0 spec. It integrates four LEDs and allows users to identify system problem through 16 various combinations of LED signals. For definitions of 16 signal combinations, please refer to *D-Bracket™ 2 (Optional)* in Chapter 1.

Pin Definition

Pin	Signal
1	DBG1 (high for green color)
2	DBR1 (high for red color)
3	DBG2 (high for green color)
4	DBR2 (high for red color)
5	DBG3 (high for green color)
6	DBR3 (high for red color)
7	DBG4 (high for green color)
8	DBR4 (high for red color)
9	Key
10	NC

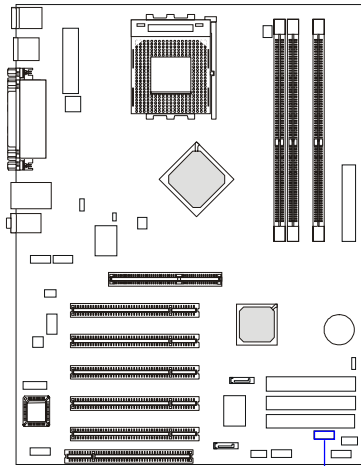

Connected to JDLED1
 Connected to JUSB2

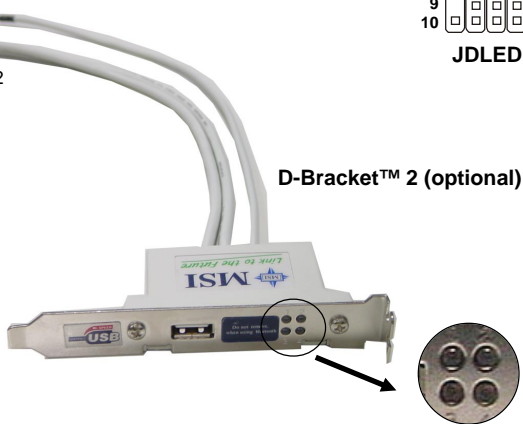

LEDs

CD-In Connector: JCD

The connector is for CD-ROM audio connector.

S-Bracket Connector: JSP2

The connector allows you to connect a S-Bracket for Sony & Philips Digital Interface (SPDIF). The S-Bracket offers 2 SPDIF jacks for digital audio transmission (one for optical fiber connection and the other for coaxial), and 2 analog Line-Out jacks for 4-channel audio output.

To attach the fiber-optic cable to optical SPDIF jack, you need to remove the plug from the jack first. The two SPDIF jacks support *SPDIF output* only. For more information on the S-Bracket, refer to *Appendix. Using 4- or 6-Channel Audio Function*.

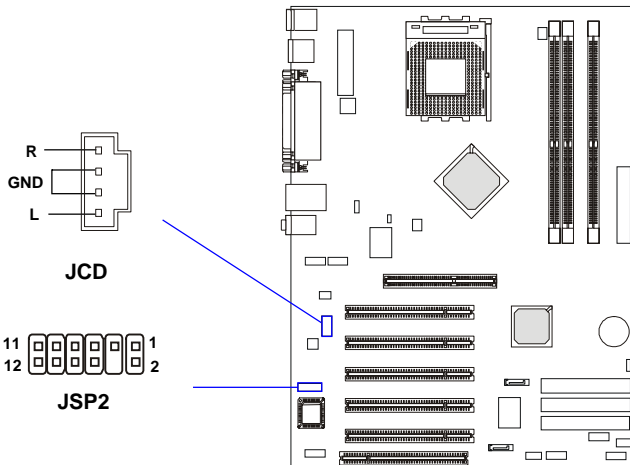

JSP2 Pin Definition

PIN	SIGNAL	DESCRIPTION	PIN	SIGNAL	DESCRIPTION
1	VCC5	VCC 5V	2	VDD3	VDD 3.3V
3	SPDFO	S/PDIF output	4	(No Pin)	Key
5	GND	Ground	6	SPDFI	S/PDIF input
7	LFE-OUT	Audio bass output	8	SOUT-R	Audio right surrounding output
9	CET-OUT	Audio center output	10	SOUT-L	Audio left surrounding output
11	GND	Ground	12	GND	Ground

Optional S-Bracket

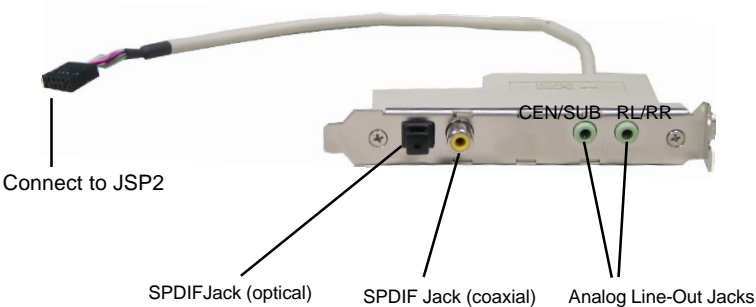

IEEE 1394 Connectors: J1394_1 & J1394_2 (Optional)

The mainboard provides two 1394 pin headers that allow you to connect IEEE 1394 ports via an external IEEE1394 bracket (optional).

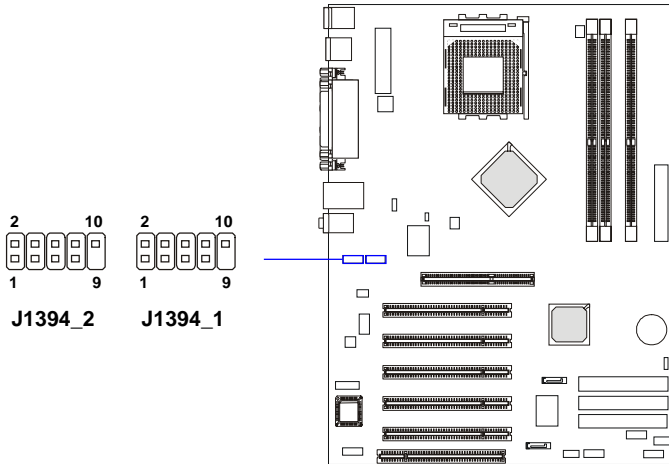

Pin Definition

PIN	SIGNAL	PIN	SIGNAL
1	TPA+	2	TPA-
3	Ground	4	Ground
5	TPB+	6	TPB-
7	Cable power	8	Cable power
9	Key (no pin)	10	Ground

How to attach the IEEE 1394 Port:

1. Take out the IEEE 1394 Bracket.



2. Locate the IEEE 1394 connectors (J1394_1, J1394_2) on the mainboard.

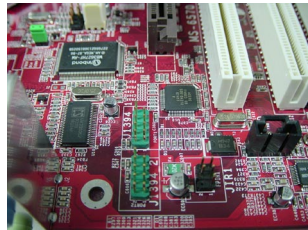

3. Connect the IEEE1394 Bracket to the connectors. Align the foolproof design with the pin layout of the connector to avoid mis-inserting.

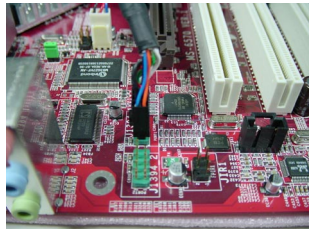

4. Place the IEEE 1394 Bracket into the first slot of your system case.

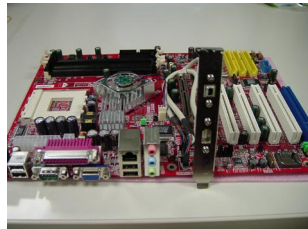

IrDA Infrared Module Header: JIR1

The connector allows you to connect to IrDA Infrared module. You must configure the setting through the BIOS setup to use the IR function. JIR1 is compliant with Intel® Front Panel I/O Connectivity Design Guide.

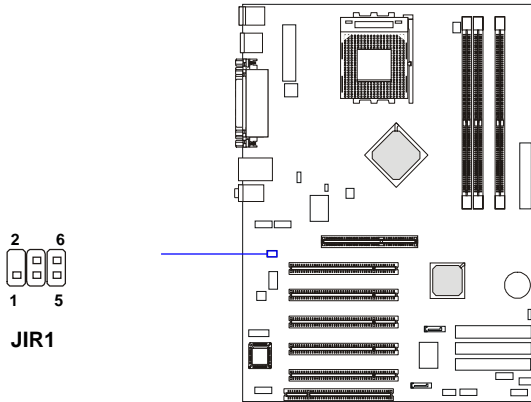

Pin Definition

Pin	Signal
1	NC
2	NC
3	VCC5
4	GND
5	IRTX
6	IRRX

Jumpers

The motherboard provides the following jumpers for you to set the computer's function. This section will explain how to change your motherboard's function through the use of jumpers.

Clear CMOS Jumper: JBAT1

There is a CMOS RAM on board that has a power supply from external battery to keep the data of system configuration. With the CMOS RAM, the system can automatically boot OS every time it is turned on. If you want to clear the system configuration, use the JBAT1 (Clear CMOS Jumper) to clear data. Follow the instructions below to clear the data:

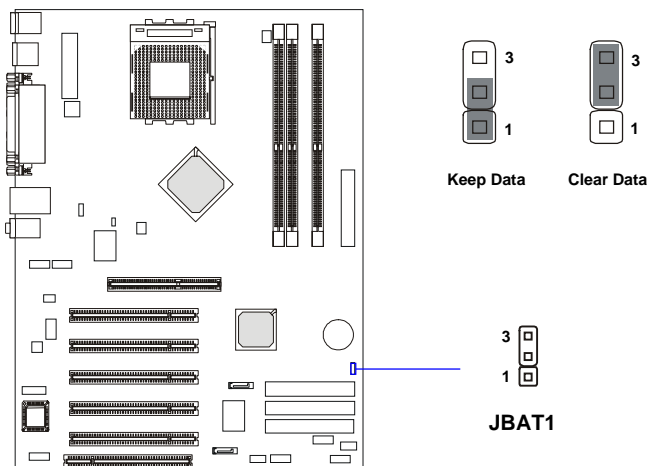

MSI Reminds You...

You can clear CMOS by shorting 2-3 pin while the system is off. Then return to 1-2 pin position. Avoid clearing the CMOS while the system is on; it will damage the mainboard.

FSB Mode Jumper: J10

This jumper allows you to set the CPU FSB mode.

CPU FSB Frequency Jumper: J11

This jumper is used to specify the CPU FSB (Front Side Bus) frequency. Leave the jumper short connected if a 133/166MHz FSB CPU is installed. If the CPU supports 100MHz FSB, leave the jumper open connected. To use a 200MHz FSB CPU, set the jumper short connected and enter the BIOS Setup Utility to adjust the CPU FSB Clock Frequency (see p. 3-12).

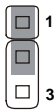
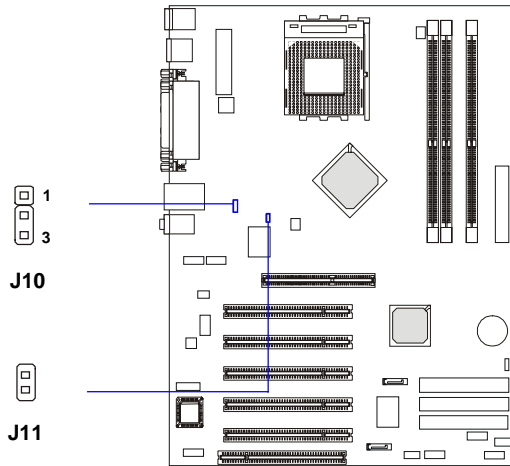

User mode
(default)
133 MHz



Safe mode
100 MHz



open
100MHz



Short
133/166MHz



MSI Reminds You...

If your computer hang while overclocking, please reset J10 to safe mode and reboot. After rebooting, enter BIOS Setup menu to reload the BIOS Setup Defaults and reset J10 to user mode.

Slots

The motherboard provides one AGP slot, five 32-bit PCI bus slots, and one ACR slot.

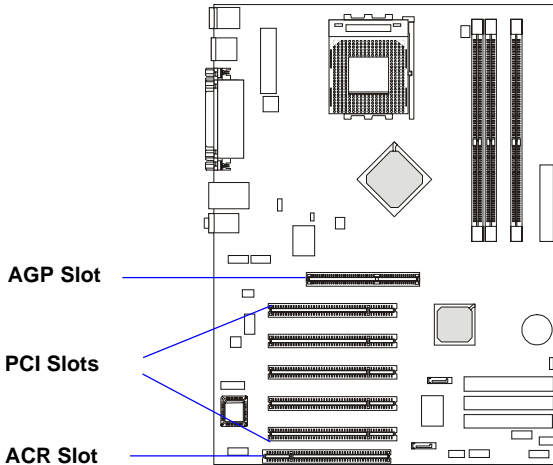

AGP (Accelerated Graphics Port) Slot

The AGP slot allows you to insert the AGP graphics card. AGP is an interface specification designed for the throughput demands of 3D graphics. It introduces a 66MHz, 32-bit channel for the graphics controller to directly access main memory. The mainboard supports 4x/8x 1.5V AGP card.

PCI (Peripheral Component Interconnect) Slots

The PCI slots allow you to insert the expansion cards to meet your needs. When adding or removing expansion cards, make sure that you unplug the power supply first. Meanwhile, read the documentation for the expansion card to make any necessary hardware or software settings for the expansion card, such as jumpers, switches or BIOS configuration.

ACR (Advanced Communication Riser) Slot

The ACR slot allows you to insert the ACR expansion cards. The ACR specification supports modem, audio, Local Area Network (LAN), and Digital Subscriber Line (DSL). The ACR interface combines existing communications buses, and introduces new and advanced communications buses answering industry demand for low-cost, high-performance communications peripherals.

PCI Interrupt Request Routing

The IRQ, acronym of interrupt request line and pronounced I-R-Q, are hardware lines over which devices can send interrupt signals to the microprocessor.

The PCI IRQ pins are typically connected to the PCI bus PIRQ A# ~ PIRQ D# pins as follows:

	Order 1	Order 2	Order 3	Order 4
PCI Slot 1	PIRQ D#	PIRQ A#	PIRQ B#	PIRQ C#
PCI Slot 2	PIRQ A#	PIRQ B#	PIRQ C#	PIRQ D#
PCI Slot 3	PIRQ B#	PIRQ C#	PIRQ D#	PIRQ A#
PCI Slot 4	PIRQ D#	PIRQ A#	PIRQ B#	PIRQ C#
PCI Slot 5	PIRQ D#	PIRQ A#	PIRQ B#	PIRQ C#
AGP	PIRQ D#			
Onboard Serial ATA	PIRQ C#			

3

BIOS Setup

This chapter provides information on the BIOS Setup program and allows you to configure the system for optimum use. You may need to run the Setup program when:

- ◆ An error message appears on the screen during the system booting up, and requests you to run SETUP.
- ◆ You want to change the default settings for customized features.

Entering Setup

Power on the computer and the system will start POST (Power On Self Test) process. When the message below appears on the screen, press key to enter Setup.

Press DEL to enter SETUP

If the message disappears before you respond and you still wish to enter Setup, restart the system by turning it OFF and On or pressing the RESET button. You may also restart the system by simultaneously pressing <Ctrl>, <Alt>, and <Delete> keys.

Control Keys

<↑>	Move to the previous item
<↓>	Move to the next item
<←>	Move to the item in the left hand
<→>	Move to the item in the right hand
<Enter>	Select the item
<Esc>	Jumps to the Exit menu or returns to the main menu from a submenu
<+/PU>	Increase the numeric value or make changes
<-/PD>	Decrease the numeric value or make changes
<F1>	General help, only for Status Page Setup Menu and Option Page Setup Menu
<F5>	Restore the previous CMOS value from CMOS, only for Option Page Setup Menu
<F6>	Load the default CMOS value from Fail-Safe default table, only for Option Page Setup Menu
<F7>	Load Optimized defaults
<F10>	Save all the CMOS changes and exit

Getting Help

After entering the Setup menu, the first menu you will see is the Main Menu.

Main Menu

The main menu lists the setup functions you can make changes to. You can use the control keys ($\uparrow\downarrow$) to select the item. The on-line description of the highlighted setup function is displayed at the bottom of the screen.

Sub-Menu

If you find a right pointer symbol (as shown in the right view) appears to the left of certain fields that means a sub-menu containing additional options can be launched from this field. You can use control keys ($\uparrow\downarrow$) to highlight the field and press <Enter> to call up the sub-menu. Then you can use the control keys to enter values and move from field to field within a sub-menu. If you want to return to the main menu, just press <Esc >.

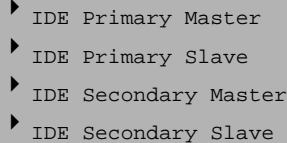
- 
- ▶ IDE Primary Master
 - ▶ IDE Primary Slave
 - ▶ IDE Secondary Master
 - ▶ IDE Secondary Slave

General Help <F1>

The BIOS setup program provides a General Help screen. You can call up this screen from any menu by simply pressing <F1>. The Help screen lists the appropriate keys to use and the possible selections for the highlighted item. Press <Esc> to exit the Help screen.



MSI Reminds You...

The items under each BIOS category described in this chapter are under continuous update for better system performance. Therefore, the description may be slightly different from the latest BIOS and should be held for reference only.

The Main Menu

Once you enter Phoenix-Award® BIOS CMOS Setup Utility, the Main Menu (Figure 1) will appear on the screen. The Main Menu allows you to select from twelve setup functions and two exit choices. Use arrow keys to select among the items and press <Enter> to accept or enter the sub-menu.



Standard CMOS Features

Use this menu for basic system configurations, such as time, date etc.

Advanced BIOS Features

Use this menu to setup the items of AWARD® special enhanced features.

Advanced Chipset Features

Use this menu to change the values in the chipset registers and optimize your system's performance.

Integrated Peripherals

Use this menu to specify your settings for integrated peripherals.

Power Management Setup

Use this menu to specify your settings for power management.

PNP/PCI Configurations

This entry appears if your system supports PnP/PCI.

PC Health Status

This entry shows your PC health status.

Frequency/Voltage Control

Use this menu to specify your settings for frequency/voltage control.

Load High Performance Defaults

Use this menu to load the BIOS values for the best system performance, but the system stability may be affected.

Load BIOS Setup Defaults

Use this menu to load factory default settings into the BIOS for stable system performance operations.

Set Supervisor Password

Use this menu to set Supervisor Password.

Set User Password

Use this menu to set User Password.

Save & Exit Setup

Save changes to CMOS and exit setup.

Exit Without Saving

Abandon all changes and exit setup.

Standard CMOS Features

The items in Standard CMOS Features Menu are divided into 11 categories. Each category includes no, one or more than one setup items. Use the arrow keys to highlight the item and then use the <PgUp> or <PgDn> keys to select the value you want in each item.



Date

This allows you to set the system to the date that you want (usually the current date). The format is <day><month> <date> <year>.

- day** Day of the week, from Sun to Sat, determined by BIOS. Read-only.
- month** The month from Jan. through Dec.
- date** The date from 1 to 31 can be keyed by numeric function keys.
- year** The year can be adjusted by users.

Time

This allows you to set the system time that you want (usually the current time). The time format is <hour> <minute> <second>.

IDE Primary/Secondary Master/Slave

Press PgUp/<+> or PgDn/<-> to select *Manual*, *None* or *Auto* type. Note that the specifications of your drive must match with the drive table. The hard disk will not work properly if you enter improper information for this category.

If your hard disk drive type is not matched or listed, you can use *Manual* to define your own drive type manually.

If you select *Manual*, related information is asked to be entered to the following items. Enter the information directly from the keyboard. This information should be provided in the documentation from your hard disk vendor or the system manufacturer.

Access Mode	The settings are CHS, LBA, Large, Auto.
Capacity	The formatted size of the storage device.
Cylinder	Number of cylinders.
Head	Number of heads.
Precomp	Write precompensation.
Landing Zone	Cylinder location of the landing zone.
Sector	Number of sectors.

Drive A:/B:

This item allows you to set the type of floppy drives installed. Available options: *None, 360K, 5.25 in., 1.2M, 5.25 in., 720K, 3.5 in., 1.44M, 3.5 in., 2.88M, 3.5 in.*

Video

The setting controls the type of video adapter used for the primary monitor of the system. Available options are *EGA/VGA , CGA 40, CGA 80* and *Mono*.

Halt On

The setting determines whether the system will stop if an error is detected at boot. Available options are:

<i>All Errors</i>	The system stops when any error is detected.
<i>No Errors</i>	The system doesn't stop for any detected error.
<i>All, But Keyboard</i>	The system doesn't stop for a keyboard error.
<i>All, But Diskette</i>	The system doesn't stop for a disk error.
<i>All, But Disk/Key</i>	The system doesn't stop for either a disk or a keyboard error.

CPU Type/BIOS Version/System Memory/Total Memory

The items show the CPU type, BIOS version and memory status of your system (read only).

Advanced BIOS Features



Anti-Virus Protection

The item is to set the Virus Warning feature for IDE Hard Disk boot sector protection. If the function is enabled and any attempt to write data into this area is made, BIOS will display a warning message on screen and beep. Settings: *Disabled* and *Enabled*.

External Cache

The item allows you to turn on or off CPU's external (L2)cache. Settings: *Enabled* and *Disabled*.

Quick Boot

Setting the item to *Enabled* allows the system to boot within 5 seconds since it will skip some check items. Available options: *Enabled*, *Disabled*.

1st/2nd/3rd Boot Device

The items allow you to set the sequence of boot devices where BIOS attempts to load the disk operating system. The settings are:

<i>Floppy</i>	The system will boot from floppy drive.
<i>LS120</i>	The system will boot from LS-120 drive.
<i>HDD-0</i>	The system will boot from the first HDD.
<i>SCSI</i>	The system will boot from the SCSI.
<i>CDROM</i>	The system will boot from the CD-ROM.

<i>HDD-1</i>	The system will boot from the second HDD.
<i>HDD-2</i>	The system will boot from the third HDD.
<i>HDD-3</i>	The system will boot from the fourth HDD.
<i>ZIP100</i>	The system will boot from ATAPI ZIP drive.
<i>USB-FDD</i>	The system will boot from the USB FDD.
<i>USB-ZIP</i>	The system will boot from the USB ZIP drive.
<i>USB-CDROM</i>	The system will boot from the USB CD-ROM.
<i>USB-HDD</i>	The system will boot from the USB HDD.
<i>LAN</i>	The system will boot from the Network drive.
<i>Disabled</i>	Disable this sequence.

Boot Other Device

Setting the option to *Enabled* allows the system to try to boot from other device if the system fails to boot from the 1st/2nd/3rd boot device.

Swap Floppy

Setting to *Enabled* will swap floppy drives A: and B:.

Seek Floppy

Setting to *Enabled* will make BIOS seek floppy drive A: before booting the system. Settings: *Disabled, Enabled*.

Boot Up Num-Lock LED

This setting is to set the Num Lock status when the system is powered on. Setting to *On* will turn on the Num Lock key when the system is powered on. Setting to *Off* will allow users to use the arrow keys on the numeric keypad. Setting options: *On, Off*.

Gate A20 Option

This item is to set the Gate A20 status. A20 refers to the first 64KB of extended memory. When the default value *Fast* is selected, the Gate A20 is controlled by Port92 or chipset specific method resulting in faster system performance. When *Normal* is selected, A20 is controlled by a keyboard controller or chipset hardware.

Typematic Rate Setting

This item is used to enable or disable the typematic rate setting including Typematic Rate & Typematic Delay.

Typematic Rate (Chars/Sec)

After *Typematic Rate Setting* is enabled, this item allows you to set the rate (characters/second) at which the keys are accelerated. Settings: *6, 8, 10, 12, 15, 20, 24* and *30*.

Typematic Delay (Msec)

This item allows you to select the delay between when the key was first pressed and when the acceleration begins. Settings: *250, 500, 750* and *1000*.

Security Option

This specifies the type of BIOS password protection that is implemented. Settings are described below:

Option	Description
<i>Setup</i>	The password prompt appears only when end users try to run Setup.
<i>System</i>	A password prompt appears every time when the computer is powered on or when end users try to run Setup.

APIC Function

This field is used to enable or disable the APIC (Advanced Programmable Interrupt Controller). Due to compliance with PC2001 design guide, the system is able to run in APIC mode. Enabling APIC mode will expand available IRQ resources for the system. Settings: *Enabled* and *Disabled*.

MPS Table Version

This field allows you to select which MPS (Multi-Processor Specification) version to be used for the operating system. You need to select the MPS version supported by your operating system. To find out which version to use, consult the vendor of your operating system. Settings: *1.4, 1.1*.

Boot OS/2 for DRAM > 64MB

This allows you to run the OS/2® operating system with DRAM larger than 64MB. When you choose *No*, you cannot run the OS/2® operating system with DRAM larger than 64MB. But it is possible if you choose *Yes*.

Hard Disk S.M.A.R.T.

This allows you to activate the S.M.A.R.T. (Self-Monitoring Analysis & Reporting Technology) capability for the hard disks. S.M.A.R.T is a utility that

monitors your disk status to predict hard disk failure. This gives you an opportunity to move data from a hard disk that is going to fail to a safe place before the hard disk becomes offline. Settings: *Enabled* and *Disabled*.

Video BIOS Cacheable

Selecting *Enabled* allows caching of the video BIOS ROM at C0000h to C7FFFh, resulting in better video performance. However, if any program writes to this memory area, a system error may result. Setting options: *Disabled, Enabled*.

Advanced Chipset Features

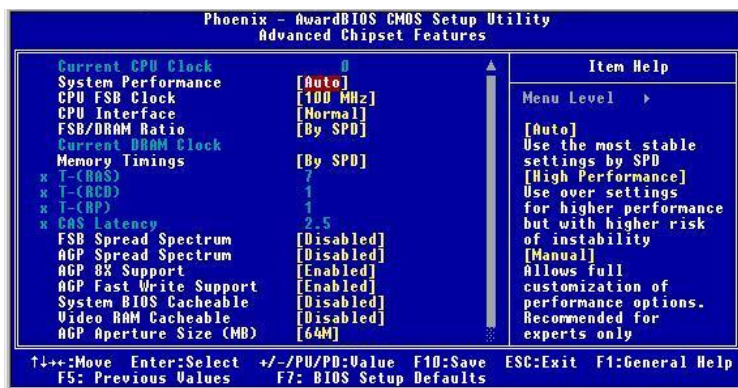

MSI Reminds You...

Change these settings only if you are familiar with the chipset.

Current CPU Clock

It shows the current clock frequency of the CPU. (read only)

System Performance

This field allows users to control the status of system performance. Users may select [Auto] for the most stable settings by SPD. [High Performance] will increase the system performance but may have instability problems. [Manual] allows full customization of performance options, and is recommended for experts only. Settings: *Auto, High Performance, Manual.*

CPU FSB Clock

This setting allows you to select the CPU Front Side Bus clock frequency. Settings: *100~200MHz at 1 MHz increment.*

CPU Interface

This setting allows you to select the CPU/FSB parameters. Settings: *Normal, High Performance.* When [High Performance] is selected, the system will use overclocked CPU/FSB parameters. Select [Normal] for normal mode CPU/FSB parameters.

FSB/DRAM Ratio

This setting controls the ratio of CPU FSB clock & DRAM Frequency to enable the CPU & DRAM to run at different frequency combinations.

Please note that the setting options vary according to the CPU FSB clock preset. Options: *By SPD, 2:1, 5:3, 3:2, 4:3, 5:4, 6:5, 1:1, 5:6, 4:5, 3:4, 2:3, 3:5, 1:2.*

Current DRAM Clock

It shows the clock frequency of the installed DRAMs. (read only)

Memory Timing

Selects whether DRAM timing is controlled by the SPD (Serial Presence Detect) EEPROM on the DRAM module. Setting to *By SPD* enables DRAM timings to be determined by BIOS based on the configurations on the SPD. Selecting *Manual* allows users to configure the DRAM timings manually. Options: *By SPD, Manual, High Performance.*

T-(RAS)

This setting controls the number of clock cycles for DRAM to be allowed to precharge from the active state. Settings: *1 through 15.*

T-(RCD)

When DRAM is refreshed, both rows and columns are addressed separately. This setup item allows you to determine the timing of the transition from RAS (row address strobe) to CAS (column address strobe). The less the clock cycles, the faster the DRAM performance. Setting options: *1 through 7.*

T-(RP)

This item controls the number of cycles for Row Address Strobe (RAS) to be allowed to precharge. If insufficient time is allowed for the RAS to accumulate its charge before DRAM refresh, refresh may be incomplete and DRAM may fail to retain data. This item applies only when synchronous DRAM is installed in the system. Available settings: *1 through 7.*

CAS Latency

The field controls the CAS latency, which determines the timing delay before RAM starts a read command after receiving it. Setting options are: 2, 2.5, and 3. 2T increases system performance while 3T provides more stable system performance.

FSB Spread Spectrum

This item is used to enable or disable the FSB clock generator's Spread Spectrum feature. When overclocking the FSB, always set it to *Disabled*. Options: *Disabled, 0.50%, 1.00%*.

AGP Spread Spectrum

This item is used to enable or disable the AGP clock generator's Spread Spectrum feature. When overclocking the AGP slot, always set it to *Disabled*. Options: *Disabled, 0.50%, 1.00%*.

AGP 8x Support

This item is used to control the functionality of the AGP 3.0 8x interface. Options: *Disabled, Enabled*. Select Enabled only when your card supports this function.

AGP Fast Write Support

The item enables or disables the AGP Fast Write feature. The Fast Write technology allows CPU to write directly into the graphics controller without passing anything through system memory and improves 8x speed accordingly. Select Enabled only when your AGP card supports the feature. Options: *Disabled, Enabled*.

System BIOS Cacheable

Selecting *Enabled* allows caching of the system BIOS ROM at F0000h-FFFFFh, resulting in better system performance. However, if any program writes to this memory area, a system error may result. Setting options: *Enabled, Disabled*.

Video RAM Cacheable

Selecting *Enabled* allows caching of the video memory (RAM) at A0000h to AFFFFh, resulting in better video performance. However, if any program writes to this memory area, a memory access error may result. Setting options: *Disabled, Enabled*.

AGP Aperture Size

This setting controls just how much system RAM can be allocated to AGP for video purposes. The aperture is a portion of the PCI memory address range dedicated to graphics memory address space. Host cycles that hit the aperture

range are forwarded to the AGP without any translation. The option allows the selection of an aperture size of *32MB*, *64MB*, *128MB*, *256MB* and *512MB*.

Integrated Peripherals

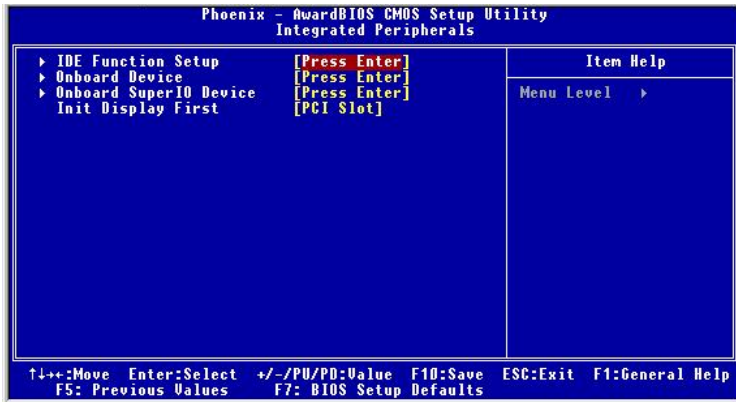

IDE Function Setup

Press <Enter> to enter the sub-menu and the following screen appears:

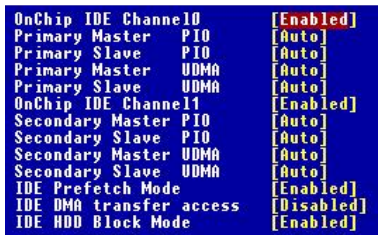

OnChip IDE Channel 0/1

The integrated peripheral controller contains an IDE interface with support for two IDE channels. Choose [Enabled] to activate each channel separately. Settings: *Enabled, Disabled*.

IDE Primary/Secondary Master/Slave PIO

The four IDE PIO (Programmed Input/Output) fields let you set a PIO mode (0-4) for each of the four IDE devices that the onboard IDE interface supports. Modes 0 through 4 provide successively increased performance. In Auto mode, the system automatically determines the best mode for each device. The settings are: *Auto, Mode 0, Mode 1, Mode 2, Mode 3, Mode 4*.

Primary/Secondary Master/Slave UltraDMA

Ultra DMA/33 implementation is possible only if your IDE hard drive supports it and the operating environment includes a DMA driver (Windows 95 OSR2 or a third-party IDE bus master driver). If your hard drive and your system software both support Ultra DMA/33, Ultra DMA/66 and Ultra DMA/100 select Auto to enable BIOS support. The settings are: *Auto, Disabled*.

IDE Prefetch Mode

The onboard IDE drive interfaces support IDE prefetching, for faster drive accesses. When you install a primary and/or secondary add-in IDE interface, set this option to *Disabled* if the interface does not support prefetching.

IDE DMA Transfer Access

This item is used to enable or disable the DMA transfer function of the IDE Hard Drive. The settings are: *Enabled, Disabled*.

IDE HDD Block Mode

Block mode is also called block transfer, multiple commands, or multiple sector read/write. If your IDE hard drive supports block mode (most new drives do), select Enabled for automatic detection of the optimal number of block read/writes per sector the drive can support. Settings: *Enabled, Disabled*.

Onboard Device

Press <Enter> to enter the sub-menu and the following screen appears:

```

AC97 Audio           [Auto]
MC97 Modem          [Auto]
OnChip USB           [U1.1+U2.0]
USB Keyboard Support [Disabled]
OnChip 1394          [Auto]
OnChip Lan(nVIDIA)  [Auto]
MAC Address (nVIDIA) [Disabled]
x MAC Address Input (nVIDIA) Press Enter

```

AC97 Audio

Auto allows the mainboard to detect whether an audio device is used. If an audio device is detected, the onboard AC'97 (Audio Codec'97) controller will be enabled; if not, it is disabled. Disable the controller if you want to use other controller cards to connect an audio device. Settings: *Auto, Disabled*.

MC97 Modem

Auto allows the mainboard to detect whether a modem is used. If a modem is detected, the onboard MC'97 modem controller will be enabled; if not, it is disabled. Disable the controller if you want to use other controller cards to connect a modem. Settings: *Auto, Disabled*.

OnChip USB

This setting allows you to enable/disable the onboard USB controller. Selecting [V1.1+V2.0] enables the system to support both USB 1.1 and 2.0 spec. Setting options: *Disabled, V1.1, V1.1+V2.0*.

USB Keyboard Support

Select *Enabled* if you need to use a USB-interfaced keyboard in the operating system. Setting options: *Enabled, Disabled*.

OnChip 1394

This item allows you to enable/disable the onboard IEEE1394 controller. Setting options: *Auto* and *Disabled*.

OnChip Lan (nVIDIA)

Setting to [Auto] allows the BIOS to auto-detect the nVIDIA LAN controller and enable it. Setting options: *Auto* and *Disabled*.

MAC Address (nVIDIA)

Setting to [Enabled] allows users to manually update the MAC address under **MAC (NV) Address Input**. Setting options: *Enabled* and *Disabled*.

MAC Address Input (nVIDIA)

Users can key in the MAC (NV) address in this field.

Onboard Super IO Device

Press <Enter> to enter the sub-menu and the following screen appears:

```
Onboard FDC Controller      [Enabled]
Onboard Serial Port        [3F8/IRQ4]
UART Mode Select           [Normal]
Rx0 , Tx0 Active           [Hi,Lo]
IR Transmission Delay      [Enabled]
USB Duplex Mode            [Half]
Use IR Pins                 [IR-Rx2Tx2]
Onboard Parallel Port      [378/IRQ7]
Parallel Port Mode         [SPP]
EPP Mode Select            [EPP1.7]
ECP Mode Use DMA          [3]
```

Onboard FDC Controller

Select Enabled if your system has a floppy disk controller (FDD) installed on the system board and you wish to use it. If you install add-on FDC or the system has no floppy drive, select Disabled in this field. The settings are: *Enabled* and *Disabled*.

Onboard Serial Port

Select an address and corresponding interrupt for the first and second serial ports. The settings are: *3F8/IRQ4*, *2E8/IRQ3*, *3E8/IRQ4*, *2F8/IRQ3*, *Disabled*, *Auto*.

UART Mode Select

This setting allows you to specify the operation mode for serial port 2. Setting options: *IrDA*, *ASKIR*, *Normal*.

<i>Normal</i>	RS-232C Serial Port
<i>IrDA</i>	IrDA-compliant Serial Infrared Port
<i>ASKIR</i>	Amplitude Shift Keyed Infrared Port

RxD, TxD Active

This setting controls the receiving and transmitting speed of the IR peripheral in use. Setting options: *Hi/Hi*, *Hi/Lo*, *Lo/Hi*, *Lo/Lo*.

IR Transmission Delay

This setting determines whether the IR transmission rate will be delayed while converting to receiving mode. Setting options: *Disabled*, *Enabled*.

UR2 Duplex Mode

This setting controls the operating mode of IR transmission/reception. Setting options: *Full*, *Half*. Under Full Duplex mode, synchronous, bi-directional transmission/reception is allowed. Under Half Duplex mode, only asynchronous, bi-directional transmission/reception is allowed.

Use IR Pins

Please consult your IR peripheral documentation to select the correct setting of the TxD and RxD signals. Setting options: *RxD2/TxD2*, *IR-Rx2Tx2*.

Onboard Parallel Port

There is a built-in parallel port on the on-board Super I/O chipset that provides Standard, ECP, and EPP features. It has the following options:

Disabled

3BC/IRQ7 Line Printer port 0

278/IRQ5 Line Printer port 2

378/IRQ7 Line Printer port 1

Parallel Port Mode

SPP : Standard Parallel Port

EPP : Enhanced Parallel Port

ECP : Extended Capability Port

ECP + EPP: Extended Capability Port + Enhanced Parallel Port

SPP/EPP/ECP/ECP+EPP

To operate the onboard parallel port as Standard Parallel Port only, choose "SPP." To operate the onboard parallel port in the EPP mode simultaneously, choose "EPP." By choosing "ECP", the onboard parallel port will operate in ECP mode only. Choosing "ECP + EPP" will allow the onboard parallel port to support both the ECP and EPP modes simultaneously.

EPP Mode Select

The onboard parallel port is EPP Spec. compliant, so after the user chooses the onboard parallel port with the EPP function, the following message will be displayed on the screen: "EPP Mode Select." At this time either *EPP 1.7 spec* or *EPP 1.9 spec* can be chosen.

ECP Mode Use DMA

The ECP mode has to use the DMA channel, so choose the onboard parallel port with the ECP feature. After selecting it, the following message will appear: "ECP Mode Use DMA." At this time, the user can choose between DMA channel 3 or 1.

Init Display First

This item specifies which VGA card is your primary graphics adapter. Settings: *PCI Slot* and *AGP Slot*.

Power Management Setup

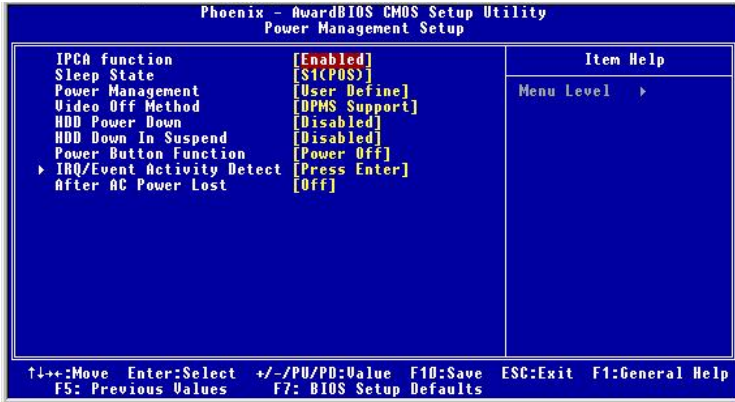

MSI Reminds You...

S3-related functions described in this section are available only when your BIOS supports S3 sleep mode.

IPCA Function

This item is to activate the ACPI (Advanced Configuration and Power Management Interface) function. If your operating system is ACPI-aware, such as Windows 98SE/2000/ME, select *Enabled*. Available options: *Enabled*, *Disabled*.

Sleep State

This item specifies the power saving modes for ACPI function. If your operating system supports ACPI, such as Windows 98SE, Windows ME and Windows 2000, you can choose to enter the Standby mode in S1(POS) or S3 (STR) fashion through the setting of this field. Options are:

- S1/POS** The S1 sleep mode is a low power state. In this state, no system context is lost (CPU or chipset) and hardware maintains all system context.
- S3/STR** The S3 sleep mode is a lower power state where the information of system configuration and open applications/files is saved to main memory that remains powered

Auto while most other hardware components turn off to save energy. The information stored in memory will be used to restore the system when a “wake up” event occurs. The system will decide when to enter S1 or S3 state.

Power Management

This item is used to select the degree (or type) of power saving and is related to these modes: *Suspend Mode* and *HDD Power Down*. There are three options for power management:

- Min Saving* Minimum Power Management. Suspend Mode=1 Hour
- Max Saving* Maximum Power Management. Suspend Mode=1 Min
- User Define* Allows end users to configure each mode separately.

Video Off Method

This determines the manner in which the monitor is blanked.

- V/H SYNC+Blank* This selection will cause the system to turn off the vertical and horizontal synchronization ports and write blanks to the video buffer.
- Blank Screen* This option only writes blanks to the video buffer.
- DPMS Support* Initial display power management signaling

HDD Power Down

If HDD activity is not detected for the length of time specified in this field, the hard disk drive will be powered down while all other devices remain active. Settings are *Disabled* and *1 through 15 Min*.

HDD Down In Suspend

This item determines whether the hard disk drive will be turned off during suspend mode. Settings: *Disabled* and *Enabled*.

Power Button Function

This feature sets the function of the power button. Settings are:

- Power Off* The power button functions as normal power off button.
- Suspend* When you press the power button, the computer enters the suspend/sleep mode, but if the button is pressed for more than four seconds, the computer is turned off.

IRQ/Event Activity Detect

Press <Enter> and the following sub-menu appears.

```

PowerOn by PCI card [Disabled]
USB Resume from S3 [Disabled]
RTC Resume [Disabled]
x Time(hh:mm:ss) Alarm 0 : 0 : 0
> IRQs Activity Monitoring [Press Enter]

```

PowerOn by PCI card

This item specifies whether the system will be awakened from power saving modes (S1, S3, S4) when activity or input signal of the specified hardware peripheral is detected. Settings are: *Enabled* and *Disabled*.

USB Resume from S3

This item allows the activity of the USB device to wake up the system from S3 (Suspend to RAM) state. Settings are: *Enabled* and *Disabled*.

RTC Resume

This function is for setting time for your computer to boot up. Setting options: *Disabled*, *Enabled*.

Time (hh:mm:ss) Alarm You can choose what hour, minute and second the system will boot up.



MSI Reminds You...

If you have changed this setting, you must let the system boot up until it enters the operating system, before this function will work.

IRQ Activity Monitoring

Press <Enter> and the following sub-menu appears.

```

IRQs Activity [Primary]
IRQ3 [Enabled]
IRQ4 [Enabled]
IRQ5 [Enabled]
IRQ6 [Enabled]
IRQ7 [Enabled]
IRQ8 [Disabled]
IRQ9 [Enabled]
IRQ10 [Enabled]
IRQ11 [Enabled]
IRQ12 [Enabled]
IRQ13 [Enabled]
IRQ14 [Enabled]
IRQ15 [Disabled]

```

IRQs Activity, IRQ3~IRQ15

IRQ3~IRQ15 enable or disable the monitoring of the specified IRQ line. If set to [Enabled], the activity of the specified IRQ line will prevent the system from entering power saving modes or awaken it from power saving modes.



MSI Reminds You...

IRQ (Interrupt Request) lines are system resources allocated to I/O devices. When an I/O device needs to gain attention of the operating system, it signals this by causing an IRQ to occur. After receiving the signal, when the operating system is ready, the system will interrupt itself and perform the service required by the I/O device.

After AC Power Lost

This setting specifies whether your system will reboot after a power failure or interrupt occurs. Available settings are:

- | | |
|-------------------|---|
| <i>Off</i> | Leaves the computer in the power off state. |
| <i>On</i> | Leaves the computer in the power on state. |
| <i>Last State</i> | Restores the system to the status before power failure or interrupt occurred. |

PNP/PCI Configurations

This section describes configuring the PCI bus system and PnP (Plug & Play) feature. PCI, or **Peripheral Component Interconnect**, is a system which allows I/O devices to operate at speeds nearing the speed the CPU itself uses when communicating with its special components. This section covers some very technical items and it is strongly recommended that only experienced users should make any changes to the default settings.

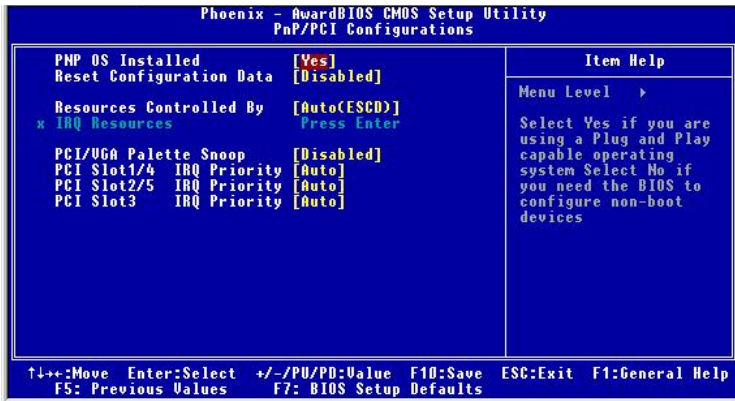

PNP OS Installed

When set to [Yes], BIOS will only initialize the PnP cards used for booting (VGA, IDE, SCSI). The rest of the cards will be initialized by the PnP operating system like Windows 98. When set to [No], BIOS will initialize all the PnP cards. So, select [Yes] if your operating system is Plug & Play aware.

Reset Configuration Data

Normally, you leave this field Disabled. Select Enabled to reset Extended System Configuration Data (ESCD) when you exit Setup if you have installed a new add-on and the system reconfiguration has caused such a serious conflict that the operating system can not boot. The settings are: *Enabled* and *Disabled*.

Resource Controlled By

The Award Plug and Play BIOS has the capacity to automatically configure all of the boot and Plug and Play compatible devices. However, this capability means absolutely nothing unless you are using a Plug and Play operating system

such as Windows® 95/98. If you set this field to “manual” choose specific resources by going into each of the sub menu that follows this field (a sub menu is preceded by a “>”). The settings are: *Auto (ESCD)*, *Manual*.

IRQ Resources

The items are adjustable only when *Resources Controlled By* is set to *Manual*. Press <Enter> and you will enter the sub-menu of the items. IRQ Resources list IRQ 3/4/5/7/9/10/11/12/14/15 for users to set each IRQ a type depending on the type of device using the IRQ. Settings are:

- PCI Device* For Plug & Play compatible devices designed for PCI bus architecture.
- Reserved* The IRQ will be reserved for further request.

PCI/VGA Palette Snoop

When set to *Enabled*, multiple VGA devices operating on different buses can handle data from the CPU on each set of palette registers on every video device. Bit 5 of the command register in the PCI device configuration space is the VGA Palette Snoop bit (0 is disabled). For example, if there are two VGA devices in the computer (one PCI and one ISA) and the:

VGA Palette Snoop Bit Setting	Action
<i>Disabled</i>	Data read or written by the CPU is only directed to the PCI VGA device's palette registers.
<i>Enabled</i>	Data read or written by the CPU is directed to both the PCI VGA device's palette registers and the ISA VGA device's palette registers, permitting the palette registers of both VGA devices to be identical.

The setting must be set to *Enabled* if any ISA bus adapter in the system requires VGA palette snooping.

PCI Slot 1/4, 2/5, 3 IRQ Priority

These items specify the IRQ line for each PCI slot. Settings: 3, 4, 5, 7, 9, 10, 11, 12, 14, 15 and *Auto*. Selecting *Auto* allows BIOS to automatically determine the IRQ line for each PCI slot.

PC Health Status

This section shows the status of your CPU, fan, overall system status, etc. Monitor function is available only if there is hardware monitoring mechanism onboard.

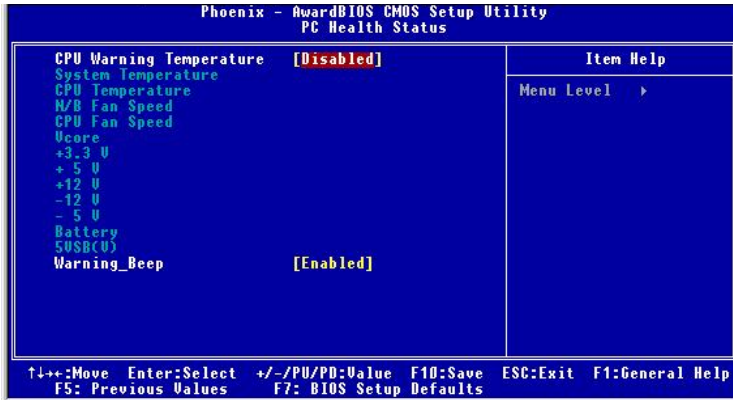

CPU Warning Temperature

This item is used to specify a thermal limit for CPU. If CPU temperature reaches the specified limit, the system will issue a warning which allows you to prevent the CPU overheat problem. Settings: *Disabled*, 50°C/122°F, 53°C/127°F, 56°C/133°F, 60°C/140°F, 63°C/145°F, 66°C/151°F and 70°C/158°F.

System/CPU Temperature, NB/CPU Fan Speed, Vcore, 3.3V, +5V, +12V, -12V, -5V, Battery, 5VSB(V)

These items display the current status of all of the monitored hardware devices/components such as CPU voltages, temperatures and all fans' speeds.

Warning Beep

The item controls whether the system beeps when any warning such as system overheating problem or chassis intrusion event occurs. Settings: *Enabled* and *Disabled*.

Frequency/Voltage Control

Use this menu to specify your settings for frequency/voltage control.

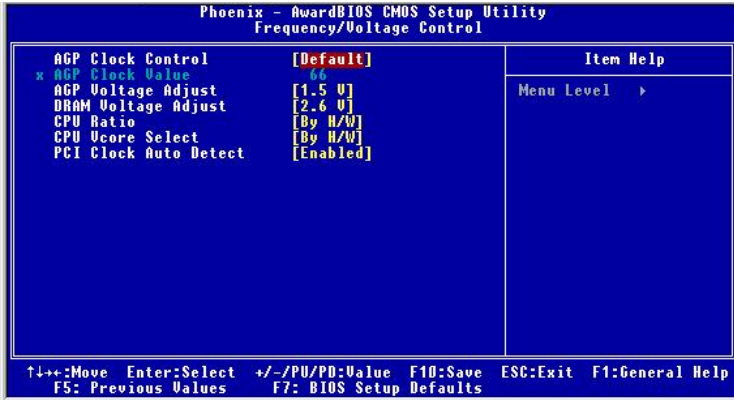

AGP Clock Control

This item allows users to set the AGP clock manually or by default. Options: *Default, Manual*.

AGP Clock Value

When **AGP Clock Control** is set to *Manual*, users can key in a DEC number between 66 and 120.

AGP Voltage Adjust

AGP voltage is adjustable in the field, allowing you to increase the performance of your AGP display card when overclocking, but the stability may be affected.

DRAM Voltage Adjust

Adjusting the DDR voltage can increase the DDR speed. Any changes made to this setting may cause a stability issue, so *changing the DDR voltage for long-term purpose is NOT recommended*.

CPU Ratio/CPU Vcore Select

The settings are used to adjust the CPU clock multiplier (ratio) and CPU core voltage (Vcore). These settings offer users a tool to overclock the system.

PCI Clock Auto Detect

This feature enables the BIOS to auto detect PCI device and set PCI slot clock. Options are: *Enabled, Disabled.*



MSI Reminds You...

Changing CPU Ratio/Vcore could result in the instability of the system; therefore, it is NOT recommended to change the default setting for long-term usage.

Load High Performance/BIOS Setup Defaults

The two options on the main menu allow users to restore all of the BIOS settings to the High Performance or BIOS Setup Defaults. The High Performance Defaults are the default values set by the mainboard manufacturer specifically for optimal performance of the mainboard. The BIOS Setup Defaults are the default values set by the BIOS vendor for stable system performance.

When you select Load High Performance Defaults, a message as below appears:



Pressing Y loads the default factory settings for optimal system performance.



MSI Reminds You...

The option is for power or overclocking users only. Use of high performance defaults will tighten most timings to increase the system performance. Therefore, a high-end system configuration is a must, which means you need high-quality VGA adapter, RAM and so on. We don't recommend that users should apply the high performance defaults in their regular systems. Otherwise, the system may become unstable or even crash. If the system crashes or hangs after enabling the feature, please CLEAR CMOS DATA to resolve the problem. For more information, refer to "Clear CMOS Jumper:JBAT1" in Chapter 2.

When you select Load BIOS Setup Defaults, a message as below appears:



Pressing Y loads the BIOS default values for the most stable, minimal system performance.

Set Supervisor/User Password

When you select this function, a message as below will appear on the screen:

Enter Password:

Type the password, up to eight characters in length, and press <Enter>. The password typed now will replace any previously set password from CMOS memory. You will be prompted to confirm the password. Retype the password and press <Enter>. You may also press <Esc> to abort the selection and not enter a password.

To clear a set password, just press <Enter> when you are prompted to enter the password. A message will show up confirming the password will be disabled. Once the password is disabled, the system will boot and you can enter Setup without entering any password.

When a password has been set, you will be prompted to enter it every time you try to enter Setup. This prevents an unauthorized person from changing any part of your system configuration.

Additionally, when a password is enabled, you can also have BIOS to request a password each time the system is booted. This would prevent unauthorized use of your computer. The setting to determine when the password prompt is required is the Security Option of the Advanced BIOS Feature menu. If the Security Option is set to *System*, the password is required both at boot and at entry to Setup. If set to *Setup*, password prompt only occurs when you try to enter Setup.



MSI Reminds You...

About Supervisor Password & User Password:

Supervisor password: Can enter and change the settings of the setup menu.

User password: Can only enter but do not have the right to change the settings of the setup menu.

Appendix: Using 4- or 6-Channel Audio Function

You need to install the *NVIDIA nForce System Drivers* to function properly before you can get access to 4-/6-channel audio operations. Follow the procedures described below to install the drivers for different operating systems.

TOPICS

<i>Installing the Audio Driver</i>	A-2
<i>Using 4 or 6-Channel Audio Function (For MCP2-T)</i>	A-4
<i>Using the Optional S-Bracket</i>	A-5
<i>Using the Back Panel Only (For MCP2)</i>	A-14
<i>Configuration in the Software Utility</i>	A-19

Installing the Audio Driver

Installation for Windows 98SE/ME/2000/XP

For Windows® 2000, you must install Windows® 2000 Service Pack2 or later before installing the driver.

The following illustrations are based on Windows® XP environment and could look slightly different if you install the drivers in different operating systems.

1. Insert the companion CD into the CD-ROM drive. The setup screen will automatically appear.
2. Click **NVIDIA nForce System Drivers**.

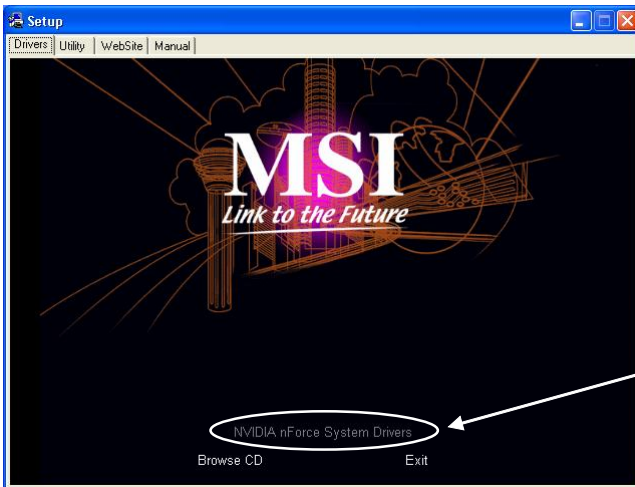

3. Click **Next** to start installing files into the system.

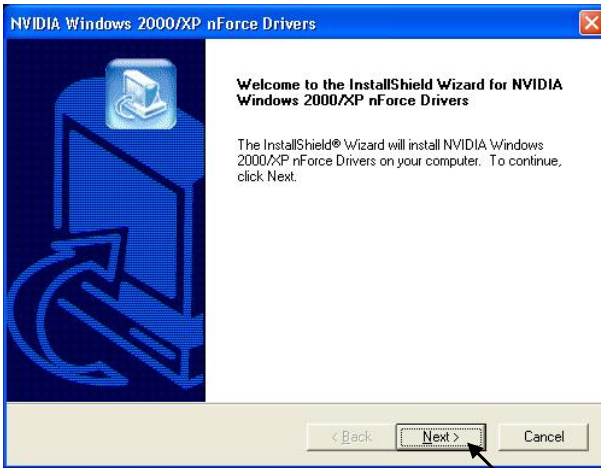

Click here

4. Click **Finish** to restart the system.



Select this option

Click here

Using 4- or 6-Channel Audio Function

After installing the audio driver, you are able to use the 4-/6-channel audio feature now. To enable 4- or 6-channel audio operation, first connect 4 or 6 speakers to the appropriate audio connectors, and then select 4- or 6-channel audio setting in the software utility.

There are two ways to utilize the function and connect the speakers to your computer:

- **Using the optional S-Bracket**

If your motherboard supports S-Bracket and you have installed S-Bracket in the computer, you can connect two speakers to back panel's Line-Out connector, and the rest of speakers to S-Bracket.

- **Using the back panel only**

If you do not have a S-Bracket, you can connect all speakers to the audio connectors on the back panel.

For MCP2-T

Using the Optional S-Bracket

S-Bracket integrates the SPDIF (Sony & Philips Digital Interface) and analog LINE OUT connectors together. With this optional accessory, users will be able to decide either analog or digital audio output when applying the speakers to the connectors.

Read the following instructions to have the Multi-Channel Audio Function mode properly set in the software utility, and then have your speakers correctly connected to the S-Bracket:

Configuration in the Software Utility

1. Click the audio icon at the lower-right corner of the screen.
2. Click the *Speaker Setup* tab.
3. Select a desired multi-channel operation from *Listening Mode*.
 - a. Headphones Mode for headphone Output
 - b. 2-Channel Mode for Stereo-Speaker Output
 - c. 4-Channel Mode for 4-Speaker Output
 - d. 6-Channel Mode for 5.1-Speaker Output
4. Select *Analog Output* and *Digital Output* when using S-Bracket.

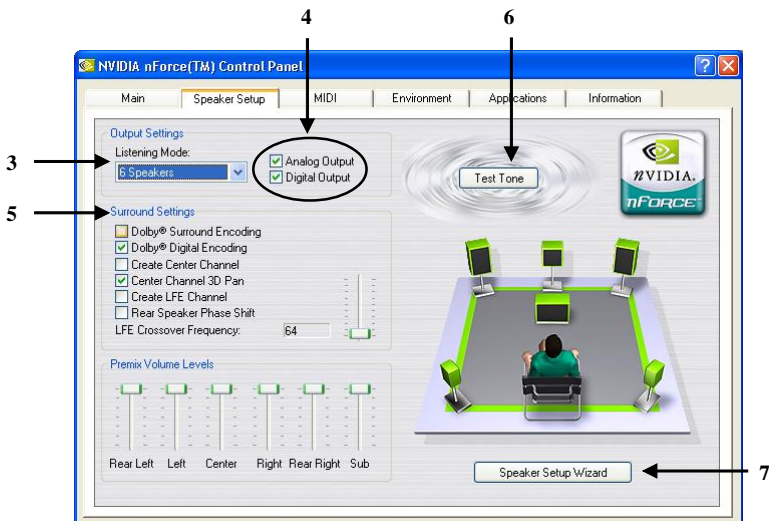

5. Select the *Surround Settings* in accordance with your speaker system.
6. Click *Test Tone* to auto-detect if all speakers are installed.
7. Click *Speaker Setup Wizard* to configure the control panel settings.
8. The *Speaker Setup Wizard* dialog box will pop out. Click **Next** to continue.



9. Select a desired listening mode from the list.

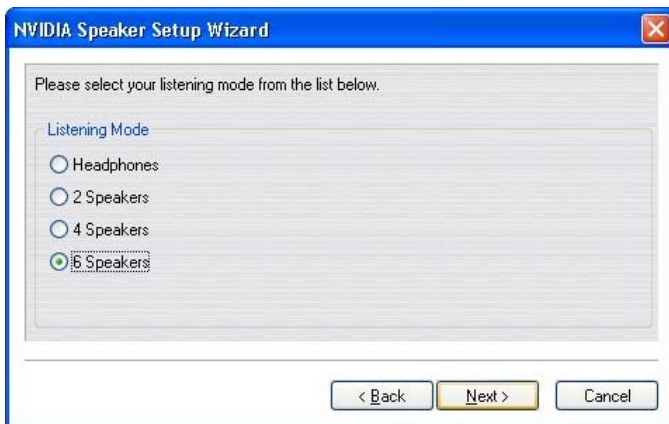

- 10a. If you are using the digital connection, please select **Digital Output**. Click **Next** to continue.
- 10b. If you are using the analog connection, please select **Analog Output**. Click **Next** to continue.



- 11a. Select “My digital speakers support Dolby Digital decoding.” to experience the 5.1 channel sound effects if your speakers support so. Click **Next**.

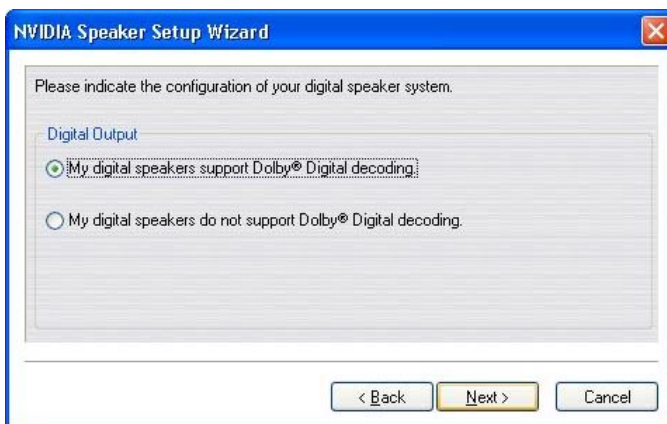

- 11b-1. Select “My analog speakers use a single input and are in Dolby Surround mode.” Click **Next**.

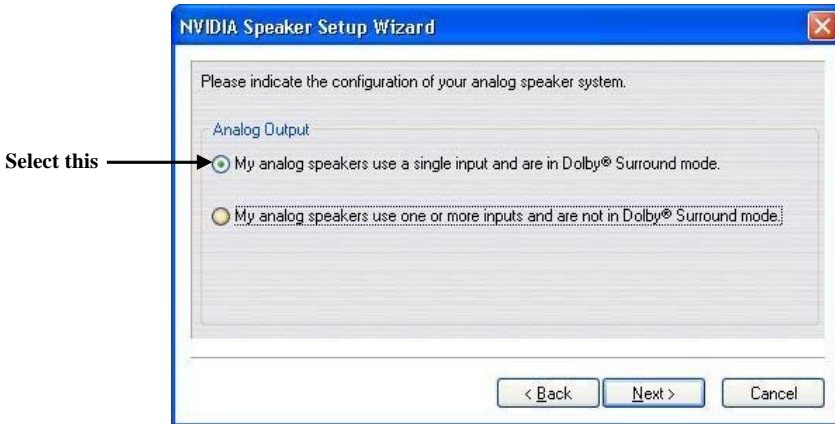

- 11b-2. Do not click **Rear Speakers** and **Center Speaker and Subwoofer** when using the S-Bracket. Click **Next**.



12. Click **Finish**.



13. Click the *Environment* tab.

14. Select a desired surround sound effect from the “Environment Presets” drop-down menu.

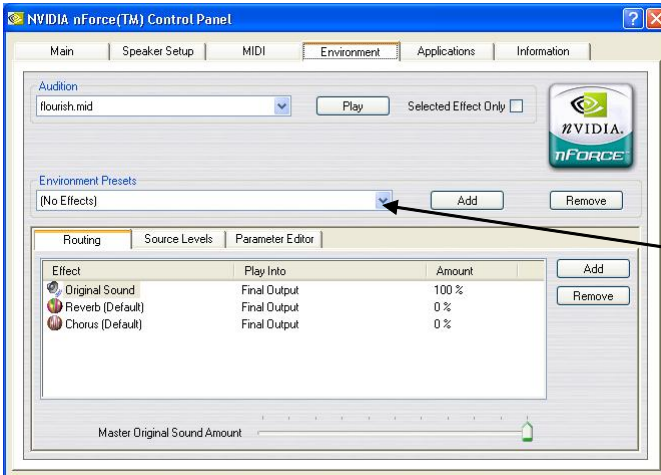

Use the drop-down menu

Connecting the Speakers

When you have set the Multi-Channel Audio Function mode properly in the software utility, connect your speakers to the correct phonejacks in accordance with the setting in software utility.

■ 2-Channel Mode for Stereo-Speaker Output

When this mode is selected, it is recommended to attach the speakers to the Line Out connector on the back panel instead of the Line Out connector on the S-Bracket.

Refer to the following diagram and caption for the function of each phonejack on the back panel when 2-Channel mode is selected.

Analog Output

- 1 MIC
- 2 Line In
- 3 Line Out (*Front channels*)
- 4 Optical SPDIF jack
- 5 Coaxial SPDIF jack

Digital Output

- 1 MIC
- 2 Line In
- 3 Line Out (*Front channels*)
- 4 Optical SPDIF jack
- 5 Coaxial SPDIF jack

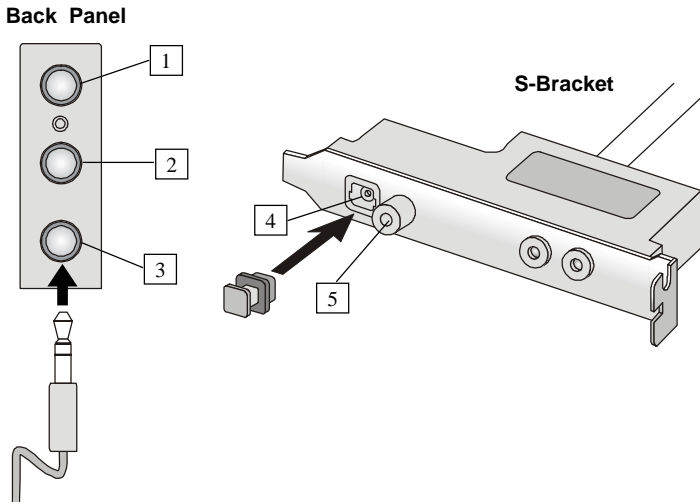

■ 4-Channel Mode for 4-Speaker Output

When this mode is selected, plug the two front speakers to the Line Out connector on the back panel, and the other two rear speakers to the Line Out connector on the S-Bracket.

Refer to the following diagram and caption for the function of each phonejack on the back panel and S-Bracket when 4-Channel mode is selected.

Analog Output

- 1 MIC
- 2 Line In
- 3 Line Out (Front channels)
- 4 Optical SPDIF jack
- 5 Coaxial SPDIF jack
- 6 Line Out (Reserved for Center and Subwoofer channel, but it is not functioning here)
- 7 Line Out (Rear channels)

Digital Output

- 1 MIC
- 2 Line In
- 3 Line Out (Front channels)
- 4 Optical SPDIF jack
- 5 Coaxial SPDIF jack
- 6 Line Out (Reserved for Center and Subwoofer channel, but it is not functioning here)
- 7 Line Out (Rear channels)

Back Panel

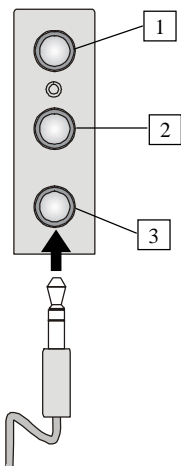

S-Bracket

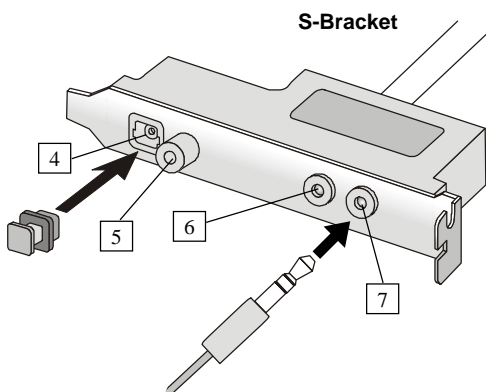

■ **6-Channel Mode for 6-Speaker Output**

When this mode is selected, plug the two front speakers to the Line Out connector on the back panel, and the other two rear speakers to the Line Out connector on the S-Bracket.

Refer to the following diagram and caption for the function of each phonejack on the back panel and S-Bracket when 6-Channel mode is selected.

Analog Output

- 1 MIC
- 2 Line In
- 3 Line Out (*Front channels*)
- 4 Optical SPDIF jack
- 5 Coaxial SPDIF jack
- 6 Line Out (*Center and Subwoofer channels*)
- 7 Line Out (*Rear channels*)

Digital Output

- 1 MIC
- 2 Line In
- 3 Line Out (*Front channels*)
- 4 Optical SPDIF jack
- 5 Coaxial SPDIF jack
- 6 Line Out (*Center and Subwoofer channels*)
- 7 Line Out (*Rear channels*)

Back Panel

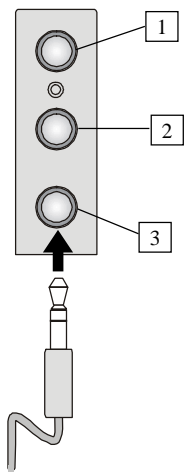

S-Bracket

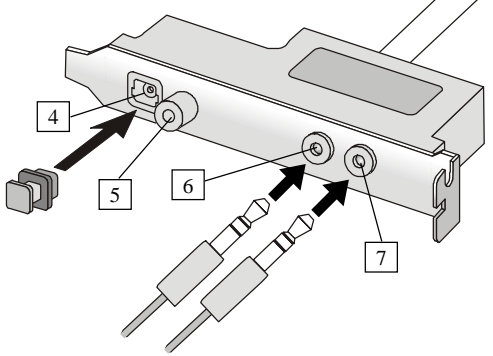

■ **Digital Audio Output**

When any Multi-Channel Audio Function mode is selected, you may also connect your speakers to the Optical or Coaxial SPDIF phonejack on the S-Bracket to experience digital surround sound effect.

Remove the plug from the optical SPDIF phonejack before inserting the fiber-optic cable, and read the following diagram and captions for the function of each phonejack on the S-Bracket.

- 1 Optical SPDIF jack
- 2 Coaxial SPDIF jack

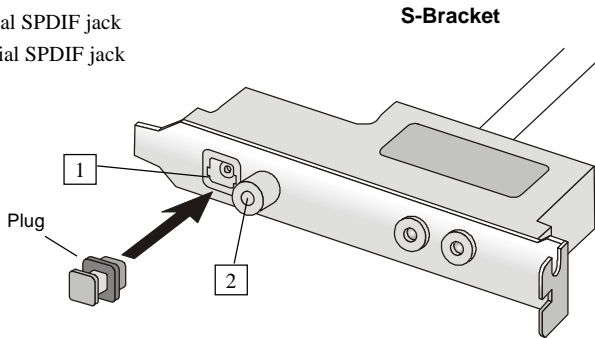

Using the Back Panel only

In addition to a default 2-channel analog audio output function, the audio connectors on the Back Panel also provide 4- or 6-channel analog audio output function if a proper setting is made in the software utility.

Read the following steps to have the Multi-Channel Audio Function properly set in the software utility, and have your speakers correctly connected to the Back Panel.

Configuration in the Software Utility

1. Click the audio icon at the lower-right corner of the screen.
2. Click the *Speaker Setup* tab.
3. Select a desired multi-channel operation from *Listening Mode*.
 - a. Headphones Mode for headphone Output
 - b. 2-Channel Mode for Stereo-Speaker Output
 - c. 4-Channel Mode for 4-Speaker Output
 - d. 6-Channel Mode for 5.1-Speaker Output
4. Select *Analog Output* when using Back Panel only.



5. Select the **Surround Settings** in accordance with your speaker system.
6. Click **Test Tone** to auto-detect if all speakers are installed.
7. Click **Speaker Setup Wizard** to configure the control panel settings.
8. The **Speaker Setup Wizard** dialog box will pop out. Click **Next** to continue.



9. Select a desired listening mode from the list.

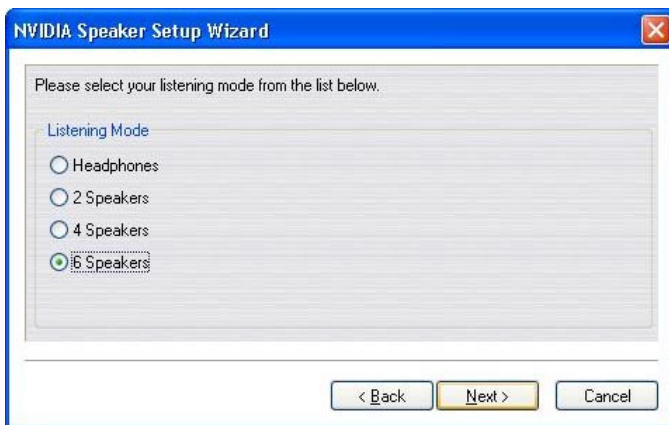

10. Click **Rear Speakers** and **Center Speaker and Subwoofer** for 6-channel speaker setup. Click **Next**.



12. Click **Finish**.



Connecting the Speakers

When you have set the Multi-Channel Audio Function mode properly in the software utility, connect your speakers to the correct phonejacks in accordance with the setting in software utility.

■ 2-Channel Mode for Stereo-Speaker Output

Refer to the following diagram and caption for the function of each phonejack on the back panel when 2-Channel Mode is selected.

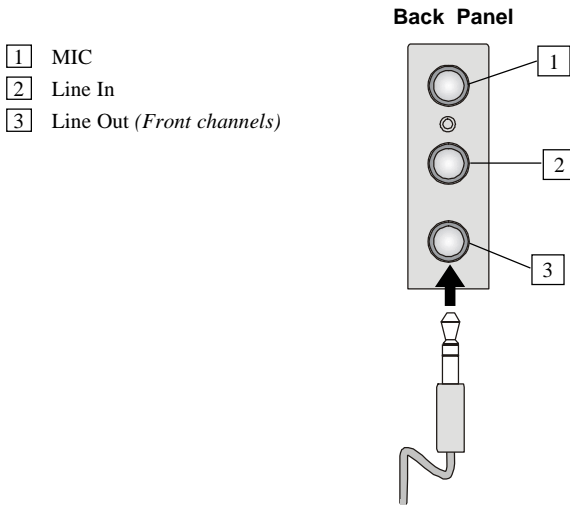

■ 4-Channel Mode for 4-Speaker Output

The audio jacks on the back panel always provide 2-channel analog audio output function, however these audio jacks can be transformed to 4- or 6- channel analog audio jacks by selecting the corresponding multi-channel operation from **No. of Speakers**.

Refer to the following diagram and caption for the function of each jack on the back panel when 4-Channel Mode is selected.

- 1 MIC
- 2* Line Out (Rear channels)
- 3 Line Out (Front channels)

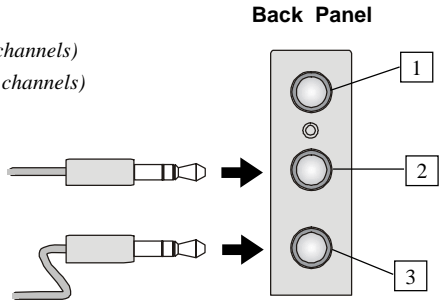

* Line In function is converted to Line Out function when 4-Channel Mode for 4-Speaker Output is selected.

■ 6-Channel Mode for 6-Speaker Output

Refer to the following diagram and caption for the function of each jack on the back panel when 6-Channel Mode is selected.

- 1* Line Out (Center and Subwoofer channel)
- 2* Line Out (Rear channels)
- 3 Line Out (Front channels)

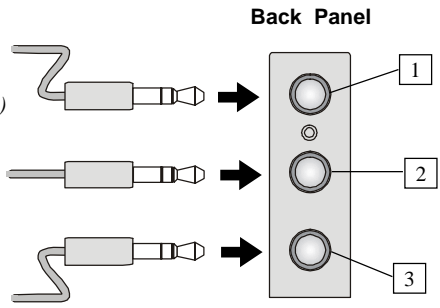

* Both Line In and MIC function are converted to Line Out function when 4-Channel Mode for 6-Speaker Output is selected.

For MCP2

Configuration in the Software Utility

1. Click the audio icon at the lower-right corner of the screen. The Master Volume dialog box will appear on the screen.

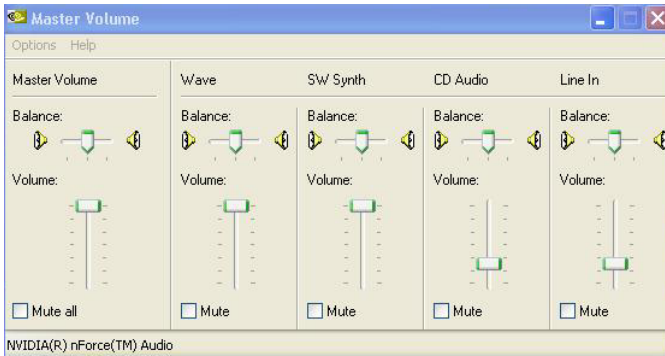

2. On the Options menu, click *Advanced Controls*.

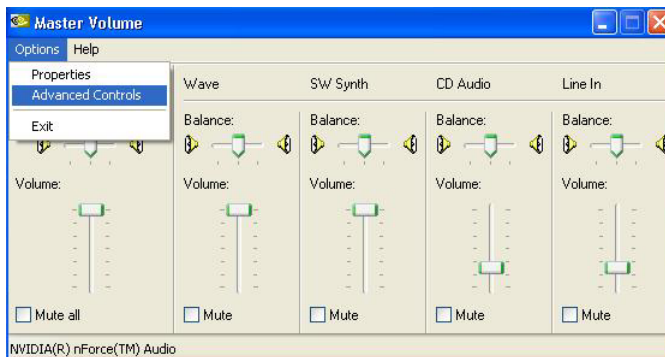

3. Click **Advanced**.

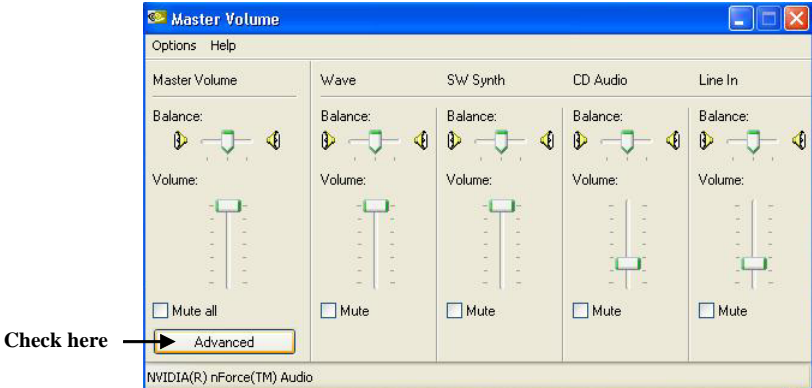

4. Check **Rear Speakers connected to Line In** and **Center speaker and subwoofer connected to microphone** for 6-channel audio output.

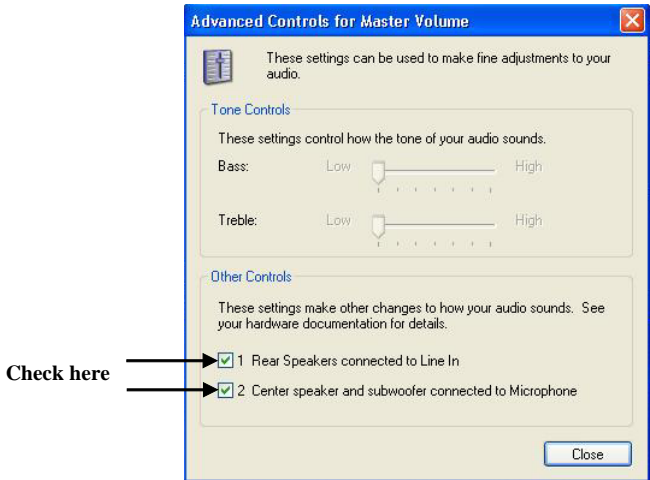

5. Click **Close** to exit.

Troubleshooting

Q: Where will I find the model number of the mainboard?

A: There are two places where you can find the model number of the mainboard:

1. Somewhere between the PCI slots you shall find MS-xxxx or the marketing name like "K7T Turbo". You can also find the version number beside it.
2. At the back cover of the user's manual.

Q: What do you mean by PCB version 1?

A: PCB is printed circuit board. Saying PCB version 1 is the same as saying motherboard version 1.

Q: Why my motherboard BIOS sticker is "Phoenix BIOS" but when I boot up my system I saw that "Award BIOS" is being used?

A: Phoenix & Award already merged as one company. All MSI motherboard using Award BIOS comes with Phoenix logo sticker.

Q: How do I know what MSI D-LED or D-bracket light mean?

A: Please follow the special tech issue, http://www.msi.com.tw/support/techexpress/special_tech/smartled.htm

Q: I have got MSI Motherboard and when it says detecting drives, it detects them but says an error saying "Primary IDE Channel no 80 Conductor Cable Installed"

A: This is not a problem. It merely means that you're using an ATA-66 or ATA-100 HDD, but you're using the conductor 40 ATA-33 cable.

Q: I have high speed CPU cooling fan like Taisol CGK760092, Vantec CCK-6035D & GlobalWin WBK38. Can I install the fan directly to the motherboard?

A: We strongly recommend that you do NOT connect those described CPU fan directly to your motherboard, as it draws so much power, that it could damage it. Please use a 3-Pin to 4-Pin Cable that comes together with the fan.

Q: Can I use more than 512MB memory on Win9x or WinME?

A: No, you can't. You can only use more than 512MB memory on Win2000 or WinXP. This is a Microsoft OS issue. Please check <http://support.microsoft.com/support/kb/articles/Q108/0/79.ASP>

Q: I have tried to download the MSI Live Update utility from <http://www.msi.com.tw/support/liveupdate/livedriver.htm> but it keeps on failing?

A: This can be solved by one of the following suggestions: 1. Dont install zonealarm 2. Disable "WebTrap" of PC-cillion 2000 3. Disable any web based anti-virus Software.

Q: Can Live Update Series support WinXP?

A: Live Update Series version 215 can support WinXP. Download it from <http://www.msi.com.tw/support/liveupdate/livedriver.htm>

Q: After flashing the BIOS, my system for unknown reason dont want to boot, what should I do?

A: Please refer to the following suggestions: 1. Try the BIOS boot recovery feature as described in <http://www.msi.com.tw/support/bios/boot.htm> 2. Try to clear the CMOS If problem still persists, ask your reseller for new BIOS chip or contact one of MSI office near your place for new BIOS chip <http://www.msi.com.tw/contact/main.htm>

Q: Should I update my BIOS, once a new BIOS is released?

A: A new BIOS is usually released due to the following reasons:

1. New function is supported
2. New BIOS source code

3. Bugs are found
4. Customer-specific request

When we release a new BIOS, there's usually a release note attached which lists the reason for the release. Refer to this release note and decide for yourself if upgrading to the new BIOS will be worth it. A word of advice, though, do not upgrade to the new BIOS, unless you really have to.

Q: How do I update the BIOS?

A: Please refer to <http://www.msi.com.tw/support/bios/note.htm> for details.

Q: How do I identify the BIOS version?

A: Upon boot-up, the 1st line appearing after the memory count is the BIOS version. It is usually in the format:

1. For older model number:

AG76091096 where:

1st digit refers to BIOS maker as A = AMI(R) W = AWARD(R) P = PHOENIX (R).

2nd digit refers to the internal chipset code.

3rd digit refers to the processor class as 5 = 486, 7 = 586, 8 = 686.

4th digit is incremental.

091096 refers to the date this BIOS is released.

2. For newer model number:

W5139MS V1.091096 where:

1st digit refers to BIOS maker as A = AMI(R) W = AWARD(R) P = PHOENIX (R).

2nd - 5th digit refers to the model number.

6th - 7th digit refers to the customer as MS = all standard customers.

V1.0 refers to the BIOS version.

091096 refers to the date this BIOS is released.

Q: After flashing the bios and rebooting the system, the screen went blank.

A: *For AMI BIOS*

Rename the desired AMI BIOS file to AMIBOOT.ROM and save it on a floppy disk. e.g. Rename A569MS23.ROM to AMIBOOT.ROM

Insert this floppy disk in the floppy drive. Turn On the system and press and hold Ctrl-Home to force update. It will read the AMIBOOT.ROM file and recover the BIOS from the A drive.

When 4 beeps are heard you may remove the floppy disk and restart the computer.

For Award BIOS

Make a bootable floppy disk

Copy the Award flash utility & BIOS file to the said floppy disk

Create an autoexec.bat with "awdf1535 biosfilename" in the content e.g.
awdf1535 a619mj21.bin

Boot up system with the said floppy (it will take less than 2 minutes before screen comes out)

Re-flash the BIOS & reboot.

Glossary

ACPI (*Advanced Configuration & Power Interface*)

This power management specification enables the OS (operating system) to control the amount of power given to each device attached to the computer. Windows 98/98SE, Windows 2000 and Windows ME can fully support ACPI to allow users managing the system power flexibly.

AGP (*Accelerated Graphics Port*)

A new, high-speed graphics interface that based on PCI construction and designed especially for the throughput demands of 3-D graphics. AGP provides a direct channel (32-bit wide bus) between the display controller and main memory for high graphics quality and performance.

Bluetooth

Bluetooth refers to a worldwide standard for the wireless exchange of data between two devices. Bluetooth requires that a low-cost transceiver chip be included in each device. The transceiver transmits and receives in a previously unused frequency band of 2.45 GHz that is available globally (with some variation of bandwidth in different countries). In addition to data, up to three voice channels are available. Each device has a unique 48-bit address from the IEEE 802 standard. Connections can be point-to-point or multipoint. The maximum range is 10 meters. Data can be exchanged at a rate of 1 megabit per second (up to 2 Mbps in the second generation of the technology).

BIOS (*Basic Input/Output System*)

On PCs, an essential software that contains all the control code of input/output interface (such as keyboard, disk drives, etc.). It executes hardware test on booting the system, starts the OS, and provides an interface between the OS and the components. The BIOS is stored in a ROM chip.

Bus

A set of hardware lines within the computer system, through which the data is transferred among different components. In a PC, the term **bus** usually refers to a local bus that connects the internal components to the CPU and main memory.

Cache

A special memory subsystem that is used to speed up the data transfer. It stores the

contents of frequently accessed RAM locations and the addresses where these data items are stored.

Chipset

A collection of integrated chips designed to perform one or more related functions. For example, a modem chipset contains all the primary circuits for transmitting and receiving data; a PC chipset provides the electronic interfaces between all subsystems.

Clock Cycle

Clock cycle (or tick) is the smallest unit of time recognized by a device. For personal computers, clock cycles generally refer to the main system clock, which runs at 66 MHz. This means that there are 66 million clock cycles per second. Since modern CPUs run much faster (up to 533 MHz), the CPU can execute several instructions in a single clock tick.

CMOS (*Complementary Metal-Oxide Semiconductor*)

CMOS is a widely used type of semiconductor, which features high speed and low power consumption. PCs usually contain a small amount of battery-powered CMOS memory to retain the date, time, and system setup parameters.

DRAM (*Dynamic RAM*)

A most common type of computer memory. It usually uses one transistor and a capacitor to represent a bit. As the development of technology, the memory type and specification used in computer becomes variety, such as SDRAM, DDR SDRAM, and RDRAM. For further instruction, please see the table below:

Dynamic RAM (DRAM) Memory Technologies					
Type	First Used	Clock Rate	Bus* Width	Peak Bandwidth	Volts
FPM (60,70ns)	1990	25MHz	64 bits	200 MBps	5v
EDO (50,60,70ns)	1994	40MHz	64 bits	320 MBps	5v
SDRAM (66MHz)	1996	66MHz	64 bits	528 MBps	3.3v
SDRAM (100MHz)	1998	100MHz	64 bits	800 MBps	3.3v
SDRAM (133MHz)	1999	133MHz	64 bits	1.1 GBps	3.3v
RDRAM (Direct Rambus)	1999	400MHz	16 bits	1.6 GBps	2.5v
DDR SDRAM (100MHz)	2000	100MHz	64 bits	1.6 GBps	3.3v
DDR SDRAM (133MHz)	2000	133MHz	64 bits	2.1 GBps	3.3v

* Memory channel width (64 bits started with 75MHz Pentium)

Source: *Computer Desktop Encyclopedia*

ECC Memory (*Error Correcting Code Memory*)

A type of memory that contains special circuitry for testing the accuracy of data and correcting the errors on the fly.

EEPROM

Acronym for Electrically Erasable Programmable Read-Only Memory. An EEPROM is a special type of PROM that can be erased by exposing it to an electrical charge. Like other types of PROM, EEPROM retains its contents even when the power is turned off. Also like other types of ROM, EEPROM is not as fast as RAM. EEPROM is similar to flash memory (sometimes called flash EEPROM). The principal difference is that EEPROM requires data to be written or erased one byte at a time whereas flash memory allows data to be written or erased in blocks. This makes flash memory faster.

EIDE

Short for Enhanced IDE, a newer version of the IDE mass storage device interface standard developed by Western Digital Corporation. It supports data rates of between 4 and 16.6 MBps, about three to four times faster than the old IDE standard. In addition, it can support mass storage devices of up to 8.4 gigabytes, whereas the old standard was limited to 528 MB. Because of its lower cost, enhanced EIDE has replaced SCSI in many areas. There are four EIDE modes defined. The most common is Mode 4, which supports transfer rates of 16.6 MBps. There is also a new mode, called ATA-3 or Ultra ATA, that supports transfer rates of 33 MBps.

EISA (*Extended Industry Standard Architecture*)

EISA is a standard bus (computer interconnection) architecture that extends the ISA standard to a 32-bit interface. It was developed in part as an open alternative to the proprietary Micro Channel Architecture (MCA) that IBM introduced in its PS/2 computers. EISA data transfer can reach a peak of 33 megabytes per second.

ESCD (*Extended System Configuration Data*)

It is a format for storing information about Plug-and-Play (PnP) devices in the BIOS. Windows and the BIOS access the ESCD area each time you re-boot your computer

External Cache

Short for Level 2 cache, cache memory that is external to the microprocessor. In general, L2 cache memory, also called the secondary cache, resides on a separate chip from the microprocessor chip. Although, more and more microprocessors are including L2 caches into their architectures.

IDE (*Integrated Drive Electronics*)

A type of disk-drive interface widely used to connect hard disks, CD-ROMs and tape drives to a PC, in which the controller electronics is integrated into the drive itself, eliminating the need for a separate adapter card. The IDE interface is known as the ATA (AT Attachment) specification.

IEEE 1394

A new, high speed external bus standard, also known as **FireWire** or **iLink**, which supports data transfer rates of up to 400 Mbps for connecting up to 63 external devices.

Internal Cache

Short for Level 1 cache, a memory cache built into the microprocessor. The L1 cache is also called the primary cache.

IrDA (*Infrared Data Association*)

A group of device vendors, including computer, component and telecommunications, who have developed a standard for transmitting data via infrared light waves. This enables you to transfer data from one device to another without any cables.

IRQ (*Interrupt Request Line*)

IRQs are hardware lines over which devices can send interrupt signals to the microprocessor. When you add a new device to a PC, you sometimes need to set its IRQ number by setting a DIP switch. This specifies which interrupt line the device may use. IRQ conflicts used to be a common problem when adding expansion boards, but the Plug-and-Play specification has removed this headache in most cases.

ISA (*Industry Standard Architecture*)

ISA is a standard bus (computer interconnection) architecture that is associated with the IBM AT motherboard. It allows 16 bits at a time to flow between the motherboard circuitry and an expansion slot card and its associated device(s). Also see EISA and MCA.

LAN (*Local Area Network*)

A computer network that covers a relatively smaller area, such as in a building or an enterprise. It is made up of servers, workstations, shared resources, a network operating system and a communications link. These individual PCs and devices on a LAN are known as “nodes”, and are connected by cables to access data and devices anywhere on the LAN, so that many users can share expensive devices and data.

LBA (*Logical Block Addressing*)

Logical block addressing is a technique that allows a computer to address a hard disk larger than 528 megabytes. A logical block address is a 28-bit value that maps to a specific cylinder-head-sector address on the disk. 28 bits allows sufficient variation to specify addresses on a hard disk up to 8.4 gigabytes in data storage capacity. Logical block addressing is one of the defining features of Enhanced IDE (EIDE), a hard disk interface to the computer bus or data paths.

LED (*Light Emitting Diode*)

A semiconductor device that converts electrical energy into light. Since it lights up (usually red) when electricity is passed through it, it is usually used for the activity lights on computer's component, such as disk drivers.

LPT (*Line Printer Terminal*)

Logical device name for a line printer; a name reserved by the MS-DOS for up to three parallel printer ports: LPT1, LPT2, and LPT3. It is frequently used by the OS to identify a printer.

Overclocking

Overclocking is resetting your computer so that the microprocessor runs faster than the manufacturer-specified speed (for example, setting an Intel 166 MHz (megahertz) microprocessor to run at 200 Mhz).

PCI (*Peripheral Component Interconnect*)

A local bus standard developed by Intel that first appeared on PCs in late 1993. PCI provides "plug and play" capability and allows IRQs to be shared. The PCI controller can exchange data with the system's CPU either 32 bits or 64 bits at a time.

PnP (*Plug and Play*)

A set of specifications that allows a PC to configure itself automatically to work with peripherals. The user can "plug" in a peripheral device and "play" it without configuring the system manually. To implement this useful feature, both the BIOS that supports PnP and a PnP expansion card are required.

POST (*Power On Self Test*)

During booting up your system, the BIOS executes a series of diagnostic tests, include checking the RAM, the keyboard, the disk drives, etc., to see if they are properly connected and operating.

PS/2 Port

A type of port developed by IBM for connecting a mouse or keyboard to a PC. The PS/2 port supports a mini DIN plug containing just 6 pins. Most modern PCs equipped with PS/2 ports so that the special port can be used by another device, such as a modem.

RAID

RAID (Redundant Array of Independent Disks; originally Redundant Array of Inexpensive Disks) is a way of storing the same data in different places (thus, redundantly) on multiple hard disks. By placing data on multiple disks, I/O operations can overlap in a balanced way, improving performance. Since multiple disks increases the mean time between failure (MTBF), storing data redundantly also increases fault-tolerance.

SCSI

Acronym for Small Computer System Interface. Pronounced "scuzzy," SCSI is a parallel interface standard used by Apple Macintosh computers, PCs, and many UNIX systems for attaching peripheral devices to computers. SCSI interfaces provide for faster data transmission rates (up to 80 megabytes per second) than standard serial and parallel ports. In addition, you can attach many devices to a single SCSI port, so that SCSI is really an I/O bus rather than simply an interface.

USB (*Universal Serial Bus*)

A hardware interface for low-speed peripherals such as the keyboard, mouse, joystick, etc. USB provides a maximum bandwidth of 12 Mbit/sec (Mbps) for connecting up to 127 peripheral devices to PC. USB features hot swap capability and multiple data streams, allows external devices to be plugged in and unplugged without turning the system off.

Virus

A program or a piece of code that infects computer files by inserting in those files copies of itself. The virus code is buried within an existing program, and is activated when that program is executed. All the viruses are man-made, and often have damaging side effects.

WLAN

Acronym for wireless local-area network. Also referred to as LAWN. A type of local-area network that uses high-frequency radio waves rather than wires to communicate between nodes.